



## HAC Test Report for Telecoil IHDP56ME1

**Tests Requested By:** Motorola Mobility, Inc.  
600 N. US Highway 45  
Libertyville, IL 60048

**Date of Tests:** Aug-13-2011  
**Date of Report:** Sep-13-2011

**Test Laboratory:** Motorola Mobility, Inc. - ADR Test Services Laboratory  
600 N. US Highway 45  
Libertyville, Illinois 60048

**Report Author:** Thomas Knipple  
Senior RF Engineer

**Statement of Compliance:** Motorola declares under its sole responsibility that portable cellular telephone FCC ID IHDP56ME1 to which this declaration relates, complies with recommendations and guidelines FCC 47 CFR §20.19. The measurements were performed to ensure compliance to the ANSI C63.19-2007. It also declares that the product was tested in accordance with the appropriate measurement standards, guidelines and recommended practices. Any deviations from these standards, guidelines and recommended practices are noted below:

(none)

**Results Summary:** T Category = T3

©Motorola Mobility, Inc. 2011

This test report shall not be reproduced except in full, without written approval of the laboratory.

The results and statements contained herein relate only to the items tested. The names of individuals involved may be mentioned only in connection with the statements or results from this report.

Motorola encourages all feedback, both positive and negative, on this test report.

**Table of Contents**

**1. INTRODUCTION .....3**

**2. DESCRIPTION OF THE DEVICE UNDER TEST.....3**

**3. TEST EQUIPMENT USED.....4**

**4. SIGNAL VERIFICATION.....7**

**5. TEST RESULTS.....8**

**5.1 Telecoil SNR Results .....8**

**5.2 Telecoil Environment Results.....11**

**6. MEASUREMENTS FOR CERTIFICATION OF 3G DEVICES.....13**

**Appendix 1: Contour Plots**

**Appendix 2: Ambient Noise Spectrum Plots**

**Appendix 3: Details on the Measurement Systems**

**Appendix 4: Pictures of Test Setup**

**Appendix 5: Motorola Uncertainty Budget**

**Appendix 6: Audio Magnetic Probe Certificate**

**Appendix 7: AMCC Certificate (Helmholtz Coil)**

**Appendix 8: HAC Distribution Plots for E-Field and H-Field**

## 1. Introduction

The Motorola Mobile Devices Business Product Safety Laboratory has performed Hearing Aid Compatibility (HAC) measurements for the portable cellular phone (FCC ID IHDP56ME1). The portable cellular phone was tested in accordance with ANSI C63.19-2007 standard. The test results presented herein clearly demonstrate compliance FCC 47 CFR § 20.19. This report demonstrates compliance for Telecoil performance only and not for near field emissions.

## 2. Description of the Device Under Test

**Table 1: Information for the Device Under Test**

<b>Serial Number(s) (Functional Use)</b>	LS4V230096 (All Telecoil HAC testing, conducted power measurements)
<b>Production Unit or Identical Prototype (47 CFR §2.908)</b>	Identical Prototype
<b>Device Category</b>	Portable
<b>RF Exposure Limits</b>	General Population / Uncontrolled

Mode(s) of Operation	Modulation Mode(s)	Maximum Output Power Setting	Duty Cycle	Transmitting Frequency Range(s)	Supports Voice on Interface	Test requirements defined in C63.19-2007	Supports Simultaneous Operation With
LTE Band 13	QPSK, 16QAM	25.0 dBm	1:1	777 - 787 MHz	YES (VOIP only)	NO	CDMA, Wi-Fi, Bluetooth
CDMA 800	QPSK	24.5 dBm	1:1	824.70 - 848.31 MHz	YES	YES	LTE, Wi-Fi, Bluetooth
CDMA 1900	QPSK	25.0 dBm	1:1	1851.20 - 1908.75 MHz	YES	YES	LTE, Wi-Fi, Bluetooth
Wi-Fi 802.11b/g/n	BPSK	18.5 dBm	1:1	2412.0 - 2462.5 MHz	YES (VOIP only)	NO	LTE, CDMA, Bluetooth
Bluetooth	GFSK	10 dBm	1:1	2402.0 - 2483.5 MHz	NO	NO	LTE, CDMA, Wi-Fi

Note: No Bluetooth profile exists in this phone that will allow a Bluetooth link while in a cellular call that passes audio to the earpiece. If the user had Bluetooth enabled and a link established, they could not be listening to the phone through the earpiece.

Note: Wi-Fi capability is included in this phone without measurements for hearing aid compatibility based on the interim ruling by the FCC according to paragraph 37 of the Federal Register, Volume 3, Number 89, as of May 7, 2008. Users shall be informed of this via the product user guide per the same FCC ruling.

Note: This device supports voice call functionality over GSM and WCDMA on non-US cellular networks. The GSM/WCDMA network functions have been disabled by firmware and are SIM locked for all US operators. Further information regarding this functionality is contained within Exhibit 12.

**3. Test Equipment Used**

The Motorola Mobility Inc. ADR Test Services Laboratory utilizes a Dosimetric Assessment System (Dasy4™ v4.7) manufactured by Schmid & Partner Engineering AG (SPEAG™) of Zurich, Switzerland. All Telecoil measurements are taken within a shielded enclosure. The measurement uncertainty budget is given in Appendix 5. The list of calibrated equipment used for the measurements is shown in Table 2.

**Table 2: Test Equipment**

	Description	Serial Number	Cal Date	Cal Due Date
<b>Dosimetric System Equipment</b>	DAE3	703	Nov-12-2010	Nov-12-2011
	Audio Magnetic 1D Field Probe AM1DV3	3080		
	AMMI SE UMS 010 AA	1005		
	AMCC SD HAC P02 AB	1005		
	Test Arch SD HAC D01 BA	1073		
<b>Additional Test Equipment</b>	Rohde & Schwarz CMU 200	110518	Mar-02-2011	Mar-02-2012

**Figure 1: Telecoil setup and cabling (pictures from DASY manual)**

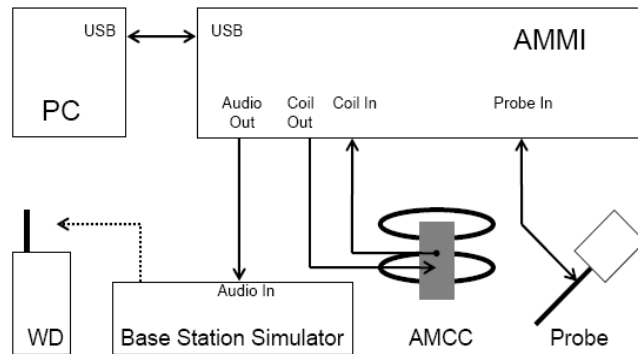

AMMI (Audio Magnetic Measurement Instrument) is a desktop unit containing a sampling unit, a waveform generator for test, calibration signals and a USB interface. Front connectors include: Audio Out - predefined or user definable audio signals for injection into the WD; Probe In - the probe signal is evaluated by AMMI; Coil Out - test and calibration signal to the AMCC; Coil In - monitor signal from the AMCC.

Audio Magnetic Probe (AM1DV2) is an active probe with a single sensor. The same probe coil is used to measure three orthogonal field components (axial, radial 1, radial 2). The probe is rotated to properly orient the coil for each field component. Probe's frequency response, linearity and other characteristics are given in the certificate in Appendix 6.

AMCC (Audio Magnetic Calibration Coil) is a Helmholtz coil for calibration of the AM1D probe. The two horizontal coils create a homogeneous magnetic field in the z direction. Refer to Appendix 7 for more details on AMCC coil.

The probe is calibrated in the AMCC coil. The frequency response and sensitivity are measured and stored. Sensitivity includes both probe sensitivity and pre-amplifier sensitivity.

**Graph 1: Frequency Response measured in AMCC**

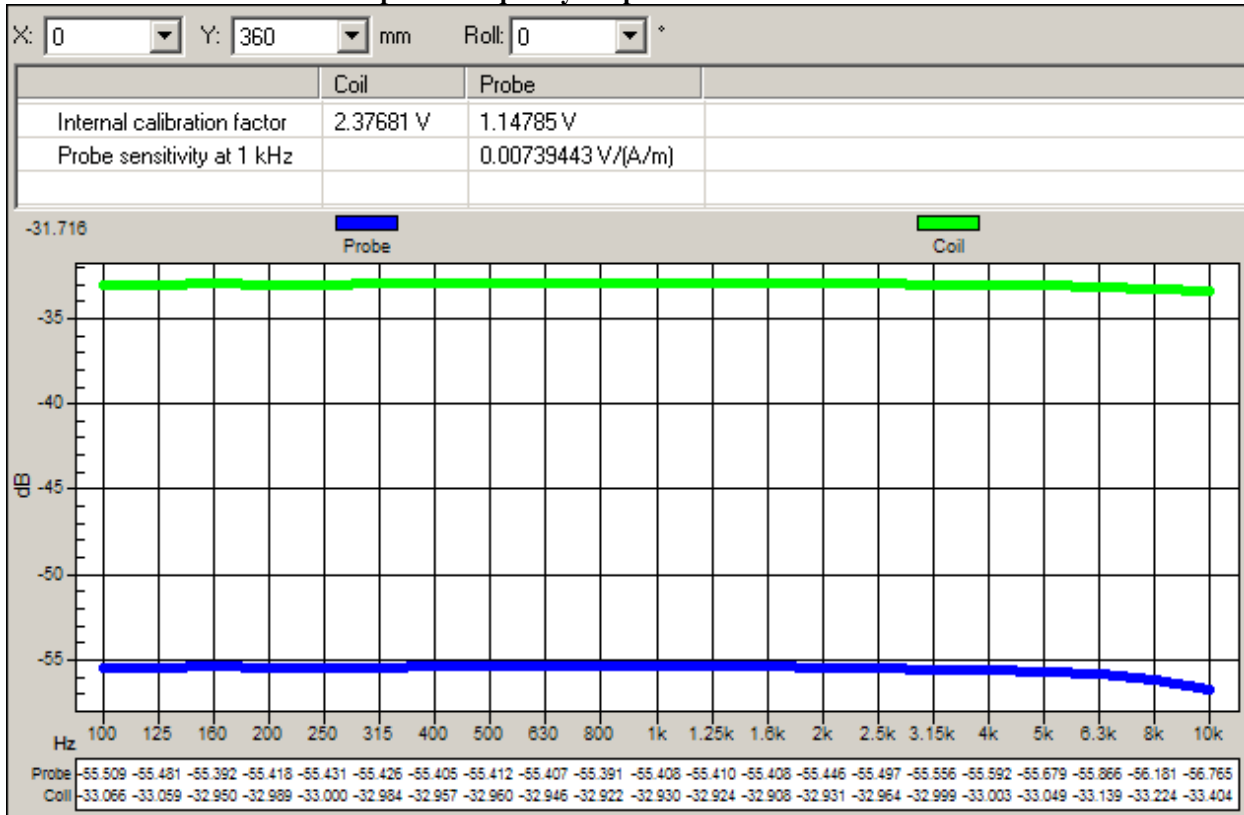

Sensitivity measured in AMCC:  $0.00739443 \text{ V}/(\text{A/m})$

The sensitivity is for a 1 kHz sine signal. The sensitivity includes both probe sensitivity and pre-amplifier sensitivity. It is the total calibration, and there are no additional probe calibration factors. The voltage into the Helmholtz coil is across the shunt resistor.

**4. Signal Verification**

An Input Level is measured to verify that it is within  $\pm 0.2$  dB from the Reference Input Level in section 6.3.2.1 of ANSI C63.19-2007.

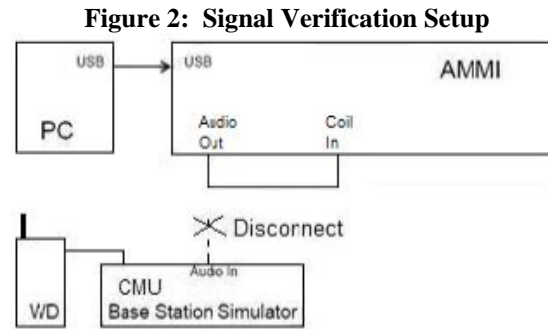

In Figure 2 setup, “Audio Out” of the AMMI is connected to the “Coil In” of the AMMI. The “Audio Out” of the AMMI is measured using 1 V as the reference.

Section 6.3.2.1 of ANSI C63.19-2007 specifies the reference input level to be -16 for GSM/WCDMA and -18 for CDMA. Each CMU has a slightly different “0dBm0 Input Reference” value that must be measured. When the CMU box is replaced or externally re-calibrated, an internal calibration procedure must be completed in each transmission mode. On the CMU 200 (SN 110518), the 0dBm0 Input Reference value is 0.76 V for GSM/WCDMA and 0.73 V for CDMA. For more information on “0dBm0 Input Reference” measurements, refer to Appendix 3-5.

The Target Level for “Audio Out” of the AMMI is shown in Table 3. This target level takes into account the difference between AMMI’s and CMU’s reference levels.

**Table 3: Measured Input Level**

Modulation	Reference Input Level from ANSI PC63.19 (dBm0)	CMU’s 0dBm0 Input Reference Value (dB)	Target Level for “Audio Out” of AMMI (dBm0)
GSM/WCDMA	-16	-2.38	-18.38
CDMA	-18	-2.73	-20.73

The signal level for “Audio Out” of the AMMI is measured. Signal Verification has been conducted on the same days as DUT measurements. If it is not within  $\pm 0.2$  dB, the gain settings in the DASY template are adjusted. The obtained results are displayed in Table 4.

**Table 4: Measured Input Level**

Modulation	Measured date	Signal	Measured Level for “Audio Out” of AMMI (dBm0)	Target Level for “Audio Out” of AMMI (dBm0)
CDMA	Aug-13-2011	Narrowband	-20.71	-20.73
		Broadband	-20.76	

## 5. Test Results

### 5.1 Telecoil SNR Results

The phone was tested in normal configurations for against-the-ear use. The DASY4 v4.7 measurement system specified in section 3.1 was utilized within the intended operations as set by the SPEAG™ setup. The Test Arch provided by SPEAG is used to position the DUT. All tests are done via conducted setup with CMU 200. The volume on the phone is adjusted to maximum. Backlight was off during testing, and HAC compliance will be explained in the manual.

The tests are performed with telecoil function enabled. To enable the telecoil function, select:  
*Main Menu → Settings → Call Settings → HAC Mode Settings → [Check box to enable]*

The cellular phone model covered by this report has the following battery options:  
 Battery #1 – SNN5899A – 1800 mAh Battery

The distance is established by positioning the device beneath the test arch phantom so that it is touching the frame. The location and thickness of the arch, and the location/orientation of the coil within the probe housing, are precisely known values in the DASY software. The height of the measurement plane is further fine-tuned by performing a Surface Detection job at the beginning of each test. The end result is that the probe sensor is very precisely located 10 mm above the device reference plane.

ABM2 investigation has been carried out to determine the highest channel / frequency of each applicable frequency band. At the location of the Telecoil source, ABM2 is measured in the axial probe position for each frequency (Table 5). For each band, the channel with the highest ABM2 measurement is highlighted in **bold**.

**Table 5: ABM2 measurements across the frequency band for the portable cellular telephone at highest possible output power.**

ABM2 Measurements (dB A/m)		
CDMA 800	Ch 1013	<b>-38.0727</b>
	Ch 384	-39.3919
	Ch 777	-38.9543
CDMA 1900	Ch 25	-36.8986
	Ch 600	-37.2391
	Ch 1175	<b>-36.2469</b>

For the channels highlighted in bold in Table 5, Telecoil SNR measurements are shown in Tables 6 and 7. The sequence of the Telecoil SNR measurement is listed in the steps below.

- a) Geometry & signal check
- b) Background noise measurement. The background noise is measured at the center of the listening area.
- c) Coarse resolution axial scan (narrowband signal, 1 s measurement times, 50 x 50 mm grid with 5.55 mm spacing). Only ABM1 is measured in order to find the location of the Telecoil source.
- d) Fine resolution axial, radial-transverse, & radial-longitudinal scans, positioned appropriately based on optimal ABM1 of coarse resolution axial scan (narrowband signal, 1 s measurement times, variable grid size with 2 mm spacing). Both ABM1 and ABM2 are measured in order to find the location of the SNR point.
- e) ABM1 & ABM2 point measurements in axial, radial-transverse, & radial-longitudinal coil orientations, positioned appropriately based on optimal signal quality of fine resolution scans (narrowband signal, 2 s measurement times). SNR is calculated for each coil orientation.
- f) Frequency Response point measurement in axial coil orientation, positioned appropriately based on optimal signal quality of fine resolution axial scan (broadband signal, 12 s measurement time)

The ABM1, SNR and Telecoil Rating results are shown in Tables 6 and 7. Also shown are the location of the measured point, noise, and ABM2. The delta between Ambient Noise measurement and ABM2 measurement should be greater than 10 dB. However, in cases where ABM2 is very low, it is suitable for the delta to be less than 10 dB. For the three probe positions, contour plots for the lowest SNR, indicated in **bold numbers**, are given in Appendix 1. Contour plots are provided for both the default battery alone and with the battery using the inductive charging door. For the three probe positions, noise spectrum plots for the highest ambient noise, indicated with **bold numbers**, are given in Appendix 2. These noise spectrum plots are half band integrated with an A-weighting filter applied.

Telecoil SNR Limits		
ABM 1	Greater or equal to -18 dB A/m	
SNR	T3	Greater than 20 dB
	T4	Greater than 30 dB

**Table 6: Telecoil SNR measurement results for the cellular phone at highest possible output power**

Probe Position	Frequency Band (MHz)	Channel	Measured Point Location (x mm, y mm)	Ambient Noise (dB A/m)	ABM2 (dB A/m)	ABM2 – Ambient Noise (dB)	ABM1 (dB A/m)	SNR (dB)	Telecoil SNR Rating
Axial	CDMA 800	1013	4.4, -6.0	<b>-55.7727</b>	-39.2685	16.5042	-7.6564	31.61	T4
	CDMA 1900	1175	2.8, -6.0	-55.8335	-37.3288	18.5047	-6.3773	<b>30.95</b>	T4
Radial 1	CDMA 800	1013	-6.0, -4.4	-55.2844	-42.3500	12.9344	-15.9990	<b>26.35</b>	T3
	CDMA 1900	1175	-5.6, -4.8	<b>-55.0496</b>	-42.3119	12.7377	-14.8202	27.49	T3
Radial 2	CDMA 800	1013	0.0, 5.6	<b>-55.4720</b>	-50.9106	4.5614	-16.6374	34.27	T4
	CDMA 1900	1175	2.4, 7.2	-55.5138	-49.1082	6.4056	-15.6004	<b>33.51</b>	T4

Graph 2: CDMA 800 Frequency Response

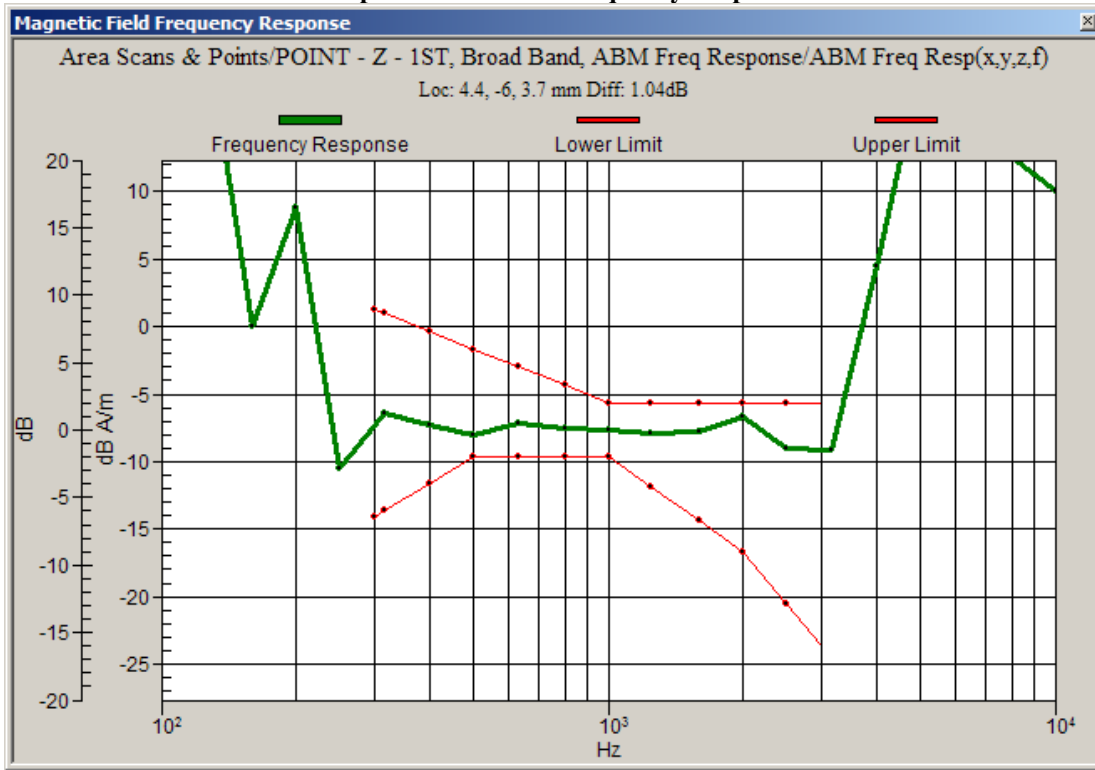

Graph 3: CDMA 1900 Frequency Response

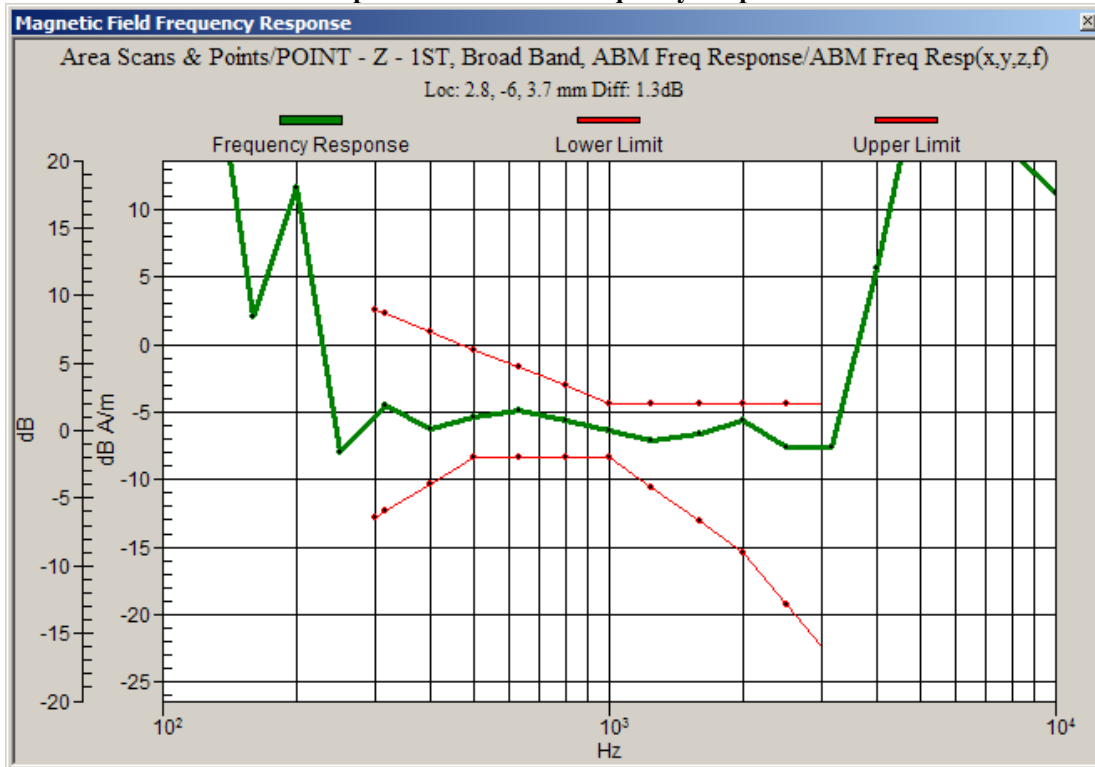

## 5.2 Telecoil Environment Results

Telecoil Environment is determined by analysis of both E-Field scans and H-Field scans in the area of the Telecoil location. The Telecoil location is the earpiece speaker area. The 5 cm x 5 cm measurement grid is centered on the acoustic output of the device. The probe is raised 15 mm from the highest point of the phone's contour to the center point of the probe element. The phone was tested in normal configurations for the ear use. These configurations are tested at the high, middle and low frequency channels of each applicable frequency band. For more information on the near field measurements on the unit LS4V230096, refer to "HAC Test Report for Near Field Emissions IHDP56ME1" from Sep-12-2011.

The worst-case test conditions are indicated with **bold numbers** in the tables and are detailed in Appendix 8: HAC distribution plots for E-Field and H-Field.

**Table 8: Telecoil Environment measurement results for the portable cellular telephone at highest possible output power.**

**Table 8a: HAC E-Field measurement results for the portable cellular telephone at highest possible output power (Full Rate).**

Frequency Band (MHz)	Channel Setting	Measured PMF	Drift (dB)	Excluded Cells	Peak Field (V/m)	Rating
CDMA 800	1013	1.05	<b>-0.090</b>	<b>6,9</b>	<b>99.5</b>	<b>M4</b>
	384		0.133	6,9	91.1	M4
	777		-0.035	8,9	86.2	M4
CDMA 1900	25	1.06	-0.067	7,8,9	35.9	M4
	600		0.232	6,8,9	33.8	M4
	1175		<b>-0.096</b>	<b>6,8,9</b>	<b>50.9</b>	<b>M4</b>

**Table 8b: HAC E-Field measurement results for the portable cellular telephone at highest possible output power (1/8 Rate).**

Frequency Band (MHz)	Channel Setting	Measured PMF	Drift (dB)	Excluded Cells	Peak Field (V/m)	Rating
CDMA 800	1013	2.84	<b>0.107</b>	<b>3,6</b>	<b>99.2</b>	<b>M4</b>
	384		0.017	6,9	86.7	M4
	777		0.115	8,9	85.8	M4
CDMA 1900	25	2.89	-0.063	7,8,9	36.3	M4
	600		0.165	6,8,9	33.4	M4
	1175		<b>0.007</b>	<b>6,8,9</b>	<b>49.0</b>	<b>M4</b>

**Table 8c: HAC H-Field measurement results for the portable cellular telephone at highest possible output power (Full Rate).**

Frequency Band (MHz)	Channel Setting	Measured PMF	Drift (dB)	Excluded Cells	Peak Field (A/m)	Rating
CDMA 800	1013	1.02	<b>-0.169</b>	<b>1,4,7</b>	<b>0.139</b>	<b>M4</b>
	384		0.057	1,4,7	0.132	M4
	777		-0.182	1,4,7	0.132	M4
CDMA 1900	25	1.02	-0.049	4,7,8	0.110	M4
	600		0.098	4,7,8	0.097	M4
	1175		<b>0.025</b>	<b>4,7,8</b>	<b>0.143</b>	<b>M4</b>

**Table 8d: HAC H-Field measurement results for the portable cellular telephone at highest possible output power (1/8 Rate).**

Frequency Band (MHz)	Channel Setting	Measured PMF	Drift (dB)	Excluded Cells	Peak Field (A/m)	Rating
CDMA 800	1013	2.46	<b>0.052</b>	<b>1,4,7</b>	<b>0.128</b>	<b>M4</b>
	384		0.056	1,4,7	0.109	M4
	777		0.059	1,4,7	0.117	M4
CDMA 1900	25	2.53	0.043	4,7,8	0.107	M4
	600		-0.062	4,7,8	0.102	M4
	1175		<b>0.026</b>	<b>4,7,8</b>	<b>0.125</b>	<b>M4</b>

**6. Measurements for Certification of 3G Devices**

For CDMA devices, RC1 and RC3 CDMA modes are considered in S055 service option. In addition, RC1 and RC3 modes are considered in S02 service option. The conducted power measurements for each mode are shown in the table below.

Conducted power (dBm) for CDMA modes					
Band	Channel	RC1		RC3	
		SO2	SO55	SO2	SO55
CDMA 800	1013	24.51	24.47	24.52	24.52
	384	24.61	24.58	24.62	24.63
	777	24.36	24.39	24.37	24.56
CDMA 1900	25	25.27	24.96	25.25	25.16
	600	25.29	25.26	25.26	25.06
	1175	24.93	25.22	24.96	25.19

For CDMA devices, RC1 S03 mode is used for Telecoil compliance evaluation. This RC1 S03 is used for measurements in Table 5 and Table 6. As per the recent presentation by Qualcomm to the FCC on March 15, 2007, RC1 S03 combination represents the appropriate configuration for Telecoil testing. Please refer to the ATIS filing which includes Qualcomm’s presentation. This filing can be found at:  
<http://www.atis.org/legal/Docs/MISC/ATIS%2006-203%20Ex%20Parte%20Letter%203-16-07%20w-attach.pdf>

**Appendix 1**  
**Contour Plots**

Z-Axial Signal Scan with Battery SNN5892A

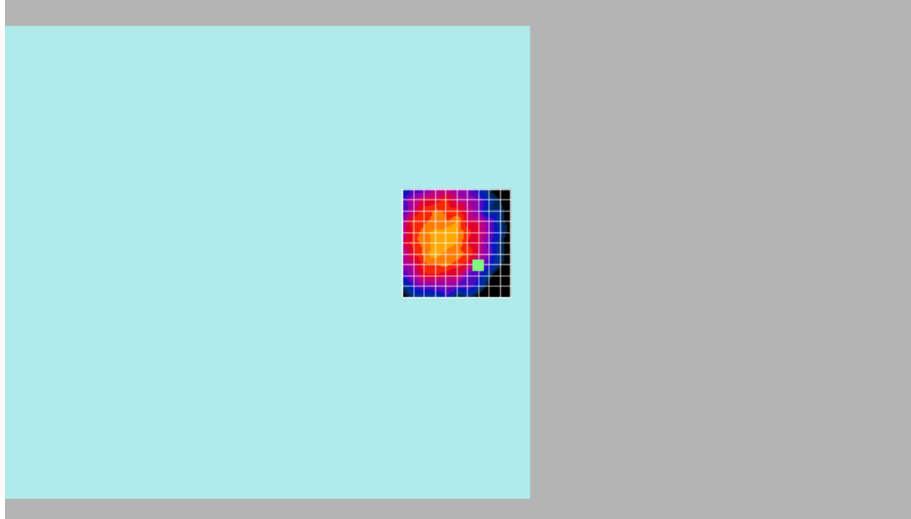

X-Radial Signal Scan with Battery SNN5892A

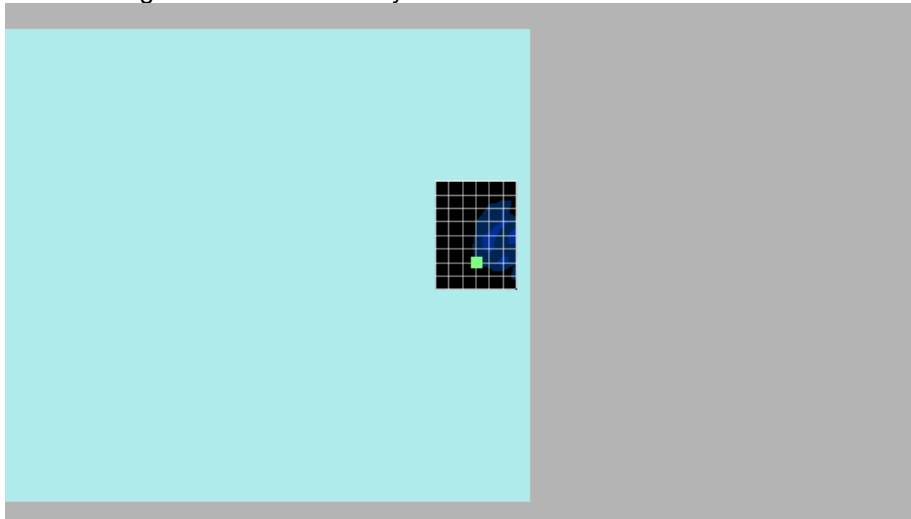

Y-Radial Signal Scan with Battery SNN5892A

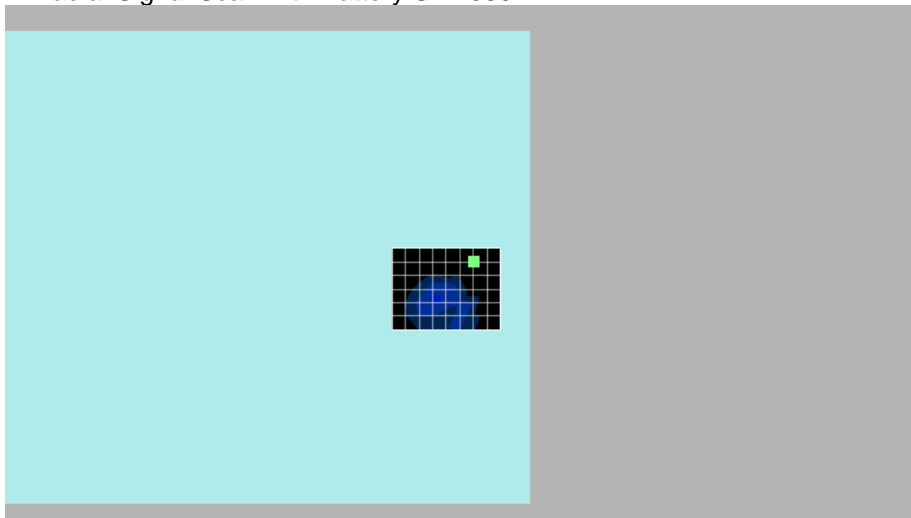

Note: The green square designates the device reference point.

Axial – ABM1

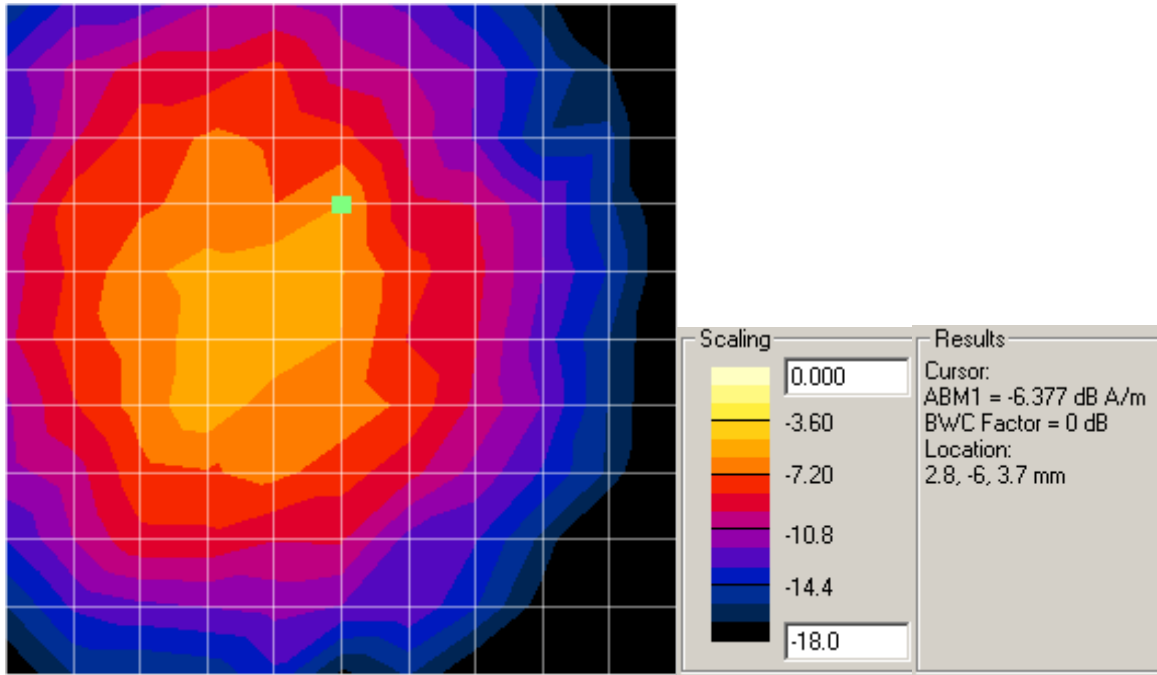

Axial – SNR

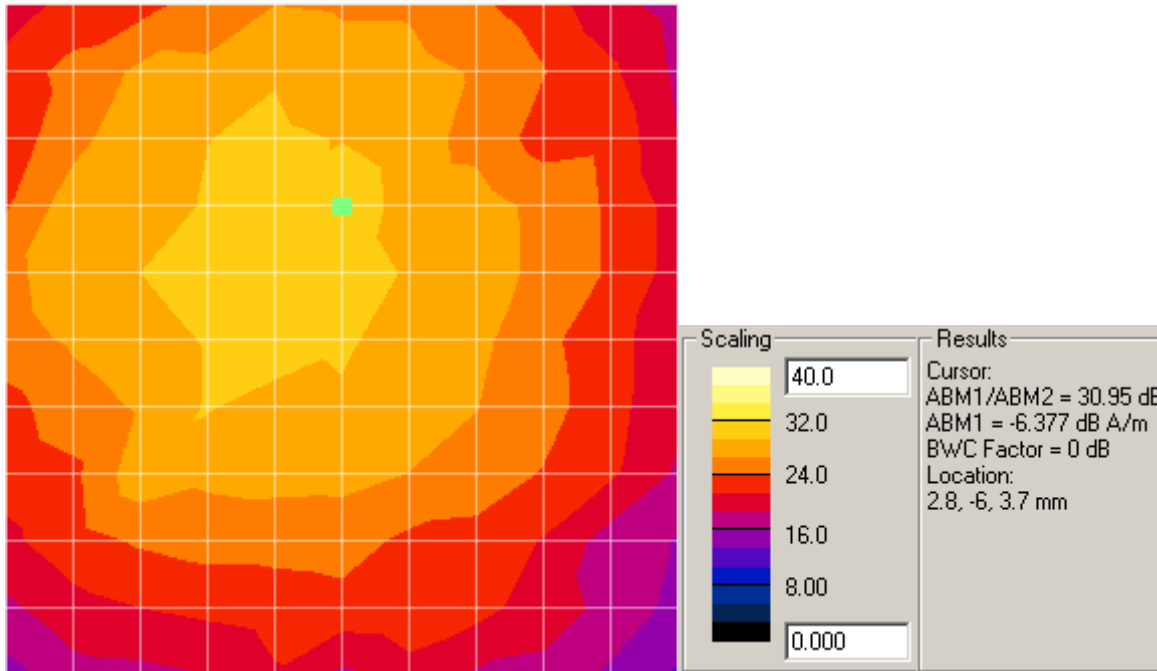

Radial1 – ABM1

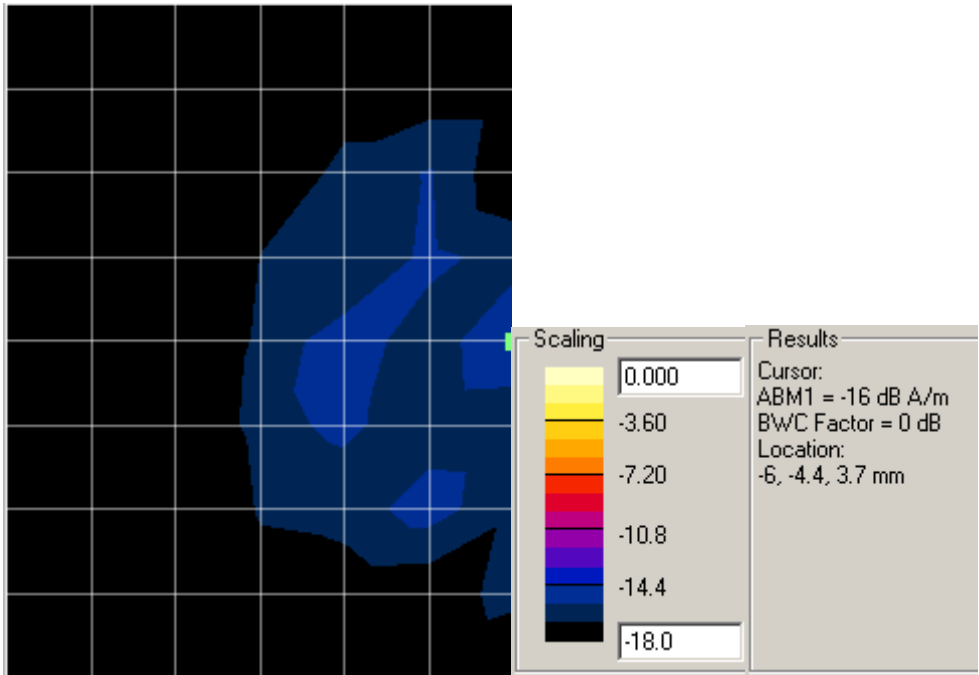

Radial1 – SNR

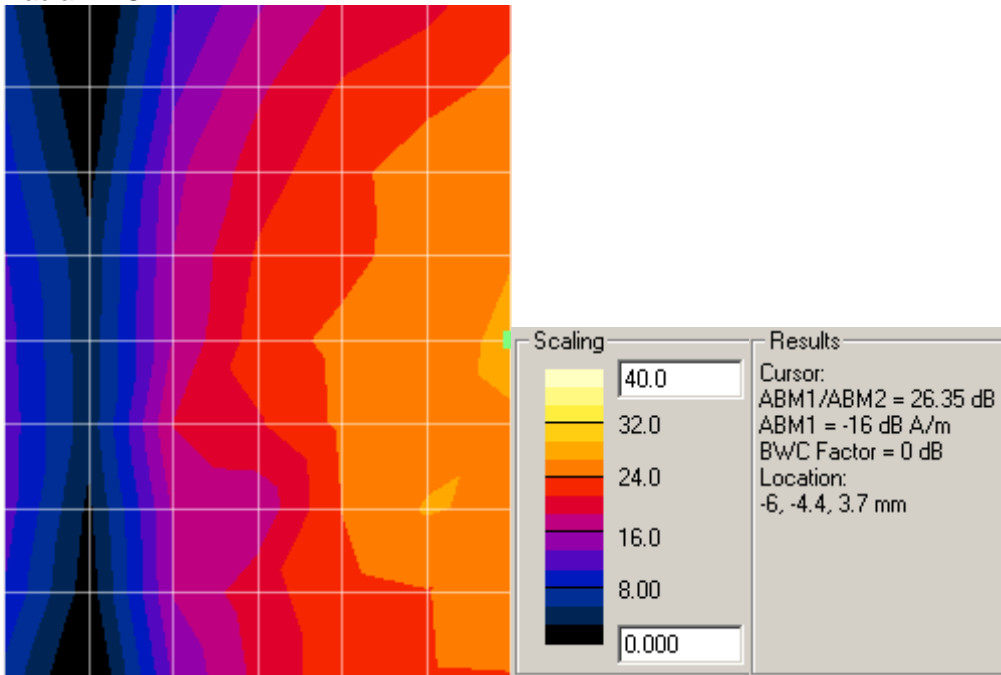

Radial2 – ABM1

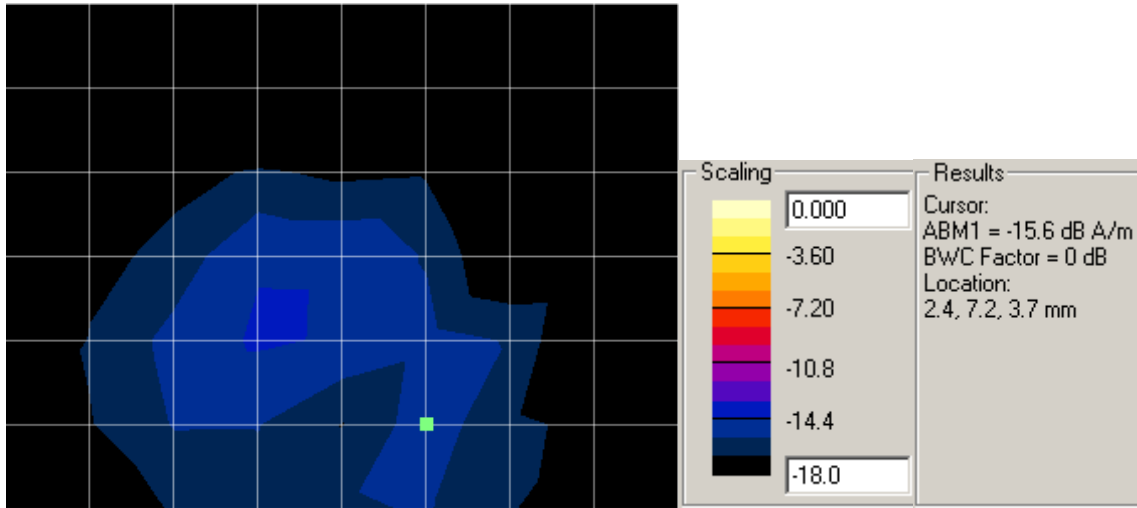

Radial2 – SNR

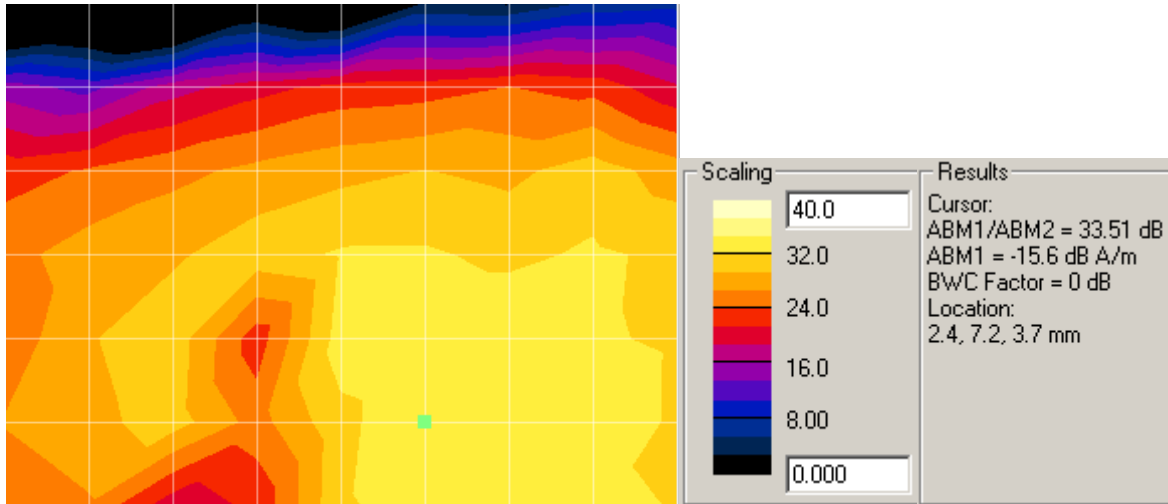

**Appendix 2**

**Ambient Noise Spectrum Plots**

Graph A2-1. Axial Position Ambient Noise Spectrum Plot

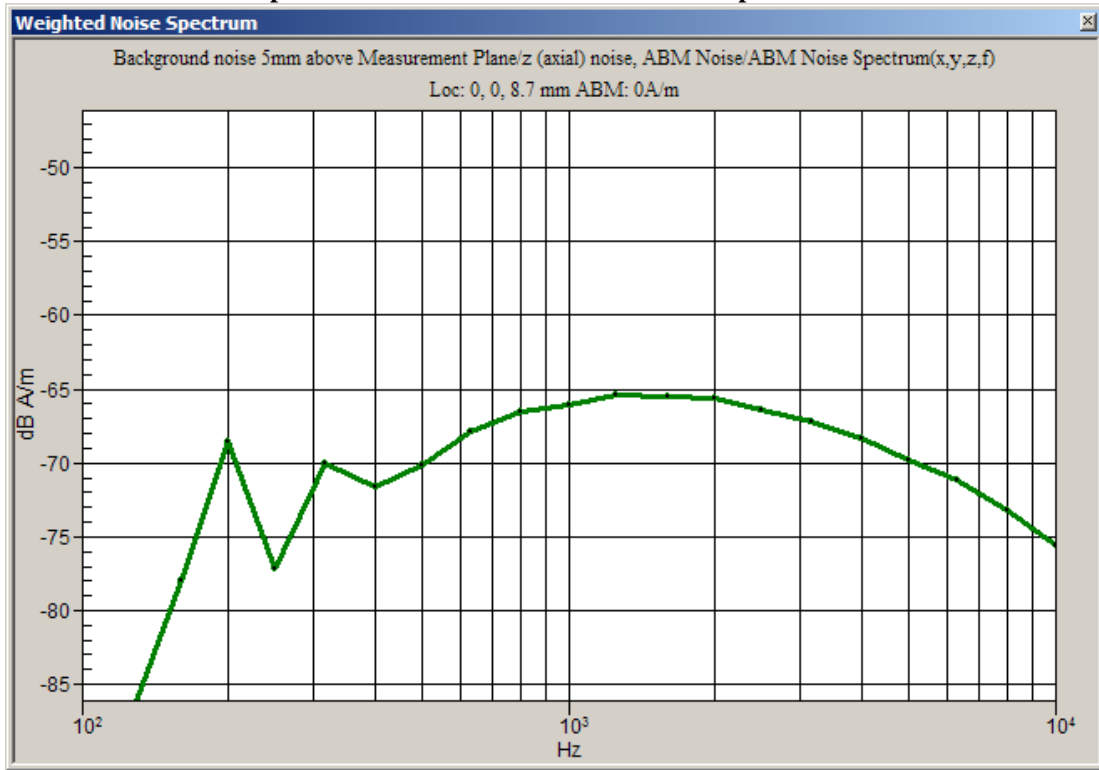

Graph A2-2. Radial 1 Position Ambient Noise Spectrum Plot

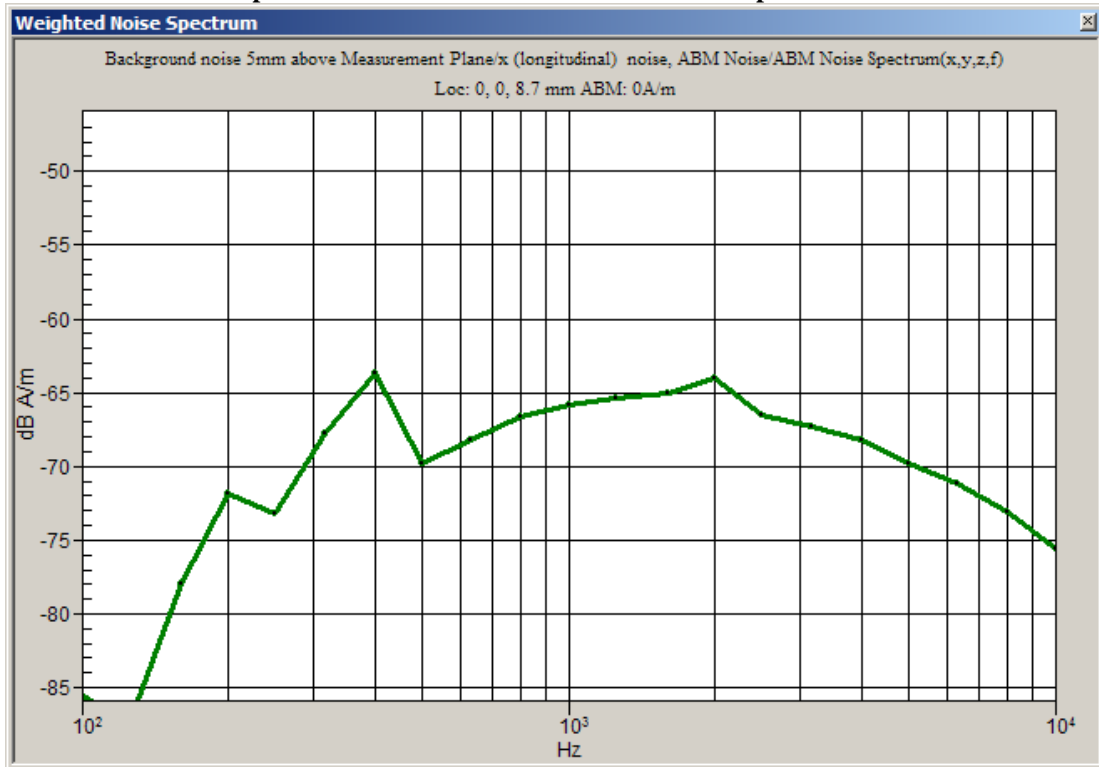

Graph A2-3. Radial 2 Position Ambient Noise Spectrum Plot

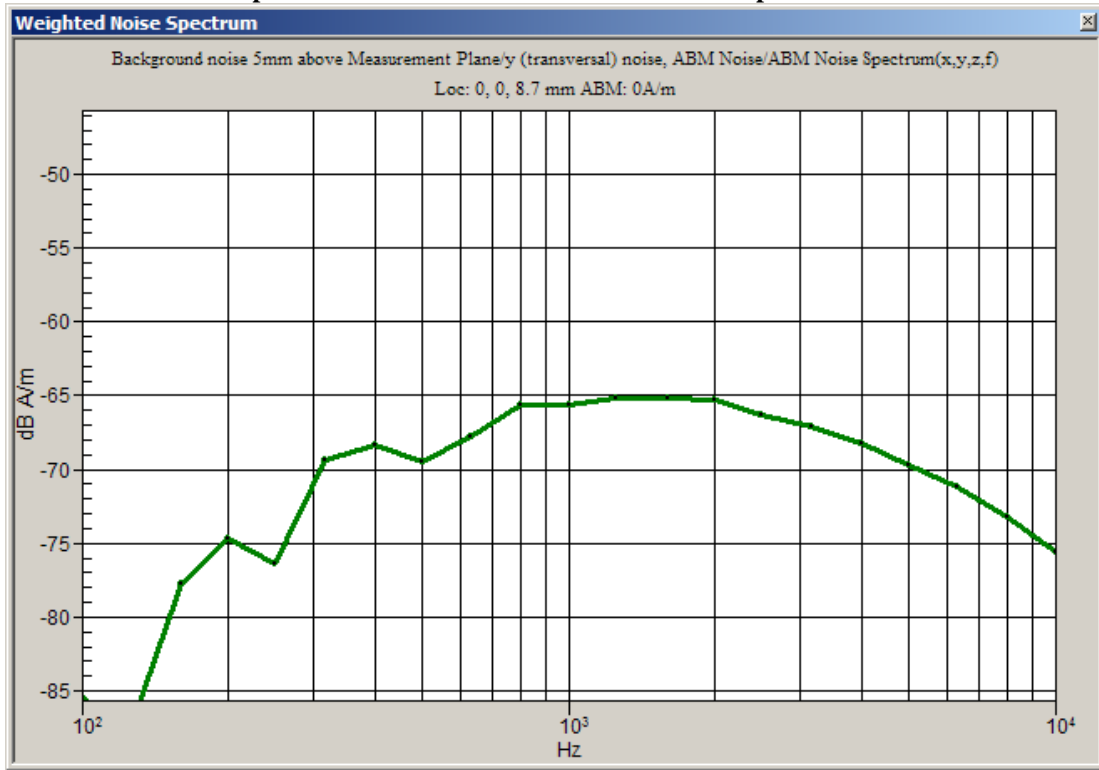

**Appendix 3**

**Details on the Measurement Systems**

**3-1) Details on ABM2 measurements by the system**

**(Description provided by Schmid & Partner Engineering, AG):**

The processing applies a convolution in the time-domain. This filtering is composed of integrator (straight-forward), Half-Band filter (first-order filter) and A-weighting. The convolved data stream is then integrated over the desired period and represented and stored numerically in DASY4 as the ABM Noise (= ABM2).

During the validation process of our system, the functionality of this process has been verified by debugging the filters step-by-step progressive and comparing the results also with a Rohde & Schwarz UPL Analyzer. The intermediate steps are not accessible in the final software code operated by the end user. In addition, the following verification has been made, using a single frequency (sine) signal: At the reference frequency of 1 kHz, the signal is equivalent to ABM1. ABM1 is visible from the calibration job, inclusive its frequency slope from 100Hz to 5kHz. This function (conversion of the coil voltage to the field) is the same integration function.

The verification of the probe linearity and the linearity of the integrator has been determined and documented in the certificate 880-SP AM1 001 A, inclusive the integrator, over the required frequency range (exceeding 5 kHz). The additional frequency slope of the Half-Band filter and the A-weighting have also been tested by changing the applied frequency over the full range. The attenuation was verified for each third-octave-band and up to > 10 kHz. In addition, the correct processing of multiple sine-wave signals was verified.

The convolutions work over the full frequency range available in the analog path, only limited by AC-coupling at the low end and anti-aliasing filter at the high frequency end. White noise signal without band limitation has not been used for filter measurements. Pink noise, decreasing with frequency, resulting in a frequency independent response of the third-octave filter bank was used to optically verify the correct filtering function. Precision measurements were however made with pure sine signals.

Frequency components beyond the visible range of 5 kHz are contained in the ABM2 figure.

**(Measurements made by Motorola):**

Comparison of 1kHz narrowband signal driven externally into TMFS coil

ABM1 @ 1kHz	ABM2 @ 1kHz	difference
-25.122	-25.124	0.002 dB

Frequency dependent ABM1 - ABM2 with broadband noise and narrowband tones driven externally into TMFS coil

Frequency	dB difference ABM1-ABM2 broadband signal	dB difference ABM1-ABM2 single frequency signals	ideal value for ABM1-ABM2	variance from ideal broadband	variance from ideal single frequencies
200		22.062	22.35		0.288
250			17.89		
315			14.03		
400		10.371	10.39		0.019
500	6.852		7.18	0.328	
630	4.228		4.36	0.132	
800	1.587	1.881	1.88	0.293	-0.001
1000	0.013	0.013	0	-0.013	-0.013
1250	-1.473		-1.46	0.013	
1600	-2.72		-2.58	0.14	
2000	-3.535	-3.235	-3.24	0.295	-0.005
2500	-3.736		-3.67	0.068	
3150	-3.837		-3.79	0.047	
4000	-3.733	-3.744	-3.75	-0.017	-0.006
5000	-3.283	-3.336	-3.34	-0.057	-0.004
<b>maximum variation from ideal:</b>				<b>0.328 dB</b>	

**3-2) Details on the compliancy of the frequency and linearity response****(Description provided by Schmid & Partner Engineering, AG):**

See also probe certificate of conformity in Appendix 6, titled 880-SP AM1 001 A-A

See also coil certificate of conformity in Appendix 7, titled 880-SD HAC P02A-A

Frequency response has been tested to be within +/- 0.5 dB of ideal differentiator from 100 Hz to 10 kHz. The test was made with the real integrator and deducting the ideal integrator values. Reference signal was the Helmholtz calibration coil current which is equivalent to the field. The coil is qualified according to certificate 880-SD HAC P02 A-A.

The test data up to 5 kHz are visible directly in the calibration job result (coil current / shunt voltage, and probe voltage). Separate measurements were made for a very wide frequency range, including higher frequencies. For the third-octave bands up to 5 kHz do not exceed 0.05 dB and decay by < 0.2 dB to 5 kHz and by < 0.5 dB to 10 kHz, as required.

Linearity has also been tested and is stated in the certificate. Deviation was not measurable from 5 dB below limitation to 26 dB above noise level. For lower levels, the deviation increased to 0.1 dB at 16 dB above noise level, which corresponds to the theoretical value of 0.11 dB expected at that noise suppression level.

Significant noise contribution beyond 10 kHz will be attenuated by the convoluting A-filter as explained in answer #2. Such interferences contribute also to ABM2 represented as numerical value from the integration.

**3-3) Details on Measurements by the systems**

Details regarding timing and averaging of the reported final measured points are as follows:

	Narrowband Signal	Broadband Signal
Signal Length (sec):	1	2
Total Data Acquisition Time per Location (sec):	2	12
	Averaging is over 2 signal repetitions	Averaging is over 6 signal repetitions

The broadband signal utilized is shown in the following plot:

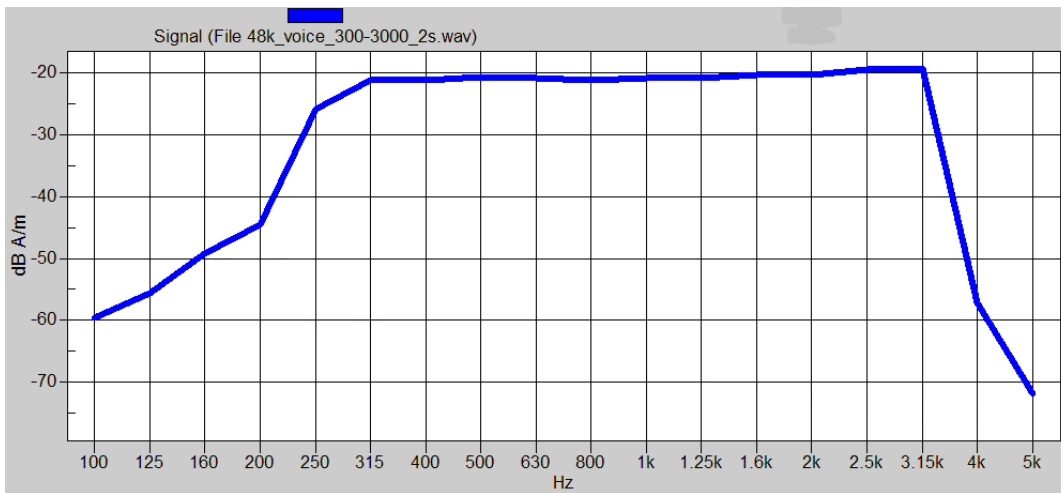

Mathematical processing is not required because the preferred method (as described in IEEE ANSI C63.19-2007 section 6.3) is utilized. The broadband audio signal is used only for assessment of frequency response. The DASY4 system corrects for the spectral response after measurement since it knows the spectrum of the input signal. However, please note that for the signal that we use, the spectrum is flat when measured in 1/3 octave bands, covering the range up to 3kHz.

The narrowband signal utilized is shown in the following plot:

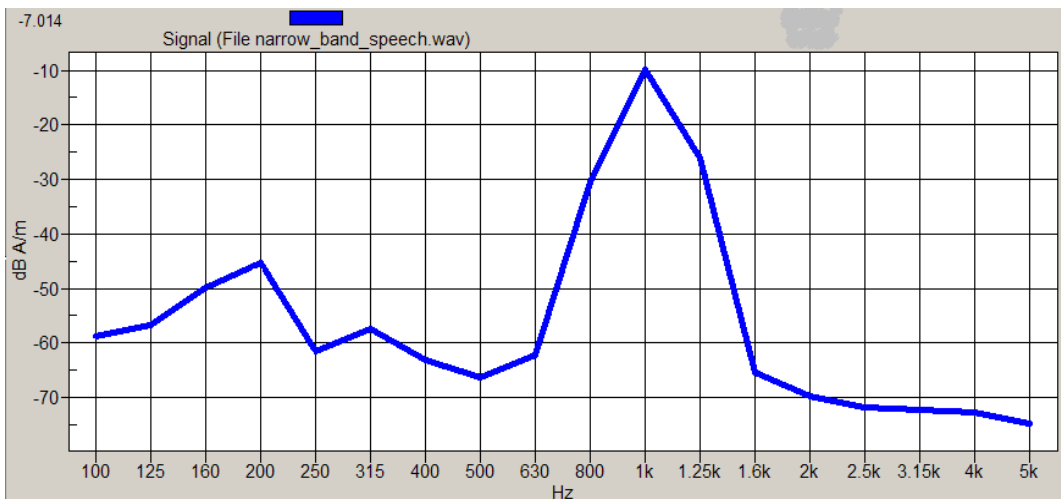

**3-4) Details of the source audio signals for all aspects of the test**

Here is the temporal response of the narrow band signal. The signal is one second of the standard P.50 speech band limited to the ANSI 1kHz 1/3 octave band. The signal is Hann windowed to ensure continuity of the signal.

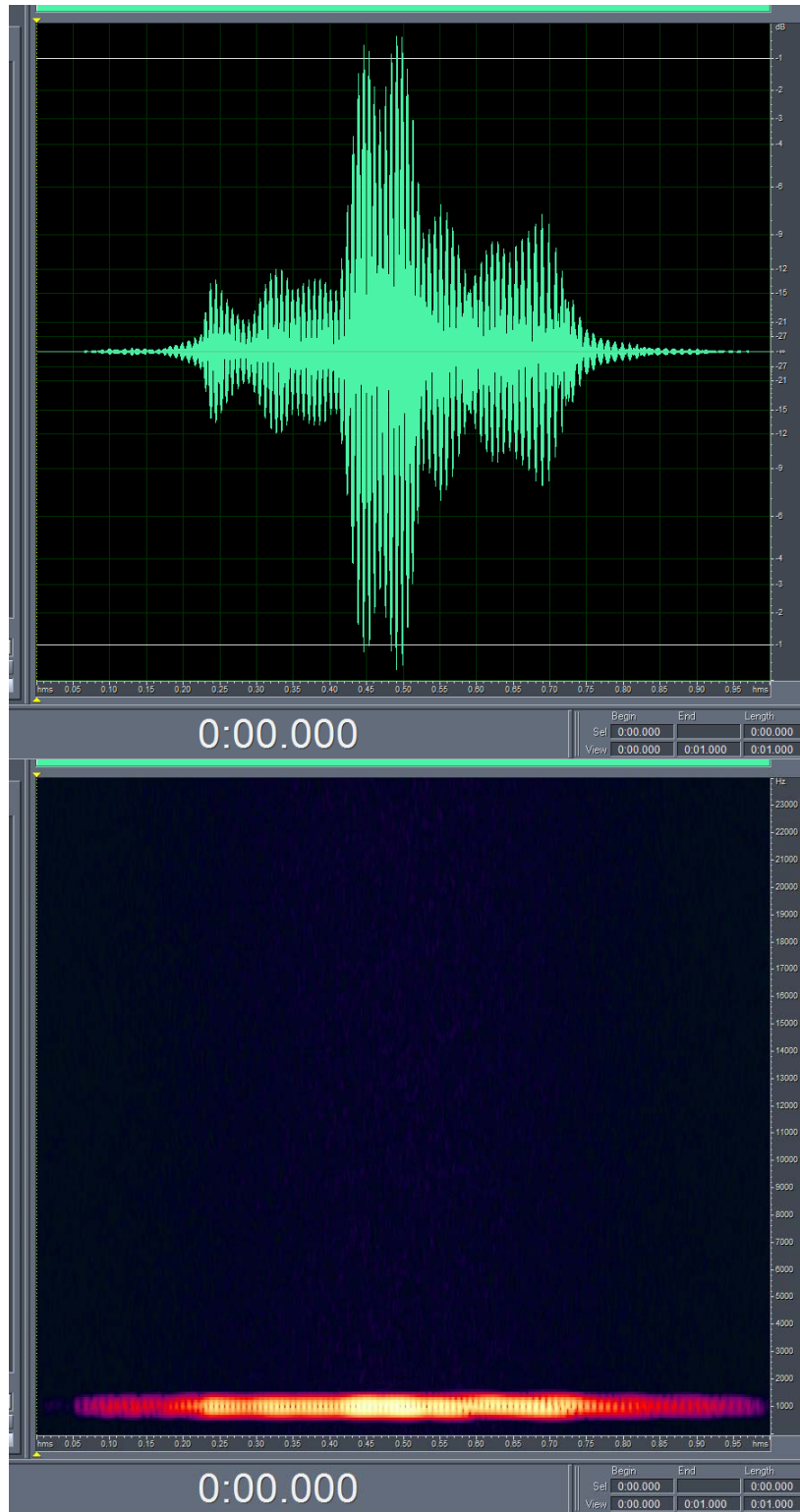

Here is the temporal response of the 300Hz-3kHz broadband signal. The signal is a 2 second segment of the standard P.50 speech that is equalized flat (for ANSI 1/3 octaves) over the 300Hz to 3kHz range. The signal is Hann windowed to ensure continuity of the signal.

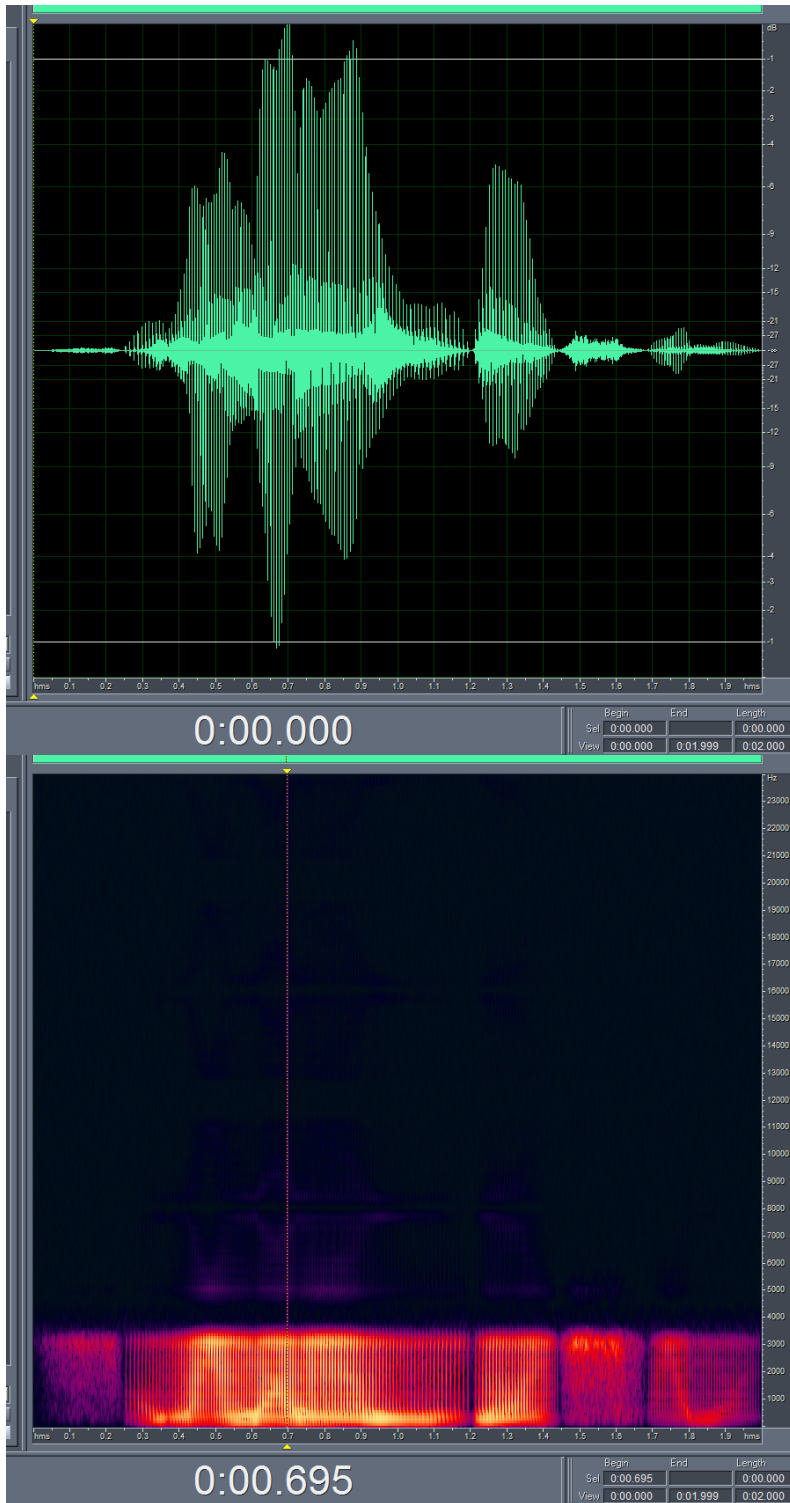

**3-5) Details of the CMU-200 “0dBm0 Input Reference value”****Measure “Ref Input Level”**

- a) Generate a 1 kHz Sine Signal using AMMI.
- b) Capture a signal level using AMMI.
- c) Record the value as the "Ref Input Level"

**Measure Value “X”**

- d) Connect CMU to AMMI.
- e) Connect a phone which operates in the desired modulation to the CMU. Establish a call to the CMU. Select Decoder Cal on CMU.
- f) Capture a signal level from CMU using AMMI.
- g) Record the value as the "Value X".

**Measure Value “M”**

- h) Make another connection from AMMI to CMU. Change to Encoder Cal on CMU.
- i) Generate a 1 kHz Sine Signal using AMMI
- j) Capture a signal from CMU using AMMI.
- k) Record the value as the "Value M".

Calculate the resulting Input Correction Factor & the 0dBm0 Input Reference

**Relevant Equations:**

Measured values from above: Ref Input Level, X, M

Input Correction Factor = Ref Input Level + X – M

0dBm0 Input Reference =  $10^{(\text{Input Corr Factor}/20)}$  \* CMU-200 manual ref value

**Appendix 4**

**Pictures of Test Setup**

See Exhibit 7B

**Appendix 5**

**Motorola Uncertainty Budget**

**Table A5-1: Telecoil Uncertainty Budget, provided by SPEAG**

Error Description	Uncertainty value (%)	Prob. Dist.	Div.	c ABM1	c ABM2	St.Unc ABM1 (%)	St.Unc ABM2 (%)
<b>PROBE SENSITIVITY</b>							
Reference level	3.0	N	1	1	1	3.0	3.0
AMCC geometry	0.4	R	1.7	1	1	0.2	0.2
AMCC current	0.6	R	1.7	1	1	0.4	0.4
Probe positioning during calibration	0.1	R	1.7	1	1	0.1	0.1
Noise contribution	0.7	R	1.7	0.0143	1	0.0	0.4
Frequency slope	5.9	R	1.7	0.1	1	0.3	3.5
<b>PROBE SYSTEM</b>							
Repeatability / Drift	1.0	R	1.7	1	1	0.6	0.6
Linearity / Dynamic range	0.6	R	1.7	1	1	0.4	0.4
Acoustic noise	1.0	R	1.7	0.1	1	0.1	0.6
Probe angle	2.3	R	1.7	1	1	1.4	1.4
Spectral processing	0.9	R	1.7	1	1	0.5	0.5
Integration time	0.6	N	1	1	5	0.6	3.0
Field disturbance	0.2	R	1.7	1	1	0.1	0.1
<b>TEST SIGNAL</b>							
Reference signal spectral response	0.6	R	1.7	0	1	0.0	0.4
<b>POSITIONING</b>							
Probe positioning	1.9	R	1.7	1	1	1.1	1.1
Phantom thickness	0.9	R	1.7	1	1	0.5	0.5
DUT positioning **	4.0	R	1.7	1	1	2.4	2.4
<b>EXTERNAL CONTRIBUTIONS</b>							
RF interference	0.0	R	1.7	1	1	0.0	0.0
Test signal variation	2.0	R	1.7	1	1	1.2	1.2
<b>COMBINED UNCERTAINTY</b>							
<b>Combined Std.Uncert. (ABM field)</b>						4.6	6.5
<b>Expanded Std. Uncertainty, k=2 (%)</b>						9.1	12.9

\*\* based on repeat measurements of reference unit

**Appendix 6**

**Audio Magnetic Probe Certificate**



Accredited by the Swiss Accreditation Service (SAS)  
The Swiss Accreditation Service is one of the signatories to the EA  
Multilateral Agreement for the recognition of calibration certificates  
Client **Motorola MDb**

Accreditation No.: **SCS 108**

Certificate No: **AM1DV3-3080\_Nov10**

## CALIBRATION CERTIFICATE

Object **AM1DV3 - SN: 3080**

Calibration procedure(s) **QA CAL-24.v2  
Calibration procedure for AM1D magnetic field probes and TMFS in the  
audio range**

Calibration date: **November 29, 2010**

This calibration certificate documents the traceability to national standards, which realize the physical units of measurements (SI).  
The measurements and the uncertainties with confidence probability are given on the following pages and are part of the certificate.

All calibrations have been conducted in the closed laboratory facility: environment temperature (22 ± 3)°C and humidity < 70%.

Calibration Equipment used (M&TE critical for calibration)

Primary Standards	ID #	Cal Date (Certificate No.)	Scheduled Calibration
Keithley Multimeter Type 2001	SN: 0810278	28-Sep-10 (No:10376)	Sep-11
Reference Probe AM1DV3	SN: 3000	6-Sep-10 (No. AM1D-3000_Sep10)	Sep-11
DAE4	SN: 781	22-Jan-10 (No. DAE4-781_Jan10)	Jan-11
Secondary Standards	ID #	Check Date (in house)	Scheduled Check
AMCC	1050	15-Oct-09 (in house check Oct-09)	Oct-11

	Name	Function	Signature
Calibrated by:	Mike Meili	Laboratory Technician	
Approved by:	Fin Bomholt	R&D Director	

Issued: November 29, 2010

This calibration certificate shall not be reproduced except in full without written approval of the laboratory.

## References

- [1] ANSI C63.19-2007  
American National Standard for Methods of Measurement of Compatibility between Wireless Communications Devices and Hearing Aids.
- [2] DASY4 manual, Chapter: Hearing Aid Compatibility (HAC) T-Coil Extension

## Description of the AM1D probe

The AM1D Audio Magnetic Field Probe is a fully shielded magnetic field probe for the frequency range from 100 Hz to 20 kHz. The pickup coil is compliant with the dimensional requirements of [1]. The probe includes a symmetric low noise amplifier for the signal available at the shielded 3 pin connector at the side. Power is supplied via the same connector (phantom power supply) and monitored via the LED near the connector. The 7 pin connector at the end of the probe does not carry any signals, but determines the angle of the sensor when mounted on the DAE. The probe supports mechanical detection of the surface.

The single sensor in the probe is arranged in a tilt angle allowing measurement of 3 orthogonal field components when rotating the probe by 120° around its axis. It is aligned with the perpendicular component of the field, if the probe axis is tilted nominally 35.3° above the measurement plane, using the connector rotation and sensor angle stated below.

The probe is fully RF shielded when operated with the matching signal cable (shielded) and allows measurement of audio magnetic fields in the close vicinity of RF emitting wireless devices according to [1] without additional shielding.

## Handling of the item

The probe is manufactured from stainless steel. In order to maintain the performance and calibration of the probe, it must not be opened. The probe is designed for operation in air and shall not be exposed to humidity or liquids. For proper operation of the surface detection and emergency stop functions in a DASY system, the probe must be operated with the special probe cup provided (larger diameter).

## Methods Applied and Interpretation of Parameters

- *Coordinate System:* The AM1D probe is mounted in the DASY system for operation with a HAC Test Arch phantom with AMCC Helmholtz calibration coil according to [2], with the tip pointing to "southwest" orientation.
- *Functional Test:* The functional test preceding calibration includes test of Noise level  
RF immunity (1kHz AM modulated signal). The shield of the probe cable must be well connected.  
Frequency response verification from 100 Hz to 10 kHz.
- *Connector Rotation:* The connector at the end of the probe does not carry any signals and is used for fixation to the DAE only. The probe is operated in the center of the AMCC Helmholtz coil using a 1 kHz magnetic field signal. Its angle is determined from the two minima at nominally +120° and -120° rotation, so the sensor in the tip of the probe is aligned to the vertical plane in z-direction, corresponding to the field maximum in the AMCC Helmholtz calibration coil.
- *Sensor Angle:* The sensor tilting in the vertical plane from the ideal vertical direction is determined from the two minima at nominally +120° and -120°. DASY system uses this angle to align the sensor for radial measurements to the x and y axis in the horizontal plane.
- *Sensitivity:* With the probe sensor aligned to the z-field in the AMCC, the output of the probe is compared to the magnetic field in the AMCC at 1 kHz. The field in the AMCC Helmholtz coil is given by the geometry and the current through the coil, which is monitored on the precision shunt resistor of the coil.

## AM1D probe identification and configuration data

Item	<b>AM1DV3</b> Audio Magnetic 1D Field Probe
Type No	SP AM1 001 BA
Serial No	<b>3080</b>

Overall length	296 mm
Tip diameter	6.0 mm (at the tip)
Sensor offset	3.0 mm (centre of sensor from tip)
Internal Amplifier	20 dB

Manufacturer / Origin	Schmid & Partner Engineering AG, Zürich, Switzerland
Manufacturing date	May-2010
Last calibration date	n/a

## Calibration data

Connector rotation angle	(in DASY system)	<b>157.7 °</b>	+/- 3.6 ° (k=2)
Sensor angle	(in DASY system)	<b>0.69 °</b>	+/- 0.5 ° (k=2)
Sensitivity at 1 kHz	(in DASY system)	<b>0.00739 V / (A/m)</b>	+/- 2.2 % (k=2)

**Appendix 7**

**AMCC Certificate (Helmholtz Coil)**

**Certificate of conformity**

Item	Audio Magnetic Calibration Coil AMCC
Type No	SD HAC P02 A
Series No	1001 ff.
Manufacturer / Origin	Schmid & Partner Engineering AG Zurich, Switzerland

**Description of the item**

The Audio Magnetic Calibration coil (AMCC) is a Helmholtz Coil designed according to standard [1], section D.9 for calibration of the AM1D probe. Two horizontal coils are positioned above a non-metallic base plate and generate a homogeneous magnetic field in the z direction (normal to it).

**Configuration**

The AMCC consists of two parallel coils of 20 turns with radius 143 mm connected in parallel in a distance of 143 mm. With this design, a current of 10 mA produces a field of 1 A/m. The DC input resistance at the input BNC socket is adjusted by a series resistor to a DC resistance of approximately 50 Ohm. The voltage required to produce a field of 1 A/m is consequently approx. 500 mV.

The current through the coil is monitored via a shunt resistor of 10 Ohm +/- 1%. The voltage is available on a BNO socket with 100 mV corresponding to 1 A/m.

**Handling of the item**

The coil shall be positioned in a non-metallic environment to avoid distortion of the magnetic field.

**Tests**

Test	Requirement	Details	Units tested
Number of turns	N = 20 per coil	Resistance measurement	all
Orientation of coils	parallel coils with same direction of windings	Magnetic field variation in the AMCC axis	all
Coil radius	r = 143 mm	mechanical dimension	First article
Coil distance	d = 143 mm distance between coil centers	mechanical dimension	First article
Input resistance	51.7 +/- 2 Ohm	DC resistance at BNC input connector	all
Shunt resistance	R = 10.0 Ohm +/- 1 %	DC resistance at BNO output connector	all
Shunt sensitivity	Hc = 1 A/m per 100 mV according to formula $H_c = (U / R) * N / r / (1.25^{*1.5})$	Field measurement compared with Narda ELT400 + BN2300/90.10	First article

**Standards**

[1] ANSI PC63.19-2006 Draft 3.12

**Conformity**

Based on the tests above, we certify that this item is in compliance with the requirements of [1].

Date

22.5.2006

Stamp / Signature

**s p e a g**

Schmid & Partner Engineering AG  
 Zeughausstrasse 43, 8004 Zurich, Switzerland  
 Phone +41 1 245 9700, Fax +41 1 245 9779  
 info@speag.com, http://www.speag.com

**Appendix 8**

**HAC Distribution plots for E-Field and H-Field**

Date/Time: 8/11/2011 1:58:57 PM

## Test Laboratory: Motorola - CDMA 800 E-Field, Full Rate Vocoder

Serial: LS4V230096; FCC ID: IHDP56ME1

Procedure Notes: Pwr Step: All Up Bits; Antenna Position: INTERNAL; Accessory Model #: N/A

Battery Model #: Internal; Vocoder Rate: Full Rate; Positioner: Polystyrene Block

Communication System: CDMA 835; Frequency: 824.7 MHz; Channel Number: 1013; Duty Cycle: 1:1

Medium: Air; Medium parameters used:  $\sigma = 0$  mho/m,  $\epsilon_r = 1$ ;  $\rho = 0$  kg/m<sup>3</sup>

DASY4 Configuration:

- Probe: ER3DV6R - SN2248; ConvF(1, 1, 1); Calibrated: 4/15/2011
- Sensor-Surface: (Fix Surface)
- Electronics: DAE3 Sn378; Calibrated: 4/14/2011
- Phantom: R-3, HAC Test Arch (rev.2); Type: SD HAC P01 BA; Serial: 1071;
- Measurement SW: DASY4, V4.7 Build 80; Postprocessing SW: SEMCAD, V1.8 Build 186

### E Scan - Sensor center 15mm above WD, Hearing Aid Compatibility Test (101x101x1):

Measurement grid: dx=5mm, dy=5mm

Maximum value of peak Total field = 99.5 V/m; Probe Modulation Factor = 1.05

Device Reference Point: 0.000, 0.000, -6.30 mm; Reference Value = 114.1 V/m; Power Drift = -0.090 dB

Hearing Aid Near-Field Category: **M4 (AWF 0 dB)**

Peak E-field in V/m

Grid 1 <b>84.0 M4</b>	Grid 2 <b>97.9 M4</b>	Grid 3 <b>96.7 M4</b>
Grid 4 <b>84.7 M4</b>	Grid 5 <b>99.5 M4</b>	Grid 6 <b>99.6 M4</b>
Grid 7 <b>85.1 M4</b>	Grid 8 <b>98.2 M4</b>	Grid 9 <b>97.8 M4</b>

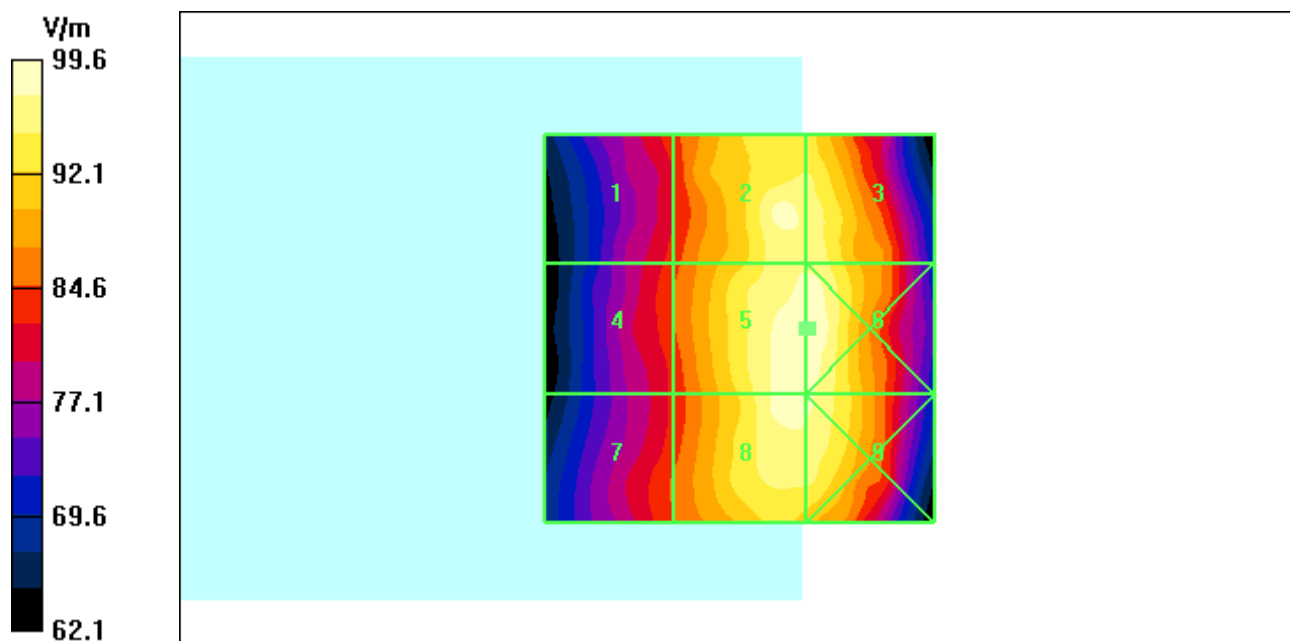

Date/Time: 8/17/2011 10:51:39 PM

## Test Laboratory: Motorola - CDMA 1900 E-Field, Full Rate Vocoder

Serial: LS4V230096; FCC ID: IHDP56ME1

Procedure Notes: Pwr Step: All Up Bits; Antenna Position: Internal; Accessory Model #: N/A

Battery Model #: Internal; Vocoder Rate: Full Rate; Positioner: Polystyrene Block

Communication System: CDMA 1900; Frequency: 1908.75 MHz; Channel Number: 1175; Duty Cycle: 1:1

Medium: Air; Medium parameters used:  $\sigma = 0$  mho/m,  $\epsilon_r = 1$ ;  $\rho = 0$  kg/m<sup>3</sup>

DASY4 Configuration:

- Probe: ER3DV6R - SN2248; ConvF(1, 1, 1); Calibrated: 4/15/2011
- Sensor-Surface: (Fix Surface)
- Electronics: DAE3 Sn378; Calibrated: 4/14/2011
- Phantom: R-3, HAC Test Arch (rev.2); Type: SD HAC P01 BA; Serial: 1071;
- Measurement SW: DASY4, V4.7 Build 80; Postprocessing SW: SEMCAD, V1.8 Build 186

### E Scan - Sensor center 15mm above WD, Hearing Aid Compatibility Test (101x101x1):

Measurement grid: dx=5mm, dy=5mm

Maximum value of peak Total field = 50.9 V/m; Probe Modulation Factor = 1.06

Device Reference Point: 0.000, 0.000, -6.30 mm; Reference Value = 41.8 V/m; Power Drift = -0.096 dB

Hearing Aid Near-Field Category: **M4 (AWF 0 dB)**

Peak E-field in V/m

Grid 1 <b>25.4 M4</b>	Grid 2 <b>44.1 M4</b>	Grid 3 <b>46.6 M4</b>
Grid 4 <b>36.1 M4</b>	Grid 5 <b>50.9 M4</b>	Grid 6 <b>52.4 M4</b>
Grid 7 <b>47.4 M4</b>	Grid 8 <b>55.7 M4</b>	Grid 9 <b>55.7 M4</b>

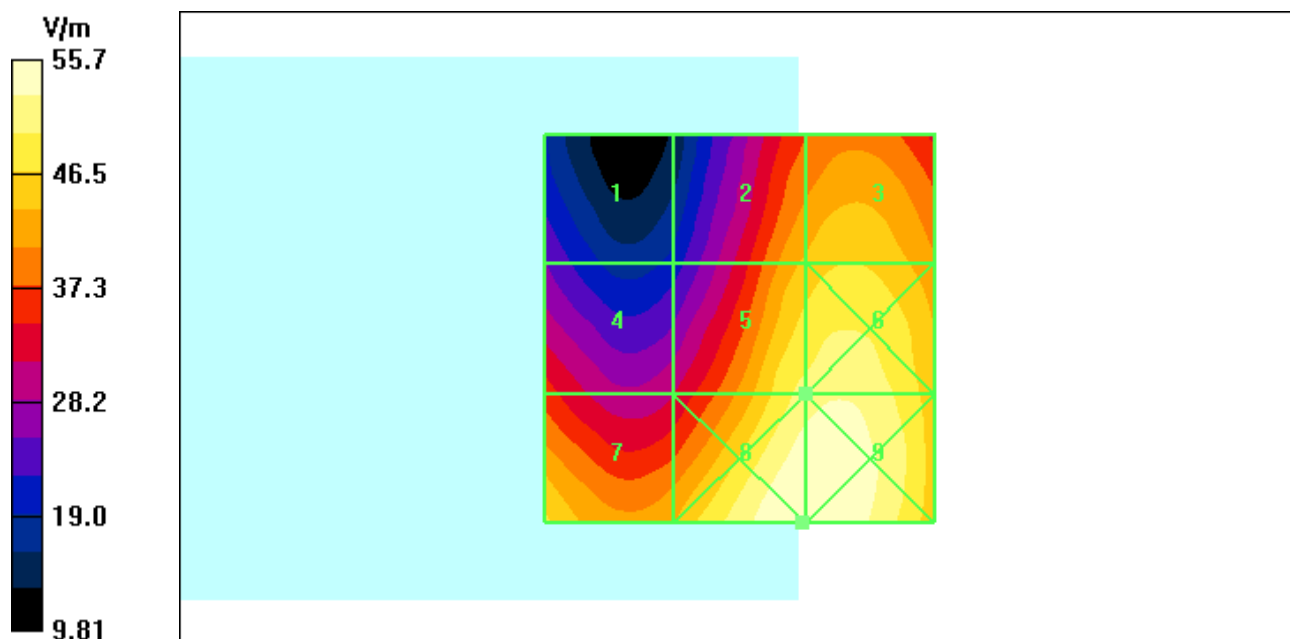

Date/Time: 8/11/2011 2:27:39 PM

## Test Laboratory: Motorola - CDMA 800 E-Field, 1/8th Rate Vocoder

Serial: LS4V230096; FCC ID: IHDP56ME1

Procedure Notes: Pwr Step: All Up Bits; Antenna Position: Internal; Accessory Model #: N/A

Battery Model #: Internal; Vocoder Rate: 1/8th Rate; Positioner: Polystyrene Block

Communication System: CDMA 835; Frequency: 824.7 MHz; Channel Number: 1013; Duty Cycle: 1:8

Medium: Air; Medium parameters used:  $\sigma = 0$  mho/m,  $\epsilon_r = 1$ ;  $\rho = 0$  kg/m<sup>3</sup>

DASY4 Configuration:

- Probe: ER3DV6R - SN2248; ConvF(1, 1, 1); Calibrated: 4/15/2011
- Sensor-Surface: (Fix Surface)
- Electronics: DAE3 Sn378; Calibrated: 4/14/2011
- Phantom: R-3, HAC Test Arch (rev.2); Type: SD HAC P01 BA; Serial: 1071;
- Measurement SW: DASY4, V4.7 Build 80; Postprocessing SW: SEMCAD, V1.8 Build 186

### E Scan - Sensor center 15mm above WD, Hearing Aid Compatibility Test (101x101x1):

Measurement grid: dx=5mm, dy=5mm

Maximum value of peak Total field = 99.2 V/m; Probe Modulation Factor = 2.84

Device Reference Point: 0.000, 0.000, -6.30 mm; Reference Value = 41.4 V/m; Power Drift = 0.107 dB

Hearing Aid Near-Field Category: **M4 (AWF 0 dB)**

Peak E-field in V/m

Grid 1 <b>83.0 M4</b>	Grid 2 <b>96.6 M4</b>	Grid 3 <b>96.9 M4</b>
Grid 4 <b>84.9 M4</b>	Grid 5 <b>99.2 M4</b>	Grid 6 <b>99.4 M4</b>
Grid 7 <b>82.5 M4</b>	Grid 8 <b>95.9 M4</b>	Grid 9 <b>95.8 M4</b>

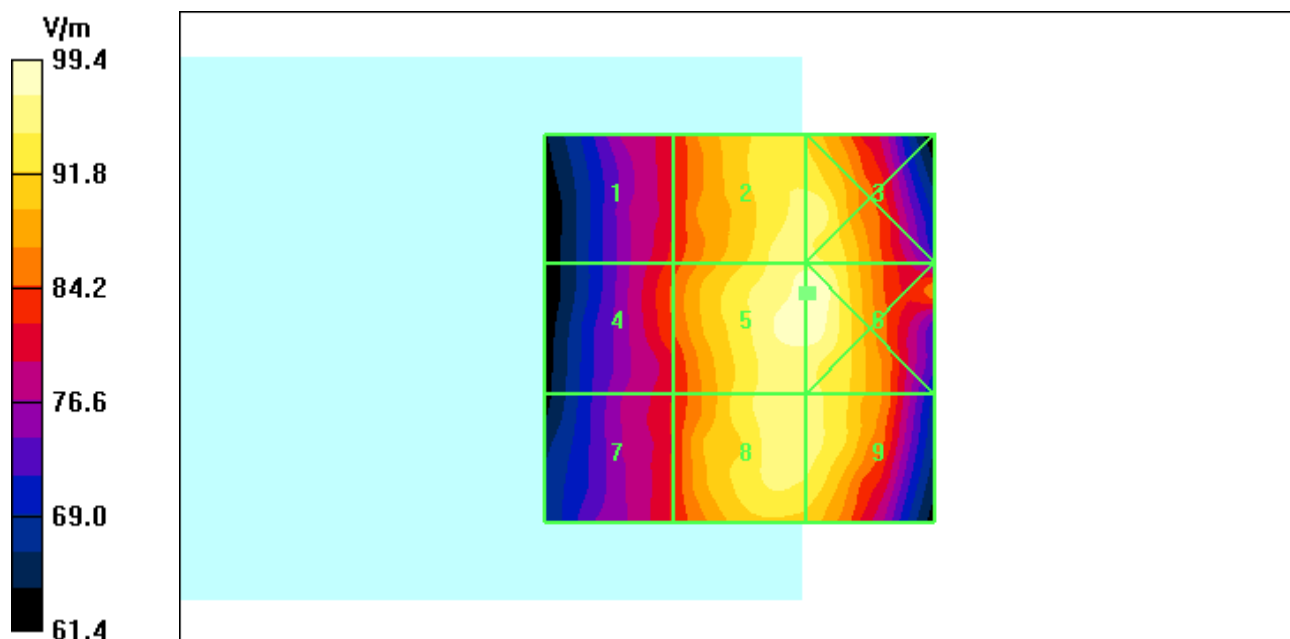

Date/Time: 8/18/2011 12:15:14 AM

## Test Laboratory: Motorola - CDMA 1900 E-Field, 1/8th Rate Vocoder

Serial: LS4V230096; FCC ID: IHDP56ME1

Procedure Notes: Pwr Step: All Up Bits; Antenna Position: Internal; Accessory Model #: N/A

Battery Model #: Internal; Vocoder Rate: Full Rate; Positioner: Polystyrene Block

Communication System: CDMA 1900; Frequency: 1908.75 MHz; Channel Number: 1175; Duty Cycle: 1:8

Medium: Air; Medium parameters used:  $\sigma = 0$  mho/m,  $\epsilon_r = 1$ ;  $\rho = 0$  kg/m<sup>3</sup>

DASY4 Configuration:

- Probe: ER3DV6R - SN2248; ConvF(1, 1, 1); Calibrated: 4/15/2011
- Sensor-Surface: (Fix Surface)
- Electronics: DAE3 Sn378; Calibrated: 4/14/2011
- Phantom: R-3, HAC Test Arch (rev.2); Type: SD HAC P01 BA; Serial: 1071;
- Measurement SW: DASY4, V4.7 Build 80; Postprocessing SW: SEMCAD, V1.8 Build 186

### E Scan - Sensor center 15mm above WD, Hearing Aid Compatibility Test (101x101x1):

Measurement grid: dx=5mm, dy=5mm

Maximum value of peak Total field = 49.0 V/m; Probe Modulation Factor = 2.89

Device Reference Point: 0.000, 0.000, -6.30 mm; Reference Value = 14.7 V/m; Power Drift = 0.007 dB

Hearing Aid Near-Field Category: **M4 (AWF 0 dB)**

Peak E-field in V/m

Grid 1 <b>25.3 M4</b>	Grid 2 <b>42.3 M4</b>	Grid 3 <b>45.9 M4</b>
Grid 4 <b>36.6 M4</b>	Grid 5 <b>49.0 M4</b>	Grid 6 <b>51.2 M4</b>
Grid 7 <b>48.5 M4</b>	Grid 8 <b>54.3 M4</b>	Grid 9 <b>54.5 M4</b>

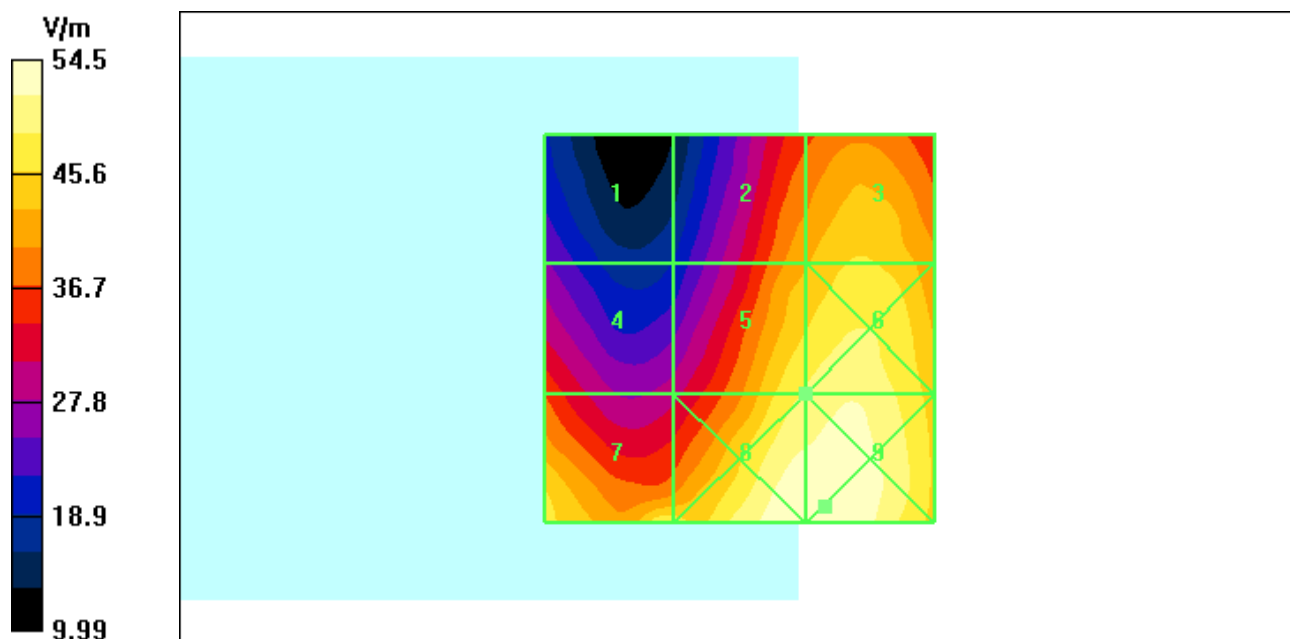

Date/Time: 8/18/2011 9:04:02 AM

## Test Laboratory: Motorola - CDMA 800 H-Field, Full Rate Vocoder

Serial: LS4V230096; FCC ID: IHDP56ME1

Procedure Notes: Pwr Step: All Up Bits; Antenna Position: Internal; Accessory Model #: N/A

Battery Model #: Internal; Vocoder Rate: Full Rate; Positioner: Polystyrene Block

Communication System: CDMA 835; Frequency: 824.7 MHz; Channel Number: 1013; Duty Cycle: 1:1

Medium: Air; Medium parameters used:  $\sigma = 0$  mho/m,  $\epsilon_r = 1$ ;  $\rho = 0$  kg/m<sup>3</sup>

DASY4 Configuration:

- Probe: H3DV6 - SN6074; ; Calibrated: 4/11/2011
- Sensor-Surface: (Fix Surface)
- Electronics: DAE4 Sn661; Calibrated: 1/13/2011
- Phantom: R-3, HAC Test Arch (rev.2); Type: SD HAC P01 BA; Serial: 1071;
- Measurement SW: DASY4, V4.7 Build 80; Postprocessing SW: SEMCAD, V1.8 Build 186

### H Scan - Sensor center 15mm above WD, Hearing Aid Compatibility Test (101x101x1):

Measurement grid: dx=5mm, dy=5mm;

Maximum value of peak Total field = 0.139 A/m; Probe Modulation Factor = 1.02;

Device Reference Point: 0.000, 0.000, -6.30 mm; Reference Value = 0.106 A/m; Power Drift = -0.169 dB

**Hearing Aid Near-Field Category: M4 (AWF 0 dB)**

Peak H-field in A/m

Grid 1 <b>0.181 M4</b>	Grid 2 <b>0.137 M4</b>	Grid 3 <b>0.090 M4</b>
Grid 4 <b>0.171 M4</b>	Grid 5 <b>0.129 M4</b>	Grid 6 <b>0.082 M4</b>
Grid 7 <b>0.192 M4</b>	Grid 8 <b>0.139 M4</b>	Grid 9 <b>0.082 M4</b>

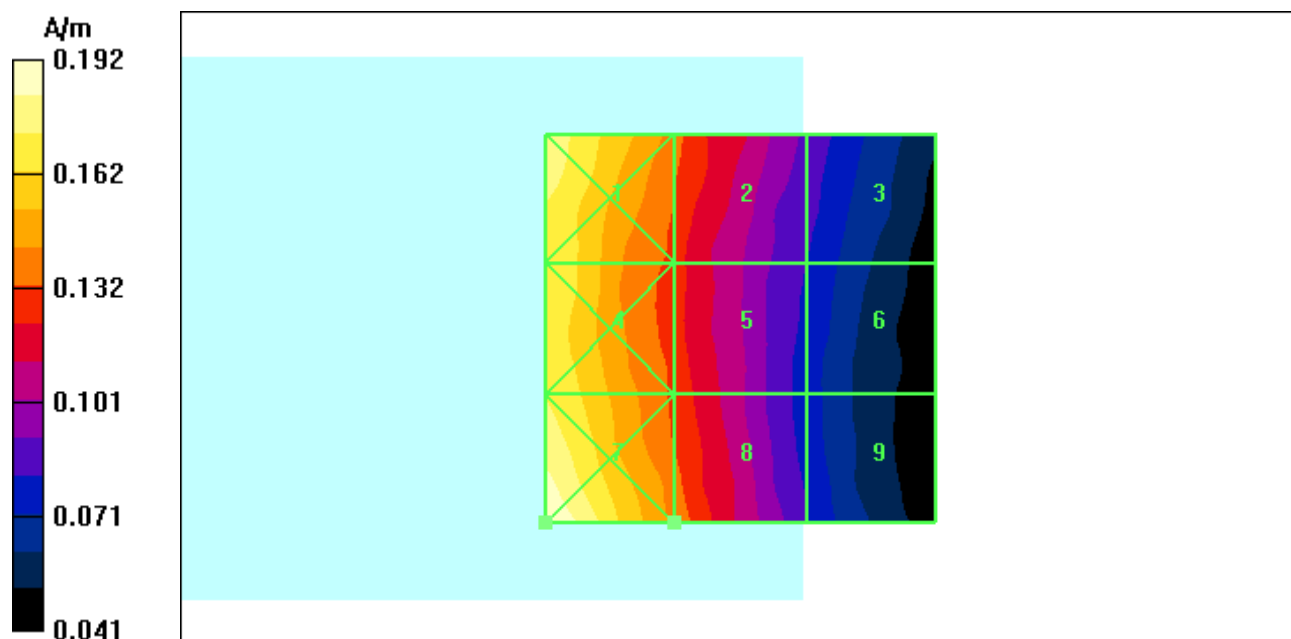

Date/Time: 8/18/2011 10:56:39 AM

## Test Laboratory: Motorola - CDMA 1900 H-Field, Full Rate Vocoder

Serial: LS4V230096; FCC ID: IHDP56ME1

Procedure Notes: Pwr Step: All Up Bits; Antenna Position: Internal; Accessory Model #: N/A

Battery Model #: Internal; Vocoder Rate: Full Rate; Positioner: Polystyrene Block

Communication System: CDMA 1900; Frequency: 1908.75 MHz; Channel Number: 1175; Duty Cycle: 1:1

Medium: Air; Medium parameters used:  $\sigma = 0$  mho/m,  $\epsilon_r = 1$ ;  $\rho = 0$  kg/m<sup>3</sup>

DASY4 Configuration:

- Probe: H3DV6 - SN6074; ; Calibrated: 4/11/2011
- Sensor-Surface: (Fix Surface)
- Electronics: DAE4 Sn661; Calibrated: 1/13/2011
- Phantom: R-3, HAC Test Arch (rev.2); Type: SD HAC P01 BA; Serial: 1071;
- Measurement SW: DASY4, V4.7 Build 80; Postprocessing SW: SEMCAD, V1.8 Build 186

### H Scan - Sensor center 15mm above WD, Hearing Aid Compatibility Test (101x101x1):

Measurement grid: dx=5mm, dy=5mm

Maximum value of peak Total field = 0.143 A/m; Probe Modulation Factor = 1.02

Device Reference Point: 0.000, 0.000, -6.30 mm; Reference Value = 0.129 A/m; Power Drift = 0.025 dB

**Hearing Aid Near-Field Category: M4 (AWF 0 dB)**

Peak H-field in A/m

Grid 1 <b>0.121 M4</b>	Grid 2 <b>0.120 M4</b>	Grid 3 <b>0.098 M4</b>
Grid 4 <b>0.145 M4</b>	Grid 5 <b>0.143 M4</b>	Grid 6 <b>0.114 M4</b>
Grid 7 <b>0.176 M4</b>	Grid 8 <b>0.167 M4</b>	Grid 9 <b>0.125 M4</b>

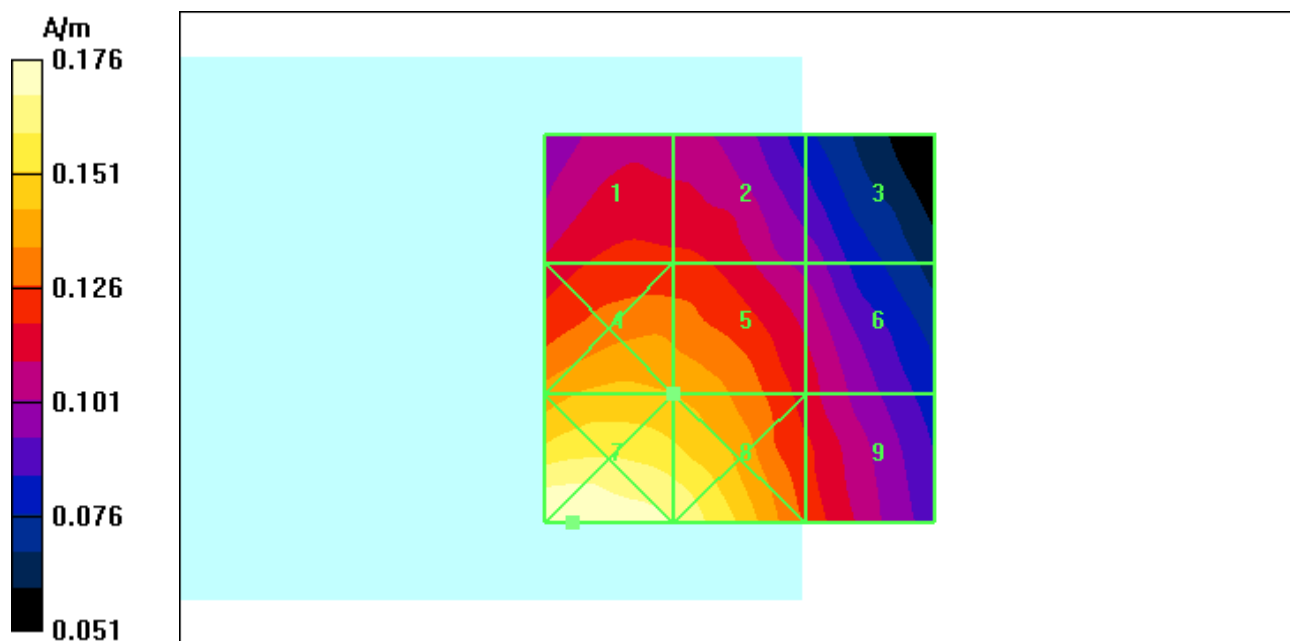

Date/Time: 8/18/2011 9:33:15 AM

## Test Laboratory: Motorola - CDMA 800 H-Field, 1/8th Rate Vocoder

Serial: LS4V230096; FCC ID: IHDP56ME1

Procedure Notes: Pwr Step: All Up Bits; Antenna Position: Internal; Accessory Model #: N/A

Battery Model #: Internal; Vocoder Rate: 1/8th Rate; Positioner: Polystyrene Block

Communication System: CDMA 835; Frequency: 824.7 MHz; Channel Number: 1013; Duty Cycle: 1:8

Medium: Air; Medium parameters used:  $\sigma = 0$  mho/m,  $\epsilon_r = 1$ ;  $\rho = 0$  kg/m<sup>3</sup>

DASY4 Configuration:

- Probe: H3DV6 - SN6074; ; Calibrated: 4/11/2011
- Sensor-Surface: (Fix Surface)
- Electronics: DAE4 Sn661; Calibrated: 1/13/2011
- Phantom: R-3, HAC Test Arch (rev.2); Type: SD HAC P01 BA; Serial: 1071;
- Measurement SW: DASY4, V4.7 Build 80; Postprocessing SW: SEMCAD, V1.8 Build 186

### H Scan - Sensor center 15mm above WD, Hearing Aid Compatibility Test (101x101x1):

Measurement grid: dx=5mm, dy=5mm

Maximum value of peak Total field = 0.128 A/m; Probe Modulation Factor = 2.46

Device Reference Point: 0.000, 0.000, -6.30 mm; Reference Value = 0.041 A/m; Power Drift = 0.052 dB

**Hearing Aid Near-Field Category: M4 (AWF 0 dB)**

Peak H-field in A/m

Grid 1 <b>0.167 M4</b>	Grid 2 <b>0.126 M4</b>	Grid 3 <b>0.086 M4</b>
Grid 4 <b>0.158 M4</b>	Grid 5 <b>0.119 M4</b>	Grid 6 <b>0.079 M4</b>
Grid 7 <b>0.179 M4</b>	Grid 8 <b>0.128 M4</b>	Grid 9 <b>0.088 M4</b>

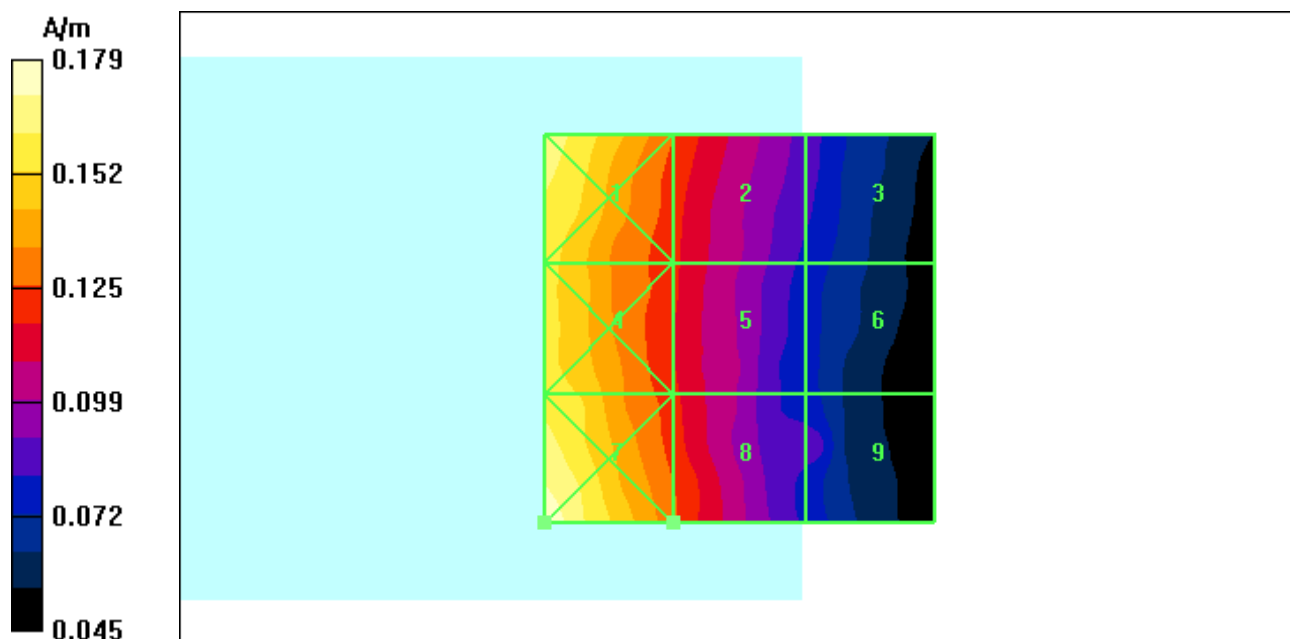

Date/Time: 8/18/2011 2:37:47 AM

## Test Laboratory: Motorola- CDMA 1900 H-Field, 1/8th Rate Vocoder

Serial: LS4V230096; FCC ID: IHDP56ME1

Procedure Notes: Pwr Step: All Up Bits; Antenna Position: Internal; Accessory Model #: N/A

Battery Model #: Internal; Vocoder Rate: Full Rate; Positioner: Polystyrene Block

Communication System: CDMA 1900; Frequency: 1908.75 MHz; Channel Number: 1175; Duty Cycle: 1:8

Medium: Air; Medium parameters used:  $\sigma = 0$  mho/m,  $\epsilon_r = 1$ ;  $\rho = 0$  kg/m<sup>3</sup>

DASY4 Configuration:

- Probe: H3DV6 - SN6074; ; Calibrated: 4/11/2011
- Sensor-Surface: (Fix Surface)
- Electronics: DAE4 Sn661; Calibrated: 1/13/2011
- Phantom: R-3, HAC Test Arch (rev.2); Type: SD HAC P01 BA; Serial: 1071;
- Measurement SW: DASY4, V4.7 Build 80; Postprocessing SW: SEMCAD, V1.8 Build 186

### H Scan - Sensor center 15mm above WD, Hearing Aid Compatibility Test (101x101x1):

Measurement grid: dx=5mm, dy=5mm

Maximum value of peak Total field = 0.125 A/m; Probe Modulation Factor = 2.53

Device Reference Point: 0.000, 0.000, -6.30 mm; Reference Value = 0.046 A/m; Power Drift = 0.026 dB

**Hearing Aid Near-Field Category: M4 (AWF 0 dB)**

Peak H-field in A/m

Grid 1 <b>0.104 M4</b>	Grid 2 <b>0.105 M4</b>	Grid 3 <b>0.087 M4</b>
Grid 4 <b>0.128 M4</b>	Grid 5 <b>0.125 M4</b>	Grid 6 <b>0.102 M4</b>
Grid 7 <b>0.159 M4</b>	Grid 8 <b>0.149 M4</b>	Grid 9 <b>0.111 M4</b>

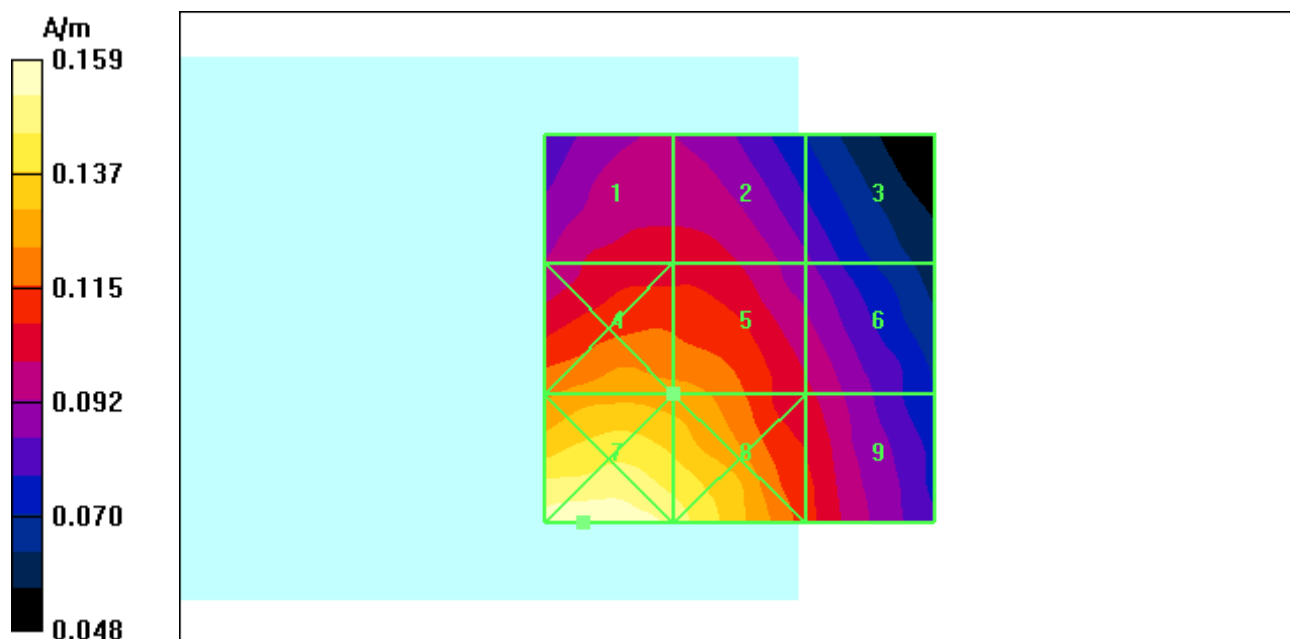

**END OF REPORT**