

## APPENDIX C: PROBE CALIBRATION



Accredited by the Swiss Accreditation Service (SAS)  
The Swiss Accreditation Service is one of the signatories to the EA  
Multilateral Agreement for the recognition of calibration certificates

Accreditation No.: **SCS 108**

Client **PC Test**

Certificate No: **ES3-3209\_Apr11**

**CALIBRATION CERTIFICATE**

Object: **ES3DV3 - SN:3209**

Calibration procedure(s): **QA CAL-01.v7, QA CAL-12.v6, QA CAL-23.v4, QA CAL-25.v3  
Calibration procedure for dosimetric E-field probes**

Calibration date: **April 18, 2011**

This calibration certificate documents the traceability to national standards, which realize the physical units of measurements (SI).  
The measurements and the uncertainties with confidence probability are given on the following pages and are part of the certificate.

All calibrations have been conducted in the closed laboratory facility: environment temperature (22 ± 3)°C and humidity < 70%.

Calibration Equipment used (M&TE critical for calibration)

✓  
KOK  
4/12/11

Primary Standards	ID	Cal Date (Certificate No.)	Scheduled Calibration
Power meter E4419B	GB41293874	31-Mar-11 (No. 217-01372)	Apr-12
Power sensor E4412A	MY41495277	31-Mar-11 (No. 217-01372)	Apr-12
Power sensor E4412A	MY41498087	31-Mar-11 (No. 217-01372)	Apr-12
Reference 3 dB Attenuator	SN: S5054 (3c)	29-Mar-11 (No. 217-01369)	Apr-12
Reference 20 dB Attenuator	SN: S5086 (20b)	29-Mar-11 (No. 217-01367)	Apr-12
Reference 30 dB Attenuator	SN: S5129 (30b)	29-Mar-11 (No. 217-01370)	Apr-12
Reference Probe ES3DV2	SN: 3013	29-Dec-10 (No. ES3-3013_Dec10)	Dec-11
DAE4	SN: 654	23-Apr-10 (No. DAE4-654_Apr10)	Apr-11
Secondary Standards	ID	Check Date (in house)	Scheduled Check
RF generator HP 8648C	US3642U01700	4-Aug-99 (in house check Oct-09)	In house check: Oct-11
Network Analyzer HP 8753E	US37390585	18-Oct-01 (in house check Oct-10)	In house check: Oct-11

	Name	Function	Signature
Calibrated by:	Jeton Kastrati	Laboratory Technician	
Approved by:	Katja Pokovic	Technical Manager	

Issued: April 18, 2011

This calibration certificate shall not be reproduced except in full without written approval of the laboratory.



Accredited by the Swiss Accreditation Service (SAS)

Accreditation No.: **SCS 108**

The Swiss Accreditation Service is one of the signatories to the EA  
Multilateral Agreement for the recognition of calibration certificates

### Glossary:

TSL	tissue simulating liquid
NORM <sub>x,y,z</sub>	sensitivity in free space
ConvF	sensitivity in TSL / NORM <sub>x,y,z</sub>
DCP	diode compression point
CF	crest factor (1/duty_cycle) of the RF signal
A, B, C	modulation dependent linearization parameters
Polarization $\varphi$	$\varphi$ rotation around probe axis
Polarization $\vartheta$	$\vartheta$ rotation around an axis that is in the plane normal to probe axis (at measurement center), i.e., $\vartheta = 0$ is normal to probe axis

### Calibration is Performed According to the Following Standards:

- IEEE Std 1528-2003, "IEEE Recommended Practice for Determining the Peak Spatial-Averaged Specific Absorption Rate (SAR) in the Human Head from Wireless Communications Devices: Measurement Techniques", December 2003
- IEC 62209-1, "Procedure to measure the Specific Absorption Rate (SAR) for hand-held devices used in close proximity to the ear (frequency range of 300 MHz to 3 GHz)", February 2005

### Methods Applied and Interpretation of Parameters:

- NORM<sub>x,y,z</sub>**: Assessed for E-field polarization  $\vartheta = 0$  ( $f \leq 900$  MHz in TEM-cell;  $f > 1800$  MHz: R22 waveguide). NORM<sub>x,y,z</sub> are only intermediate values, i.e., the uncertainties of NORM<sub>x,y,z</sub> does not affect the E<sup>2</sup>-field uncertainty inside TSL (see below *ConvF*).
- NORM(f)<sub>x,y,z</sub> = NORM<sub>x,y,z</sub> \* frequency\_response** (see Frequency Response Chart). This linearization is implemented in DASY4 software versions later than 4.2. The uncertainty of the frequency response is included in the stated uncertainty of *ConvF*.
- DCP<sub>x,y,z</sub>**: DCP are numerical linearization parameters assessed based on the data of power sweep with CW signal (no uncertainty required). DCP does not depend on frequency nor media.
- PAR**: PAR is the Peak to Average Ratio that is not calibrated but determined based on the signal characteristics
- A<sub>x,y,z</sub>; B<sub>x,y,z</sub>; C<sub>x,y,z</sub>** are numerical linearization parameters in dB assessed based on the data of power sweep for specific modulation signal. The parameters do not depend on frequency nor media.
- VR**: VR is the validity range of the calibration related to the average diode voltage or DAE voltage in mV.
- ConvF and Boundary Effect Parameters**: Assessed in flat phantom using E-field (or Temperature Transfer Standard for  $f \leq 800$  MHz) and inside waveguide using analytical field distributions based on power measurements for  $f > 800$  MHz. The same setups are used for assessment of the parameters applied for boundary compensation (alpha, depth) of which typical uncertainty values are given. These parameters are used in DASY4 software to improve probe accuracy close to the boundary. The sensitivity in TSL corresponds to NORM<sub>x,y,z</sub> \* ConvF whereby the uncertainty corresponds to that given for ConvF. A frequency dependent ConvF is used in DASY version 4.4 and higher which allows extending the validity from  $\pm 50$  MHz to  $\pm 100$  MHz.
- Spherical isotropy (3D deviation from isotropy)**: in a field of low gradients realized using a flat phantom exposed by a patch antenna.
- Sensor Offset**: The sensor offset corresponds to the offset of virtual measurement center from the probe tip (on probe axis). No tolerance required.

# Probe ES3DV3

## SN:3209

Manufactured: October 14, 2008  
Calibrated: April 18, 2011

Calibrated for DASY/EASY Systems  
(Note: non-compatible with DASY2 system!)

## DASY/EASY - Parameters of Probe: ES3DV3 - SN:3209

### Basic Calibration Parameters

	Sensor X	Sensor Y	Sensor Z	Unc (k=2)
Norm ( $\mu\text{V}/(\text{V}/\text{m})^2$ ) <sup>A</sup>	1.37	1.34	1.15	± 10.1 %
DCP (mV) <sup>B</sup>	97.0	100.4	100.0	

### Modulation Calibration Parameters

UID	Communication System Name	PAR		A dB	B dB	C dB	VR mV	Unc <sup>E</sup> (k=2)
10000	CW	0.00	X	0.00	0.00	1.00	116.0	±3.0 %
			Y	0.00	0.00	1.00	118.9	
			Z	0.00	0.00	1.00	103.8	

The reported uncertainty of measurement is stated as the standard uncertainty of measurement multiplied by the coverage factor k=2, which for a normal distribution corresponds to a coverage probability of approximately 95%.

<sup>A</sup> The uncertainties of NormX,Y,Z do not affect the E<sup>2</sup>-field uncertainty inside TSL (see Pages 5 and 6).

<sup>B</sup> Numerical linearization parameter: uncertainty not required.

<sup>E</sup> Uncertainty is determined using the max. deviation from linear response applying rectangular distribution and is expressed for the square of the field value.

## DASY/EASY - Parameters of Probe: ES3DV3 - SN:3209

### Calibration Parameter Determined in Head Tissue Simulating Media

f (MHz) <sup>C</sup>	Relative Permittivity <sup>F</sup>	Conductivity (S/m) <sup>F</sup>	ConvF X	ConvF Y	ConvF Z	Alpha	Depth (mm)	Unct. (k=2)
750	41.9	0.89	6.42	6.42	6.42	0.99	1.10	± 12.0 %
835	41.5	0.90	6.17	6.17	6.17	0.99	1.10	± 12.0 %
1750	40.1	1.37	5.33	5.33	5.33	0.99	1.12	± 12.0 %
1900	40.0	1.40	5.11	5.11	5.11	0.99	1.09	± 12.0 %
2450	39.2	1.80	4.52	4.52	4.52	0.84	1.21	± 12.0 %
2600	39.0	1.96	4.35	4.35	4.35	0.74	1.32	± 12.0 %

<sup>C</sup> Frequency validity of ± 100 MHz only applies for DASY v4.4 and higher (see Page 2), else it is restricted to ± 50 MHz. The uncertainty is the RSS of the ConvF uncertainty at calibration frequency and the uncertainty for the indicated frequency band.

<sup>F</sup> At frequencies below 3 GHz, the validity of tissue parameters ( $\epsilon$  and  $\sigma$ ) can be relaxed to ± 10% if liquid compensation formula is applied to measured SAR values. At frequencies above 3 GHz, the validity of tissue parameters ( $\epsilon$  and  $\sigma$ ) is restricted to ± 5%. The uncertainty is the RSS of the ConvF uncertainty for indicated target tissue parameters.

## DASY/EASY - Parameters of Probe: ES3DV3- SN:3209

### Calibration Parameter Determined in Body Tissue Simulating Media

f (MHz) <sup>C</sup>	Relative Permittivity <sup>F</sup>	Conductivity (S/m) <sup>F</sup>	ConvF X	ConvF Y	ConvF Z	Alpha	Depth (mm)	Unct. (k=2)
450	56.7	0.94	7.06	7.06	7.06	0.11	1.00	± 13.4 %
750	55.5	0.96	6.18	6.18	6.18	0.99	1.15	± 12.0 %
835	55.2	0.97	6.15	6.15	6.15	0.99	1.12	± 12.0 %
1640	53.8	1.40	5.18	5.18	5.18	0.89	1.25	± 12.0 %
1750	53.4	1.49	4.75	4.75	4.75	0.81	1.31	± 12.0 %
1900	53.3	1.52	4.48	4.48	4.48	0.95	1.19	± 12.0 %
2450	52.7	1.95	4.15	4.15	4.15	0.99	1.04	± 12.0 %
2600	52.5	2.16	4.00	4.00	4.00	0.88	1.15	± 12.0 %

<sup>C</sup> Frequency validity of ± 100 MHz only applies for DASY v4.4 and higher (see Page 2), else it is restricted to ± 50 MHz. The uncertainty is the RSS of the ConvF uncertainty at calibration frequency and the uncertainty for the indicated frequency band.

<sup>F</sup> At frequencies below 3 GHz, the validity of tissue parameters ( $\epsilon$  and  $\sigma$ ) can be relaxed to ± 10% if liquid compensation formula is applied to measured SAR values. At frequencies above 3 GHz, the validity of tissue parameters ( $\epsilon$  and  $\sigma$ ) is restricted to ± 5%. The uncertainty is the RSS of the ConvF uncertainty for indicated target tissue parameters.

# Frequency Response of E-Field

(TEM-Cell:ifi110 EXX, Waveguide: R22)

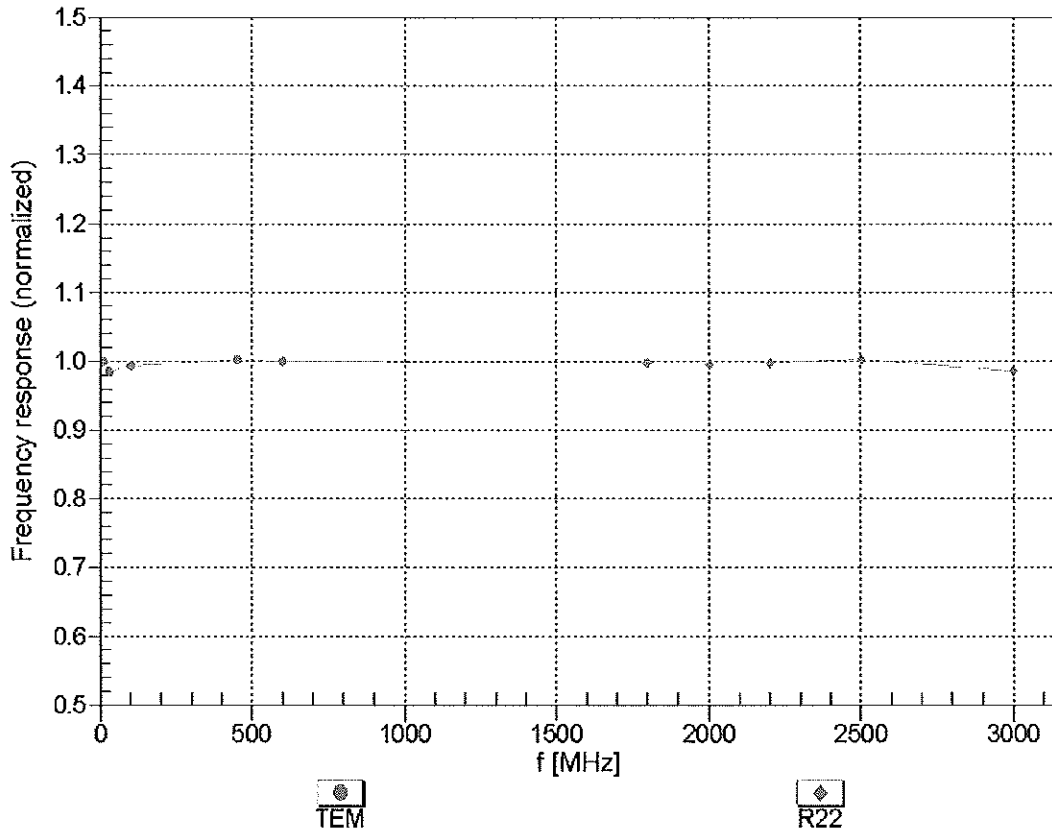

Uncertainty of Frequency Response of E-field:  $\pm 6.3\%$  (k=2)

## Receiving Pattern ( $\phi$ ), $\theta = 0^\circ$

f=600 MHz,TEM

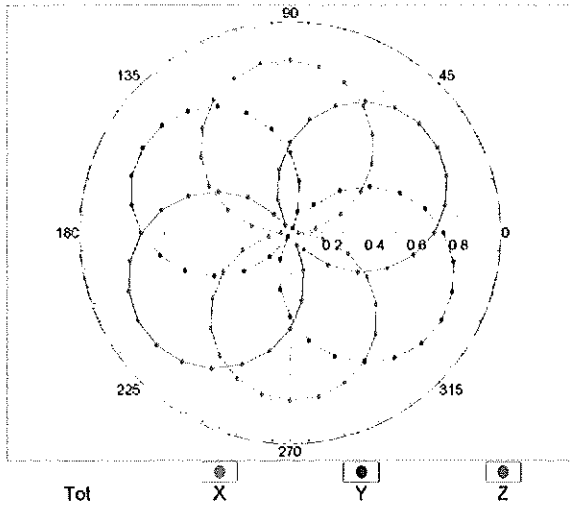

f=1800 MHz,R22

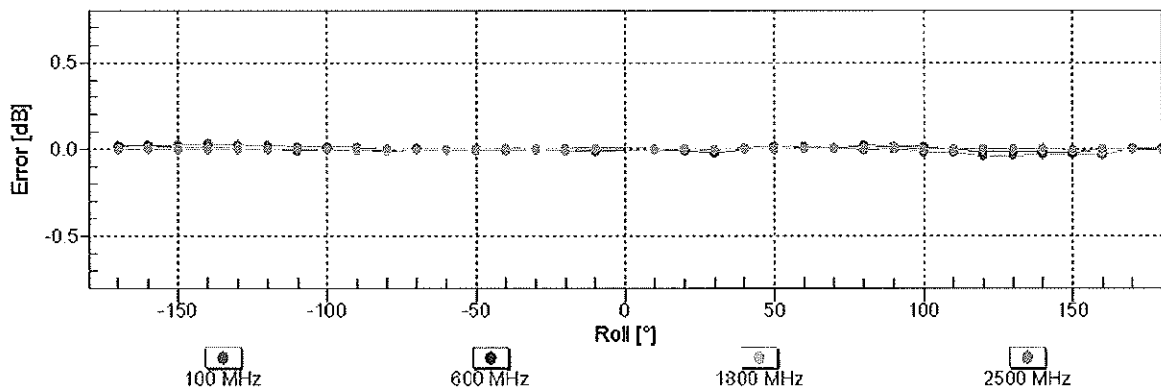
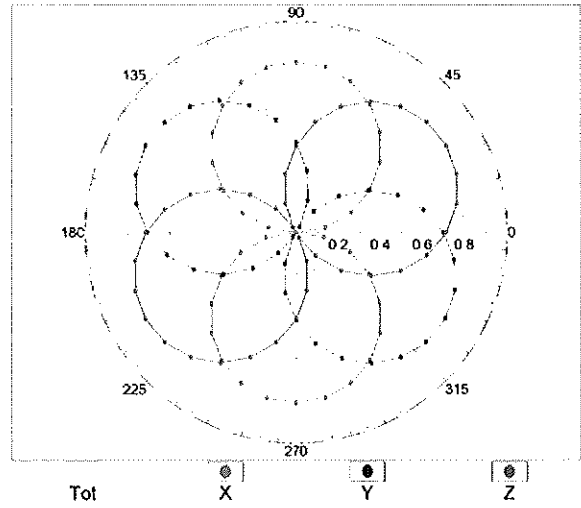

Uncertainty of Axial Isotropy Assessment:  $\pm 0.5\%$  (k=2)

## Dynamic Range f(SAR<sub>head</sub>) (TEM cell , f = 900 MHz)

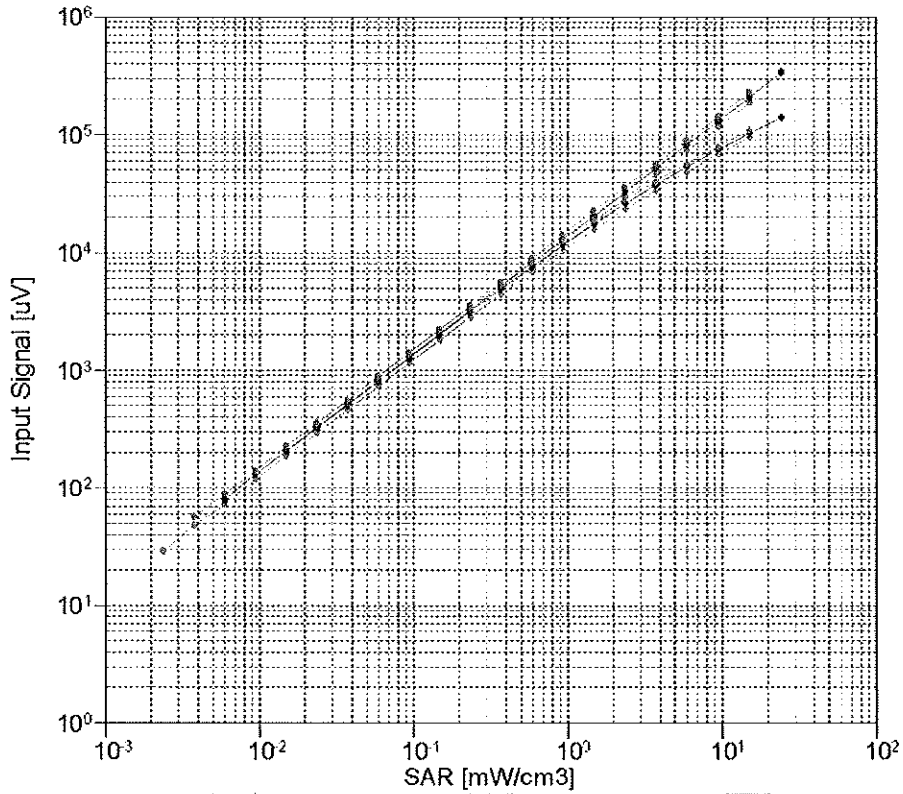

X compensated	X not compensated	Y compensated
Y not compensated	Z compensated	Z not compensated

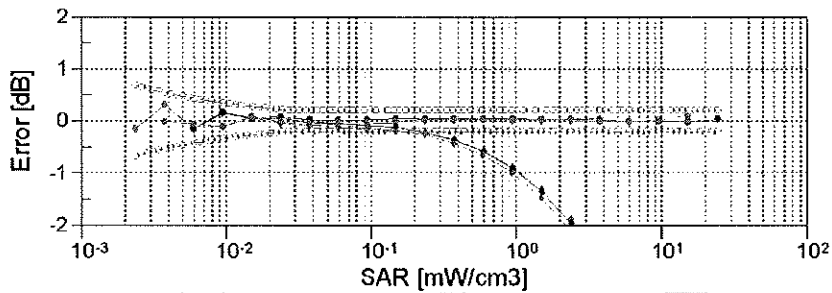

X compensated	X not compensated	Y compensated
Y not compensated	Z compensated	Z not compensated

**Uncertainty of Linearity Assessment: ± 0.6% (k=2)**

# Conversion Factor Assessment

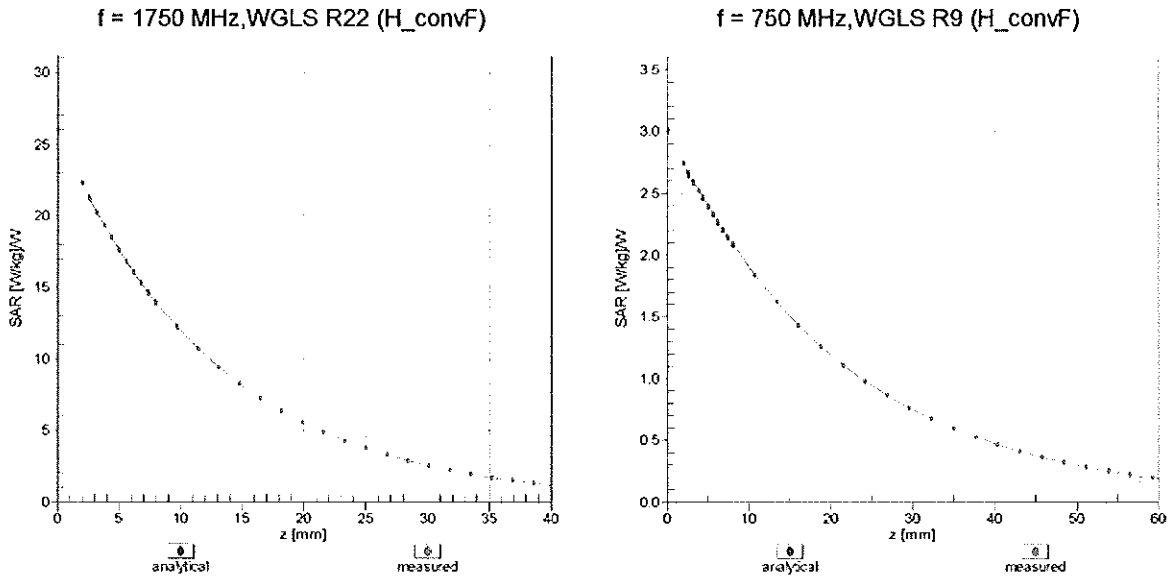

## Deviation from Isotropy in Liquid Error ( $\phi, \theta$ ), f = 900 MHz

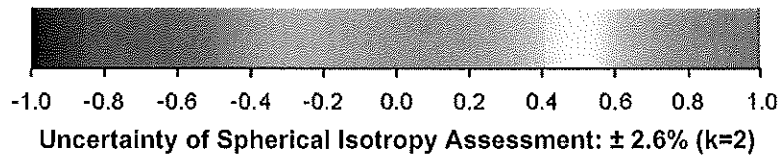
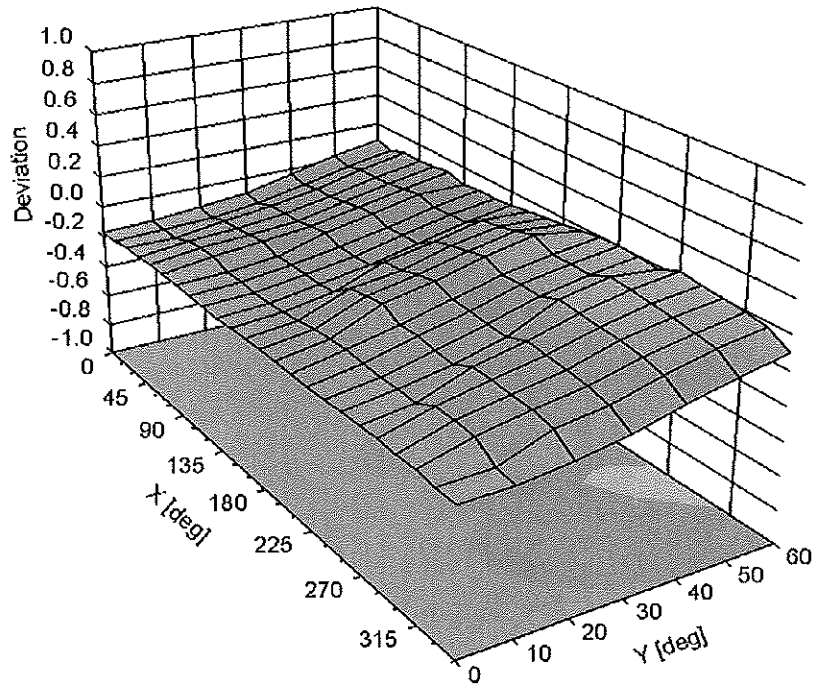

**DASY/EASY - Parameters of Probe: ES3DV3 - SN:3209****Other Probe Parameters**

Sensor Arrangement	Triangular
Connector Angle (°)	Not applicable
Mechanical Surface Detection Mode	enabled
Optical Surface Detection Mode	disabled
Probe Overall Length	337 mm
Probe Body Diameter	10 mm
Tip Length	10 mm
Tip Diameter	4 mm
Probe Tip to Sensor X Calibration Point	2 mm
Probe Tip to Sensor Y Calibration Point	2 mm
Probe Tip to Sensor Z Calibration Point	2 mm
Recommended Measurement Distance from Surface	3 mm

## **Additional Conversion Factors**

for Dosimetric E-Field Probe

Type:

**ES3DV3**

Serial Number:

**3209**

Place of Assessment:

**Zurich**

Date of Assessment:

**April 20, 2011**

Probe Calibration Date:

**April 18, 2011**

Schmid & Partner Engineering AG hereby certifies that conversion factor(s) of this probe have been evaluated on the date indicated above. The assessment was performed using the FDTD numerical code SEMCAD of Schmid & Partner Engineering AG. The evaluation is coupled with measured conversion factors (probe calibration date indicated above). The uncertainty of the numerical assessment is based on the extrapolation from measured value at 835 MHz or at 1750 MHz.

Assessed by:

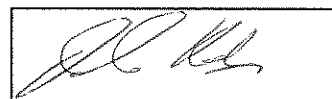

**Dosimetric E-Field Probe ES3DV3 SN:3209**Conversion factor ( $\pm$  standard deviation)

550 $\pm$ 50 MHz	<i>ConvF</i>	6.7 $\pm$ 7%	$\epsilon_r = 56.3 \pm 5\%$ $\sigma = 0.95 \pm 5\%$ mho/m (body tissue)
650 $\pm$ 50 MHz	<i>ConvF</i>	6.3 $\pm$ 7%	$\epsilon_r = 55.9 \pm 5\%$ $\sigma = 0.95 \pm 5\%$ mho/m (body tissue)

**Important Note:**

For numerically assessed probe conversion factors, parameters Alpha and Delta in the DASY software must have the following entries: Alpha = 0 and Delta = 1.

Please see also DASY Manual.



Accredited by the Swiss Accreditation Service (SAS)  
The Swiss Accreditation Service is one of the signatories to the EA  
Multilateral Agreement for the recognition of calibration certificates

Accreditation No.: SCS 108

Client **PC Test**

Certificate No: **ES3-3258\_Apr11**

**CALIBRATION CERTIFICATE**

Object **ES3DV3 - SN:3258**

Calibration procedure(s) **QA CAL-01.v7, QA CAL-23.v4, QA CAL-25.v3  
Calibration procedure for dosimetric E-field probes**

Calibration date: **April 8, 2011**

This calibration certificate documents the traceability to national standards, which realize the physical units of measurements (SI).  
The measurements and the uncertainties with confidence probability are given on the following pages and are part of the certificate.

All calibrations have been conducted in the closed laboratory facility: environment temperature (22 ± 3)°C and humidity < 70%.

Calibration Equipment used (M&TE critical for calibration)

*✓ KOK  
6/2/11*

Primary Standards	ID	Cal Date (Certificate No.)	Scheduled Calibration
Power meter E4419B	GB41293874	31-Mar-11 (No. 217-01372)	Apr-12
Power sensor E4412A	MY41495277	31-Mar-11 (No. 217-01372)	Apr-12
Power sensor E4412A	MY41498087	31-Mar-11 (No. 217-01372)	Apr-12
Reference 3 dB Attenuator	SN: S5054 (3c)	29-Mar-11 (No. 217-01369)	Apr-12
Reference 20 dB Attenuator	SN: S5086 (20b)	29-Mar-11 (No. 217-01367)	Apr-12
Reference 30 dB Attenuator	SN: S5129 (30b)	29-Mar-11 (No. 217-01370)	Apr-12
Reference Probe ES3DV2	SN: 3013	29-Dec-10 (No. ES3-3013_Dec10)	Dec-11
DAE4	SN: 654	23-Apr-10 (No. DAE4-654_Apr10)	Apr-11
Secondary Standards	ID	Check Date (in house)	Scheduled Check
RF generator HP 8648C	US3642U01700	4-Aug-99 (in house check Oct-09)	In house check: Oct-11
Network Analyzer HP 8753E	US37390585	18-Oct-01 (in house check Oct-10)	In house check: Oct-11

	Name	Function	Signature
Calibrated by:	Dimce Iliev	Laboratory Technician	<i>Dimce Iliev</i>
Approved by:	Kalja Pokovic	Technical Manager	<i>Kalja Pokovic</i>

Issued: April 13, 2011

This calibration certificate shall not be reproduced except in full without written approval of the laboratory.



Accredited by the Swiss Accreditation Service (SAS)

Accreditation No.: SCS 108

The Swiss Accreditation Service is one of the signatories to the EA  
Multilateral Agreement for the recognition of calibration certificates

### Glossary:

TSL	tissue simulating liquid
NORM <sub>x,y,z</sub>	sensitivity in free space
ConvF	sensitivity in TSL / NORM <sub>x,y,z</sub>
DCP	diode compression point
CF	crest factor (1/duty_cycle) of the RF signal
A, B, C	modulation dependent linearization parameters
Polarization $\varphi$	$\varphi$ rotation around probe axis
Polarization $\vartheta$	$\vartheta$ rotation around an axis that is in the plane normal to probe axis (at measurement center), i.e., $\vartheta = 0$ is normal to probe axis

### Calibration is Performed According to the Following Standards:

- IEEE Std 1528-2003, "IEEE Recommended Practice for Determining the Peak Spatial-Averaged Specific Absorption Rate (SAR) in the Human Head from Wireless Communications Devices: Measurement Techniques", December 2003
- IEC 62209-1, "Procedure to measure the Specific Absorption Rate (SAR) for hand-held devices used in close proximity to the ear (frequency range of 300 MHz to 3 GHz)", February 2005

### Methods Applied and Interpretation of Parameters:

- NORM<sub>x,y,z</sub>**: Assessed for E-field polarization  $\vartheta = 0$  ( $f \leq 900$  MHz in TEM-cell;  $f > 1800$  MHz: R22 waveguide). NORM<sub>x,y,z</sub> are only intermediate values, i.e., the uncertainties of NORM<sub>x,y,z</sub> does not affect the E<sup>2</sup>-field uncertainty inside TSL (see below ConvF).
- NORM(f)<sub>x,y,z</sub>** = NORM<sub>x,y,z</sub> \* frequency\_response (see Frequency Response Chart). This linearization is implemented in DASY4 software versions later than 4.2. The uncertainty of the frequency response is included in the stated uncertainty of ConvF.
- DCP<sub>x,y,z</sub>**: DCP are numerical linearization parameters assessed based on the data of power sweep with CW signal (no uncertainty required). DCP does not depend on frequency nor media.
- PAR**: PAR is the Peak to Average Ratio that is not calibrated but determined based on the signal characteristics
- A<sub>x,y,z</sub>; B<sub>x,y,z</sub>; C<sub>x,y,z</sub>** are numerical linearization parameters in dB assessed based on the data of power sweep for specific modulation signal. The parameters do not depend on frequency nor media.
- VR**: VR is the validity range of the calibration related to the average diode voltage or DAE voltage in mV.
- ConvF and Boundary Effect Parameters**: Assessed in flat phantom using E-field (or Temperature Transfer Standard for  $f \leq 800$  MHz) and inside waveguide using analytical field distributions based on power measurements for  $f > 800$  MHz. The same setups are used for assessment of the parameters applied for boundary compensation (alpha, depth) of which typical uncertainty values are given. These parameters are used in DASY4 software to improve probe accuracy close to the boundary. The sensitivity in TSL corresponds to NORM<sub>x,y,z</sub> \* ConvF whereby the uncertainty corresponds to that given for ConvF. A frequency dependent ConvF is used in DASY version 4.4 and higher which allows extending the validity from  $\pm 50$  MHz to  $\pm 100$  MHz.
- Spherical isotropy (3D deviation from isotropy)**: in a field of low gradients realized using a flat phantom exposed by a patch antenna.
- Sensor Offset**: The sensor offset corresponds to the offset of virtual measurement center from the probe tip (on probe axis). No tolerance required.

# Probe ES3DV3

## SN:3258

Manufactured: January 25, 2010  
Calibrated: April 8, 2011

Calibrated for DASY/EASY Systems  
(Note: non-compatible with DASY2 system!)

## DASY/EASY - Parameters of Probe: ES3DV3 - SN:3258

### Basic Calibration Parameters

	Sensor X	Sensor Y	Sensor Z	Unc (k=2)
Norm ( $\mu V/(V/m)^2$ ) <sup>A</sup>	1.31	1.19	1.25	$\pm 10.1 \%$
DCP (mV) <sup>B</sup>	98.3	103.8	99.8	

### Modulation Calibration Parameters

UID	Communication System Name	PAR		A dB	B dB	C dB	VR mV	Unc <sup>E</sup> (k=2)
10000	CW	0.00	X	0.00	0.00	1.00	115.1	$\pm 2.7 \%$
			Y	0.00	0.00	1.00	105.5	
			Z	0.00	0.00	1.00	113.5	

The reported uncertainty of measurement is stated as the standard uncertainty of measurement multiplied by the coverage factor k=2, which for a normal distribution corresponds to a coverage probability of approximately 95%.

<sup>A</sup> The uncertainties of NormX,Y,Z do not affect the E<sup>2</sup>-field uncertainty inside TSL (see Pages 5 and 6).

<sup>B</sup> Numerical linearization parameter: uncertainty not required.

<sup>E</sup> Uncertainty is determined using the max. deviation from linear response applying rectangular distribution and is expressed for the square of the field value.

## DASY/EASY - Parameters of Probe: ES3DV3 - SN:3258

### Calibration Parameter Determined in Head Tissue Simulating Media

f (MHz) <sup>C</sup>	Relative Permittivity <sup>F</sup>	Conductivity (S/m) <sup>F</sup>	ConvF X	ConvF Y	ConvF Z	Alpha	Depth (mm)	Unct. (k=2)
750	41.9	0.89	6.41	6.41	6.41	1.00	1.00	± 12.0 %
835	41.5	0.90	6.18	6.18	6.18	1.00	1.00	± 12.0 %
1750	40.1	1.37	5.32	5.32	5.32	0.99	1.16	± 12.0 %
1900	40.0	1.40	5.15	5.15	5.15	1.00	1.15	± 12.0 %
2450	39.2	1.80	4.50	4.50	4.50	0.87	1.26	± 12.0 %
2600	39.0	1.96	4.33	4.33	4.33	0.87	1.24	± 12.0 %

<sup>C</sup> Frequency validity of ± 100 MHz only applies for DASY v4.4 and higher (see Page 2), else it is restricted to ± 50 MHz. The uncertainty is the RSS of the ConvF uncertainty at calibration frequency and the uncertainty for the indicated frequency band.

<sup>F</sup> At frequencies below 3 GHz, the validity of tissue parameters ( $\epsilon$  and  $\sigma$ ) can be relaxed to ± 10% if liquid compensation formula is applied to measured SAR values. At frequencies above 3 GHz, the validity of tissue parameters ( $\epsilon$  and  $\sigma$ ) is restricted to ± 5%. The uncertainty is the RSS of the ConvF uncertainty for indicated target tissue parameters.

## DASY/EASY - Parameters of Probe: ES3DV3- SN:3258

### Calibration Parameter Determined in Body Tissue Simulating Media

f (MHz) <sup>C</sup>	Relative Permittivity <sup>F</sup>	Conductivity (S/m) <sup>F</sup>	ConvF X	ConvF Y	ConvF Z	Alpha	Depth (mm)	Unct. (k=2)
750	55.5	0.96	6.16	6.16	6.16	1.00	1.00	± 12.0 %
835	55.2	0.97	6.12	6.12	6.12	1.00	1.00	± 12.0 %
1750	53.4	1.49	5.00	5.00	5.00	0.91	1.28	± 12.0 %
1900	53.3	1.52	4.75	4.75	4.75	0.90	1.23	± 12.0 %
2450	52.7	1.95	4.34	4.34	4.34	1.00	1.00	± 12.0 %
2600	52.5	2.16	4.16	4.16	4.16	0.94	1.15	± 12.0 %

<sup>C</sup> Frequency validity of ± 100 MHz only applies for DASY v4.4 and higher (see Page 2), else it is restricted to ± 50 MHz. The uncertainty is the RSS of the ConvF uncertainty at calibration frequency and the uncertainty for the indicated frequency band.

<sup>F</sup> At frequencies below 3 GHz, the validity of tissue parameters ( $\epsilon$  and  $\sigma$ ) can be relaxed to ± 10% if liquid compensation formula is applied to measured SAR values. At frequencies above 3 GHz, the validity of tissue parameters ( $\epsilon$  and  $\sigma$ ) is restricted to ± 5%. The uncertainty is the RSS of the ConvF uncertainty for indicated target tissue parameters.

# Frequency Response of E-Field

(TEM-Cell:ifi1110 EXX, Waveguide: R22)

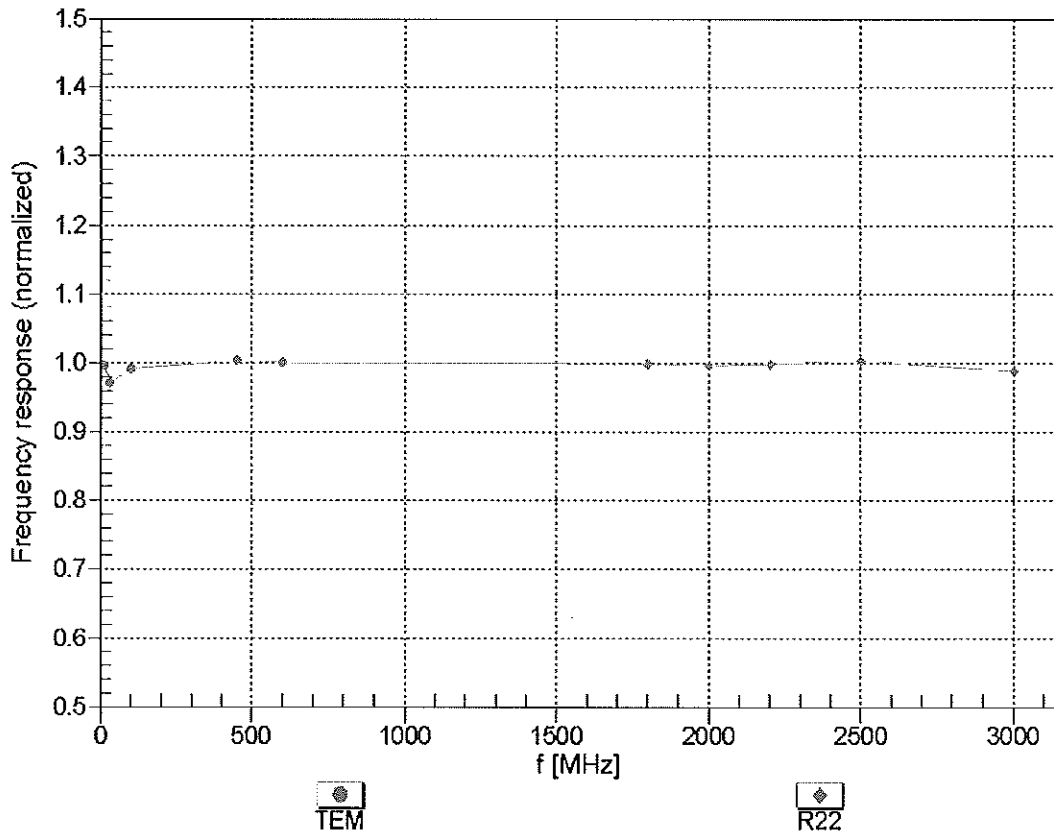

Uncertainty of Frequency Response of E-field:  $\pm 6.3\%$  (k=2)

### Receiving Pattern ( $\phi$ ), $\theta = 0^\circ$

f=600 MHz,TEM

f=1800 MHz,R22

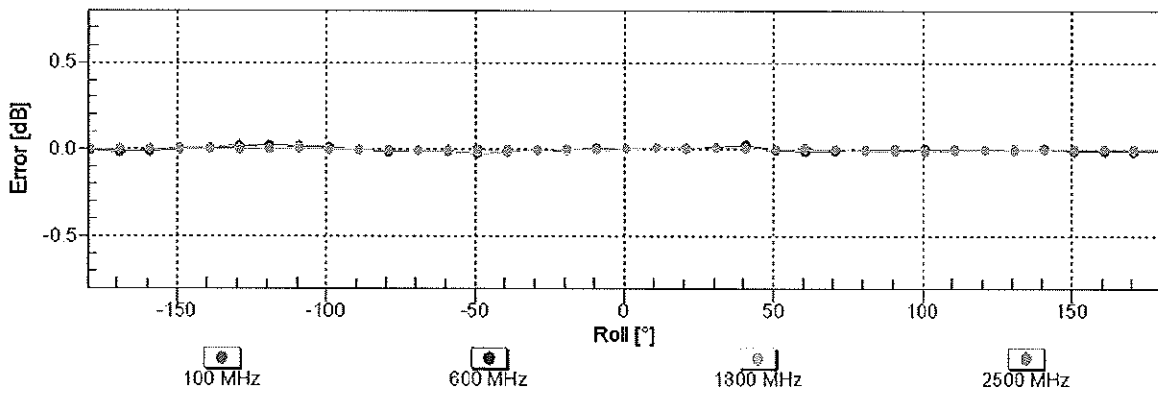
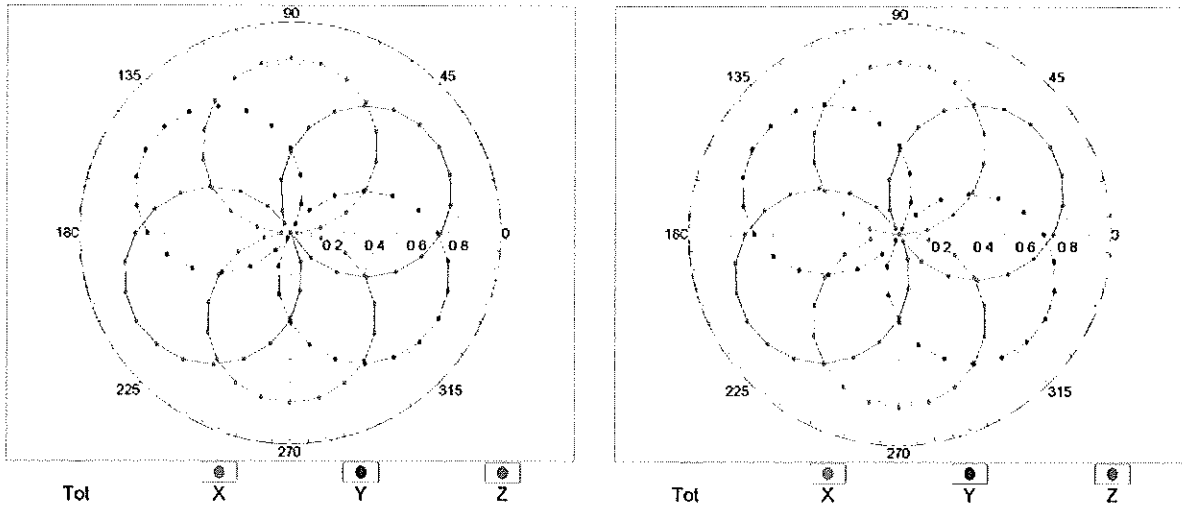

Uncertainty of Axial Isotropy Assessment:  $\pm 0.5\%$  (k=2)

## Dynamic Range $f(\text{SAR}_{\text{head}})$ (TEM cell , $f = 900 \text{ MHz}$ )

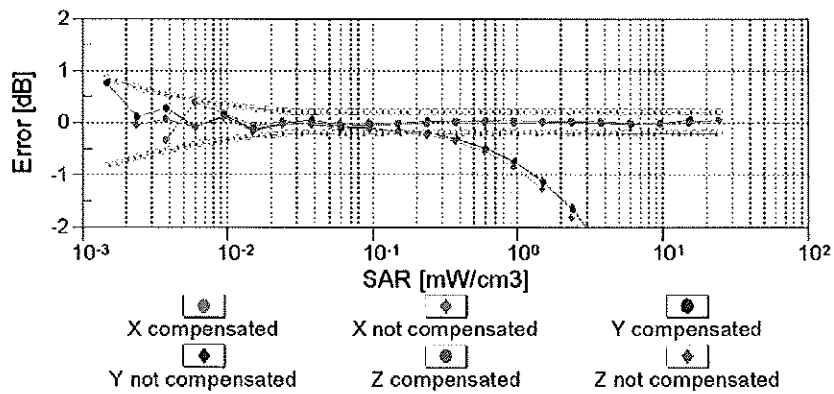
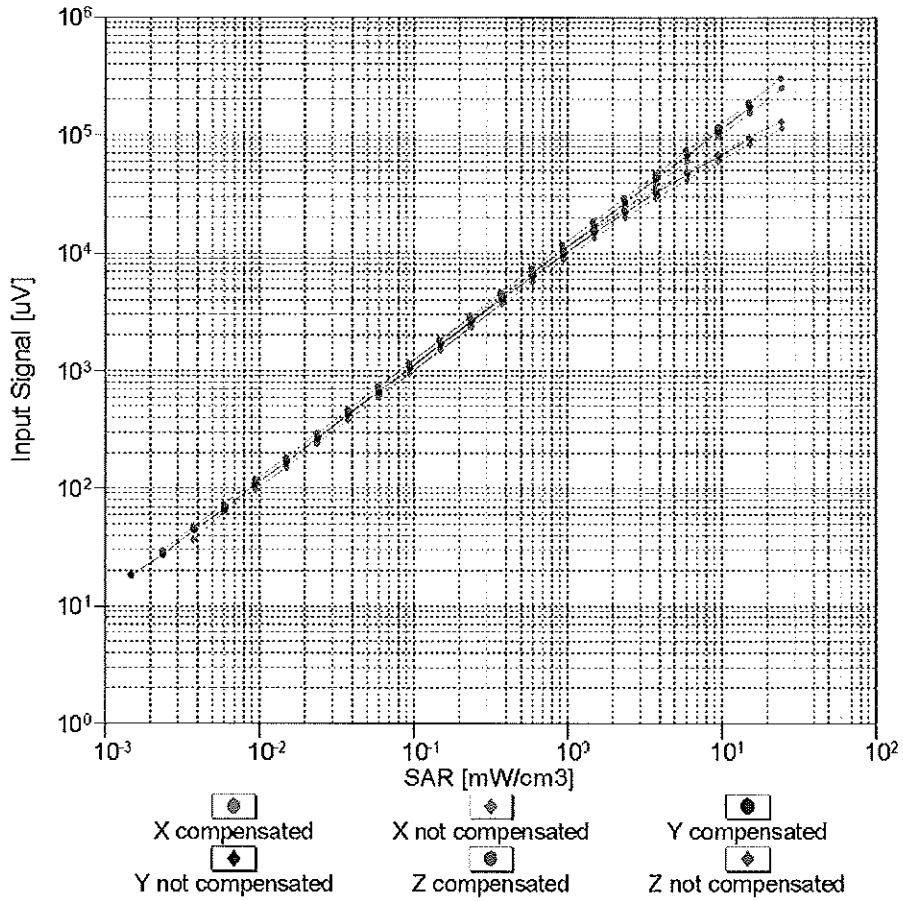

**Uncertainty of Linearity Assessment:  $\pm 0.6\%$  ( $k=2$ )**

# Conversion Factor Assessment

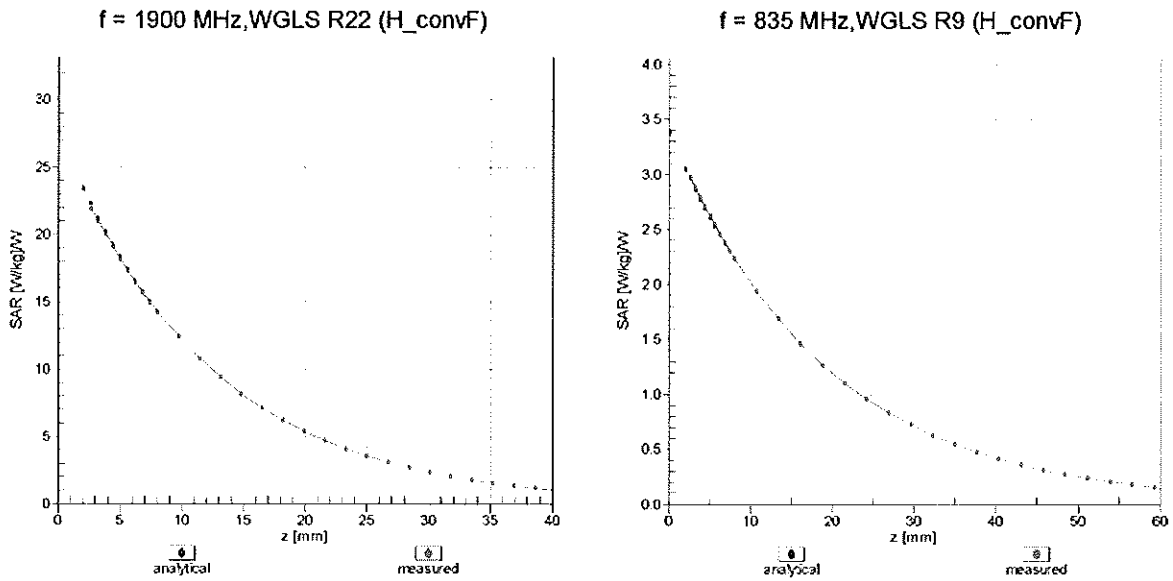

## Deviation from Isotropy in Liquid Error ( $\phi$ , $\theta$ ), f = 900 MHz

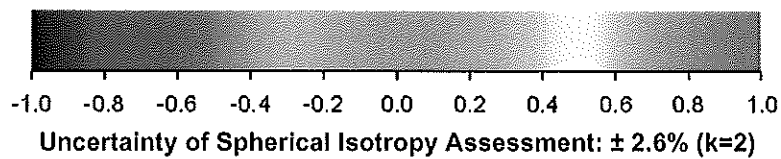
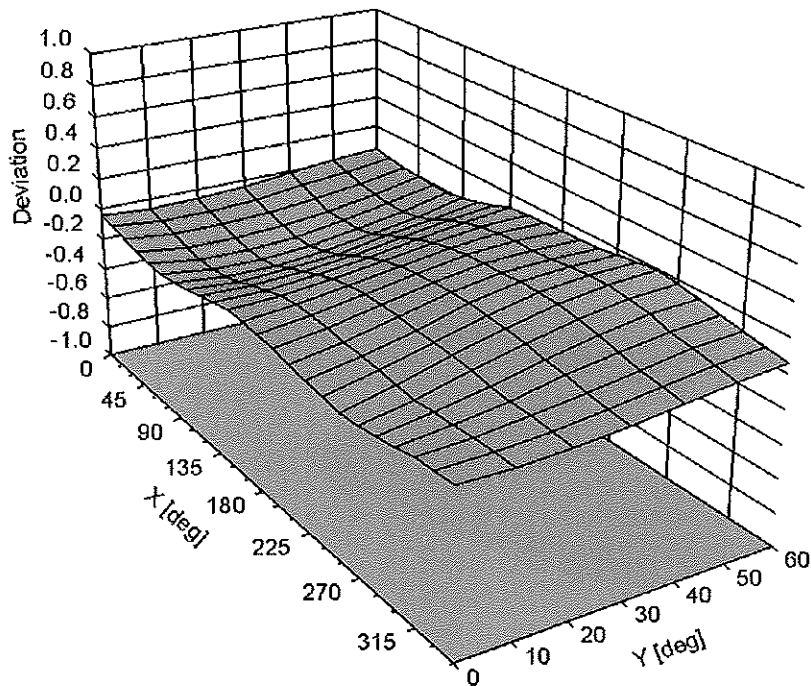

## DASY/EASY - Parameters of Probe: ES3DV3 - SN:3258

### Other Probe Parameters

Sensor Arrangement	Triangular
Connector Angle (°)	Not applicable
Mechanical Surface Detection Mode	enabled
Optical Surface Detection Mode	disabled
Probe Overall Length	337 mm
Probe Body Diameter	10 mm
Tip Length	10 mm
Tip Diameter	4 mm
Probe Tip to Sensor X Calibration Point	2 mm
Probe Tip to Sensor Y Calibration Point	2 mm
Probe Tip to Sensor Z Calibration Point	2 mm
Recommended Measurement Distance from Surface	3 mm



Accredited by the Swiss Accreditation Service (SAS)  
The Swiss Accreditation Service is one of the signatories to the EA  
Multilateral Agreement for the recognition of calibration certificates

Accreditation No.: **SCS 108**

Client **PC Test**

Certificate No: **D835V2-4d047\_Feb11**

**CALIBRATION CERTIFICATE**

Object **D835V2 - SN: 4d047**

Calibration procedure(s) **QA CAL-05.v8  
Calibration procedure for dipole validation kits**

Calibration date: **February 09, 2011**

✓  
2/24/11  
KOK

This calibration certificate documents the traceability to national standards, which realize the physical units of measurements (SI).  
The measurements and the uncertainties with confidence probability are given on the following pages and are part of the certificate.

All calibrations have been conducted in the closed laboratory facility: environment temperature (22 ± 3)°C and humidity < 70%.

Calibration Equipment used (M&TE critical for calibration)

Primary Standards	ID #	Cal Date (Certificate No.)	Scheduled Calibration
Power meter EPM-442A	GB37480704	06-Oct-10 (No. 217-01266)	Oct-11
Power sensor HP 8481A	US37292783	06-Oct-10 (No. 217-01266)	Oct-11
Reference 20 dB Attenuator	SN: 5086 (20g)	30-Mar-10 (No. 217-01158)	Mar-11
Type-N mismatch combination	SN: 5047.2 / 06327	30-Mar-10 (No. 217-01162)	Mar-11
Reference Probe ES3DV3	SN: 3205	30-Apr-10 (No. ES3-3205_Apr10)	Apr-11
DAE4	SN: 601	10-Jun-10 (No. DAE4-601_Jun10)	Jun-11
Secondary Standards	ID #	Check Date (in house)	Scheduled Check
Power sensor HP 8481A	MY41092317	18-Oct-02 (in house check Oct-09)	In house check: Oct-11
RF generator R&S SMT-06	100005	4-Aug-99 (in house check Oct-09)	In house check: Oct-11
Network Analyzer HP 8753E	US37390585 S4206	18-Oct-01 (in house check Oct-10)	In house check: Oct-11

Calibrated by: **Dimce Iliev**      **Function: Laboratory Technician**      **Signature: [Signature]**

Approved by: **Katja Pokovic**      **Technical Manager**      **Signature: [Signature]**

Issued: February 9, 2011

This calibration certificate shall not be reproduced except in full without written approval of the laboratory.



Accredited by the Swiss Accreditation Service (SAS)  
The Swiss Accreditation Service is one of the signatories to the EA  
Multilateral Agreement for the recognition of calibration certificates

Accreditation No.: **SCS 108**

**Glossary:**

TSL	tissue simulating liquid
ConvF	sensitivity in TSL / NORM x,y,z
N/A	not applicable or not measured

**Calibration is Performed According to the Following Standards:**

- IEEE Std 1528-2003, "IEEE Recommended Practice for Determining the Peak Spatial-Averaged Specific Absorption Rate (SAR) in the Human Head from Wireless Communications Devices: Measurement Techniques", December 2003
- IEC 62209-1, "Procedure to measure the Specific Absorption Rate (SAR) for hand-held devices used in close proximity to the ear (frequency range of 300 MHz to 3 GHz)", February 2005
- Federal Communications Commission Office of Engineering & Technology (FCC OET), "Evaluating Compliance with FCC Guidelines for Human Exposure to Radiofrequency Electromagnetic Fields; Additional Information for Evaluating Compliance of Mobile and Portable Devices with FCC Limits for Human Exposure to Radiofrequency Emissions", Supplement C (Edition 01-01) to Bulletin 65

**Additional Documentation:**

- DASY4/5 System Handbook

**Methods Applied and Interpretation of Parameters:**

- Measurement Conditions:** Further details are available from the Validation Report at the end of the certificate. All figures stated in the certificate are valid at the frequency indicated.
- Antenna Parameters with TSL:** The dipole is mounted with the spacer to position its feed point exactly below the center marking of the flat phantom section, with the arms oriented parallel to the body axis.
- Feed Point Impedance and Return Loss:** These parameters are measured with the dipole positioned under the liquid filled phantom. The impedance stated is transformed from the measurement at the SMA connector to the feed point. The Return Loss ensures low reflected power. No uncertainty required.
- Electrical Delay:** One-way delay between the SMA connector and the antenna feed point. No uncertainty required.
- SAR measured:** SAR measured at the stated antenna input power.
- SAR normalized:** SAR as measured, normalized to an input power of 1 W at the antenna connector.
- SAR for nominal TSL parameters:** The measured TSL parameters are used to calculate the nominal SAR result.

## Measurement Conditions

DASY system configuration, as far as not given on page 1.

<b>DASY Version</b>	DASY5	V52.6
<b>Extrapolation</b>	Advanced Extrapolation	
<b>Phantom</b>	Modular Flat Phantom V4.9	
<b>Distance Dipole Center - TSL</b>	15 mm	with Spacer
<b>Zoom Scan Resolution</b>	dx, dy, dz = 5 mm	
<b>Frequency</b>	835 MHz $\pm$ 1 MHz	

## Head TSL parameters

The following parameters and calculations were applied.

	Temperature	Permittivity	Conductivity
<b>Nominal Head TSL parameters</b>	22.0 °C	41.5	0.90 mho/m
<b>Measured Head TSL parameters</b>	(22.0 $\pm$ 0.2) °C	41.1 $\pm$ 6 %	0.89 mho/m $\pm$ 6 %
<b>Head TSL temperature during test</b>	(21.8 $\pm$ 0.2) °C	----	----

## SAR result with Head TSL

<b>SAR averaged over 1 cm<sup>3</sup> (1 g) of Head TSL</b>	Condition	
SAR measured	250 mW input power	2.37 mW / g
SAR normalized	normalized to 1W	9.48 mW / g
SAR for nominal Head TSL parameters	normalized to 1W	<b>9.53 mW / g <math>\pm</math> 17.0 % (k=2)</b>

<b>SAR averaged over 10 cm<sup>3</sup> (10 g) of Head TSL</b>	condition	
SAR measured	250 mW input power	1.54 mW / g
SAR normalized	normalized to 1W	6.16 mW / g
SAR for nominal Head TSL parameters	normalized to 1W	<b>6.19 mW / g <math>\pm</math> 16.5 % (k=2)</b>

## Body TSL parameters

The following parameters and calculations were applied.

	Temperature	Permittivity	Conductivity
Nominal Body TSL parameters	22.0 °C	55.2	0.97 mho/m
Measured Body TSL parameters	(22.0 ± 0.2) °C	54.2 ± 6 %	0.99 mho/m ± 6 %
Body TSL temperature during test	(22.0 ± 0.2) °C	----	----

## SAR result with Body TSL

SAR averaged over 1 cm <sup>3</sup> (1 g) of Body TSL	Condition	
SAR measured	250 mW input power	2.51 mW / g
SAR normalized	normalized to 1W	10.0 mW / g
SAR for nominal Body TSL parameters	normalized to 1W	<b>9.85 mW / g ± 17.0 % (k=2)</b>

SAR averaged over 10 cm <sup>3</sup> (10 g) of Body TSL	condition	
SAR measured	250 mW input power	1.64 mW / g
SAR normalized	normalized to 1W	6.56 mW / g
SAR for nominal Body TSL parameters	normalized to 1W	<b>6.47 mW / g ± 16.5 % (k=2)</b>

## Appendix

### Antenna Parameters with Head TSL

Impedance, transformed to feed point	50.1 $\Omega$ - 6.2 j $\Omega$
Return Loss	- 24.2 dB

### Antenna Parameters with Body TSL

Impedance, transformed to feed point	45.9 $\Omega$ - 8.2 j $\Omega$
Return Loss	- 20.4 dB

### General Antenna Parameters and Design

Electrical Delay (one direction)	1.387 ns
----------------------------------	----------

After long term use with 100W radiated power, only a slight warming of the dipole near the feedpoint can be measured.

The dipole is made of standard semirigid coaxial cable. The center conductor of the feeding line is directly connected to the second arm of the dipole. The antenna is therefore short-circuited for DC-signals.

No excessive force must be applied to the dipole arms, because they might bend or the soldered connections near the feedpoint may be damaged.

### Additional EUT Data

Manufactured by	SPEAG
Manufactured on	August 16, 2006

# DASY5 Validation Report for Head TSL

Date/Time: 09.02.2011 10:54:37

Test Laboratory: SPEAG, Zurich, Switzerland

**DUT: Dipole 835 MHz; Type: D835V2; Serial: D835V2 - SN:4d047**

Communication System: CW; Frequency: 835 MHz; Duty Cycle: 1:1

Medium: HSL900

Medium parameters used:  $f = 835 \text{ MHz}$ ;  $\sigma = 0.89 \text{ mho/m}$ ;  $\epsilon_r = 41$ ;  $\rho = 1000 \text{ kg/m}^3$

Phantom section: Flat Section

Measurement Standard: DASY5 (IEEE/IEC/ANSI C63.19-2007)

DASY5 Configuration:

- Probe: ES3DV3 - SN3205; ConvF(6.03, 6.03, 6.03); Calibrated: 30.04.2010
- Sensor-Surface: 3mm (Mechanical Surface Detection)
- Electronics: DAE4 Sn601; Calibrated: 10.06.2010
- Phantom: Flat Phantom 4.9L; Type: QD000P49AA; Serial: 1001
- Measurement SW: DASY52, V52.6.1 Build (408)
- Postprocessing SW: SEMCAD X, V14.4.2 Build (2595)

**Pin=250 mW /d=15mm, dist=3.0mm (ES-Probe)/Zoom Scan (7x7x7) /Cube 0: Measurement grid: dx=5mm, dy=5mm, dz=5mm**

Reference Value = 57.212 V/m; Power Drift = 0.02 dB

Peak SAR (extrapolated) = 3.567 W/kg

**SAR(1 g) = 2.37 mW/g; SAR(10 g) = 1.54 mW/g**

Maximum value of SAR (measured) = 2.763 mW/g

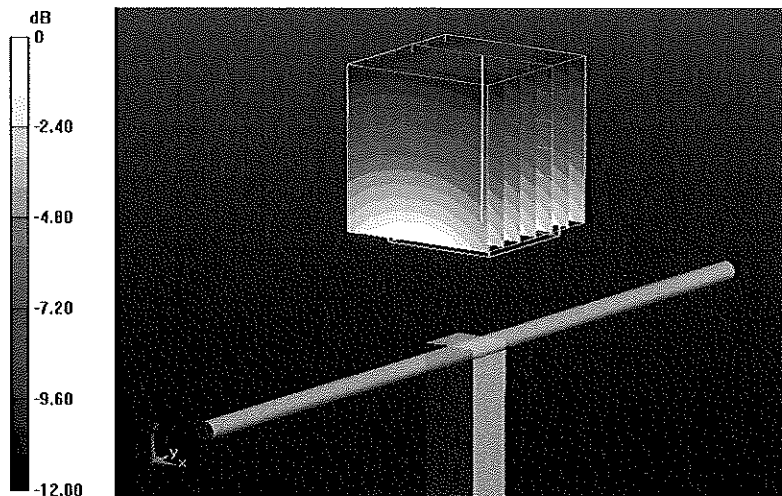

0 dB = 2.760mW/g

# Impedance Measurement Plot for Head TSL

9 Feb 2011 10:16:52

[CH1] S11 1 U FS 1: 50.000  $\Omega$  -6.1836  $\Omega$  30.824 pF 835.000 000 MHz

\*  
De1

Cor

Avg  
16

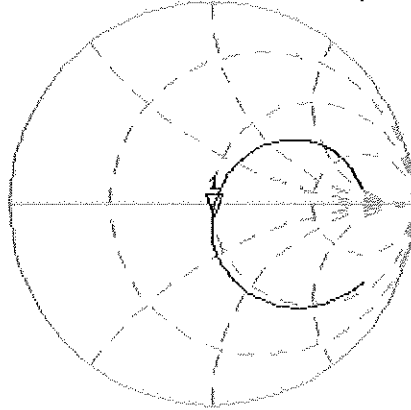

CH2 S11 LOG 5 dB/REF -20 dB 1: -24.208 dB 835.000 000 MHz

Cor

Avg  
16

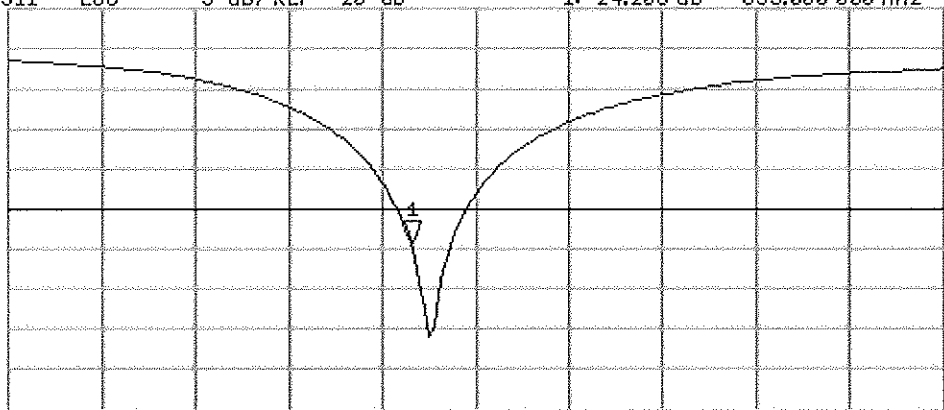

START 635.000 000 MHz

STOP 1 100.000 000 MHz

## DASY5 Validation Report for Body TSL

Date/Time: 09.02.2011 13:56:30

Test Laboratory: SPEAG, Zurich, Switzerland

**DUT: Dipole 835 MHz; Type: D835V2; Serial: D835V2 - SN:4d047**

Communication System: CW; Frequency: 835 MHz; Duty Cycle: 1:1

Medium: MSL900

Medium parameters used:  $f = 835$  MHz;  $\sigma = 0.99$  mho/m;  $\epsilon_r = 54.2$ ;  $\rho = 1000$  kg/m<sup>3</sup>

Phantom section: Flat Section

Measurement Standard: DASY5 (IEEE/IEC/ANSI C63.19-2007)

DASY5 Configuration:

- Probe: ES3DV3 - SN3205; ConvF(5.86, 5.86, 5.86); Calibrated: 30.04.2010
- Sensor-Surface: 3mm (Mechanical Surface Detection)
- Electronics: DAE4 Sn601; Calibrated: 10.06.2010
- Phantom: Flat Phantom 4.9L; Type: QD000P49AA; Serial: 1001
- Measurement SW: DASY52, V52.6.1 Build (408)
- Postprocessing SW: SEMCAD X, V14.4.2 Build (2595)

**Pin=250 mW /d=15mm, dist=3.0mm (ES-Probe)/Zoom Scan (7x7x7) /Cube 0: Measurement grid: dx=5mm, dy=5mm, dz=5mm**

Reference Value = 56.092 V/m; Power Drift = 0.02 dB

Peak SAR (extrapolated) = 3.714 W/kg

**SAR(1 g) = 2.51 mW/g; SAR(10 g) = 1.64 mW/g**

Maximum value of SAR (measured) = 2.921 mW/g

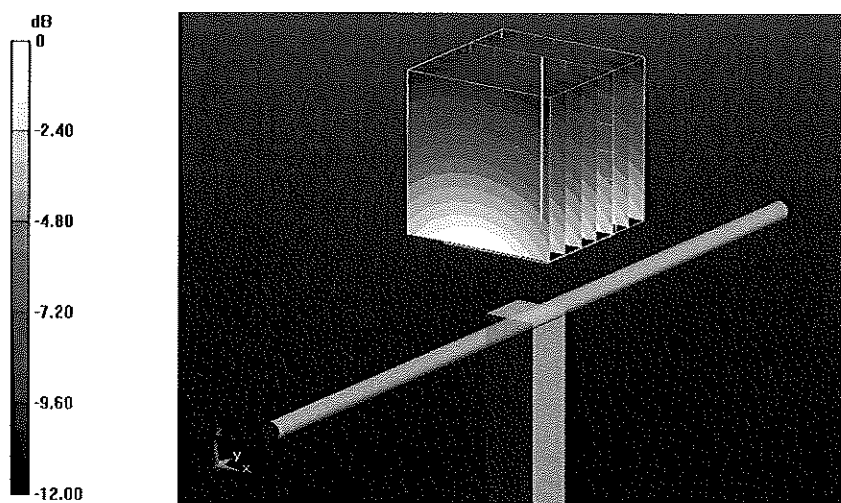

0 dB = 2.920mW/g

# Impedance Measurement Plot for Body TSL

9 Feb 2011 14:20:21

CH1 S11 1 U FS 1: 45.922  $\Omega$  -8.2461  $\Omega$  23.115  $\mu$ F 835.000 000 MHz

\*  
Del  
Cor

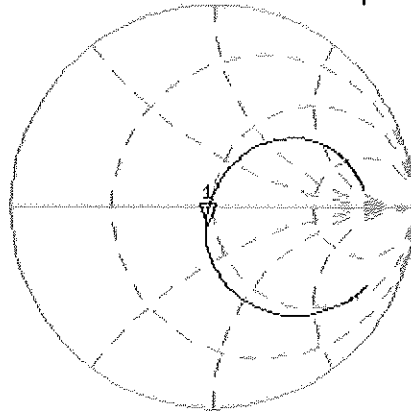

Avg  
16

↑

CH2 S11 LOG 5 dB/REF -20 dB 1: -20.397 dB 835.000 000 MHz

Cor

Avg  
16

↑

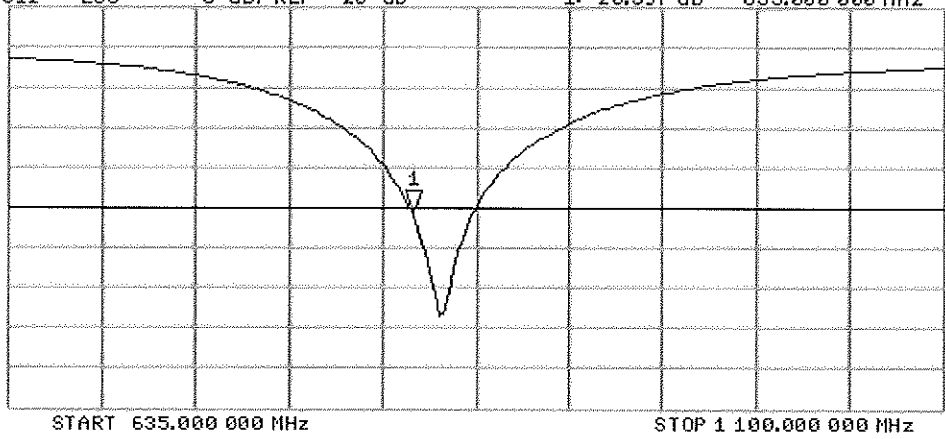



Accredited by the Swiss Accreditation Service (SAS)

Accreditation No.: **SCS 108**

The Swiss Accreditation Service is one of the signatories to the EA  
Multilateral Agreement for the recognition of calibration certificates

Client **PC Test**

Certificate No: **D1900V2-5d080\_Jul11**

## CALIBRATION CERTIFICATE

Object **D1900V2 - SN: 5d080**

Calibration procedure(s) **QA CAL-05.v8  
Calibration procedure for dipole validation kits above 700 MHz**

Calibration date: **July 22, 2011**

✓ KOK  
9/6/11

This calibration certificate documents the traceability to national standards, which realize the physical units of measurements (SI).  
The measurements and the uncertainties with confidence probability are given on the following pages and are part of the certificate.

All calibrations have been conducted in the closed laboratory facility: environment temperature (22 ± 3)°C and humidity < 70%.

Calibration Equipment used (M&TE critical for calibration)

Primary Standards	ID #	Cal Date (Certificate No.)	Scheduled Calibration
Power meter EPM-442A	GB37480704	06-Oct-10 (No. 217-01266)	Oct-11
Power sensor HP 8481A	US37292783	06-Oct-10 (No. 217-01266)	Oct-11
Reference 20 dB Attenuator	SN: S5086 (20b)	29-Mar-11 (No. 217-01367)	Apr-12
Type-N mismatch combination	SN: 5047.2 / 06327	29-Mar-11 (No. 217-01371)	Apr-12
Reference Probe ES3DV3	SN: 3205	29-Apr-11 (No. ES3-3205_Apr11)	Apr-12
DAE4	SN: 601	04-Jul-11 (No. DAE4-601_Jul11)	Jul-12
Secondary Standards	ID #	Check Date (in house)	Scheduled Check
Power sensor HP 8481A	MY41092317	18-Oct-02 (in house check Oct-09)	In house check: Oct-11
RF generator R&S SMT-06	100005	04-Aug-99 (in house check Oct-09)	In house check: Oct-11
Network Analyzer HP 8753E	US37390585 S4206	18-Oct-01 (in house check Oct-10)	In house check: Oct-11

Calibrated by: **Dimce Iliev**      **Dimce Iliev**      **Laboratory Technician**      *D. Iliev*

Approved by: **Katja Pokovic**      **Katja Pokovic**      **Technical Manager**      *K. Pokovic*

Issued: July 22, 2011

This calibration certificate shall not be reproduced except in full without written approval of the laboratory.



The Swiss Accreditation Service is one of the signatories to the EA  
Multilateral Agreement for the recognition of calibration certificates

**Glossary:**

TSL	tissue simulating liquid
ConvF	sensitivity in TSL / NORM x,y,z
N/A	not applicable or not measured

**Calibration is Performed According to the Following Standards:**

- a) IEEE Std 1528-2003, "IEEE Recommended Practice for Determining the Peak Spatial-Averaged Specific Absorption Rate (SAR) in the Human Head from Wireless Communications Devices: Measurement Techniques", December 2003
- b) IEC 62209-1, "Procedure to measure the Specific Absorption Rate (SAR) for hand-held devices used in close proximity to the ear (frequency range of 300 MHz to 3 GHz)", February 2005
- c) Federal Communications Commission Office of Engineering & Technology (FCC OET), "Evaluating Compliance with FCC Guidelines for Human Exposure to Radiofrequency Electromagnetic Fields; Additional Information for Evaluating Compliance of Mobile and Portable Devices with FCC Limits for Human Exposure to Radiofrequency Emissions", Supplement C (Edition 01-01) to Bulletin 65

**Additional Documentation:**

- d) DASY4/5 System Handbook

**Methods Applied and Interpretation of Parameters:**

- *Measurement Conditions:* Further details are available from the Validation Report at the end of the certificate. All figures stated in the certificate are valid at the frequency indicated.
- *Antenna Parameters with TSL:* The dipole is mounted with the spacer to position its feed point exactly below the center marking of the flat phantom section, with the arms oriented parallel to the body axis.
- *Feed Point Impedance and Return Loss:* These parameters are measured with the dipole positioned under the liquid filled phantom. The impedance stated is transformed from the measurement at the SMA connector to the feed point. The Return Loss ensures low reflected power. No uncertainty required.
- *Electrical Delay:* One-way delay between the SMA connector and the antenna feed point. No uncertainty required.
- *SAR measured:* SAR measured at the stated antenna input power.
- *SAR normalized:* SAR as measured, normalized to an input power of 1 W at the antenna connector.
- *SAR for nominal TSL parameters:* The measured TSL parameters are used to calculate the nominal SAR result.

## Measurement Conditions

DASY system configuration, as far as not given on page 1.

DASY Version	DASY5	V52.6.2
Extrapolation	Advanced Extrapolation	
Phantom	Modular Flat Phantom	
Distance Dipole Center - TSL	10 mm	with Spacer
Zoom Scan Resolution	dx, dy, dz = 5 mm	
Frequency	1900 MHz $\pm$ 1 MHz	

## Head TSL parameters

The following parameters and calculations were applied.

	Temperature	Permittivity	Conductivity
Nominal Head TSL parameters	22.0 °C	40.0	1.40 mho/m
Measured Head TSL parameters	(22.0 $\pm$ 0.2) °C	39.1 $\pm$ 6 %	1.42 mho/m $\pm$ 6 %
Head TSL temperature change during test	< 0.5 °C	----	----

## SAR result with Head TSL

SAR averaged over 1 cm <sup>3</sup> (1 g) of Head TSL	Condition	
SAR measured	250 mW input power	10.1 mW / g
SAR for nominal Head TSL parameters	normalized to 1W	39.9 mW / g $\pm$ 17.0 % (k=2)

SAR averaged over 10 cm <sup>3</sup> (10 g) of Head TSL	condition	
SAR measured	250 mW input power	5.26 mW / g
SAR for nominal Head TSL parameters	normalized to 1W	20.9 mW / g $\pm$ 16.5 % (k=2)

## Body TSL parameters

The following parameters and calculations were applied.

	Temperature	Permittivity	Conductivity
Nominal Body TSL parameters	22.0 °C	53.3	1.52 mho/m
Measured Body TSL parameters	(22.0 $\pm$ 0.2) °C	52.3 $\pm$ 6 %	1.53 mho/m $\pm$ 6 %
Body TSL temperature change during test	< 0.5 °C	----	----

## SAR result with Body TSL

SAR averaged over 1 cm <sup>3</sup> (1 g) of Body TSL	Condition	
SAR measured	250 mW input power	10.3 mW / g
SAR for nominal Body TSL parameters	normalized to 1W	40.9 mW / g $\pm$ 17.0 % (k=2)

SAR averaged over 10 cm <sup>3</sup> (10 g) of Body TSL	condition	
SAR measured	250 mW input power	5.38 mW / g
SAR for nominal Body TSL parameters	normalized to 1W	21.4 mW / g $\pm$ 16.5 % (k=2)

## Appendix

### Antenna Parameters with Head TSL

Impedance, transformed to feed point	$52.5 \Omega + 8.0 j\Omega$
Return Loss	- 21.8 dB

### Antenna Parameters with Body TSL

Impedance, transformed to feed point	$46.7 \Omega + 7.1 j\Omega$
Return Loss	- 21.8 dB

### General Antenna Parameters and Design

Electrical Delay (one direction)	1.192 ns
----------------------------------	----------

After long term use with 100W radiated power, only a slight warming of the dipole near the feedpoint can be measured.

The dipole is made of standard semirigid coaxial cable. The center conductor of the feeding line is directly connected to the second arm of the dipole. The antenna is therefore short-circuited for DC-signals.

No excessive force must be applied to the dipole arms, because they might bend or the soldered connections near the feedpoint may be damaged.

### Additional EUT Data

Manufactured by	SPEAG
Manufactured on	June 28, 2006

# DASY5 Validation Report for Head TSL

Date: 20.07.2011

Test Laboratory: SPEAG, Zurich, Switzerland

---

**DUT: Dipole 1900 MHz; Type: D1900V2; Serial: D1900V2 - SN: 5d080**

---

Communication System: CW; Frequency: 1900 MHz

Medium parameters used:  $f = 1900$  MHz;  $\sigma = 1.42$  mho/m;  $\epsilon_r = 39.1$ ;  $\rho = 1000$  kg/m<sup>3</sup>

Phantom section: Flat Section

Measurement Standard: DASY5 (IEEE/IEC/ANSI C63.19-2007)

DASY52 Configuration:

- Probe: ES3DV3 - SN3205; ConvF(5.01, 5.01, 5.01); Calibrated: 29.04.2011
- Sensor-Surface: 3mm (Mechanical Surface Detection)
- Electronics: DAE4 Sn601; Calibrated: 04.07.2011
- Phantom: Flat Phantom 5.0 (front); Type: QD000P50AA; Serial: 1001
- DASY52 52.6.2(482); SEMCAD X 14.4.5(3634)

## Dipole Calibration for Head Tissue/Pin=250 mW, d=10mm/Zoom Scan (7x7x7)/Cube 0:

Measurement grid: dx=5mm, dy=5mm, dz=5mm

Reference Value = 98.443 V/m; Power Drift = 0.03 dB

Peak SAR (extrapolated) = 18.442 W/kg

**SAR(1 g) = 10.1 mW/g; SAR(10 g) = 5.26 mW/g**

Maximum value of SAR (measured) = 12.731 mW/g

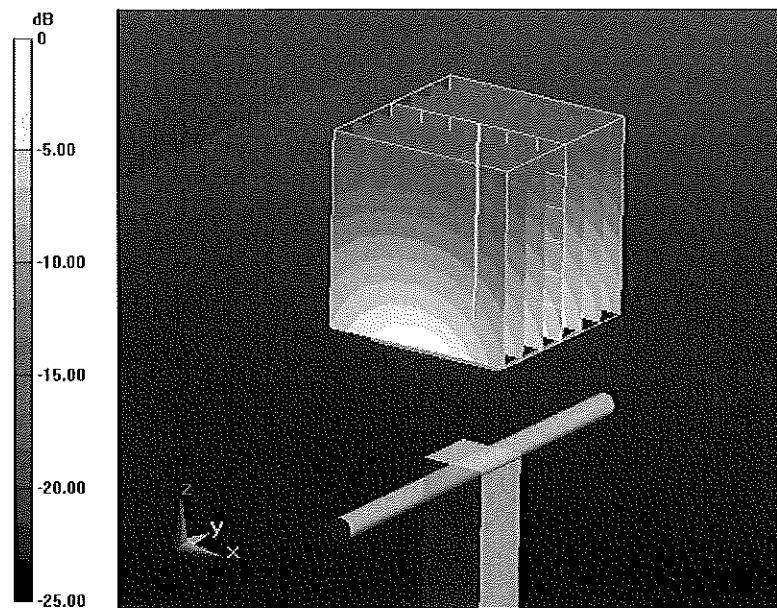

0 dB = 12.730mW/g

# Impedance Measurement Plot for Head TSL

20 Jul 2011 09:48:19

CH1 S11 1 U FS 2:52.539 n 0.0078 n 670.78 pF 1:900.000 000 MHz

\*  
De1  
Cor  
Avg  
16  
H1 d

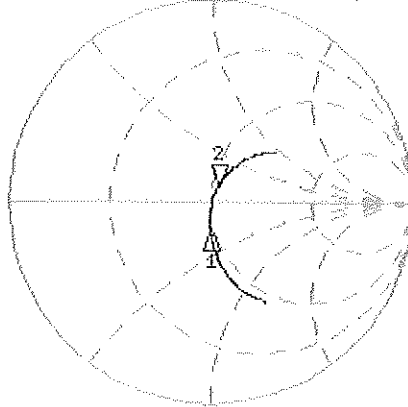

CH1 Markers  
1: 47.551 n  
-14.164 n  
1.80000 GHz

CH2 S11 LOG 5 dB/REF -20 dB 2:-21.756 dB 1:900.000 000 MHz

Cor  
Avg  
16  
H1 d

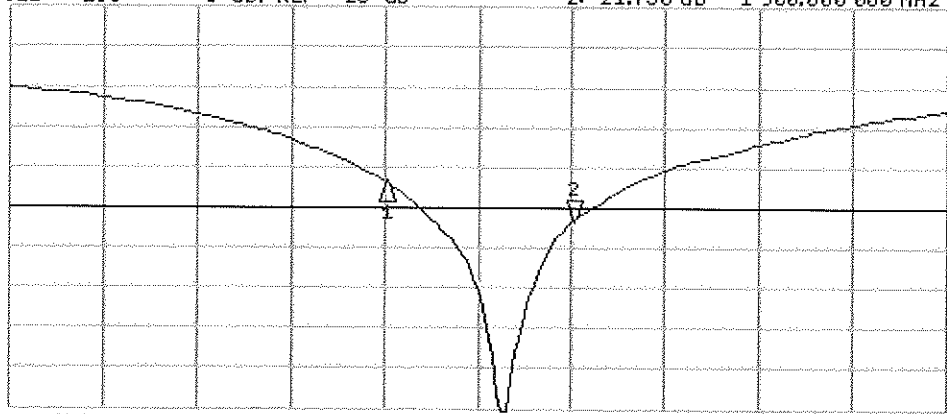

CH2 Markers  
1:-16.725 dB  
1.80000 GHz

# DASY5 Validation Report for Body TSL

Date: 22.07.2011

Test Laboratory: SPEAG, Zurich, Switzerland

~~DUT: Dipole 1900 MHz; Type: D1900V2; Serial: D1900V2 - SN: 5d080~~

Communication System: CW; Frequency: 1900 MHz

Medium parameters used:  $f = 1900$  MHz;  $\sigma = 1.53$  mho/m;  $\epsilon_r = 52.3$ ;  $\rho = 1000$  kg/m<sup>3</sup>

Phantom section: Flat Section

Measurement Standard: DASY5 (IEEE/IEC/ANSI C63.19-2007)

DASY52 Configuration:

- Probe: ES3DV3 - SN3205; ConvF(4.62, 4.62, 4.62); Calibrated: 29.04.2011
- Sensor-Surface: 3mm (Mechanical Surface Detection)
- Electronics: DAE4 Sn601; Calibrated: 04.07.2011
- Phantom: Flat Phantom 5.0 (back); Type: QD000P50AA; Serial: 1002
- DASY52 52.6.2(482); SEMCAD X 14.4.5(3634)

## Dipole Calibration for Body Tissue/Pin=250 mW, d=10mm/Zoom Scan (7x7x7)/Cube 0:

Measurement grid: dx=5mm, dy=5mm, dz=5mm

Reference Value = 96.049 V/m; Power Drift = 0.0018 dB

Peak SAR (extrapolated) = 18.160 W/kg

**SAR(1 g) = 10.3 mW/g; SAR(10 g) = 5.38 mW/g**

Maximum value of SAR (measured) = 13.017 mW/g

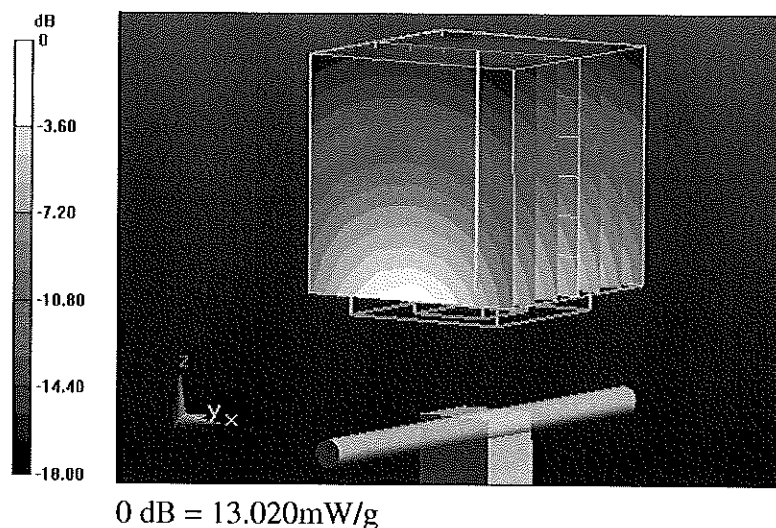

# Impedance Measurement Plot for Body TSL

22 Jul 2011 09:44:35

[CH1] S11 1 U FS 2:46.744  $\mu$  7.1348  $\mu$  597.65 pF 1 900.000 000 MHz

\*  
De1  
Cor

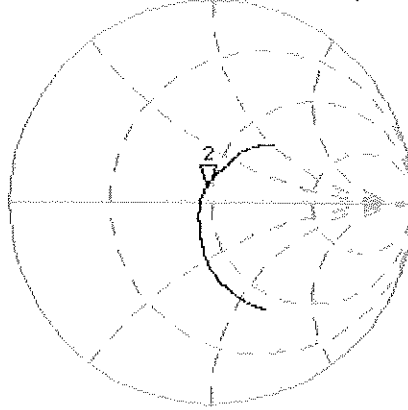

Avg  
16

H1d

CH2 S11 LOG 5 dB/REF -20 dB 2:-21.845 dB 1 900.000 000 MHz

Cor

Avg  
16

H1d

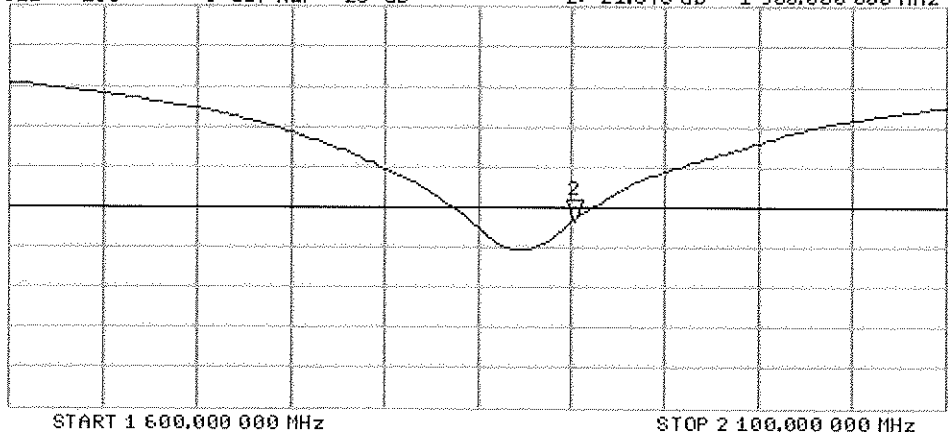



Accredited by the Swiss Accreditation Service (SAS)

Accreditation No.: **SCS 108**

The Swiss Accreditation Service is one of the signatories to the EA  
Multilateral Agreement for the recognition of calibration certificates

Client **PC Test**

Certificate No: **D2450V2-719\_Aug11**

## CALIBRATION CERTIFICATE

Object **D2450V2 - SN: 719**

Calibration procedure(s) **QA CAL-05.v8  
Calibration procedure for dipole validation kits above 700 MHz**

Calibration date: **August 19, 2011**

✓ KOK  
9/6/11

This calibration certificate documents the traceability to national standards, which realize the physical units of measurements (SI).  
The measurements and the uncertainties with confidence probability are given on the following pages and are part of the certificate.

All calibrations have been conducted in the closed laboratory facility: environment temperature (22 ± 3)°C and humidity < 70%.

Calibration Equipment used (M&TE critical for calibration)

Primary Standards	ID #	Cal Date (Certificate No.)	Scheduled Calibration
Power meter EPM-442A	GB37480704	06-Oct-10 (No. 217-01266)	Oct-11
Power sensor HP 8481A	US37292783	06-Oct-10 (No. 217-01266)	Oct-11
Reference 20 dB Attenuator	SN: S5086 (20b)	29-Mar-11 (No. 217-01367)	Apr-12
Type-N mismatch combination	SN: 5047.2 / 06327	29-Mar-11 (No. 217-01371)	Apr-12
Reference Probe ES3DV3	SN: 3205	29-Apr-11 (No. ES3-3205_Apr11)	Apr-12
DAE4	SN: 601	04-Jul-11 (No. DAE4-601_Jul11)	Jul-12
Secondary Standards	ID #	Check Date (in house)	Scheduled Check
Power sensor HP 8481A	MY41092317	18-Oct-02 (in house check Oct-09)	In house check: Oct-11
RF generator R&S SMT-06	100005	04-Aug-99 (in house check Oct-09)	In house check: Oct-11
Network Analyzer HP 8753E	US37390585 S4206	18-Oct-01 (in house check Oct-10)	In house check: Oct-11

Calibrated by: **Claudio Leubler**      **Laboratory Technician**

Signature

Approved by: **Katja Pokovic**      **Technical Manager**

Issued: August 22, 2011

This calibration certificate shall not be reproduced except in full without written approval of the laboratory.



Accredited by the Swiss Accreditation Service (SAS)

Accreditation No.: **SCS 108**

The Swiss Accreditation Service is one of the signatories to the EA  
Multilateral Agreement for the recognition of calibration certificates

### Glossary:

TSL	tissue simulating liquid
ConvF	sensitivity in TSL / NORM x,y,z
N/A	not applicable or not measured

### Calibration is Performed According to the Following Standards:

- IEEE Std 1528-2003, "IEEE Recommended Practice for Determining the Peak Spatial-Averaged Specific Absorption Rate (SAR) in the Human Head from Wireless Communications Devices: Measurement Techniques", December 2003
- IEC 62209-1, "Procedure to measure the Specific Absorption Rate (SAR) for hand-held devices used in close proximity to the ear (frequency range of 300 MHz to 3 GHz)", February 2005
- Federal Communications Commission Office of Engineering & Technology (FCC OET), "Evaluating Compliance with FCC Guidelines for Human Exposure to Radiofrequency Electromagnetic Fields; Additional Information for Evaluating Compliance of Mobile and Portable Devices with FCC Limits for Human Exposure to Radiofrequency Emissions", Supplement C (Edition 01-01) to Bulletin 65

### Additional Documentation:

- DASY4/5 System Handbook

### Methods Applied and Interpretation of Parameters:

- Measurement Conditions:** Further details are available from the Validation Report at the end of the certificate. All figures stated in the certificate are valid at the frequency indicated.
- Antenna Parameters with TSL:** The dipole is mounted with the spacer to position its feed point exactly below the center marking of the flat phantom section, with the arms oriented parallel to the body axis.
- Feed Point Impedance and Return Loss:** These parameters are measured with the dipole positioned under the liquid filled phantom. The impedance stated is transformed from the measurement at the SMA connector to the feed point. The Return Loss ensures low reflected power. No uncertainty required.
- Electrical Delay:** One-way delay between the SMA connector and the antenna feed point. No uncertainty required.
- SAR measured:** SAR measured at the stated antenna input power.
- SAR normalized:** SAR as measured, normalized to an input power of 1 W at the antenna connector.
- SAR for nominal TSL parameters:** The measured TSL parameters are used to calculate the nominal SAR result.

## Measurement Conditions

DASY system configuration, as far as not given on page 1.

DASY Version	DASY5	V52.6.2
Extrapolation	Advanced Extrapolation	
Phantom	Modular Flat Phantom	
Distance Dipole Center - TSL	10 mm	with Spacer
Zoom Scan Resolution	dx, dy, dz = 5 mm	
Frequency	2450 MHz $\pm$ 1 MHz	

## Head TSL parameters

The following parameters and calculations were applied.

	Temperature	Permittivity	Conductivity
Nominal Head TSL parameters	22.0 °C	39.2	1.80 mho/m
Measured Head TSL parameters	(22.0 $\pm$ 0.2) °C	38.4 $\pm$ 6 %	1.85 mho/m $\pm$ 6 %
Head TSL temperature change during test	< 0.5 °C	----	----

## SAR result with Head TSL

SAR averaged over 1 cm <sup>3</sup> (1 g) of Head TSL	Condition	
SAR measured	250 mW input power	13.7 mW / g
SAR for nominal Head TSL parameters	normalized to 1W	<b>53.8 mW / g <math>\pm</math> 17.0 % (k=2)</b>

SAR averaged over 10 cm <sup>3</sup> (10 g) of Head TSL	condition	
SAR measured	250 mW input power	6.35 mW / g
SAR for nominal Head TSL parameters	normalized to 1W	<b>25.2 mW / g <math>\pm</math> 16.5 % (k=2)</b>

## Body TSL parameters

The following parameters and calculations were applied.

	Temperature	Permittivity	Conductivity
Nominal Body TSL parameters	22.0 °C	52.7	1.95 mho/m
Measured Body TSL parameters	(22.0 $\pm$ 0.2) °C	51.8 $\pm$ 6 %	2.02 mho/m $\pm$ 6 %
Body TSL temperature change during test	< 0.5 °C	----	----

## SAR result with Body TSL

SAR averaged over 1 cm <sup>3</sup> (1 g) of Body TSL	Condition	
SAR measured	250 mW input power	13.1 mW / g
SAR for nominal Body TSL parameters	normalized to 1W	<b>51.3 mW / g <math>\pm</math> 17.0 % (k=2)</b>

SAR averaged over 10 cm <sup>3</sup> (10 g) of Body TSL	condition	
SAR measured	250 mW input power	6.07 mW / g
SAR for nominal Body TSL parameters	normalized to 1W	<b>24.1 mW / g <math>\pm</math> 16.5 % (k=2)</b>

## Appendix

### Antenna Parameters with Head TSL

Impedance, transformed to feed point	53.2 $\Omega$ + 3.6 j $\Omega$
Return Loss	- 26.6 dB

### Antenna Parameters with Body TSL

Impedance, transformed to feed point	49.6 $\Omega$ + 4.3 j $\Omega$
Return Loss	- 27.3 dB

### General Antenna Parameters and Design

Electrical Delay (one direction)	1.149 ns
----------------------------------	----------

After long term use with 100W radiated power, only a slight warming of the dipole near the feedpoint can be measured.

The dipole is made of standard semirigid coaxial cable. The center conductor of the feeding line is directly connected to the second arm of the dipole. The antenna is therefore short-circuited for DC-signals.

No excessive force must be applied to the dipole arms, because they might bend or the soldered connections near the feedpoint may be damaged.

### Additional EUT Data

Manufactured by	SPEAG
Manufactured on	September 10, 2002

# DASY5 Validation Report for Head TSL

Date: 18.08.2011

Test Laboratory: SPEAG, Zurich, Switzerland

~~DUT: Dipole 2450 MHz; Type: D2450V2; Serial: D2450V2 - SN: 719~~

Communication System: CW; Frequency: 2450 MHz

Medium parameters used:  $f = 2450$  MHz;  $\sigma = 1.85$  mho/m;  $\epsilon_r = 38.4$ ;  $\rho = 1000$  kg/m<sup>3</sup>

Phantom section: Flat Section

Measurement Standard: DASY5 (IEEE/IEC/ANSI C63.19-2007)

DASY52 Configuration:

- Probe: ES3DV3 - SN3205; ConvF(4.45, 4.45, 4.45); Calibrated: 29.04.2011
- Sensor-Surface: 3mm (Mechanical Surface Detection)
- Electronics: DAE4 Sn601; Calibrated: 04.07.2011
- Phantom: Flat Phantom 5.0 (front); Type: QD000P50AA; Serial: 1001
- DASY52 52.6.2(482); SEMCAD X 14.4.5(3634)

## Dipole Calibration for Head Tissue/Pin=250 mW, d=10mm/Zoom Scan (7x7x7)/Cube 0:

Measurement grid: dx=5mm, dy=5mm, dz=5mm

Reference Value = 101.4 V/m; Power Drift = 0.06 dB

Peak SAR (extrapolated) = 28.234 W/kg

**SAR(1 g) = 13.7 mW/g; SAR(10 g) = 6.35 mW/g**

Maximum value of SAR (measured) = 17.657 mW/g

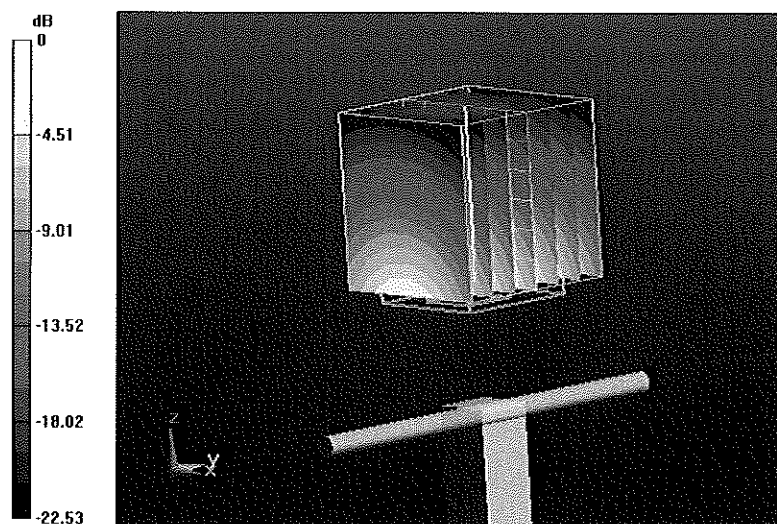

0 dB = 17.660mW/g

# Impedance Measurement Plot for Head TSL

18 Aug 2011 10:43:30

CH1 S11 1 U FS 1:53.248  $\mu$  3.5703  $\mu$  231.93 pF 2 450.000 000 MHz

\*  
Del  
CA

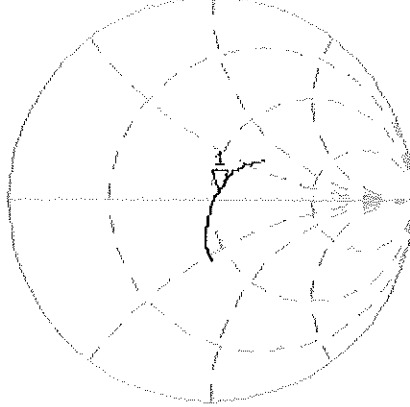

Avg  
16

HI d

CH2 S11 LOG 5 dB/REF -20 dB 1:-26.606 dB 2 450.000 000 MHz

CA

Avg  
16

HI d

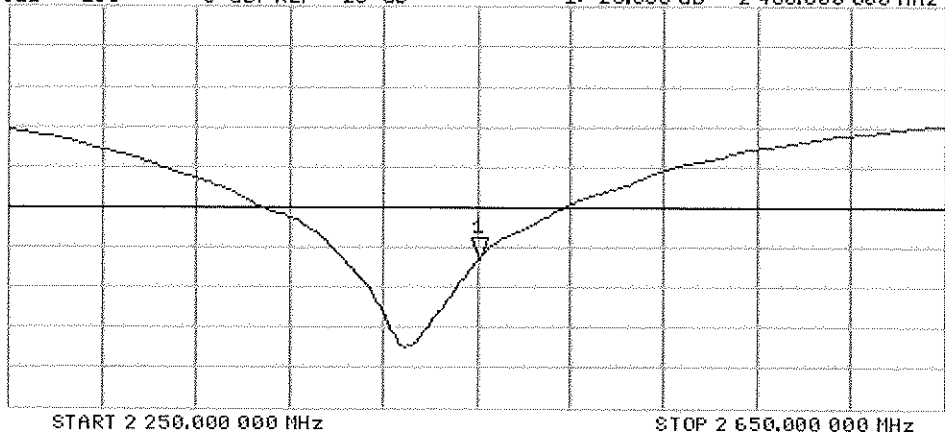

# DASY5 Validation Report for Body TSL

Date: 19.08.2011

Test Laboratory: SPEAG, Zurich, Switzerland

~~DUT: Dipole 2450 MHz; Type: D2450V2; Serial: D2450V2 - SN: 719~~

Communication System: CW; Frequency: 2450 MHz

Medium parameters used:  $f = 2450$  MHz;  $\sigma = 2.02$  mho/m;  $\epsilon_r = 51.8$ ;  $\rho = 1000$  kg/m<sup>3</sup>

Phantom section: Flat Section

Measurement Standard: DASY5 (IEEE/IEC/ANSI C63.19-2007)

DASY52 Configuration:

- Probe: ES3DV3 - SN3205; ConvF(4.26, 4.26, 4.26); Calibrated: 29.04.2011
- Sensor-Surface: 3mm (Mechanical Surface Detection)
- Electronics: DAE4 Sn601; Calibrated: 04.07.2011
- Phantom: Flat Phantom 5.0 (back); Type: QD000P50AA; Serial: 1002
- DASY52 52.6.2(482); SEMCAD X 14.4.5(3634)

## Dipole Calibration for Body Tissue/Pin=250 mW, d=10mm/Zoom Scan (7x7x7)/Cube 0:

Measurement grid: dx=5mm, dy=5mm, dz=5mm

Reference Value = 95.948 V/m; Power Drift = 0.01 dB

Peak SAR (extrapolated) = 26.876 W/kg

**SAR(1 g) = 13.1 mW/g; SAR(10 g) = 6.07 mW/g**

Maximum value of SAR (measured) = 17.309 mW/g

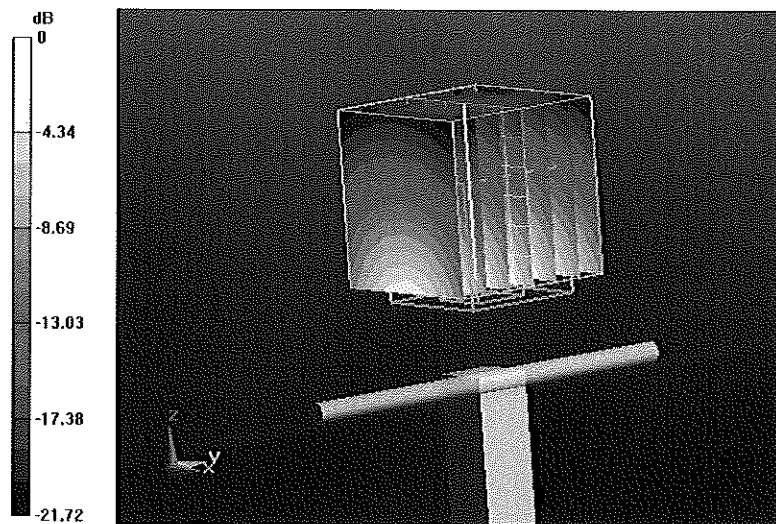

0 dB = 17.310mW/g

# Impedance Measurement Plot for Body TSL

18 Aug 2011 10:49:46

[CH1] S11 1 U FS 1: 49.582  $\mu$  4.2578  $\mu$  276.59 pH 2 450.000 000 MHz

\*  
De1  
CA

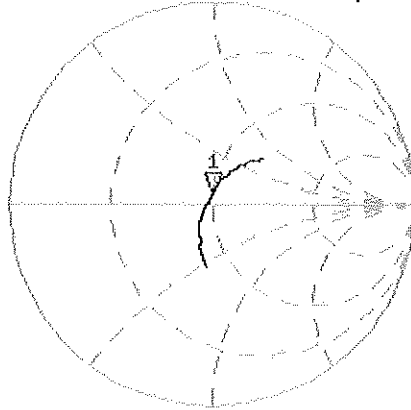

Avg  
16

H1 d

CH2 S11 LOG 5 dB/REF -20 dB 1:-27.342 dB 2 450.000 000 MHz

CA

Avg  
16

H1 d

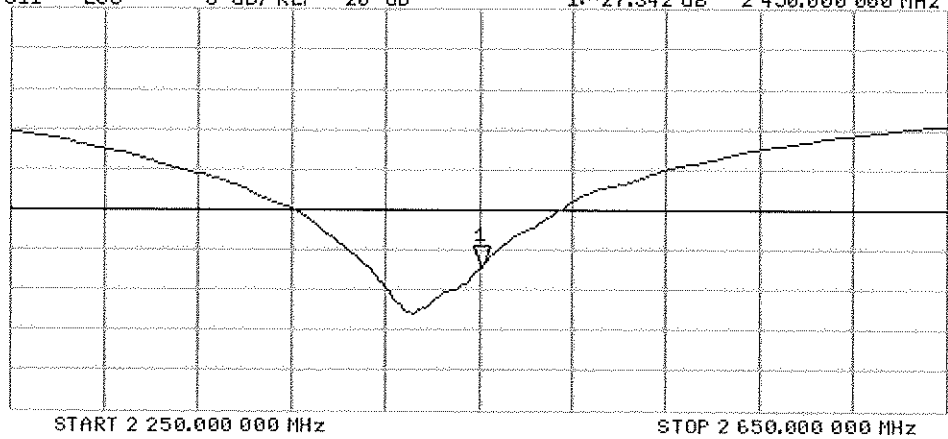



Accredited by the Swiss Accreditation Service (SAS)  
The Swiss Accreditation Service is one of the signatories to the EA  
Multilateral Agreement for the recognition of calibration certificates

Accreditation No.: **SCS 108**

Client **PC Test**

Certificate No: **D1900V2-502\_Feb11**

## CALIBRATION CERTIFICATE

Object **D1900V2 - SN: 502**

Calibration procedure(s) **QA CAL-05.v8  
Calibration procedure for dipole validation kits**

Calibration date: **February 17, 2011**

✓  
KOK  
2/24/11

This calibration certificate documents the traceability to national standards, which realize the physical units of measurements (SI).  
The measurements and the uncertainties with confidence probability are given on the following pages and are part of the certificate.

All calibrations have been conducted in the closed laboratory facility: environment temperature (22 ± 3)°C and humidity < 70%.

Calibration Equipment used (M&TE critical for calibration)

Primary Standards	ID #	Cal Date (Certificate No.)	Scheduled Calibration
Power meter EPM-442A	GB37480704	06-Oct-10 (No. 217-01266)	Oct-11
Power sensor HP 8481A	US37292783	06-Oct-10 (No. 217-01266)	Oct-11
Reference 20 dB Attenuator	SN: 5086 (20g)	30-Mar-10 (No. 217-01158)	Mar-11
Type-N mismatch combination	SN: 5047.2 / 06327	30-Mar-10 (No. 217-01162)	Mar-11
Reference Probe ES3DV3	SN: 3205	30-Apr-10 (No. ES3-3205_Apr10)	Apr-11
DAE4	SN: 601	10-Jun-10 (No. DAE4-601_Jun10)	Jun-11
Secondary Standards	ID #	Check Date (in house)	Scheduled Check
Power sensor HP 8481A	MY41092317	18-Oct-02 (in house check Oct-09)	In house check: Oct-11
RF generator R&S SMT-06	100005	4-Aug-99 (in house check Oct-09)	In house check: Oct-11
Network Analyzer HP 8753E	US37390585 S4206	18-Oct-01 (in house check Oct-10)	In house check: Oct-11

Calibrated by: **Dimce Iliev**      Name: **Dimce Iliev**      Function: **Laboratory Technician**      Signature: *[Signature]*

Approved by: **Katja Pokovic**      Name: **Katja Pokovic**      Function: **Technical Manager**      Signature: *[Signature]*

Issued: February 17, 2011

This calibration certificate shall not be reproduced except in full without written approval of the laboratory.



Accredited by the Swiss Accreditation Service (SAS)

The Swiss Accreditation Service is one of the signatories to the EA  
Multilateral Agreement for the recognition of calibration certificates

Accreditation No.: **SCS 108**

### Glossary:

TSL	tissue simulating liquid
ConvF	sensitivity in TSL / NORM x,y,z
N/A	not applicable or not measured

### Calibration is Performed According to the Following Standards:

- IEEE Std 1528-2003, "IEEE Recommended Practice for Determining the Peak Spatial-Averaged Specific Absorption Rate (SAR) in the Human Head from Wireless Communications Devices: Measurement Techniques", December 2003
- IEC 62209-1, "Procedure to measure the Specific Absorption Rate (SAR) for hand-held devices used in close proximity to the ear (frequency range of 300 MHz to 3 GHz)", February 2005
- Federal Communications Commission Office of Engineering & Technology (FCC OET), "Evaluating Compliance with FCC Guidelines for Human Exposure to Radiofrequency Electromagnetic Fields; Additional Information for Evaluating Compliance of Mobile and Portable Devices with FCC Limits for Human Exposure to Radiofrequency Emissions", Supplement C (Edition 01-01) to Bulletin 65

### Additional Documentation:

- DASY4/5 System Handbook

### Methods Applied and Interpretation of Parameters:

- Measurement Conditions:** Further details are available from the Validation Report at the end of the certificate. All figures stated in the certificate are valid at the frequency indicated.
- Antenna Parameters with TSL:** The dipole is mounted with the spacer to position its feed point exactly below the center marking of the flat phantom section, with the arms oriented parallel to the body axis.
- Feed Point Impedance and Return Loss:** These parameters are measured with the dipole positioned under the liquid filled phantom. The impedance stated is transformed from the measurement at the SMA connector to the feed point. The Return Loss ensures low reflected power. No uncertainty required.
- Electrical Delay:** One-way delay between the SMA connector and the antenna feed point. No uncertainty required.
- SAR measured:** SAR measured at the stated antenna input power.
- SAR normalized:** SAR as measured, normalized to an input power of 1 W at the antenna connector.
- SAR for nominal TSL parameters:** The measured TSL parameters are used to calculate the nominal SAR result.

## Measurement Conditions

DASY system configuration, as far as not given on page 1.

DASY Version	DASY5	V52.6
Extrapolation	Advanced Extrapolation	
Phantom	Modular Flat Phantom V5.0	
Distance Dipole Center - TSL	10 mm	with Spacer
Zoom Scan Resolution	dx, dy, dz = 5 mm	
Frequency	1900 MHz $\pm$ 1 MHz	

## Head TSL parameters

The following parameters and calculations were applied.

	Temperature	Permittivity	Conductivity
Nominal Head TSL parameters	22.0 °C	40.0	1.40 mho/m
Measured Head TSL parameters	(22.0 $\pm$ 0.2) °C	39.8 $\pm$ 6 %	1.41 mho/m $\pm$ 6 %
Head TSL temperature during test	(21.5 $\pm$ 0.2) °C	----	----

## SAR result with Head TSL

SAR averaged over 1 cm <sup>3</sup> (1 g) of Head TSL	Condition	
SAR measured	250 mW input power	10.1 mW / g
SAR normalized	normalized to 1W	40.4 mW / g
SAR for nominal Head TSL parameters	normalized to 1W	<b>40.2 mW / g <math>\pm</math> 17.0 % (k=2)</b>

SAR averaged over 10 cm <sup>3</sup> (10 g) of Head TSL	condition	
SAR measured	250 mW input power	5.26 mW / g
SAR normalized	normalized to 1W	21.0 mW / g
SAR for nominal Head TSL parameters	normalized to 1W	<b>21.0 mW / g <math>\pm</math> 16.5 % (k=2)</b>

## Body TSL parameters

The following parameters and calculations were applied.

	Temperature	Permittivity	Conductivity
Nominal Body TSL parameters	22.0 °C	53.3	1.52 mho/m
Measured Body TSL parameters	(22.0 ± 0.2) °C	52.8 ± 6 %	1.55 mho/m ± 6 %
Body TSL temperature during test	(21.5 ± 0.2) °C	----	----

## SAR result with Body TSL

SAR averaged over 1 cm <sup>3</sup> (1 g) of Body TSL	Condition	
SAR measured	250 mW input power	10.4 mW / g
SAR normalized	normalized to 1W	41.6 mW / g
SAR for nominal Body TSL parameters	normalized to 1W	<b>41.1 mW / g ± 17.0 % (k=2)</b>

SAR averaged over 10 cm <sup>3</sup> (10 g) of Body TSL	condition	
SAR measured	250 mW input power	5.48 mW / g
SAR normalized	normalized to 1W	21.9 mW / g
SAR for nominal Body TSL parameters	normalized to 1W	<b>21.8 mW / g ± 16.5 % (k=2)</b>

## Appendix

### Antenna Parameters with Head TSL

Impedance, transformed to feed point	51.3 $\Omega$ + 6.4 j $\Omega$
Return Loss	- 23.8 dB

### Antenna Parameters with Body TSL

Impedance, transformed to feed point	47.3 $\Omega$ + 6.7 j $\Omega$
Return Loss	- 22.5 dB

### General Antenna Parameters and Design

Electrical Delay (one direction)	1.206 ns
----------------------------------	----------

After long term use with 100W radiated power, only a slight warming of the dipole near the feedpoint can be measured.

The dipole is made of standard semirigid coaxial cable. The center conductor of the feeding line is directly connected to the second arm of the dipole. The antenna is therefore short-circuited for DC-signals.

No excessive force must be applied to the dipole arms, because they might bend or the soldered connections near the feedpoint may be damaged.

### Additional EUT Data

Manufactured by	SPEAG
Manufactured on	November 14, 1998

# DASY5 Validation Report for Head TSL

Date/Time: 17.02.2011 10:13:23

Test Laboratory: SPEAG, Zurich, Switzerland

**DUT: Dipole 1900 MHz; Type: D1900V2; Serial: D1900V2 - SN:502**

Communication System: CW; Frequency: 1900 MHz; Duty Cycle: 1:1

Medium: HSL U12 BB

Medium parameters used:  $f = 1900$  MHz;  $\sigma = 1.41$  mho/m;  $\epsilon_r = 39.9$ ;  $\rho = 1000$  kg/m<sup>3</sup>

Phantom section: Flat Section

Measurement Standard: DASY5 (IEEE/IEC/ANSI C63.19-2007)

DASY5 Configuration:

- Probe: ES3DV3 - SN3205; ConvF(5.09, 5.09, 5.09); Calibrated: 30.04.2010
- Sensor-Surface: 3mm (Mechanical Surface Detection)
- Electronics: DAE4 Sn601; Calibrated: 10.06.2010
- Phantom: Flat Phantom 5.0 (front); Type: QD000P50AA; Serial: 1001
- Measurement SW: DASY52, V52.6.1 Build (408)
- Postprocessing SW: SEMCAD X, V14.4.2 Build (2595)

**Pin=250 mW /d=10mm, dist=3.0mm (ES-Probe)/Zoom Scan (7x7x7) /Cube 0: Measurement grid: dx=5mm, dy=5mm, dz=5mm**

Reference Value = 97.159 V/m; Power Drift = 0.05 dB

Peak SAR (extrapolated) = 18.519 W/kg

**SAR(1 g) = 10.1 mW/g; SAR(10 g) = 5.26 mW/g**

Maximum value of SAR (measured) = 12.407 mW/g

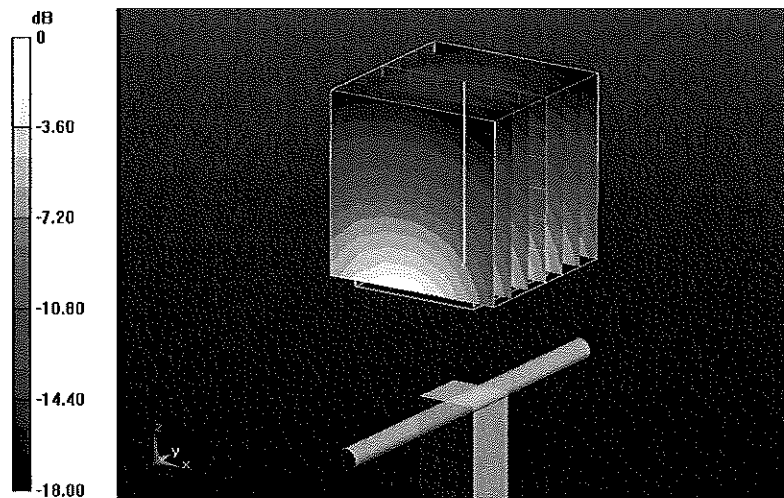

0 dB = 12.410mW/g

# Impedance Measurement Plot for Head TSL

17 Feb 2011 10:39:46

CH1 S11 1 U FS 3: 51.264  $\Omega$  6.4219  $\Omega$  537.93  $\mu$ H 1 900.000 000 MHz

\*  
Del  
CA

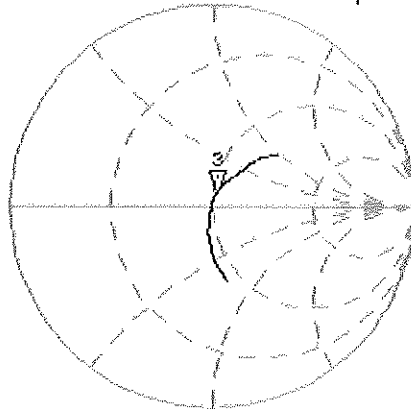

Avg  
16

CH2 S11 LOG 5 dB/REF -20 dB 3:-23.804 dB 1 900.000 000 MHz

CA

Avg  
16

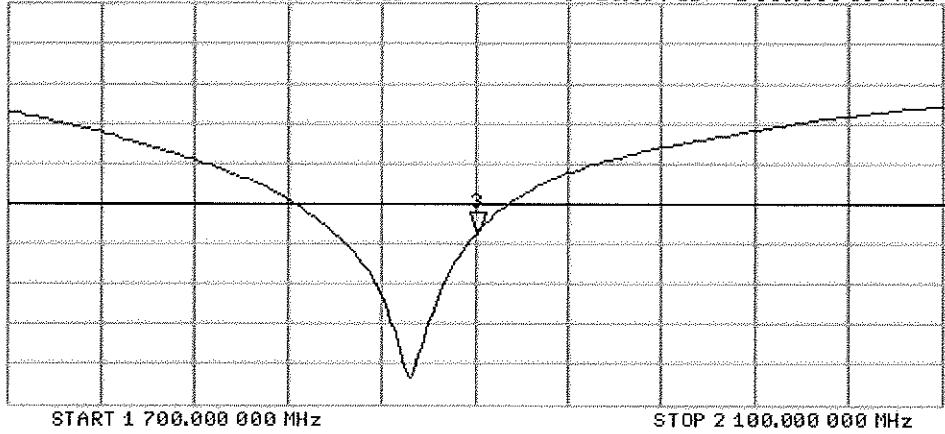

# DASY5 Validation Report for Body TSL

Date/Time: 17.02.2011 10:55:26

Test Laboratory: SPEAG, Zurich, Switzerland

**DUT: Dipole 1900 MHz; Type: D1900V2; Serial: D1900V2 - SN:502**

Communication System: CW; Frequency: 1900 MHz; Duty Cycle: 1:1

Medium: MSL U12 BB

Medium parameters used:  $f = 1900$  MHz;  $\sigma = 1.55$  mho/m;  $\epsilon_r = 52.9$ ;  $\rho = 1000$  kg/m<sup>3</sup>

Phantom section: Flat Section

Measurement Standard: DASY5 (IEEE/IEC/ANSI C63.19-2007)

DASY5 Configuration:

- Probe: ES3DV3 - SN3205; ConvF(4.59, 4.59, 4.59); Calibrated: 30.04.2010
- Sensor-Surface: 3mm (Mechanical Surface Detection)
- Electronics: DAE4 Sn601; Calibrated: 10.06.2010
- Phantom: Flat Phantom 5.0 (back); Type: QD000P50AA; Serial: 1002
- Measurement SW: DASY52, V52.6.1 Build (408)
- Postprocessing SW: SEMCAD X, V14.4.2 Build (2595)

**Pin=250 mW /d=10mm, dist=3.0mm (ES-Probe)/Zoom Scan (7x7x7) /Cube 0: Measurement grid: dx=5mm, dy=5mm, dz=5mm**

Reference Value = 96.636 V/m; Power Drift = -0.02 dB

Peak SAR (extrapolated) = 17.829 W/kg

**SAR(1 g) = 10.4 mW/g; SAR(10 g) = 5.48 mW/g**

Maximum value of SAR (measured) = 13.070 mW/g

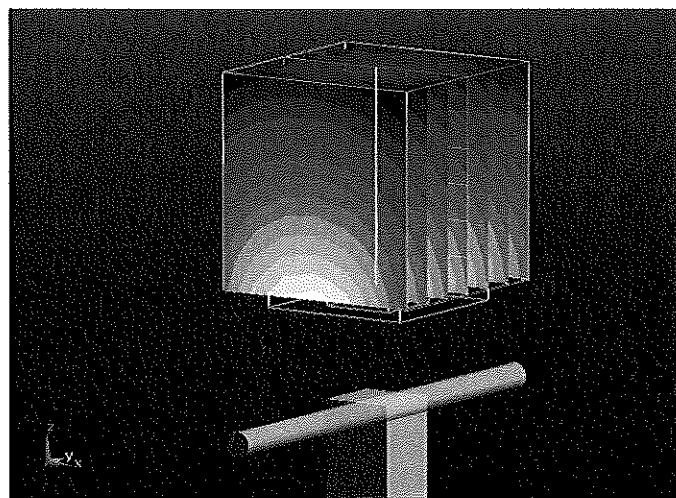

0 dB = 13.070mW/g

# Impedance Measurement Plot for Body TSL

17 Feb 2011 10:40:17

CH1 S11 1 U FS 3: 47.260  $\Omega$  6.7480  $\Omega$  565.26  $\mu$ H 1 900.000 000 MHz

\*  
De1  
CA

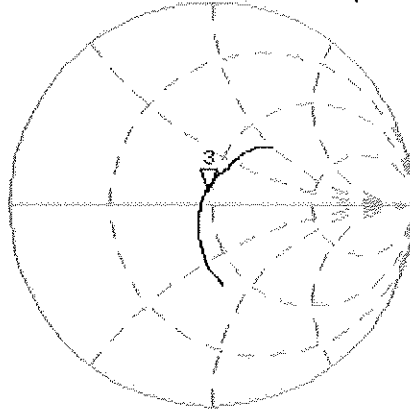

Avg  
16  
↑

CH2 S11 LOG 5 dB/REF -20 dB 3:-22.531 dB 1 900.000 000 MHz

CA

Avg  
16  
↑

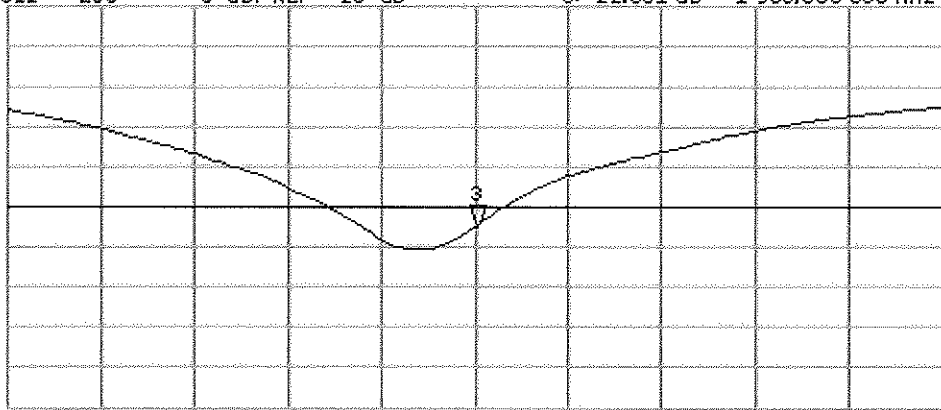

START 1 700.000 000 MHz

STOP 2 100.000 000 MHz