



# PCTEST ENGINEERING LABORATORY, INC.

6660-B Dobbin Road, Columbia, MD 21045 USA  
Tel. 410.290.6652 / Fax 410.290.6654  
http://www.pctestlab.com



## MEASUREMENT REPORT FCC PART 15.247 / IC RSS-210 Bluetooth

**Applicant Name:**  
Motorola Mobility, Inc.  
8000 West Sunrise Blvd.  
Plantation, FL 33322  
United States

**Date of Testing:**  
8/3/2011  
**Test Site/Location:**  
PCTEST Lab. Columbia, MD, USA  
**Test Report Serial No.:**  
0Y1107191263.IHD

<b>FCC ID:</b>	<b>IHDP56MD3</b>
<b>APPLICANT:</b>	<b>Motorola Mobility, Inc.</b>

**Application Type:** Certification

**EUT Type:** Cellular/PCS CDMA/EvDO Phone with BT and WLAN

**Max. RF Output Power:** 16.943 mW (12.29dBm) Conducted

**Frequency Range:** 2402 – 2480MHz (Bluetooth for US)

**Type of Modulation:** GFSK,  $\pi/4$ -QPSK, 8DPSK

**FCC Classification:** FCC Part 15 Spread Spectrum Transmitter (DSS)

**FCC Rule Part(s):** Part 15 Subpart C (15.247)

**IC Specification(s):** RSS-210 Issue 8

This equipment has been shown to be capable of compliance with the applicable technical standards as indicated in the measurement report and was tested in accordance with the measurement procedures specified in ANSI C63.4-2003. Test results reported herein relate only to the item(s) tested.



I attest to the accuracy of data. All measurements reported herein were performed by me or were made under my supervision and are correct to the best of my knowledge and belief. I assume full responsibility for the completeness of these measurements and vouch for the qualifications of all persons taking them.

*Grant Conditions: Power output listed is conducted.*

*PCTEST certifies that no party to this application has been subject to a denial of Federal benefits that includes FCC benefits pursuant to Section 5301 of the Anti-Drug Abuse Act of 1988, 21 U.S.C. 862.*



  
Randy Ortanez  
President



<b>FCC ID:</b> IHDP56MD3		<b>FCC Pt. 15.247 BLUETOOTH TEST REPORT (CERTIFICATION)</b>		<b>Reviewed by:</b> Quality Manager
<b>Test Report S/N:</b> 0Y1107191263.IHD	<b>Test Dates:</b> 8/3/2011	<b>EUT Type:</b> Cellular/PCS CDMA/EvDO Phone with BT and WLAN		Page 1 of 35

# TABLE OF CONTENTS

FCC PART 15.247 MEASUREMENT REPORT.....		3
1.0 INTRODUCTION.....		4
1.1 SCOPE.....		4
1.2 PCTEST TEST LOCATION.....		4
2.0 PRODUCT INFORMATION.....		5
2.1 EQUIPMENT DESCRIPTION.....		5
2.2 EMI SUPPRESSION DEVICE(S)/MODIFICATIONS.....		5
2.3 LABELING REQUIREMENTS.....		5
3.0 DESCRIPTION OF TEST.....		6
3.1 EVALUATION PROCEDURE.....		6
3.2 CONDUCTED EMISSIONS.....		6
3.3 RADIATED EMISSIONS.....		7
4.0 ANTENNA REQUIREMENTS.....		8
5.0 TEST EQUIPMENT CALIBRATION DATA.....		9
6.0 TEST RESULTS.....		10
6.1 SUMMARY.....		10
6.2 20DB BANDWIDTH MEASUREMENT.....		11
6.3 OUTPUT POWER MEASUREMENT.....		17
6.4 BAND EDGE COMPLIANCE.....		18
6.5 CARRIER FREQUENCY SEPARATION.....		21
6.6 TIME OF OCCUPANCY.....		22
6.7 NUMBER OF HOPPING CHANNELS.....		23
6.8 CONDUCTED SPURIOUS EMISSIONS.....		24
6.9 RADIATED SPURIOUS EMISSION MEASUREMENTS.....		28
6.10 RADIATED RESTRICTED BAND EDGE MEASUREMENTS.....		32
6.11 LINE-CONDUCTED TEST DATA.....		33
7.0 CONCLUSION.....		35

<b>FCC ID:</b> IHDP56MD3		<b>FCC Pt. 15.247 BLUETOOTH TEST REPORT (CERTIFICATION)</b>		<b>Reviewed by:</b> Quality Manager
<b>Test Report S/N:</b> 0Y1107191263.IHD	<b>Test Dates:</b> 8/3/2011	<b>EUT Type:</b> Cellular/PCS CDMA/EvDO Phone with BT and WLAN	Page 2 of 35	



# MEASUREMENT REPORT

## FCC Part 15.247



### § 2.1033 General Information

**APPLICANT:** Motorola Mobility, Inc.  
**APPLICANT ADDRESS:** 8000 West Sunrise Blvd.  
 Plantation, FL 33322, United States  
**TEST SITE:** PCTEST ENGINEERING LABORATORY, INC.  
**TEST SITE ADDRESS:** 6660-B Dobbin Road, Columbia, MD 21045 USA  
**FCC RULE PART(S):** Part 15 Subpart C (15.247)  
**IC SPECIFICATION(S):** RSS-210 Issue 8  
**FCC ID:** IHDP56MD3  
**Test Device Serial No.:** M176QL22MV     Production     Pre-Production     Engineering  
**FCC CLASSIFICATION:** FCC Part 15 Spread Spectrum Transmitter (DSS)  
**Method/System:** Frequency Hopping Spread Spectrum (FHSS)  
**DATE(S) OF TEST:** 8/3/2011  
**TEST REPORT S/N:** 0Y1107191263.IHD

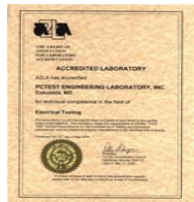

### Test Facility / Accreditations

Measurements were performed at PCTEST Engineering Lab located in Columbia, MD 21045, U.S.A.



- PCTEST facility is an FCC registered (PCTEST Reg. No. 90864) test facility with the site description report on file and has met all the requirements specified in Section 2.948 of the FCC Rules and Industry Canada (2451A-1).
- PCTEST Lab is accredited to ISO 17025 by U.S. National Institute of Standards and Technology (NIST) under the National Voluntary Laboratory Accreditation Program (NVLAP Lab code: 100431-0) in EMC, FCC and Telecommunications.
- PCTEST Lab is accredited to ISO 17025-2005 by the American Association for Laboratory Accreditation (A2LA) in Specific Absorption Rate (SAR) testing, Hearing Aid Compatibility (HAC) testing, CTIA Test Plans, and wireless testing for FCC and Industry Canada Rules.
- PCTEST Lab is a recognized U.S. Conformity Assessment Body (CAB) in EMC and R&TTE (n.b. 0982) under the U.S.-EU Mutual Recognition Agreement (MRA).
- PCTEST TCB is a Telecommunication Certification Body (TCB) accredited to ISO/IEC Guide 65 by the American National Standards Institute (ANSI) in all scopes of FCC Rules and Industry Canada Standards (RSS).
- PCTEST facility is an IC registered (2451A-1) test laboratory with the site description on file at Industry Canada.
- PCTEST is a CTIA Authorized Test Laboratory (CATL) for AMPS, CDMA, and EvDO wireless devices and for Over-the-Air (OTA) Antenna Performance testing for AMPS, CDMA, GSM, GPRS, EGPRS, UMTS (W-CDMA), CDMA 1xEVDO, and CDMA 1xRTT.



<b>FCC ID:</b> IHDP56MD3	 <b>FCC Pt. 15.247 BLUETOOTH TEST REPORT (CERTIFICATION)</b>		<b>Reviewed by:</b> Quality Manager
<b>Test Report S/N:</b> 0Y1107191263.IHD	<b>Test Dates:</b> 8/3/2011	<b>EUT Type:</b> Cellular/PCS CDMA/EvDO Phone with BT and WLAN	

# 1.0 INTRODUCTION

## 1.1 Scope

Measurement and determination of electromagnetic emissions (EMC) of radio frequency devices including intentional and/or unintentional radiators for compliance with the technical rules and regulations of the Federal Communications Commission and the Industry Canada Certification and Engineering Bureau.

## 1.2 PCTEST Test Location

The map below shows the location of the PCTEST LABORATORY, its proximity to the FCC Laboratory, the Columbia vicinity area, the Baltimore-Washington Intern't'l (BWI) airport, the city of Baltimore and the Washington, DC area. (see Figure 1-1).

These measurement tests were conducted at the PCTEST Engineering Laboratory, Inc. facility in New Concept Business Park, Guilford Industrial Park, Columbia, Maryland. The site address is 6660-B Dobbin Road, Columbia, MD 21045. The test site is one of the highest points in the Columbia area with an elevation of 390 feet above mean sea level. The site coordinates are 39° 11'15" N latitude and 76° 49'38" W longitude. The facility is 1.5 miles North of the FCC laboratory, and the ambient signal and ambient signal strength are approximately equal to those of the FCC laboratory. There are no FM or TV transmitters within 15 miles of the site. The detailed description of the measurement facility was found to be in compliance with the requirements of § 2.948 according to ANSI C63.4-2003 on January 28, 2009.

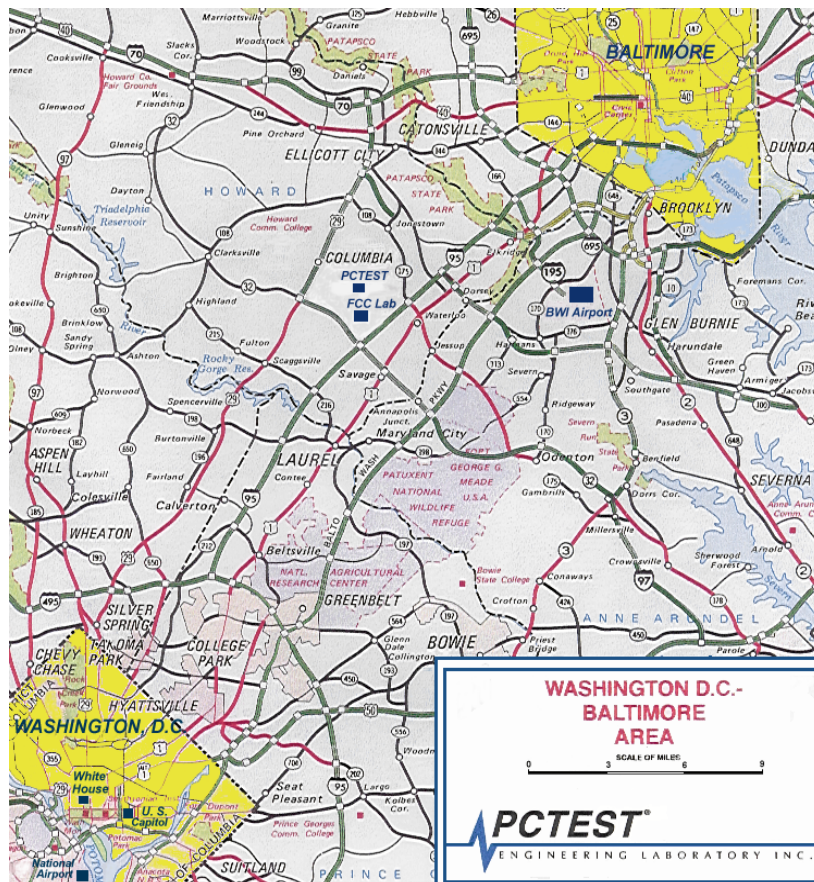

Figure 1-1. Map of the Greater Baltimore and Metropolitan Washington, D.C. area

FCC ID: IHDP56MD3		FCC Pt. 15.247 BLUETOOTH TEST REPORT (CERTIFICATION)		Reviewed by: Quality Manager
Test Report S/N: 0Y1107191263.IHD	Test Dates: 8/3/2011	EUT Type: Cellular/PCS CDMA/EvDO Phone with BT and WLAN		Page 4 of 35

## 2.0 PRODUCT INFORMATION

### 2.1 Equipment Description

The Equipment Under Test (EUT) is the **Motorola Cellular/PCS CDMA/EvDO Phone with BT and WLAN FCC ID: IHDP56MD3**. The test data contained in this report pertains only to the emissions due to the EUT's Bluetooth transmitter.

- This Bluetooth module has been tested by a Bluetooth Qualification Lab, and we confirm the following:
  - A) The hopping sequence is pseudorandom
  - B) All channels are used equally on average
  - C) The receiver input bandwidth equals the transmit bandwidth
  - D) The receiver hops in sequence with the transmit signal
- 15.247(g): In accordance with the Bluetooth Industry Standard, the system is designed to comply with all of the regulations in Section 15.247 when the transmitter is presented with a continuous data (or information) system.
- 15.247(h): In accordance with the Bluetooth Industry Standard, the system does not coordinate its channels selection/ hopping sequence with other frequency hopping systems for the express purpose of avoiding the simultaneous occupancy of individual hopping frequencies by multiple transmitters.
- The EUT consisted of the following component(s):

Manufacturer	FCC ID	Description
Motorola	IHDP56MD3	Cellular/PCS CDMA/EvDO Phone with BT and WLAN

**Table 2-1. EUT Equipment Description**

### 2.2 EMI Suppression Device(s)/Modifications



No EMI suppression device(s) were added and no modifications were made during testing.

### 2.3 Labeling Requirements

Per 15.19; Docket 95-19

The label shall be permanently affixed at a conspicuous location on the device; instruction manual or pamphlet supplied to the user and be readily visible to the purchaser at the time of purchase. However, when the device is so small wherein placement of the label with specified statement is not practical, only the trade name and FCC ID must be displayed on the device per Section 15.19(b)(2).

Please see attachment for FCC ID label and label location.

FCC ID: IHDP56MD3		<b>FCC Pt. 15.247 BLUETOOTH TEST REPORT (CERTIFICATION)</b>		<b>Reviewed by:</b> Quality Manager
<b>Test Report S/N:</b> 0Y1107191263.IHD	<b>Test Dates:</b> 8/3/2011	<b>EUT Type:</b> Cellular/PCS CDMA/EvDO Phone with BT and WLAN	Page 5 of 35	

## 3.0 DESCRIPTION OF TEST

### 3.1 Evaluation Procedure

The measurement procedure described in the American National Standard for Methods of Measurement of Radio-Noise Emission from Low-Voltage Electrical and Electronic Equipment in the Range of 9kHz to 40GHz (ANSI C63.4-2003) and FCC Public Notice DA 00-705 dated March 30, 2000 entitled "Filing and Measurement Guidelines for Frequency Hopping Spread Spectrum Systems" were used in the measurement of the **Motorola Cellular/PCS CDMA/EvDO Phone with BT and WLAN FCC ID: IHDP56MD3**.

Deviation from measurement procedure.....None

### 3.2 Conducted Emissions



**Figure 3-1. Shielded Enclosure Line-Conducted Test Facility**

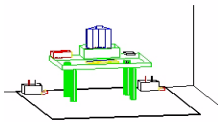

**Figure 3-2. Line Conducted Emission Test Set-Up**

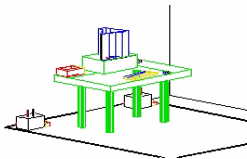

**Figure 3-3. Wooden Table & Bonded LISNs**

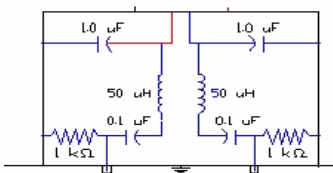

**Figure 3-4. LISN Schematic Diagram**

The line-conducted facility is located inside a 16'x20'x10' shielded enclosure, manufactured by Ray Proof Series 81 (see Figure 3-1). The shielding effectiveness of the shielded room is in accordance with MIL-Std-285 or NSA 65-5. A 1m x 1.5m wooden table 80cm high is placed 40cm away from the vertical wall and 1.5m away from the sidewall of the shielded room (see Figure 3-2). Solar Electronics and EMCO Model 3725/2 (10kHz-30MHz) 50Ω/50μH Line-Impedance Stabilization Networks (LISNs) are bonded to the shielded room (see Figure 3-3). The EUT is powered from the Solar LISN and the support equipment is powered from the EMCO LISN. Power to the LISNs are filtered by a high-current high-insertion loss Ray Proof power line filter (100dB 14Hz-10GHz). The purpose of the filter is to attenuate ambient signal interference and this filter is also bonded to the shielded enclosure. All electrical cables are shielded by braided tinned copper zipper tubing with an inner diameter of ½". If the EUT is a DC-powered device, power will be derived from the source power supply it normally will be powered from and this supply line(s) will be connected to the Solar LISN. The LISN schematic diagram is shown (see Figure 3-4). All interconnecting cables more than 1 meter were shortened to a 1 meter length by non-inductive bundling (serpentine fashion). Sufficient time for the EUT, support equipment, and test equipment was allowed in order for them to warm up to their normal operating condition. The RF output of the LISN was connected to the spectrum analyzer to determine the frequency producing the maximum EME from the EUT.

The spectrum was scanned from 150kHz to 30MHz with a spectrum analyzer. The detector function was set to CISPR quasi-peak and average mode. The bandwidth of the analyzer was set to 10kHz. The EUT, support equipment, and interconnecting cables were arranged and manipulated to maximize each EME emission. Each emission was maximized by: switching power lines; varying the mode of operation or resolution; clock or data exchange speed; scrolling H pattern to the EUT and/or support equipment, and powering the monitor from the floor mounted outlet box and the computer aux AC outlet, if applicable; whichever determined the worst-case emission. Photographs of the worst-case emission can be seen in the test setup photographs. Each EME reported was calibrated using the Agilent E8257D (250kHz – 20GHz) PSG Signal Generator.

FCC ID: IHDP56MD3	PCTEST ENGINEERING LABORATORY, INC.	FCC Pt. 15.247 BLUETOOTH TEST REPORT (CERTIFICATION)		Reviewed by: Quality Manager
Test Report S/N: 0Y1107191263.IHD	Test Dates: 8/3/2011	EUT Type: Cellular/PCS CDMA/EvDO Phone with BT and WLAN	Page 6 of 35	

### 3.3 Radiated Emissions

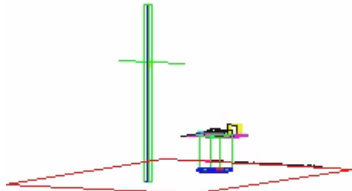

**Figure 3-5. 3-Meter Test Site**

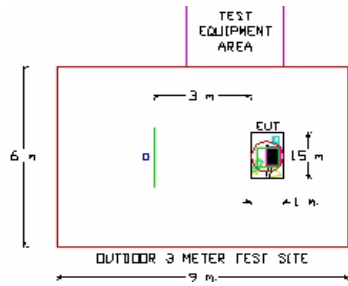

**Figure 3-6. Dimensions of Outdoor Test Site**

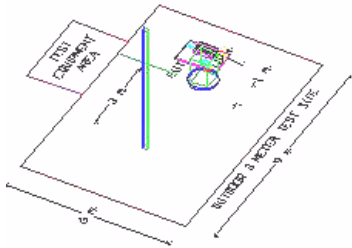

**Figure 3-7. Turntable and System Setup**

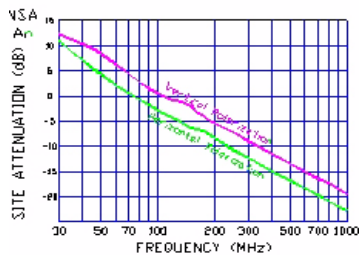

**Figure 3-8. Normalized Site Attenuation Curves (H&V)**

Preliminary measurements were made indoors at 1-meter using broadband antennas, broadband amplifiers, and spectrum analyzers to determine the frequency producing the maximum EME. Appropriate precaution was taken to ensure that all EME from the EUT were maximized and investigated. The system configuration, clock speed, mode of operation or video resolution, and turntable azimuth with respect to the antenna was noted for each frequency found. The spectrum was scanned from 30 to 200 MHz using a bi-conical antenna and from 200 to 1000 MHz using a log-spiral antenna. Above 1 GHz, linearly polarized double ridge horn antennas were used.

Final measurements were made outdoors at 3-meter test range using Roberts™ Dipole antennas or horn antennas (see Figure 3-5). The test equipment was placed on a wooden and plastic bench situated on a 1.5m x 2m area adjacent to the measurement area (see Figure 3-6). Sufficient time for the EUT, support equipment, and test equipment was allowed in order for them to warm up to their normal operating condition. The detector function was set to CISPR quasi-peak mode and the bandwidth of the spectrum analyzer was set to 100kHz for frequencies below 1GHz or 1MHz for frequencies above 1GHz. Above 1GHz the detector function was set to average mode (RBW = 1MHz, VBW = 10Hz).

The half-wave dipole antenna was tuned to the frequency found during preliminary radiated measurements. The EUT, support equipment and interconnecting cables were re-configured to the set-up producing the maximum emission for the frequency and were placed on top of a 0.8-meter high non-metallic 1 x 1.5 meter table (see Figure 3-7). The EUT, support equipment, and interconnecting cables were re-arranged and manipulated to maximize each EME emission. The turntable containing the system was rotated and the height of the receive antenna was varied 1 to 4 meters and stopped at the azimuth and height producing the maximum emission. Each emission was maximized by: varying the mode of operation or resolution; clock or data exchange speed; scrolling H pattern to the EUT and/or support equipment, and powering the monitor from the floor mounted outlet box and the computer aux AC outlet, if applicable; and changing the polarity of the antenna, whichever determined the worst-case emission. Photographs of the worst-case emission can be seen in the test setup photographs. Each EME reported was calibrated using the Agilent E8257D (250kHz – 20GHz) PSG Signal Generator. The Theoretical Normalized Site Attenuation Curves for both horizontal and vertical polarization are shown in Figure 3-8.

FCC ID: IHDP56MD3		FCC Pt. 15.247 BLUETOOTH TEST REPORT (CERTIFICATION)		Reviewed by: Quality Manager
Test Report S/N: 0Y1107191263.IHD	Test Dates: 8/3/2011	EUT Type: Cellular/PCS CDMA/EvDO Phone with BT and WLAN		Page 7 of 35

## 4.0 ANTENNA REQUIREMENTS

**Excerpt from §15.203 of the FCC Rules/Regulations:**

“An intentional radiator antenna shall be designed to ensure that no antenna other than that furnished by the responsible party can be used with the device. The use of a permanently attached antenna or of an antenna that uses a unique coupling to the intentional radiator shall be considered sufficient to comply with the provisions of this section.”



- The antennas of the Motorola Cellular/PCS CDMA/EvDO Phone with BT and WLAN are **permanently attached**.
- There are no provisions for connection to an external antenna.

**Conclusion:**

The **Motorola Cellular/PCS CDMA/EvDO Phone with BT and WLAN FCC ID: IHDP56MD3** unit complies with the requirement of §15.203.

Ch.	Frequency (MHz)
00	2402
:	:
39	2441
:	:
78	2480

**Table 4-1. Frequency/ Channel Operations**



<b>FCC ID:</b> IHDP56MD3		<b>FCC Pt. 15.247 BLUETOOTH TEST REPORT (CERTIFICATION)</b>		<b>Reviewed by:</b> Quality Manager
<b>Test Report S/N:</b> 0Y1107191263.IHD	<b>Test Dates:</b> 8/3/2011	<b>EUT Type:</b> Cellular/PCS CDMA/EvDO Phone with BT and WLAN		Page 8 of 35

## 5.0 TEST EQUIPMENT CALIBRATION DATA

Test Equipment Calibration is traceable to the National Institute of Standards and Technology (NIST).

Manufacturer	Model	Description	Cal Date	Cal Interval	Cal Due	Serial Number
-	263-10dB	(DC-18GHz) 10 dB Attenuator	N/A		N/A	N/A
-	No.166	(1000-26500MHz) Microwave RF Cable	N/A		N/A	N/A
-	No.167	(100kHz - 100MHz) RG58 Coax Cable	N/A		N/A	N/A
Agilent	8447D	Broadband Amplifier	3/17/2011	Annual	3/17/2012	1937A03348
Agilent	85650A	Quasi-Peak Adapter	4/7/2011	Annual	4/7/2012	2043A00301
Agilent	8447D	Broadband Amplifier	3/17/2011	Annual	3/17/2012	2443A01900
Agilent	8449B	(1-26.5GHz) Pre-Amplifier	2/8/2011	Annual	2/8/2012	3008A00985
Agilent	85650A	Quasi-Peak Adapter	4/7/2011	Annual	4/7/2012	3303A01872
Agilent	8566B	(100Hz-22GHz) Spectrum Analyzer	4/7/2011	Annual	4/7/2012	3638A08713
Agilent	N4010A	Wireless Connectivity Test Set	N/A			GB44450273
Agilent	N4010A	Wireless Connectivity Test Set	9/27/2010	Annual	9/27/2011	GB46170464
Agilent	E8257D	(250kHz-20GHz) Signal Generator	4/8/2011	Annual	4/8/2012	MY45470194
Agilent	E4407B	ESA Spectrum Analyzer	4/5/2011	Annual	4/5/2012	US39210313
Agilent	E4448A	PSA (3Hz-50GHz) Spectrum Analyzer	11/30/2010	Annual	11/30/2011	US42510244
Agilent	N9020A	MXA Signal Analyzer	9/8/2010	Annual	9/8/2011	US46470561
Anritsu	ML2495A	Power Meter	10/13/2010	Annual	10/13/2011	941001
Emco	3116	Horn Antenna (18 - 40GHz)	9/9/2008	Triennial	9/9/2011	9203-2178
Emco	3115	Horn Antenna (1-18GHz)	4/8/2010	Biennial	4/8/2012	9205-3874
Emco	3115	Horn Antenna (1-18GHz)	10/14/2009	Biennial	10/14/2011	9704-5182
Emco	3816/2	LISN	11/5/2010	Biennial	11/5/2012	9707-1077
MiniCircuits	VHF-3100+	High Pass Filter	N/A		N/A	30721
Pasternack	PE2209-10	Bidirectional Coupler	N/A		N/A	N/A
Pasternack	PE7000-6	6 dB Attenuator	N/A		N/A	N/A
Rohde & Schwarz	FSQ 26	Spectrum Analyzer	8/28/2010	Annual	8/28/2011	200452
Rohde & Schwarz	CMU200	Base Station Simulator	6/1/2011	Annual	6/1/2012	833855/0010
Sunol	DRH-118	Horn Antenna (1 - 18GHz)	7/5/2011	Biennial	7/5/2013	A050307
Sunol	JB5	Bi-Log Antenna (30M - 5GHz)	8/17/2009	Biennial	8/17/2011	A051107

**Table 5-1. Annual Test Equipment Calibration Schedule**

FCC ID: IHDP56MD3		FCC Pt. 15.247 BLUETOOTH TEST REPORT (CERTIFICATION)		Reviewed by: Quality Manager
Test Report S/N: 0Y1107191263.IHD	Test Dates: 8/3/2011	EUT Type: Cellular/PCS CDMA/EvDO Phone with BT and WLAN	Page 9 of 35	

## 6.0 TEST RESULTS



### 6.1 Summary

Company Name: Motorola Mobility, Inc.  
 FCC ID: IHDP56MD3  
 Method/System: Frequency Hopping Spread Spectrum (FHSS)  
 Number of Channels: 79

FCC Part Section(s)	RSS Section(s)	Test Description	Test Limit	Test Condition	Test Result	Reference
<b>TRANSMITTER MODE (Tx)</b>						
15.247(a)(1)(iii)	RSS-210 [A8.1]	20dB Bandwidth	< 1 MHz only if using less than 15 non-overlapping channels	CONDUCTED	PASS	Section 6.2
15.247(b)(1)	RSS-210 [A8.4(2)]	Peak Transmitter Output Power	< 1 Watt if $\geq 75$ non-overlapping channels used		PASS	Section 6.3
15.247(a)(1)	RSS-210 [A8.1(2)]	Channel Separation	> 2/3 of 20 dB BW for systems with Output Power < 125mW		PASS	Section 6.5
15.247(a)(1)(iii)	RSS-210 [A8.1(4)]	Number of Channels	> 15 Channels		PASS	Section 6.7
15.247(a)(1)(iii)	RSS-210 [A8.1(4)]	Time of Occupancy	< 0.4 sec in 31.6 sec period		PASS	Section 6.6
15.247(d)	RSS-210 [A8.5]	Band Edge / Out-of-Band Emissions	Conducted < 20dBc		PASS	Section 6.4, Section 6.8
15.205 15.209	RSS-210 [A8.5]	General Field Strength Limits (Restricted Bands and Radiated Emission Limits)	Emissions in restricted bands must meet the radiated limits detailed in 15.209 (RSS-210 table 3 limits)	RADIATED	PASS	Section 6.9, Section 6.10
15.207	RSS-Gen [7.2.2]	AC Conducted Emissions 150kHz – 30MHz	< FCC 15.207 limits or < RSS-Gen table 2 limits	LINE CONDUCTED	PASS	Section 6.11
<b>RECEIVER MODE (Rx) / DIGITAL DEVICE</b>						
15.107	RSS-Gen [7.2.2]	AC Conducted Emissions 150kHz – 30MHz	< FCC 15.107 limits or < RSS-Gen table 2 limits	LINE CONDUCTED	PASS	Part 15B Test Report
15.109	RSS-Gen [7.2.3.2]	General Field Strength Limits (Restricted Bands and Radiated Emissions Limits)	< FCC 15.109 limits or < RSS-Gen limits [Section 6; Table1]	RADIATED (30MHz-1GHz) (1-25 GHz)	PASS	Part 15B Test Report

**Table 6-1. Summary of Test Results**

**Note:** Test plots show an earlier date than the test dates of this report. These plots are applicable to this model.

FCC ID: IHDP56MD3		FCC Pt. 15.247 BLUETOOTH TEST REPORT (CERTIFICATION)		Reviewed by: Quality Manager
Test Report S/N: 0Y1107191263.IHD	Test Dates: 8/3/2011	EUT Type: Cellular/PCS CDMA/EvDO Phone with BT and WLAN	Page 10 of 35	

## 6.2 20dB Bandwidth Measurement

**§15.247 (a)(1)(iii); RSS-210 (A8.1)**



The bandwidth at 20dB down from the highest in-band spectral density is measured with a spectrum analyzer connected to the receive antenna while the EUT is operating in transmission mode at the appropriate frequencies. **The maximum permissible 20dB bandwidth is 1 MHz, unless more than 15 non-overlapping channels are employed.**

Frequency [MHz]	Data Rate [Mbps]	Channel No.	20dB Bandwidth Test Results	
			[kHz]	Pass/Fail
2402	1.0	0	1016	Pass
2441	1.0	39	1020	Pass
2480	1.0	78	958	Pass
2402	2.0	0	1324	Pass
2441	2.0	39	1316	Pass
2480	2.0	78	1328	Pass
2402	3.0	0	1296	Pass
2441	3.0	39	1296	Pass
2480	3.0	78	1302	Pass

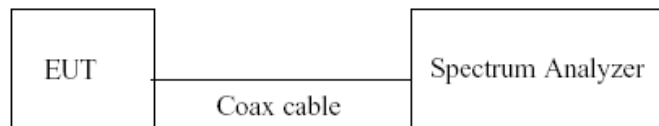
**Table 6-2. Conducted 20dB Bandwidth Measurements**



**Figure 6-1. Test Instrument & Measurement Setup**

FCC ID: IHDP56MD3		FCC Pt. 15.247 BLUETOOTH TEST REPORT (CERTIFICATION)		Reviewed by: Quality Manager
Test Report S/N: 0Y1107191263.IHD	Test Dates: 8/3/2011	EUT Type: Cellular/PCS CDMA/EvDO Phone with BT and WLAN	Page 11 of 35	



Plot 6-1. 20dB Bandwidth Plot (Bluetooth, 1Mbps – Ch. 0)



Plot 6-2. 20dB Bandwidth Plot (Bluetooth, 1Mbps – Ch. 39)



FCC ID: IHDP56MD3		FCC Pt. 15.247 BLUETOOTH TEST REPORT (CERTIFICATION)		Reviewed by: Quality Manager
Test Report S/N: 0Y1107191263.IHD	Test Dates: 8/3/2011	EUT Type: Cellular/PCS CDMA/EvDO Phone with BT and WLAN		Page 12 of 35



Plot 6-3. 20dB Bandwidth Plot (Bluetooth, 1Mbps – Ch. 78)



Plot 6-4. 20dB Bandwidth Plot (Bluetooth, 2Mbps – Ch. 0)

FCC ID: IHDP56MD3		FCC Pt. 15.247 BLUETOOTH TEST REPORT (CERTIFICATION)		Reviewed by: Quality Manager
Test Report S/N: 0Y1107191263.IHD	Test Dates: 8/3/2011	EUT Type: Cellular/PCS CDMA/EvDO Phone with BT and WLAN	Page 13 of 35	



Plot 6-5. 20dB Bandwidth Plot (Bluetooth, 2Mbps – Ch. 39)



Plot 6-6. 20dB Bandwidth Plot (Bluetooth, 2Mbps – Ch. 78)

FCC ID: IHDP56MD3		FCC Pt. 15.247 BLUETOOTH TEST REPORT (CERTIFICATION)		Reviewed by: Quality Manager
Test Report S/N: 0Y1107191263.IHD	Test Dates: 8/3/2011	EUT Type: Cellular/PCS CDMA/EvDO Phone with BT and WLAN		Page 14 of 35

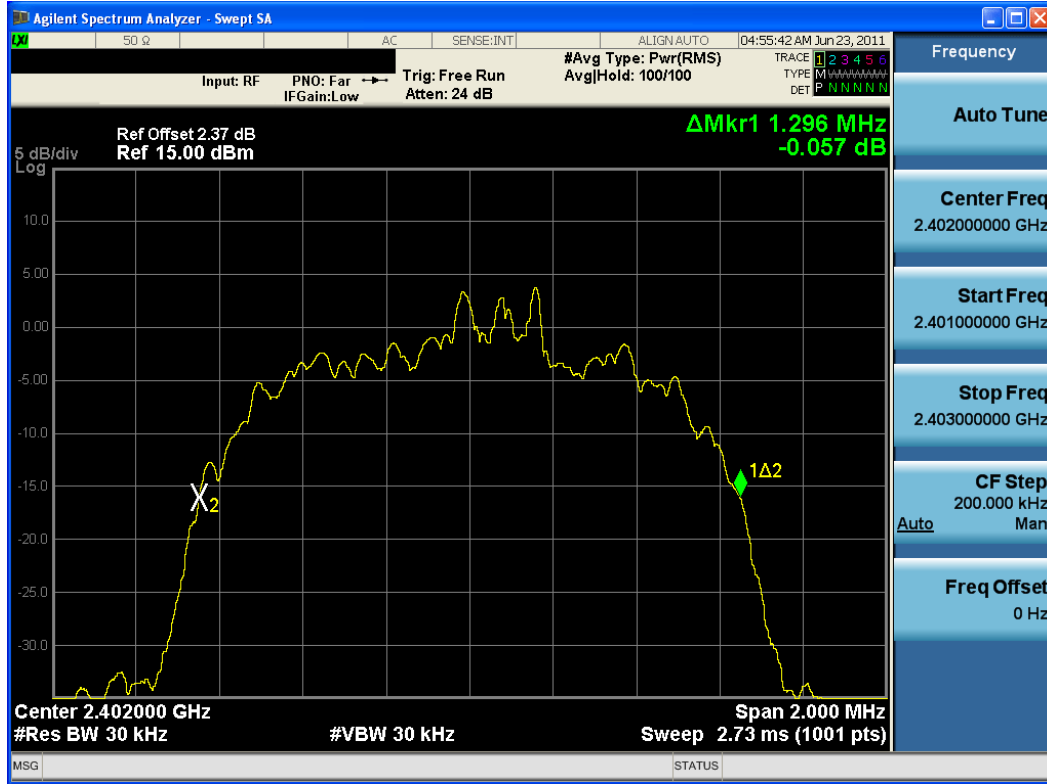

Plot 6-7. 20dB Bandwidth Plot (Bluetooth, 3Mbps – Ch. 0)

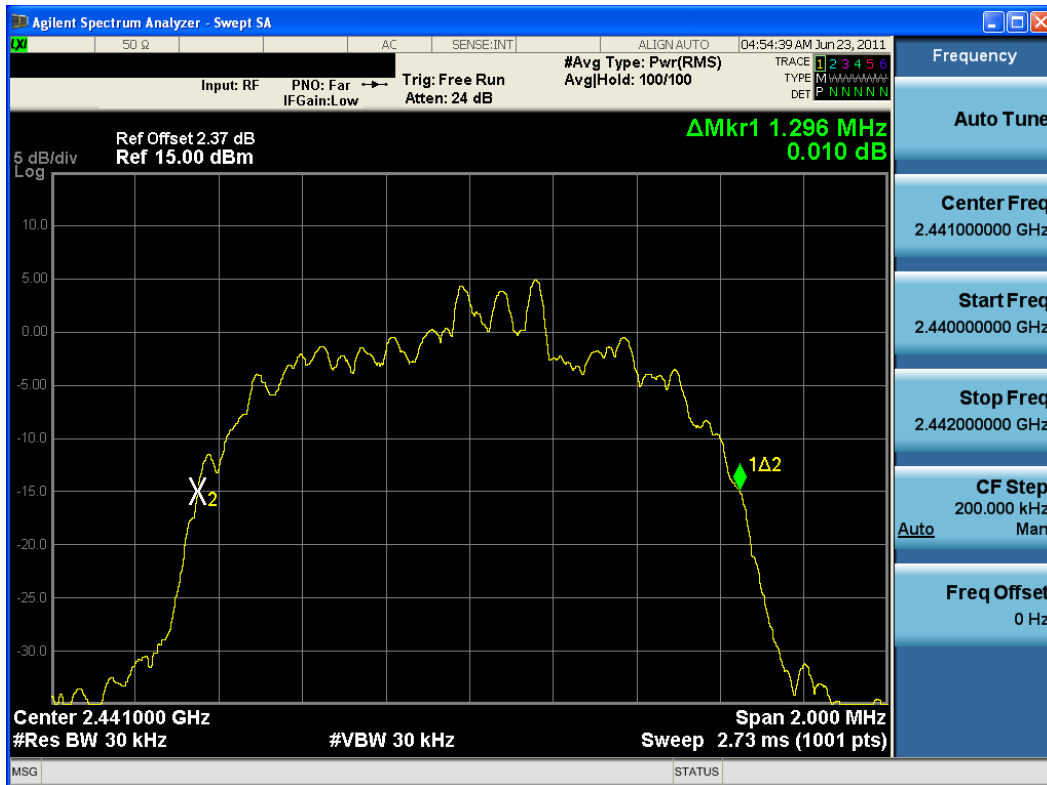



Plot 6-8. 20dB Bandwidth Plot (Bluetooth, 3Mbps – Ch. 39)

FCC ID: IHDP56MD3		FCC Pt. 15.247 BLUETOOTH TEST REPORT (CERTIFICATION)		Reviewed by: Quality Manager
Test Report S/N: 0Y1107191263.IHD	Test Dates: 8/3/2011	EUT Type: Cellular/PCS CDMA/EvDO Phone with BT and WLAN		Page 15 of 35



Plot 6-9. 20dB Bandwidth Plot (Bluetooth, 3Mbps – Ch. 78)

FCC ID: IHDP56MD3		FCC Pt. 15.247 BLUETOOTH TEST REPORT (CERTIFICATION)		Reviewed by: Quality Manager
Test Report S/N: 0Y1107191263.IHD	Test Dates: 8/3/2011	EUT Type: Cellular/PCS CDMA/EvDO Phone with BT and WLAN	Page 16 of 35	

### 6.3 Output Power Measurement

**§15.247 (b)(1); RSS-210 (A8.4 (2))**

Measurement is made while the EUT is operating in non-hopping transmission mode. The powers shown below are peak powers measured using a Bluetooth signaling test set (Agilent Model: N4010A) and a spectrum analyzer set to peak detector with RBW = VBW = 3MHz. **The maximum permissible output power is 1 Watt.**



This unit was tested with all possible data rates and the highest power is reported with the unit transmitting at 2Mbps.

Frequency [MHz]	Data Rate [Mbps]	Channel No.	Peak Conducted Power	
			[dBm]	[mW]
2402	1.0	0	8.57	7.194
2441	1.0	39	9.79	9.528
2480	1.0	78	9.05	8.035
2402	2.0	0	11.13	12.972
2441	2.0	39	12.29	16.943
2480	2.0	78	11.48	14.060
2402	3.0	0	9.06	8.054
2441	3.0	39	10.16	10.375
2480	3.0	78	9.37	8.650

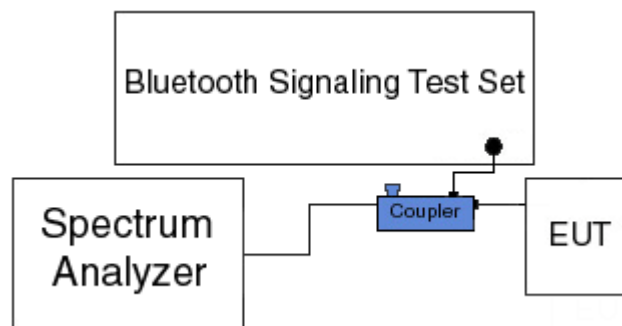
**Table 6-3. Conducted Output Power Measurements**



**Figure 6-2. Test Instrument & Measurement Setup**

FCC ID: IHDP56MD3		FCC Pt. 15.247 BLUETOOTH TEST REPORT (CERTIFICATION)		Reviewed by: Quality Manager
Test Report S/N: 0Y1107191263.IHD	Test Dates: 8/3/2011	EUT Type: Cellular/PCS CDMA/EvDO Phone with BT and WLAN	Page 17 of 35	

## 6.4 Band Edge Compliance

### §15.247 (d); RSS-210 (A8.5)

Measurement is taken at the highest point located outside of the emission bandwidth. **The maximum permissible emission level is 20 dBc. Any emission lying outside of the emission bandwidth and in a restricted band is subject to a field strength limit specified in Section 15.209 of the Title 47 CFR.**

Out of band conducted spurious emissions at the band edge were investigated for all data rates and the worst case emissions were found with the EUT transmitting at 2Mbps. Band edge emissions were also investigated with the EUT transmitting in all data rates. The worst case emissions for EDR transmission was found at 2Mbps. Plots of the worst case emissions are shown below.

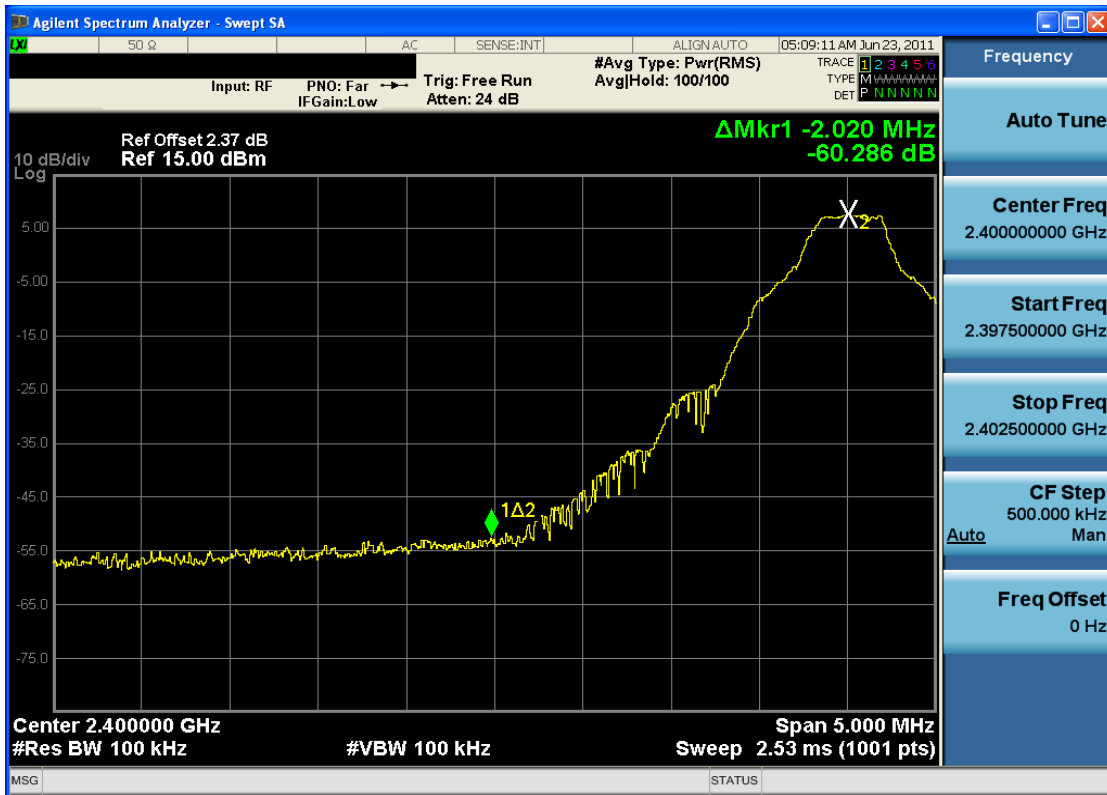

Plot 6-10. Band Edge Plot (Bluetooth, 1Mbps – Ch. 0)

FCC ID: IHDP56MD3		FCC Pt. 15.247 BLUETOOTH TEST REPORT (CERTIFICATION)		Reviewed by: Quality Manager
Test Report S/N: 0Y1107191263.IHD	Test Dates: 8/3/2011	EUT Type: Cellular/PCS CDMA/EvDO Phone with BT and WLAN		Page 18 of 35



Plot 6-11. Band Edge Plot (Bluetooth, 1Mbps – Ch. 78)

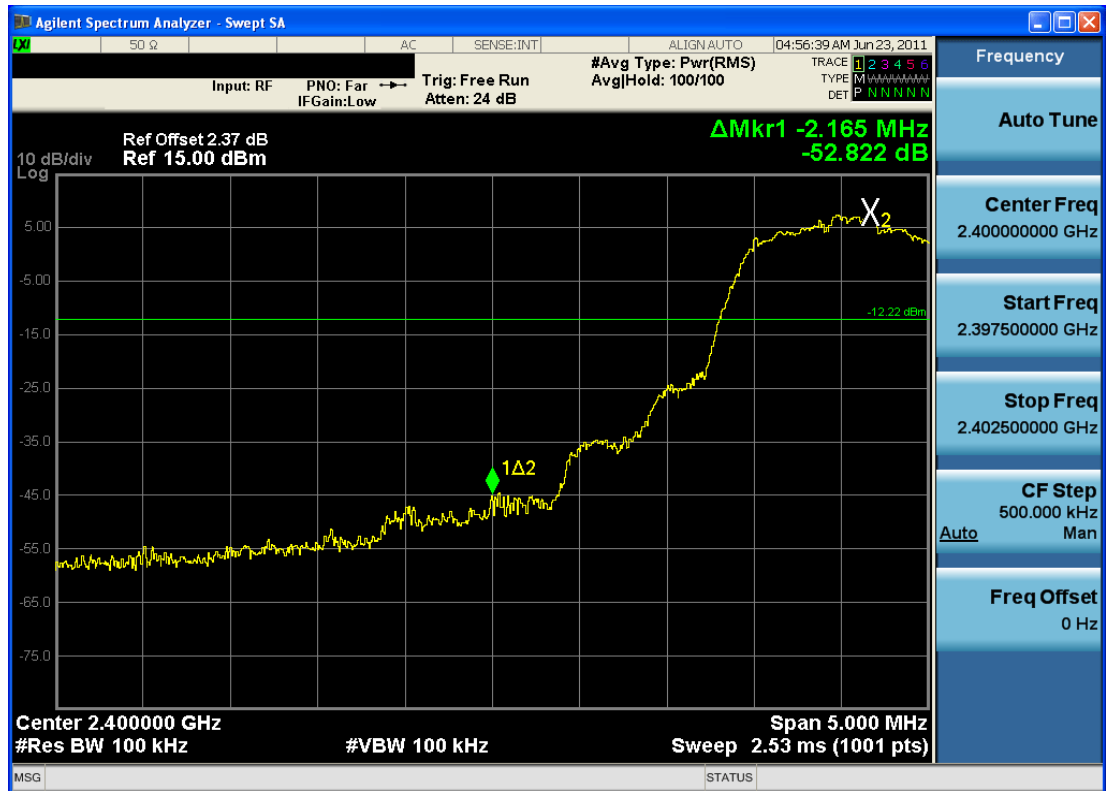

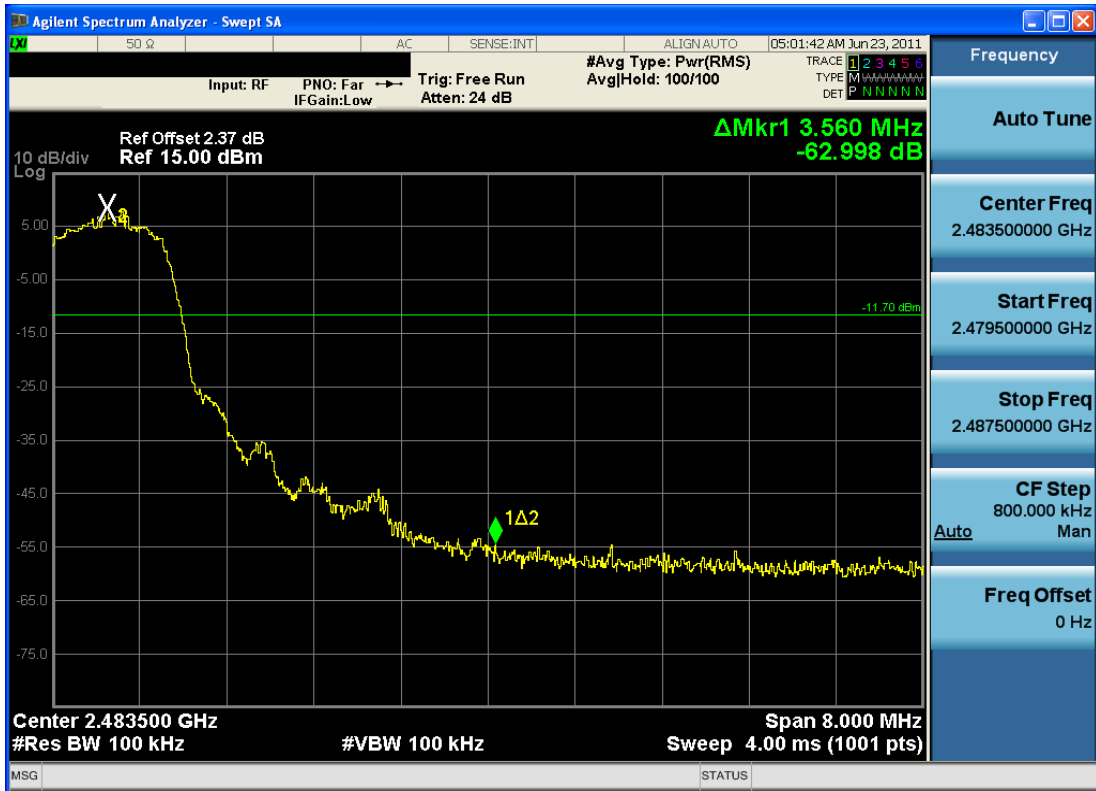

Plot 6-12. Band Edge Plot (Bluetooth, 2Mbps – Ch. 0)

FCC ID: IHDP56MD3	PCTEST ENGINEERING LABORATORY, INC.	FCC Pt. 15.247 BLUETOOTH TEST REPORT (CERTIFICATION)		Reviewed by: Quality Manager
Test Report S/N: 0Y1107191263.IHD	Test Dates: 8/3/2011	EUT Type: Cellular/PCS CDMA/EvDO Phone with BT and WLAN		Page 19 of 35



Plot 6-13. Band Edge Plot (Bluetooth, 2Mbps – Ch. 78)

FCC ID: IHDP56MD3		FCC Pt. 15.247 BLUETOOTH TEST REPORT (CERTIFICATION)		Reviewed by: Quality Manager
Test Report S/N: 0Y1107191263.IHD	Test Dates: 8/3/2011	EUT Type: Cellular/PCS CDMA/EvDO Phone with BT and WLAN	Page 20 of 35	

## 6.5 Carrier Frequency Separation

### §15.247 (a)(1); RSS-210 (A8.1 (2))

Measurement is made with EUT operating in hopping mode. *The minimum permissible channel separation for this system is 2/3 the value of the 20dB BW.*

Frequency [MHz]	Data Rate [Mbps]	Channel No.	Min. Channel Separation [MHz]
2402	1.0	0	0.677
2441	1.0	39	0.680
2480	1.0	78	0.639
2402	2.0	0	0.883
2441	2.0	39	0.877
2480	2.0	78	0.885
2402	3.0	0	0.864
2441	3.0	39	0.864
2480	3.0	78	0.868

Table 6-4. Minimum Channel Separation

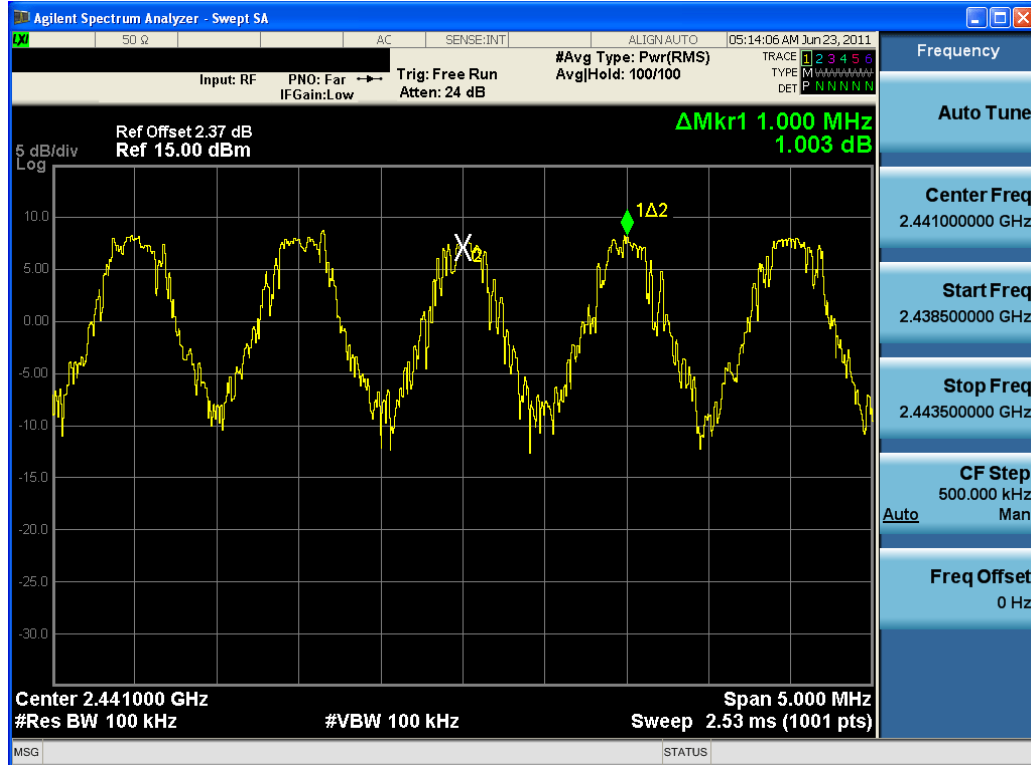

Plot 6-14. Channel Spacing Plot (Bluetooth)

FCC ID: IHDP56MD3		FCC Pt. 15.247 BLUETOOTH TEST REPORT (CERTIFICATION)		Reviewed by: Quality Manager
Test Report S/N: 0Y1107191263.IHD	Test Dates: 8/3/2011	EUT Type: Cellular/PCS CDMA/EvDO Phone with BT and WLAN		Page 21 of 35

## 6.6 Time of Occupancy

**§15.247 (a)(1)(iii); RSS-210 (A8.1 (4))**

Measurement is made while EUT is operating in hopping mode with the spectrum analyzer set to zero span. *The maximum permissible time of occupancy is 400 ms within a period of 400ms multiplied by the number of hopping channels employed.*

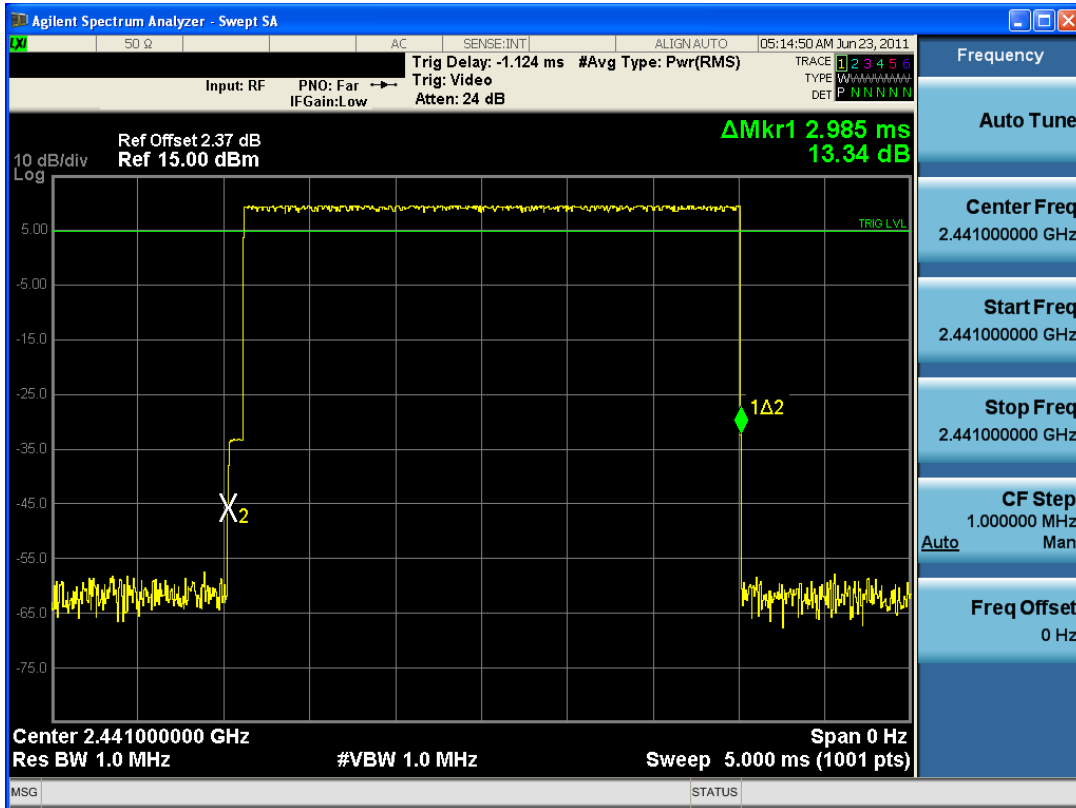

**Plot 6-15. Time of Occupancy Plot (Bluetooth)**

### Sample Calculation

Time of Occupancy for one pulse width = 2ms.

- 400ms x 79 hopping channels = 31.6sec
- 2ms x 79 hopping channels = 158ms (total duration of all channels)
- 31.6sec / 158ms = 200 (number of times one channel transmits within a 31.6sec time frame)
- 200 x 2ms = 400ms (total duration of time that one channel transmits within a 31.6sec time frame)

FCC ID: IHDP56MD3		FCC Pt. 15.247 BLUETOOTH TEST REPORT (CERTIFICATION)		Reviewed by: Quality Manager
Test Report S/N: 0Y1107191263.IHD	Test Dates: 8/3/2011	EUT Type: Cellular/PCS CDMA/EvDO Phone with BT and WLAN		Page 22 of 35

## 6.7 Number of Hopping Channels

§15.247 (a)(1)(iii); RSS-210 (A8.1 (4))

Measurement is made while EUT is operating in hopping mode. *This frequency hopping system must employ a minimum of 15 hopping channels.*

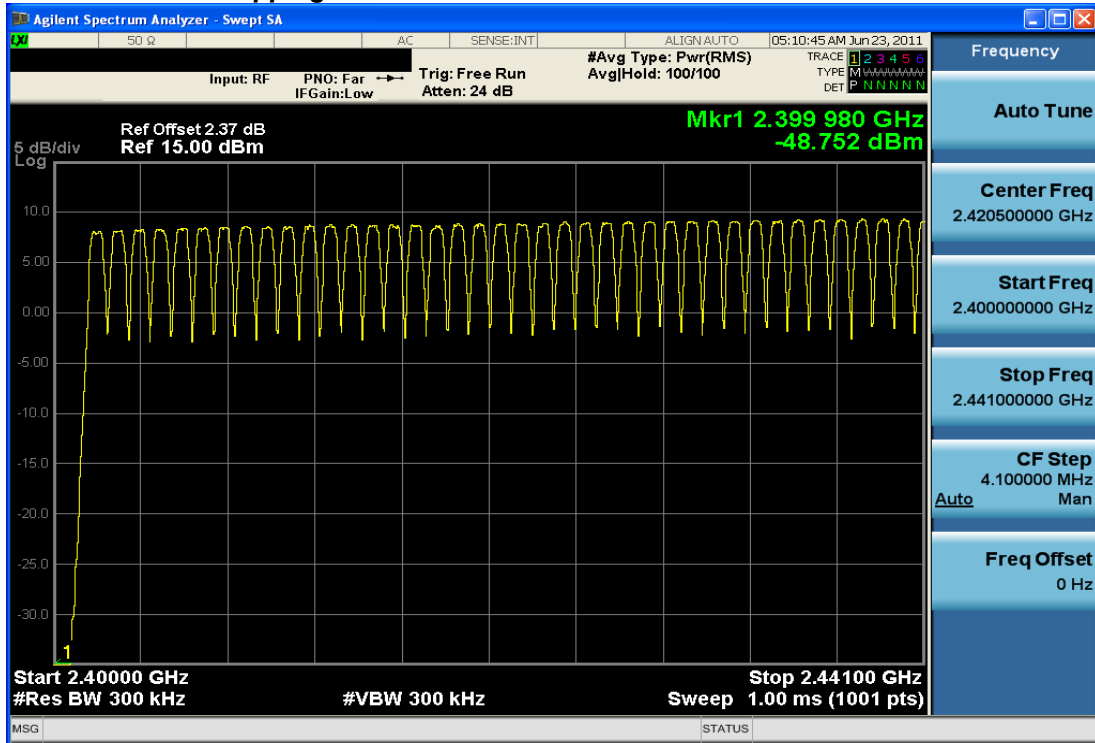

Plot 6-16. Low End Spectrum Channel Hopping Plot (Bluetooth)

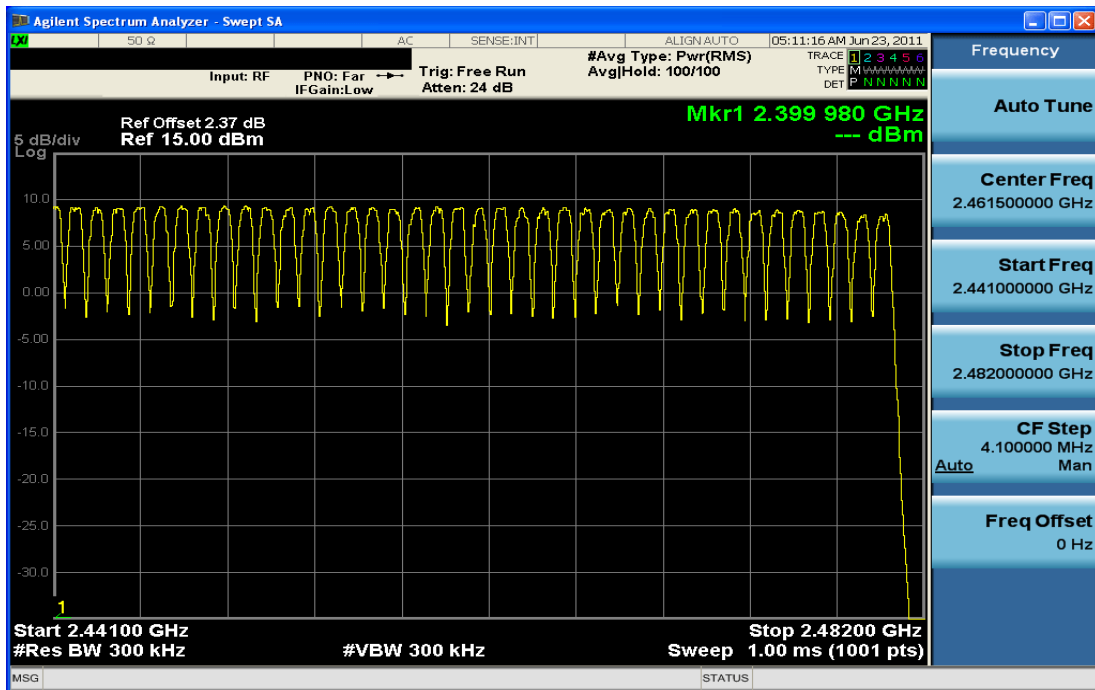

Plot 6-17. High End Spectrum Channel Hopping Plot (Bluetooth)

FCC ID: IHDP56MD3		FCC Pt. 15.247 BLUETOOTH TEST REPORT (CERTIFICATION)		Reviewed by: Quality Manager
Test Report S/N: 0Y1107191263.IHD	Test Dates: 8/3/2011	EUT Type: Cellular/PCS CDMA/EvDO Phone with BT and WLAN		Page 23 of 35

## 6.8 Conducted Spurious Emissions

### §15.247 (d)

Out of band conducted spurious emissions were investigated for all data rates and the worst case emissions were found with the EUT transmitting at 2Mbps. Plots of the worst case emissions are shown below.

The display line shown in the following plots denotes the limit at 20dB below the fundamental emission level measured in a 100kHz bandwidth. However, since the traces in the following plots are measured with a 1MHz RBW, the display line may not necessarily appear to be 20dB below the level of the fundamental in a 1MHz bandwidth.

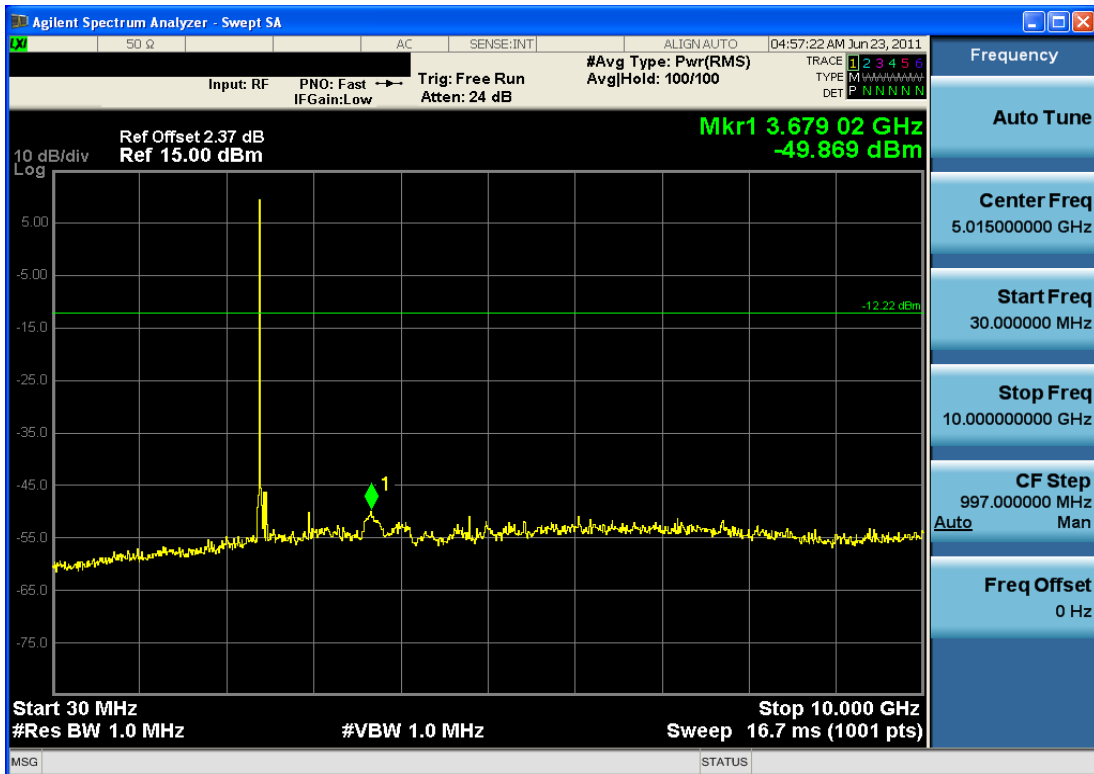

Plot 6-18. Conducted Spurious Plot (Bluetooth, 2Mbps – Ch. 0)

FCC ID: IHDP56MD3		FCC Pt. 15.247 BLUETOOTH TEST REPORT (CERTIFICATION)		Reviewed by: Quality Manager
Test Report S/N: 0Y1107191263.IHD	Test Dates: 8/3/2011	EUT Type: Cellular/PCS CDMA/EvDO Phone with BT and WLAN		Page 24 of 35



Plot 6-19. Conducted Spurious Plot (Bluetooth, 2Mbps – Ch. 0)

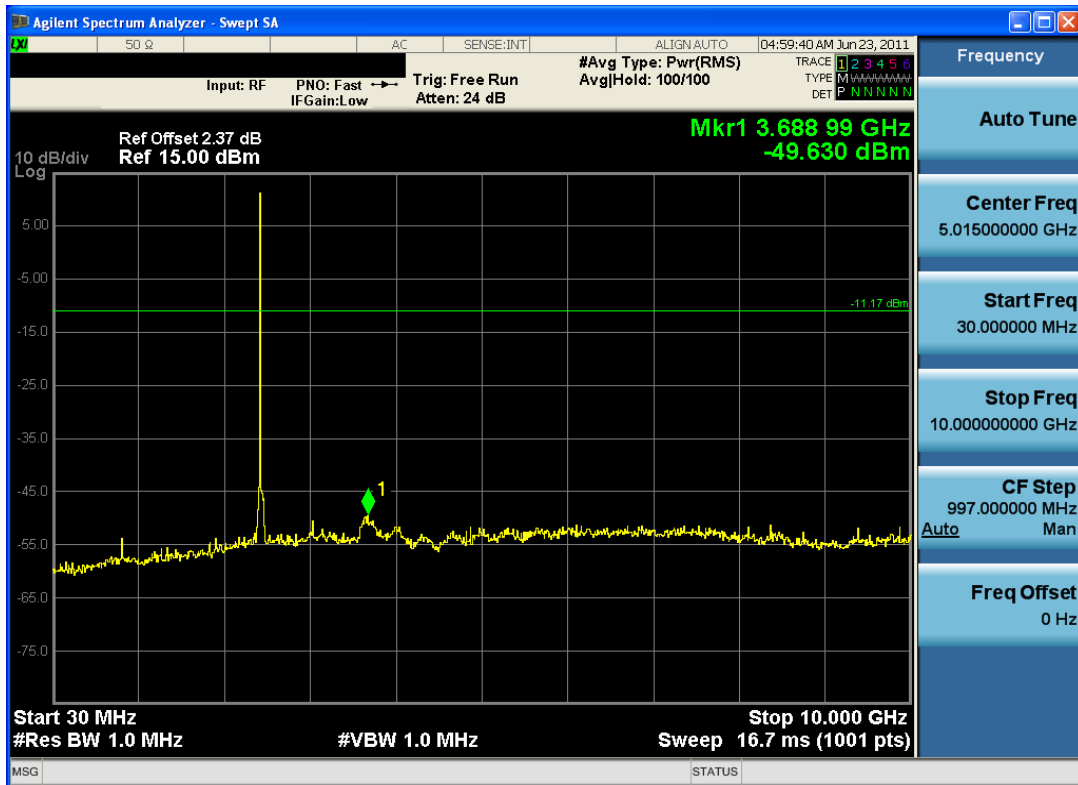

Plot 6-20. Conducted Spurious Plot (Bluetooth, 2Mbps – Ch. 39)

FCC ID: IHDP56MD3		FCC Pt. 15.247 BLUETOOTH TEST REPORT (CERTIFICATION)		Reviewed by: Quality Manager
Test Report S/N: 0Y1107191263.IHD	Test Dates: 8/3/2011	EUT Type: Cellular/PCS CDMA/EvDO Phone with BT and WLAN		Page 25 of 35

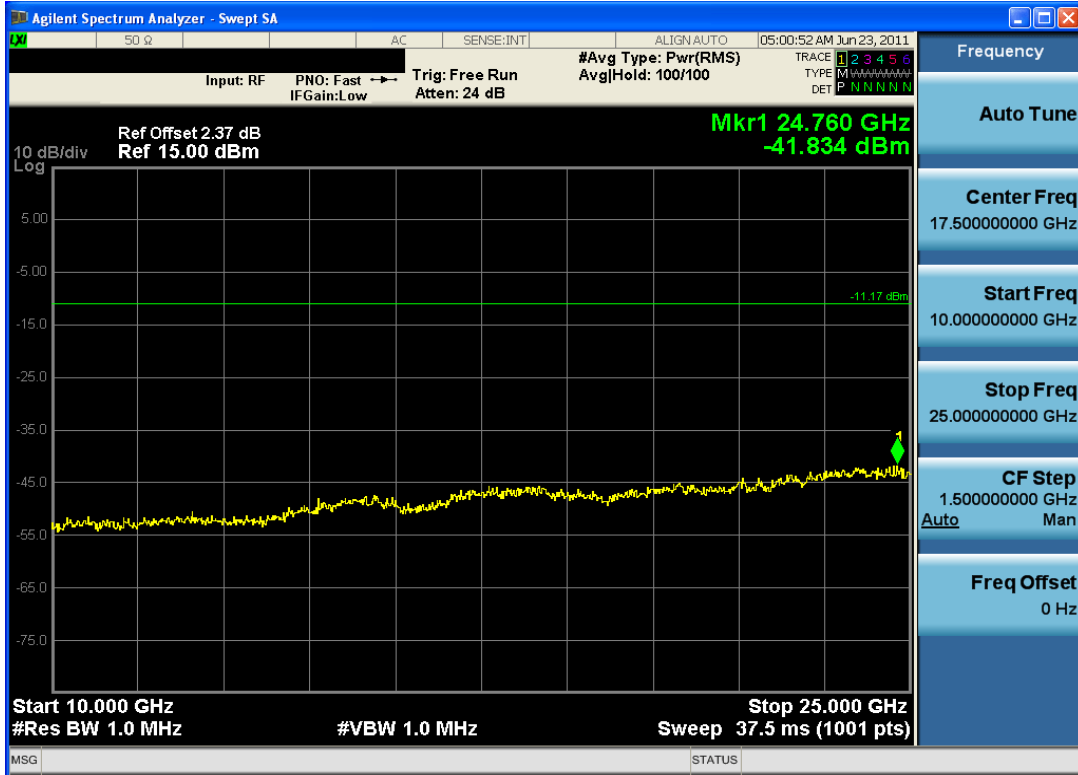

Plot 6-21. Conducted Spurious Plot (Bluetooth, 2Mbps – Ch. 39)

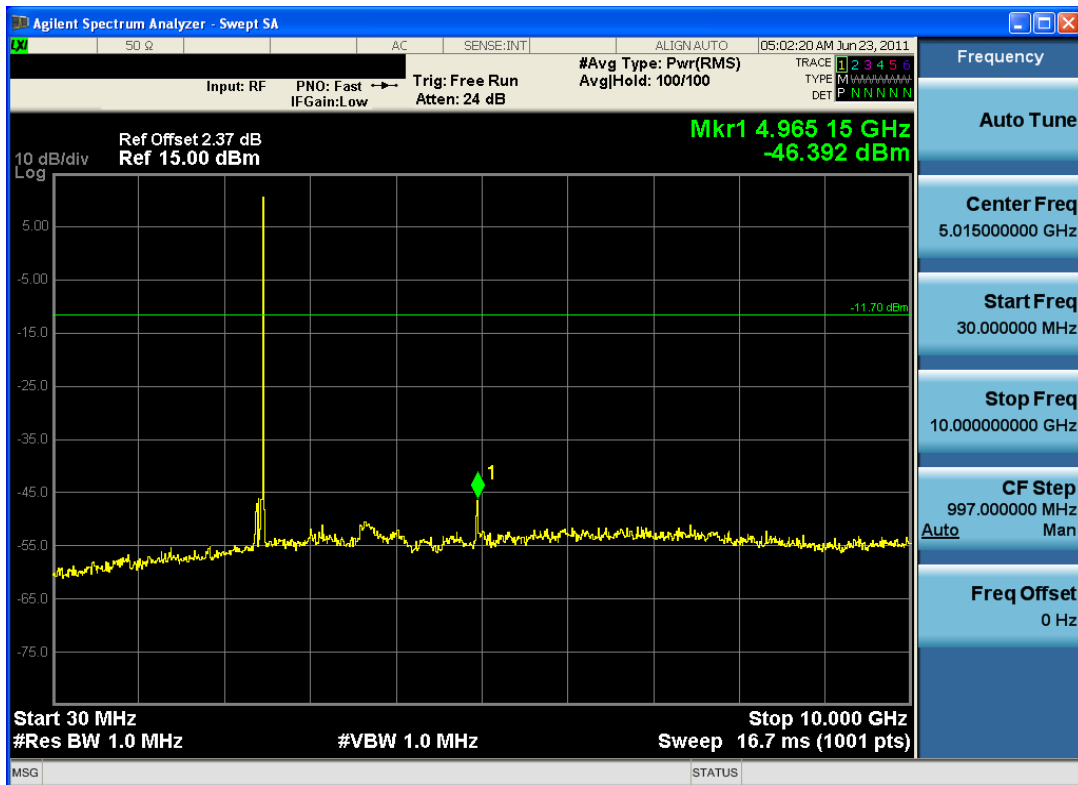



Plot 6-22. Conducted Spurious Plot (Bluetooth, 2Mbps – Ch. 78)

FCC ID: IHDP56MD3		FCC Pt. 15.247 BLUETOOTH TEST REPORT (CERTIFICATION)		Reviewed by: Quality Manager
Test Report S/N: 0Y1107191263.IHD	Test Dates: 8/3/2011	EUT Type: Cellular/PCS CDMA/EvDO Phone with BT and WLAN		Page 26 of 35



Plot 6-23. Conducted Spurious Plot (Bluetooth, 2Mbps – Ch. 78)

FCC ID: IHDP56MD3		FCC Pt. 15.247 BLUETOOTH TEST REPORT (CERTIFICATION)		Reviewed by: Quality Manager
Test Report S/N: 0Y1107191263.IHD	Test Dates: 8/3/2011	EUT Type: Cellular/PCS CDMA/EvDO Phone with BT and WLAN	Page 27 of 35	

## 6.9 Radiated Spurious Emission Measurements

**§15.205 & §15.209, §15.247 (d); RSS-210 (A8.5)**

The EUT was tested from 9kHz and up to the 10<sup>th</sup> harmonic of the fundamental frequency of the transmitter using CISPR quasi peak detector below 1GHz. Above 1 GHz, average measurement was used, using RBW = 1MHz, VBW = 1KHz  $\geq 1/\tau$  Hz, where  $\tau$  is the Bluetooth pulse width in seconds, and linearly polarized horn antennas. All out of band emissions appearing in a restricted band as specified in Section 15.205 of the Title 47 CFR must not exceed the limits shown in Table 6-5 per Section 15.209. This unit was tested with all possible data rates and the highest power is reported with the unit transmitting at 2Mbps. No significant radiated emissions were found in the 2310 - 2390MHz restricted band.

Frequency	Field Strength [ $\mu$ V/m]	Measured Distance [Meters]
0.009 – 0.490 MHz	2400/F (kHz)	300
0.490 – 1.705 MHz	24000/F (kHz)	30
1.705 – 30.00 MHz	30	30
30.00 – 88.00 MHz	100	3
88.00 – 216.0 MHz	150	3
216.0 – 960.0 MHz	200	3
Above 960.0 MHz	500	3



**Table 6-5. Radiated Limits**

### Sample Calculation

- Field Strength Level [ $\text{dB}_{\mu\text{V/m}}$ ] = Analyzer Level [ $\text{dBm}$ ] + 107 + AFCL [ $\text{dB}$ ] + Duty Cycle Correction [ $\text{dB}$ ]

### Notes:

- AFCL = Antenna Factor [ $\text{dB}$ ] + Cable Loss [ $\text{dB}$ ]
- Duty Cycle Correction Factor Calculation:
  - Time to cycle through all channels =  $\Delta t = \tau_{[\text{ms}]} \times 79$  channels, where  $\tau$  = pulse width
  - $100\text{ms} / \Delta t_{[\text{ms}]} = H \rightarrow$  Round up to next highest integer, to account for worst case,  $H'$
  - Worst Case Dwell Time =  $\tau_{[\text{ms}]} \times H'$
  - Duty Cycle Correction =  $20\log(\text{Worst Case Dwell Time}/100\text{ms})$  [ $\text{dB}$ ]

FCC ID: IHDP56MD3		FCC Pt. 15.247 BLUETOOTH TEST REPORT (CERTIFICATION)		Reviewed by: Quality Manager
Test Report S/N: 0Y1107191263.IHD	Test Dates: 8/3/2011	EUT Type: Cellular/PCS CDMA/EvDO Phone with BT and WLAN	Page 28 of 35	

## Radiated Spurious Emission Measurements (Cont'd)

§15.205 & §15.209, §15.247 (d); RSS-210 (A8.5)

Mode: Bluetooth

Measurement Distance: 3 Meters

Operating Frequency: 2402MHz



Channel: 0

Frequency [MHz]	Analyzer Level [dBm]	Detector	Pol [H/V]	AFCL [dB]	Field Strength [dB $\mu$ V/m]	Limit [dB $\mu$ V/m]	Margin [dB]
4804.00	-111.92	Avg	V	42.96	38.04	53.98	-15.93
4804.00	-102.89	Peak	V	42.96	47.07	73.98	-26.90
12010.00	-135.00	Avg	V	63.15	35.15	53.98	-18.83
12010.00	-125.00	Peak	V	63.15	45.15	73.98	-28.83

**Table 6-6. Radiated Measurements**

### NOTES:

- All emissions shown lie in the restricted bands specified in §15.205 and are below the limit shown in Table 6-5.
- Average measurements > 1GHz using RBW = 1MHz and VBW = 1KHz  $\geq 1/\tau$  Hz, where  $\tau$  = pulse width in seconds. Peak measurements > 1GHz using RBW = VBW = 1MHz.
- The antenna is manipulated through typical positions, polarity and length during the tests. The EUT is manipulated through three orthogonal planes.
- The EUT is supplied with nominal AC voltage and/or a new/fully-recharged battery.
- The spectrum is measured from 9kHz to the 10<sup>th</sup> harmonic and the worst-case emissions are reported. No significant emissions were found beyond the fifth harmonic for this device.
- Levels at - 135 dBm represent the analyzer noise floor and signify that no emission was detected.
- Above 960MHz the limit is 500  $\mu$ V/m (54dB $\mu$ /m) at 3 meters radiated.

FCC ID: IHDP56MD3		FCC Pt. 15.247 BLUETOOTH TEST REPORT (CERTIFICATION)		Reviewed by: Quality Manager
Test Report S/N: 0Y1107191263.IHD	Test Dates: 8/3/2011	EUT Type: Cellular/PCS CDMA/EvDO Phone with BT and WLAN	Page 29 of 35	

**Radiated Spurious Emission Measurements (Cont'd)**  
**§15.205 & §15.209, §15.247 (d); RSS-210 (A8.5)**

Mode: Bluetooth

Measurement Distance: 3 Meters

Operating Frequency: 2441MHz



Channel: 39

Frequency [MHz]	Analyzer Level [dBm]	Detector	Pol [H/V]	AFCL [dB]	Field Strength [dBμV/m]	Limit [dBμV/m]	Margin [dB]
4882.00	-112.10	Avg	V	43.20	38.10	53.98	-15.87
4882.00	-102.60	Peak	V	43.20	47.60	73.98	-26.37
7323.00	-135.00	Avg	V	50.15	22.15	53.98	-31.83
7323.00	-125.00	Peak	V	50.15	32.15	73.98	-41.83
12205.00	-135.00	Avg	V	64.28	36.28	53.98	-17.70
12205.00	-125.00	Peak	V	64.28	46.28	73.98	-27.70

**Table 6-7. Radiated Measurements**

**NOTES:**

- All emissions shown lie in the restricted bands specified in §15.205 and are below the limit shown in Table 6-5.
- Average measurements > 1GHz using RBW = 1MHz and VBW = 1KHz  $\geq 1/\tau$  Hz, where  $\tau$  = pulse width in seconds. Peak measurements > 1GHz using RBW = VBW = 1MHz.
- The antenna is manipulated through typical positions, polarity and length during the tests. The EUT is manipulated through three orthogonal planes.
- The EUT is supplied with nominal AC voltage and/or a new/fully-recharged battery.
- The spectrum is measured from 9kHz to the 10<sup>th</sup> harmonic and the worst-case emissions are reported. No significant emissions were found beyond the fifth harmonic for this device.
- Levels at - 135 dBm represent the analyzer noise floor and signify that no emission was detected.
- Above 960MHz the limit is 500 μV/m (54dBμ/m) at 3 meters radiated.

FCC ID: IHDP56MD3		FCC Pt. 15.247 BLUETOOTH TEST REPORT (CERTIFICATION)		Reviewed by: Quality Manager
Test Report S/N: 0Y1107191263.IHD	Test Dates: 8/3/2011	EUT Type: Cellular/PCS CDMA/EvDO Phone with BT and WLAN	Page 30 of 35	

## Radiated Spurious Emission Measurements (Cont'd)

§15.205 & §15.209, §15.247 (d); RSS-210 (A8.5)

Mode: Bluetooth

Measurement Distance: 3 Meters

Operating Frequency: 2480MHz



Channel: 78

Frequency [MHz]	Analyzer Level [dBm]	Detector	Pol [H/V]	AFCL [dB]	Field Strength [dBμV/m]	Limit [dBμV/m]	Margin [dB]
4960.00	-112.02	Avg	V	43.52	38.50	53.98	-15.48
4960.00	-101.97	Peak	V	43.52	48.55	73.98	-25.43
7440.00	-135.00	Avg	V	50.26	22.26	53.98	-31.72
7440.00	-125.00	Peak	V	50.26	32.26	73.98	-41.72
12400.00	-135.00	Avg	V	64.53	36.53	53.98	-17.45
12400.00	-125.00	Peak	V	64.53	46.53	73.98	-27.45

**Table 6-8. Radiated Measurements**

**NOTES:**

- All emissions shown lie in the restricted bands specified in §15.205 and are below the limit shown in Table 6-5.
- Average measurements > 1GHz using RBW = 1MHz and VBW = 1KHz  $\geq 1/\tau$  Hz, where  $\tau$  = pulse width in seconds. Peak measurements > 1GHz using RBW = VBW = 1MHz.
- The antenna is manipulated through typical positions, polarity and length during the tests. The EUT is manipulated through three orthogonal planes.
- The EUT is supplied with nominal AC voltage and/or a new/fully-recharged battery.
- The spectrum is measured from 9kHz to the 10<sup>th</sup> harmonic and the worst-case emissions are reported. No significant emissions were found beyond the fifth harmonic for this device.
- Levels at - 135 dBm represent the analyzer noise floor and signify that no emission was detected.
- Above 960MHz the limit is 500 μV/m (54dBμ/m) at 3 meters radiated.

FCC ID: IHDP56MD3		FCC Pt. 15.247 BLUETOOTH TEST REPORT (CERTIFICATION)		Reviewed by: Quality Manager
Test Report S/N: 0Y1107191263.IHD	Test Dates: 8/3/2011	EUT Type: Cellular/PCS CDMA/EvDO Phone with BT and WLAN	Page 31 of 35	

## 6.10 Radiated Restricted Band Edge Measurements

§15.205 & §15.209, §15.247 (d); RSS-210 (A8.5)

Mode: Bluetooth

Measurement Distance: 3 Meters

Operating Frequency: 2480MHz



Channel: 78

Frequency [MHz]	Analyzer Level [dBm]	Detector	Pol [H/V]	AFCL [dB]	Field Strength [dB $\mu$ V/m]	Limit [dB $\mu$ V/m]	Margin [dB]
2484.28	-112.05	Avg	V	36.62	31.58	53.98	-22.40
2484.28	-108.68	Peak	V	36.62	34.95	73.98	-39.03
2483.91	-110.30	Avg	V	36.62	33.33	53.98	-20.65
2483.91	-106.83	Peak	V	36.62	36.80	73.98	-37.18
2483.50	-106.17	Avg	V	36.62	37.46	53.98	-16.52
2483.50	-102.71	Peak	V	36.62	40.92	73.98	-33.06

**Table 6-9. Radiated Restricted Band Edge Measurements at 3-meters**

**NOTES:**

- All emissions shown lie in the restricted bands specified in §15.205 and are below the limit shown in Table 6-5.
- Average measurements > 1GHz using RBW = 1MHz and VBW = 1KHz  $\geq 1/\tau$  Hz, where  $\tau$  = pulse width in seconds. Peak measurements > 1GHz using RBW = VBW = 1MHz.
- The antenna is manipulated through typical positions, polarity and length during the tests. The EUT is manipulated through three orthogonal planes.
- The EUT is supplied with nominal AC voltage and/or a new/fully-recharged battery.
- The spectrum is measured from 9kHz to the 10<sup>th</sup> harmonic and the worst-case emissions are reported. No significant emissions were found beyond the fifth harmonic for this device.
- Levels at - 135 dBm represent the analyzer noise floor and signify that no emission was detected.
- Above 960MHz the limit is 500  $\mu$ V/m (54dB $\mu$ /m) at 3 meters radiated.

FCC ID: IHDP56MD3		FCC Pt. 15.247 BLUETOOTH TEST REPORT (CERTIFICATION)		Reviewed by: Quality Manager
Test Report S/N: 0Y1107191263.IHD	Test Dates: 8/3/2011	EUT Type: Cellular/PCS CDMA/EvDO Phone with BT and WLAN	Page 32 of 35	

**6.11 Line-Conducted Test Data**  
**§15.207; RSS-Gen (7.2.2)**

# PCTEST Engineering Laboratory Inc.

Company : Motorola Mobility, Inc.  
 FCC ID Code : IHDP56MD3  
 Standard : FCC Part 15C, 15.207

Power Source : AC120V/60Hz  
 Tested Date : 08/03/2011  
 Note : Tested with Bluetooth ON

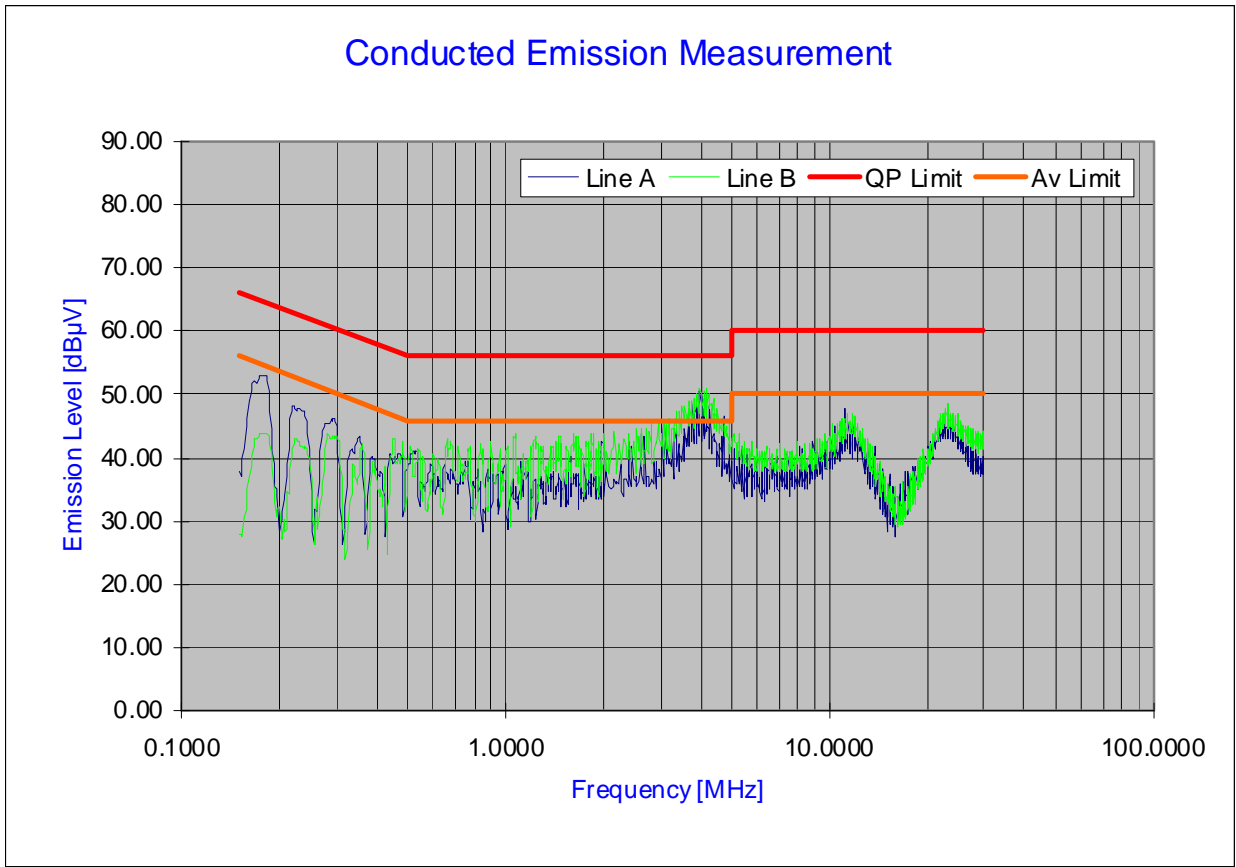



Ver.1.1 ©PCTEST 2006.08

**Plot 6-24. Line Conducted Plot with Bluetooth**

**Notes:**

1. All modes of operation were investigated and the worst-case emissions are reported with a 2Mbps data rate.
2. The limit for Class B device(s) from 150kHz to 30MHz are specified in Section 15.207 of the Title 47 CFR.
3. Line A = Phase; Line B = Neutral
4. Traces shown in plot are made using a peak detector.
5. Deviations to the Specifications: None.

<b>FCC ID:</b> IHDP56MD3		<b>FCC Pt. 15.247 BLUETOOTH TEST REPORT (CERTIFICATION)</b>		<b>Reviewed by:</b> Quality Manager
<b>Test Report S/N:</b> 0Y1107191263.IHD	<b>Test Dates:</b> 8/3/2011	<b>EUT Type:</b> Cellular/PCS CDMA/EvDO Phone with BT and WLAN		Page 33 of 35



**Line-Conducted Test Data (Cont'd)**  
**§15.207; RSS-Gen (7.2.2)**

No.	Line	Frequency [MHz]	Factor [dB]	QP [dBμV]	Limit [dBμV]	Margin [dB]	Average [dBμV]	Limit [dBμV]	Margin [dB]
1	A	0.178	6.86	46.30	64.57	-18.27	33.73	54.57	-20.84
2	A	2.656	7.23	36.10	56.00	-19.90	23.43	46.00	-22.57
3	A	3.132	7.28	37.92	56.00	-18.08	25.13	46.00	-20.87
4	A	3.309	7.29	39.42	56.00	-16.58	25.32	46.00	-20.68
5	A	3.789	7.33	39.72	56.00	-16.28	29.08	46.00	-16.92
6	A	3.934	7.34	42.60	56.00	-13.40	29.60	46.00	-16.40
7	A	3.953	7.34	43.10	56.00	-12.90	29.49	46.00	-16.51
8	A	4.246	7.36	40.84	56.00	-15.16	28.82	46.00	-17.18
9	A	4.616	7.39	37.27	56.00	-18.73	26.07	46.00	-19.93
10	A	11.216	7.69	39.02	60.00	-20.98	29.22	50.00	-20.78
11	B	2.975	7.27	41.20	56.00	-14.80	27.50	46.00	-18.50
12	B	3.128	7.28	40.73	56.00	-15.27	29.44	46.00	-16.56
13	B	3.371	7.31	42.10	56.00	-13.90	28.47	46.00	-17.53
14	B	3.510	7.32	42.58	56.00	-13.42	28.73	46.00	-17.27
15	B	3.512	7.32	42.81	56.00	-13.19	28.85	46.00	-17.15
16	B	3.758	7.34	43.90	56.00	-12.10	30.82	46.00	-15.18
17	B	3.926	7.35	45.07	56.00	-10.93	32.46	46.00	-13.54
18	B	3.984	7.36	44.99	56.00	-11.01	33.06	46.00	-12.94
19	B	4.647	7.40	39.90	56.00	-16.10	27.30	46.00	-18.70
20	B	4.944	7.42	39.04	56.00	-16.96	26.53	46.00	-19.47

**Table 6-10. Line Conducted Data with Bluetooth**



**Notes:**

1. All modes of operation were investigated and the worst-case emissions are reported with a 2Mbps data rate.
2. The limit for Class B device(s) from 150kHz to 30MHz are specified in Section 15.207 of the Title 47 CFR.
3. Line A = Phase; Line B = Neutral
4. Traces shown in plot are made using a peak detector.
5. Deviations to the Specifications: None.

FCC ID: IHDP56MD3		FCC Pt. 15.247 BLUETOOTH TEST REPORT (CERTIFICATION)		Reviewed by: Quality Manager
Test Report S/N: 0Y1107191263.IHD	Test Dates: 8/3/2011	EUT Type: Cellular/PCS CDMA/EvDO Phone with BT and WLAN	Page 34 of 35	

## 7.0 CONCLUSION

The data collected relate only to the item(s) tested and show that the **Motorola Cellular/PCS CDMA/EvDO Phone with BT and WLAN FCC ID: IHDP56MD3** is in compliance with Part 15 Subpart C (15.247) of the FCC Rules and RSS-210 of the Industry Canada Rules.

FCC ID: IHDP56MD3		FCC Pt. 15.247 BLUETOOTH TEST REPORT (CERTIFICATION)		Reviewed by: Quality Manager
Test Report S/N: 0Y1107191263.IHD	Test Dates: 8/3/2011	EUT Type: Cellular/PCS CDMA/EvDO Phone with BT and WLAN		Page 35 of 35