



FCC 47 CFR PART 22 SUBPART H AND PART 24 SUBPART E

TEST REPORT

For

Mobile Phone

Model: W418G, WX345

Trade Name: MOTOROLA

Issued to

**Motorola Inc.
600 N. U.S. Highway 45 Libertyville,
Illinois United states 60048-5343**

Issued by

**Compliance Certification Services Inc.
No. 11, Wu-Gong 6th Rd., Wugu Industrial Park,
Taipei Hsien 248, Taiwan (R.O.C.)
<http://www.ccsrf.com>
service@ccsrf.com**



***Note:** This report shall not be reproduced except in full, without the written approval of Compliance Certification Services Inc. This document may be altered or revised by Compliance Certification Services Inc. personnel only, and shall be noted in the revision section of the document.*



TABLE OF CONTENTS

- 1. TEST RESULT CERTIFICATION..... 3**
- 2. EUT DESCRIPTION 4**
- 3. TEST METHODOLOGY 5**
 - 3.1 EUT CONFIGURATION 5
 - 3.2 EUT EXERCISE 5
 - 3.3 GENERAL TEST PROCEDURES 5
 - 3.4 DESCRIPTION OF TEST MODES 6
- 4. INSTRUMENT CALIBRATION..... 7**
 - 4.1 MEASURING INSTRUMENT CALIBRATION 7
 - 4.2 MEASUREMENT EQUIPMENT USED 8
 - 4.3 MEASUREMENT UNCERTAINTY 9
- 5. FACILITIES AND ACCREDITATIONS 10**
 - 5.1 FACILITIES 10
 - 5.2 EQUIPMENT 10
 - 5.3 TABLE OF ACCREDITATIONS AND LISTINGS 11
- 6. SETUP OF EQUIPMENT UNDER TEST 12**
 - 6.1 SETUP CONFIGURATION OF EUT 12
 - 6.2 SUPPORT EQUIPMENT 12
- 7. FCC PART 22 & 24 REQUIREMENTS 13**
 - 7.1 PEAK POWER..... 13
 - 7.2 AVERAGE POWER..... 15
 - 7.1 ERP & EIRP MEASUREMENT 17
 - 7.2 OCCUPIED BANDWIDTH MEASUREMENT 23
 - 7.3 OUT OF BAND EMISSION AT ANTENNA TERMINALS 31
 - 7.4 FIELD STRENGTH OF SPURIOUS RADIATION MEASUREMENT 43
 - 7.5 FREQUENCY STABILITY V.S. TEMPERATURE MEASUREMENT 69
 - 7.6 FREQUENCY STABILITY V.S. VOLTAGE MEASUREMENT 72
 - 7.7 POWERLINE CONDUCTED EMISSIONS 75
- APPENDIX I RADIO FREQUENCY EXPOSURE..... 80**
- APPENDIX II PHOTOGRAPHS OF TEST SETUP 82**
- APPENDIX 1 - PHOTOGRAPHS OF EUT**



1. TEST RESULT CERTIFICATION

Applicant: Motorola Inc.
600 N. U.S. Highway 45 Libertyville,
Illinois United states 60048-5343

Equipment Under Test: Mobile Phone

Trade Name: MOTOROLA

Model Number: W418G, WX345

Date of Test: May 21 ~ 24, 2010

APPLICABLE STANDARDS	
STANDARD	TEST RESULT
FCC 47 CFR Part 22 Subpart H & Part 24 Subpart E	No non-compliance noted

We hereby certify that:

The above equipment was tested by Compliance Certification Services Inc. The test data, data evaluation, test procedures, and equipment configurations shown in this report were made in accordance with the procedures given in TIA/EIA-603-C: 2004 and the energy emitted by the sample EUT tested as described in this report is in compliance with conducted and radiated emission limits of FCC Rule FCC PART 22 Subpart H and PART 24 Subpart E.

The test results of this report relate only to the tested sample identified in this report.

Approved by:

Reviewed by:

Rex Lai
Section Manager
Compliance Certification Services Inc.

Gina Lo
Section Manager
Compliance Certification Services Inc.



2. EUT DESCRIPTION

Product	Mobile Phone
Trade Name	MOTOROLA
Model Number	W418G, WX345
Model Discrepancy	All the specification and layout are identical except they come with different model numbers for marketing purposes.
EUT Power Rating	<ol style="list-style-type: none"> Powered by Power Adapter MOTOROLA / DCH3-050US-0303 I/P: 100-240V, 50-60Hz, 0.2A O/P: 5.0V, 550mA Powered from host device via USB cable Battery Model: BQ50 Rating: 3.4V, 910mAh
Frequency Range	GSM / GPRS: 850: 824.2 ~ 848.8 MHz GSM / GPRS: 1900: 1850.2 ~ 1909.8 MHz
Transmit Power (ERP & EIRP Power)	GSM 850: 31.46dBm GSM 1900: 31.29 dBm GPRS 850: 30.35 dBm GPRS 1900: 31.41 dBm
Modulation Technique	GSM: GMSK GPRS: GMSK
Type of Emission	GSM 850 MHz: 251KGXW--- GSM 1900 MHz: 251KGXW--- GPRS 850 MHz: 248KGXW--- GPRS 1900 MHz: 248KGXW---
Antenna Gain	GSM / GPRS 850 MHz: -4.16 dBi GSM / GPRS 1900 MHz: -4.23 dBi
Antenna Type	Embedded inverted-F antenna

Remark:

- The sample selected for test was engineering sample that approximated to production product and was provided by manufacturer.
- This submittal(s) (test report) is intended for FCC ID: **IHDP56LJ5** filing to comply with Part 22 and Part 24 of the FCC 47 CFR Rules.



3. TEST METHODOLOGY

Both conducted and radiated testing were performed according to the procedures document on chapter 13 of ANSI C63.4: 2003, TIA/EIA-603-C: 2004 and FCC CFR 47, Part 2, PART 22 SUBPART H AND PART 24 SUBPART E

3.1 EUT CONFIGURATION

The EUT configuration for testing is installed on RF field strength measurement to meet the Commissions requirement and operating in a manner that intends to maximize its emission characteristics in a continuous normal application.

3.2 EUT EXERCISE

The EUT was operated in the engineering mode to fix the TX frequency that was for the purpose of the measurements.

3.3 GENERAL TEST PROCEDURES

Conducted Emissions

The EUT is placed on the turntable, which is 0.8 m above ground plane. According to the requirements in Section 13.1.4.1 of ANSI C63.4: 2003. Conducted emissions from the EUT measured in the frequency range between 0.15 MHz and 30MHz using CISPR Quasi-peak and average detector modes.

Radiated Emissions

The EUT is placed on a turn table, which is 0.8 m above ground plane. The turntable shall rotate 360 degrees to determine the position of maximum emission level. EUT is set 3m away from the receiving antenna, which varied from 1m to 4m to find out the highest emission. And also, each emission was to be maximized by changing the polarization of receiving antenna both horizontal and vertical. In order to find out the maximum emissions, exploratory radiated emission measurements were made according to the requirements in Section 13.1.4.1 of ANSI C63.4: 2003.



3.4 DESCRIPTION OF TEST MODES

The EUT (model: W418G) had been tested under operating condition.

EUT staying in continuous transmitting mode was programmed.

GSM / GPRS 850:

Channel Low (CH128), Channel Mid (CH190) and Channel High (CH251) were chosen for full testing.

GSM / GPRS 1900:

Channel Low (CH512), Channel Mid (CH661) and Channel High (CH810) were chosen for full testing.

After verification, all tests were carried out with the worst case test modes as shown below except radiated spurious emission below 1GHz and power line conducted emissions below 30MHz, which worst case was in normal link mode only.

Based on the above results from the different modulations, GSM850 / GSM1900 / GPRS 850 / GPRS1900 were determined to be the worst-case scenario for all tests.

The worst emission was found:

in lie-down (X axis) for GPRS 850 mode

in lie-down (Y axis) for GSM 850 / GSM 1900 mode.

and stand-up position (Z axis) for GPRS 1900 mode



4. INSTRUMENT CALIBRATION

4.1 MEASURING INSTRUMENT CALIBRATION

The measuring equipment, which was utilized in performing the tests documented herein, has been calibrated in accordance with the manufacturer's recommendations for utilizing calibration equipment, which is traceable to recognized national standards.



4.2 MEASUREMENT EQUIPMENT USED

Equipment Used for Emissions Measurement

Remark: Each piece of equipment is scheduled for calibration once a year.

Conducted Emissions Test Site				
Name of Equipment	Manufacturer	Model	Serial Number	Calibration Due
Spectrum Analyzer	Agilent	E4446A	MY43360131	03/03/2011
Power Meter	Agilent	E4416A	GB41291611	06/28/2010
Power Sensor	Agilent	E9327A	US40441097	06/28/2010
Temp. / Humidity Chamber	Terchy	MHG-150LF	930619	09/15/2010
DC Power Source	Agilent	E3640A	MY40001774	01/08/2011

3M Semi Anechoic Chamber				
Name of Equipment	Manufacturer	Model	Serial Number	Calibration Due
Spectrum Analyzer	Agilent	E4446A	US42510252	10/26/2010
EMI Test Receiver	R&S	ESCI	100064	02/04/2011
Pre-Amplifier	Mini-Circults	ZFL-1000LN	SF350700823	01/13/2011
Pre-Amplifier	MITEQ	AFS44-00102650-42-10P-44	1415367	11/20/2010
Bilog Antenna	Sunol Sciences	JB3	A030105	09/11/2010
Horn Antenna	EMCO	3117	00055165	12/07/2010
Loop Antenna	EMCO	6502	8905/2356	05/27/2011
Turn Table	CCS	CC-T-1F	N/A	N.C.R
Antenna Tower	CCS	CC-A-1F	N/A	N.C.R
Controller	CCS	CC-C-1F	N/A	N.C.R
Site NSA	CCS	N/A	N/A	12/31/2010
Test S/W	EZ-EMC (CCS-3A1RE)			

Powerline Conducted Emissions Test Site				
Name of Equipment	Manufacturer	Model	Serial Number	Calibration Due
EMI Test Receiver	R&S	ESHS30	828144/003	12/06/2010
LISN	EMCO	3825/2	9106-1809	05/02/2011
LISN	SCHAFFNER	NNB 41	03/10013	12/03/2010
Test S/W	CCS-3A1-CE			



4.3 MEASUREMENT UNCERTAINTY

PARAMETER	UNCERTAINTY
Powerline Conducted Emission	+/- 1.6202
3M Semi Anechoic Chamber / 30M~200M	+/- 4.0606
3M Semi Anechoic Chamber / 200M~1000M	+/- 3.9979
3M Semi Anechoic Chamber / 1G~8G	+/- 2.5790
3M Semi Anechoic Chamber / 8G~18G	+/- 2.5928
3M Semi Anechoic Chamber / 18G~26G	+/- 2.7212
3M Semi Anechoic Chamber / 26G~40G	+/- 2.9520

Remark: This uncertainty represents an expanded uncertainty expressed at approximately the 95% confidence level using a coverage factor of $k=2$.



5. FACILITIES AND ACCREDITATIONS

5.1 FACILITIES

No.199, Chunghsen Road, Hsintien City, Taipei Hsien, Taiwan, R.O.C.

Tel: 886-2-2217-0894 / Fax: 886-2-2217-1029

No.11, Wugong 6th Rd., Wugu Industrial Park, Taipei Hsien 248, Taiwan

Tel: 886-2-2299-9720 / Fax: 886-2-2298-4045

No.81-1, Lane 210, Bade 2nd Rd., Luchu Hsiang, Taoyuan Hsien 338, Taiwan

Tel: 886-3-324-0332 / Fax: 886-3-324-5235

The sites are constructed in conformance with the requirements of ANSI C63.7, ANSI C63.4 and CISPR Publication 22.

5.2 EQUIPMENT

Radiated emissions are measured with one or more of the following types of linearly polarized antennas: tuned dipole, biconical, log periodic, bi-log, and/or ridged waveguide, horn. Spectrum analyzers with pre-selectors and quasi-peak detectors are used to perform radiated measurements.



Conducted emissions are measured with Line Impedance Stabilization Networks and EMI Test Receivers.

Calibrated wideband preamplifiers, coaxial cables, and coaxial attenuators are also used for making measurements.

All receiving equipment conforms to CISPR Publication 16-1, "Radio Interference Measuring Apparatus and Measurement Methods."



5.3 TABLE OF ACCREDITATIONS AND LISTINGS

Country	Agency	Scope of Accreditation	Logo
USA	FCC	3M Semi Anechoic Chamber (FCC MRA: TW1039) to perform FCC Part 15 measurements	 FCC MRA: TW1039
Taiwan	TAF	LP0002, RTTE01, FCC Method-47 CFR Part 15 Subpart C, D, E, RSS-210, RSS-310 IDA TS SRD, AS/NZS 4268, AS/NZS 4771, TS 12.1 & 12.2, ETSI EN 300 440-1, ETSI EN 300 440-2, ETSI EN 300 328, ETSI EN 300 220-1, ETSI EN 300 220-2, ETSI EN 301 893, ETSI EN 301 489-1/3/7/17 FCC OET Bulletin 65 + Supplement C, EN 50360, EN 50361, EN 50371, RSS 102, EN 50383, EN 50385, EN 50392, IEC 62209, CNS 14958-1, CNS 14959 FCC Method -47 CFR Part 15 Subpart B IEC / EN 61000-3-2, IEC / EN 61000-3-3, IEC / EN 61000-4-2/3/4/5/6/8/11	 Testing Laboratory 1309
Canada	Industry Canada	3M Semi Anechoic Chamber (IC 2324G-1 / IC 2324G-2) to perform	 IC 2324G-1 IC 2324G-2

* No part of this report may be used to claim or imply product endorsement by A2LA or any agency of the US Government.



6. SETUP OF EQUIPMENT UNDER TEST

6.1 SETUP CONFIGURATION OF EUT

See test photographs attached in Appendix I for the actual connections between EUT and support equipment.

6.2 SUPPORT EQUIPMENT

No.	Device Type	Brand	Model	FCC ID	Series No.	Data Cable	Power Cord
1.	Notebook PC	ASUS	M5200AE	5BN0AG019631	PD9WM3B2100	N/A	AC I/P: Unshielded, 1.8m with a core DC O/P: Unshielded, 1.8m
2.	LCD Monitor	DELL	2407WFPb	CN-0FC255-46633-6 75-22TJS	FCC DoC	Shielded, 1.8m with 2 cores	Unshielded, 1.8m
3.	320GB 2.5" HDD	Seagate	9ZA2MG-500	2GE3NHH0	FCC DoC	Shielded, 1.8m	N/A
4.	USB Mouse	DELL	M-UV69a	323617-001	FCC DoC	Shielded, 1.8m	N/A
5.	Universal Radio Communication Tester (Remote)	R&S	CMU200	N/A	101245	N/A	Unshielded, 1.8m

Remark:

1. All the equipment/cables were placed in the worst-case configuration to maximize the emission during the test.
2. Grounding was established in accordance with the manufacturer's requirements and conditions for the intended use.



7. FCC PART 22 & 24 REQUIREMENTS

7.1 PEAK POWER

LIMIT

According to FCC §2.1046.

Test Configuration

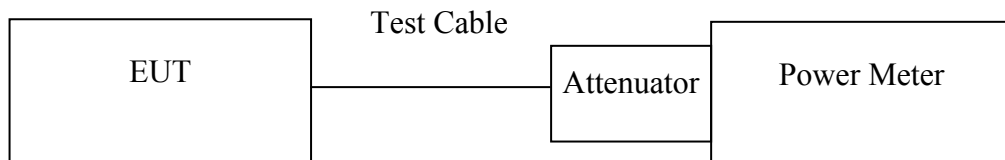

Remark: Measurement setup for testing on Antenna connector

TEST PROCEDURE

The transmitter output was connected to a calibrated attenuator, the other end of which was connected to a power meter. Transmitter output was read off the power meter in dBm. The power output at the transmitter antenna port was determined by adding the value of the attenuator to the power meter reading.

TEST RESULTS

No non-compliance noted.



Test Data

Test Mode	CH	Frequency (MHz)	Peak Power (dBm)	Output Power W
GSM 850 (Class 10)	128	824.20	32.60	1.8197
	190	836.40	33.30	2.1380
	251	848.80	33.40	2.1878
GPRS 850 (Class 10)	128	824.20	32.00	1.5849
	190	836.40	32.80	1.9055
	251	848.80	33.00	1.9953

Test Mode	CH	Frequency (MHz)	Peak Power (dBm)	Output Power W
GSM 1900 (Class 10)	512	1850.20	29.50	0.8913
	661	1880.00	30.00	1.0000
	810	1909.80	30.20	1.0471
GPRS 1900 (Class 10)	512	1850.20	27.80	0.6026
	661	1880.00	28.40	0.6918
	810	1909.80	28.60	0.7244

Remark: The value of factor includes both the loss of cable and external attenuator



7.2 AVERAGE POWER

LIMIT

For reporting purposes only.

Test Configuration

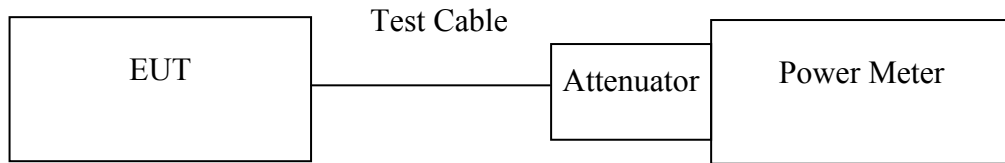

Remark: Measurement setup for testing on Antenna connector

TEST PROCEDURE

The transmitter output was connected to a calibrated attenuator, the other end of which was connected to a power meter. Transmitter output was read off the power meter in dBm. The power output at the transmitter antenna port was determined by adding the value of the attenuator to the power meter reading.

TEST RESULTS

No non-compliance noted.



TEST RESULTS

No non-compliance noted.

Test Data

Test Mode	CH	Frequency (MHz)	AVG Power (dBm)	Output Power W
GSM 850 (Class 10)	128	824.20	32.50	1.7783
	190	836.40	33.10	2.0417
	251	848.80	33.20	2.0893
GPRS 850 (Class 10)	128	824.20	31.90	1.5488
	190	836.40	32.70	1.8621
	251	848.80	32.90	1.9498

Test Mode	CH	Frequency (MHz)	AVG Power (dBm)	Output Power W
GSM 1900 (Class 10)	512	1850.20	29.40	0.8710
	661	1880.00	29.90	0.9772
	810	1909.80	30.00	1.0000
GPRS 1900 (Class 10)	512	1850.20	27.70	0.5888
	661	1880.00	28.30	0.6761
	810	1909.80	28.50	0.7079

Remark: *The value of factor includes both the loss of cable and external attenuator*

7.3 ERP & EIRP MEASUREMENT

LIMIT

According to FCC §2.1046

FCC 22.913(a): The Effective Radiated Power (ERP) of mobile transmitters must not exceed 7 Watts.

FCC 24.232(b): The equivalent Isotropic Radiated Power (EIRP) must not exceed 2 Watts.

Test Configuration

Below 1 GHz

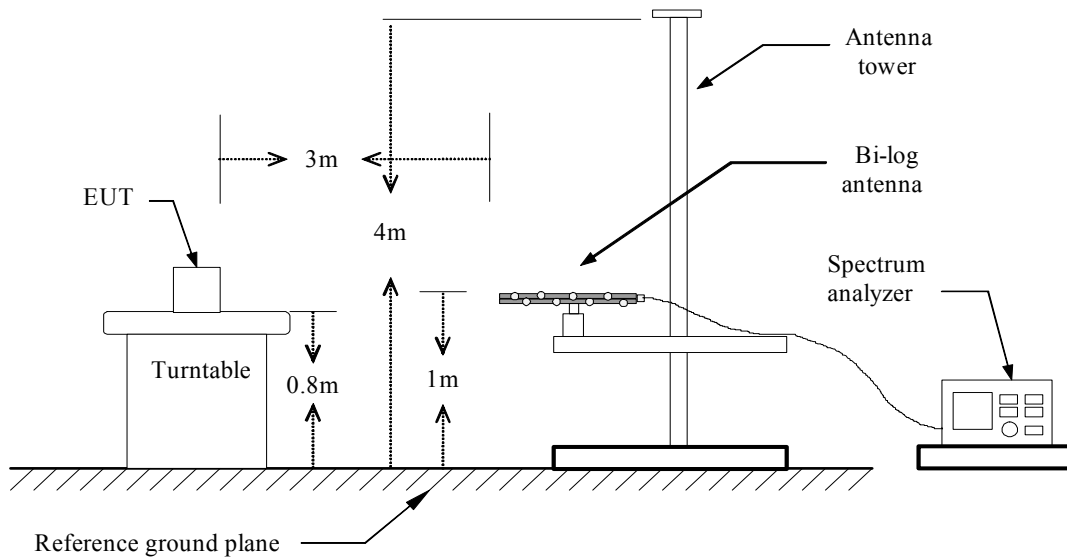

Above 1 GHz

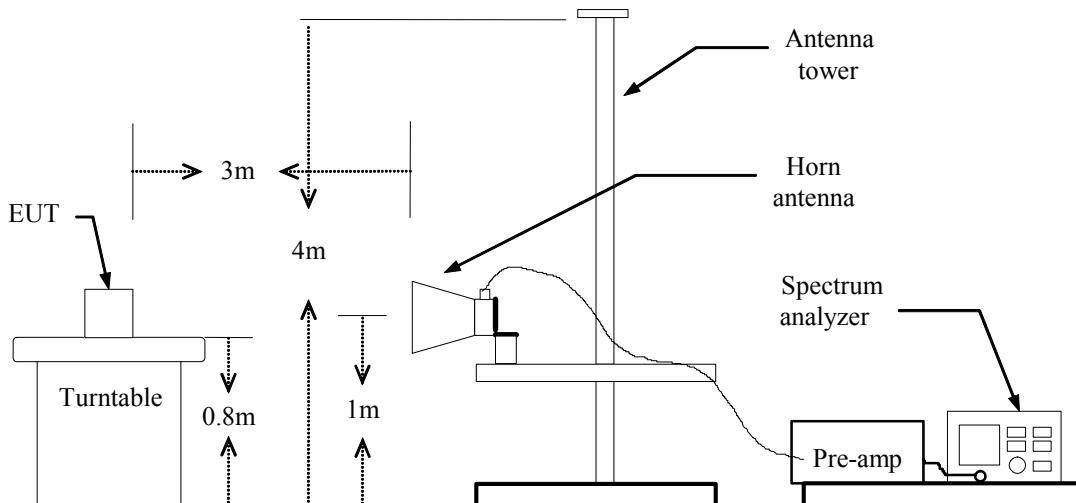

For Substituted Method Test Set-UP

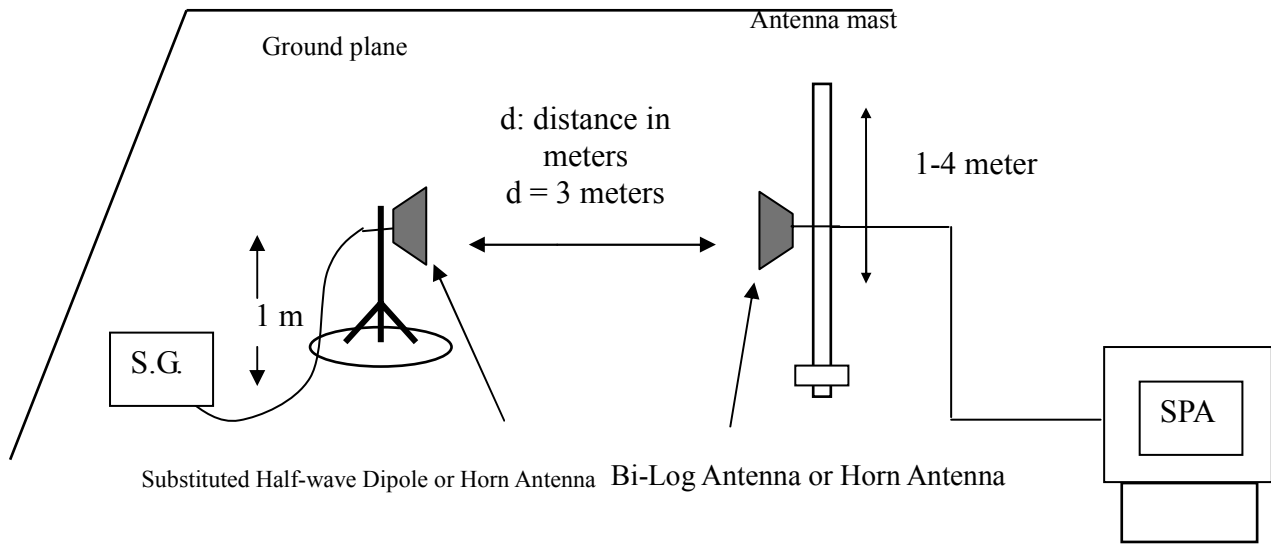

TEST PROCEDURE

The EUT was placed on an non-conductive turntable using a non-conductive support. The radiated emission at the fundamental frequency was measured at 3 m with a test antenna and EMI spectrum analyzer.

During the measurement of the EUT, the resolution bandwidth was set to 3MHz and the average bandwidth was set to 3MHz. The highest emission was recorded with the rotation of the turntable and the lowering of the test antenna. The reading was recorded and the field strength (E in dBuV/m) was calculated.

ERP in frequency band 824-849MHz, and EIRP in frequency band 1851.25 –1910MHz were measured using a substitution method. The EUT was replaced by half-wave dipole (824-849MHz) or horn antenna (1851.25-1910MHz) connected to a signal generator. The spectrum analyzer reading was recorded and ERP/EIRP was calculated as follows:

$$ERP = \text{S.G. output (dBm)} + \text{Antenna Gain (dBd)} - \text{Cable (dB)}$$

$$EIRP = \text{S.G. output (dBm)} + \text{Antenna Gain (dBi)} - \text{Cable (dB)}$$

TEST RESULTS

No non-compliance noted.

**GSM 850 TEST DATA (CLASS 10)**

EUT Pol.	Channel	Frequency (MHz)	Antenna Pol.	Reading level (dBuV)	Correction Factor (dB)	Emission level (dBm)	Limit (dBm)	Margin (dB)
X	128	824.30	V	-21.10	34.62	13.52	38.45	-24.93
		824.30	H	-4.03	34.65	30.61	38.45	-7.84
	190	836.66	V	-23.31	34.53	11.22	38.45	-27.23
		836.66	H	-4.48	34.63	30.15	38.45	-8.3
	251	848.84	V	-22.81	34.64	11.83	38.45	-26.62
		848.84	H	-5.61	34.75	29.14	38.45	-9.31
Y	128	824.18	V	-14.55	34.62	20.06	38.45	-18.39
		824.30	H	-3.19	34.65	*31.46	38.45	-6.99
	190	836.66	V	-17.44	34.53	17.09	38.45	-21.36
		836.78	H	-4.32	34.63	30.31	38.45	-8.14
	251	848.84	V	-16.76	34.64	17.88	38.45	-20.57
		848.84	H	-5.53	34.75	29.22	38.45	-9.23
Z	128	824.48	V	-4.29	34.62	30.33	38.45	-8.12
		824.06	H	-16.08	34.65	18.56	38.45	-19.89
	190	836.66	V	-4.78	34.53	29.74	38.45	-8.71
		836.66	H	-15.74	34.63	18.90	38.45	-19.55
	251	848.78	V	-5.94	34.64	28.70	38.45	-9.75
		848.78	H	-17.33	34.75	17.42	38.45	-21.03



GPRS 850 TEST DATA (CLASS 10)

EUT Pol.	Channel	Frequency (MHz)	Antenna Pol.	Reading level (dBuV)	Correction Factor (dB)	Emission level (dBm)	Limit (dBm)	Margin (dB)
X	128	824.18	V	-16.71	34.62	17.91	38.45	-20.54
		824.18	H	-4.29	34.65	*30.35	38.45	-8.1
	190	836.48	V	-15.45	34.53	19.07	38.45	-19.38
		836.48	H	-4.72	34.63	29.91	38.45	-8.54
	251	848.78	V	-16.47	34.64	18.17	38.45	-20.28
		848.78	H	-7.18	34.75	27.56	38.45	-10.89
Y	128	824.18	V	-12.78	34.62	21.83	38.45	-16.62
		824.18	H	-5.26	34.65	29.38	38.45	-9.07
	190	836.54	V	-15.70	34.53	18.83	38.45	-19.62
		836.54	H	-5.79	34.63	28.84	38.45	-9.61
	251	848.78	V	-19.46	34.64	15.18	38.45	-23.27
		849.08	H	-6.95	34.75	27.80	38.45	-10.65
Z	128	824.06	V	-4.96	34.62	29.66	38.45	-8.79
		824.18	H	-18.89	34.65	15.75	38.45	-22.7
	190	836.30	V	-6.04	34.53	28.49	38.45	-9.96
		836.48	H	-18.68	34.63	15.95	38.45	-22.5
	251	848.78	V	-7.78	34.64	26.86	38.45	-11.59
		848.78	H	-18.76	34.75	15.99	38.45	-22.46



GSM 1900 TEST DATA (CLASS 10)

EUT Pol.	Channel	Frequency (MHz)	Antenna Pol.	Reading level (dBuV)	Correction Factor (dB)	Emission level (dBm)	Limit (dBm)	Margin (dB)
X	512	1850.10	V	-16.40	41.17	24.77	33.00	-8.23
		1850.20	H	-9.95	40.79	30.84	33.00	-2.16
	661	1880.00	V	-18.11	41.23	23.12	33.00	-9.88
		1879.80	H	-10.32	41.14	30.82	33.00	-2.18
	810	1909.70	V	-19.53	41.30	21.77	33.00	-11.23
		1909.90	H	-11.05	41.38	30.32	33.00	-2.68
Y	512	1850.10	V	-9.88	41.17	*31.29	33.00	-1.71
		1850.00	H	-16.29	40.79	24.50	33.00	-8.50
	661	1880.00	V	-9.99	41.23	31.24	33.00	-1.76
		1879.80	H	-17.55	41.14	23.59	33.00	-9.41
	810	1909.90	V	-10.95	41.30	30.36	33.00	-2.64
		1909.90	H	-17.23	41.38	24.15	33.00	-8.85
Z	512	1850.10	V	-10.76	41.17	30.42	33.00	-2.58
		1850.10	H	-16.70	40.79	24.09	33.00	-8.91
	661	1880.00	V	-10.43	41.23	30.80	33.00	-2.20
		1880.00	H	-18.12	41.14	23.03	33.00	-9.97
	810	1909.70	V	-11.16	41.30	30.15	33.00	-2.85
		1909.70	H	-17.80	41.38	23.57	33.00	-9.43



GPRS 1900 TEST DATA (CLASS 10)

EUT Pol.	Channel	Frequency (MHz)	Antenna Pol.	Reading level (dBuV)	Correction Factor (dB)	Emission level (dBm)	Limit (dBm)	Margin (dB)
X	512	1850.20	V	-17.65	41.17	23.52	33.00	-9.48
		1850.10	H	-10.63	40.79	30.16	33.00	-2.84
	661	1879.80	V	-18.53	41.23	22.70	33.00	-10.30
		1879.80	H	-10.36	41.14	30.78	33.00	-2.22
	810	1909.90	V	-17.91	41.30	23.40	33.00	-9.60
		1909.60	H	-10.57	41.38	30.81	33.00	-2.19
Y	512	1850.10	V	-11.23	41.17	29.94	33.00	-3.06
		1850.10	H	-17.02	40.79	23.77	33.00	-9.23
	661	1880.10	V	-10.75	41.23	30.48	33.00	-2.52
		1880.10	H	-17.93	41.15	23.22	33.00	-9.78
	810	1909.70	V	-10.72	41.30	30.58	33.00	-2.42
		1909.60	H	-17.94	41.38	23.43	33.00	-9.57
Z	512	1850.20	V	-12.03	41.17	29.15	33.00	-3.85
		1850.20	H	-16.02	40.79	24.77	33.00	-8.23
	661	1879.80	V	-10.48	41.23	30.75	33.00	-2.25
		1879.80	H	-17.36	41.14	23.79	33.00	-9.21
	810	1909.70	V	-9.89	41.30	*31.41	33.00	-1.59
		1909.70	H	-16.75	41.38	24.62	33.00	-8.38



7.4 OCCUPIED BANDWIDTH MEASUREMENT

LIMIT

According to §FCC 2.1049.

Test Configuration

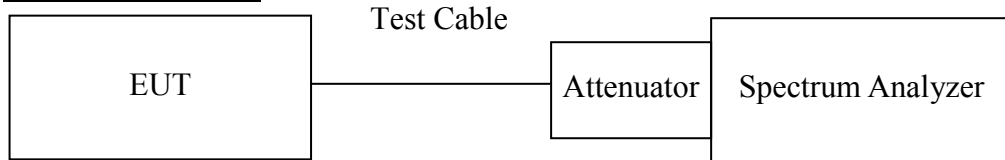

Remark: Measurement setup for testing on Antenna connector

TEST PROCEDURE

The EUT's output RF connector was connected with a short cable to the spectrum analyzer, RBW was set to about 1% of emission BW, VBW is set to 3 times the RBW, -26dBc display line was placed on the screen (or 99% bandwidth), the occupied bandwidth is the delta frequency between the two points where the display line intersects the signal trace.

TEST RESULTS

No non-compliance noted



Test Data

Test Mode	CH	Frequency (MHz)	99% Bandwidth (kHz)
GSM 850 (Class 10)	128	824.200	249.7463
	190	836.600	244.4998
	251	848.800	251.8361
GPRS 850 (Class 10)	128	824.200	242.7108
	190	836.600	243.6862
	251	848.800	248.0358

Test Mode	CH	Frequency (MHz)	99% Bandwidth (kHz)
GSM 1900 (Class 10)	512	1850.200	245.7767
	661	1880.000	251.7144
	810	1909.800	249.9063
GPRS 1900 (Class 10)	512	1850.200	248.2529
	661	1880.000	248.6393
	810	1909.800	243.7532



Test Plot

GSM 850 (CH Low)

Agilent 14:58:03 May 21, 2010

R L

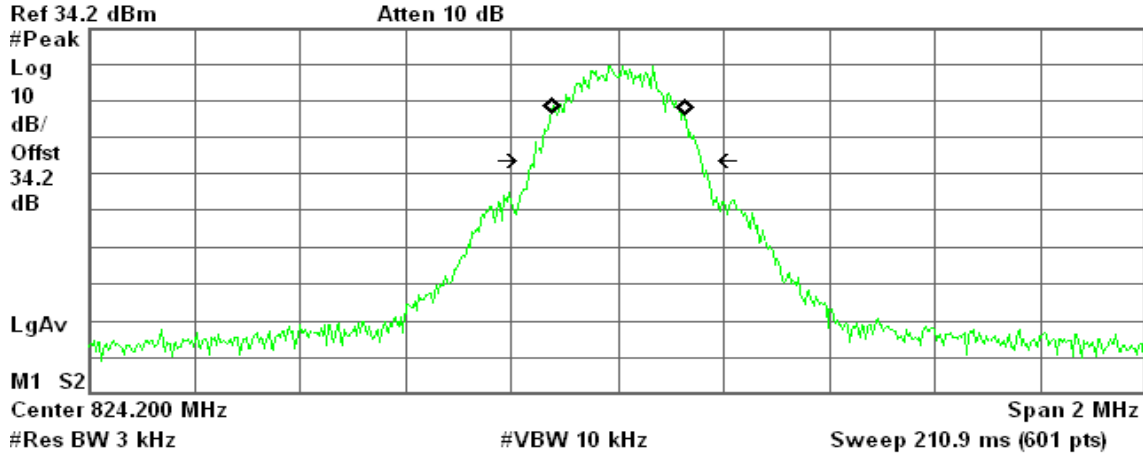

Occupied Bandwidth
249.7463 kHz

Occ BW % Pwr 99.00 %
x dB -26.00 dB

Transmit Freq Error 209.507 Hz
x dB Bandwidth 313.706 kHz

GSM 850 (CH Mid)

Agilent 15:00:07 May 21, 2010

R T

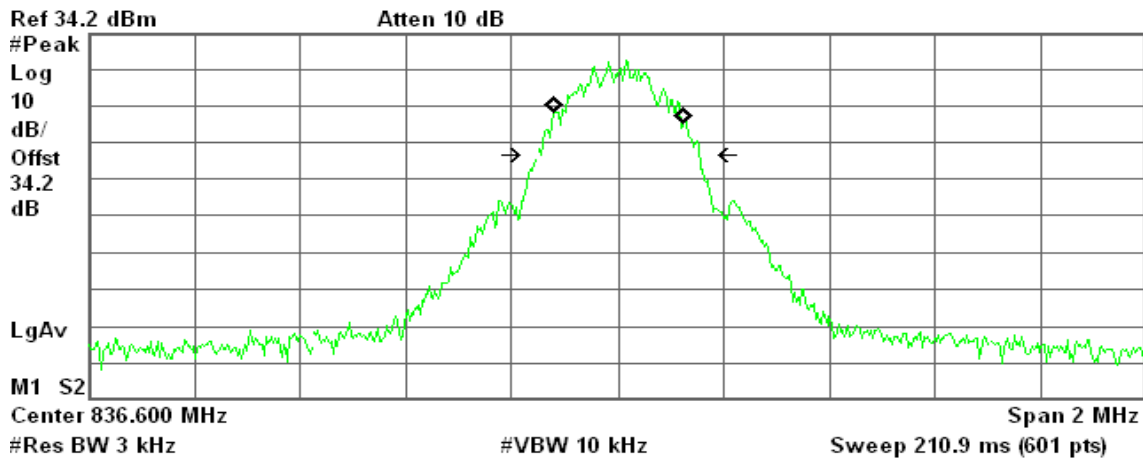

Occupied Bandwidth
244.4998 kHz

Occ BW % Pwr 99.00 %
x dB -26.00 dB

Transmit Freq Error 1.969 kHz
x dB Bandwidth 304.114 kHz



GSM 850 (CH High)

Agilent 15:01:03 May 21, 2010

R T

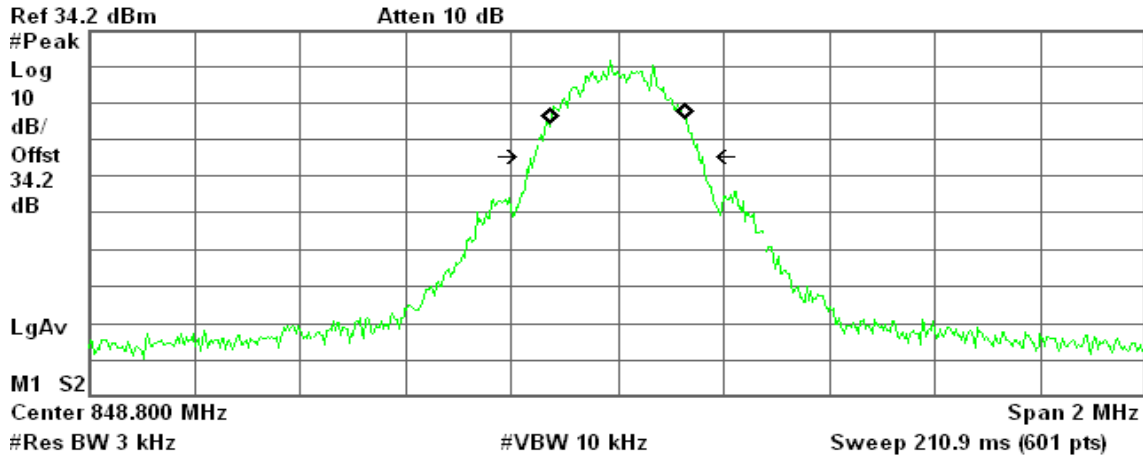

Occupied Bandwidth
251.8361 kHz

Occ BW % Pwr 99.00 %
x dB -26.00 dB

Transmit Freq Error -41.843 Hz
x dB Bandwidth 308.172 kHz

GPRS 850 (CH Low)

Agilent 15:42:54 May 21, 2010

R T

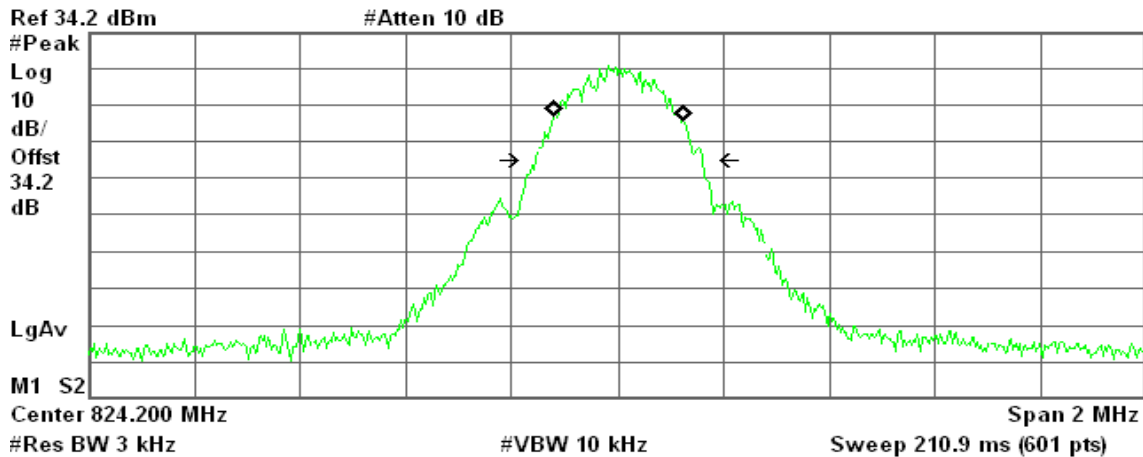

Occupied Bandwidth
242.7108 kHz

Occ BW % Pwr 99.00 %
x dB -26.00 dB

Transmit Freq Error 906.436 Hz
x dB Bandwidth 315.038 kHz



GPRS 850 (CH Mid)

Agilent 15:45:50 May 21, 2010

R T

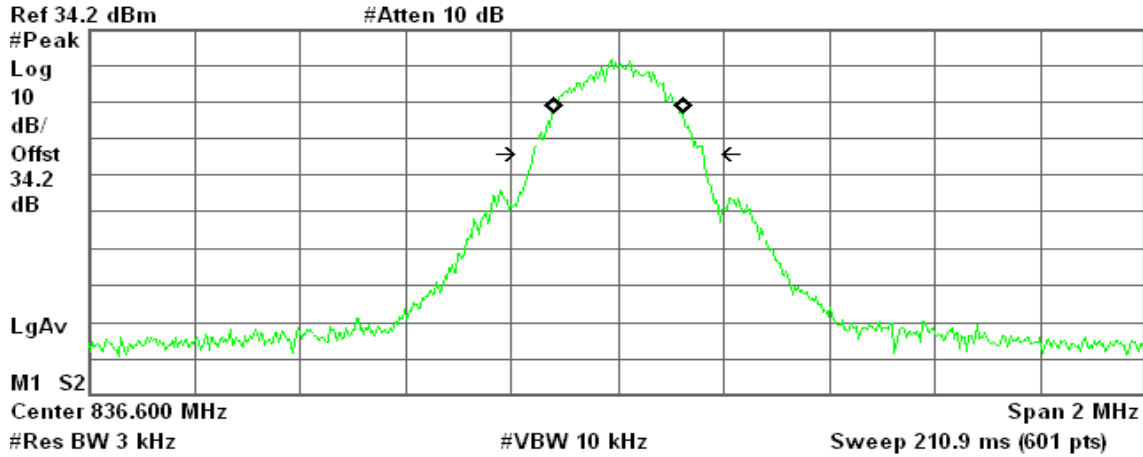

Occupied Bandwidth
243.6862 kHz

Occ BW % Pwr 99.00 %
x dB -26.00 dB

Transmit Freq Error 303.493 Hz
Occupied Bandwidth 320.372 kHz

GPRS 850(CH High)

Agilent 15:47:28 May 21, 2010

R T

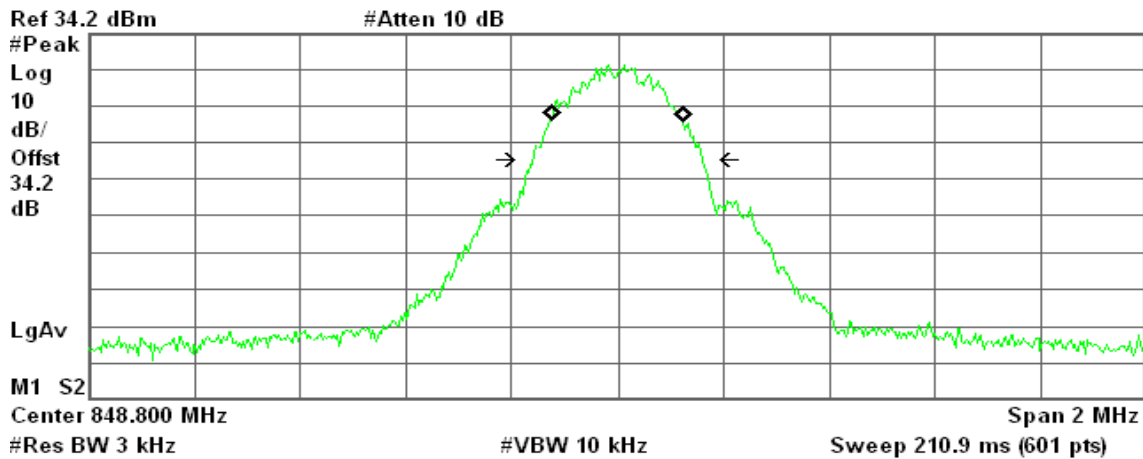

Occupied Bandwidth
248.0358 kHz

Occ BW % Pwr 99.00 %
x dB -26.00 dB

Transmit Freq Error 35.536 Hz
x dB Bandwidth 318.561 kHz



GSM 1900 (CH Low)

Agilent 09:02:52 May 21, 2010

R T

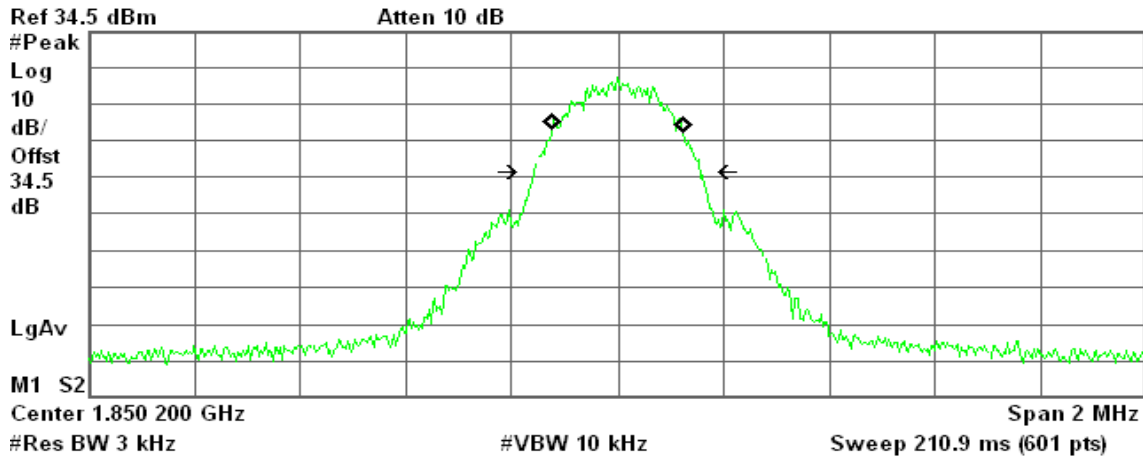

Occupied Bandwidth
245.7767 kHz

Occ BW % Pwr 99.00 %
x dB -26.00 dB

Transmit Freq Error 361.196 Hz
x dB Bandwidth 312.724 kHz

GSM 1900 (CH Mid)

Agilent 09:05:07 May 21, 2010

R T

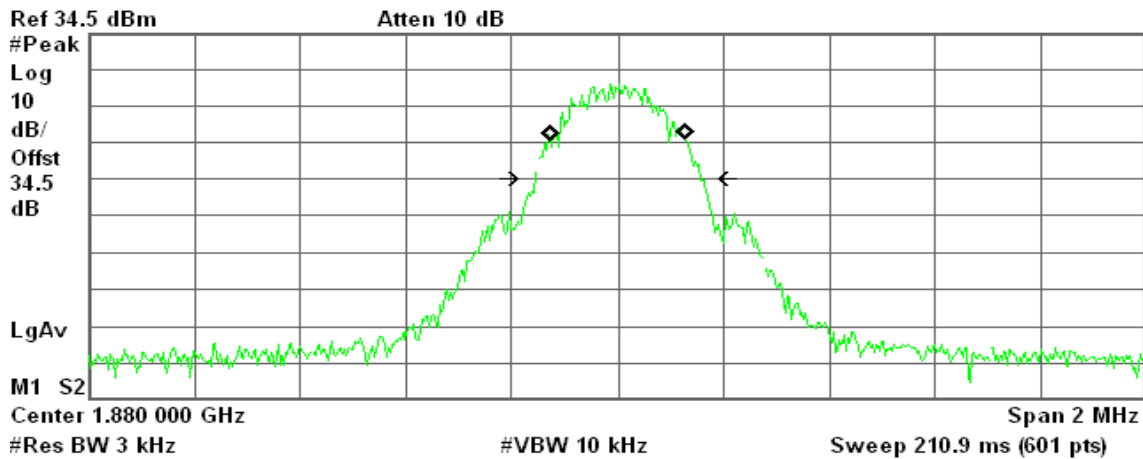

Occupied Bandwidth
251.7144 kHz

Occ BW % Pwr 99.00 %
x dB -26.00 dB

Transmit Freq Error -466.551 Hz
x dB Bandwidth 310.763 kHz



GSM 1900 (CH High)

Agilent 09:05:49 May 21, 2010

R T

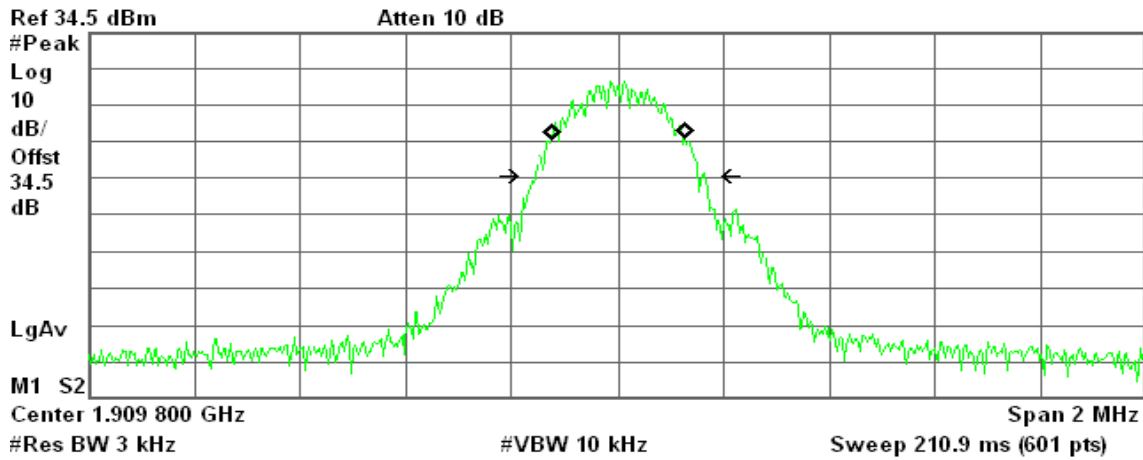

Occupied Bandwidth
249.9063 kHz

Occ BW % Pwr 99.00 %
x dB -26.00 dB

Transmit Freq Error 1.817 kHz
x dB Bandwidth 317.636 kHz

GPRS 1900 (CH Low)

Agilent 09:49:55 May 21, 2010

R T

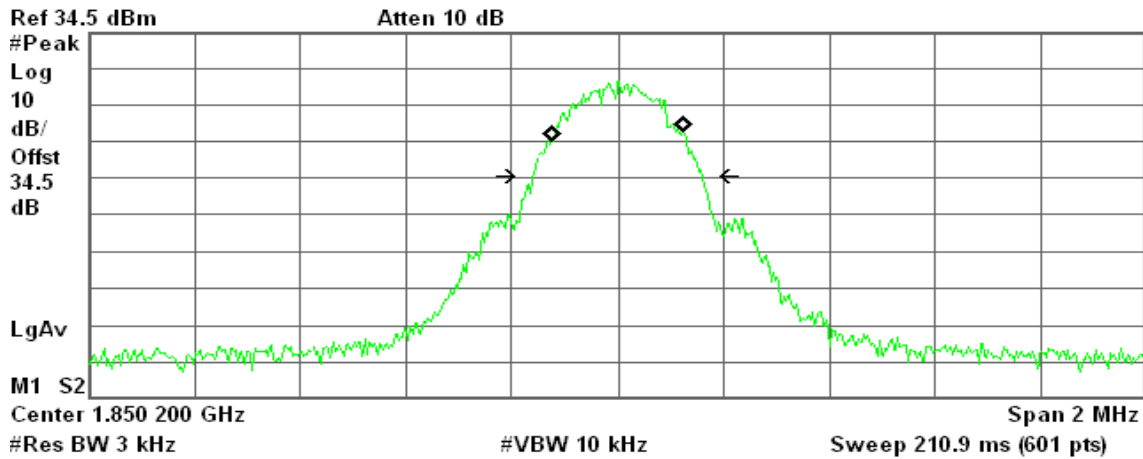

Occupied Bandwidth
248.2529 kHz

Occ BW % Pwr 99.00 %
x dB -26.00 dB

Transmit Freq Error 563.871 Hz
x dB Bandwidth 318.637 kHz



GPRS 1900 (CH Mid)

Agilent 09:51:21 May 21, 2010

R T

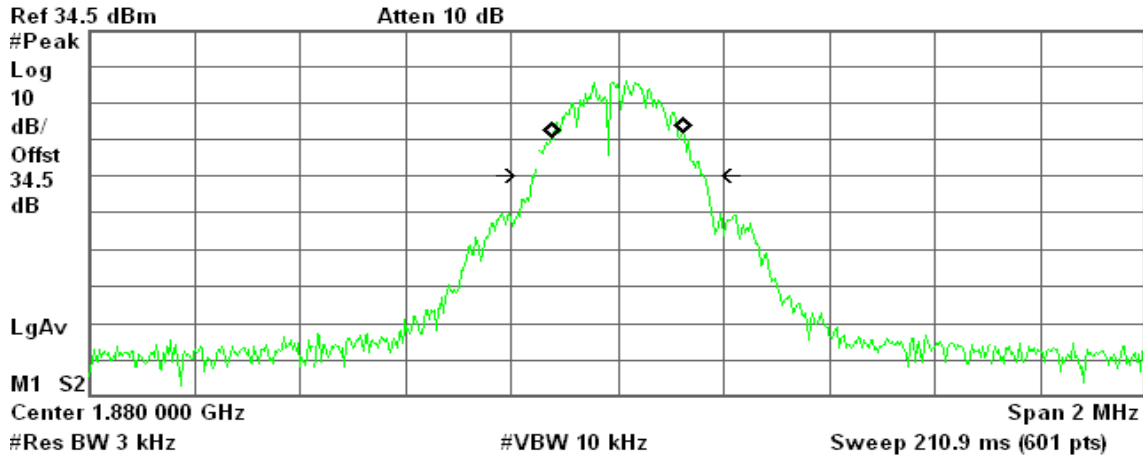

Occupied Bandwidth
248.6393 kHz

Occ BW % Pwr 99.00 %
x dB -26.00 dB

Transmit Freq Error -399.314 Hz
x dB Bandwidth 322.203 kHz

GPRS 1900 (CH High)

Agilent 09:58:51 May 21, 2010

R T

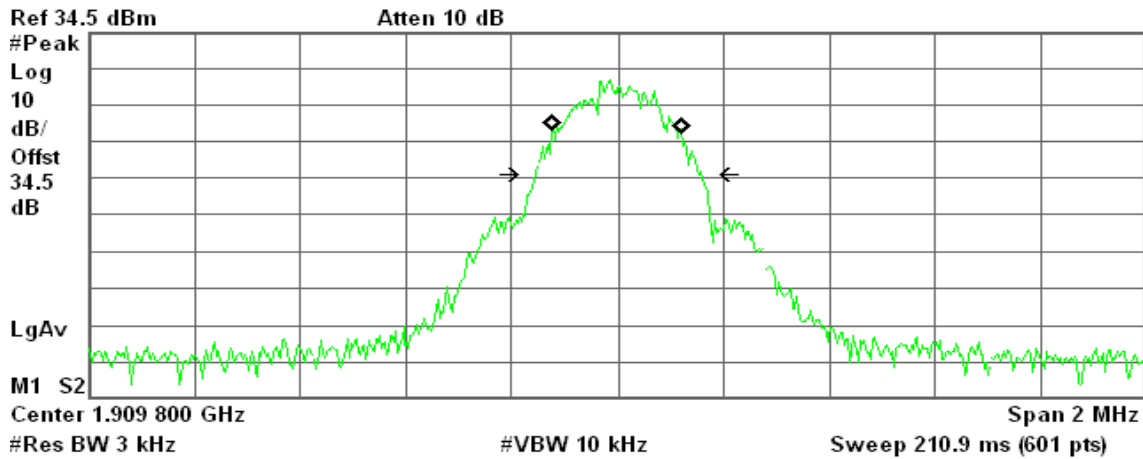

Occupied Bandwidth
243.7532 kHz

Occ BW % Pwr 99.00 %
x dB -26.00 dB

Transmit Freq Error -973.219 Hz
x dB Bandwidth 311.729 kHz



7.5 OUT OF BAND EMISSION AT ANTENNA TERMINALS

LIMIT

According to FCC §2.1051, FCC §22.917, FCC §24.238(a).

Out of Band Emissions: The mean power of emission must be attenuated below the mean power of the non-modulated carrier (P) on any frequency twice or more than twice the fundamental frequency by at least $43 + 10 \log P$ dB.

Mobile Emissions in Base Frequency Range: The mean power of any emissions appearing in the base station frequency range from cellular mobile transmitters operated must be attenuated to a level not exceed -80 dBm at the transmit antenna connector.

Band Edge Requirements: In the 1MHz bands immediately outside and adjacent to the frequency block, a resolution bandwidth of at least 1% of the emission bandwidth of the fundamental emission of the transmitter may be employed to measure the Out of band Emission

Test Configuration

Out of band emission at antenna terminals:

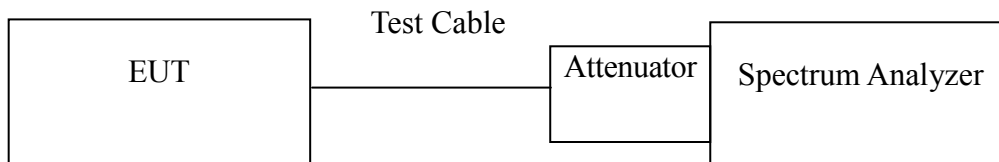

TEST PROCEDURE

The RF output of the transceiver was connected to a spectrum analyzer through appropriate attenuation. The resolution bandwidth of the spectrum analyzer was set at 1MHz, sufficient scans were taken to show the out of band Emissions if any up to 10th harmonic.

For the out of band: Set the RBW, VBW = 1MHz, Start=30MHz, Stop= 10 th harmonic. Limit = -13dBm

Band Edge Requirements (824 MHz and 849 MHz /1850MHz and 1910MHz): In the 1 MHz bands immediately outside and adjacent to the frequency block, a resolution bandwidth of at least 1 percent of the emission bandwidth of the fundamental emission of the transmitter may be employed to measure the out of band Emissions. Limit, -13dBm.

TEST RESULTS

No non-compliance noted.



Test Data

Mode	CH	Location	Description
GSM 850 (Class 10)	128	Figure 7-1	Conducted spurious emissions, 30MHz - 20GHz
	190	Figure 7-2	Conducted spurious emissions, 30MHz - 20GHz
	251	Figure 7-3	Conducted spurious emissions, 30MHz - 20GHz
GPRS 850 (Class 10)	128	Figure 8-1	Conducted spurious emissions, 30MHz - 20GHz
	190	Figure 8-2	Conducted spurious emissions, 30MHz - 20GHz
	251	Figure 8-3	Conducted spurious emissions, 30MHz - 20GHz

Mode	CH	Location	Description
GSM 1900 (Class 10)	512	Figure 9-1	Conducted spurious emissions, 30MHz - 20GHz
	661	Figure 9-2	Conducted spurious emissions, 30MHz - 20GHz
	810	Figure 9-3	Conducted spurious emissions, 30MHz - 20GHz
GPRS 1900 (Class 10)	512	Figure 10-1	Conducted spurious emissions, 30MHz - 20GHz
	661	Figure 10-2	Conducted spurious emissions, 30MHz - 20GHz
	810	Figure 10-3	Conducted spurious emissions, 30MHz - 20GHz

Mode	CH	Location	Description
GSM 850 (Class 10)	128	Figure 11-1	Band Edge emissions
	251	Figure 11-2	Band Edge emissions
GPRS 850 (Class 10)	128	Figure 12-1	Band Edge emissions
	251	Figure 12-2	Band Edge emissions

Mode	CH	Location	Description
GSM 1900 (Class 10)	512	Figure 13-1	Band Edge emissions
	810	Figure 13-2	Band Edge emissions
GPRS 1900 (Class 10)	512	Figure 14-1	Band Edge emissions
	810	Figure 14-2	Band Edge emissions



Test Plot

GSM 850

Figure 7-1: Out of Band emission at antenna terminals – GSM CH Low

Agilent 15:17:23 May 21, 2010

R T

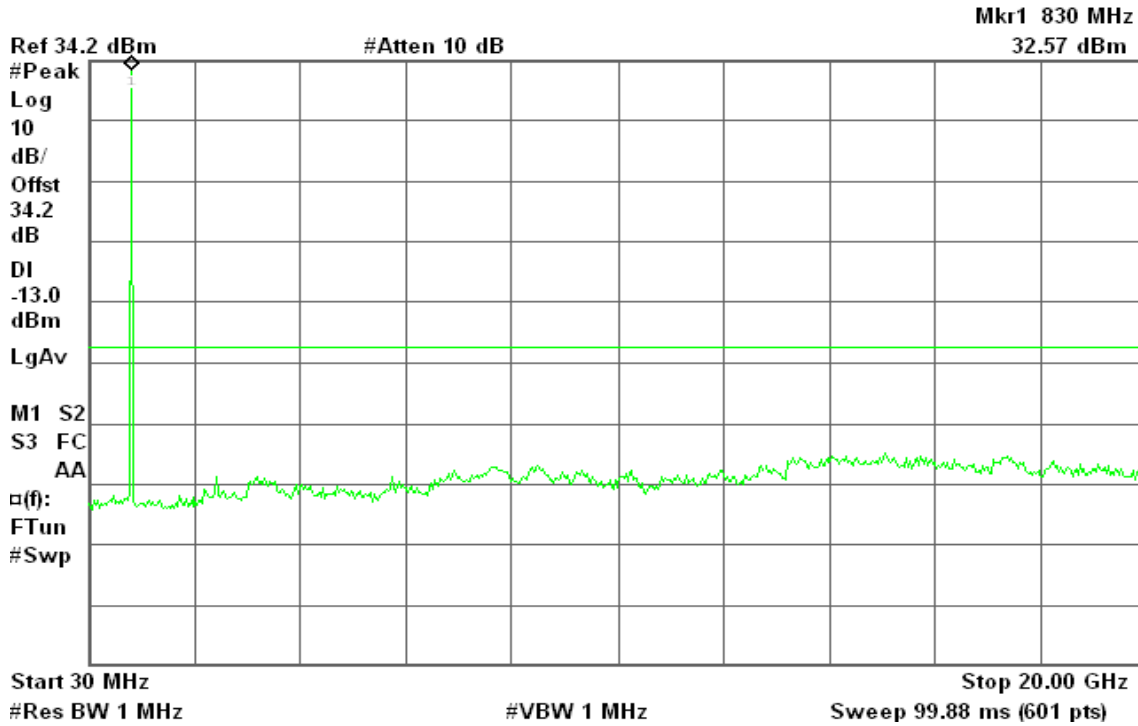

Figure 7-2: Out of Band emission at antenna terminals – GSM CH Mid

Agilent 15:16:13 May 21, 2010

R T

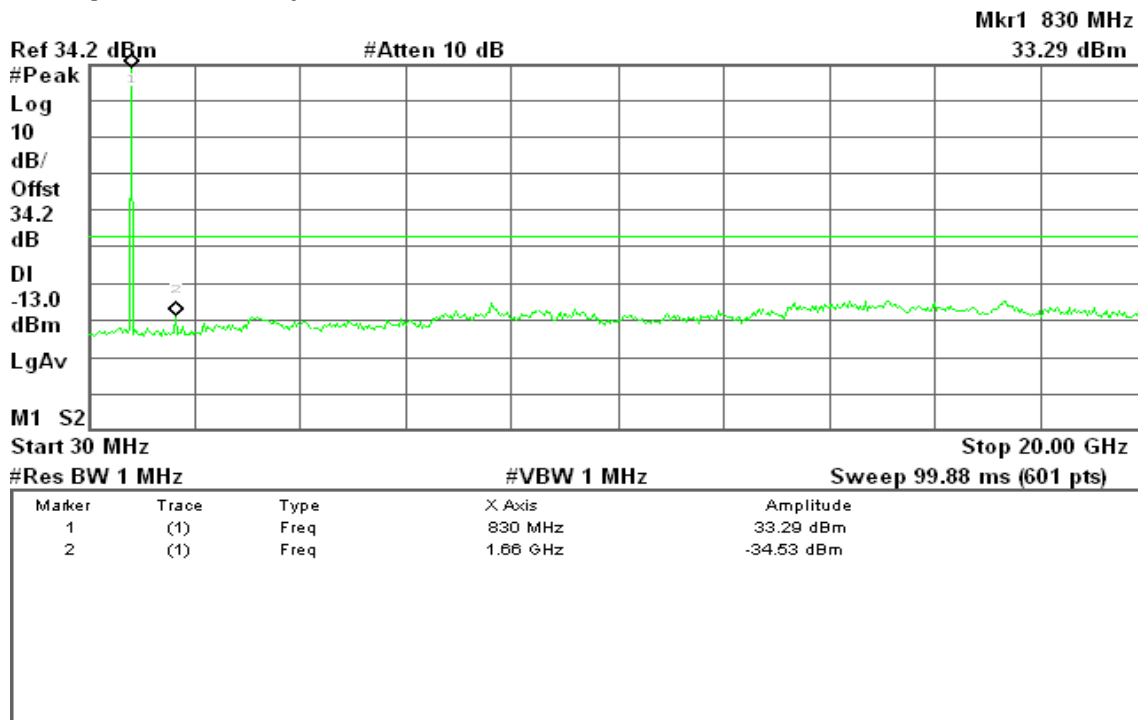
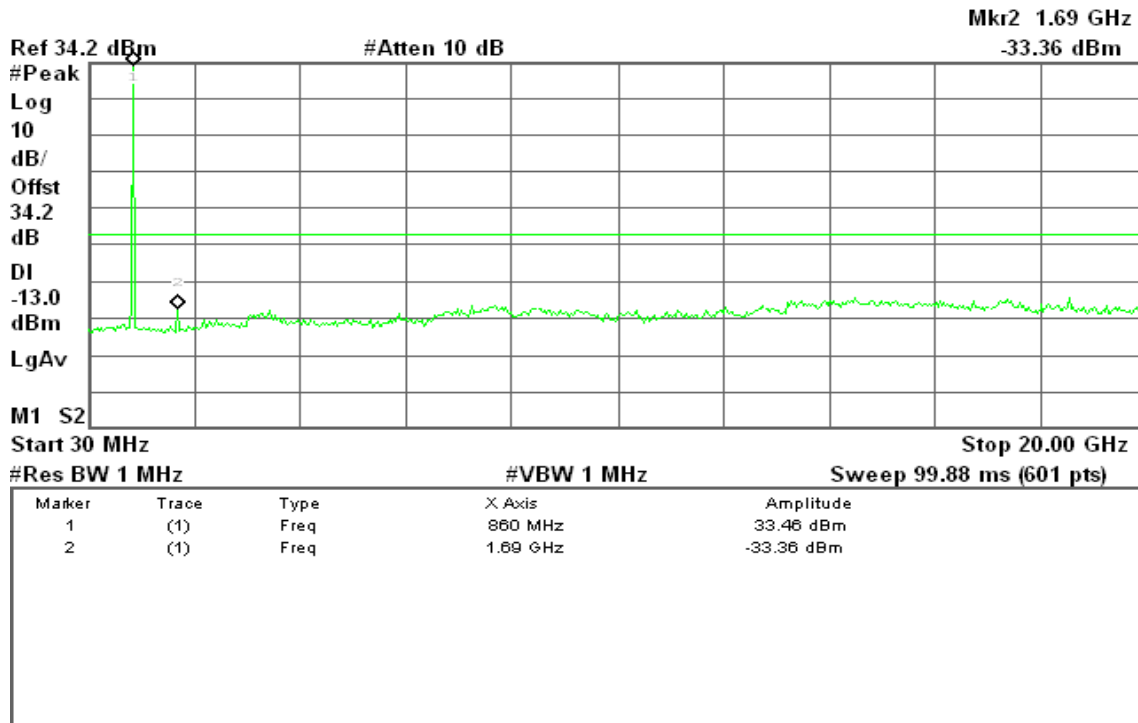



Figure 7-3: Out of Band emission at antenna terminals – GSM CH High

Agilent 15:15:52 May 21, 2010

R T



GPRS 850

Figure 8-1: Out of Band emission at antenna terminals – GSM CH Low

Agilent 22:51:46 Sep 3, 1970

R T

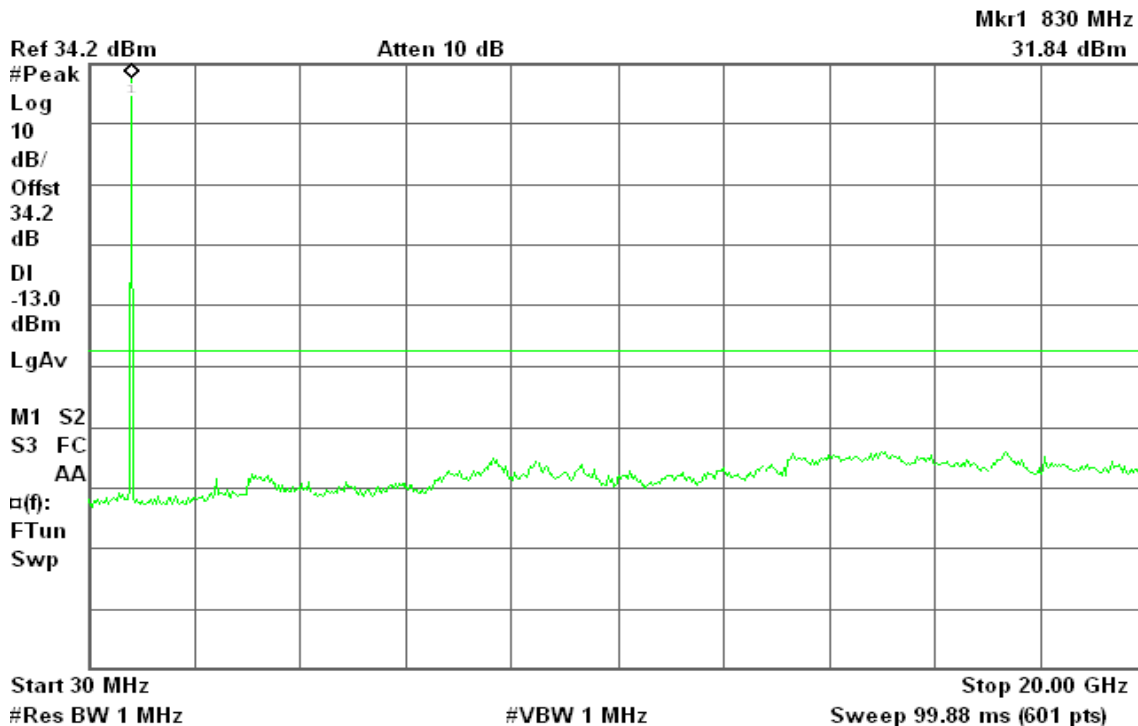



Figure 8-2: Out of Band emission at antenna terminals – GSM CH Mid

Agilent 22:53:46 Sep 3, 1970

R T

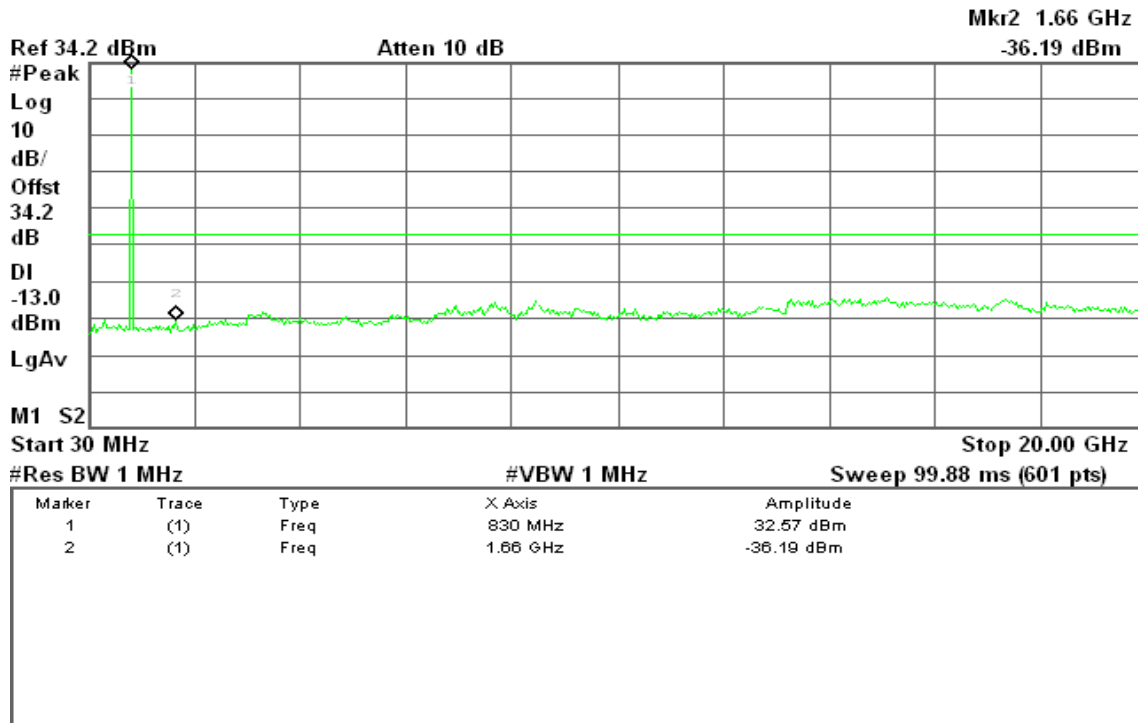
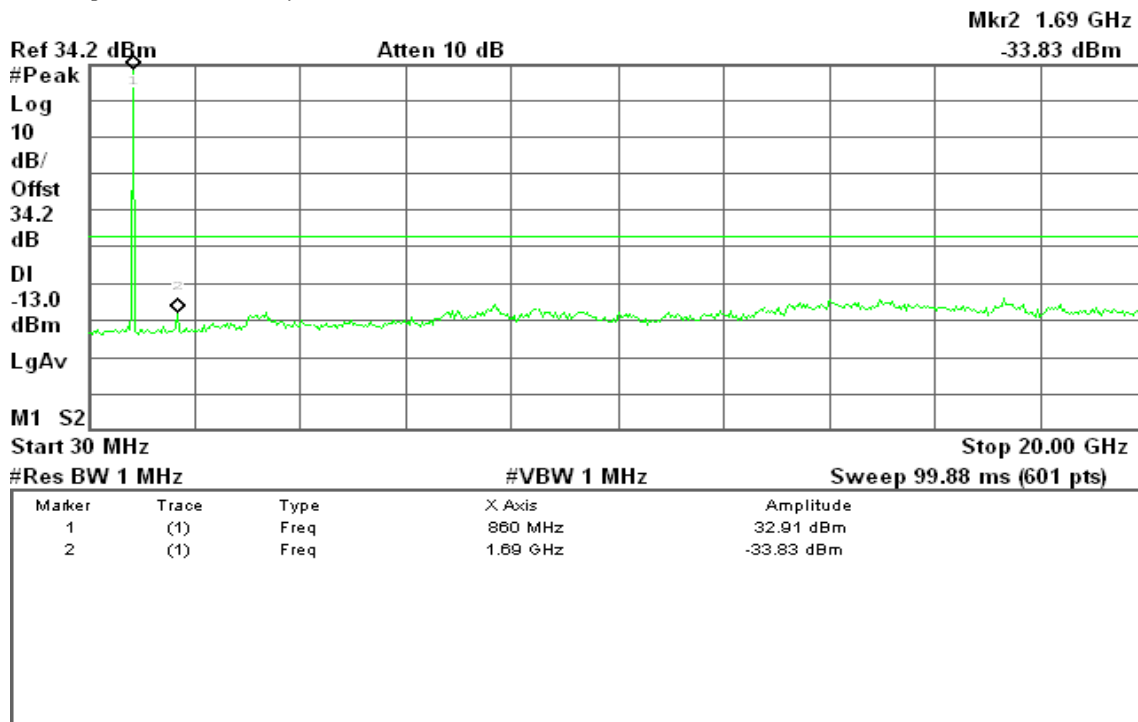

Figure 8-3: Out of Band emission at antenna terminals – GSM CH High

Agilent 22:52:49 Sep 3, 1970

R T





GSM 1900

Figure 9-1: Out of Band emission at antenna terminals – GSM CH Low

Agilent 09:11:54 May 21, 2010

R T

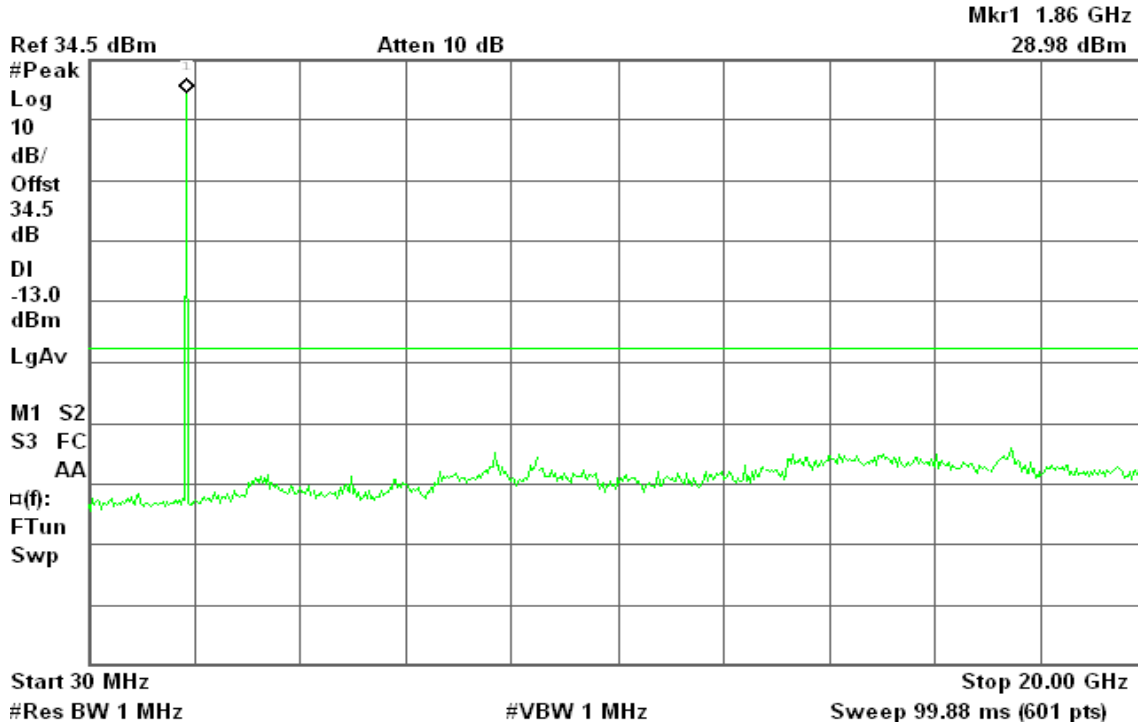

Figure 9-2: Out of Band emission at antenna terminals – GSM CH Mid

Agilent 09:12:20 May 21, 2010

R T

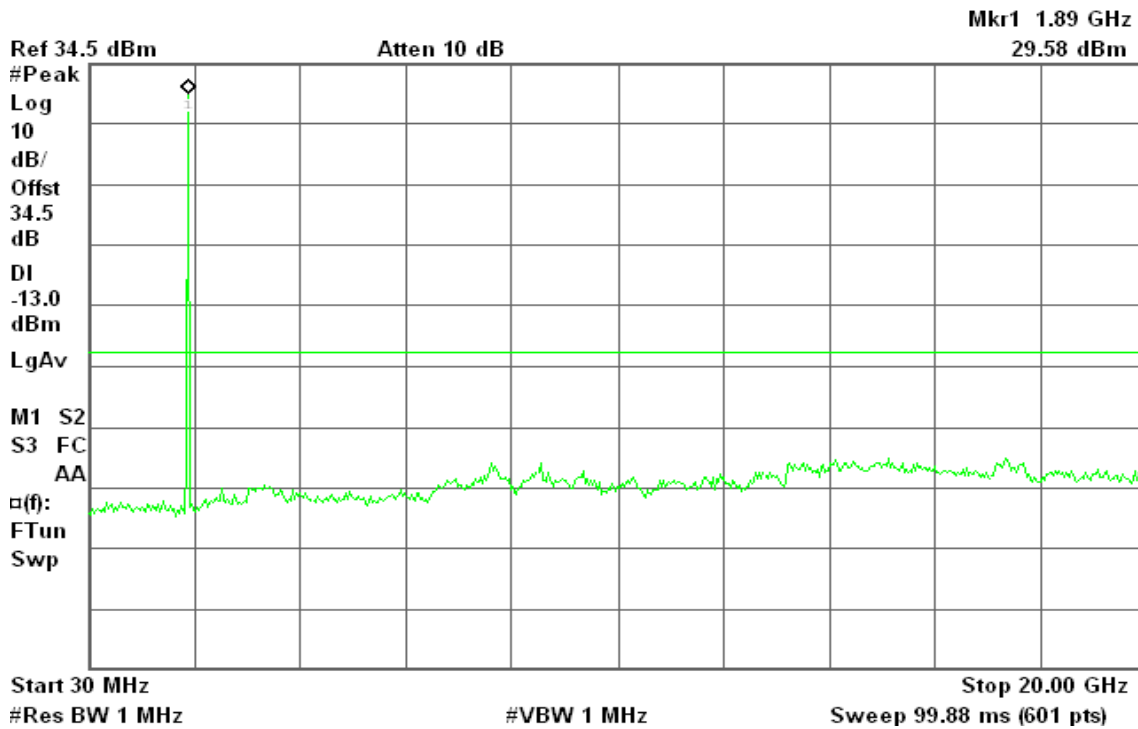



Figure 10-2: Out of Band emission at antenna terminals – GSM CH Mid

Agilent 23:12:42 Sep 3, 1970

R T

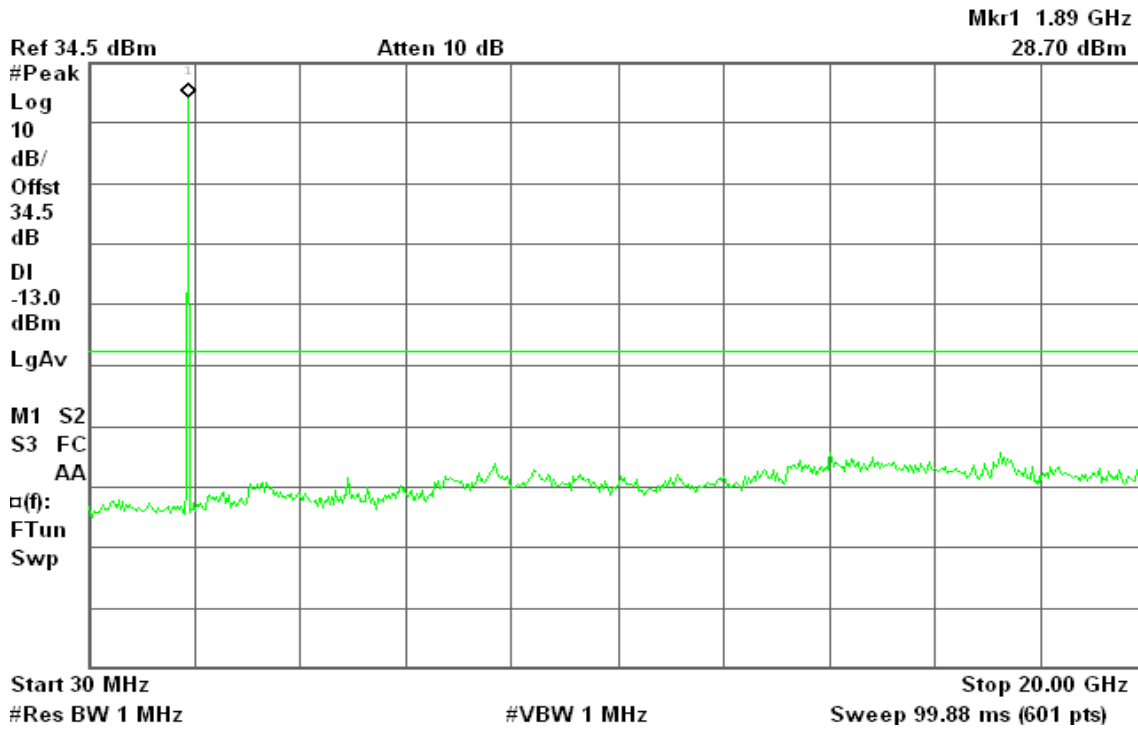
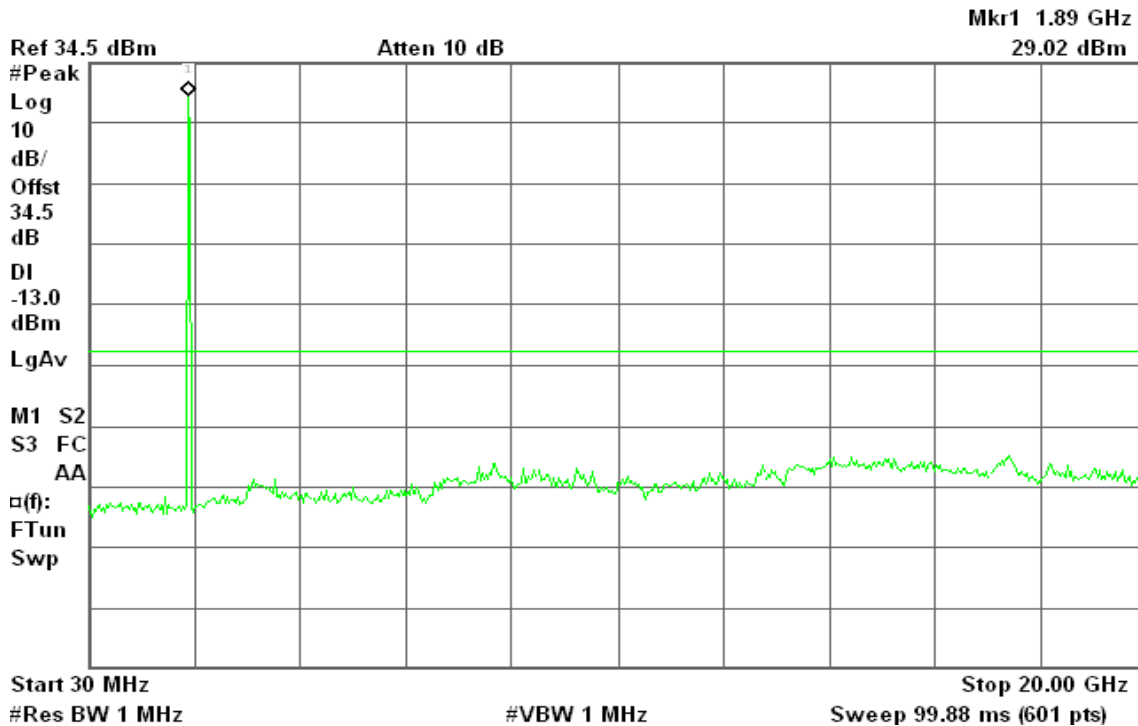

Figure 10-3: Out of Band emission at antenna terminals – GSM CH High

Agilent 23:13:11 Sep 3, 1970

R T





GSM 850

Figure 11-1: Band Edge emissions – GSM CH Low

Agilent 15:07:38 May 21, 2010

R T

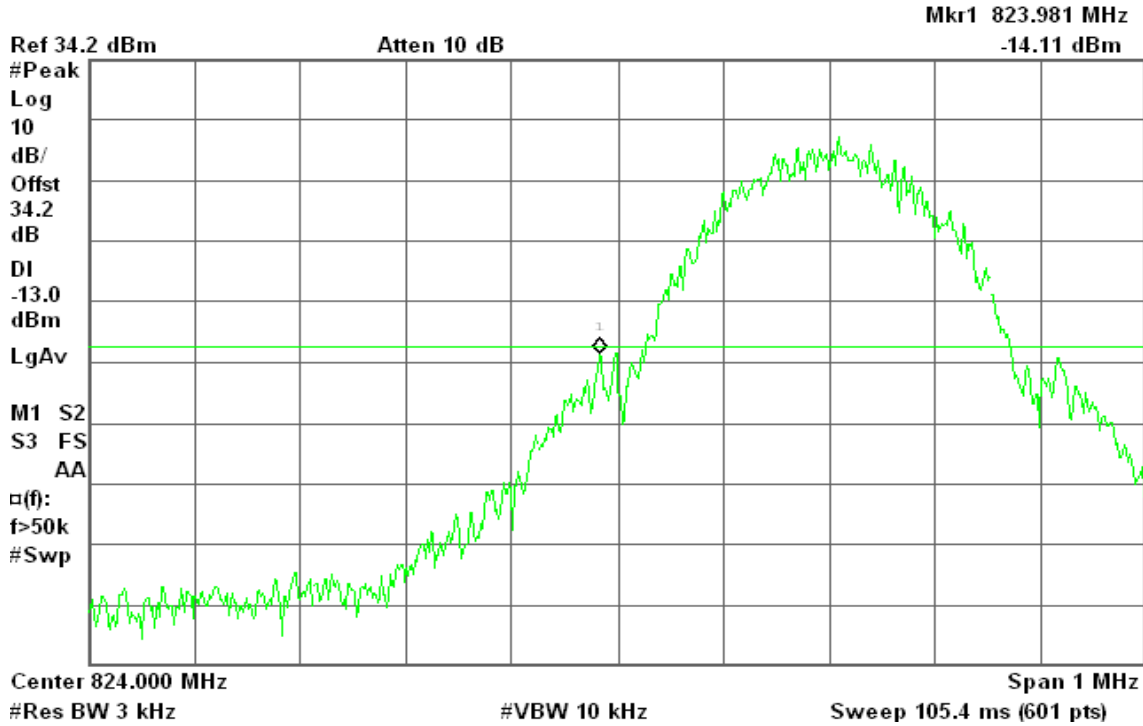
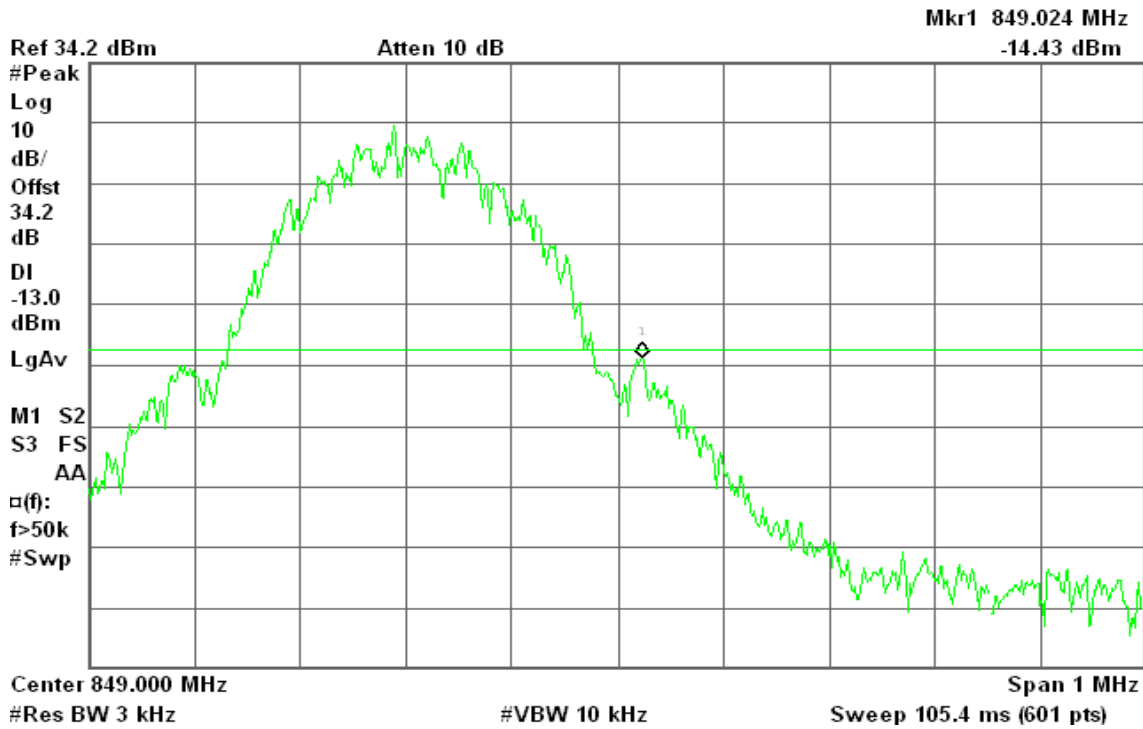

Figure 11-2: Band Edge emissions – GSM CH High

Agilent 15:06:28 May 21, 2010

R T





GPRS 850

Figure 12-1: Band Edge emissions – GPRS CH Low

Agilent 15:40:39 May 21, 2010

R T

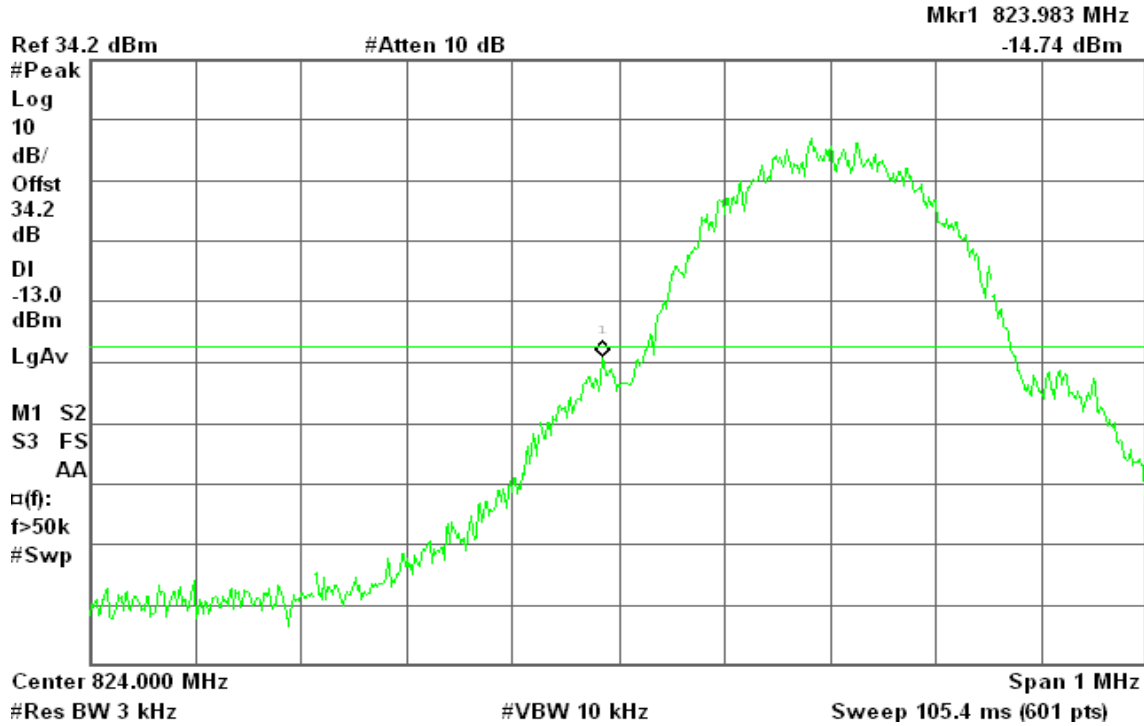
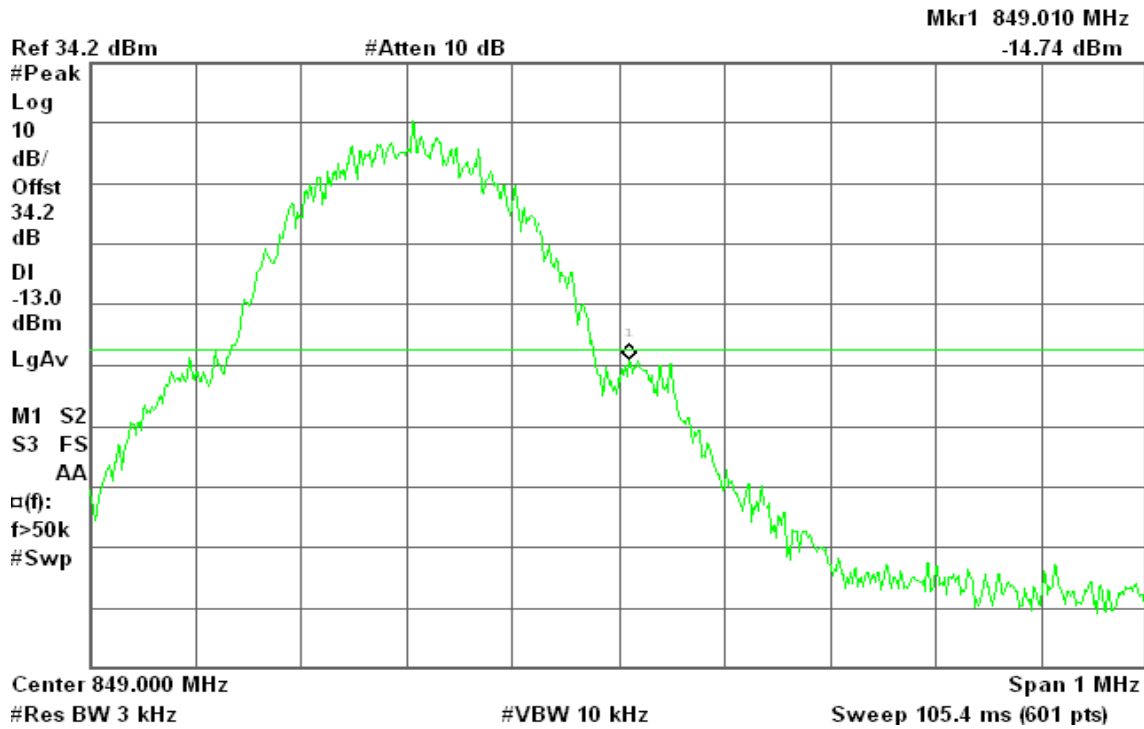

Figure 12-2: Band Edge emissions –GPRS CH High

Agilent 15:39:48 May 21, 2010

R T





GSM 1900

Figure 13-1: Band Edge emissions – GSM CH Low

Agilent 09:10:29 May 21, 2010

R T

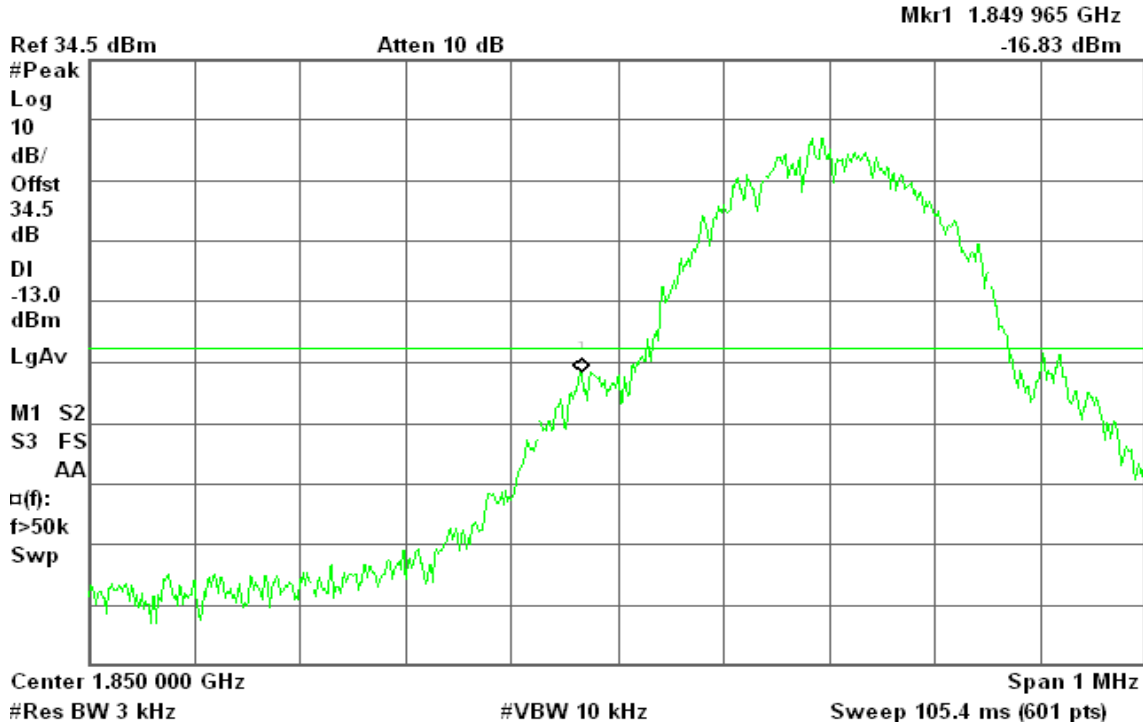
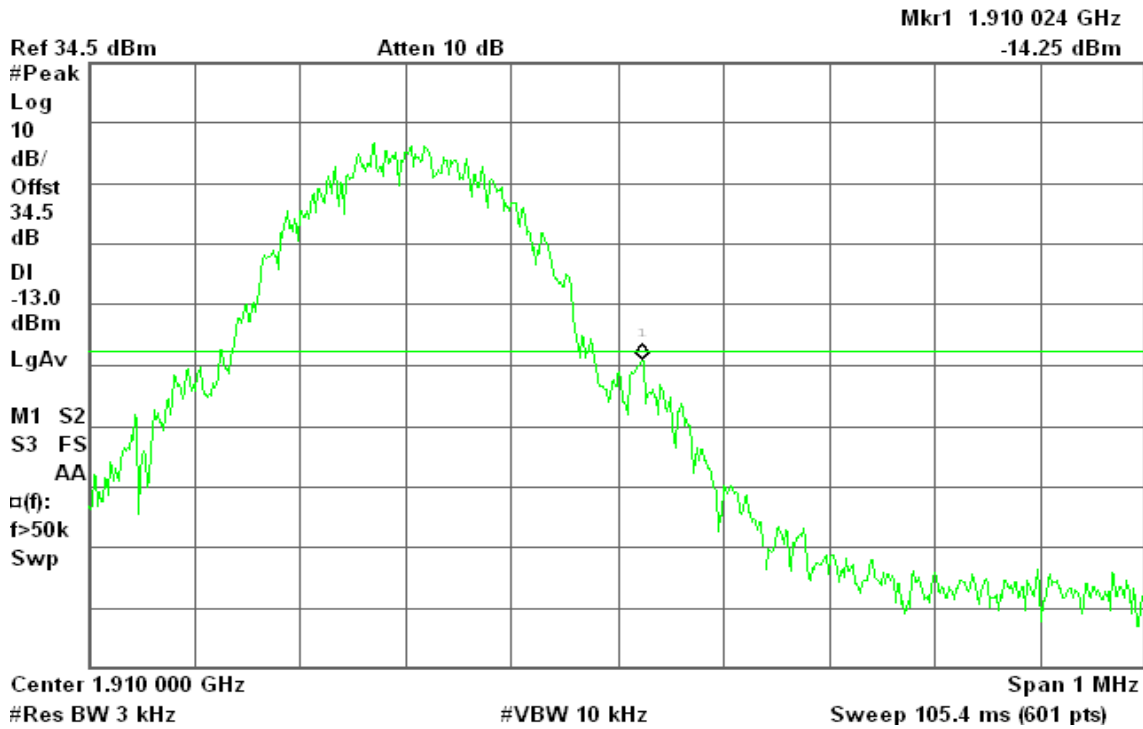

Figure 13-2: Band Edge emissions – GSM CH High

Agilent 09:08:54 May 21, 2010

R T





GPRS 1900

Figure 14-1: Band Edge emissions – GPRS CH Low

Agilent 09:44:00 May 21, 2010

R T

Mkr1 1.849 992 GHz
-15.69 dBm

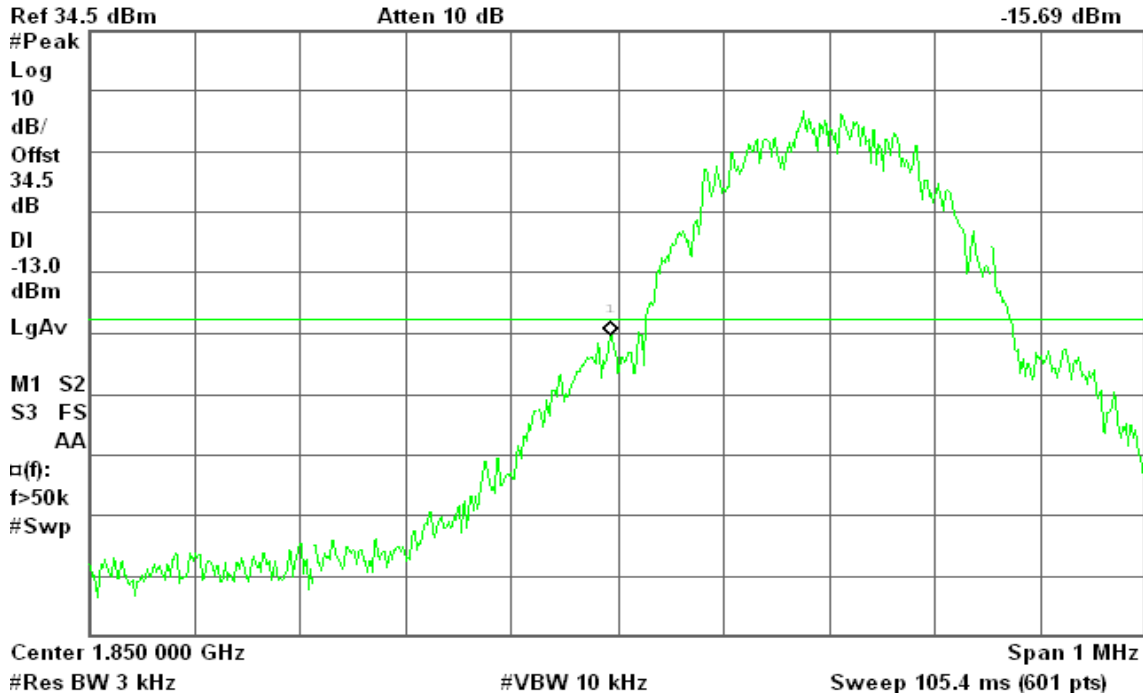
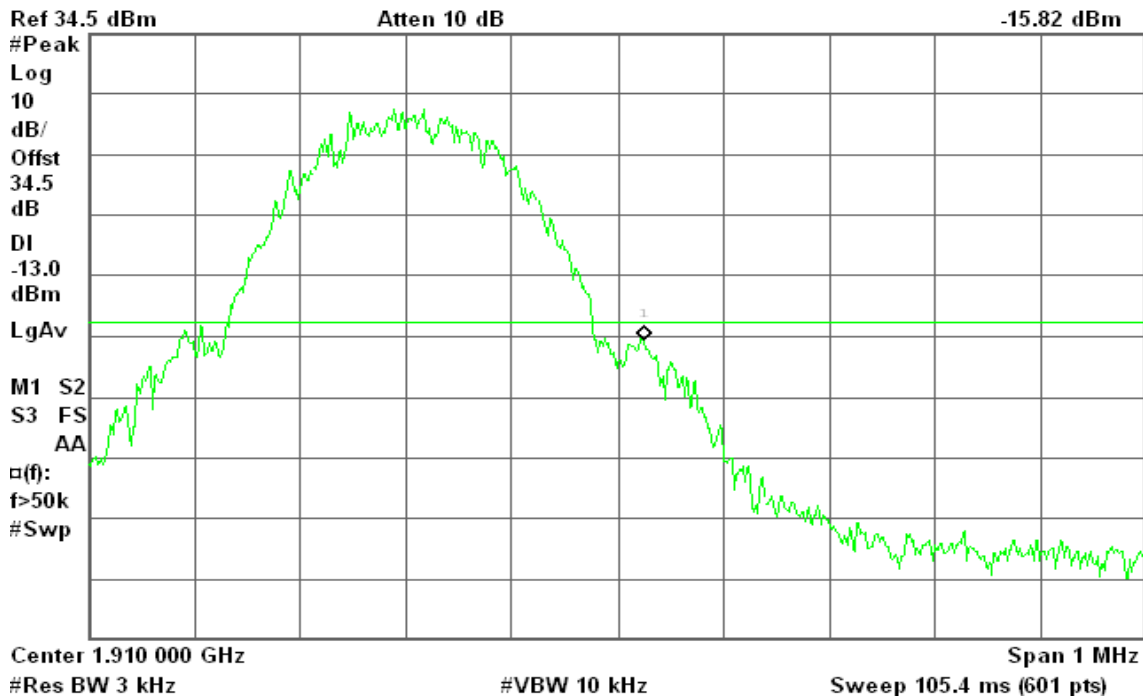

Figure 14-2: Band Edge emissions – GPRS CH High

Agilent 09:42:48 May 21, 2010

R T

Mkr1 1.910 025 GHz
-15.82 dBm



7.6 FIELD STRENGTH OF SPURIOUS RADIATION MEASUREMENT

LIMIT

According to FCC §2.1053

Test Configuration

Below 1 GHz

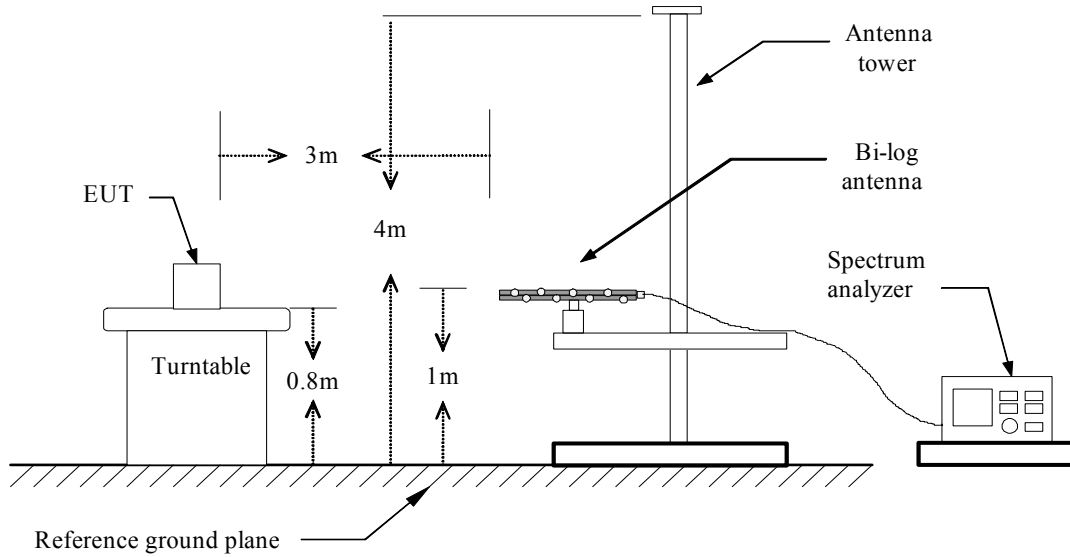

Above 1 GHz

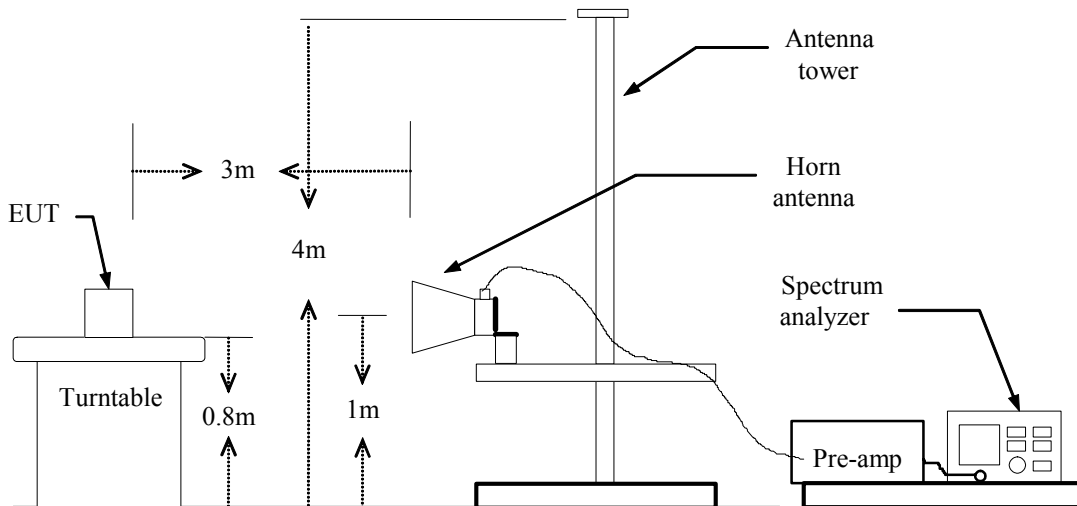

Substituted Method Test Set-up

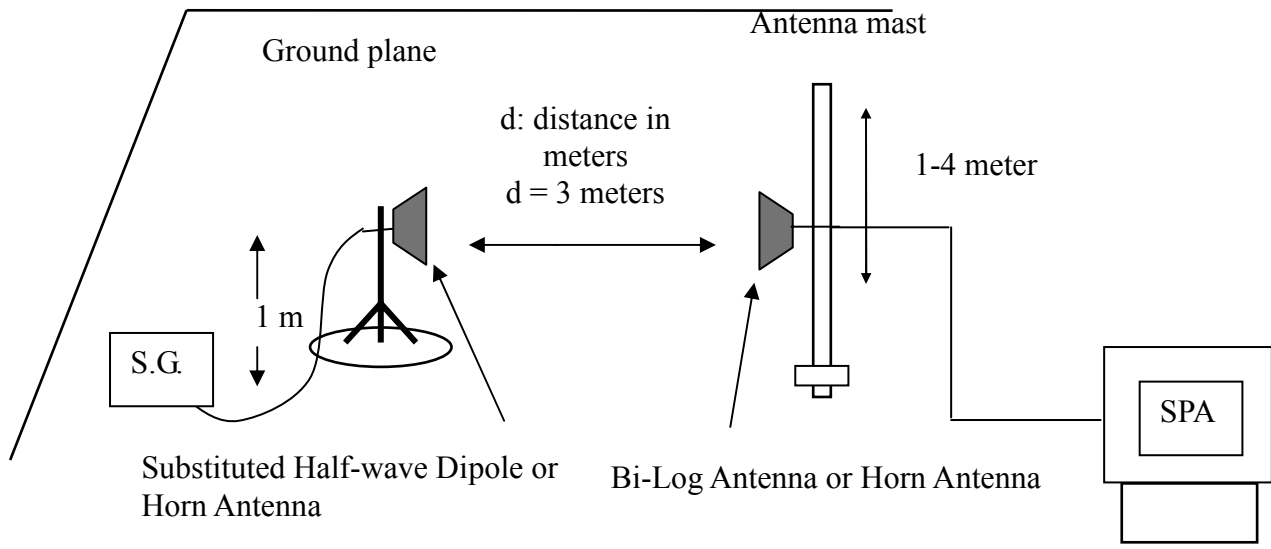

TEST PROCEDURE

The EUT was placed on a non-conductive, the measurement antenna was placed at a distance of 3 meters from the EUT. During the tests, the antenna height and the EUT azimuth were varied in order to identify the maximum level of emissions from the EUT. This maximization process was repeated with the EUT positioned in each of its three orthogonal orientations.

The frequency range up to tenth harmonic was investigated for each of three fundamental frequency (low, middle and high channels). Once spurious emission were identified, the power of the emission was determined using the substitution method.

The spurious emissions attenuation was calculated as the difference between radiated power at the fundamental frequency and the spurious emissions frequency.

$$ERP = \text{S.G. output (dBm)} + \text{Antenna Gain (dBd)} - \text{Cable (dB)}$$

$$EIRP = \text{S.G. output (dBm)} + \text{Antenna Gain (dBi)} - \text{Cable (dB)}$$

TEST RESULTS

Refer to the attached tabular data sheets.



Radiated Spurious Emission Measurement Result / Below 1GHz

Operation Mode: GSM 850 / TX / CH 128

Test Date: May 23, 2010

Temperature: 23°C

Tested by: Wolf Huang

Humidity: 51 % RH

Polarity: Ver. / Hor.

Frequency (MHz)	Antenna Polarization (V/H)	Reading (dBm)	Correction Factor (dB)	Emission level (dBm)	Limit (dBm)	Margin (dB)
35.82	V	-56.32	-14.95	-71.27	-13.00	-58.27
99.84	V	-46.78	-18.10	-64.88	-13.00	-51.88
399.57	V	-55.45	-12.10	-67.55	-13.00	-54.55
408.30	V	-56.79	-11.56	-68.34	-13.00	-55.34
512.09	V	-61.19	-8.54	-69.72	-13.00	-56.72
681.84	V	-60.26	-6.58	-66.84	-13.00	-53.84
40.67	H	-64.46	-11.67	-76.13	-13.00	-63.13
99.84	H	-46.49	-18.04	-64.53	-13.00	-51.53
399.57	H	-55.92	-11.72	-67.64	-13.00	-54.64
408.30	H	-53.78	-11.22	-65.00	-13.00	-52.00
512.09	H	-61.97	-8.65	-70.62	-13.00	-57.62
682.81	H	-59.98	-6.57	-66.55	-13.00	-53.55

Remark:

- The emission behaviour belongs to narrowband spurious emission.*
- Measurements above show only up to 6 maximum emissions noted, or would be lesser; with " N/A " remark, if no specific emissions from the EUT are recorded (ie: margin>20dB from the applicable limit) and considered that's already beyond the background noise floor.*



Operation Mode: GSM 850 / TX / CH 190

Test Date: May 23, 2010

Temperature: 23°C

Tested by: Wolf Huang

Humidity: 51 % RH

Polarity: Ver. / Hor.

Frequency (MHz)	Antenna Polarization (V/H)	Reading (dBm)	Correction Factor (dB)	Emission level (dBm)	Limit (dBm)	Margin (dB)
39.70	V	-60.63	-12.78	-73.41	-13.00	-60.41
60.07	V	-54.84	-16.07	-70.90	-13.00	-57.90
130.88	V	-46.84	-12.79	-59.62	-13.00	-46.62
453.89	V	-58.24	-9.93	-68.17	-13.00	-55.17
523.73	V	-60.04	-8.40	-68.44	-13.00	-55.44
967.02	V	-60.49	-3.16	-63.65	-13.00	-50.65
44.55	H	-63.19	-11.72	-74.92	-13.00	-61.92
130.88	H	-46.35	-14.14	-60.50	-13.00	-47.50
191.02	H	-62.85	-14.24	-77.09	-13.00	-64.09
288.02	H	-64.36	-13.11	-77.47	-13.00	-64.47
452.92	H	-54.87	-9.87	-64.73	-13.00	-51.73
523.73	H	-61.49	-8.50	-69.99	-13.00	-56.99

Remark:

1. The emission behaviour belongs to narrowband spurious emission.
2. Measurements above show only up to 6 maximum emissions noted, or would be lesser, with " N/A " remark, if no specific emissions from the EUT are recorded (ie: margin > 20dB from the applicable limit) and considered that's already beyond the background noise floor.



Operation Mode: GSM 850 / TX / CH 251

Test Date: May 23, 2010

Temperature: 23°C

Tested by: Wolf Huang

Humidity: 51 % RH

Polarity: Ver. / Hor.

	Antenna Polarization (V/H)	Reading (dBm)	Correction Factor (dB)	Emission level (dBm)	Limit (dBm)	Margin (dB)
33.88	V	-57.80	-16.06	-73.85	-13.00	-60.85
64.92	V	-55.30	-15.85	-71.15	-13.00	-58.15
125.06	V	-66.77	-13.23	-80.00	-13.00	-67.00
279.29	V	-68.31	-12.18	-80.48	-13.00	-67.48
475.23	V	-67.86	-9.17	-77.03	-13.00	-64.03
728.40	V	-68.23	-6.02	-74.26	-13.00	-61.26
41.64	H	-63.63	-11.68	-75.31	-13.00	-62.31
160.95	H	-48.58	-14.37	-62.95	-13.00	-49.95
191.02	H	-64.05	-14.24	-78.29	-13.00	-65.29
498.51	H	-61.18	-8.82	-70.00	-13.00	-57.00
585.81	H	-62.80	-7.83	-70.63	-13.00	-57.63
645.95	H	-62.48	-6.63	-69.11	-13.00	-56.11

Remark:

1. The emission behaviour belongs to narrowband spurious emission.
2. Measurements above show only up to 6 maximum emissions noted, or would be lesser, with " N/A " remark, if no specific emissions from the EUT are recorded (ie: margin > 20dB from the applicable limit) and considered that's already beyond the background noise floor.



Operation Mode: GPRS 850 / TX / CH 128

Test Date: May 23, 2010

Temperature: 23°C

Tested by: Wolf Huang

Humidity: 51 % RH

Polarity: Ver. / Hor.

Frequency (MHz)	Antenna Polarization (V/H)	Reading (dBm)	Correction Factor (dB)	Emission level (dBm)	Limit (dBm)	Margin (dB)
35.82	V	-51.69	-14.95	-66.64	-13.00	-53.64
61.04	V	-53.23	-16.02	-69.25	-13.00	-56.25
99.84	V	-46.90	-18.10	-65.00	-13.00	-52.00
316.15	V	-54.73	-13.60	-68.33	-13.00	-55.33
398.60	V	-55.63	-12.15	-67.78	-13.00	-54.78
408.30	V	-55.34	-11.56	-66.89	-13.00	-53.89
41.64	H	-63.25	-11.68	-74.93	-13.00	-61.93
99.84	H	-46.94	-18.04	-64.98	-13.00	-51.98
398.60	H	-55.33	-11.73	-67.06	-13.00	-54.06
408.30	H	-52.87	-11.22	-64.09	-13.00	-51.09
512.09	H	-62.30	-8.65	-70.95	-13.00	-57.95
682.81	H	-59.73	-6.57	-66.30	-13.00	-53.30

Remark:

1. The emission behaviour belongs to narrowband spurious emission.
2. Measurements above show only up to 6 maximum emissions noted, or would be lesser, with " N/A " remark, if no specific emissions from the EUT are recorded (ie: margin > 20dB from the applicable limit) and considered that's already beyond the background noise floor.



Operation Mode: GPRS 850 / TX / CH 190

Test Date: May 23, 2010

Temperature: 23°C

Tested by: Wolf Huang

Humidity: 51 % RH

Polarity: Ver. / Hor.

Frequency (MHz)	Antenna Polarization (V/H)	Reading (dBm)	Correction Factor (dB)	Emission level (dBm)	Limit (dBm)	Margin (dB)
35.82	V	-51.54	-14.95	-66.49	-13.00	-53.49
61.04	V	-52.86	-16.02	-68.88	-13.00	-55.88
130.88	V	-46.61	-12.79	-59.40	-13.00	-46.40
453.89	V	-57.79	-9.93	-67.72	-13.00	-54.72
523.73	V	-59.77	-8.40	-68.16	-13.00	-55.16
967.02	V	-60.32	-3.16	-63.48	-13.00	-50.48
39.70	H	-63.28	-11.85	-75.14	-13.00	-62.14
130.88	H	-46.30	-14.14	-60.45	-13.00	-47.45
191.02	H	-63.77	-14.24	-78.01	-13.00	-65.01
453.89	H	-55.05	-9.83	-64.88	-13.00	-51.88
523.73	H	-60.28	-8.50	-68.78	-13.00	-55.78
967.99	H	-60.67	-3.31	-63.98	-13.00	-50.98

Remark:

1. The emission behaviour belongs to narrowband spurious emission.
2. Measurements above show only up to 6 maximum emissions noted, or would be lesser, with " N/A " remark, if no specific emissions from the EUT are recorded (ie: margin > 20dB from the applicable limit) and considered that's already beyond the background noise floor.



Operation Mode: GPRS 850 / TX / CH 251

Test Date: May 23, 2010

Temperature: 23°C

Tested by: Wolf Huang

Humidity: 51 % RH

Polarity: Ver. / Hor.

Frequency (MHz)	Antenna Polarization (V/H)	Reading (dBm)	Correction Factor (dB)	Emission level (dBm)	Limit (dBm)	Margin (dB)
35.82	V	-51.18	-14.95	-66.13	-13.00	-53.13
60.07	V	-52.37	-16.07	-68.43	-13.00	-55.43
160.95	V	-64.30	-14.31	-78.61	-13.00	-65.61
285.11	V	-66.90	-12.10	-79.00	-13.00	-66.00
356.89	V	-65.31	-13.10	-78.41	-13.00	-65.41
569.32	V	-67.29	-7.94	-75.24	-13.00	-62.24
41.64	H	-61.64	-11.68	-73.33	-13.00	-60.33
160.95	H	-47.80	-14.37	-62.17	-13.00	-49.17
191.02	H	-62.67	-14.24	-76.91	-13.00	-63.91
498.51	H	-58.53	-8.82	-67.36	-13.00	-54.36
585.81	H	-59.33	-7.83	-67.17	-13.00	-54.17
644.98	H	-60.19	-6.63	-66.82	-13.00	-53.82

Remark:

1. The emission behaviour belongs to narrowband spurious emission.
2. Measurements above show only up to 6 maximum emissions noted, or would be lesser, with " N/A " remark, if no specific emissions from the EUT are recorded (ie: margin > 20dB from the applicable limit) and considered that's already beyond the background noise floor.



Operation Mode: GSM 1900 / TX / CH 512

Test Date: May 23, 2010

Temperature: 23°C

Tested by: Wolf Huang

Humidity: 51 % RH

Polarity: Ver. / Hor.

Frequency (MHz)	Antenna Polarization (V/H)	Reading (dBm)	Correction Factor (dB)	Emission level (dBm)	Limit (dBm)	Margin (dB)
37.76	V	-60.20	-13.86	-74.07	-13.00	-61.07
61.04	V	-55.48	-16.02	-71.51	-13.00	-58.51
129.91	V	-64.31	-12.73	-77.04	-13.00	-64.04
370.47	V	-62.50	-13.02	-75.52	-13.00	-62.52
588.72	V	-68.10	-7.84	-75.94	-13.00	-62.94
611.03	V	-68.23	-7.27	-75.50	-13.00	-62.50
43.58	H	-63.63	-11.71	-75.34	-13.00	-62.34
126.03	H	-66.08	-14.06	-80.14	-13.00	-67.14
191.02	H	-63.61	-14.24	-77.85	-13.00	-64.85
429.64	H	-67.47	-10.45	-77.92	-13.00	-64.92
590.66	H	-68.99	-7.80	-76.79	-13.00	-63.79
868.08	H	-69.13	-4.17	-73.31	-13.00	-60.31

Remark:

1. Measuring frequencies from 1 GHz to the 10th harmonic of highest fundamental frequency.
2. Measurements above show only up to 6 maximum emissions noted, or would be lesser, with " N/A " remark, if no specific emissions from the EUT are recorded (ie: margin > 20dB from the applicable limit) and considered that's already beyond the background noise floor.



Operation Mode: GSM 1900 / TX / CH 661

Test Date: May 23, 2010

Temperature: 23°C

Tested by: Wolf Huang

Humidity: 51 % RH

Polarity: Ver. / Hor.

Frequency (MHz)	Antenna Polarization (V/H)	Reading (dBm)	Correction Factor (dB)	Emission level (dBm)	Limit (dBm)	Margin (dB)
35.82	V	-58.15	-14.95	-73.10	-13.00	-60.10
65.89	V	-53.74	-15.80	-69.54	-13.00	-56.54
127.00	V	-67.04	-13.03	-80.07	-13.00	-67.07
452.92	V	-67.02	-9.95	-76.97	-13.00	-63.97
471.35	V	-67.63	-9.33	-76.95	-13.00	-63.95
623.64	V	-68.31	-6.87	-75.18	-13.00	-62.18
41.64	H	-64.09	-11.68	-75.77	-13.00	-62.77
64.92	H	-62.50	-17.20	-79.71	-13.00	-66.71
191.02	H	-64.18	-14.24	-78.42	-13.00	-65.42
570.29	H	-68.80	-7.83	-76.63	-13.00	-63.63
698.33	H	-69.20	-6.54	-75.74	-13.00	-62.74
833.16	H	-68.80	-4.76	-73.56	-13.00	-60.56

Remark:

1. *Measuring frequencies from 1 GHz to the 10th harmonic of highest fundamental frequency.*
2. *Measurements above show only up to 6 maximum emissions noted, or would be lesser, with " N/A " remark, if no specific emissions from the EUT are recorded (ie: margin > 20dB from the applicable limit) and considered that's already beyond the background noise floor.*



Operation Mode: GSM 1900 / TX / CH 810

Test Date: May 23, 2010

Temperature: 23°C

Tested by: Wolf Huang

Humidity: 51 % RH

Polarity: Ver. / Hor.

Frequency (MHz)	Antenna Polarization (V/H)	Reading (dBm)	Correction Factor (dB)	Emission level (dBm)	Limit (dBm)	Margin (dB)
35.82	V	-57.45	-14.95	-72.40	-13.00	-59.40
66.86	V	-53.99	-15.76	-69.75	-13.00	-56.75
135.73	V	-66.18	-13.16	-79.33	-13.00	-66.33
288.02	V	-67.13	-12.08	-79.21	-13.00	-66.21
740.04	V	-69.37	-5.92	-75.29	-13.00	-62.29
881.66	V	-69.75	-3.93	-73.68	-13.00	-60.68
40.67	H	-64.46	-11.67	-76.13	-13.00	-63.13
125.06	H	-66.66	-14.06	-80.72	-13.00	-67.72
191.02	H	-63.84	-14.24	-78.08	-13.00	-65.08
489.78	H	-67.40	-8.89	-76.28	-13.00	-63.28
779.81	H	-68.56	-5.32	-73.89	-13.00	-60.89
952.47	H	-69.75	-3.55	-73.31	-13.00	-60.31

Remark:

1. *Measuring frequencies from 1 GHz to the 10th harmonic of highest fundamental frequency.*
2. *Measurements above show only up to 6 maximum emissions noted, or would be lesser, with " N/A " remark, if no specific emissions from the EUT are recorded (ie: margin > 20dB from the applicable limit) and considered that's already beyond the background noise floor.*



Operation Mode: GPRS 1900 / TX / CH 512

Test Date: May 23, 2010

Temperature: 23°C

Tested by: Wolf Huang

Humidity: 51 % RH

Polarity: Ver. / Hor.

Frequency (MHz)	Antenna Polarization (V/H)	Reading (dBm)	Correction Factor (dB)	Emission level (dBm)	Limit (dBm)	Margin (dB)
35.82	V	-52.74	-14.95	-67.69	-13.00	-54.69
64.92	V	-58.02	-15.85	-73.87	-13.00	-60.87
147.37	V	-66.94	-13.18	-80.12	-13.00	-67.12
288.02	V	-68.34	-12.08	-80.42	-13.00	-67.42
639.16	V	-68.23	-6.63	-74.87	-13.00	-61.87
820.55	V	-69.19	-4.72	-73.91	-13.00	-60.91
32.91	H	-61.38	-16.57	-77.94	-13.00	-64.94
44.55	H	-63.37	-11.72	-75.09	-13.00	-62.09
200.72	H	-64.45	-13.48	-77.93	-13.00	-64.93
394.72	H	-67.45	-11.80	-79.24	-13.00	-66.24
563.50	H	-69.01	-7.80	-76.81	-13.00	-63.81
883.60	H	-69.78	-3.80	-73.59	-13.00	-60.59

Remark:

1. *Measuring frequencies from 1 GHz to the 10th harmonic of highest fundamental frequency.*
2. *Measurements above show only up to 6 maximum emissions noted, or would be lesser, with " N/A " remark, if no specific emissions from the EUT are recorded (ie: margin > 20dB from the applicable limit) and considered that's already beyond the background noise floor.*



Operation Mode: GPRS 1900 / TX / CH 661

Test Date: May 23, 2010

Temperature: 25°C

Tested by: Wolf Huang

Humidity: 51 % RH

Polarity: Ver. / Hor.

Frequency (MHz)	Antenna Polarization (V/H)	Reading (dBm)	Correction Factor (dB)	Emission level (dBm)	Limit (dBm)	Margin (dB)
35.82	V	-53.14	-14.95	-68.09	-13.00	-55.09
65.89	V	-57.38	-15.80	-73.19	-13.00	-60.19
130.88	V	-66.23	-12.79	-79.02	-13.00	-66.02
283.17	V	-67.65	-12.11	-79.76	-13.00	-66.76
577.08	V	-68.58	-7.95	-76.53	-13.00	-63.53
961.20	V	-69.22	-3.28	-72.50	-13.00	-59.50
43.58	H	-63.59	-11.71	-75.30	-13.00	-62.30
128.94	H	-66.01	-14.08	-80.09	-13.00	-67.09
191.02	H	-64.18	-14.24	-78.42	-13.00	-65.42
477.17	H	-69.08	-9.05	-78.13	-13.00	-65.13
660.50	H	-68.77	-6.67	-75.43	-13.00	-62.43
868.08	H	-69.55	-4.17	-73.73	-13.00	-60.73

Remark:

1. *Measuring frequencies from 1 GHz to the 10th harmonic of highest fundamental frequency.*
2. *Measurements above show only up to 6 maximum emissions noted, or would be lesser, with " N/A " remark, if no specific emissions from the EUT are recorded (ie: margin > 20dB from the applicable limit) and considered that's already beyond the background noise floor.*



Operation Mode: GPRS 1900 / TX / CH 810

Test Date: May 23, 2010

Temperature: 23°C

Tested by: Wolf Huang

Humidity: 51 % RH

Polarity: Ver. / Hor.

Frequency (MHz)	Antenna Polarization (V/H)	Reading (dBm)	Correction Factor (dB)	Emission level (dBm)	Limit (dBm)	Margin (dB)
35.82	V	-53.28	-14.95	-68.23	-13.00	-55.23
60.07	V	-55.75	-16.07	-71.81	-13.00	-58.81
86.26	V	-58.03	-20.48	-78.51	-13.00	-65.51
102.75	V	-56.91	-17.49	-74.40	-13.00	-61.40
438.37	V	-65.46	-10.31	-75.77	-13.00	-62.77
844.80	V	-68.85	-4.62	-73.47	-13.00	-60.47
44.55	H	-63.46	-11.72	-75.18	-13.00	-62.18
127.97	H	-67.01	-14.08	-81.09	-13.00	-68.09
191.02	H	-64.30	-14.24	-78.54	-13.00	-65.54
381.14	H	-67.25	-12.02	-79.27	-13.00	-66.27
650.80	H	-68.99	-6.65	-75.64	-13.00	-62.64
906.88	H	-69.22	-3.73	-72.95	-13.00	-59.95

Remark:

1. *Measuring frequencies from 1 GHz to the 10th harmonic of highest fundamental frequency.*
2. *Measurements above show only up to 6 maximum emissions noted, or would be lesser, with " N/A " remark, if no specific emissions from the EUT are recorded (ie: margin>20dB from the applicable limit) and considered that's already beyond the background noise floor.*



Above 1GHz

Operation Mode: GSM 850 / TX / CH 128

Test Date: May 23, 2010

Temperature: 23°C

Tested by: Wolf Huang

Humidity: 51 % RH

Polarity: Ver. / Hor.

Frequency (MHz)	Antenna Polarization	Reading level (dBuV)	Correction Factor (dB)	Emission level (dBm)	Limit (dBm)	Margin (dB)
1651.00	V	-43.43	1.61	-41.82	-13.00	-28.82
N/A						
1651.00	H	-50.70	1.42	-49.28	-13.00	-36.28
N/A						

Remark:

1. *Measuring frequencies from 1 GHz to the 10th harmonic of highest fundamental frequency.*
2. *Measurements above show only up to 6 maximum emissions noted, or would be lesser; with " N/A " remark, if no specific emissions from the EUT are recorded (ie: margin > 20dB from the applicable limit) and considered that's already beyond the background noise floor.*



Operation Mode: GSM 850 / TX / CH 190

Test Date: May 23, 2010

Temperature: 23°C

Tested by: Wolf Huang

Humidity: 51 % RH

Polarity: Ver. / Hor.

Frequency (MHz)	Antenna Polarization	Reading level (dBuV)	Correction Factor (dB)	Emission level (dBm)	Limit (dBm)	Margin (dB)
1672.00	V	-44.29	1.63	-42.66	-13.00	-29.66
2512.00	V	-56.47	4.62	-51.85	-13.00	-38.85
N/A						
1672.00	H	-46.95	1.40	-45.55	-13.00	-32.55
N/A						

Remark:

1. Measuring frequencies from 1 GHz to the 10th harmonic of highest fundamental frequency.
2. Measurements above show only up to 6 maximum emissions noted, or would be lesser, with " N/A " remark, if no specific emissions from the EUT are recorded (ie: margin > 20dB from the applicable limit) and considered that's already beyond the background noise floor.



Operation Mode: GSM 850 / TX / CH 251

Test Date: May 23, 2010

Temperature: 23°C

Tested by: Wolf Huang

Humidity: 51 % RH

Polarity: Ver. / Hor.

Frequency (MHz)	Antenna Polarization	Reading level (dBuV)	Correction Factor (dB)	Emission level (dBm)	Limit (dBm)	Margin (dB)
1700.00	V	-46.91	1.64	-45.27	-13.00	-32.27
2547.00	V	-54.05	4.76	-49.29	-13.00	-36.29
N/A						
1700.00	H	-50.30	1.38	-48.92	-13.00	-35.92
N/A						

Remark:

1. Measuring frequencies from 1 GHz to the 10th harmonic of highest fundamental frequency.
2. Measurements above show only up to 6 maximum emissions noted, or would be lesser; with " N/A " remark, if no specific emissions from the EUT are recorded (ie: margin > 20dB from the applicable limit) and considered that's already beyond the background noise floor.



Operation Mode: GPRS 850 / TX / CH 128

Test Date: May 23, 2010

Temperature: 23°C

Tested by: Wolf Huang

Humidity: 51 % RH

Polarity: Ver. / Hor.

Frequency (MHz)	Antenna Polarization	Reading level (dBuV)	Correction Factor (dB)	Emission level (dBm)	Limit (dBm)	Margin (dB)
1651.00	V	-47.22	1.61	-45.60	-13.00	-32.60
N/A						
1651.00	H	-44.95	1.42	-43.53	-13.00	-30.53
2470.00	H	-59.19	4.43	-54.76	-13.00	-41.76
N/A						

Remark:

1. Measuring frequencies from 1 GHz to the 10th harmonic of highest fundamental frequency.
2. Measurements above show only up to 6 maximum emissions noted, or would be lesser, with " N/A " remark, if no specific emissions from the EUT are recorded (ie: margin > 20dB from the applicable limit) and considered that's already beyond the background noise floor.



Operation Mode: GPRS 850 / TX / CH 190

Test Date: May 23, 2010

Temperature: 23°C

Tested by: Wolf Huang

Humidity: 51 % RH

Polarity: Ver. / Hor.

Frequency (MHz)	Antenna Polarization	Reading level (dBuV)	Correction Factor (dB)	Emission level (dBm)	Limit (dBm)	Margin (dB)
1672.00	V	-49.71	1.63	-48.08	-13.00	-35.08
N/A						
1672.00	H	-46.88	1.40	-45.47	-13.00	-32.47
2512.00	H	-55.15	4.69	-50.46	-13.00	-37.46
N/A						

Remark:

1. Measuring frequencies from 1 GHz to the 10th harmonic of highest fundamental frequency.
2. Measurements above show only up to 6 maximum emissions noted, or would be lesser, with " N/A " remark, if no specific emissions from the EUT are recorded (ie: margin > 20dB from the applicable limit) and considered that's already beyond the background noise floor.



Operation Mode: GPRS 850 / TX / CH 251

Test Date: May 23, 2010

Temperature: 25°C

Tested by: Wolf Huang

Humidity: 51 % RH

Polarity: Ver. / Hor.

Frequency (MHz)	Antenna Polarization	Reading level (dBuV)	Correction Factor (dB)	Emission level (dBm)	Limit (dBm)	Margin (dB)
1700.00	V	-53.02	1.64	-51.37	-13.00	-38.37
N/A						
1700.00	H	-47.74	1.38	-46.36	-13.00	-33.36
2547.00	H	-53.51	4.82	-48.68	-13.00	-35.68
N/A						

Remark:

1. Measuring frequencies from 1 GHz to the 10th harmonic of highest fundamental frequency.
2. Measurements above show only up to 6 maximum emissions noted, or would be lesser, with " N/A " remark, if no specific emissions from the EUT are recorded (ie: margin > 20dB from the applicable limit) and considered that's already beyond the background noise floor.



Operation Mode: GSM 1900 / TX / CH 512

Test Date: May 23, 2010

Temperature: 25°C

Tested by: Wolf Huang

Humidity: 51 % RH

Polarity: Ver. / Hor.

Frequency (MHz)	Antenna Polarization	Reading level (dBuV)	Correction Factor (dB)	Emission level (dBm)	Limit (dBm)	Margin (dB)
3702.00	V	-47.90	9.11	-38.79	-13.00	-25.79
5550.00	V	-50.95	10.32	-40.62	-13.00	-27.62
N/A						
3702.00	H	-53.67	8.89	-44.78	-13.00	-31.78
5550.00	H	-52.09	10.12	-41.97	-13.00	-28.97
N/A						

Remark:

1. Measuring frequencies from 1 GHz to the 10th harmonic of highest fundamental frequency.
2. Measurements above show only up to 6 maximum emissions noted, or would be lesser, with " N/A " remark, if no specific emissions from the EUT are recorded (ie: margin > 20dB from the applicable limit) and considered that's already beyond the background noise floor.



Operation Mode: GSM 1900 / TX / CH 661

Test Date: May 23, 2010

Temperature: 25°C

Tested by: Wolf Huang

Humidity: 51 % RH

Polarity: Ver. / Hor.

Frequency (MHz)	Antenna Polarization	Reading level (dBuV)	Correction Factor (dB)	Emission level (dBm)	Limit (dBm)	Margin (dB)
3758.00	V	-50.29	8.98	-41.32	-13.00	-28.32
5641.00	V	-46.69	10.40	-36.28	-13.00	-23.28
N/A						
3758.00	H	-51.76	8.76	-42.99	-13.00	-29.99
5641.00	H	-49.35	10.23	-39.13	-13.00	-26.13
N/A						

Remark:

1. Measuring frequencies from 1 GHz to the 10th harmonic of highest fundamental frequency.
2. Measurements above show only up to 6 maximum emissions noted, or would be lesser, with " N/A " remark, if no specific emissions from the EUT are recorded (ie: margin > 20dB from the applicable limit) and considered that's already beyond the background noise floor.



Operation Mode: GSM 1900 / TX / CH 810

Test Date: May 23, 2010

Temperature: 23°C

Tested by: Wolf Huang

Humidity: 51 % RH

Polarity: Ver. / Hor.

Frequency (MHz)	Antenna Polarization	Reading level (dBuV)	Correction Factor (dB)	Emission level (dBm)	Limit (dBm)	Margin (dB)
3821.00	V	-47.05	8.83	-38.22	-13.00	-25.22
5732.00	V	-47.87	10.48	-37.38	-13.00	-24.38
N/A						
3821.00	H	-48.72	8.62	-40.10	-13.00	-27.10
5732.00	H	-49.36	10.33	-39.03	-13.00	-26.03
N/A						

Remark:

1. Measuring frequencies from 1 GHz to the 10th harmonic of highest fundamental frequency.
2. Measurements above show only up to 6 maximum emissions noted, or would be lesser, with " N/A " remark, if no specific emissions from the EUT are recorded (ie: margin > 20dB from the applicable limit) and considered that's already beyond the background noise floor.



Operation Mode: GPRS 1900 / TX / CH 512

Test Date: May 23, 2010

Temperature: 23°C

Tested by: Wolf Huang

Humidity: 51 % RH

Polarity: Ver. / Hor.

Frequency (MHz)	Antenna Polarization	Reading level (dBuV)	Correction Factor (dB)	Emission level (dBm)	Limit (dBm)	Margin (dB)
3702.00	V	-56.65	9.11	-47.54	-13.00	-34.54
5550.00	V	-47.78	10.32	-37.46	-13.00	-24.46
N/A						
3702.00	H	-53.12	8.89	-44.23	-13.00	-31.23
5550.00	H	-53.11	10.12	-42.98	-13.00	-29.98
N/A						

Remark:

1. Measuring frequencies from 1 GHz to the 10th harmonic of highest fundamental frequency.
2. Measurements above show only up to 6 maximum emissions noted, or would be lesser, with " N/A " remark, if no specific emissions from the EUT are recorded (ie: margin > 20dB from the applicable limit) and considered that's already beyond the background noise floor.



Operation Mode: GPRS 1900 / TX / CH 661

Test Date: May 23, 2010

Temperature: 23°C

Tested by: Wolf Huang

Humidity: 51 % RH

Polarity: Ver. / Hor.

Frequency (MHz)	Antenna Polarization	Reading level (dBuV)	Correction Factor (dB)	Emission level (dBm)	Limit (dBm)	Margin (dB)
3758.00	V	-53.98	8.98	-45.00	-13.00	-32.00
5641.00	V	-47.57	10.40	-37.17	-13.00	-24.17
N/A						
3758.00	H	-50.22	8.76	-41.46	-13.00	-28.46
5641.00	H	-49.43	10.23	-39.21	-13.00	-26.21
N/A						

Remark:

1. Measuring frequencies from 1 GHz to the 10th harmonic of highest fundamental frequency.
2. Measurements above show only up to 6 maximum emissions noted, or would be lesser, with " N/A " remark, if no specific emissions from the EUT are recorded (ie: margin > 20dB from the applicable limit) and considered that's already beyond the background noise floor.



Operation Mode: GPRS 1900 / TX / CH 810

Test Date: May 23, 2010

Temperature: 23°C

Tested by: Wolf Huang

Humidity: 51 % RH

Polarity: Ver. / Hor.

Frequency (MHz)	Antenna Polarization	Reading level (dBuV)	Correction Factor (dB)	Emission level (dBm)	Limit (dBm)	Margin (dB)
3821.00	V	-52.06	8.83	-43.23	-13.00	-30.23
5732.00	V	-50.56	10.48	-40.08	-13.00	-27.08
N/A						
3821.00	H	-48.28	8.62	-39.67	-13.00	-26.67
5732.00	H	-50.28	10.33	-39.96	-13.00	-26.96
N/A						

Remark:

1. Measuring frequencies from 1 GHz to the 10th harmonic of highest fundamental frequency.
2. Measurements above show only up to 6 maximum emissions noted, or would be lesser, with " N/A " remark, if no specific emissions from the EUT are recorded (ie: margin > 20dB from the applicable limit) and considered that's already beyond the background noise floor.

7.7 FREQUENCY STABILITY V.S. TEMPERATURE MEASUREMENT

LIMIT

According to FCC §2.1055, FCC §22.355, .FCC §24.235.

Frequency Tolerance: 2.5 ppm

Test Configuration

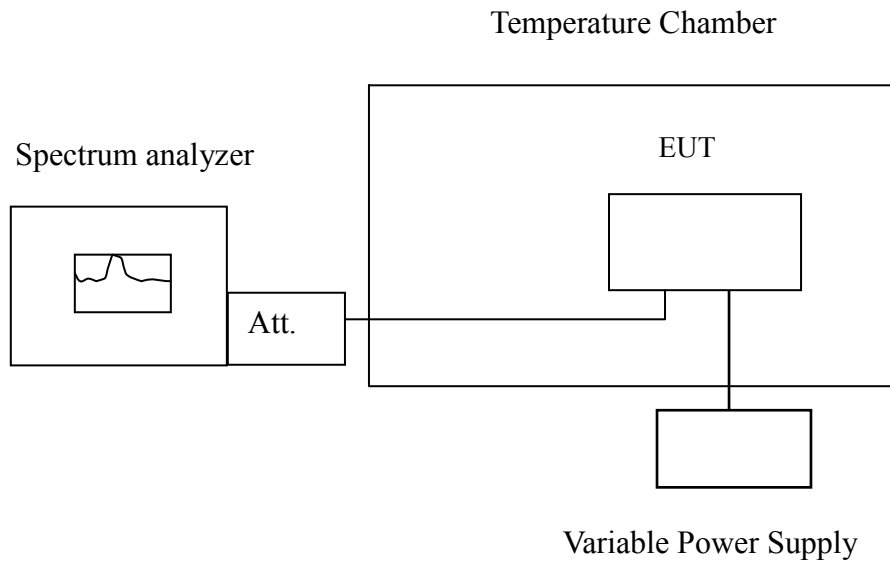

Remark: Measurement setup for testing on Antenna connector



TEST PROCEDURE

The equipment under test was connected to an external AC or DC power supply and input rated voltage. RF output was connected to a frequency counter or spectrum analyzer via feed through attenuators. The EUT was placed inside the temperature chamber. Set the spectrum analyzer RBW low enough to obtain the desired frequency resolution and measure EUT 20°C operating frequency as reference frequency. Turn EUT off and set the chamber temperature to -30°C. After the temperature stabilized for approximately 30 minutes recorded the frequency. Repeat step measure with 10°C increased per stage until the highest temperature of +50°C reached.

TEST RESULTS

No non-compliance noted.

Reference Frequency: GSM Mid Channel 836.6 MHz @ 20°C				
Limit: ± 2.5 ppm = 2090 Hz				
Power Supply Vdc	Environment Temperature (°C)	Frequency (Hz)	Delta (Hz)	Limit (Hz)
3.7	50	836600001	-2	2090
	40	836600000	-3	
	30	836599998	-5	
	20	836600003	0	
	10	836599996	-7	
	0	836599994	-9	
	-10	836599997	-6	
	-20	836600006	3	
	-30	836600002	-1	

Reference Frequency: GSM Mid Channel 1880 MHz @ 20°C				
Limit: ± 2.5 ppm = 4700 Hz				
Power Supply Vdc	Environment Temperature (°C)	Frequency (Hz)	Delta (Hz)	Limit (Hz)
3.7	50	1880000004	13	4700
	40	1880000011	20	
	30	1880000009	18	
	20	1879999991	0	
	10	1880000013	22	
	0	1880000005	14	
	-10	1880000014	23	
	-20	1880000013	22	
	-30	1880000020	29	



Reference Frequency: GPRS Mid Channel 836.6 MHz @ 20°C				
Limit: +/- 2.5 ppm = 2090 Hz				
Power Supply Vdc	Environment Temperature (°C)	Frequency (Hz)	Delta (Hz)	Limit (Hz)
3.7	50	836600007	8	2090
	40	836600009	10	
	30	836600004	5	
	20	836599999	0	
	10	836600002	3	
	0	836599997	-2	
	-10	836599998	-1	
	-20	836600001	2	
	-30	836600005	6	

Reference Frequency: GPRS Mid Channel 1880 MHz @ 20°C				
Limit: ± 2.5 ppm = 4700 Hz				
Power Supply Vdc	Environment Temperature (°C)	Frequency (Hz)	Delta (Hz)	Limit (Hz)
3.7	50	1880000004	20	4700
	40	1880000011	27	
	30	1880000001	17	
	20	1879999984	0	
	10	1880000014	30	
	0	1880000009	25	
	-10	1880000013	29	
	-20	1880000005	21	
	-30	1880000009	25	

7.8 FREQUENCY STABILITY V.S. VOLTAGE MEASUREMENT

LIMIT

According to FCC §2.1055, FCC §22.355, .FCC §24.235,

Test Configuration

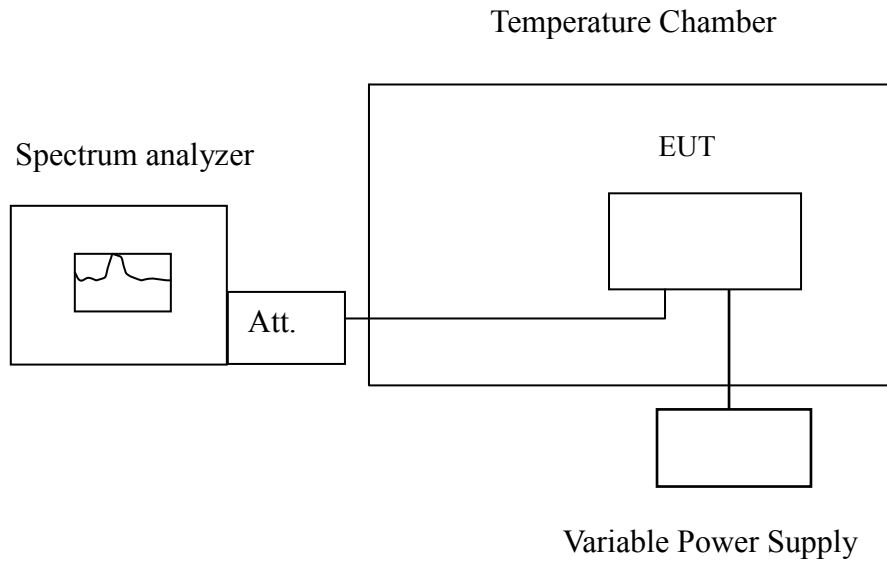

Remark: Measurement setup for testing on Antenna connector.



TEST PROCEDURE

Set chamber temperature to 20°C. Use a variable AC power supply / DC power source to power the EUT and set the voltage to rated voltage. Set the spectrum analyzer RBW low enough to obtain the desired frequency resolution and recorded the frequency.

Reduce the input voltage to specify extreme voltage variation (± 15%) and endpoint, record the maximum frequency change.

TEST RESULTS

No non-compliance noted.

Reference Frequency: GSM Mid Channel 836.6 MHz @ 20°C				
Limit: ± 2.5 ppm = 2090Hz				
Power Supply Vdc	Environment Temperature (°C)	Frequency (Hz)	Delta (Hz)	Limit (Hz)
4.255	20	836600005	2	2090
3.7		836600003	0	
3.145		836600001	-2	
2.9 (End Point)		836599679	-322	

Reference Frequency: GSM Mid Channel 1880 MHz @ 20°C				
Limit: ± 2.5 ppm = 4700 Hz				
Power Supply Vdc	Environment Temperature (°C)	Frequency (Hz)	Delta (Hz)	Limit (Hz)
4.255	20	1879999994	3	4700
3.7		1879999991	0	
3.145		1879999988	-3	
2.9 (End Point)		1879999770	-221	



Reference Frequency: GPRS Mid Channel 836.6 MHz @ 20°C				
Limit: ± 2.5 ppm = 2090Hz				
Power Supply Vdc	Environment Temperature (°C)	Frequency (Hz)	Delta (Hz)	Limit (Hz)
4.255	20	836599998	-1	2090
3.7		836599999	0	
3.145		836599996	-3	
2.9 (End Point)		836599646	-350	

Reference Frequency: GPRS Mid Channel 1880 MHz @ 20°C				
Limit: ± 2.5 ppm = 4700 Hz				
Power Supply Vdc	Environment Temperature (°C)	Frequency (Hz)	Delta (Hz)	Limit (Hz)
4.255	20	1879999983	-1	4700
3.7		1879999984	0	
3.145		1879999990	6	
2.9 (End Point)		1879999811	-173	



7.9 POWERLINE CONDUCTED EMISSIONS

LIMIT

For an intentional radiator which is designed to be connected to the public utility (AC) power line, the radio frequency voltage that is conducted back onto the AC power line on any frequency or frequencies within the band 150 kHz to 30 MHz shall not exceed 250 microvolts (The limit decreases linearly with the logarithm of the frequency in the range 0.15 MHz to 0.50 MHz). The limits at specific frequency range is listed as follows:

Frequency Range (MHz)	Limits (dB μ V)	
	Quasi-peak	Average
0.15 to 0.50	66 to 56	56 to 46
0.50 to 5	56	46
5 to 30	60	50

Compliance with this provision shall be based on the measurement of the radio frequency voltage between each power line (LINE and NEUTRAL) and ground at the power terminals.

Test Configuration

See test photographs attached in Appendix I for the actual connections between EUT and support equipment.

TEST PROCEDURE

1. The EUT was placed on a table, which is 0.8m above ground plane.
2. Maximum procedure was performed on the six highest emissions to ensure EUT compliance.
3. Repeat above procedures until all frequency measured were complete.

**TEST RESULTS**

The initial step in collecting conducted data is a spectrum analyzer peak scan of the measurement range. Significant peaks are then marked as shown on the following data page, and these signals are then quasi-peaked.

Operation Mode: Power Adapter Mode **Test Date:** May 24, 2010
Temperature: 26°C **Tested by:** Wolf Huang
Humidity: 60% RH

Freq. (MHz)	QP Reading (dBuV)	AV Reading (dBuV)	Corr. factor (dB)	QP Result (dBuV)	AV Result (dBuV)	QP Limit (dBuV)	AV Limit (dBuV)	QP Margin (dB)	AV Margin (dB)	Note
0.1500	44.48	31.78	0.22	44.70	32.00	66.00	56.00	-21.30	-24.00	L1
0.2222	40.93	28.73	0.17	41.10	28.90	62.74	52.74	-21.64	-23.84	L1
0.6400	41.54	32.44	0.06	41.60	32.50	56.00	46.00	-14.40	-13.50	L1
1.5150	39.45	25.75	0.05	39.50	25.80	56.00	46.00	-16.50	-20.20	L1
1.8950	40.35	25.75	0.05	40.40	25.80	56.00	46.00	-15.60	-20.20	L1
5.7850	37.98	22.28	0.22	38.20	22.50	60.00	50.00	-21.80	-27.50	L1
0.1524	46.48	33.58	0.22	46.70	33.80	65.87	55.87	-19.17	-22.07	L2
0.2269	39.63	26.33	0.17	39.80	26.50	62.56	52.56	-22.76	-26.06	L2
0.2975	39.86	24.36	0.14	40.00	24.50	60.31	50.31	-20.31	-25.81	L2
0.8310	36.95	18.95	0.05	37.00	19.00	56.00	46.00	-19.00	-27.00	L2
1.5350	34.65	10.25	0.05	34.70	10.30	56.00	46.00	-21.30	-35.70	L2
5.9200	33.87	19.87	0.23	34.10	20.10	60.00	50.00	-25.90	-29.90	L2

Remark:

1. Measuring frequencies from 0.15 MHz to 30MHz.
2. The emissions measured in frequency range from 0.15 MHz to 30MHz were made with an instrument using Quasi-peak detector and average detector.
3. The IF bandwidth of SPA between 0.15MHz and 30MHz was 10kHz; the IF bandwidth of Test Receiver between 0.15MHz and 30MHz was 9kHz;
4. L1 = Line One (Live Line) / L2 = Line Two (Neutral Line)



Test Plots

Conducted emissions (Line 1)

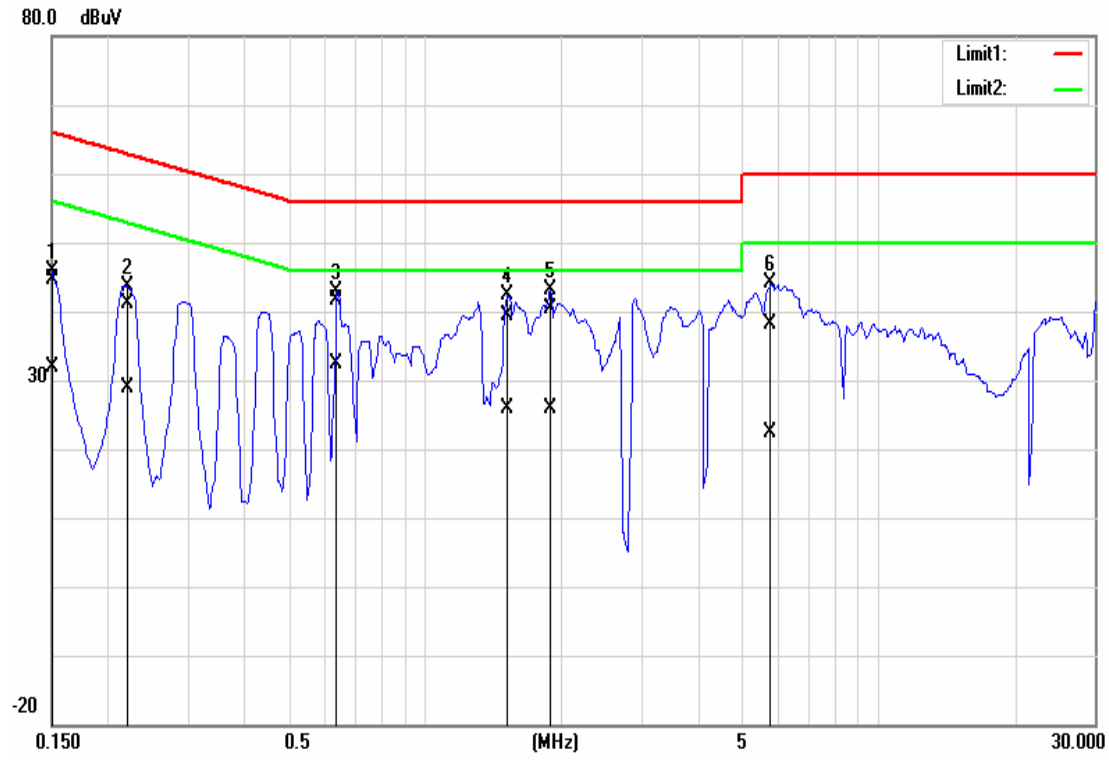

Conducted emissions (Line 2)

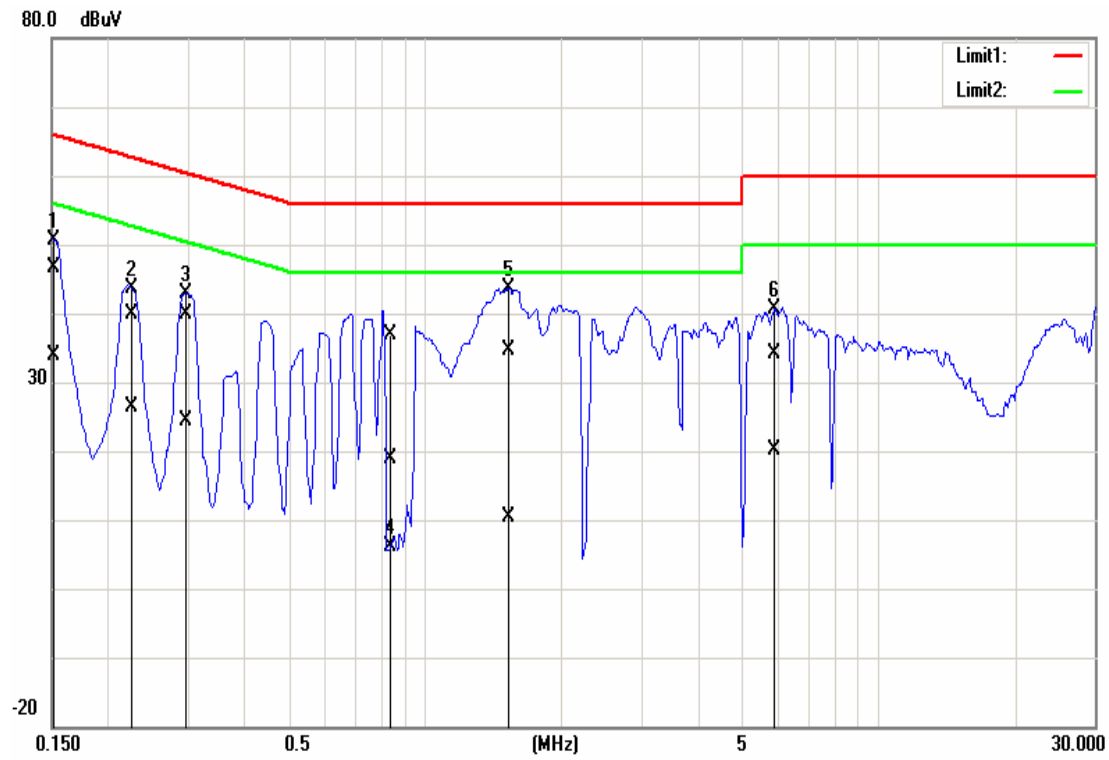

**Test Data****Operation Mode:** USB Cable Mode**Test Date:** May 24, 2010**Temperature:** 26°C**Tested by:** Wolf Huang**Humidity:** 60% RH

Freq. (MHz)	QP Reading (dBuV)	AV Reading (dBuV)	Corr. factor (dB)	QP Result (dBuV)	AV Result (dBuV)	QP Limit (dBuV)	AV Limit (dBuV)	QP Margin (dB)	AV Margin (dB)	Note
0.1500	40.58	13.98	0.22	40.80	14.20	66.00	56.00	-25.20	-41.80	L1
0.2000	51.22	45.42	0.18	51.40	45.60	63.61	53.61	-12.21	-8.01	L1
0.2650	45.95	39.75	0.15	46.10	39.90	61.27	51.27	-15.17	-11.37	L1
4.9311	43.95	37.05	0.15	44.10	37.20	56.00	46.00	-11.90	-8.80	L1
5.2653	45.23	38.63	0.17	45.40	38.80	60.00	50.00	-14.60	-11.20	L1
6.1330	46.55	44.35	0.25	46.80	44.60	60.00	50.00	-13.20	-5.40	L1
0.1500	38.38	13.08	0.22	38.60	13.30	66.00	56.00	-27.40	-42.70	L2
0.2000	49.52	44.42	0.18	49.70	44.60	63.61	53.61	-13.91	-9.01	L2
0.2650	45.25	39.35	0.15	45.40	39.50	61.27	51.27	-15.87	-11.77	L2
4.4814	40.77	35.27	0.13	40.90	35.40	56.00	46.00	-15.10	-10.60	L2
4.7500	43.06	36.26	0.14	43.20	36.40	56.00	46.00	-12.80	-9.60	L2
6.0219	47.86	45.46	0.24	48.10	45.70	60.00	50.00	-11.90	-4.30	L2

Remark:

1. Measuring frequencies from 0.15 MHz to 30MHz.
2. The emissions measured in frequency range from 0.15 MHz to 30MHz were made with an instrument using Quasi-peak detector and average detector.
3. The IF bandwidth of SPA between 0.15MHz and 30MHz was 10kHz; the IF bandwidth of Test Receiver between 0.15MHz and 30MHz was 9kHz;
4. L1 = Line One (Live Line) / L2 = Line Two (Neutral Line)



Test Plots

Conducted emissions (Line 1)

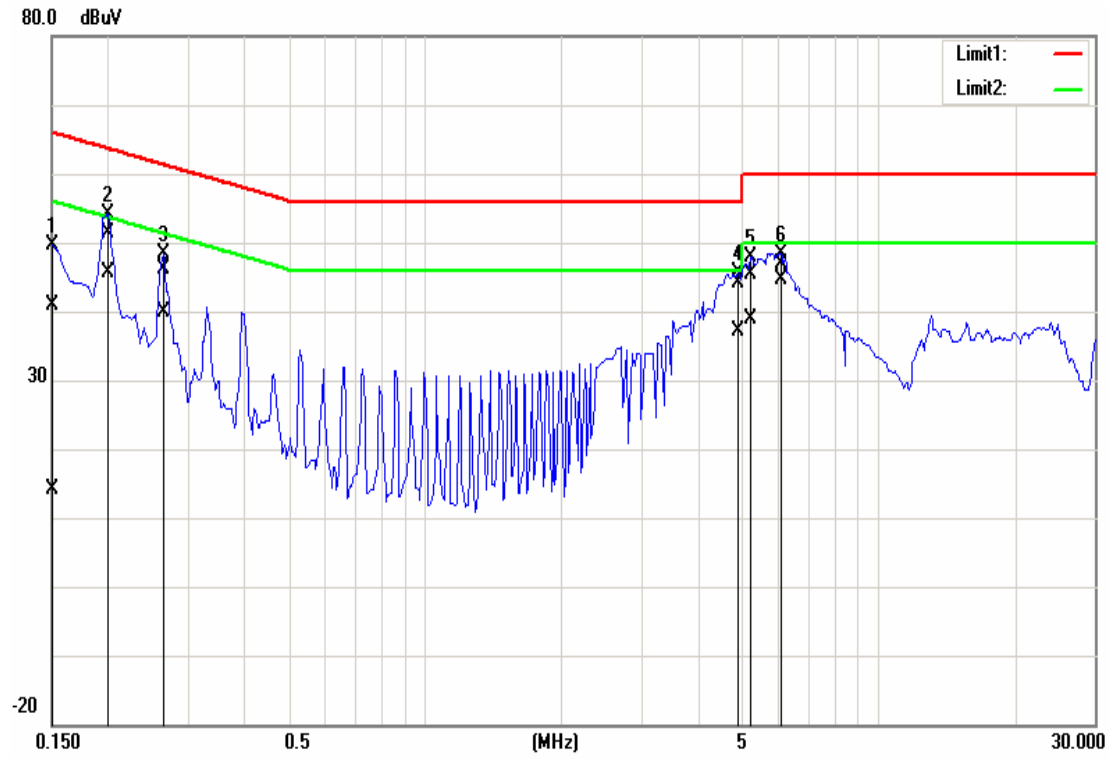

Conducted emissions (Line 2)

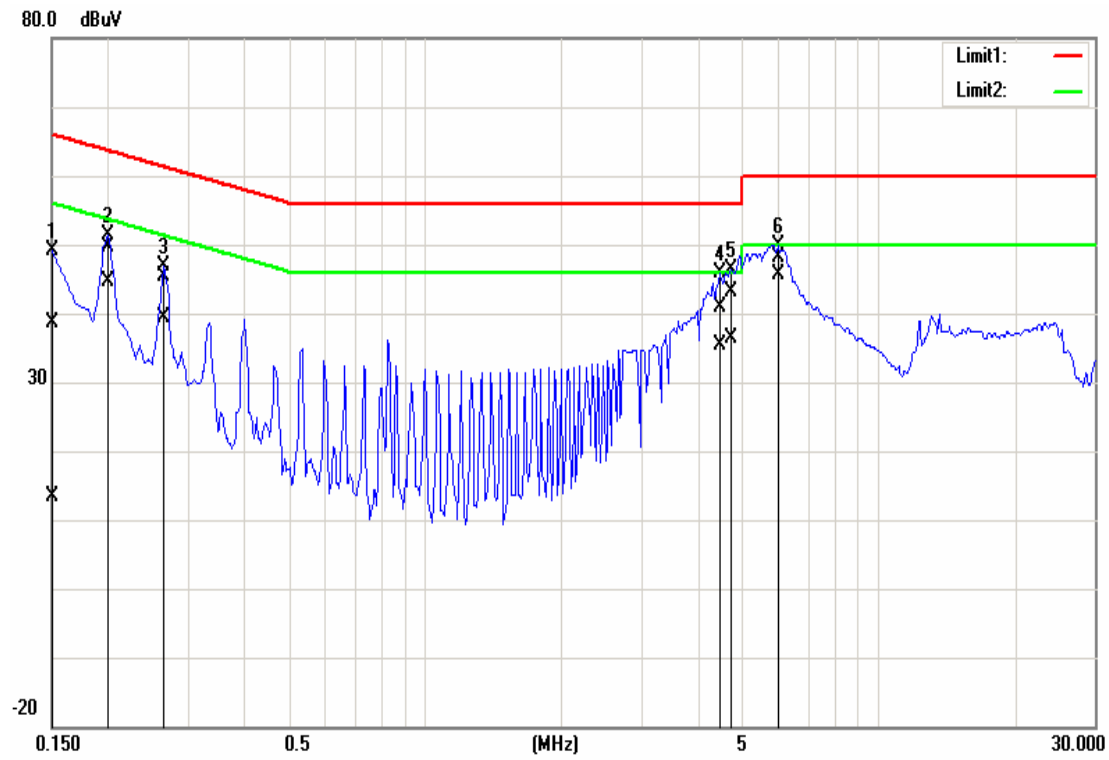



APPENDIX I RADIO FREQUENCY EXPOSURE

LIMIT

EUT Specification

EUT	Mobile Phone
Frequency band (Operating)	<input type="checkbox"/> WLAN: 2.412GHz ~ 2.462GHz <input type="checkbox"/> WLAN: 5.18GHz ~ 5.32GHz / 5.50GHz ~ 5.70GHz <input type="checkbox"/> WLAN: 5.745GHz ~ 5.825GHz <input checked="" type="checkbox"/> Others: GSM / GPRS 850MHz: 824.2 ~ 848.8 MHz
Device category	<input checked="" type="checkbox"/> Portable (<20cm separation) <input type="checkbox"/> Mobile (>20cm separation) <input type="checkbox"/> Others _____
Exposure classification	<input type="checkbox"/> Occupational/Controlled exposure (S = 5mW/cm ²) <input checked="" type="checkbox"/> General Population/Uncontrolled exposure (S=1mW/cm ²)
Antenna diversity	<input checked="" type="checkbox"/> Single antenna <input type="checkbox"/> Multiple antennas <input type="checkbox"/> Tx diversity <input type="checkbox"/> Rx diversity <input type="checkbox"/> Tx/Rx diversity
Max. output power	ERP: 31.46 dBm (1399.59 mW)
Antenna gain (Max)	-4.16 dBi (Numeric gain: 0.38)
Evaluation applied	<input type="checkbox"/> MPE Evaluation <input checked="" type="checkbox"/> SAR Evaluation* <input type="checkbox"/> N/A
Remark:	
1. The maximum output power is <u>31.46dBm (1399.59mW)</u> at <u>824.30MHz</u> (with <u>0.38 numeric antenna gain.</u>) 2. DTS device is not subject to routine RF evaluation; MPE estimate is used to justify the compliance.	

TEST RESULTS

No non-compliance noted.

Not applicable, Please refers to the SAR test report.

**EUT Specification**

EUT	Mobile Phone
Frequency band (Operating)	<input type="checkbox"/> WLAN: 2.412GHz ~ 2.462GHz <input type="checkbox"/> WLAN: 5.725GHz ~ 5.850GHz <input type="checkbox"/> WLAN: 5.15GHz ~ 5.35GHz <input checked="" type="checkbox"/> Others: GSM / GPRS: 1900: 1850.2 ~ 1909.8 MHz
Device category	<input checked="" type="checkbox"/> Portable (<20cm separation) <input type="checkbox"/> Mobile (>20cm separation) <input type="checkbox"/> Others
Exposure classification	<input type="checkbox"/> Occupational/Controlled exposure (S = 5mW/cm2) <input checked="" type="checkbox"/> General Population/Uncontrolled exposure (S=1mW/cm2)
Antenna diversity	<input checked="" type="checkbox"/> Single antenna <input type="checkbox"/> Multiple antennas <input type="checkbox"/> Tx diversity <input type="checkbox"/> Rx diversity <input type="checkbox"/> Tx/Rx diversity
Max. output power	ERP: 31.41 dBm (1383.57mW)
Antenna gain (Max)	-4.23 dBi (Numeric gain: 038)
Evaluation applied	<input type="checkbox"/> MPE Evaluation <input checked="" type="checkbox"/> SAR Evaluation* <input type="checkbox"/> N/A
Remark:	
1. The maximum output power is <u>31.41dBm (1383.57mW)</u> at <u>1909.70MHz</u> (with <u>0.38 numeric antenna gain.</u>) 2. DTS device is not subject to routine RF evaluation; MPE estimate is used to justify the compliance.	

TEST RESULTS

No non-compliance noted.

Not applicable, Please refers to the SAR test report.