



FCC TEST REPORT (Bluetooth)

REPORT NO.: RF990421C04
MODEL NO.: EX115, EX112
RECEIVED: Apr. 21, 2010
TESTED: Apr. 23 ~ May 07, 2010
ISSUED: May 13, 2010

APPLICANT: Motorola Inc

ADDRESS: Mobile Devices 600 N. U.S. Highway 45,
Libertyville, Illinois, United States, 60048-5343

ISSUED BY: Bureau Veritas Consumer Products Services
(H.K.) Ltd., Taoyuan Branch

LAB ADDRESS: No. 47, 14th Ling, Chia Pau Tsuen, Lin Kou
Hsiang, Taipei Hsien 244, Taiwan, R.O.C.

TEST LOCATION: No. 19, Hwa Ya 2nd Rd, Wen Hwa Tsuen,
Kwei Shan Hsiang, Taoyuan Hsien 333,
Taiwan, R.O.C.

This test report consists of 63 pages in total. It may be duplicated completely for legal use with the approval of the applicant. It should not be reproduced except in full, without the written approval of our laboratory. The client should not use it to claim product endorsement by TAF or any government agencies. The test results in the report only apply to the tested sample.





A D T

Table of Contents

| | | |
|-------|--|----|
| 1. | CERTIFICATION..... | 4 |
| 2. | SUMMARY OF TEST RESULTS | 5 |
| 2.1 | MEASUREMENT UNCERTAINTY | 5 |
| 3. | GENERAL INFORMATION..... | 6 |
| 3.1 | GENERAL DESCRIPTION OF EUT..... | 6 |
| 3.2 | DESCRIPTION OF TEST MODES..... | 7 |
| 3.2.1 | CONFIGURATION OF SYSTEM UNDER TEST..... | 8 |
| 3.2.2 | TEST MODE APPLICABILITY AND TESTED CHANNEL DETAIL..... | 9 |
| 3.3 | GENERAL DESCRIPTION OF APPLIED STANDARDS | 11 |
| 3.4 | DESCRIPTION OF SUPPORT UNITS | 11 |
| 4. | TEST TYPES AND RESULTS | 12 |
| 4.1 | RADIATED EMISSION MEASUREMENT | 12 |
| 4.1.1 | LIMITS OF RADIATED EMISSION MEASUREMENT..... | 12 |
| 4.1.2 | TEST INSTRUMENTS | 13 |
| 4.1.3 | TEST PROCEDURES | 14 |
| 4.1.4 | DEVIATION FROM TEST STANDARD | 14 |
| 4.1.5 | TEST SETUP | 15 |
| 4.1.6 | EUT OPERATING CONDITIONS | 15 |
| 4.1.7 | TEST RESULTS | 16 |
| 4.2 | CONDUCTED EMISSION MEASUREMENT | 24 |
| 4.2.1 | LIMITS OF CONDUCTED EMISSION MEASUREMENT..... | 24 |
| 4.2.2 | TEST INSTRUMENTS | 24 |
| 4.2.3 | TEST PROCEDURES | 25 |
| 4.2.4 | DEVIATION FROM TEST STANDARD | 25 |
| 4.2.5 | TEST SETUP | 26 |
| 4.2.6 | EUT OPERATING CONDITIONS | 26 |
| 4.2.7 | TEST RESULTS | 27 |
| 4.3 | NUMBER OF HOPPING FREQUENCY USED..... | 31 |
| 4.3.1 | LIMIT OF HOPPING FREQUENCY USED | 31 |
| 4.3.2 | TEST INSTRUMENTS | 31 |
| 4.3.3 | TEST PROCEDURES | 31 |
| 4.3.4 | DEVIATION FROM TEST STANDARD | 32 |
| 4.3.5 | TEST SETUP | 32 |
| 4.3.6 | TEST RESULTS | 32 |
| 4.4 | DWELL TIME ON EACH CHANNEL | 35 |
| 4.4.1 | LIMIT OF DWELL TIME USED..... | 35 |
| 4.4.2 | TEST INSTRUMENTS | 35 |
| 4.4.3 | TEST PROCEDURES | 35 |
| 4.4.4 | DEVIATION FROM TEST STANDARD | 35 |
| 4.4.5 | TEST SETUP | 36 |
| 4.4.6 | TEST RESULTS | 36 |
| 4.5 | CHANNEL BANDWIDTH..... | 44 |
| 4.5.1 | LIMITS OF CHANNEL BANDWIDTH | 44 |
| 4.5.2 | TEST INSTRUMENTS | 44 |
| 4.5.3 | TEST PROCEDURE | 44 |
| 4.5.4 | DEVIATION FROM TEST STANDARD | 45 |



A D T

| | | |
|-------|--|----|
| 4.5.5 | TEST SETUP | 45 |
| 4.5.6 | EUT OPERATING CONDITION | 45 |
| 4.5.7 | TEST RESULTS | 46 |
| 4.6 | HOPPING CHANNEL SEPARATION | 48 |
| 4.6.1 | LIMIT OF HOPPING CHANNEL SEPARATION | 48 |
| 4.6.2 | TEST INSTRUMENTS | 48 |
| 4.6.3 | TEST PROCEDURES | 48 |
| 4.6.4 | DEVIATION FROM TEST STANDARD | 48 |
| 4.6.5 | TEST SETUP | 49 |
| 4.6.6 | TEST RESULTS | 49 |
| 4.7 | MAXIMUM OUTPUT POWER..... | 51 |
| 4.7.1 | LIMITS OF MAXIMUM OUTPUT POWER MEASUREMENT | 51 |
| 4.7.2 | TEST INSTRUMENTS | 51 |
| 4.7.3 | TEST PROCEDURES | 51 |
| 4.7.4 | DEVIATION FROM TEST STANDARD | 51 |
| 4.7.5 | TEST SETUP | 52 |
| 4.7.6 | EUT OPERATING CONDITION | 52 |
| 4.7.7 | TEST RESULTS | 52 |
| 4.8 | BAND EDGES MEASUREMENT | 54 |
| 4.8.1 | LIMITS OF BAND EDGES MEASUREMENT | 54 |
| 4.8.2 | TEST INSTRUMENTS | 54 |
| 4.8.3 | TEST PROCEDURE | 54 |
| 4.8.4 | DEVIATION FROM TEST STANDARD | 54 |
| 4.8.5 | EUT OPERATING CONDITION | 54 |
| 4.8.6 | TEST RESULTS | 55 |
| 5. | PHOTOGRAPHS OF THE TEST CONFIGURATION..... | 61 |
| 6. | INFORMATION ON THE TESTING LABORATORIES | 62 |
| 7. | APPENDIX A - MODIFICATIONS RECORDERS FOR ENGINEERING CHANGES TO THE EUT BY THE LAB..... | 63 |



1. CERTIFICATION

PRODUCT: GSM / EGPRS Mobile Phone

MODEL NO.: EX115 (refer to item 3.1 for more detail)

BRAND: Motorola

APPLICANT: Motorola Inc

TESTED: Apr. 23 ~ May 07, 2010

TEST SAMPLE: ENGINEERING SAMPLE

STANDARDS: FCC Part 15, Subpart C (Section 15.247)

ANSI C63.4-2003

The above equipment (Model: EX115) has been tested by **Bureau Veritas Consumer Products Services (H.K.) Ltd., Taoyuan Branch**, and found compliance with the requirement of the above standards. The test record, data evaluation & Equipment Under Test (EUT) configurations represented herein are true and accurate accounts of the measurements of the sample's EMC characteristics under the conditions specified in this report.

PREPARED BY : Andrea Hsia , **DATE:** May 13, 2010
Andrea Hsia / Specialist

TECHNICAL ACCEPTANCE : Long Chen , **DATE:** May 13, 2010
Responsible for RF Long Chen / Senior Engineer

APPROVED BY : Gary Chang , **DATE:** May 13, 2010
Gary Chang / Assistant Manager



2. SUMMARY OF TEST RESULTS

The EUT has been tested according to the following specifications:

| APPLIED STANDARD: FCC Part 15, Subpart C | | | |
|--|---|--------|--|
| STANDARD SECTION | TEST TYPE AND LIMIT | RESULT | REMARK |
| 15.207 | AC Power Conducted Emission | PASS | Meet the requirement of limit. Minimum passing margin is -11.90dB at 1.457MHz. |
| 15.247(a)(1) (iii) | Number of Hopping Frequency Used Spec.: At least 15 channels | PASS | Meet the requirement of limit. |
| 15.247(a)(1) (iii) | Dwell Time on Each Channel Spec.: Max. 0.4 second within 31.6 second | PASS | Meet the requirement of limit. |
| 15.247(a)(1) | 1. Hopping Channel Separation Spec.: Min. 25 kHz or $\frac{2}{3}$ *20 dB bandwidth, whichever is greater 2. Spectrum Bandwidth of a Frequency Hopping Sequence Spread Spectrum System | PASS | Meet the requirement of limit. |
| 15.247(b) | Maximum Output Power Spec.: max. 21dBm | PASS | Meet the requirement of limit. |
| 15.247(d) | Transmitter Radiated Emissions Spec.: Table 15.209 | PASS | Meet the requirement of limit. Minimum passing margin is -5.5dB at 33.79MHz. |
| 15.247(d) | Band Edge Measurement | PASS | Meet the requirement of limit. |
| 15.203 | Antenna Requirement | PASS | No antenna connector is used. |

NOTE: If The Frequency Hopping System operating in 2400-2483.5MHz band and the output power less than 125mW. The hopping channel carrier frequencies separated by a minimum of 25kHz or two-thirds of the 20dB bandwidth of hopping channel whichever is greater.

2.1 MEASUREMENT UNCERTAINTY

Where relevant, the following measurement uncertainty levels have been estimated for tests performed on the EUT as specified in CISPR 16-4-2:

| MEASUREMENT | FREQUENCY | UNCERTAINTY |
|---------------------|-----------------|-------------|
| Conducted emissions | 9kHz~30MHz | 2.44 dB |
| Radiated emissions | 30MHz ~ 200MHz | 3.34 dB |
| | 200MHz ~1000MHz | 3.35 dB |
| | 1GHz ~ 18GHz | 2.26 dB |
| | 18GHz ~ 40GHz | 1.94 dB |

This uncertainty represents an expanded uncertainty expressed at approximately the 95% confidence level using a coverage factor of k=2.



3. GENERAL INFORMATION

3.1 GENERAL DESCRIPTION OF EUT

| | |
|------------------------------|---|
| EUT | GSM / EGPRS Mobile Phone |
| MODEL NO. | EX115 (Refer to Note for the more details) |
| FCC ID | IHDP56LJ3 |
| POWER SUPPLY | 3.7Vdc (battery) 5.0Vdc (adapter & host equipment) |
| MODULATION TYPE | GFSK, $\pi/4$ -DQPSK, 8DPSK |
| MODULATION TECHNOLOGY | FHSS |
| TRANSFER RATE | 1/2/3Mbps |
| OPERATING FREQUENCY | 2402 ~ 2480MHz |
| NUMBER OF CHANNEL | 79 |
| OUTPUT POWER | 3.6mW |
| ANTENNA TYPE | Embedded inverted-F antenna with -3.94dBi gain |
| ANTENNA CONNECTOR | NA |
| DATA CABLE | 1.3m shielded USB cable without core |
| I/O PORTS | Refer to user's manual |
| ACCESSORY DEVICES | Adapter, Battery, Earphone (Model: YD-16PS-1, 1.3m shielded cable without core) |

NOTE:

1. The EUT is a GSM / EGPRS Mobile Phone which the EGPRS function was for receive only.
2. The EUT is a GSM / EGPRS Mobile Phone which has dual SIM card design (Model: EX115) and single SIM card design (Model: EX112). Both models were assessed and model EX115 was found to be worst case and was selected for the final test configuration.

| Brand | Model Name | Remark |
|----------|------------|------------|
| MOTOROLA | EX115 | dual SIM |
| MOTOROLA | EX112 | single SIM |

3. The EUT were tested with the following lithium battery and adapter:

| Lithium Battery | |
|-----------------|---------------------|
| BRAND : | MOTOROLA |
| MODEL : | BK60 |
| RATING : | 3.7V, 930mAh, 3.4Wh |

| Adapter | |
|-----------------|---------------------------|
| BRAND : | MOTOROLA |
| MODEL : | DCH3-050US-0303 |
| INPUT : | 100-240Vac, 50/60Hz, 0.2A |
| OUTPUT : | 5Vdc, 550mA |



A D T

3. The EUT is a GSM / EGPRS Mobile Phone. The functions of EUT listed as below:

| | TEST STANDARD | REFERENCE REPORT |
|-----------|--|------------------|
| BLUETOOTH | FCC Part 15, Subpart C (Section 15.247) | RF990421C04 |
| GSM 850 | FCC Part 22 | RF990421C04-1 |
| PCS 1900 | FCC Part 24 | RF990421C04-2 |

4. The above EUT information was declared by manufacturer and for more detailed features description, please refer to the manufacturer's specifications or user's manual.

3.2 DESCRIPTION OF TEST MODES

79 channels are provided to this EUT:

| CHANNEL | FREQ. (MHz) | CHANNEL | FREQ. (MHz) | CHANNEL | FREQ. (MHz) | CHANNEL | FREQ. (MHz) |
|---------|----------------|---------|----------------|---------|----------------|---------|----------------|
| 0 | 2402 | 20 | 2422 | 40 | 2442 | 60 | 2462 |
| 1 | 2403 | 21 | 2423 | 41 | 2443 | 61 | 2463 |
| 2 | 2404 | 22 | 2424 | 42 | 2444 | 62 | 2464 |
| 3 | 2405 | 23 | 2425 | 43 | 2445 | 63 | 2465 |
| 4 | 2406 | 24 | 2426 | 44 | 2446 | 64 | 2466 |
| 5 | 2407 | 25 | 2427 | 45 | 2447 | 65 | 2467 |
| 6 | 2408 | 26 | 2428 | 46 | 2448 | 66 | 2468 |
| 7 | 2409 | 27 | 2429 | 47 | 2449 | 67 | 2469 |
| 8 | 2410 | 28 | 2430 | 48 | 2450 | 68 | 2470 |
| 9 | 2411 | 29 | 2431 | 49 | 2451 | 69 | 2471 |
| 10 | 2412 | 30 | 2432 | 50 | 2452 | 70 | 2472 |
| 11 | 2413 | 31 | 2433 | 51 | 2453 | 71 | 2473 |
| 12 | 2414 | 32 | 2434 | 52 | 2454 | 72 | 2474 |
| 13 | 2415 | 33 | 2435 | 53 | 2455 | 73 | 2475 |
| 14 | 2416 | 34 | 2436 | 54 | 2456 | 74 | 2476 |
| 15 | 2417 | 35 | 2437 | 55 | 2457 | 75 | 2477 |
| 16 | 2418 | 36 | 2438 | 56 | 2458 | 76 | 2478 |
| 17 | 2419 | 37 | 2439 | 57 | 2459 | 77 | 2479 |
| 18 | 2420 | 38 | 2440 | 58 | 2460 | 78 | 2480 |
| 19 | 2421 | 39 | 2441 | 59 | 2461 | | |

3.2.1 CONFIGURATION OF SYSTEM UNDER TEST

TEST MODE A

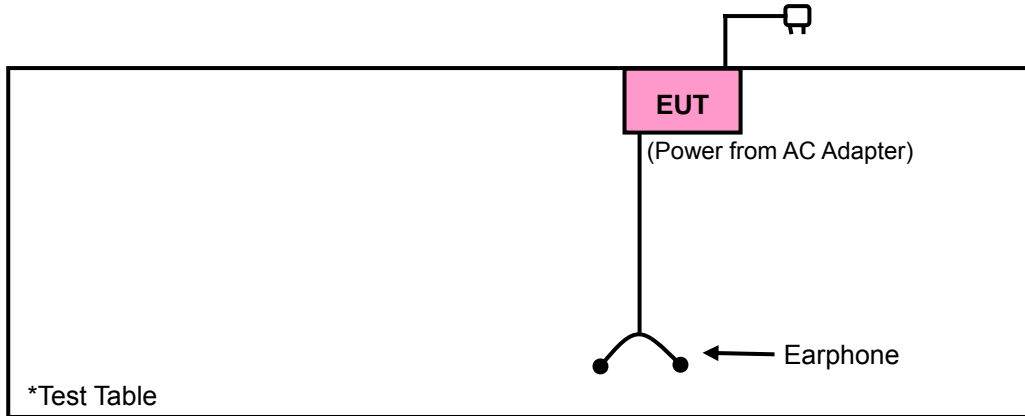

TEST MODE B

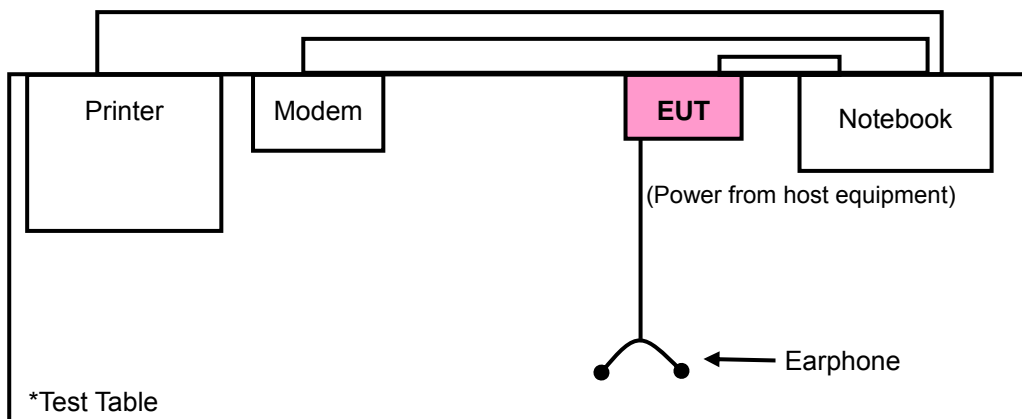



A D T

3.2.2 TEST MODE APPLICABILITY AND TESTED CHANNEL DETAIL

| EUT CONFIGURE MODE | APPLICABLE TO | | | | DESCRIPTION |
|--------------------|---------------|-------|-----|------|---------------------------|
| | RE \geq 1G | RE<1G | PLC | APCM | |
| A | √ | √ | √ | √ | Power from AC Adapter |
| B | - | √ | √ | - | Power from host equipment |

Where **RE \geq 1G**: Radiated Emission above 1GHz
PLC: Power Line Conducted Emission

RE<1G: Radiated Emission below 1GHz
APCM: Antenna Port Conducted Measurement

NOTE: "-" means no effect.

RADIATED EMISSION TEST (ABOVE 1 GHz):

- Pre-Scan has been conducted to determine the worst-case mode from all possible combinations between available modulations, data rates, XYZ axis, antenna ports (if EUT with antenna diversity architecture) and packet type.
- Following channel(s) was (were) selected for the final test as listed below.

| EUT CONFIGURE MODE | AVAILABLE CHANNEL | TESTED CHANNEL | MODULATION TECHNOLOGY | MODULATION TYPE | PACKET TYPE | AXIS |
|--------------------|-------------------|----------------|-----------------------|-----------------|-------------|------|
| A | 0 to 78 | 0, 39, 78 | FHSS | GFSK | DH5 | X |
| A | 0 to 78 | 0, 39, 78 | FHSS | 8DPSK | DH5 | X |

RADIATED EMISSION TEST (BELOW 1 GHz):

- Pre-Scan has been conducted to determine the worst-case mode from all possible combinations between available modulations, data rates, XYZ axis, antenna ports (if EUT with antenna diversity architecture) and packet type.
- Following channel(s) was (were) selected for the final test as listed below.

| EUT CONFIGURE MODE | AVAILABLE CHANNEL | TESTED CHANNEL | MODULATION TECHNOLOGY | MODULATION TYPE | PACKET TYPE | AXIS |
|--------------------|-------------------|----------------|-----------------------|-----------------|-------------|------|
| A & B | 0 to 78 | 39 | FHSS | 8DPSK | DH5 | X |

POWER LINE CONDUCTED EMISSION TEST:

- Pre-Scan has been conducted to determine the worst-case mode from all possible combinations between available modulations, antenna ports (if EUT with antenna diversity architecture), and packet types.
- Following channel(s) was (were) selected for the final test as listed below.

| EUT CONFIGURE MODE | AVAILABLE CHANNEL | TESTED CHANNEL | MODULATION TECHNOLOGY | MODULATION TYPE | PACKET TYPE |
|--------------------|-------------------|----------------|-----------------------|-----------------|-------------|
| A & B | 0 to 78 | 39 | FHSS | 8DPSK | DH5 |



BANDEDGE MEASUREMENT:

- Pre-Scan has been conducted to determine the worst-case mode from all possible combinations between available modulations, antenna ports (if EUT with antenna diversity architecture), and packet types.
- Following channel(s) was (were) selected for the final test as listed below.

| EUT CONFIGURE MODE | AVAILABLE CHANNEL | TESTED CHANNEL | MODULATION TECHNOLOGY | MODULATION TYPE | PACKET TYPE |
|--------------------|-------------------|----------------|-----------------------|-----------------|-------------|
| A | 0 to 78 | 0, 78 | FHSS | GFSK | DH5 |
| A | 0 to 78 | 0, 78 | FHSS | 8DPSK | DH5 |

ANTENNA PORT CONDUCTED MEASUREMENT:

- This item includes all test value of each mode, but only includes spectrum plot of worst value of each mode.
- Pre-Scan has been conducted to determine the worst-case mode from all possible combinations between available modulations, data rates and antenna ports (if EUT with antenna diversity architecture).
- Following channel(s) was (were) selected for the final test as listed below.

| EUT CONFIGURE MODE | AVAILABLE CHANNEL | TESTED CHANNEL | MODULATION TECHNOLOGY | MODULATION TYPE | PACKET TYPE |
|--------------------|-------------------|----------------|-----------------------|-----------------|-------------|
| A | 0 to 78 | 0, 39, 78 | FHSS | GFSK | DH5 |
| A | 0 to 78 | 0, 39, 78 | FHSS | 8DPSK | DH5 |

TEST CONDITION:

| APPLICABLE TO | ENVIRONMENTAL CONDITIONS | INPUT POWER (SYSTEM) | TESTED BY |
|---------------|---------------------------|----------------------|-----------|
| RE≥1G | 23deg. C, 65%RH, 1020 hPa | 120Vac, 60Hz | Brad Wu |
| RE<1G | 25deg. C, 65%RH, 1020 hPa | 120Vac, 60Hz | Mark Liao |
| PLC | 25deg. C, 66%RH, 1020 hPa | 120Vac, 60Hz | Dean Wang |
| APCM | 26deg. C, 62%RH, 1020 hPa | 120Vac, 60Hz | Mark Liao |

3.3 GENERAL DESCRIPTION OF APPLIED STANDARDS

The EUT is a RF Product. According to the specifications of the manufacturer, it must comply with the requirements of the following standards:

FCC Part 15, Subpart C. (15.247)
ANSI C63.4-2003

All test items have been performed and recorded as per the above standards.

NOTE: The EUT is also considered as a kind of computer peripheral, because the connection to computer is necessary for typical use. It has been verified to comply with the requirements of FCC Part 15, Subpart B, Class B (DoC). The test report has been issued separately.

3.4 DESCRIPTION OF SUPPORT UNITS

The EUT has been tested as an independent unit together with other necessary accessories or support units. The following support units or accessories were used to form a representative test configuration during the tests.

| NO. | PRODUCT | BRAND | MODEL NO. | SERIAL NO. | FCC ID |
|-----|----------|-------|-----------|--------------------------|------------------|
| 1 | NOTEBOOK | DELL | D600 | CN-0G5152-48643-49C-8226 | NA |
| 2 | PRINTER | EPSON | LQ-300+ | DCGY054146 | FCC DoC Approved |
| 3 | MODEM | ACEEX | 1414V/3 | 0401008277 | IFAXDM1414 |

| NO. | SIGNAL CABLE DESCRIPTION OF THE ABOVE SUPPORT UNITS |
|-----|---|
| 1 | NA |
| 2 | 1.8m braid shielded wire, DB25 connector, w/o core. |
| 3 | 1.2m braid shielded wire, DB25 & DB9 connector, w/o core. |

NOTE: All power cords of the above support units are non shielded (1.8m).

4. TEST TYPES AND RESULTS

4.1 RADIATED EMISSION MEASUREMENT

4.1.1 LIMITS OF RADIATED EMISSION MEASUREMENT

Emissions radiated outside of the specified bands, shall be according to the general radiated limits in 15.209 as following:

| FREQUENCIES (MHz) | FIELD STRENGTH (microvolts/meter) | MEASUREMENT DISTANCE (meters) |
|-------------------|-----------------------------------|-------------------------------|
| 0.009 ~ 0.490 | 2400/F(kHz) | 300 |
| 0.490 ~ 1.705 | 24000/F(kHz) | 30 |
| 1.705 ~ 30.0 | 30 | 30 |
| 30 ~ 88 | 100 | 3 |
| 88 ~ 216 | 150 | 3 |
| 216 ~ 960 | 200 | 3 |
| Above 960 | 500 | 3 |

NOTE:

1. The lower limit shall apply at the transition frequencies.
2. Emission level (dBuV/m) = 20 log Emission level (uV/m).
3. As shown in 15.35(b), for frequencies above 1000MHz, the field strength limits are based on average detector, however, the peak field strength of any emission shall not exceed the maximum permitted average limits, specified above by more than 20dB under any condition of modulation.



4.1.2 TEST INSTRUMENTS

| DESCRIPTION & MANUFACTURER | MODEL NO. | SERIAL NO. | DATE OF CALIBRATION | DUE DATE OF CALIBRATION |
|---|------------------------------|-------------|---------------------|-------------------------|
| Test Receiver ROHDE & SCHWARZ | ESI7 | 100033 | Jul. 06, 2009 | Jul. 05, 2010 |
| Spectrum Analyzer ROHDE & SCHWARZ | FSP40 | 100076 | May 26, 2009 | May 25, 2010 |
| BILOG Antenna SCHWARZBECK | VULB9168 | 9168-160 | Apr. 27, 2010 | Apr. 26, 2011 |
| HORN Antenna SCHWARZBECK | 9120D | 9120D-209 | Jul. 01, 2009 | Jun. 30, 2010 |
| HORN Antenna SCHWARZBECK | BBHA 9170 | BBHA9170243 | Dec. 25, 2009 | Dec. 24, 2010 |
| Preamplifier Agilent | 8447D | 2944A10633 | Nov. 10, 2009 | Nov. 09, 2010 |
| Preamplifier Agilent | 8449B | 3008A01964 | Nov. 09, 2009 | Nov. 08, 2010 |
| RF signal cable HUBER+SUHNNER | SUCOFLEX 104 | 238141/4 | May 13, 2009 | May 12, 2010 |
| RF signal cable HUBER+SUHNNER | SUCOFLEX 104 | 12738/6 | May 13, 2009 | May 12, 2010 |
| Software ADT. | ADT_Radiated_ V7.6.15.9.2 | NA | NA | NA |
| Antenna Tower inn-co GmbH | MA 4000 | 013303 | NA | NA |
| Antenna Tower Controller inn-co GmbH | CO2000 | 017303 | NA | NA |
| Turn Table ADT. | TT100. | TT93021703 | NA | NA |
| Turn Table Controller ADT. | SC100. | SC93021703 | NA | NA |

- NOTE:**
1. The calibration interval of the above test instruments is 12 months and the calibrations are traceable to NML/ROC and NIST/USA.
 2. The test was performed in HwaYa Chamber 3.
 3. The horn antenna and HP preamplifier (model: 8449B) are used only for the measurement of emission frequency above 1GHz if tested.
 4. The FCC Site Registration No. is 988962.
 5. The IC Site Registration No. is IC 7450F-3.

4.1.3 TEST PROCEDURES

- a. The EUT was placed on the top of a rotating table 0.8 meters above the ground at a 3 meter semi-anechoic chamber. The table was rotated 360 degrees to determine the position of the highest radiation.
- b. The EUT was set 3 meters away from the interference-receiving antenna, which was mounted on the top of a variable-height antenna tower.
- c. The antenna is a broadband antenna, and its height is varied from one meter to four meters above the ground to determine the maximum value of the field strength. Both horizontal and vertical polarizations of the antenna are set to make the measurement.
- d. For each suspected emission, the EUT was arranged to its worst case and then the antenna was tuned to heights from 1 meter to 4 meters and the rotatable table was turned from 0 degrees to 360 degrees to find the maximum reading.
- e. The test-receiver system was set to Peak Detect Function and Specified Bandwidth with Maximum Hold Mode.
- f. If the emission level of the EUT in peak mode was lower than the limit specified, then testing could be stopped and the peak values of the EUT would be reported. Otherwise the emissions would be re-tested one by one using peak, quasi-peak or average method as specified and then reported in a data sheet.

NOTE:

1. The resolution bandwidth and video bandwidth of test receiver/spectrum analyzer is 120kHz for Quasi-peak detection at frequency below 1GHz.
2. The resolution bandwidth of test receiver/spectrum analyzer is 1 MHz and video bandwidth is 3MHz for Peak detection at frequency above 1GHz.
3. All modes of operation were investigated and the worst-case emissions are reported.

4.1.4 DEVIATION FROM TEST STANDARD

No deviation

4.1.5 TEST SETUP

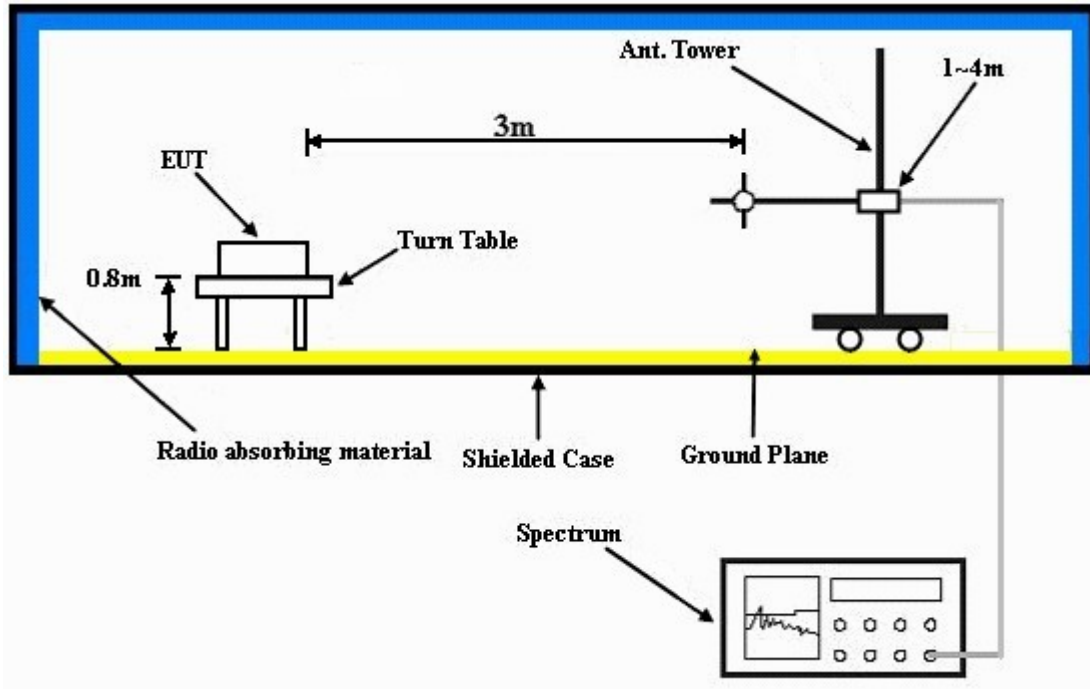

For the actual test configuration, please refer to the attached file (Test Setup Photo).

4.1.6 EUT OPERATING CONDITIONS

- a. Connected the EUT to a notebook via a USB cable and placed on a testing table.
- b. The EUT runs a test program (provided by manufacture) to transmit at specific channel.
- c. The necessary accessories enable the system in full functions.



A D T

4.1.7 TEST RESULTS

GFSK

| EUT TEST CONDITION | | MEASUREMENT DETAIL | |
|--------------------------|-----------------------------|--------------------|---------------------------|
| CHANNEL | Channel 0 | FREQUENCY RANGE | 1 ~ 25GHz |
| INPUT POWER (SYSTEM) | 120Vac, 60 Hz | DETECTOR FUNCTION | Peak (PK) Average (AV) |
| ENVIRONMENTAL CONDITIONS | 23deg. C, 65%RH 1020 hPa | TESTED BY | Brad Wu |

ANTENNA POLARITY & TEST DISTANCE: HORIZONTAL AT 3 M

| NO. | FREQ. (MHz) | EMISSION LEVEL (dBuV/m) | LIMIT (dBuV/m) | MARGIN (dB) | ANTENNA HEIGHT (m) | TABLE ANGLE (Degree) | RAW VALUE (dBuV) | CORRECTION FACTOR (dB/m) |
|-----|-------------|-------------------------|----------------|-------------|--------------------|----------------------|------------------|--------------------------|
| 1 | 2390.00 | 39.5 PK | 74.0 | -34.5 | 1.08 H | 18 | 9.00 | 30.50 |
| 2 | 2390.00 | 29.2 AV | 54.0 | -24.8 | 1.08 H | 18 | -1.30 | 30.50 |
| 3 | #2398.00 | 46.8 PK | 75.8 | -29.0 | 1.08 H | 18 | 16.30 | 30.50 |
| 4 | #2398.00 | 38.6 AV | 45.7 | -7.1 | 1.08 H | 18 | 8.10 | 30.50 |
| 5 | #2400.00 | 43.7 PK | 75.8 | -32.1 | 1.08 H | 18 | 13.20 | 30.50 |
| 6 | #2400.00 | 13.6 AV | 45.7 | -32.1 | 1.08 H | 18 | -16.90 | 30.50 |
| 7 | *2402.00 | 95.8 PK | | | 1.08 H | 18 | 65.30 | 30.50 |
| 8 | *2402.00 | 65.7 AV | | | 1.08 H | 18 | 35.20 | 30.50 |
| 9 | 4804.00 | 49.3 PK | 74.0 | -24.7 | 1.03 H | 211 | 13.20 | 36.10 |
| 10 | 4804.00 | 19.2 AV | 54.0 | -34.8 | 1.03 H | 211 | -16.90 | 36.10 |

ANTENNA POLARITY & TEST DISTANCE: VERTICAL AT 3 M

| NO. | FREQ. (MHz) | EMISSION LEVEL (dBuV/m) | LIMIT (dBuV/m) | MARGIN (dB) | ANTENNA HEIGHT (m) | TABLE ANGLE (Degree) | RAW VALUE (dBuV) | CORRECTION FACTOR (dB/m) |
|-----|-------------|-------------------------|----------------|-------------|--------------------|----------------------|------------------|--------------------------|
| 1 | 2390.00 | 38.8 PK | 74.0 | -35.2 | 1.00 V | 325 | 8.30 | 30.50 |
| 2 | 2390.00 | 28.6 AV | 54.0 | -25.4 | 1.00 V | 325 | -1.90 | 30.50 |
| 3 | #2398.00 | 44.5 PK | 72.6 | -28.1 | 1.00 V | 325 | 14.00 | 30.50 |
| 4 | #2398.00 | 36.2 AV | 42.5 | -6.3 | 1.00 V | 325 | 5.70 | 30.50 |
| 5 | #2400.00 | 40.5 PK | 72.6 | -32.1 | 1.00 V | 325 | 10.00 | 30.50 |
| 6 | #2400.00 | 10.4 AV | 42.5 | -32.1 | 1.00 V | 325 | -20.10 | 30.50 |
| 7 | *2402.00 | 92.6 PK | | | 1.00 V | 325 | 62.10 | 30.50 |
| 8 | *2402.00 | 62.5 AV | | | 1.00 V | 325 | 32.00 | 30.50 |
| 9 | 4804.00 | 48.6 PK | 74.0 | -25.4 | 1.12 V | 35 | 12.50 | 36.10 |
| 10 | 4804.00 | 18.5 AV | 54.0 | -35.5 | 1.12 V | 35 | -17.60 | 36.10 |

- REMARKS:**
1. Emission level (dBuV/m) = Raw Value (dBuV) + Correction Factor (dB/m).
 2. Correction Factor (dB/m) = Antenna Factor (dB/m) + Cable Factor (dB).
 3. The other emission levels were very low against the limit.
 4. Margin value = Emission level – Limit value.
 5. “ * “: Fundamental frequency.
 6. The DH5 packet was the worse case duty cycle for a transmit dwell time on a channel, based upon bluetooth theory the transmitter is on 0.625 * 5 per 296.25 ms per channel. Therefore, the duty cycle correlation factor be equal to: $20\log(3.125 / 100) = -30.1$ dB.
 7. Average value = peak reading + $20\log(\text{duty cycle})$.
 8. "#":The radiated frequency is out the restricted band.



A D T

| EUT TEST CONDITION | | MEASUREMENT DETAIL | |
|--------------------------|-----------------------------|--------------------|---------------------------|
| CHANNEL | Channel 39 | FREQUENCY RANGE | 1 ~ 25GHz |
| INPUT POWER (SYSTEM) | 120Vac, 60 Hz | DETECTOR FUNCTION | Peak (PK) Average (AV) |
| ENVIRONMENTAL CONDITIONS | 23deg. C, 65%RH 1020 hPa | TESTED BY | Brad Wu |

| ANTENNA POLARITY & TEST DISTANCE: HORIZONTAL AT 3 M | | | | | | | | |
|---|-------------|-------------------------|----------------|-------------|--------------------|----------------------|------------------|--------------------------|
| NO. | FREQ. (MHz) | EMISSION LEVEL (dBuV/m) | LIMIT (dBuV/m) | MARGIN (dB) | ANTENNA HEIGHT (m) | TABLE ANGLE (Degree) | RAW VALUE (dBuV) | CORRECTION FACTOR (dB/m) |
| 1 | *2441.00 | 94.9 PK | | | 1.09 H | 9 | 64.20 | 30.70 |
| 2 | *2441.00 | 64.8 AV | | | 1.09 H | 9 | 34.10 | 30.70 |
| 3 | 4882.00 | 50.3 PK | 74.0 | -23.7 | 1.16 H | 28 | 14.10 | 36.20 |
| 4 | 4882.00 | 20.2 AV | 54.0 | -33.8 | 1.16 H | 28 | -16.00 | 36.20 |

| ANTENNA POLARITY & TEST DISTANCE: VERTICAL AT 3 M | | | | | | | | |
|---|-------------|-------------------------|----------------|-------------|--------------------|----------------------|------------------|--------------------------|
| NO. | FREQ. (MHz) | EMISSION LEVEL (dBuV/m) | LIMIT (dBuV/m) | MARGIN (dB) | ANTENNA HEIGHT (m) | TABLE ANGLE (Degree) | RAW VALUE (dBuV) | CORRECTION FACTOR (dB/m) |
| 1 | *2441.00 | 91.8 PK | | | 1.01 V | 328 | 61.10 | 30.70 |
| 2 | *2441.00 | 61.7 AV | | | 1.01 V | 328 | 31.00 | 30.70 |
| 3 | 4882.00 | 49.4 PK | 74.0 | -24.6 | 1.10 V | 46 | 13.20 | 36.20 |
| 4 | 4882.00 | 19.3 AV | 54.0 | -34.7 | 1.10 V | 46 | -16.90 | 36.20 |

- REMARKS:**
1. Emission level (dBuV/m) = Raw Value (dBuV) + Correction Factor (dB/m).
 2. Correction Factor (dB/m) = Antenna Factor (dB/m) + Cable Factor (dB).
 3. The other emission levels were very low against the limit.
 4. Margin value = Emission level – Limit value.
 5. “ * “: Fundamental frequency.
 6. The DH5 packet was the worse case duty cycle for a transmit dwell time on a channel, based upon bluetooth theory the transmitter is on 0.625 * 5 per 296.25 ms per channel. Therefore, the duty cycle correlation factor be equal to: $20\log(3.125 / 100) = -30.1$ dB.
 7. Average value = peak reading + $20\log(\text{duty cycle})$.



A D T

| EUT TEST CONDITION | | MEASUREMENT DETAIL | |
|--------------------------|-----------------------------|--------------------|---------------------------|
| CHANNEL | Channel 78 | FREQUENCY RANGE | 1 ~ 25GHz |
| INPUT POWER (SYSTEM) | 120Vac, 60 Hz | DETECTOR FUNCTION | Peak (PK) Average (AV) |
| ENVIRONMENTAL CONDITIONS | 23deg. C, 65%RH 1020 hPa | TESTED BY | Brad Wu |

| ANTENNA POLARITY & TEST DISTANCE: HORIZONTAL AT 3 M | | | | | | | | |
|---|-------------|-------------------------|----------------|-------------|--------------------|----------------------|------------------|--------------------------|
| NO. | FREQ. (MHz) | EMISSION LEVEL (dBuV/m) | LIMIT (dBuV/m) | MARGIN (dB) | ANTENNA HEIGHT (m) | TABLE ANGLE (Degree) | RAW VALUE (dBuV) | CORRECTION FACTOR (dB/m) |
| 1 | *2480.00 | 93.6 PK | | | 1.30 H | 11 | 62.80 | 30.80 |
| 2 | *2480.00 | 63.5 AV | | | 1.30 H | 11 | 32.70 | 30.80 |
| 3 | 2483.50 | 38.2 PK | 74.0 | -35.8 | 1.30 H | 11 | 7.40 | 30.80 |
| 4 | 2483.50 | 8.1 AV | 54.0 | -45.9 | 1.30 H | 11 | -22.70 | 30.80 |
| 5 | 2485.50 | 42.2 PK | 74.0 | -31.8 | 1.35 H | 13 | 11.40 | 30.80 |
| 6 | 2485.50 | 28.9 AV | 54.0 | -25.1 | 1.35 H | 13 | -1.90 | 30.80 |
| 7 | 4960.00 | 50.6 PK | 74.0 | -23.4 | 1.12 H | 354 | 14.20 | 36.40 |
| 8 | 4960.00 | 20.5 AV | 54.0 | -33.5 | 1.12 H | 354 | -15.90 | 36.40 |
| ANTENNA POLARITY & TEST DISTANCE: VERTICAL AT 3 M | | | | | | | | |
| NO. | FREQ. (MHz) | EMISSION LEVEL (dBuV/m) | LIMIT (dBuV/m) | MARGIN (dB) | ANTENNA HEIGHT (m) | TABLE ANGLE (Degree) | RAW VALUE (dBuV) | CORRECTION FACTOR (dB/m) |
| 1 | *2480.00 | 90.6 PK | | | 1.03 V | 330 | 59.80 | 30.80 |
| 2 | *2480.00 | 60.5 AV | | | 1.03 V | 330 | 29.70 | 30.80 |
| 3 | 2483.50 | 35.2 PK | 74.0 | -38.8 | 1.03 V | 330 | 4.40 | 30.80 |
| 4 | 2483.50 | 5.1 AV | 54.0 | -48.9 | 1.03 V | 330 | -25.70 | 30.80 |
| 5 | 2485.50 | 41.6 PK | 74.0 | -32.4 | 1.03 V | 330 | 10.80 | 30.80 |
| 6 | 2485.50 | 28.3 AV | 54.0 | -25.7 | 1.03 V | 330 | -2.50 | 30.80 |
| 7 | 4960.00 | 49.1 PK | 74.0 | -24.9 | 1.18 V | 95 | 12.70 | 36.40 |
| 8 | 4960.00 | 19.0 AV | 54.0 | -35.0 | 1.18 V | 95 | -17.40 | 36.40 |

- REMARKS:**
- Emission level (dBuV/m) = Raw Value (dBuV) + Correction Factor (dB/m).
 - Correction Factor (dB/m) = Antenna Factor (dB/m) + Cable Factor (dB).
 - The other emission levels were very low against the limit.
 - Margin value = Emission level – Limit value.
 - * *: Fundamental frequency.
 - The DH5 packet was the worse case duty cycle for a transmit dwell time on a channel, based upon bluetooth theory the transmitter is on 0.625 * 5 per 296.25 ms per channel. Therefore, the duty cycle correlation factor be equal to: $20\log(3.125 / 100) = -30.1$ dB.
 - Average value = peak reading + $20\log(\text{duty cycle})$.



A D T

8DPSK

| EUT TEST CONDITION | | MEASUREMENT DETAIL | |
|--------------------------|-----------------------------|--------------------|---------------------------|
| CHANNEL | Channel 0 | FREQUENCY RANGE | 1 ~ 25GHz |
| INPUT POWER (SYSTEM) | 120Vac, 60 Hz | DETECTOR FUNCTION | Peak (PK) Average (AV) |
| ENVIRONMENTAL CONDITIONS | 23deg. C, 65%RH 1020 hPa | TESTED BY | Brad Wu |

ANTENNA POLARITY & TEST DISTANCE: HORIZONTAL AT 3 M

| NO. | FREQ. (MHz) | EMISSION LEVEL (dBuV/m) | LIMIT (dBuV/m) | MARGIN (dB) | ANTENNA HEIGHT (m) | TABLE ANGLE (Degree) | RAW VALUE (dBuV) | CORRECTION FACTOR (dB/m) |
|-----|-------------|-------------------------|----------------|-------------|--------------------|----------------------|------------------|--------------------------|
| 1 | 2390.00 | 40.0 PK | 74.0 | -34.0 | 1.08 H | 14 | 9.50 | 30.50 |
| 2 | 2390.00 | 29.8 AV | 54.0 | -24.2 | 1.08 H | 14 | -0.70 | 30.50 |
| 3 | #2398.00 | 46.9 PK | 76.7 | -29.8 | 1.08 H | 14 | 16.40 | 30.50 |
| 4 | #2398.00 | 35.3 AV | 46.6 | -11.3 | 1.08 H | 14 | 4.80 | 30.50 |
| 5 | #2400.00 | 41.3 PK | 76.7 | -35.4 | 1.08 H | 14 | 10.80 | 30.50 |
| 6 | #2400.00 | 11.2 AV | 46.6 | -35.4 | 1.08 H | 14 | -19.30 | 30.50 |
| 7 | *2402.00 | 96.7 PK | | | 1.08 H | 14 | 66.20 | 30.50 |
| 8 | *2402.00 | 66.6 AV | | | 1.08 H | 14 | 36.10 | 30.50 |
| 9 | 4804.00 | 49.8 PK | 74.0 | -24.2 | 1.14 H | 26 | 13.70 | 36.10 |
| 10 | 4804.00 | 19.7 AV | 54.0 | -34.3 | 1.14 H | 26 | -16.40 | 36.10 |

ANTENNA POLARITY & TEST DISTANCE: VERTICAL AT 3 M

| NO. | FREQ. (MHz) | EMISSION LEVEL (dBuV/m) | LIMIT (dBuV/m) | MARGIN (dB) | ANTENNA HEIGHT (m) | TABLE ANGLE (Degree) | RAW VALUE (dBuV) | CORRECTION FACTOR (dB/m) |
|-----|-------------|-------------------------|----------------|-------------|--------------------|----------------------|------------------|--------------------------|
| 1 | 2390.00 | 39.2 PK | 74.0 | -34.8 | 1.02 V | 321 | 8.70 | 30.50 |
| 2 | 2390.00 | 29.1 AV | 54.0 | -24.9 | 1.02 V | 321 | -1.40 | 30.50 |
| 3 | #2398.00 | 45.8 PK | 73.2 | -27.4 | 1.02 V | 321 | 15.30 | 30.50 |
| 4 | #2398.00 | 34.2 AV | 43.1 | -8.9 | 1.02 V | 321 | 3.70 | 30.50 |
| 5 | #2400.00 | 37.8 PK | 73.2 | -35.4 | 1.02 V | 321 | 7.30 | 30.50 |
| 6 | #2400.00 | 7.7 AV | 43.1 | -35.4 | 1.02 V | 321 | -22.80 | 30.50 |
| 7 | *2402.00 | 93.2 PK | | | 1.02 V | 321 | 62.70 | 30.50 |
| 8 | *2402.00 | 63.1 AV | | | 1.02 V | 321 | 32.60 | 30.50 |
| 9 | 4804.00 | 48.9 PK | 74.0 | -25.1 | 1.11 V | 25 | 12.80 | 36.10 |
| 10 | 4804.00 | 18.8 AV | 54.0 | -35.2 | 1.11 V | 25 | -17.30 | 36.10 |

- REMARKS:**
1. Emission level (dBuV/m) = Raw Value (dBuV) + Correction Factor (dB/m).
 2. Correction Factor (dB/m) = Antenna Factor (dB/m) + Cable Factor (dB).
 3. The other emission levels were very low against the limit.
 4. Margin value = Emission level – Limit value.
 5. “ * ”: Fundamental frequency.
 6. The DH5 packet was the worse case duty cycle for a transmit dwell time on a channel, based upon bluetooth theory the transmitter is on 0.625 * 5 per 296.25 ms per channel. Therefore, the duty cycle correlation factor be equal to: $20\log(3.125 / 100) = -30.1$ dB.
 7. Average value = peak reading + $20\log(\text{duty cycle})$.
 8. "#":The radiated frequency is out the restricted band.



A D T

| EUT TEST CONDITION | | MEASUREMENT DETAIL | |
|--------------------------|-----------------------------|--------------------|---------------------------|
| CHANNEL | Channel 39 | FREQUENCY RANGE | 1 ~ 25GHz |
| INPUT POWER (SYSTEM) | 120Vac, 60 Hz | DETECTOR FUNCTION | Peak (PK) Average (AV) |
| ENVIRONMENTAL CONDITIONS | 23deg. C, 65%RH 1020 hPa | TESTED BY | Brad Wu |

| ANTENNA POLARITY & TEST DISTANCE: HORIZONTAL AT 3 M | | | | | | | | |
|---|-------------|-------------------------|----------------|-------------|--------------------|----------------------|------------------|--------------------------|
| NO. | FREQ. (MHz) | EMISSION LEVEL (dBuV/m) | LIMIT (dBuV/m) | MARGIN (dB) | ANTENNA HEIGHT (m) | TABLE ANGLE (Degree) | RAW VALUE (dBuV) | CORRECTION FACTOR (dB/m) |
| 1 | *2441.00 | 95.6 PK | | | 1.10 H | 12 | 64.90 | 30.70 |
| 2 | *2441.00 | 65.5 AV | | | 1.10 H | 12 | 34.80 | 30.70 |
| 3 | 4882.00 | 49.4 PK | 74.0 | -24.6 | 1.13 H | 52 | 13.20 | 36.20 |
| 4 | 4882.00 | 19.3 AV | 54.0 | -34.7 | 1.13 H | 52 | -16.90 | 36.20 |
| ANTENNA POLARITY & TEST DISTANCE: VERTICAL AT 3 M | | | | | | | | |
| NO. | FREQ. (MHz) | EMISSION LEVEL (dBuV/m) | LIMIT (dBuV/m) | MARGIN (dB) | ANTENNA HEIGHT (m) | TABLE ANGLE (Degree) | RAW VALUE (dBuV) | CORRECTION FACTOR (dB/m) |
| 1 | *2441.00 | 92.4 PK | | | 1.03 V | 330 | 61.70 | 30.70 |
| 2 | *2441.00 | 62.3 AV | | | 1.03 V | 330 | 31.60 | 30.70 |
| 3 | 4882.00 | 49.9 PK | 74.0 | -24.1 | 1.18 V | 65 | 13.70 | 36.20 |
| 4 | 4882.00 | 19.8 AV | 54.0 | -34.2 | 1.18 V | 65 | -16.40 | 36.20 |

- REMARKS:**
- Emission level (dBuV/m) = Raw Value (dBuV) + Correction Factor (dB/m).
 - Correction Factor (dB/m) = Antenna Factor (dB/m) + Cable Factor (dB).
 - The other emission levels were very low against the limit.
 - Margin value = Emission level – Limit value.
 - “ * “: Fundamental frequency.
 - The DH5 packet was the worse case duty cycle for a transmit dwell time on a channel, based upon bluetooth theory the transmitter is on 0.625 * 5 per 296.25 ms per channel. Therefore, the duty cycle correlation factor be equal to: $20\log(3.125 / 100) = -30.1$ dB.
 - Average value = peak reading + $20\log(\text{duty cycle})$.



A D T

| EUT TEST CONDITION | | MEASUREMENT DETAIL | |
|--------------------------|-----------------------------|--------------------|---------------------------|
| CHANNEL | Channel 78 | FREQUENCY RANGE | 1 ~ 25GHz |
| INPUT POWER (SYSTEM) | 120Vac, 60 Hz | DETECTOR FUNCTION | Peak (PK) Average (AV) |
| ENVIRONMENTAL CONDITIONS | 23deg. C, 65%RH 1020 hPa | TESTED BY | Brad Wu |

| ANTENNA POLARITY & TEST DISTANCE: HORIZONTAL AT 3 M | | | | | | | | |
|---|-------------|-------------------------|----------------|-------------|--------------------|----------------------|------------------|--------------------------|
| NO. | FREQ. (MHz) | EMISSION LEVEL (dBuV/m) | LIMIT (dBuV/m) | MARGIN (dB) | ANTENNA HEIGHT (m) | TABLE ANGLE (Degree) | RAW VALUE (dBuV) | CORRECTION FACTOR (dB/m) |
| 1 | *2480.00 | 94.5 PK | | | 1.10 H | 16 | 63.70 | 30.80 |
| 2 | *2480.00 | 64.4 AV | | | 1.10 H | 16 | 33.60 | 30.80 |
| 3 | 2483.50 | 36.3 PK | 74.0 | -37.7 | 1.10 H | 16 | 5.50 | 30.80 |
| 4 | 2483.50 | 6.2 AV | 54.0 | -47.8 | 1.10 H | 16 | -24.60 | 30.80 |
| 5 | 2485.50 | 42.6 PK | 74.0 | -31.4 | 1.10 H | 16 | 11.80 | 30.80 |
| 6 | 2485.50 | 29.4 AV | 54.0 | -24.6 | 1.10 H | 16 | -1.40 | 30.80 |
| 7 | 4960.00 | 50.2 PK | 74.0 | -23.8 | 1.13 H | 61 | 13.80 | 36.40 |
| 8 | 4960.00 | 20.1 AV | 54.0 | -33.9 | 1.13 H | 61 | -16.30 | 36.40 |
| ANTENNA POLARITY & TEST DISTANCE: VERTICAL AT 3 M | | | | | | | | |
| NO. | FREQ. (MHz) | EMISSION LEVEL (dBuV/m) | LIMIT (dBuV/m) | MARGIN (dB) | ANTENNA HEIGHT (m) | TABLE ANGLE (Degree) | RAW VALUE (dBuV) | CORRECTION FACTOR (dB/m) |
| 1 | *2480.00 | 91.4 PK | | | 1.05 V | 334 | 60.60 | 30.80 |
| 2 | *2480.00 | 61.3 AV | | | 1.05 V | 334 | 30.50 | 30.80 |
| 3 | 2483.50 | 33.2 PK | 74.0 | -40.8 | 1.05 V | 334 | 2.40 | 30.80 |
| 4 | 2483.50 | 3.1 AV | 54.0 | -50.9 | 1.05 V | 334 | -27.70 | 30.80 |
| 5 | 2485.50 | 42.0 PK | 74.0 | -32.0 | 1.05 V | 334 | 11.20 | 30.80 |
| 6 | 2485.50 | 28.9 AV | 54.0 | -25.1 | 1.05 V | 334 | -1.90 | 30.80 |
| 7 | 4960.00 | 48.8 PK | 74.0 | -25.2 | 1.15 V | 66 | 12.40 | 36.40 |
| 8 | 4960.00 | 18.7 AV | 54.0 | -35.3 | 1.15 V | 66 | -17.70 | 36.40 |

- REMARKS:**
- Emission level (dBuV/m) = Raw Value (dBuV) + Correction Factor (dB/m).
 - Correction Factor (dB/m) = Antenna Factor (dB/m) + Cable Factor (dB).
 - The other emission levels were very low against the limit.
 - Margin value = Emission level – Limit value.
 - * *: Fundamental frequency.
 - The DH5 packet was the worse case duty cycle for a transmit dwell time on a channel, based upon bluetooth theory the transmitter is on 0.625 * 5 per 296.25 ms per channel. Therefore, the duty cycle correlation factor be equal to: $20\log(3.125 / 100) = -30.1$ dB.
 - Average value = peak reading + $20\log(\text{duty cycle})$.



A D T

BELOW 1GHz WORST-CASE DATA : 8DPSK

| EUT TEST CONDITION | | MEASUREMENT DETAIL | |
|--------------------------|-----------------------------|--------------------|---------------|
| CHANNEL | Channel 39 | FREQUENCY RANGE | Below 1000MHz |
| INPUT POWER (SYSTEM) | 120Vac, 60 Hz | DETECTOR FUNCTION | Quasi-Peak |
| ENVIRONMENTAL CONDITIONS | 25deg. C, 65%RH 1020 hPa | TEST MODE | A |
| TESTED BY | Mark Liao | | |

| ANTENNA POLARITY & TEST DISTANCE: HORIZONTAL AT 3 M | | | | | | | | |
|---|-------------|-------------------------|----------------|-------------|--------------------|----------------------|------------------|--------------------------|
| NO. | FREQ. (MHz) | EMISSION LEVEL (dBuV/m) | LIMIT (dBuV/m) | MARGIN (dB) | ANTENNA HEIGHT (m) | TABLE ANGLE (Degree) | RAW VALUE (dBuV) | CORRECTION FACTOR (dB/m) |
| 1 | 70.73 | 23.6 QP | 40.0 | -16.4 | 1.50 H | 124 | 10.70 | 12.90 |
| 2 | 146.56 | 29.7 QP | 43.5 | -13.8 | 1.50 H | 217 | 16.00 | 13.70 |
| 3 | 228.22 | 24.2 QP | 46.0 | -21.8 | 1.25 H | 52 | 11.80 | 12.40 |
| 4 | 344.87 | 22.1 QP | 46.0 | -23.9 | 1.25 H | 28 | 6.30 | 15.80 |
| 5 | 564.58 | 20.9 QP | 46.0 | -25.1 | 1.00 H | 274 | -0.90 | 21.80 |
| 6 | 714.29 | 24.8 QP | 46.0 | -21.2 | 1.00 H | 340 | -0.40 | 25.20 |
| ANTENNA POLARITY & TEST DISTANCE: VERTICAL AT 3 M | | | | | | | | |
| NO. | FREQ. (MHz) | EMISSION LEVEL (dBuV/m) | LIMIT (dBuV/m) | MARGIN (dB) | ANTENNA HEIGHT (m) | TABLE ANGLE (Degree) | RAW VALUE (dBuV) | CORRECTION FACTOR (dB/m) |
| 1 | 31.84 | 33.0 QP | 40.0 | -7.0 | 1.50 V | 256 | 19.90 | 13.10 |
| 2 | 68.79 | 29.0 QP | 40.0 | -11.0 | 1.00 V | 256 | 15.70 | 13.30 |
| 3 | 218.50 | 30.2 QP | 46.0 | -15.8 | 1.25 V | 46 | 18.40 | 11.80 |
| 4 | 554.86 | 21.8 QP | 46.0 | -24.2 | 2.00 V | 67 | 0.20 | 21.60 |
| 5 | 640.41 | 23.2 QP | 46.0 | -22.8 | 1.25 V | 340 | -0.40 | 23.60 |
| 6 | 982.60 | 29.8 QP | 54.0 | -24.2 | 1.25 V | 145 | 1.00 | 28.80 |

- REMARKS:**
1. Emission level (dBuV/m) = Raw Value (dBuV) + Correction Factor (dB/m).
 2. Correction Factor (dB/m) = Antenna Factor (dB/m) + Cable Factor (dB).
 3. The other emission levels were very low against the limit.
 4. Margin value = Emission level – Limit value.



A D T

| EUT TEST CONDITION | | MEASUREMENT DETAIL | |
|--------------------------|-----------------------------|--------------------|---------------|
| CHANNEL | Channel 39 | FREQUENCY RANGE | Below 1000MHz |
| INPUT POWER (SYSTEM) | 120Vac, 60 Hz | DETECTOR FUNCTION | Quasi-Peak |
| ENVIRONMENTAL CONDITIONS | 25deg. C, 65%RH 1020 hPa | TEST MODE | B |
| TESTED BY | Mark Liao | | |

| ANTENNA POLARITY & TEST DISTANCE: HORIZONTAL AT 3 M | | | | | | | | |
|---|-------------|-------------------------|----------------|-------------|--------------------|----------------------|------------------|--------------------------|
| NO. | FREQ. (MHz) | EMISSION LEVEL (dBuV/m) | LIMIT (dBuV/m) | MARGIN (dB) | ANTENNA HEIGHT (m) | TABLE ANGLE (Degree) | RAW VALUE (dBuV) | CORRECTION FACTOR (dB/m) |
| 1 | 107.67 | 33.7 QP | 43.5 | -9.8 | 1.00 H | 283 | 22.20 | 11.50 |
| 2 | 243.77 | 27.1 QP | 46.0 | -18.9 | 1.00 H | 82 | 13.60 | 13.50 |
| 3 | 467.36 | 31.4 QP | 46.0 | -14.6 | 1.25 H | 4 | 11.70 | 19.70 |
| 4 | 665.68 | 40.1 QP | 46.0 | -5.9 | 1.00 H | 322 | 15.90 | 24.20 |
| 5 | 733.73 | 36.2 QP | 46.0 | -9.8 | 1.00 H | 172 | 10.80 | 25.40 |
| 6 | 932.05 | 33.9 QP | 46.0 | -12.1 | 1.00 H | 205 | 5.50 | 28.40 |
| ANTENNA POLARITY & TEST DISTANCE: VERTICAL AT 3 M | | | | | | | | |
| NO. | FREQ. (MHz) | EMISSION LEVEL (dBuV/m) | LIMIT (dBuV/m) | MARGIN (dB) | ANTENNA HEIGHT (m) | TABLE ANGLE (Degree) | RAW VALUE (dBuV) | CORRECTION FACTOR (dB/m) |
| 1 | 33.79 | 34.5 QP | 40.0 | -5.5 | 1.00 V | 10 | 20.70 | 13.80 |
| 2 | 107.67 | 32.8 QP | 43.5 | -10.7 | 1.00 V | 214 | 21.30 | 11.50 |
| 3 | 465.42 | 31.7 QP | 46.0 | -14.3 | 1.25 V | 259 | 12.00 | 19.70 |
| 4 | 543.19 | 33.7 QP | 46.0 | -12.3 | 1.00 V | 232 | 12.30 | 21.40 |
| 5 | 729.84 | 38.6 QP | 46.0 | -7.4 | 1.50 V | 205 | 13.20 | 25.40 |
| 6 | 928.16 | 37.8 QP | 46.0 | -8.2 | 1.25 V | 256 | 9.50 | 28.30 |

- REMARKS:**
1. Emission level (dBuV/m) = Raw Value (dBuV) + Correction Factor (dB/m).
 2. Correction Factor (dB/m) = Antenna Factor (dB/m) + Cable Factor (dB).
 3. The other emission levels were very low against the limit.
 4. Margin value = Emission level – Limit value.

4.2 CONDUCTED EMISSION MEASUREMENT

4.2.1 LIMITS OF CONDUCTED EMISSION MEASUREMENT

| FREQUENCY OF EMISSION (MHz) | CONDUCTED LIMIT (dB μ V) | |
|-----------------------------|------------------------------|----------|
| | Quasi-peak | Average |
| 0.15 ~ 0.5 | 66 to 56 | 56 to 46 |
| 0.5 ~ 5 | 56 | 46 |
| 5 ~ 30 | 60 | 50 |

- NOTE:**
1. The lower limit shall apply at the transition frequencies.
 2. The limit decreases in line with the logarithm of the frequency in the range of 0.15 to 0.50 MHz.
 3. All emanations from a class A/B digital device or system, including any network of conductors and apparatus connected thereto, shall not exceed the level of field strengths specified above.

4.2.2 TEST INSTRUMENTS

| DESCRIPTION & MANUFACTURER | MODEL NO. | SERIAL NO. | DATE OF CALIBRATION | DUE DATE OF CALIBRATION |
|----------------------------------|---------------------|----------------|---------------------|-------------------------|
| Test Receiver ROHDE & SCHWARZ | ESCS30 | 100288 | Sep. 24, 2009 | Sep. 23, 2010 |
| RF signal cable Woken | 5D-FB | Cable-HYCO2-01 | Dec. 31, 2009 | Dec. 30, 2010 |
| LISN ROHDE & SCHWARZ | ESH2-Z5 | 100100 | Aug. 24, 2009 | Aug. 23, 2010 |
| LISN ROHDE & SCHWARZ | ESH3-Z5 | 100311 | Jul. 29, 2009 | Jul. 28, 2010 |
| Software ADT | ADT_Cond_ V7.3.7 | NA | NA | NA |

- NOTE:**
1. The calibration interval of the above test instruments is 12 months and the calibrations are traceable to NML/ROC and NIST/USA.
 2. The test was performed in HwaYa Shielded Room 2.
 3. The VCCI Site Registration No. is C-2047.

4.2.3 TEST PROCEDURES

- a. The EUT was placed 0.4 meters from the conducting wall of the shielded room with EUT being connected to the power mains through a line impedance stabilization network (LISN). Other support units were connected to the power mains through another LISN. The two LISNs provide 50 ohm/ 50uH of coupling impedance for the measuring instrument.
- b. Both lines of the power mains connected to the EUT were checked for maximum conducted interference.
- c. The frequency range from 150kHz to 30MHz was searched. Emission levels under (Limit - 20dB) was not recorded.

NOTE: All modes of operation were investigated and the worst-case emissions are reported.

4.2.4 DEVIATION FROM TEST STANDARD

No deviation

4.2.5 TEST SETUP

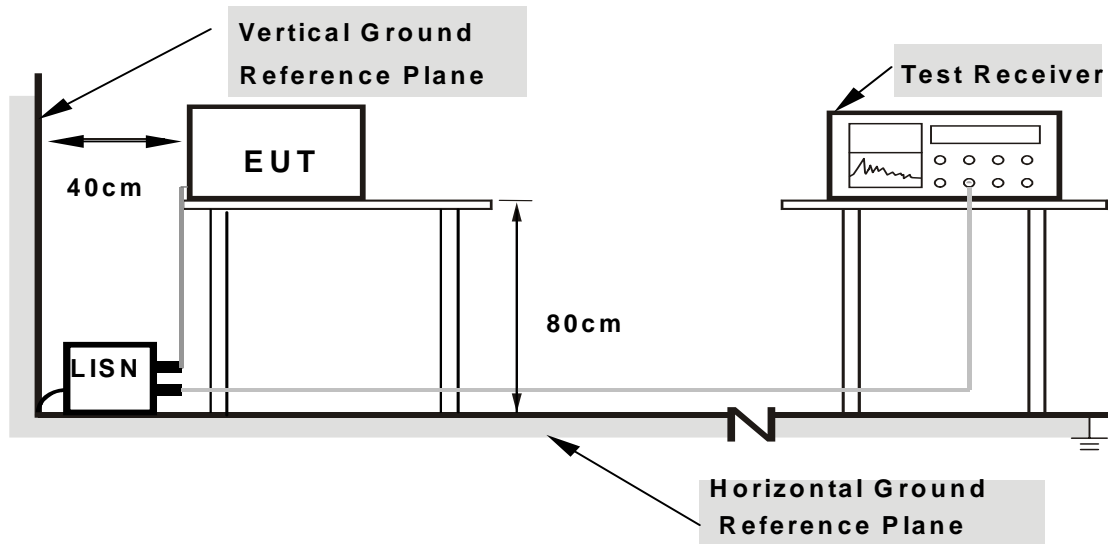

- Note:**
1. Support units were connected to second LISN.
 2. Both of LISNs (AMN) are 80 cm from EUT and at least 80 from other units and other metal planes

For the actual test configuration, please refer to the attached file (Test Setup Photo).

4.2.6 EUT OPERATING CONDITIONS

Same as 4.1.6

4.2.7 TEST RESULTS

CONDUCTED WORST CASE DATA: 8DPSK

| | | | |
|-----------|--------|---------------|------|
| PHASE | Line 1 | 6dB BANDWIDTH | 9kHz |
| TEST MODE | A | | |

| No | Freq. [MHz] | Corr. Factor (dB) | Reading Value | | Emission Level | | Limit | | Margin | |
|----|----------------|-------------------------|---------------|-----|----------------|-----|-----------|-------|--------|-----|
| | | | [dB (uV)] | | [dB (uV)] | | [dB (uV)] | | (dB) | |
| | | | Q.P. | AV. | Q.P. | AV. | Q.P. | AV. | Q.P. | AV. |
| 1 | 0.399 | 0.18 | 36.97 | - | 37.15 | - | 57.88 | 47.88 | -20.73 | - |
| 2 | 0.660 | 0.20 | 34.43 | - | 34.63 | - | 56.00 | 46.00 | -21.37 | - |
| 3 | 0.882 | 0.22 | 40.89 | - | 41.11 | - | 56.00 | 46.00 | -14.89 | - |
| 4 | 1.457 | 0.27 | 43.83 | - | 44.10 | - | 56.00 | 46.00 | -11.90 | - |
| 5 | 4.188 | 0.35 | 32.28 | - | 32.63 | - | 56.00 | 46.00 | -23.37 | - |
| 6 | 22.609 | 0.64 | 32.23 | - | 32.87 | - | 60.00 | 50.00 | -27.13 | - |

- REMARKS:**
1. Q.P. and AV. are abbreviations of quasi-peak and average individually.
 2. "-": The Quasi-peak reading value also meets average limit and measurement with the average detector is unnecessary.
 3. The emission levels of other frequencies were very low against the limit.
 4. Margin value = Emission level - Limit value
 5. Correction factor = Insertion loss + Cable loss
 6. Emission Level = Correction Factor + Reading Value.

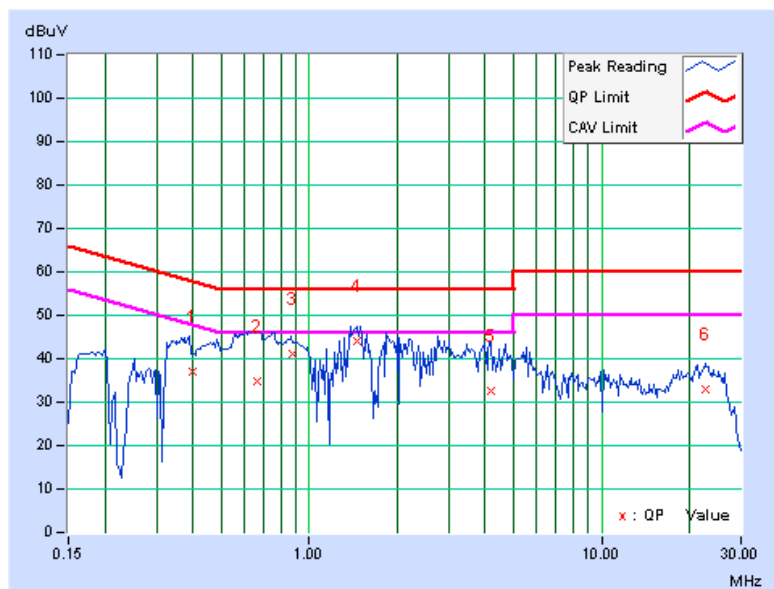



A D T

| | | | |
|-----------|--------|---------------|------|
| PHASE | Line 2 | 6dB BANDWIDTH | 9kHz |
| TEST MODE | A | | |

| No | Freq. [MHz] | Corr. Factor (dB) | Reading Value | | Emission Level | | Limit | | Margin | |
|----|----------------|-------------------------|---------------|-----|----------------|-----|-----------|-------|--------|-----|
| | | | [dB (uV)] | | [dB (uV)] | | [dB (uV)] | | (dB) | |
| | | | Q.P. | AV. | Q.P. | AV. | Q.P. | AV. | Q.P. | AV. |
| 1 | 0.162 | 0.13 | 48.41 | - | 48.54 | - | 65.38 | 55.38 | -16.84 | - |
| 2 | 0.326 | 0.15 | 43.18 | - | 43.33 | - | 59.57 | 49.57 | -16.24 | - |
| 3 | 0.657 | 0.19 | 39.98 | - | 40.17 | - | 56.00 | 46.00 | -15.83 | - |
| 4 | 1.254 | 0.24 | 33.21 | - | 33.45 | - | 56.00 | 46.00 | -22.55 | - |
| 5 | 1.398 | 0.25 | 33.92 | - | 34.17 | - | 56.00 | 46.00 | -21.83 | - |
| 6 | 23.977 | 0.87 | 28.61 | - | 29.48 | - | 60.00 | 50.00 | -30.52 | - |

- REMARKS:**
1. Q.P. and AV. are abbreviations of quasi-peak and average individually.
 2. "-": The Quasi-peak reading value also meets average limit and measurement with the average detector is unnecessary.
 3. The emission levels of other frequencies were very low against the limit.
 4. Margin value = Emission level - Limit value
 5. Correction factor = Insertion loss + Cable loss
 6. Emission Level = Correction Factor + Reading Value.

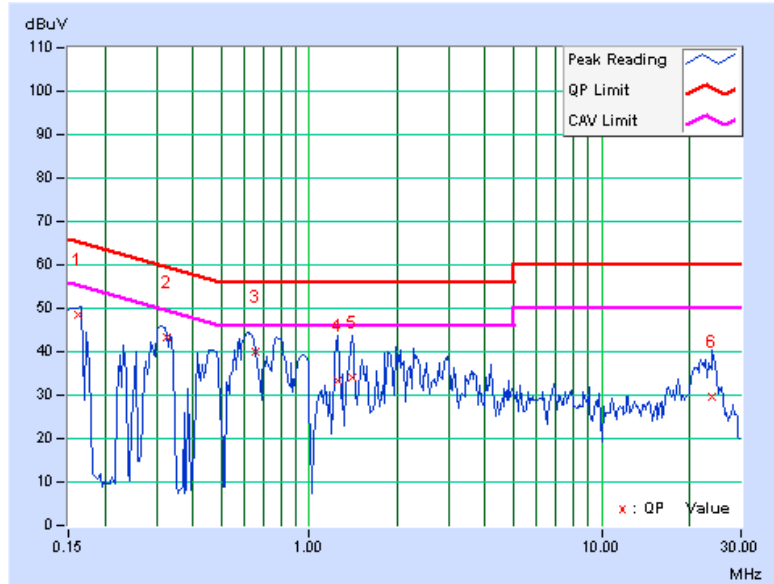

| | | | |
|-----------|--------|---------------|------|
| PHASE | Line 1 | 6dB BANDWIDTH | 9kHz |
| TEST MODE | B | | |

| No | Freq. [MHz] | Corr. Factor (dB) | Reading Value | | Emission Level | | Limit | | Margin | |
|----|----------------|-------------------------|---------------|-----|----------------|-----|-----------|-------|--------|-----|
| | | | [dB (uV)] | | [dB (uV)] | | [dB (uV)] | | (dB) | |
| | | | Q.P. | AV. | Q.P. | AV. | Q.P. | AV. | Q.P. | AV. |
| 1 | 0.168 | 0.16 | 52.70 | - | 52.86 | - | 65.07 | 55.07 | -12.21 | - |
| 2 | 0.224 | 0.16 | 45.92 | - | 46.08 | - | 62.66 | 52.66 | -16.57 | - |
| 3 | 0.282 | 0.17 | 35.48 | - | 35.65 | - | 60.77 | 50.77 | -25.12 | - |
| 4 | 0.339 | 0.17 | 37.59 | - | 37.76 | - | 59.24 | 49.24 | -21.47 | - |
| 5 | 3.770 | 0.35 | 32.55 | - | 32.90 | - | 56.00 | 46.00 | -23.10 | - |
| 6 | 10.734 | 0.37 | 30.27 | - | 30.64 | - | 60.00 | 50.00 | -29.36 | - |

- REMARKS:**
1. Q.P. and AV. are abbreviations of quasi-peak and average individually.
 2. "-": The Quasi-peak reading value also meets average limit and measurement with the average detector is unnecessary.
 3. The emission levels of other frequencies were very low against the limit.
 4. Margin value = Emission level - Limit value
 5. Correction factor = Insertion loss + Cable loss
 6. Emission Level = Correction Factor + Reading Value.

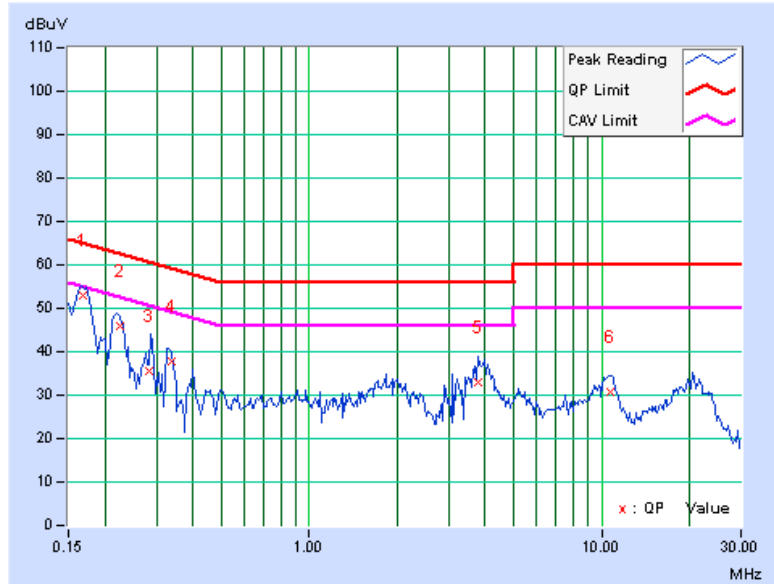



A D T

| | | | |
|-----------|--------|---------------|------|
| PHASE | Line 2 | 6dB BANDWIDTH | 9kHz |
| TEST MODE | B | | |

| No | Freq. [MHz] | Corr. Factor (dB) | Reading Value | | Emission Level | | Limit | | Margin | |
|----|----------------|-------------------------|---------------|-----|----------------|-----|-----------|-------|--------|-----|
| | | | [dB (uV)] | | [dB (uV)] | | [dB (uV)] | | (dB) | |
| | | | Q.P. | AV. | Q.P. | AV. | Q.P. | AV. | Q.P. | AV. |
| 1 | 0.167 | 0.13 | 53.06 | - | 53.19 | - | 65.11 | 55.11 | -11.93 | - |
| 2 | 0.224 | 0.13 | 45.48 | - | 45.61 | - | 62.66 | 52.66 | -17.05 | - |
| 3 | 0.282 | 0.14 | 39.05 | - | 39.19 | - | 60.77 | 50.77 | -21.58 | - |
| 4 | 2.117 | 0.30 | 30.31 | - | 30.61 | - | 56.00 | 46.00 | -25.39 | - |
| 5 | 3.945 | 0.36 | 33.17 | - | 33.53 | - | 56.00 | 46.00 | -22.47 | - |
| 6 | 10.527 | 0.46 | 31.30 | - | 31.76 | - | 60.00 | 50.00 | -28.24 | - |

- REMARKS:**
1. Q.P. and AV. are abbreviations of quasi-peak and average individually.
 2. "-": The Quasi-peak reading value also meets average limit and measurement with the average detector is unnecessary.
 3. The emission levels of other frequencies were very low against the limit.
 4. Margin value = Emission level - Limit value
 5. Correction factor = Insertion loss + Cable loss
 6. Emission Level = Correction Factor + Reading Value.

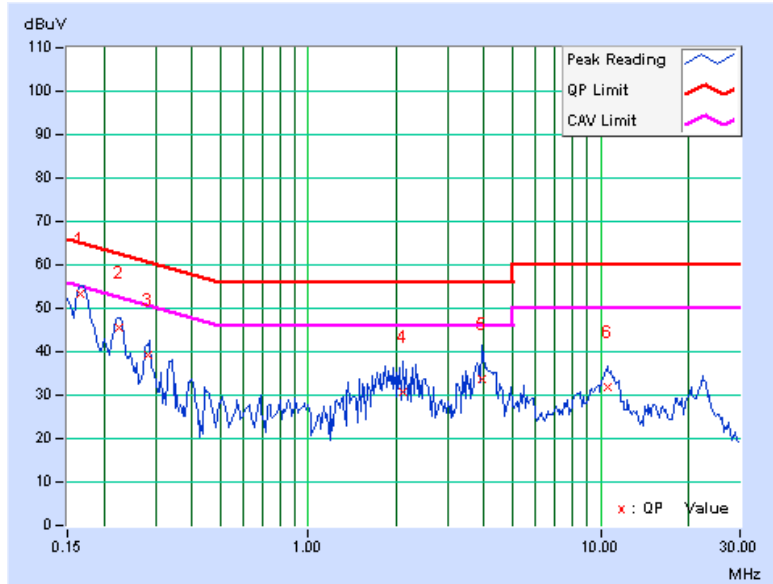

4.3 NUMBER OF HOPPING FREQUENCY USED

4.3.1 LIMIT OF HOPPING FREQUENCY USED

At least 15 channels frequencies, and should be equally spaced.

4.3.2 TEST INSTRUMENTS

| DESCRIPTION & MANUFACTURER | MODEL NO. | SERIAL NO. | DATE OF CALIBRATION | DUE DATE OF CALIBRATION |
|----------------------------|-----------|------------|---------------------|-------------------------|
| R&S SPECTRUM ANALYZER | FSP40 | 100040 | Jul. 07, 2009 | Jul. 06, 2010 |

NOTE: The calibration interval of the above test instruments is 12 months and the calibrations are traceable to NML/ROC and NIST/USA.

4.3.3 TEST PROCEDURES

- a. Check the calibration of the measuring instrument (SA) using either an internal calibrator or a known signal from an external generator.
- b. Turn on the EUT and connect its antenna terminal to measurement via a low loss cable. Then set it to any one measured frequency within its operating range and make sure the instrument is operated in its linear range.
- c. Set the SA on MaxHold Mode, and then keep the EUT in hopping mode. Record all the signals from each channel until each one has been recorded.
- d. Set the SA on View mode and then plot the result on SA screen.
- e. Repeat above procedures until all frequencies measured were complete.

4.3.4 DEVIATION FROM TEST STANDARD

No deviation.

4.3.5 TEST SETUP

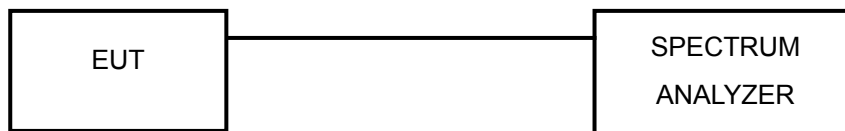

4.3.6 TEST RESULTS

There are 79 hopping frequencies in the hopping mode. Please refer to next two pages for the test result. On the plots, it shows that the hopping frequencies are equally spaced.



A D T

GFSK

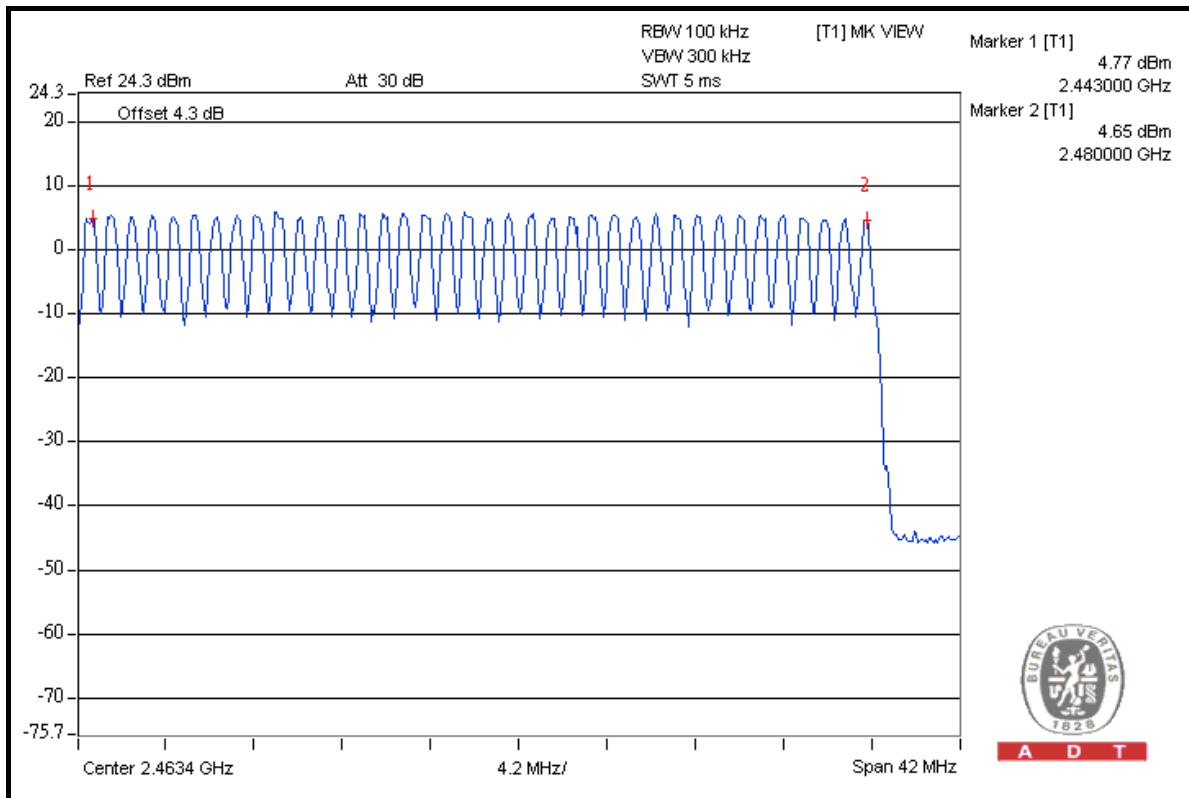
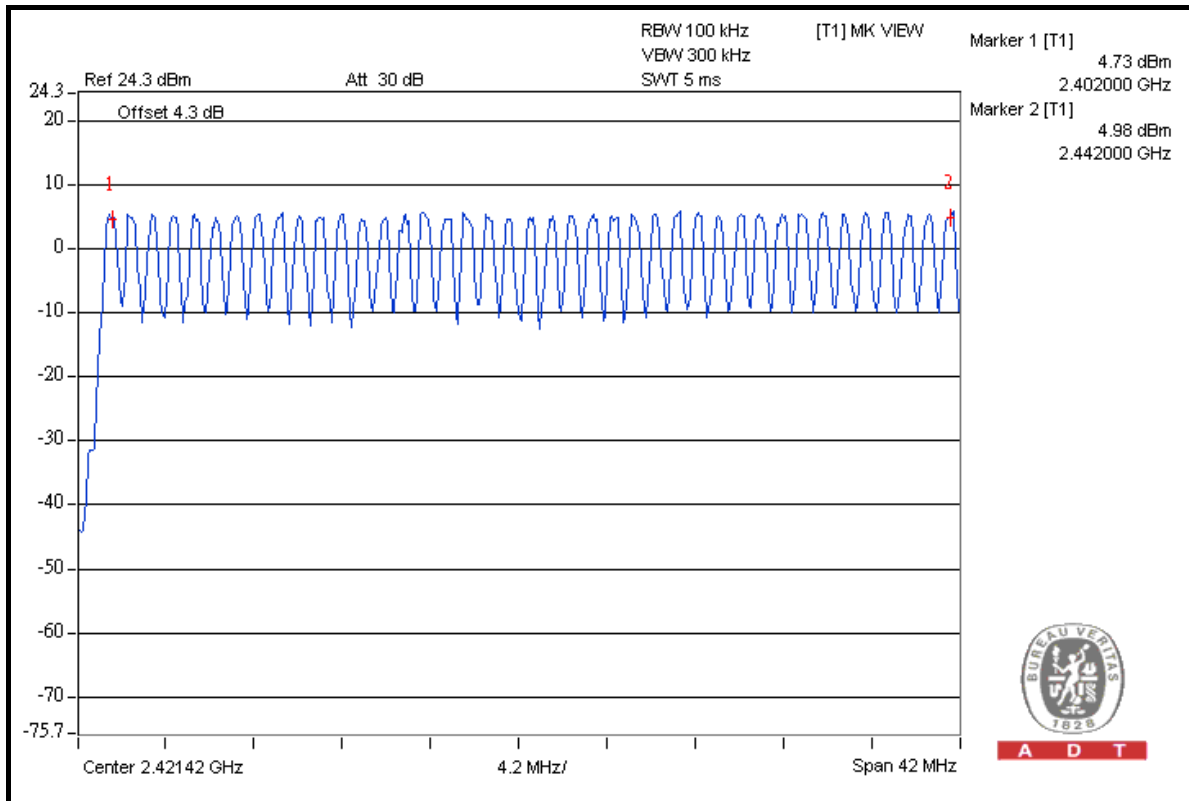



A D T

8DPSK

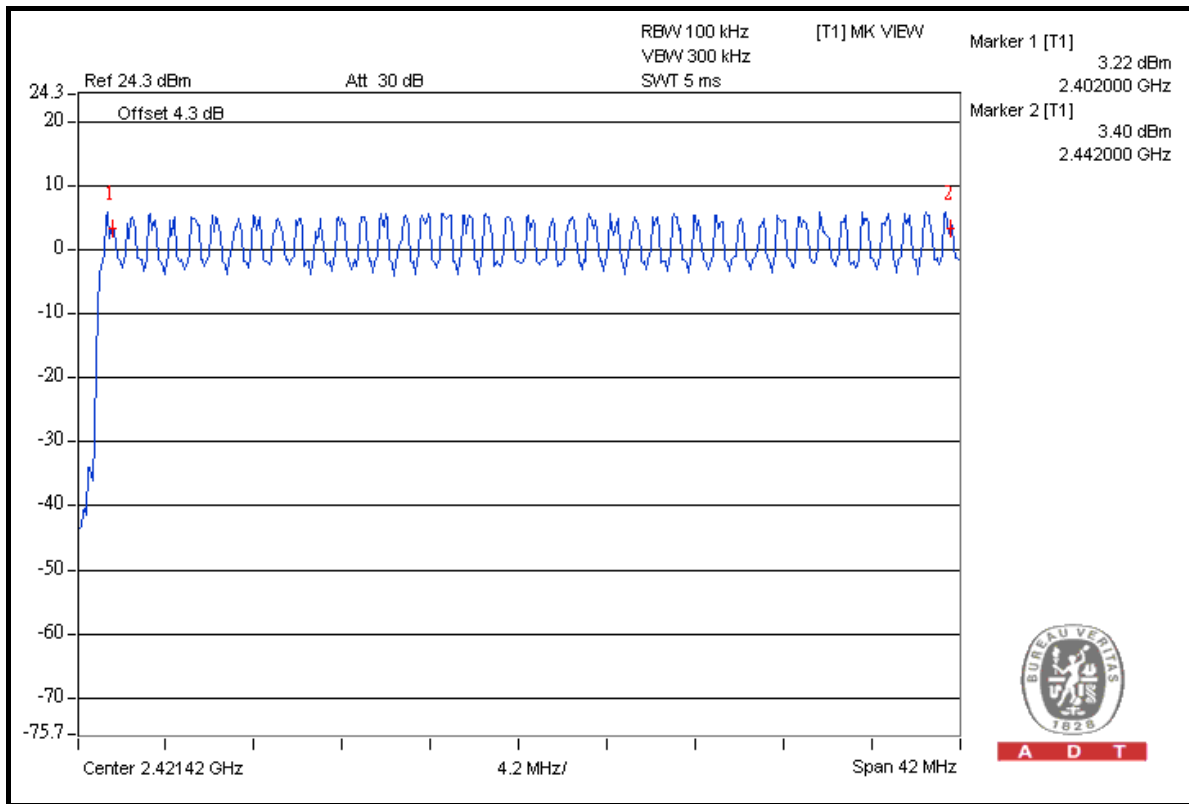

A D T

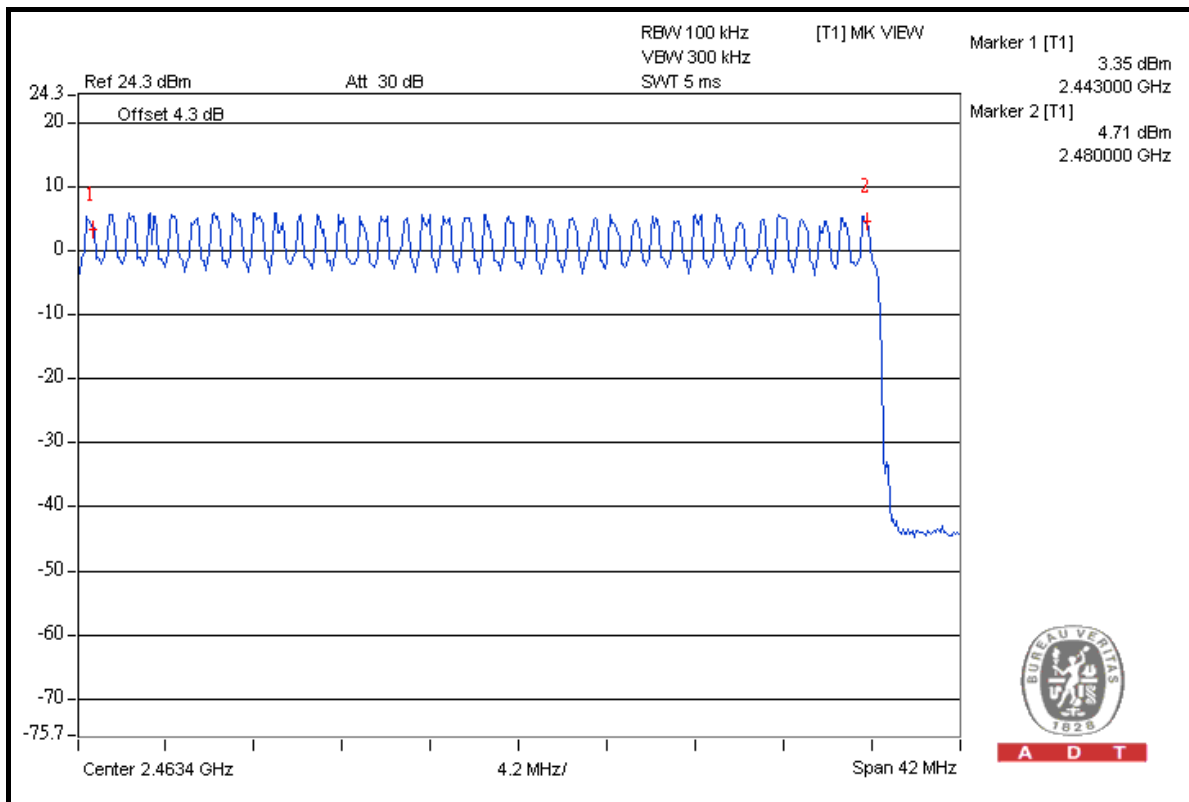

A D T

4.4 DWELL TIME ON EACH CHANNEL

4.4.1 LIMIT OF DWELL TIME USED

The average time of occupancy on any channel shall not be greater than 0.4 seconds within a period of 0.4 seconds multiplied by the number of hopping channels employed.

4.4.2 TEST INSTRUMENTS

| DESCRIPTION & MANUFACTURER | MODEL NO. | SERIAL NO. | DATE OF CALIBRATION | DUE DATE OF CALIBRATION |
|----------------------------|-----------|------------|---------------------|-------------------------|
| R&S SPECTRUM ANALYZER | FSP40 | 100040 | Jul. 07, 2009 | Jul. 06, 2010 |

NOTE: The calibration interval of the above test instruments is 12 months and the calibrations are traceable to NML/ROC and NIST/USA.

4.4.3 TEST PROCEDURES

- a. Check the calibration of the measuring instrument (SA) using either an internal calibrator or a known signal from an external generator.
- b. Turn on the EUT and connect its antenna terminal to measurement via a low loss cable. Then set it to any one measured frequency within its operating range and make sure the instrument is operated in its linear range.
- c. Adjust the center frequency of SA on any frequency be measured and set SA to zero span mode. And then, set RBW and VBW of spectrum analyzer to proper value.
- d. Measure the time duration of one transmission on the measured frequency. And then plot the result with time difference of this time duration.
- e. Repeat above procedures until all different time-slot modes have been completed.

4.4.4 DEVIATION FROM TEST STANDARD

No deviation.

4.4.5 TEST SETUP

Same as 4.3.5.

4.4.6 TEST RESULTS

GFSK

| Mode | Number of transmission in a 31.6 (79Hopping*0.4) | Length of transmission time (msec) | Result (msec) | Limit (msec) |
|------|--|------------------------------------|---------------|--------------|
| DH1 | 50 (times / 5 sec) * 6.32 = 316.00 times | 0.438 | 138.408 | 400 |
| DH3 | 27 (times / 5 sec) * 6.32 = 170.64 times | 1.680 | 286.675 | 400 |
| DH5 | 16(times / 5 sec) * 6.32 = 101.12times | 2.920 | 295.270 | 400 |

NOTE: Test plots of the transmitting time slot are shown on next 3 pages.



A D T

DH1

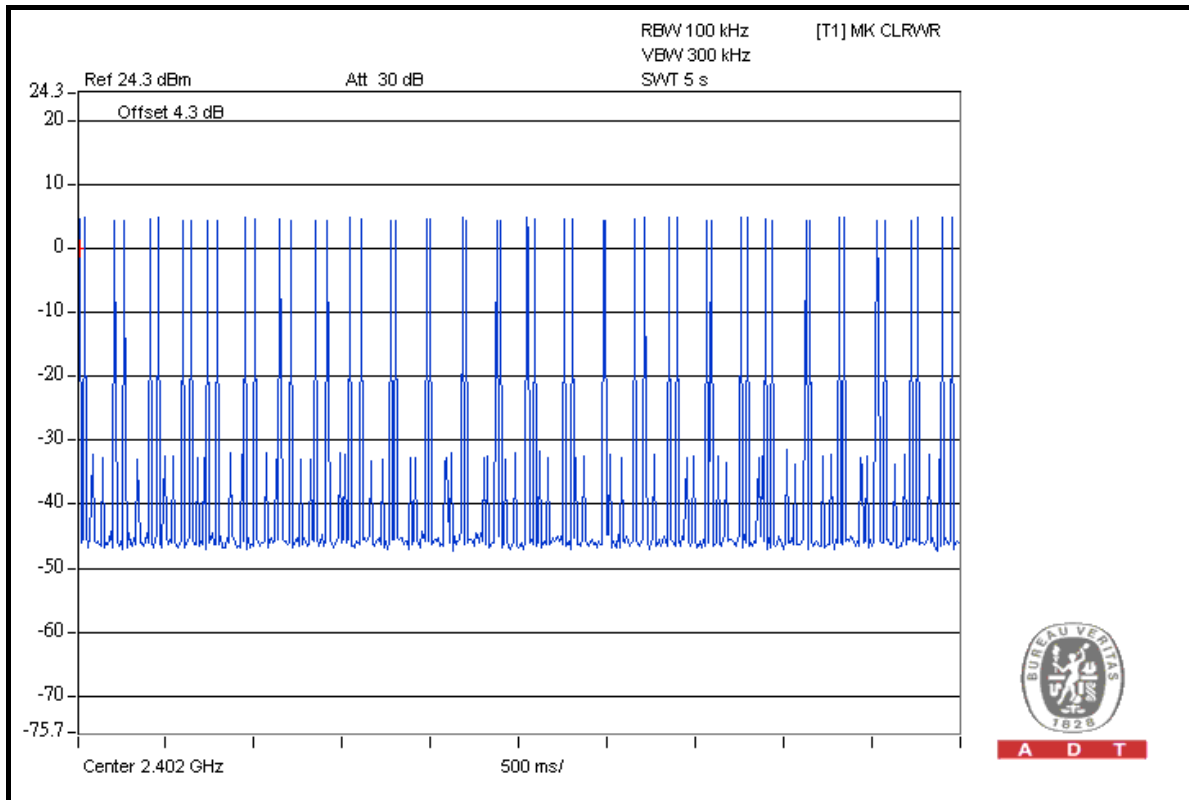

A D T

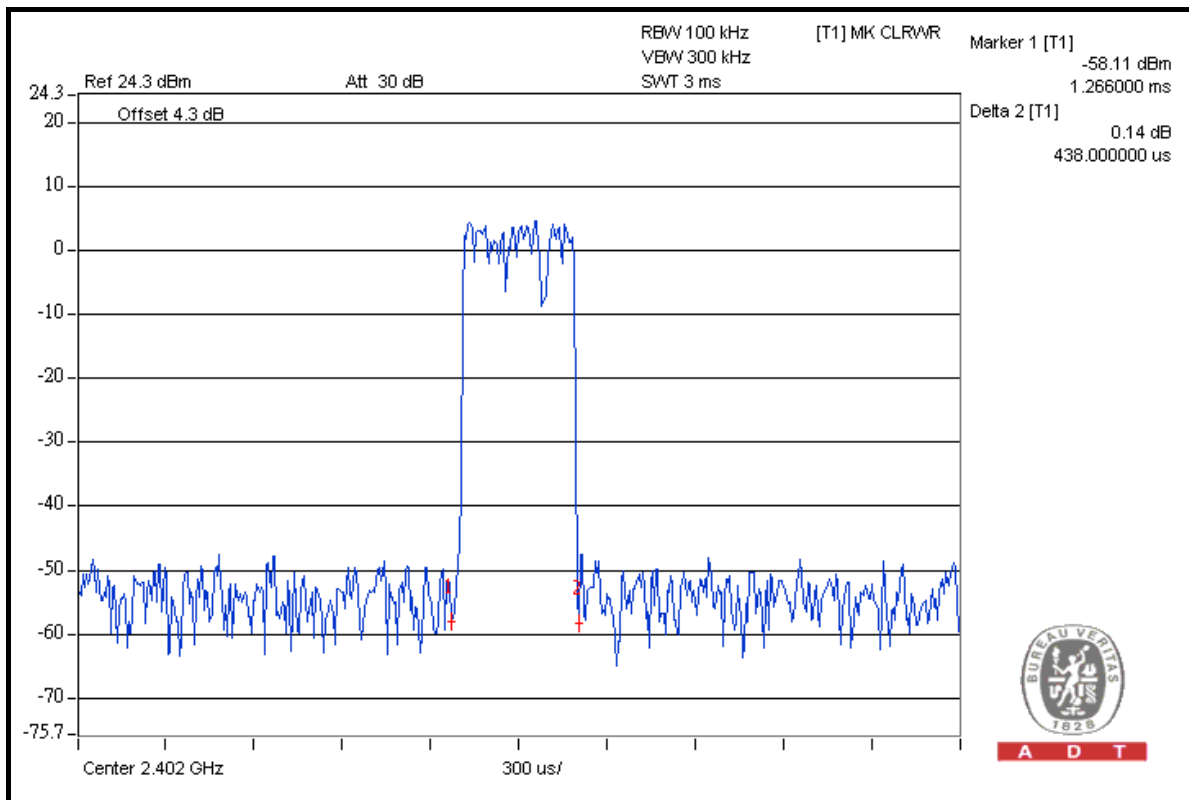

A D T



A D T

DH3

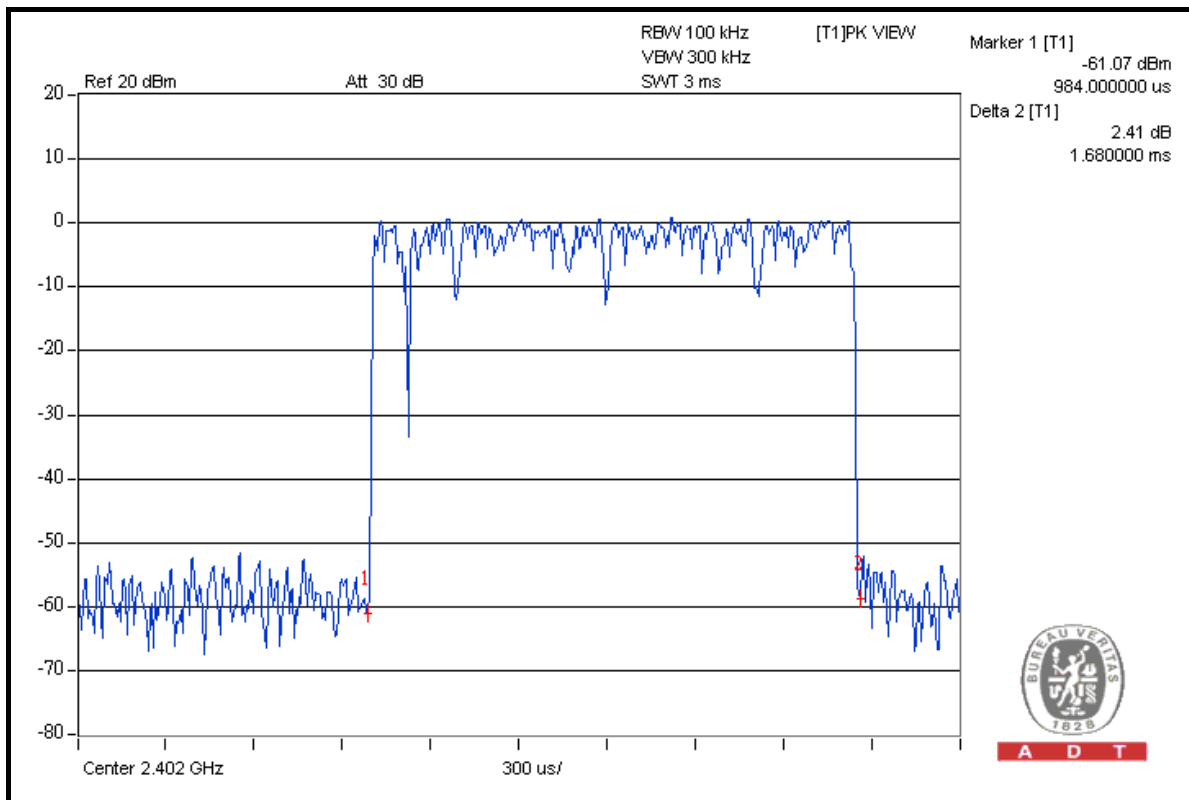
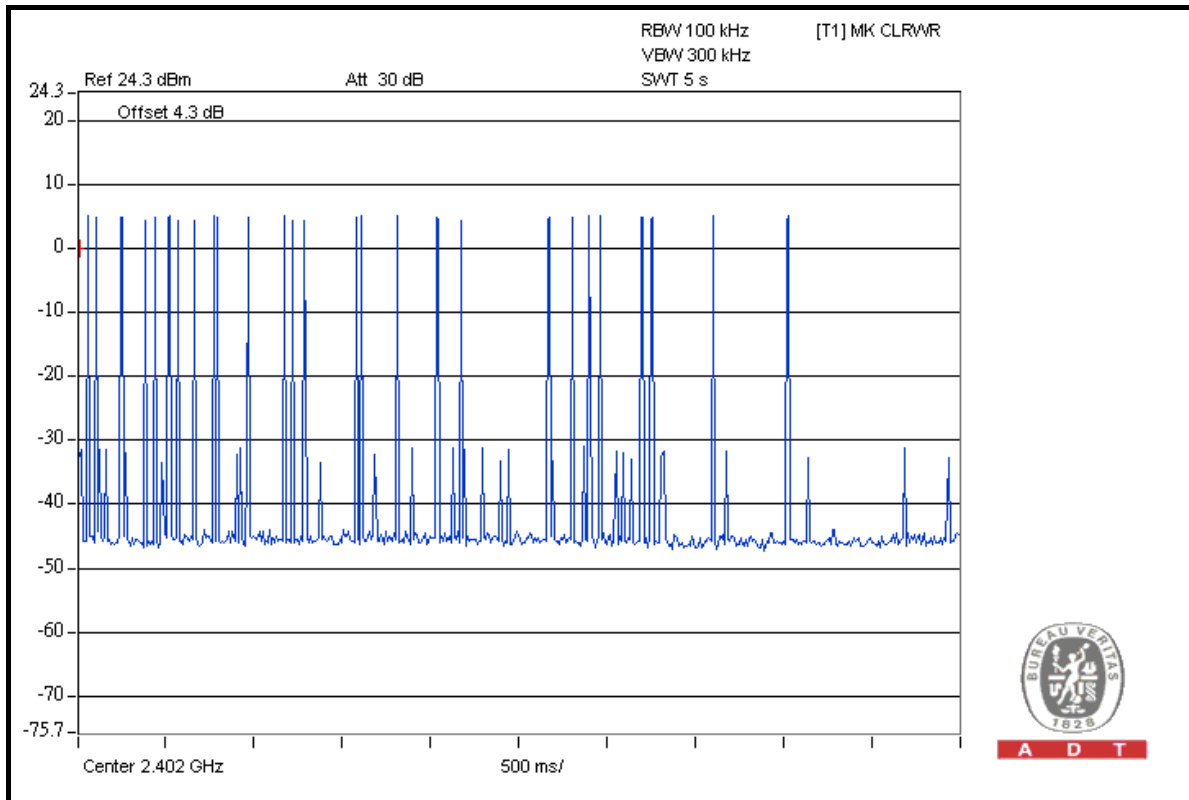



A D T

DH5

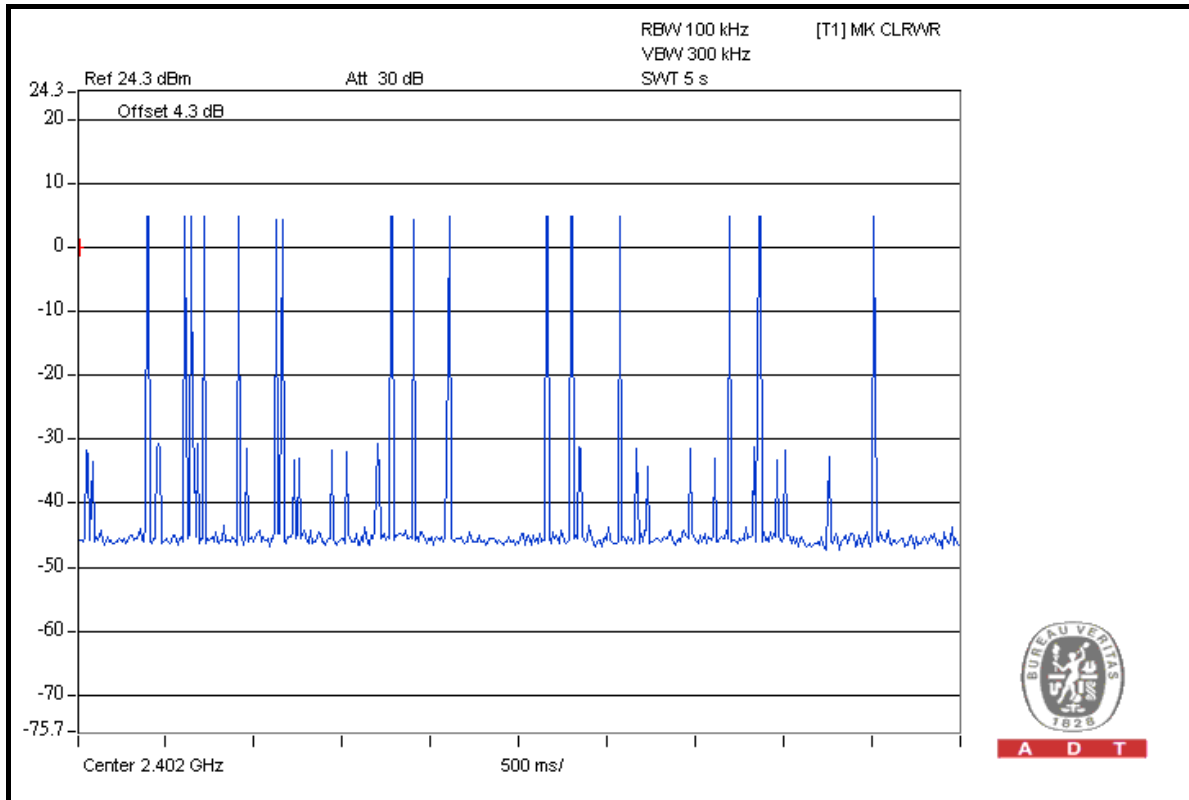

A D T

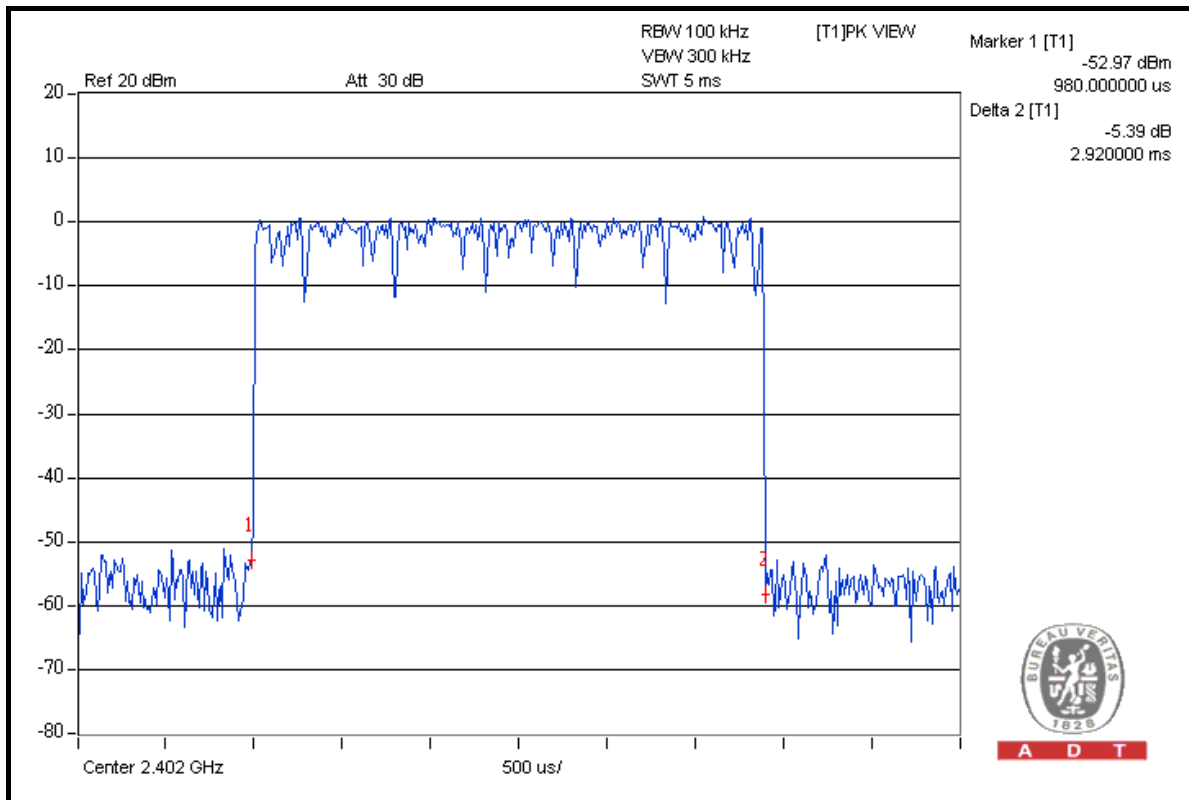

A D T



8DPSK

| Mode | Number of transmission in a 31.6 (79Hopping*0.4) | Length of transmission time (msec) | Result (msec) | Limit (msec) |
|------|--|------------------------------------|---------------|--------------|
| DH1 | 50 (times / 5 sec) * 6.32 = 316.00 times | 0.414 | 130.824 | 400 |
| DH3 | 25 (times / 5 sec) * 6.32 = 158.00 times | 1.698 | 268.284 | 400 |
| DH5 | 16 (times / 5 sec) * 6.32 = 101.12 times | 2.920 | 295.270 | 400 |

NOTE: Test plots of the transmitting time slot are shown on next 3 pages.



A D T

DH1

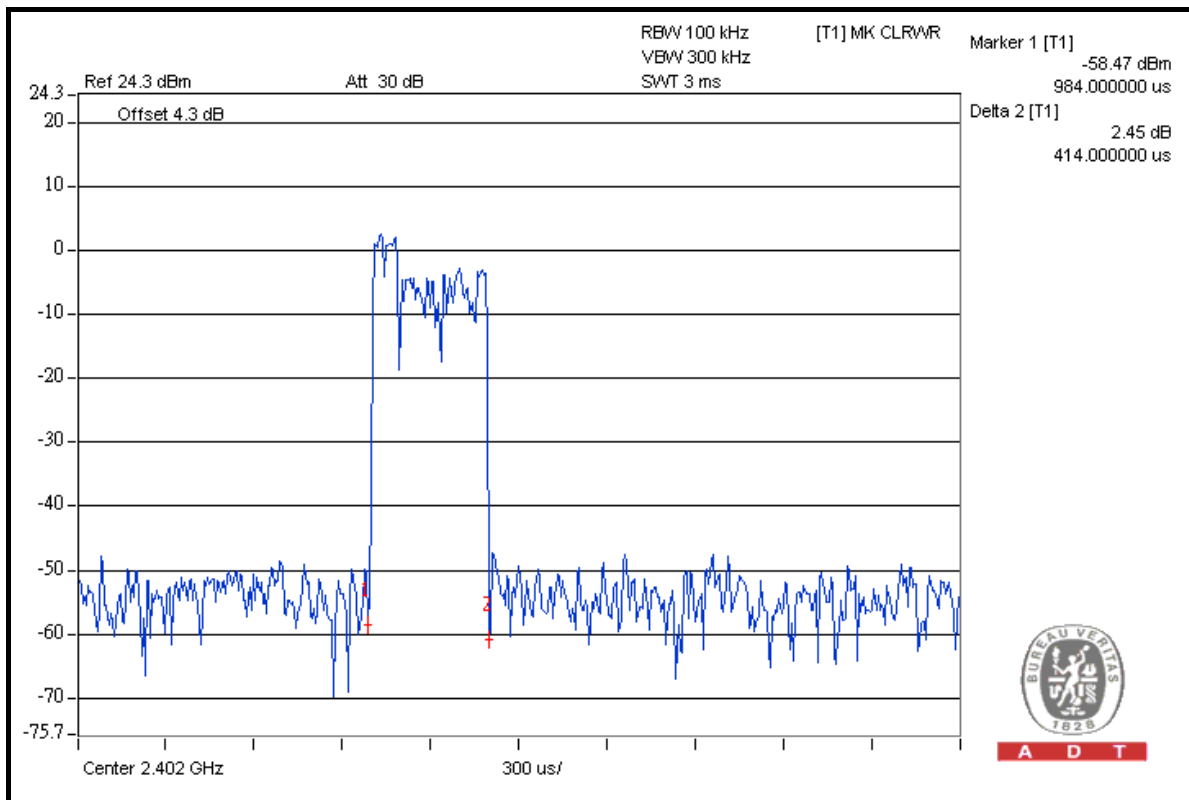
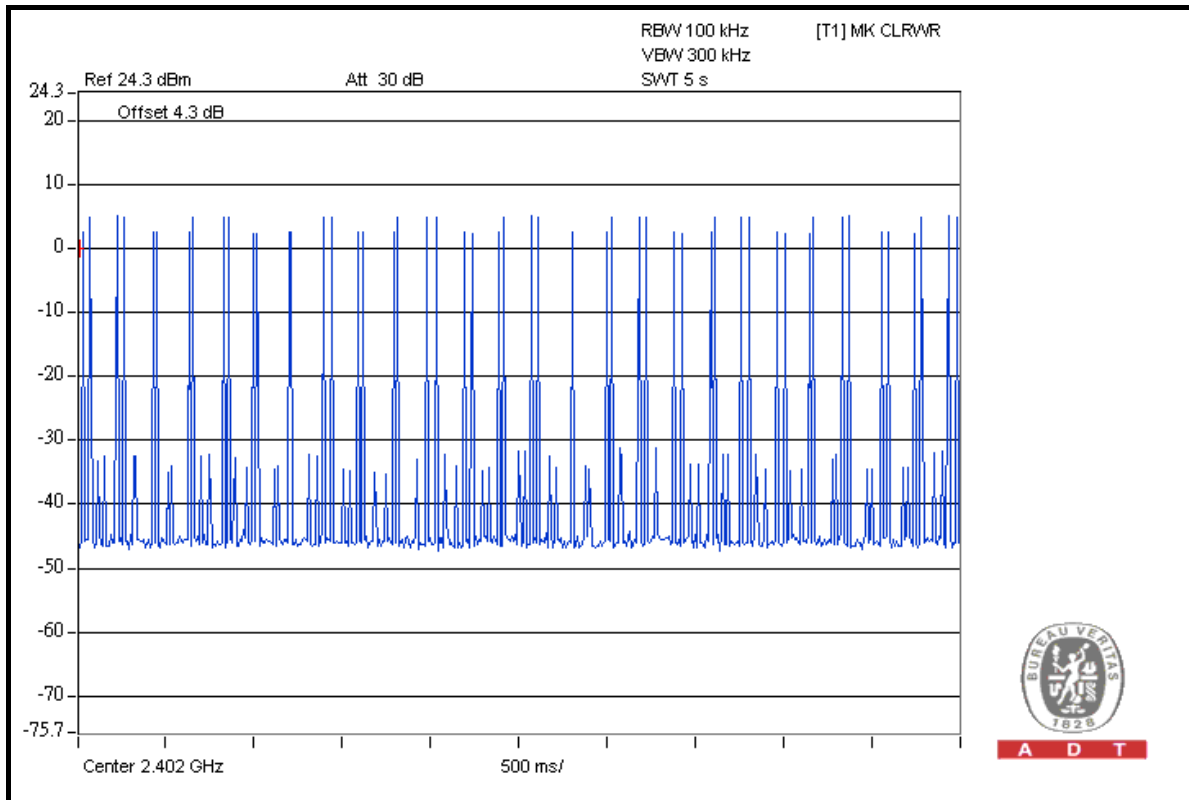



A D T

DH3

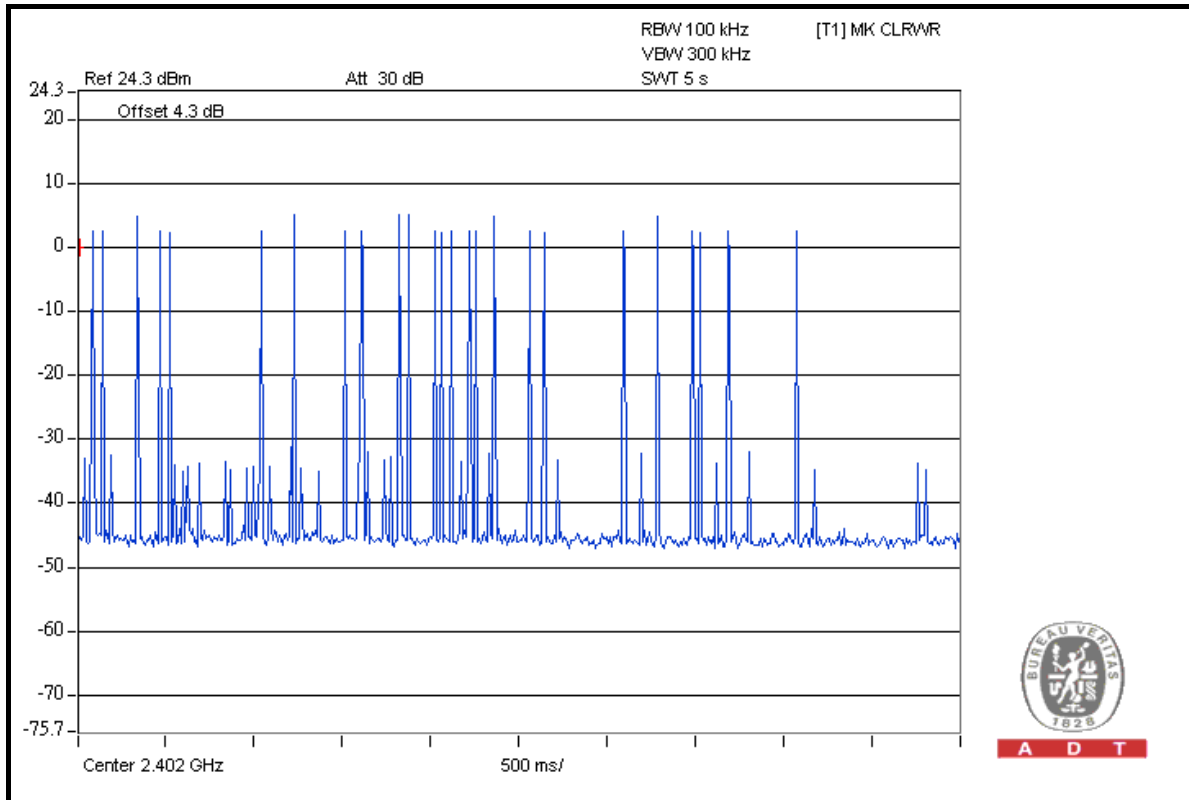

A D T

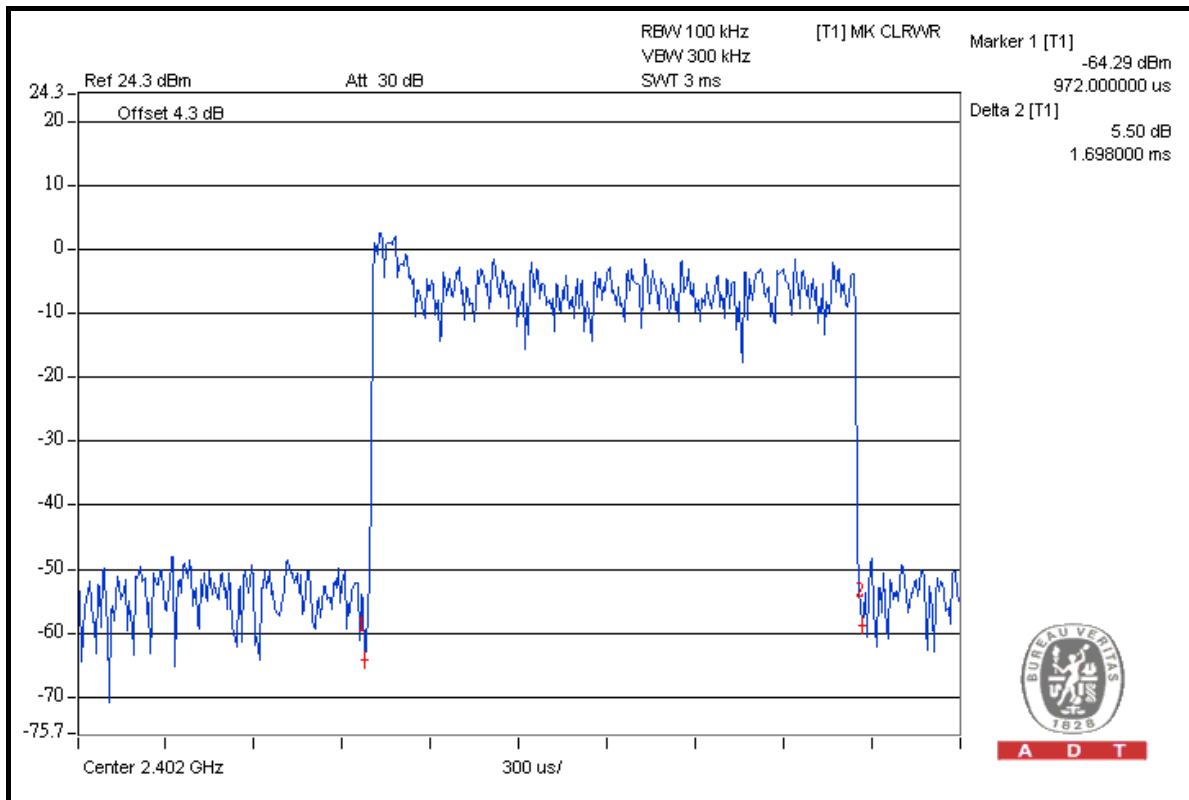

A D T

4.5 CHANNEL BANDWIDTH

4.5.1 LIMITS OF CHANNEL BANDWIDTH

For frequency hopping system operating in the 2400-2483.5MHz, If the 20dB bandwidth of hopping channel is greater than 25kHz, two-thirds 20dB bandwidth of hopping channel shall be a minimum limit for the hopping channel separation.

4.5.2 TEST INSTRUMENTS

| DESCRIPTION & MANUFACTURER | MODEL NO. | SERIAL NO. | DATE OF CALIBRATION | DUE DATE OF CALIBRATION |
|----------------------------|-----------|------------|---------------------|-------------------------|
| R&S SPECTRUM ANALYZER | FSP40 | 100040 | Jul. 07, 2009 | Jul. 06, 2010 |

NOTE: The calibration interval of the above test instruments is 12 months and the calibrations are traceable to NML/ROC and NIST/USA.

4.5.3 TEST PROCEDURE

- a. Check the calibration of the measuring instrument using either an internal calibrator or a known signal from an external generator.
- b. Turn on the EUT and connect it to measurement instrument. Then set it to any one convenient frequency within its operating range. Set a reference level on the measuring instrument equal to the highest peak value.
- c. Measure the frequency difference of two frequencies that were attenuated 20dB from the reference level. Record the frequency difference as the emission bandwidth.
- d. Repeat above procedures until all frequencies measured were complete.

4.5.4 DEVIATION FROM TEST STANDARD

No deviation.

4.5.5 TEST SETUP

Same as 4.3.5.

4.5.6 EUT OPERATING CONDITION

The software provided by client enabled the EUT to transmit and receive data at lowest, middle and highest channel frequencies individually.



A D T

4.5.7 TEST RESULTS

GFSK

| CHANNEL | CHANNEL FREQUENCY (MHz) | 20dB BANDWIDTH (MHz) |
|---------|-------------------------|----------------------|
| 0 | 2402 | 0.957 |
| 39 | 2441 | 0.957 |
| 78 | 2480 | 0.952 |

CH 0

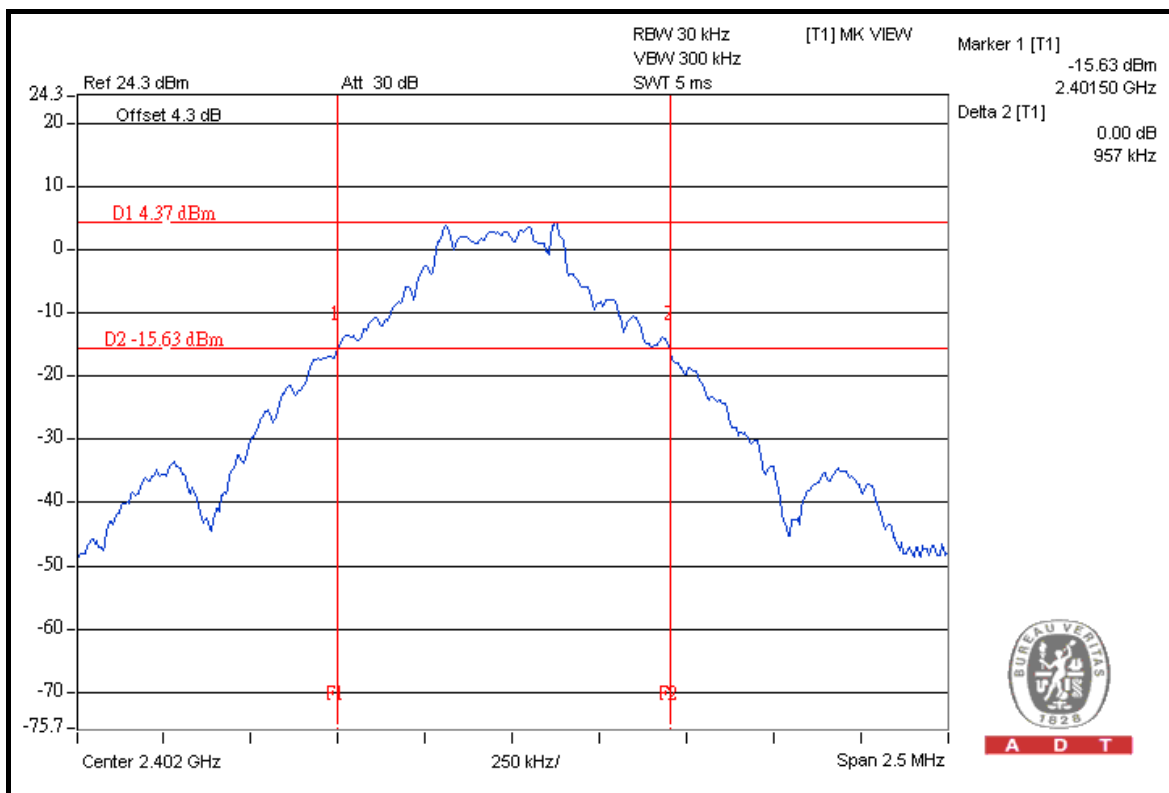



A D T

8DPSK

| CHANNEL | CHANNEL FREQUENCY (MHz) | 20dB BANDWIDTH (MHz) |
|---------|-------------------------|----------------------|
| 0 | 2402 | 1.210 |
| 39 | 2441 | 1.210 |
| 78 | 2480 | 1.210 |

CH 0

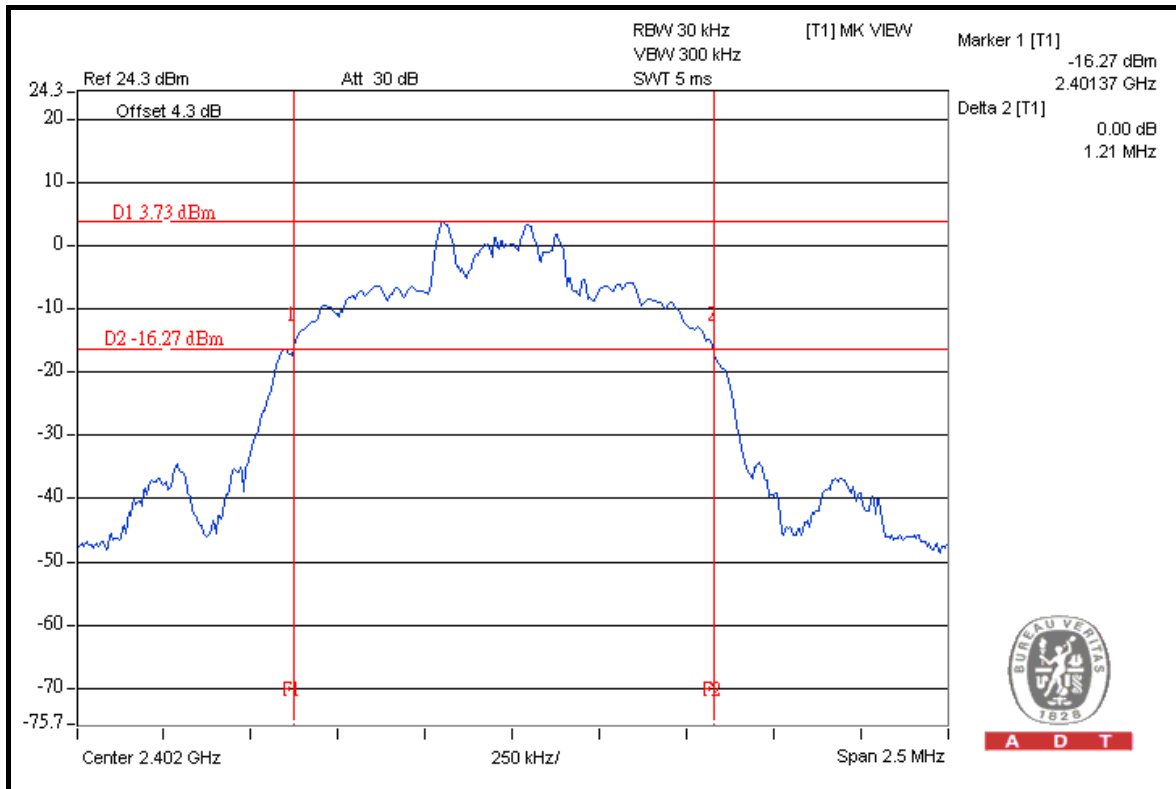

4.6 HOPPING CHANNEL SEPARATION

4.6.1 LIMIT OF HOPPING CHANNEL SEPARATION

At least 25kHz or two-third of 20dB hopping channel bandwidth (whichever is greater).

4.6.2 TEST INSTRUMENTS

| DESCRIPTION & MANUFACTURER | MODEL NO. | SERIAL NO. | DATE OF CALIBRATION | DUE DATE OF CALIBRATION |
|----------------------------|-----------|------------|---------------------|-------------------------|
| R&S SPECTRUM ANALYZER | FSP40 | 100040 | Jul. 07, 2009 | Jul. 06, 2010 |

NOTE: The calibration interval of the above test instruments is 12 months and the calibrations are traceable to NML/ROC and NIST/USA.

4.6.3 TEST PROCEDURES

1. Check the calibration of the measuring instrument using either an internal calibrator or a known signal from an external generator.
2. Turn on the EUT and connect it to measurement instrument. Then set it to any one convenient frequency within its operating range.
3. By using the MaxHold function record the separation of two adjacent channels.
4. Measure the frequency difference of these two adjacent channels by SA MARK function. And then plot the result on SA screen.
5. Repeat above procedures until all frequencies measured were complete.

4.6.4 DEVIATION FROM TEST STANDARD

No deviation.



A D T

4.6.5 TEST SETUP

Same as 4.3.5

4.6.6 TEST RESULTS

GFSK

| CHANNEL | FREQUENCY (MHz) | ADJACENT CHANNEL SEPARATION (MHz) | 20dB BANDWIDTH (MHz) | MINIMUM LIMIT (MHz) | PASS / FAIL |
|---------|-----------------|-----------------------------------|----------------------|---------------------|-------------|
| 0 | 2402 | 1.000 | 0.957 | 0.638 | PASS |
| 39 | 2441 | 1.000 | 0.957 | 0.638 | PASS |
| 78 | 2480 | 1.000 | 0.952 | 0.635 | PASS |

NOTE: The minimum limit is two-third 20dB bandwidth. Test results please refer to next two pages.

CH 0

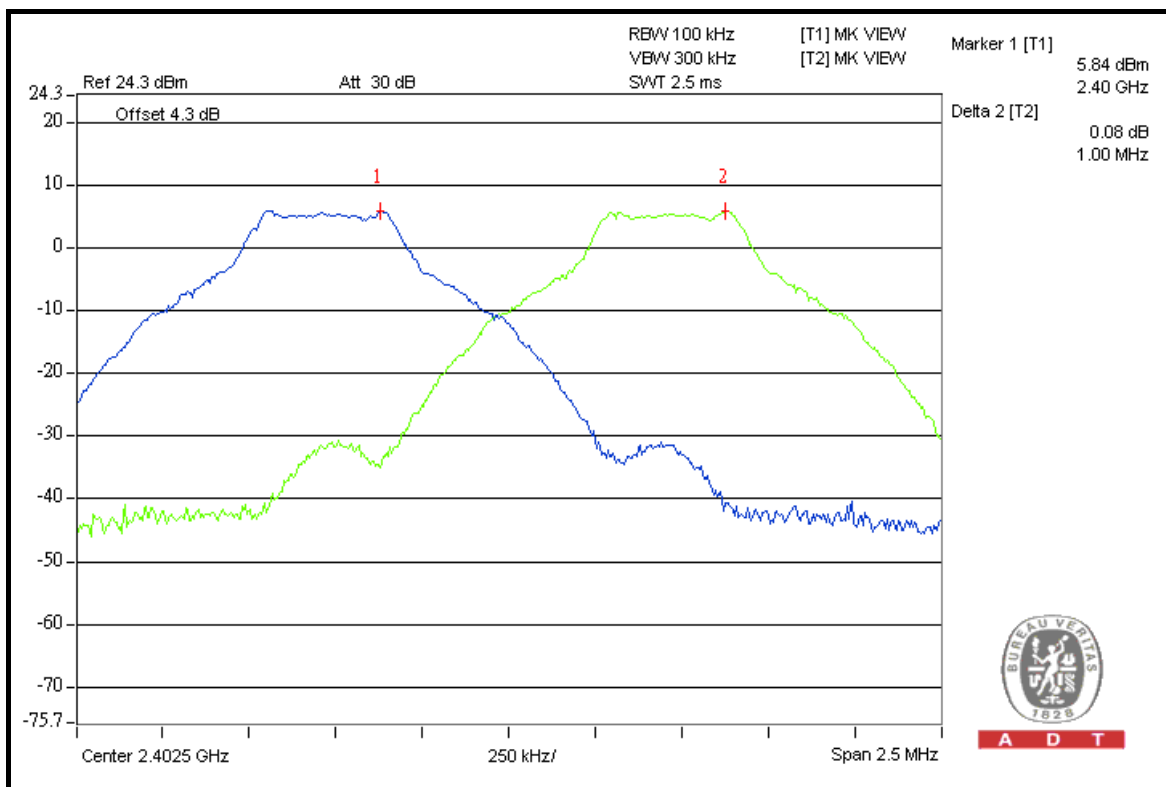

A D T



A D T

8DPSK

| CHANNEL | FREQUENCY (MHz) | ADJACENT CHANNEL SEPARATION (MHz) | 20dB BANDWIDTH (MHz) | MINIMUM LIMIT (MHz) | PASS / FAIL |
|---------|-----------------|-----------------------------------|----------------------|---------------------|-------------|
| 0 | 2402 | 1.000 | 1.210 | 0.807 | PASS |
| 39 | 2441 | 1.000 | 1.210 | 0.807 | PASS |
| 78 | 2480 | 1.000 | 1.210 | 0.807 | PASS |

NOTE: The minimum limit is two-third 20dB bandwidth. Test results please refer to next two pages.

CH 0

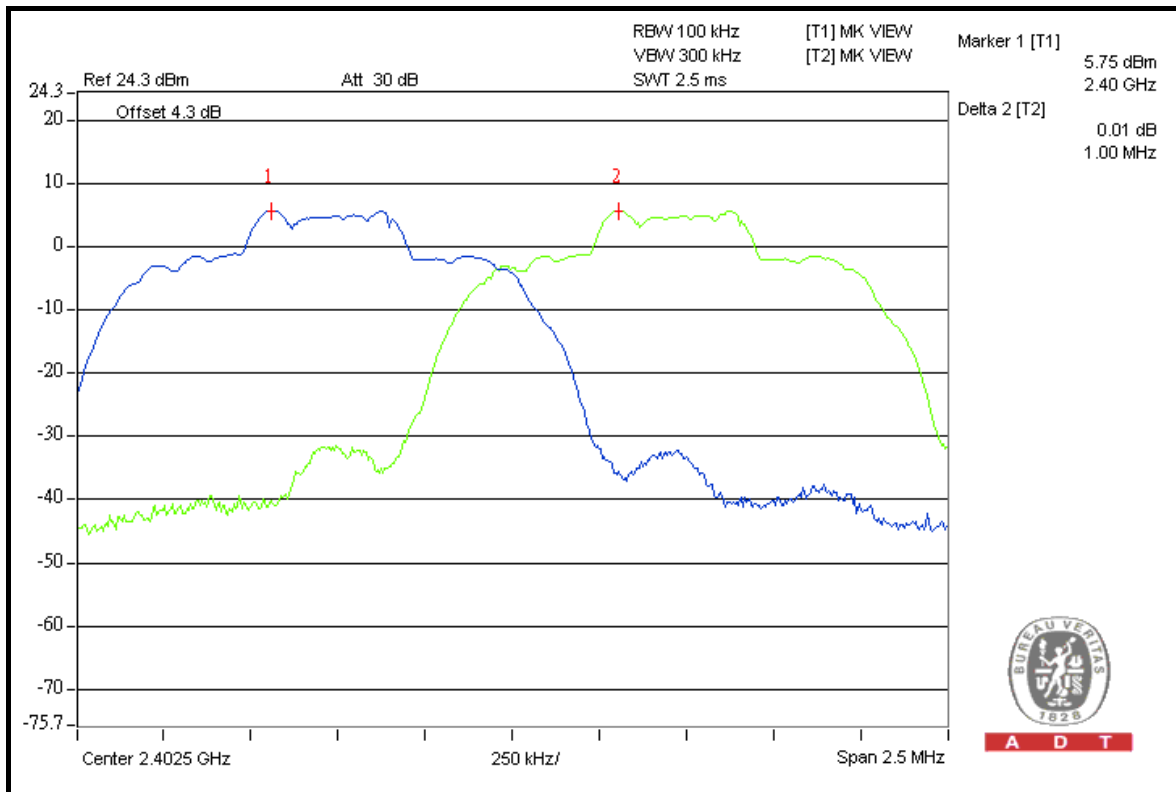



4.7 MAXIMUM OUTPUT POWER

4.7.1 LIMITS OF MAXIMUM OUTPUT POWER MEASUREMENT

The Maximum Output Power Measurement is 125mW.

4.7.2 TEST INSTRUMENTS

| DESCRIPTION & MANUFACTURER | MODEL NO. | SERIAL NO. | DATE OF CALIBRATION | DUE DATE OF CALIBRATION |
|----------------------------|-----------|------------|---------------------|-------------------------|
| R&S SPECTRUM ANALYZER | FSP40 | 100040 | Jul. 07, 2009 | Jul. 06, 2010 |

NOTE: The calibration interval of the above test instruments is 12 months and the calibrations are traceable to NML/ROC and NIST/USA.

4.7.3 TEST PROCEDURES

- a. Check the calibration of the measuring instrument using either an internal calibrator or a known signal from an external generator.
- b. Turn on the EUT and connect it to measurement instrument. Then set it to any one convenient frequency within its operating range. Set a reference level on the measuring instrument equal to the highest peak value.
- c. The center frequency of the spectrum analyzer is set to the fundamental frequency and using 3MHz RBW and 10 MHz VBW.
- d. Measure the captured power within the band and recording the plot.
- e. Repeat above procedures until all frequencies required were complete.

4.7.4 DEVIATION FROM TEST STANDARD

No deviation

4.7.5 TEST SETUP

Same as 4.3.5.

4.7.6 EUT OPERATING CONDITION

The software provided by client enabled the EUT to transmit and receive data at lowest, middle and highest channel frequencies individually.

4.7.7 TEST RESULTS

GFSK

| CHANNEL | CHANNEL FREQUENCY (MHz) | POWER OUTPUT (mW) | POWER OUTPUT (dBm) | POWER LIMIT (mW) | PASS/FAIL |
|---------|-------------------------|-------------------|--------------------|------------------|-----------|
| 0 | 2402 | 3.5 | 5.4 | 125 | PASS |
| 39 | 2441 | 3.6 | 5.5 | 125 | PASS |
| 78 | 2480 | 3.5 | 5.4 | 125 | PASS |

CH 39

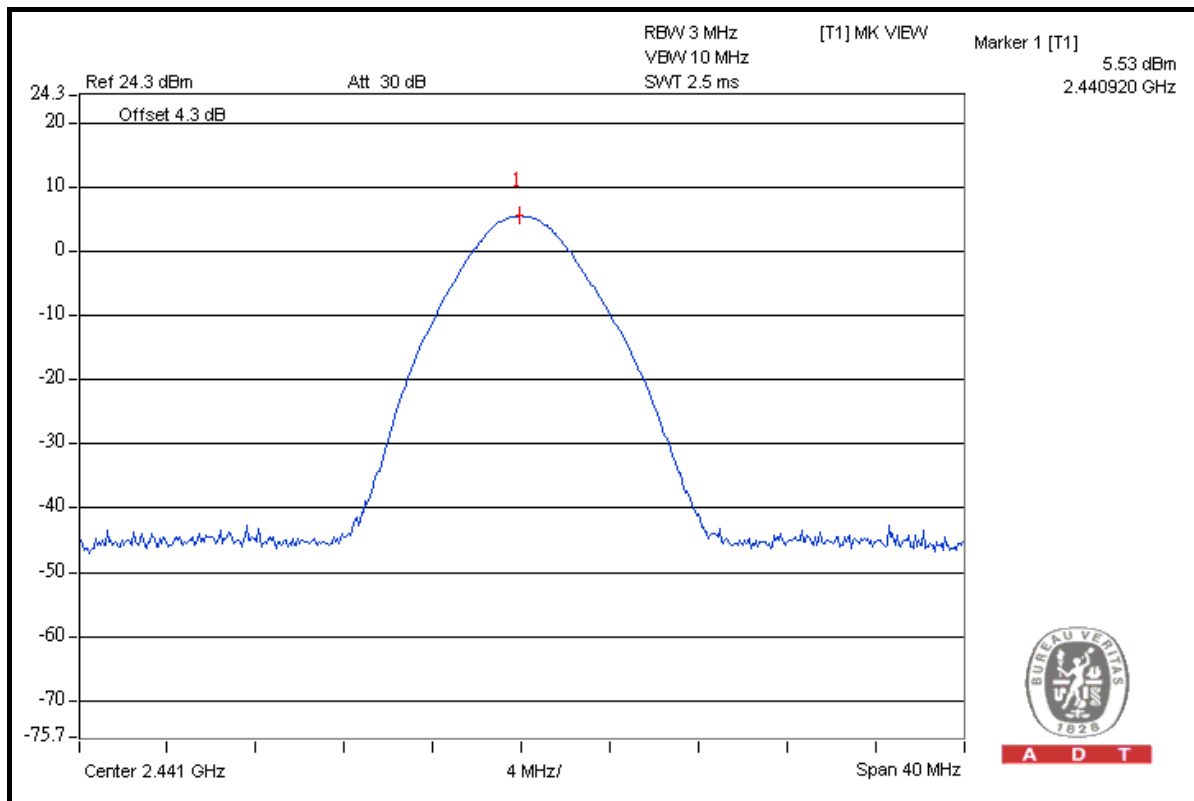



A D T

8DPSK

| CHANNEL | CHANNEL FREQUENCY (MHz) | POWER OUTPUT (mW) | POWER OUTPUT (dBm) | PEAK POWER LIMIT (mW) | PASS/FAIL |
|---------|-------------------------|-------------------|--------------------|-----------------------|-----------|
| 0 | 2402 | 3.3 | 5.2 | 125 | PASS |
| 39 | 2441 | 3.5 | 5.4 | 125 | PASS |
| 78 | 2480 | 3.4 | 5.3 | 125 | PASS |

CH 39

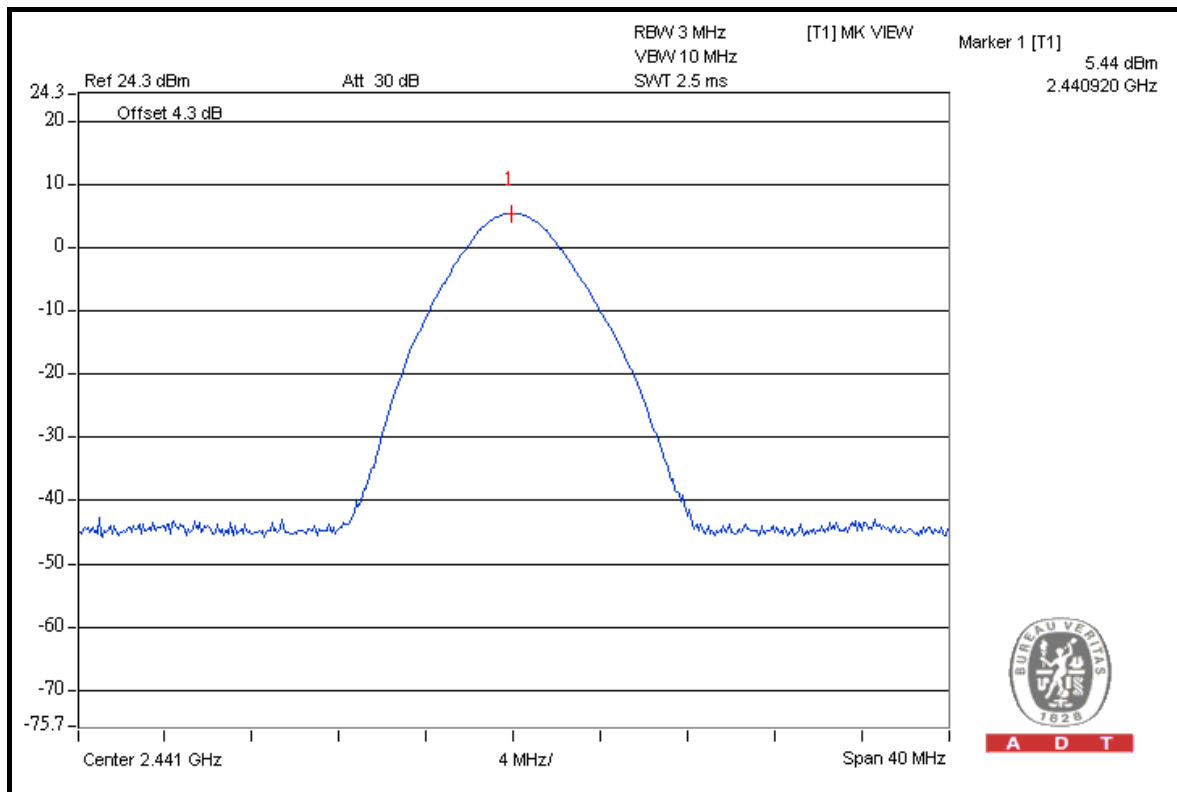

4.8 BAND EDGES MEASUREMENT

4.8.1 LIMITS OF BAND EDGES MEASUREMENT

Below -20dB of the highest emission level of operating band (in 100KHz RBW).

4.8.2 TEST INSTRUMENTS

| DESCRIPTION & MANUFACTURER | MODEL NO. | SERIAL NO. | DATE OF CALIBRATION | DUE DATE OF CALIBRATION |
|----------------------------|-----------|------------|---------------------|-------------------------|
| R&S SPECTRUM ANALYZER | FSP40 | 100040 | Jul. 07, 2009 | Jul. 06, 2010 |

NOTE: The calibration interval of the above test instruments is 12 months and the calibrations are traceable to NML/ROC and NIST/USA.

4.8.3 TEST PROCEDURE

The transmitter output was connected to the spectrum analyzer via a low lose cable. Set both RBW and VBW of spectrum analyzer to 100 kHz with suitable frequency span including 100 MHz bandwidth from band edge. The band edges was measured and recorded.

4.8.4 DEVIATION FROM TEST STANDARD

No deviation.

4.8.5 EUT OPERATING CONDITION

The software provided by client enabled the EUT to transmit and receive data at lowest, middle and highest channel frequencies individually.

4.8.6 TEST RESULTS

The spectrum plots are attached on the following 8 images. D1 line indicates the highest level, D2 line indicates the 20dB offset below D1. It shows compliance with the requirement in part 15.247(d).

GFSK

RESTRICT BAND (2310 ~ 2390 MHz)

| FREQUENCY (MHz) | FUNDAMENTAL EMISSION (dBuV/m) | DELTA (dB) | MAXIMUM FIELD STRENGTH IN RESTRICT BAND (dBuV/m) | LIMIT (dBuV/m) |
|-----------------|-------------------------------|------------|--|----------------|
| 2402.00 (PK) | 95.8 | 49.67 | 46.13 | 74.00 |
| 2402.00 (AV) | - | - | 16.03 | 54.00 |

RESTRICT BAND (2483.5 ~ 2500 MHz)

| FREQUENCY (MHz) | FUNDAMENTAL EMISSION (dBuV/m) | DELTA (dB) | MAXIMUM FIELD STRENGTH IN RESTRICT BAND (dBuV/m) | LIMIT (dBuV/m) |
|-----------------|-------------------------------|------------|--|----------------|
| 2480.00 (PK) | 93.6 | 49.92 | 43.68 | 74.00 |
| 2480.00 (AV) | - | - | 13.58 | 54.00 |

NOTE:

1. Delta = Amplitude between the peak of the fundamental and the peak of the band edge emission. Please check following 2 pages.
2. Maximum field strength in restrict band (PK value) = Fundamental emission (PK value) – Delta.
3. Average value = Peak value + 20 Log (duty cycle) = Peak value – 30.1dB.
4. The DH5 packet was the worse case duty cycle for a transmit dwell time on a channel, based upon Bluetooth theory the transmitter is on $0.625 * 5$ per 296.25 ms per channel. Therefore, the duty cycle correction factor be equal to: $20\log(3.125/100) = -30.1$ dB.



A D T

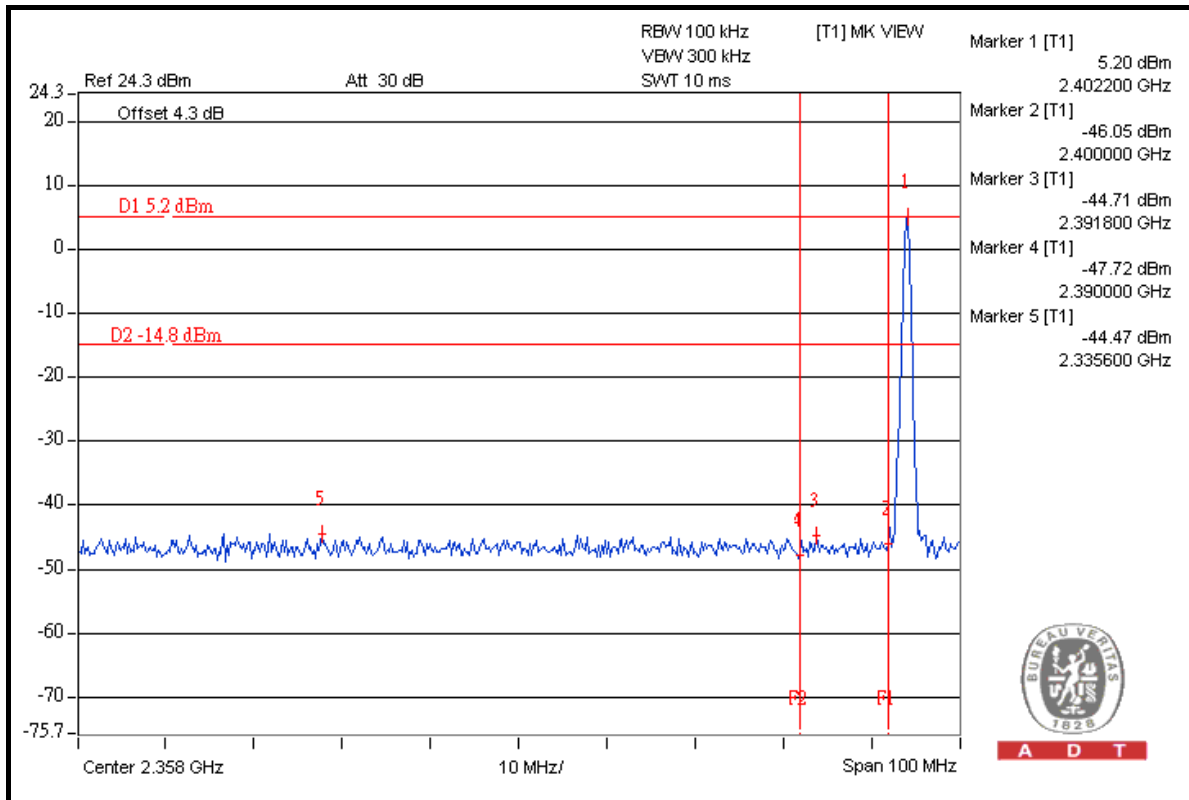

A D T

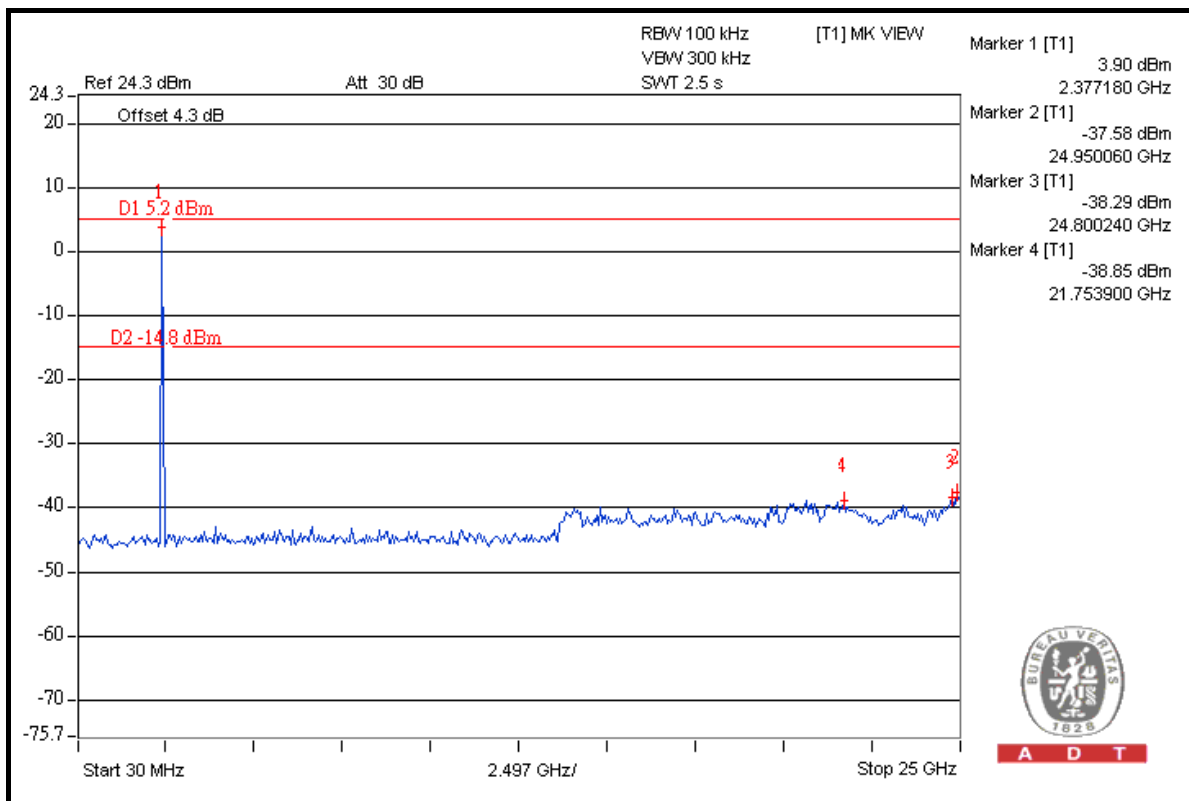

A D T



A D T

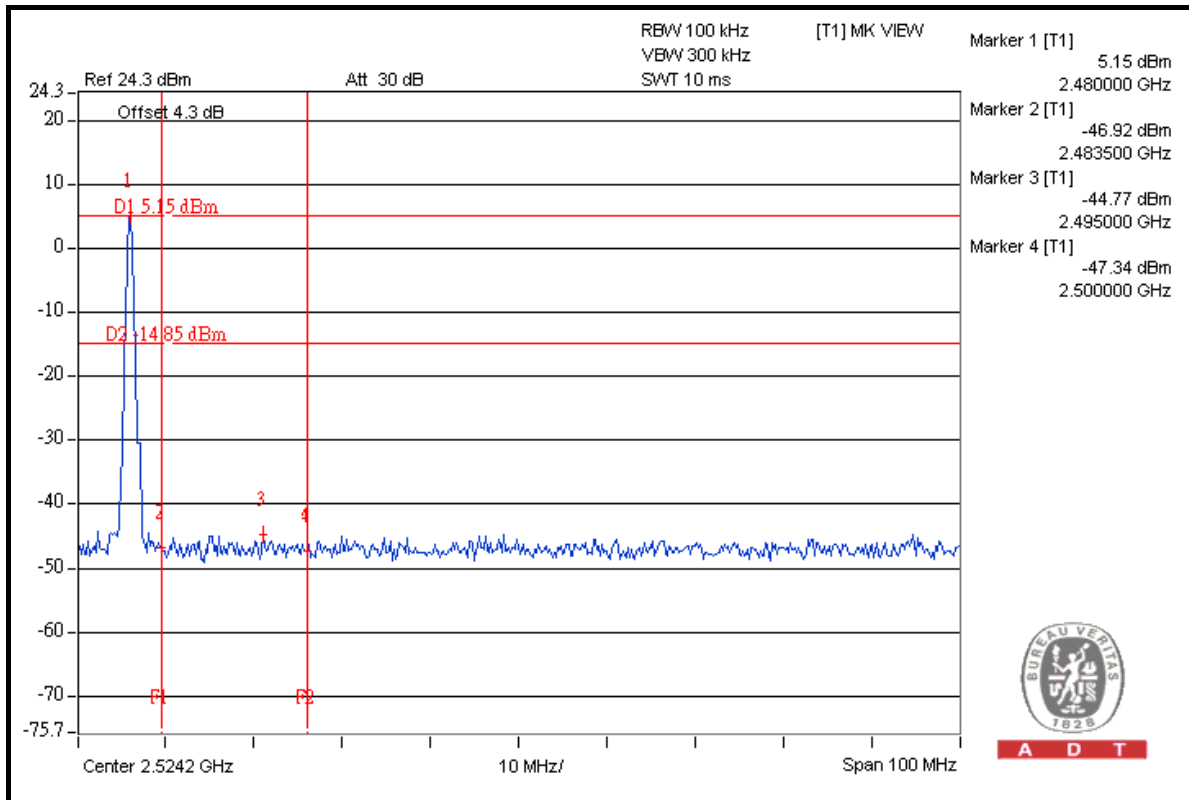

A D T

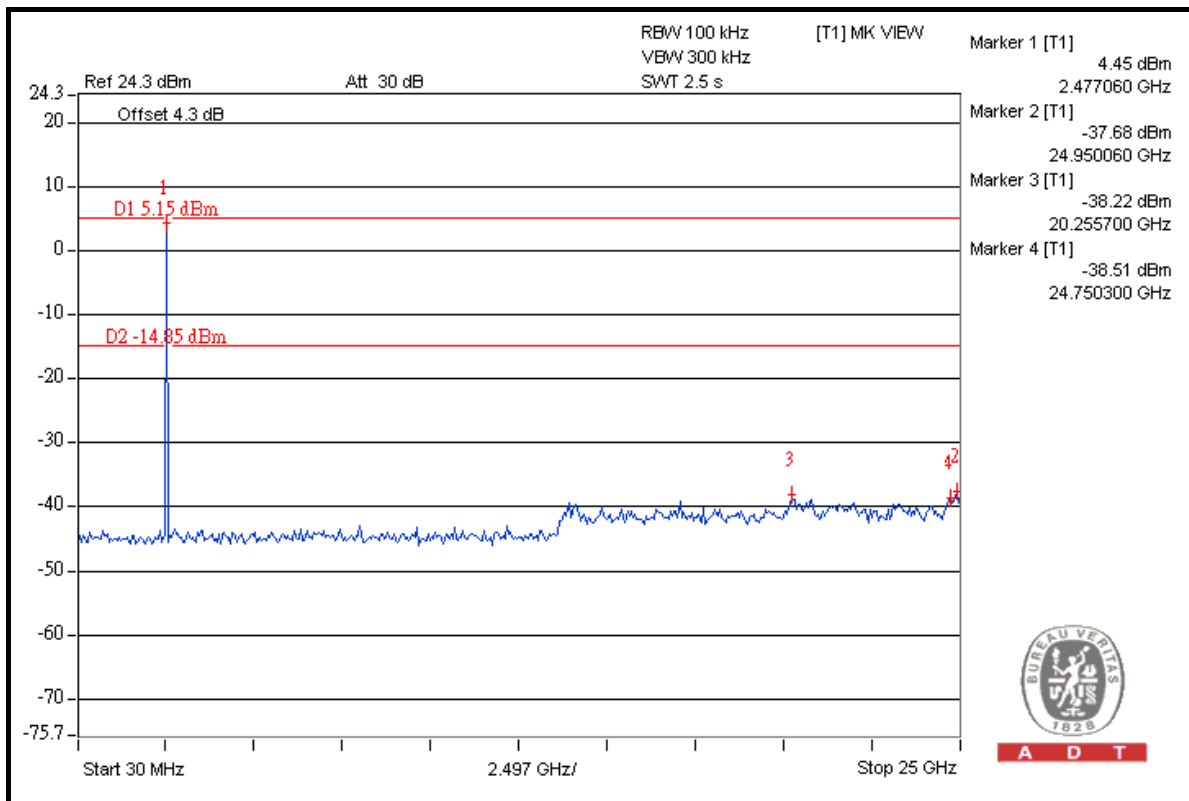

A D T



A D T

8DPSK

RESTRICT BAND (2310 ~ 2390 MHz)

| FREQUENCY (MHz) | FUNDAMENTAL EMISSION (dBuV/m) | DELTA (dB) | MAXIMUM FIELD STRENGTH IN RESTRICT BAND (dBuV/m) | LIMIT (dBuV/m) |
|-----------------|-------------------------------|------------|--|----------------|
| 2402.00 (PK) | 96.7 | 48.91 | 47.79 | 74.00 |
| 2402.00 (AV) | - | - | 17.69 | 54.00 |

RESTRICT BAND (2483.5 ~ 2500 MHz)

| FREQUENCY (MHz) | FUNDAMENTAL EMISSION (dBuV/m) | DELTA (dB) | MAXIMUM FIELD STRENGTH IN RESTRICT BAND (dBuV/m) | LIMIT (dBuV/m) |
|-----------------|-------------------------------|------------|--|----------------|
| 2480.00 (PK) | 94.5 | 49.72 | 44.78 | 74.00 |
| 2480.00 (AV) | - | - | 14.68 | 54.00 |

NOTE:

1. Delta = Amplitude between the peak of the fundamental and the peak of the band edge emission. Please check following 2 pages.
2. Maximum field strength in restrict band (PK value) = Fundamental emission (PK value) – Delta.
3. Average value = Peak value + 20 Log (duty cycle) = Peak value – 30.1dB.
4. The DH5 packet was the worse case duty cycle for a transmit dwell time on a channel, based upon Bluetooth theory the transmitter is on 0.625 * 5 per 296.25 ms per channel. Therefore, the duty cycle correction factor be equal to: $20\log(3.125/100) = -30.1$ dB.



A D T

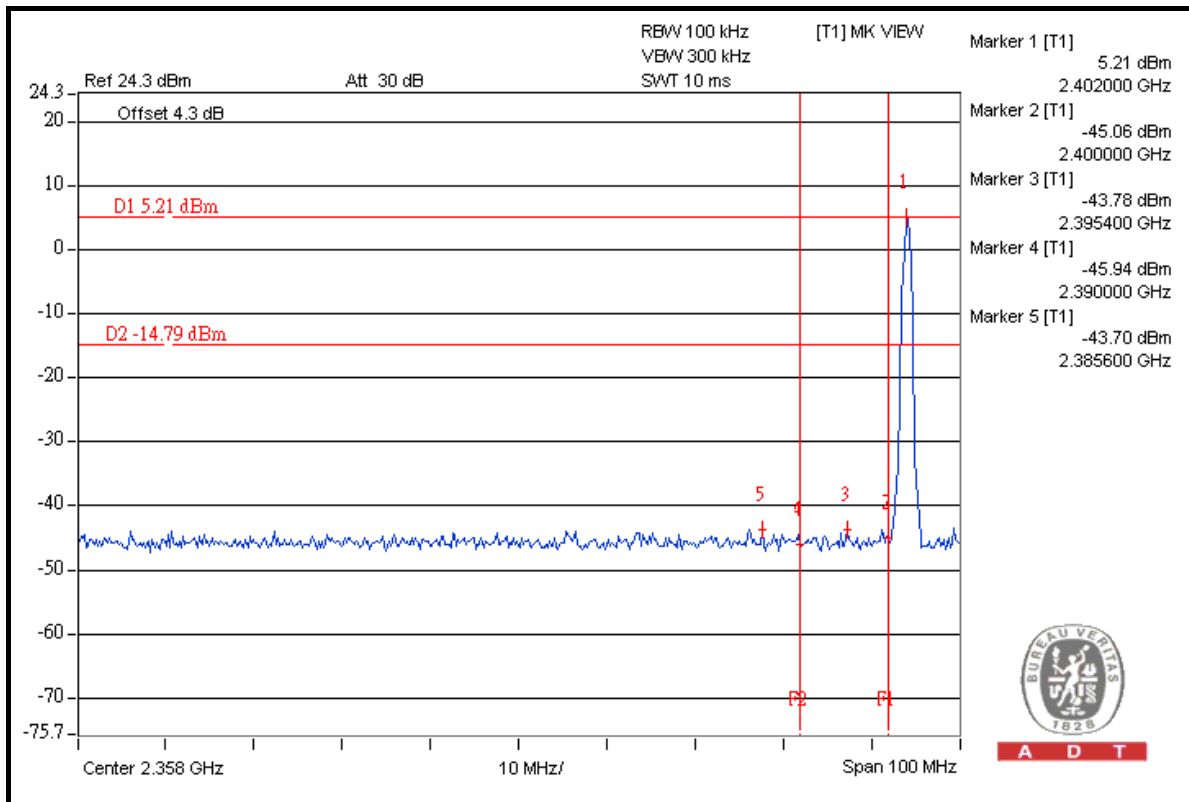

A D T

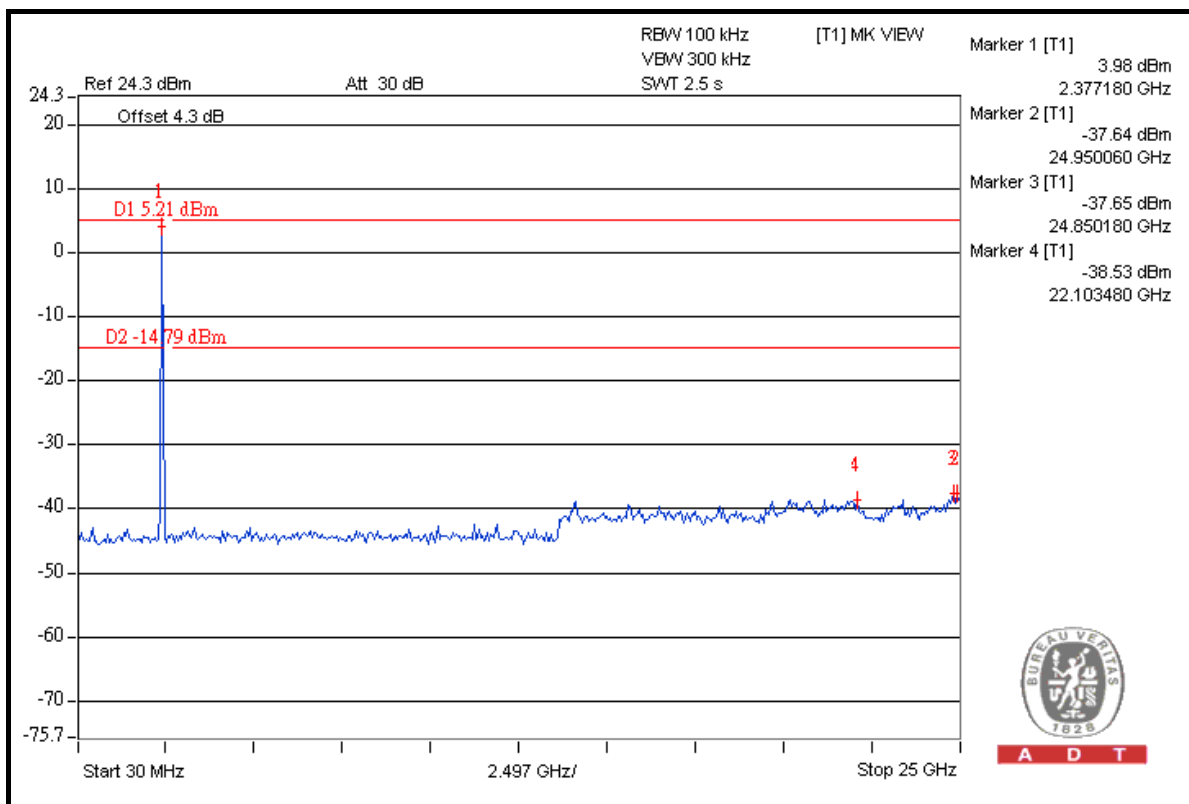

A D T



A D T

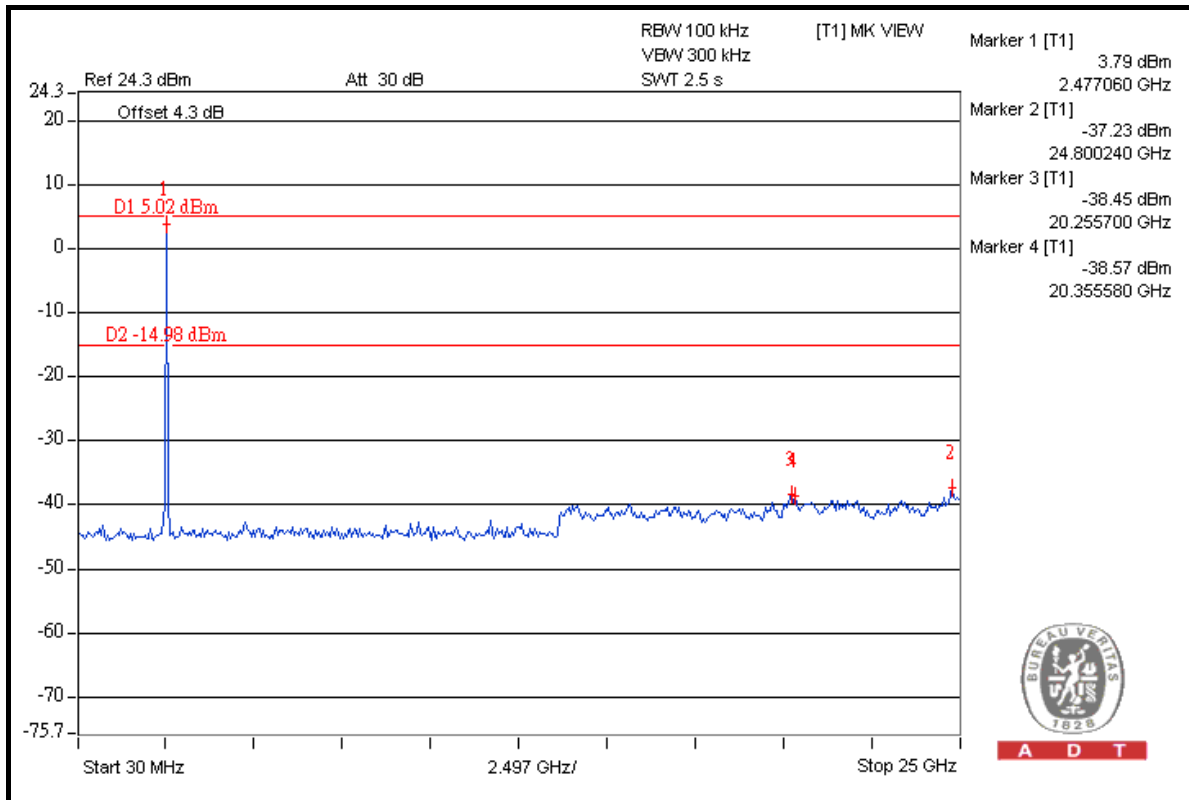
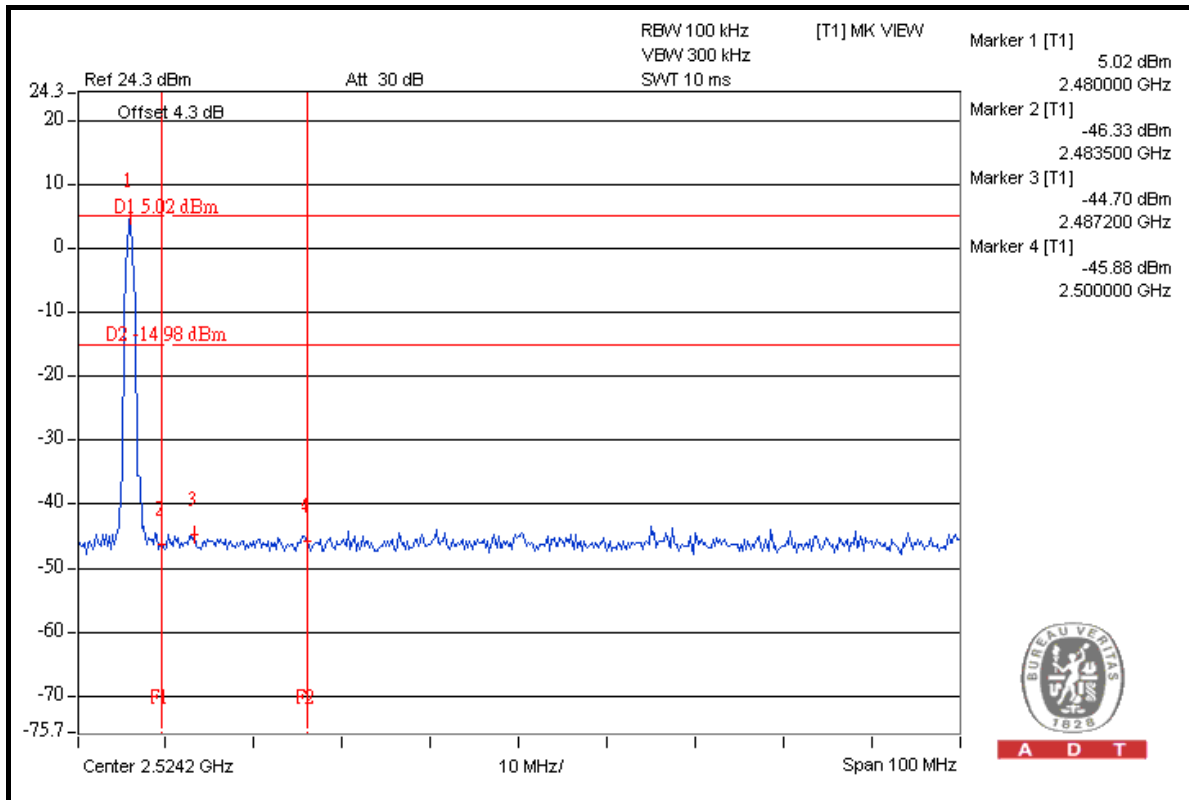

5. PHOTOGRAPHS OF THE TEST CONFIGURATION

Please refer to the attached file (Test Setup Photo).



6. INFORMATION ON THE TESTING LABORATORIES

We, Bureau Veritas Consumer Products Services (H.K.) Ltd., Taoyuan Branch, were founded in 1988 to provide our best service in EMC, Radio, Telecom and Safety consultation. Our laboratories are accredited and approved according to ISO/IEC 17025.

Copies of accreditation certificates of our laboratories obtained from approval agencies can be downloaded from our web site:

www.adt.com.tw/index.5/phtml. If you have any comments, please feel free to contact us at the following:

Linko EMC/RF Lab:

Tel: 886-2-26052180

Fax: 886-2-26051924

Hsin Chu EMC/RF Lab:

Tel: 886-3-5935343

Fax: 886-3-5935342

Hwa Ya EMC/RF/Safety Telecom Lab:

Tel: 886-3-3183232

Fax: 886-3-3185050

Web Site: www.adt.com.tw

The address and road map of all our labs can be found in our web site also.

7. APPENDIX A - MODIFICATIONS RECORDERS FOR ENGINEERING CHANGES TO THE EUT BY THE LAB

No any modifications are made to the EUT by the lab during the test.

--- END ---