



FCC TEST REPORT

(Part 24)

REPORT NO.: RF990429C05C-1

MODEL NO.: EX128, EX122

FCC ID: IHDP56LJ2

RECEIVED: Aug. 17, 2010

TESTED: Aug. 18 ~ Aug. 23, 2010

ISSUED: Aug. 25, 2010

APPLICANT: Motorola Inc

ADDRESS: Mobile Devices 600 N. U.S. Highway 45,
Libertyville, Illinois, United States, 60048-5343

ISSUED BY: Bureau Veritas Consumer Products Services
(H.K.) Ltd., Taoyuan Branch

LAB ADDRESS: No. 47, 14th Ling, Chia Pau Tsuen, Lin Kou
Hsiang, Taipei Hsien 244, Taiwan, R.O.C.

TEST LOCATION: No. 19, Hwa Ya 2nd Rd, Wen Hwa Tsuen, Kwei
Shan Hsiang, Taoyuan Hsien 333, Taiwan, R.O.C.

This test report consists of 42 pages in total. It may be duplicated completely for legal use with the approval of the applicant. It should not be reproduced except in full, without the written approval of our laboratory. The client should not use it to claim product certification, approval, or endorsement by TAF or any government agency. The test results in the report only apply to the tested sample.



TABLE OF CONTENTS

1	CERTIFICATION	4
2	SUMMARY OF TEST RESULTS	5
2.1	MEASUREMENT UNCERTAINTY	5
3	GENERAL INFORMATION.....	6
3.1	GENERAL DESCRIPTION OF EUT	6
3.2	DESCRIPTION OF TEST MODES.....	8
3.2.1	CONFIGURATION OF SYSTEM UNDER TEST	8
3.2.2	TEST MODE APPLICABILITY AND TESTED CHANNEL DETAIL	9
3.3	GENERAL DESCRIPTION OF APPLIED STANDARDS	10
3.4	DESCRIPTION OF SUPPORT UNITS	11
4	TEST TYPES AND RESULTS	12
4.1	OUTPUT POWER MEASUREMENT	12
4.1.1	LIMITS OF OUTPUT POWER MEASUREMENT	12
4.1.2	TEST INSTRUMENTS.....	13
4.1.3	TEST PROCEDURES	14
4.1.4	TEST SETUP.....	15
4.1.5	EUT OPERATING CONDITIONS	15
4.1.6	TEST RESULTS	16
4.2	BAND EDGE MEASUREMENT.....	18
4.2.1	LIMITS OF BAND EDGE MEASUREMENT	18
4.2.2	TEST INSTRUMENTS.....	18
4.2.3	TEST SETUP.....	18
4.2.4	TEST PROCEDURES	19
4.2.5	EUT OPERATING CONDITION	19
4.2.6	TEST RESULTS	20
4.3	CONDUCTED SPURIOUS EMISSIONS	23
4.3.1	LIMITS OF CONDUCTED SPURIOUS EMISSIONS MEASUREMENT	23
4.3.2	TEST INSTRUMENTS.....	23
4.3.3	TEST PROCEDURE.....	24
4.3.4	TEST SETUP.....	24
4.3.5	EUT OPERATING CONDITIONS	24
4.3.6	TEST RESULTS	25
4.4	RADIATED EMISSION MEASUREMENT (BELOW 1GHz).....	30
4.4.1	LIMITS OF RADIATED EMISSION MEASUREMENT	30
4.4.2	TEST INSTRUMENTS.....	30
4.4.3	TEST PROCEDURES	31
4.4.4	DEVIATION FROM TEST STANDARD	31
4.4.5	TEST SETUP.....	32



A D T

4.4.6	EUT OPERATING CONDITIONS	32
4.4.7	TEST RESULTS	33
4.5	RADIATED EMISSION MEASUREMENT (ABOVE 1GHz)	34
4.5.1	LIMITS OF RADIATED EMISSION MEASUREMENT	34
4.5.2	TEST INSTRUMENTS.....	34
4.5.3	TEST PROCEDURES	35
4.5.4	DEVIATION FROM TEST STANDARD	35
4.5.5	TEST SETUP.....	36
4.5.6	EUT OPERATING CONDITIONS	36
4.5.7	TEST RESULTS	37
5	PHOTOGRAPHS OF THE TEST CONFIGURATION.....	40
6	INFORMATION ON THE TESTING LABORATORIES	41
7	APPENDIX A – MODIFICATIONS RECORDERS FOR ENGINEERING CHANGES TO THE EUT BY THE LAB	42



1 CERTIFICATION

PRODUCT: GSM / EGPRS Mobile Phone
MODEL NO.: EX128 (refer to item 3.1 for more detail)
BRAND: MOTOROLA
APPLICANT: Motorola Inc
TESTED: Aug. 18 ~ Aug. 23, 2010
TEST SAMPLE: ENGINEERING SAMPLE
TEST STANDARDS: **FCC Part 24, Subpart E**
ANSI C63.4-2003

This report is issued as a supplementary report of **RF990429C05-2**. This report shall be used combined together with its original report.

PREPARED BY : Pettie Chen , **DATE:** Aug. 25, 2010
Pettie Chen / Specialist

TECHNICAL ACCEPTANCE : Long Chen , **DATE:** Aug. 25, 2010
Responsible for RF Long Chen / Senior Engineer

APPROVED BY : Gary Chang , **DATE:** Aug. 25, 2010
Gary Chang / Assistant Manager

Note: Only the Peak Output Power test, conducted Spurious Emissions test, Band Edge Measurements & Radiated Spurious Emissions test were performed for this addendum. Other testing data refer to original report.

2 SUMMARY OF TEST RESULTS

The EUT has been tested according to the following specifications:

APPLIED STANDARD: FCC Part 24 & Part 2 / IC RSS-133			
STANDARD SECTION	TEST TYPE AND LIMIT	RESULT	REMARK
2.1046 24.232	Maximum Peak Output Power Limit: max. 2 watts e.i.r.p peak power	PASS	Meet the requirement of limit. Minimum passing margin is 31.5dBm at 1909.8MHz.
2.1055 24.235	Frequency Stability AFC Freq. Error vs. Voltage AFC Freq. Error vs. Temperature Limit: max. ± 2.5 ppm	NA	Refer to Note as below
2.1049 24.238(b)	Occupied Bandwidth	NA	Refer to Note as below
24.238(b)	Band Edge Measurements	PASS	Meet the requirement of limit.
2.1051 24.238	Conducted Spurious Emissions	PASS	Meet the requirement of limit.
2.1053 24.238	Radiated Spurious Emissions	PASS	Meet the requirement of limit. Minimum passing margin is -28.1 dB at 5729.4MHz.

Note: Only the Peak Output Power test, conducted Spurious Emissions test, Band Edge Measurements & Radiated Spurious Emissions test were performed for this addendum. Other testing data refer to original report.

2.1 MEASUREMENT UNCERTAINTY

Where relevant, the following measurement uncertainty levels have been estimated for tests performed on the EUT as specified in CISPR 16-4-2:

MEASUREMENT	FREQUENCY	UNCERTAINTY
Conducted emissions	150kHz~30MHz	2.44 dB
Radiated emissions	30MHz ~ 200MHz	3.34 dB
	200MHz ~1000MHz	3.35 dB
	1GHz ~ 18GHz	2.26 dB
	18GHz ~ 40GHz	1.94 dB

This uncertainty represents an expanded uncertainty expressed at approximately the 95% confidence level using a coverage factor of $k=2$.

3 GENERAL INFORMATION

3.1 GENERAL DESCRIPTION OF EUT

EUT	GSM / EGPRS Mobile Phone
MODEL NO.	EX128 (Refer to Note for the more details)
FCC ID	IHDP56LJ2
POWER SUPPLY	3.7Vdc (battery) 5.0Vdc (adapter)
MODULATION TYPE	GMSK, 8PSK
OPERATING FREQUENCY	1850MHz ~ 1910MHz
NUMBER OF CHANNEL	299
MAX. EIRP POWER	GSM Mode: 31.5dBm (1.4125Watts) GPRS Mode: 31.2dBm (1.3183Watts) EGPRS Mode: 30.0dBm (1.0000Watts)
ANTENNA TYPE	Embedded inverted-F
MAX. ANTENNA GAIN	0.1dBi
ANTENNA CONNECTOR	NA
DATA CABLE	NA
I/O PORTS	Refer to user's manual
ACCESSORY DEVICES	Adapter, Battery, Earphone (1. Model: SYN2356A, 1.3m shielded cable without core; 2. Model: SJYN0394A, 1.4m shielded cable without core)

NOTE:

1. This report is issued as a supplementary report to the original BVADT report no.: RF990429C05-1.
2. This report is prepared for FCC class II permissive change. The differences compared with original report are changing HW version, SW version and modifying antenna. Therefore, only the Peak Output Power test, conducted Spurious Emissions test, Band Edge Measurements & Radiated Spurious Emissions test were performed for this addendum. Other testing data refer to original report.

* HW change list as below.

- a. For Motorola security function
- b. For ESD solution with +/- 15KV
- c. For SMT solder issue
- d. For touch panel sequence correction
- e. For TDMA noise
- f. For changing receiver
- g. For Motorola pre-charge mode
- h. For Transceiver TX/RX matching
- i. For Antenna matching change

3. The EUT is a GSM / EGPRS Mobile Phone which has dual SIM card design (Model: EX128) and single SIM card design (Model: EX122). Both models were assessed and model EX128 was found to be worst case and was selected for the final test configuration.

Brand	Model Name	Remark
Motorola	EX128	dual SIM
Motorola	EX122	single SIM

4. The communicated functions of EUT listed as below:

		850MHz	1900MHz	With Bluetooth 2.1+EDR function
2G	GSM	√	√	
	GPRS	√	√	
	EGPRS	√	√	

5. The EUT were tested with the following lithium battery and adapter:

LITHIUM BATTERY	
BRAND :	MOTOROLA
MODEL :	BQ50
RATING :	3.7Vdc, 910mAh, 3.4Wh

ADAPTER	
BRAND :	MOTOROLA
MODEL :	DCH3-050US-0303
INPUT :	100-240Vac, 50/60Hz, 0.2A
OUTPUT :	5Vdc, 550mA

6. The EUT is a GSM / EGPRS Mobile Phone. The functions of EUT listed as below:

	TEST STANDARD	REFERENCE REPORT
GSM 850	FCC Part 22	RF990429C05C
PCS 1900	FCC Part 24	RF990429C05C-1

7. IMEI Code: **Dual SIM:** IMEI (1): 35156604005279-2, IMEI (2): 35156604005628-0

Single SIM: IMEI (1): 35363304000793-3

8. Software vision: Kingfisher_G_07.1B.00R_S.

9. Hardware vision: PCR.

10. The above EUT information was declared by manufacturer and for more detailed features description, please refer to the manufacturer's specifications or User's Manual.

3.2 DESCRIPTION OF TEST MODES

299 channels are provided to this EUT. Therefore, the low, middle and high channels are chosen for testing.

	CHANNEL	FREQUENCY	TX MODE
LOW	512	1850.2 MHz	GSM, GPRS, EGPRS
MIDDLE	661	1880.0 MHz	GSM, GPRS, EGPRS
HIGH	810	1909.8 MHz	GSM, GPRS, EGPRS

NOTE:

1. Below 1 GHz, the channel 512, 661, and 810 were pre-tested in chamber. The channel 512 was chosen for final test.
2. Above 1 GHz, the channel 512, 661, and 810 were tested individually.
3. The worst case for final test is chosen when the power control level set 0.
4. The channel space is 0.2MHz.
5. The EUT is a GPRS class 10 device (Multislot class: 10, Mobile Terminal B), which provide 2 up-link. After pre-tested both functions, found up-link with 1 time slot is worse, therefore, test results of output power, frequency stability, occupied bandwidth and band edge tests came out from this.
6. The EUT has GSM, GPRS & EGPRS functions. After pre-testing, GSM function is the worst case for all the emission tests.

3.2.1 CONFIGURATION OF SYSTEM UNDER TEST

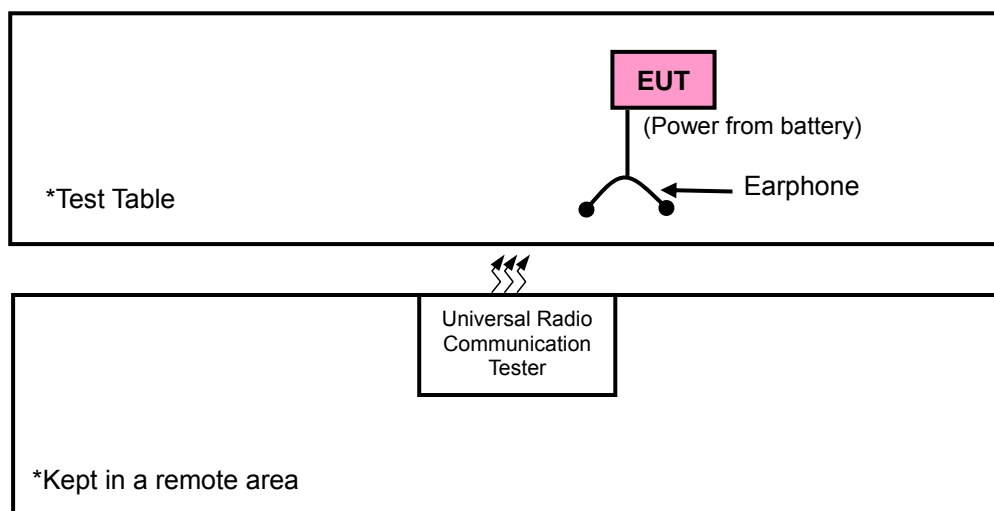

3.2.2 TEST MODE APPLICABILITY AND TESTED CHANNEL DETAIL

EUT CONFIGURE MODE	APPLICABLE TO					DESCRIPTION
	OP	BE	CE	RE<1G	RE≥1G	
-	√	√	√	√	√	-

Where **OP**: Output power
BE: Band edge
CE: Conducted spurious emissions
RE<1G: Radiated emission below 1GHz
RE≥1G: Radiated emission above 1GHz

OUTPUT POWER MEASUREMENT:

- Pre-Scan has been conducted to determine the worst-case mode from all possible combinations between available modulations, XYZ axis and antenna ports (if EUT with antenna diversity architecture).
- Following channel(s) was (were) selected for the final test as listed below.

AVAILABLE CHANNEL	TESTED CHANNEL	MODULATION TECHNOLOGY	AXIS
512 to 810	512, 661, 810	GSM, GPRS, EGPRS	Y

BAND EDGE MEASUREMENT:

- Pre-Scan has been conducted to determine the worst-case mode from all possible combinations between available modulations and antenna ports (if EUT with antenna diversity architecture).
- Following channel(s) was (were) selected for the final test as listed below.

AVAILABLE CHANNEL	TESTED CHANNEL	MODULATION TECHNOLOGY
512 to 810	512, 810	GSM, GPRS, EGPRS

CONDUCTED SPURIOUS EMISSIONS MEASUREMENT:

- Pre-Scan has been conducted to determine the worst-case mode from all possible combinations between available modulations and antenna ports (if EUT with antenna diversity architecture).
- Following channel(s) was (were) selected for the final test as listed below.

AVAILABLE CHANNEL	TESTED CHANNEL	MODULATION TECHNOLOGY
512 to 810	512, 661, 810	GSM

RADIATED EMISSION MEASUREMENT (BELOW 1 GHz):

- Pre-Scan has been conducted to determine the worst-case mode from all possible combinations between available modulations, XYZ axis and antenna ports (if EUT with antenna diversity architecture).
- Following channel(s) was (were) selected for the final test as listed below.

AVAILABLE CHANNEL	TESTED CHANNEL	MODULATION TECHNOLOGY	AXIS
512 to 810	810	GSM	Y

RADIATED EMISSION MEASUREMENT (ABOVE 1 GHz):

- Pre-Scan has been conducted to determine the worst-case mode from all possible combinations between available modulations, XYZ axis and antenna ports (if EUT with antenna diversity architecture).
- Following channel(s) was (were) selected for the final test as listed below.

AVAILABLE CHANNEL	TESTED CHANNEL	MODULATION TECHNOLOGY	AXIS
512 to 810	512, 661, 810	GSM	Y

TEST CONDITION:

APPLICABLE TO	ENVIRONMENTAL CONDITIONS	INPUT POWER	TESTED BY
OP	25deg. C, 64%RH, 1008 hPa	3.7Vdc	Long Chen
BE	25deg. C, 64%RH, 1008 hPa	3.7Vdc	Long Chen
CE	25deg. C, 64%RH, 1008 hPa	3.7Vdc	Long Chen
RE < 1G	25deg. C, 65%RH, 1001 hPa	3.7Vdc	Long Chen
RE ≥ 1G	25deg. C, 65%RH, 1001 hPa	3.7Vdc	Long Chen

3.3 GENERAL DESCRIPTION OF APPLIED STANDARDS

The EUT is a RF product. According to the specifications of the manufacturer, it must comply with the requirements of the following standards:

FCC 47 CFR Part 2

FCC 47 CFR Part 24

IC RSS-133

ANSI C63.4-2003

ANSI/TIA/EIA-603-C 2004

NOTE: All test items have been performed and recorded as per the above standards.

3.4 DESCRIPTION OF SUPPORT UNITS

The EUT has been tested as an independent unit together with other necessary accessories or support units. The following support units or accessories were used to form a representative test configuration during the tests.

NO.	PRODUCT	BRAND	MODEL NO.	SERIAL NO.	FCC ID
1	UNIVERSAL RADIO COMMUNICATION TESTER	R&S	CMU200	104484	NA

NO.	SIGNAL CABLE DESCRIPTION OF THE ABOVE SUPPORT UNITS
1	NA

NOTE 1: All power cords of the above support units are non shielded (1.8m).

NOTE 2: Item 1 acted as a communication partner to transfer data.

4 TEST TYPES AND RESULTS

4.1 OUTPUT POWER MEASUREMENT

4.1.1 LIMITS OF OUTPUT POWER MEASUREMENT

The radiated peak output power shall be according to the specific rule Part 24.232(b) that “Mobile / Portable station are limited to 2 watts e.i.r.p” and 24.232(c) specific that “Peak transmit power must be measure over any interval of continuous transmission using instrumentation calibration in terms of rms-equivalent voltage.”

4.1.2 TEST INSTRUMENTS

DESCRIPTION & MANUFACTURER	MODEL NO.	SERIAL NO.	DATE OF CALIBRATION	DUE DATE OF CALIBRATION
Test Receiver ROHDE & SCHWARZ	ESIB7	100188	Dec. 21, 2009	Dec. 20, 2010
Spectrum Analyzer ROHDE & SCHWARZ	FSP40	100269	Dec. 31, 2009	Dec. 30, 2010
BILOG Antenna SCHWARZBECK	VULB9168	9168-160	Apr. 27, 2010	Apr. 26, 2011
HORN Antenna SCHWARZBECK	9120D	9120D-405	Feb. 03, 2010	Feb. 02, 2011
HORN Antenna SCHWARZBECK	BBHA 9170	BBHA9170243	Dec. 25, 2009	Dec. 24, 2010
Preamplifier Agilent	8447D	2944A10633	Nov. 10, 2009	Nov. 09, 2010
Preamplifier Agilent	8449B	3008A01964	Nov. 09, 2009	Nov. 08, 2010
RF signal cable HUBER+SUHNNER	SUCOFLEX 104	238141/4	May 14, 2010	May 13, 2011
RF signal cable HUBER+SUHNNER	SUCOFLEX 104	12738/6	May 14, 2010	May 13, 2011
Software ADT.	ADT_Radiated_ V7.6.15.9.2	NA	NA	NA
Antenna Tower inn-co GmbH	MA 4000	013303	NA	NA
Antenna Tower Controller inn-co GmbH	CO2000	017303	NA	NA
Turn Table ADT.	TT100.	TT93021703	NA	NA
Turn Table Controller ADT.	SC100.	SC93021703	NA	NA

- NOTE:**
1. The calibration interval of the above test instruments is 12 months and the calibrations are traceable to NML/ROC and NIST/USA.
 2. The test was performed in HwaYa Chamber 3.
 3. The horn antenna and HP preamplifier (model: 8449B) are used only for the measurement of emission frequency above 1GHz if tested.
 4. The FCC Site Registration No. is 988962.
 5. The IC Site Registration No. is IC 7450F-3.

4.1.3 TEST PROCEDURES

- a. The power was measured with R&S Spectrum Analyzer. All measurements were done at 3 channels, 512, 661 and 810 (low, middle and high operational frequency range.)
- b. The conducted peak output power used the power splitter via EUT RF power connector between simulation base station and spectrum analyzer. The path loss included the splitter loss, cable loss and 20dB pad loss. The spectrum set RB/VB 1MHz, then read peak power value and record to the test. (All transmitted path loss shall be considered in the test report data.)
- c. Substitution method is used for E.I.R.P measurement. In the semi-anechoic chamber, EUT placed on the 0.8m height of Turn Table, rotated the table around 360 degrees to search the maximum radiation power and receiver antenna shall be rotated vertical and horizontal polarization and moved height from 1m to 4m to find the maximum polar radiated power. The “Read Value” is the spectrum reading the maximum power value.
- d. The substitution horn antenna is substituted for EUT at the same position and signals generator export the CW signal to the substitution antenna via a tx cable . Rotated the Turn Table and moved receiving antenna to find the maximum radiation power. Adjust output power level of S.G to get a Value of spectrum reading equal to “Read Value“ of step c. Record the power level of S.G
- e. $EIRP = \text{Output power level of S.G} - \text{TX cable loss} + \text{Antenna gain of substitution horn.}$

4.1.4 TEST SETUP

EIRP POWER MEASUREMENT:

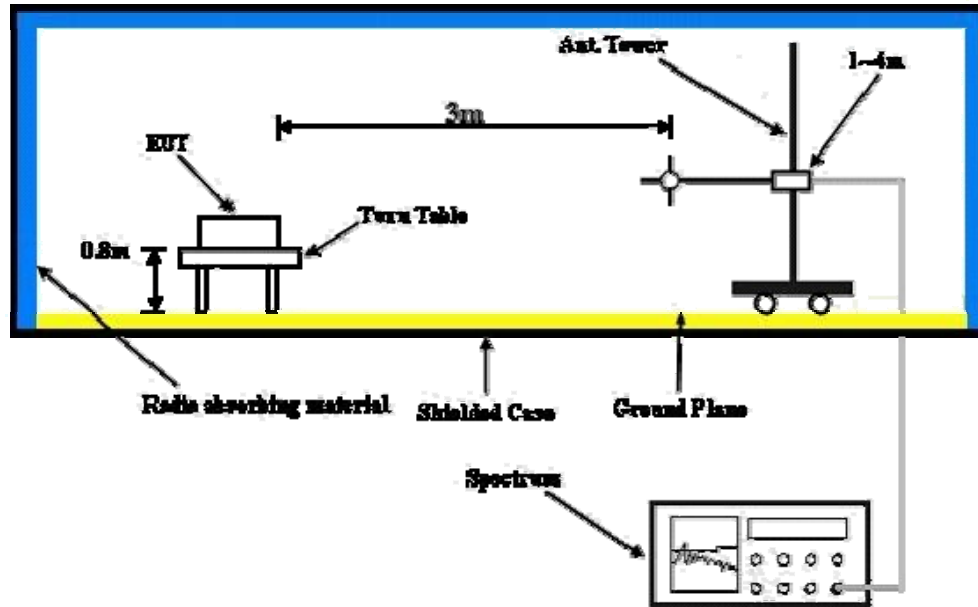

For the actual test configuration, please refer to the attached file (Test Setup Photo).

CONDUCTED POWER MEASUREMENT:

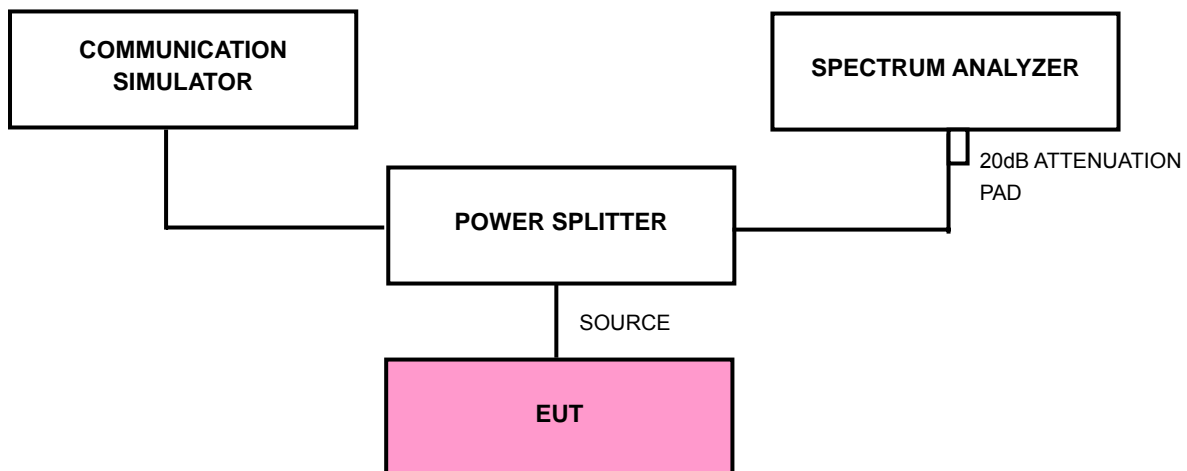

For the actual test configuration, please refer to the related item – Photographs of the Test Configuration.

4.1.5 EUT OPERATING CONDITIONS

- a. The EUT makes a phone call to the communication simulator.
- b. The communication simulator station system controlled an EUT to export maximum output power under transmission mode and specific channel frequency.

4.1.6 TEST RESULTS

FOR GSM MODE

CONDUCTED OUTPUT POWER					
CHANNEL NO.	FREQUENCY (MHz)	RAW VALUE (dBm)	CORRECTION FACTOR (dB)	OUTPUT POWER	
				dBm	Watt
512	1850.2	5.5	24.5	30.0	1.0000
661	1880.0	5.5	24.5	30.0	1.0000
810	1909.8	5.6	24.5	30.1	1.0233

FOR GPRS MODE (UP-LINK WITH 1 TIME SLOT)

CONDUCTED OUTPUT POWER					
CHANNEL NO.	FREQUENCY (MHz)	RAW VALUE (dBm)	CORRECTION FACTOR (dB)	OUTPUT POWER	
				dBm	Watt
512	1850.2	5.5	24.5	30.0	1.0000
661	1880.0	5.5	24.5	30.0	1.0000
810	1909.8	5.6	24.5	30.1	1.0233

FOR EGPRS MODE (UP-LINK WITH 1 TIME SLOT)

CONDUCTED OUTPUT POWER					
CHANNEL NO.	FREQUENCY (MHz)	RAW VALUE (dBm)	CORRECTION FACTOR (dB)	OUTPUT POWER	
				dBm	Watt
512	1850.2	1.9	24.5	26.4	0.4365
661	1880.0	1.8	24.5	26.3	0.4266
810	1909.8	2.0	24.5	26.5	0.4467

- REMARKS:** 1. Peak Output Power (dBm) = Raw Value (dBm) + Correction Factor (dB).
 2. Correction Factor (dB) = Power Splitter Loss (dB) + Cable Loss (dB).

FOR GSM MODE

EIRP POWER					
CHANNEL NO.	FREQUENCY (MHz)	S.G VALUE (dBm)	CORRECTION FACTOR (dB)	OUTPUT POWER	
				dBm	Watt
512	1850.2	22.4	8.4	30.8	1.2023
661	1880.0	22.5	8.6	31.1	1.2882
810	1909.8	23.0	8.5	31.5	1.4125

FOR GPRS MODE (UP-LINK WITH 1 TIME SLOT)

EIRP POWER					
CHANNEL NO.	FREQUENCY (MHz)	S.G VALUE (dBm)	CORRECTION FACTOR (dB)	OUTPUT POWER	
				dBm	Watt
512	1850.2	22.3	8.4	30.7	1.1749
661	1880.0	22.3	8.6	30.9	1.2303
810	1909.8	22.7	8.5	31.2	1.3183

FOR EGPRS MODE (UP-LINK WITH 1 TIME SLOT)

EIRP POWER					
CHANNEL NO.	FREQUENCY (MHz)	S.G VALUE (dBm)	CORRECTION FACTOR (dB)	OUTPUT POWER	
				dBm	Watt
512	1850.2	21.1	8.4	29.5	0.8913
661	1880.0	21.1	8.6	29.7	0.9333
810	1909.8	21.5	8.5	30.0	1.0000

- REMARKS:** 1. Peak Output Power (dBm) = S.G Value (dBm) + Correction Factor (dB).
 2. Correction Factor (dB) = Substitution Antenna Gain (dB) + Cable Loss (dB).

4.2 BAND EDGE MEASUREMENT

4.2.1 LIMITS OF BAND EDGE MEASUREMENT

According to FCC 24.238(a) specified that power of any emission outside of the authorized operating frequency ranges must be attenuated below the transmitting power (P) by a factor of at least $43 + 10 \log(P)$ dB. In the 1 MHz bands immediately outside and adjacent to the frequency block a resolution bandwidth of at least one percent of the emission bandwidth of the fundamental emission of the transmitter may be employed.

4.2.2 TEST INSTRUMENTS

DESCRIPTION & MANUFACTURER	MODEL NO.	SERIAL NO.	DATE OF CALIBRATION	DUE DATE OF CALIBRATION
ROHDE & SCHWARZ Spectrum Analyzer	E4446A	MY44360128	Feb. 23, 2010	Feb. 22, 2011
Mini-Circuits Power Splitter	ZN2PD-9G	NA	Jul. 14, 2010	Jul. 13, 2011
RF cable	SUCOFLEX 104	274398/4	Sep. 12, 2009	Sep. 11, 2010
RF cable	SUCOFLEX 104	274388/4	Sep. 12, 2009	Sep. 11, 2010
RF cable	SUCOFLEX 104	250795/4	Sep. 12, 2009	Sep. 11, 2010
JFW 20dB attenuation	50HF-020-SMA	NA	NA	NA

NOTE: The calibration interval of the above test instruments is 12 months. And the calibrations are traceable to NML/ROC and NIST/USA.

4.2.3 TEST SETUP

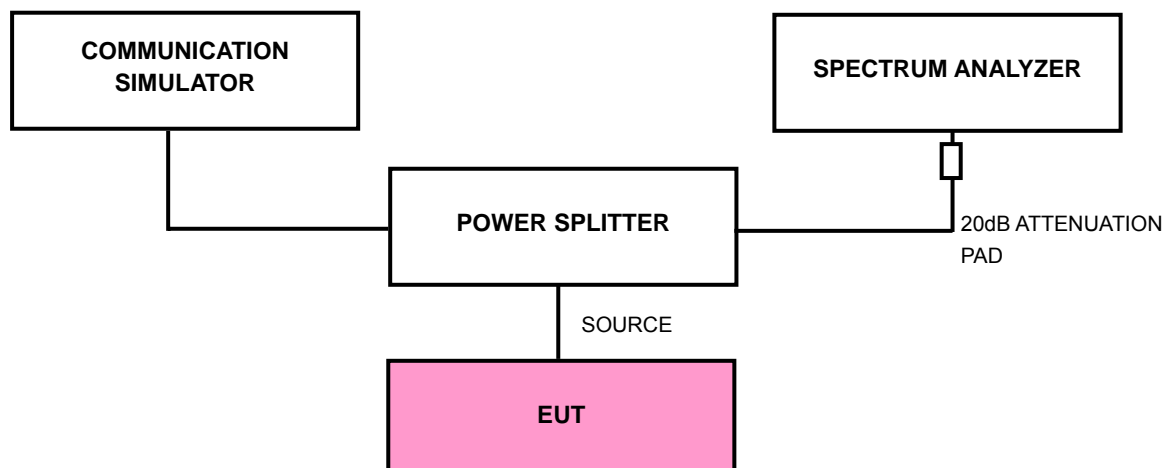

4.2.4 TEST PROCEDURES

- a. The EUT makes a phone call to the communication simulator. The power was measured with R&S Spectrum Analyzer. All measurements were done at 2 channels, 512 and 810 (low and high operational frequency range.)
- b. The band edge measurement used the power splitter via EUT RF power connector between simulation base station and spectrum analyzer. This splitter loss and cable loss are the worst loss 5dB in the transmitted path track.
- c. The center frequency of spectrum is the band edge frequency and span is 1.5 MHz. RB of the spectrum is 3kHz and VB of the spectrum is 10kHz.
- d. Record the max trace plot into the test report.

4.2.5 EUT OPERATING CONDITION

- a. The EUT makes a phone call to the communication simulator.
- b. The communication simulator station system controlled an EUT to export maximum output power under transmission mode and specific channel frequency.



A D T

4.2.6 TEST RESULTS

FOR GSM MODE

LOWER BAND EDGE

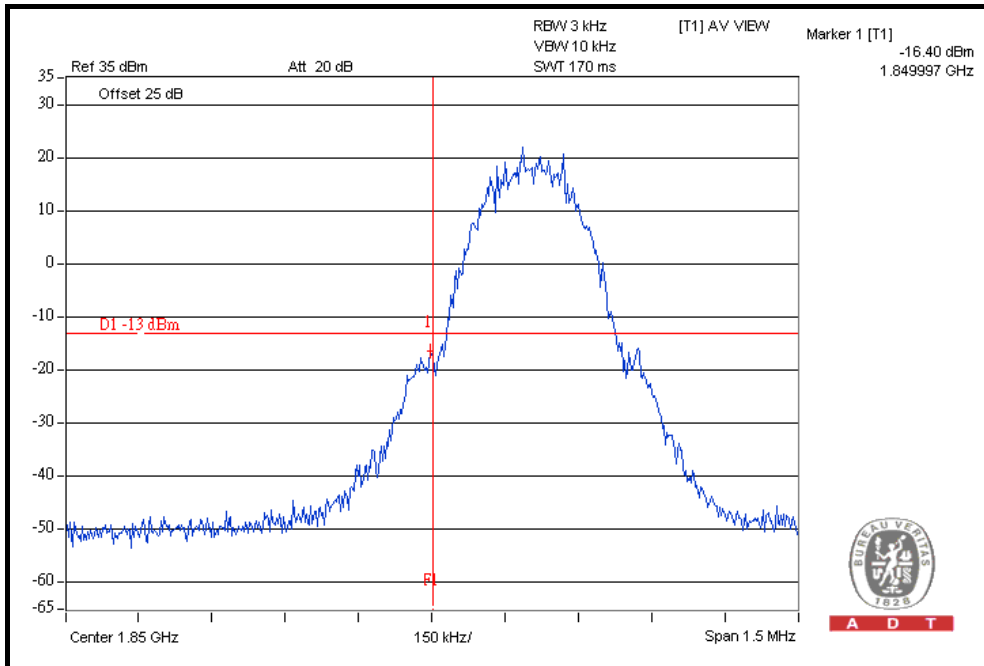

HIGHER BAND EDGE

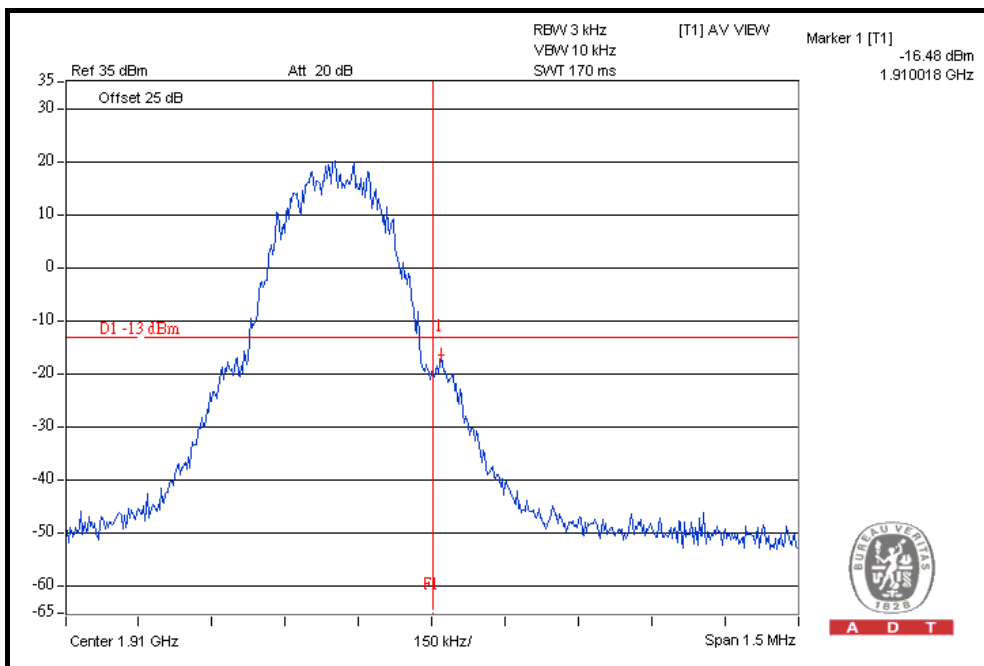



A D T

FOR GPRS MODE (UP-LINK WITH 1 TIME SLOT)

LOWER BAND EDGE

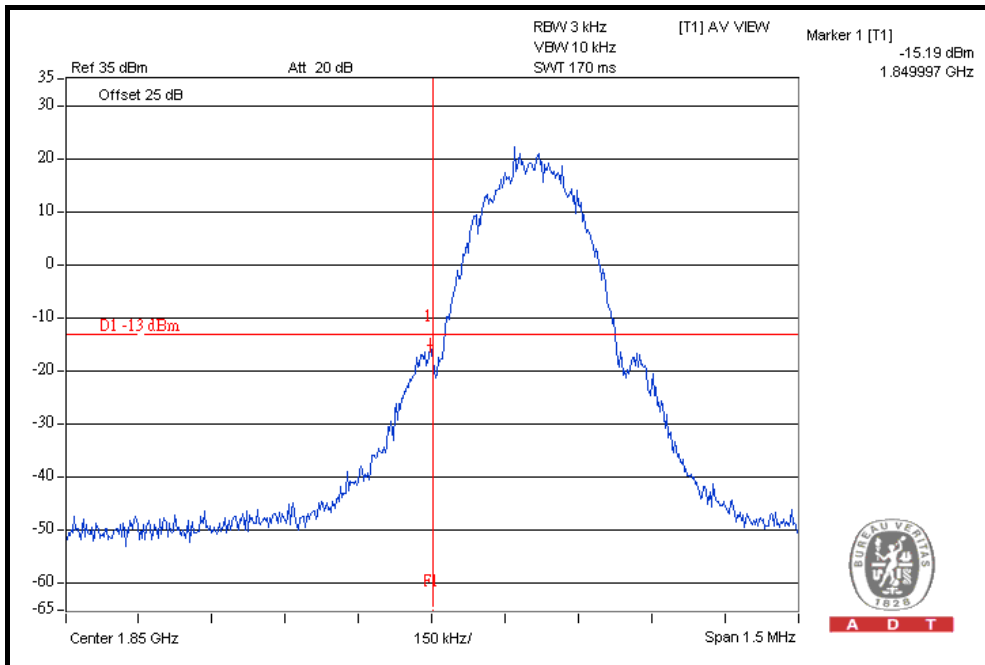

HIGHER BAND EDGE

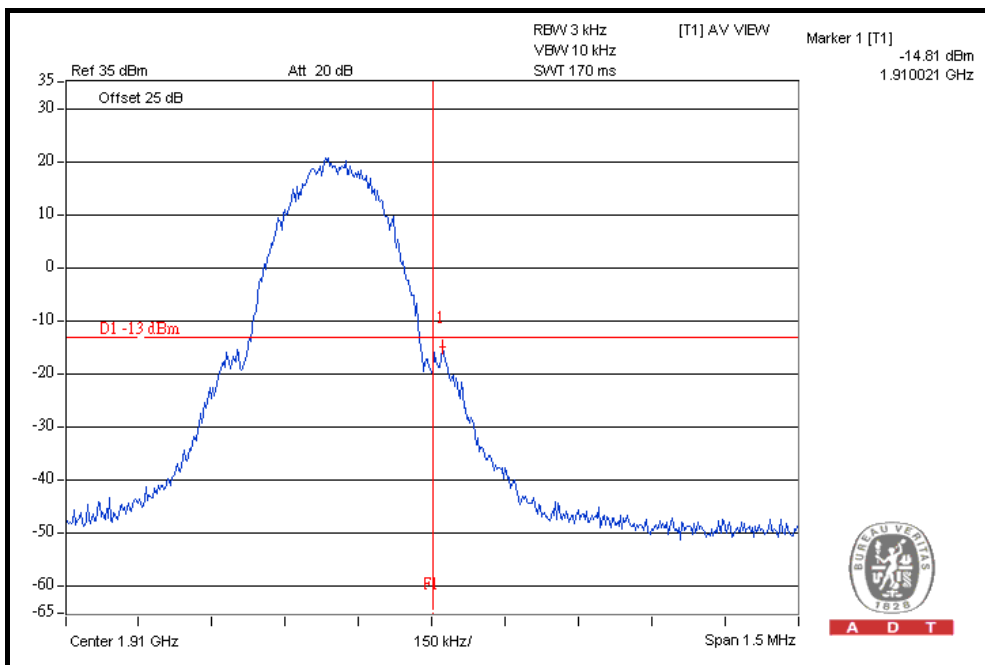



A D T

FOR EGPRS MODE (UP-LINK WITH 1 TIME SLOT)

LOWER BAND EDGE

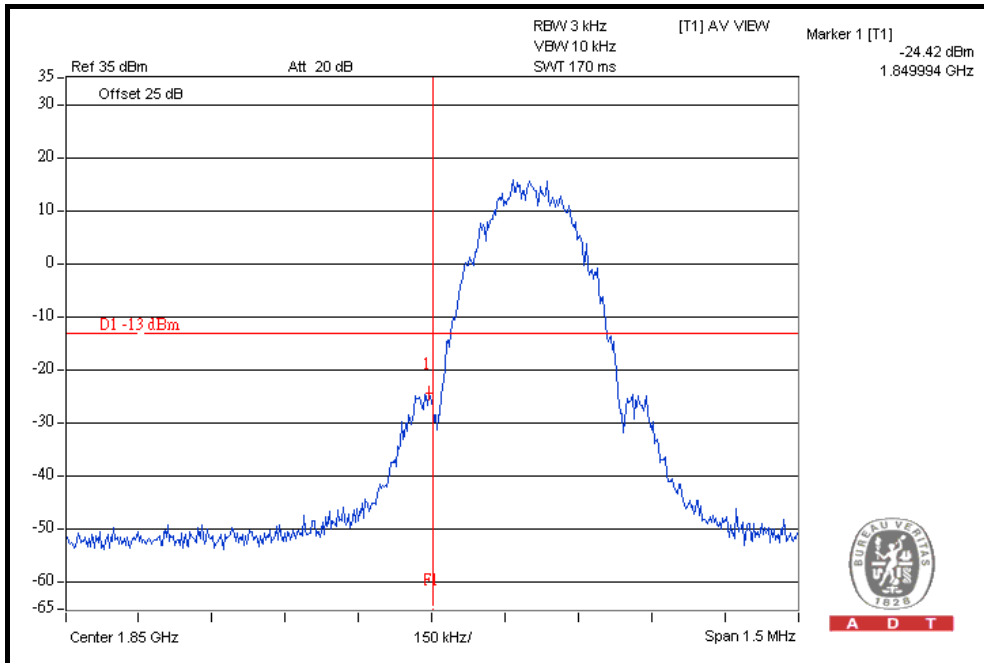

HIGHER BAND EDGE

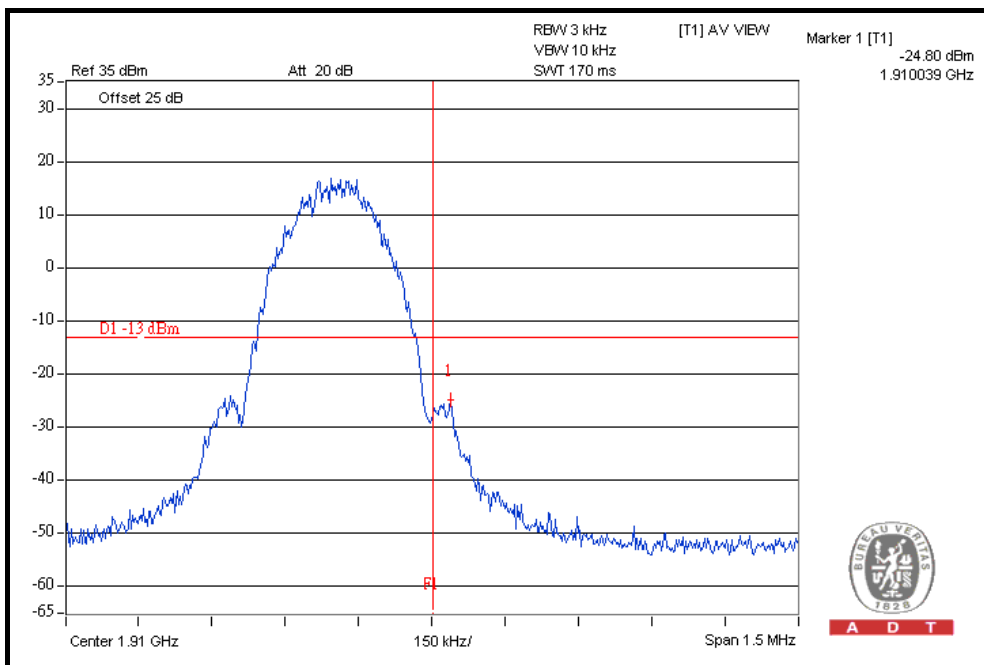

4.3 CONDUCTED SPURIOUS EMISSIONS

4.3.1 LIMITS OF CONDUCTED SPURIOUS EMISSIONS MEASUREMENT

In the FCC 24.238(a), On any frequency outside a licensee's frequency block within USPCS spectrum, the power of any emission shall be attenuated below the transmitter power (P) by at least $43 + 10 \log (P)$ dB. The specified minimum attenuation becomes 43dB and the limit of emission equal to -13dBm .

4.3.2 TEST INSTRUMENTS

DESCRIPTION & MANUFACTURER	MODEL NO.	SERIAL NO.	DATE OF CALIBRATION	DUE DATE OF CALIBRATION
ROHDE & SCHWARZ Spectrum Analyzer	FSP40	100040	Jul. 09, 2010	Jul. 08, 2011
Wainwright Instruments Band Reject Filter	WRCG 824/849-810/ 863-60/9SS	SN1	Mar. 25, 2010	Mar. 24, 2011
WI Highpass filter	WHK1.5/15G-10ST	SN1	Mar. 30, 2010	Mar. 29, 2011
Mini-Circuits Power Splitter	ZN2PD-9G	NA	Jun. 24, 2010	Jun. 23, 2011
RF cable	SUCOFLEX 104	274398/4	Sep. 12, 2009	Sep. 11, 2010
RF cable	SUCOFLEX 104	274388/4	Sep. 12, 2009	Sep. 11, 2010
RF cable	SUCOFLEX 104	250795/4	Sep. 12, 2009	Sep. 11, 2010
JFW 20dB attenuation	50HF-020-SMA	NA	NA	NA

NOTE: The calibration interval of the above test instruments is 12 months. And the calibrations are traceable to NML/ROC and NIST/USA.

4.3.3 TEST PROCEDURE

- a. The EUT makes a phone call to the communication simulator. The power was measured with R&S Spectrum Analyzer. All measurements were done at 3 channels, 512, 661 and 810 (low, middle and high operational frequency range.)
- b. The conducted spurious emission used the power splitter via EUT RF power connector between simulation base station and spectrum analyzer. This splitter loss and cable loss are the worst loss 5dB in the transmitted path track.
- c. When the spectrum scanned from 9kHz to 20GHz, it shall be connected to 20dB Pad. The spectrum set RB=1MHz, VB=3MHz.

4.3.4 TEST SETUP

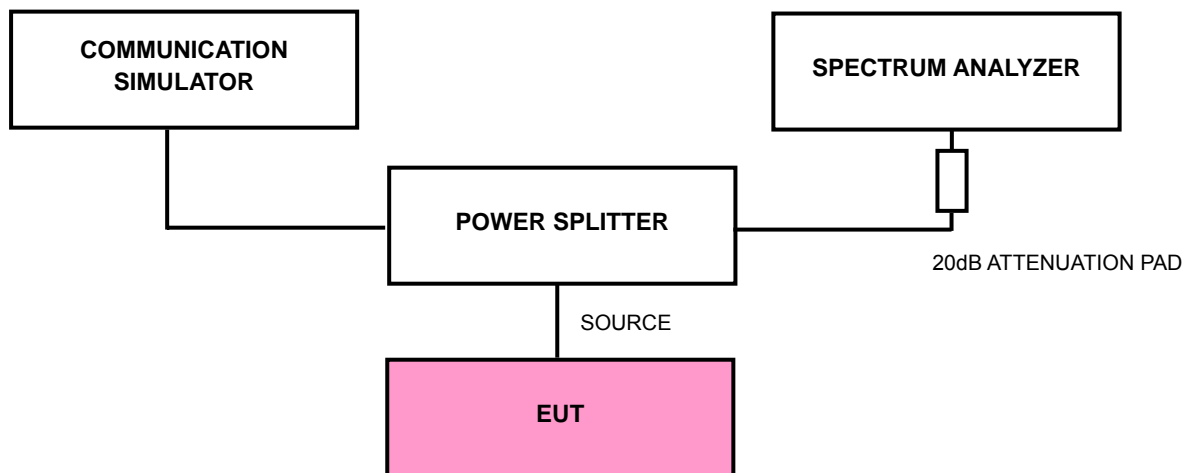

4.3.5 EUT OPERATING CONDITIONS

- a. The EUT makes a phone call to the communication simulator.
- b. The communication simulator station system controlled an EUT to export maximum output power under transmission mode and specific channel frequency.



A D T

4.3.6 TEST RESULTS

CH 512: 9kHz ~ 3GHz

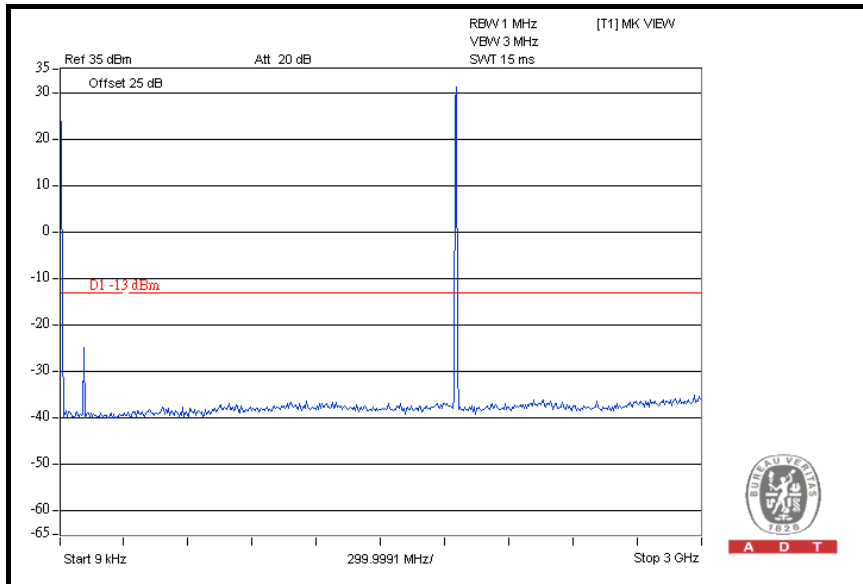

3GHz ~ 10GHz

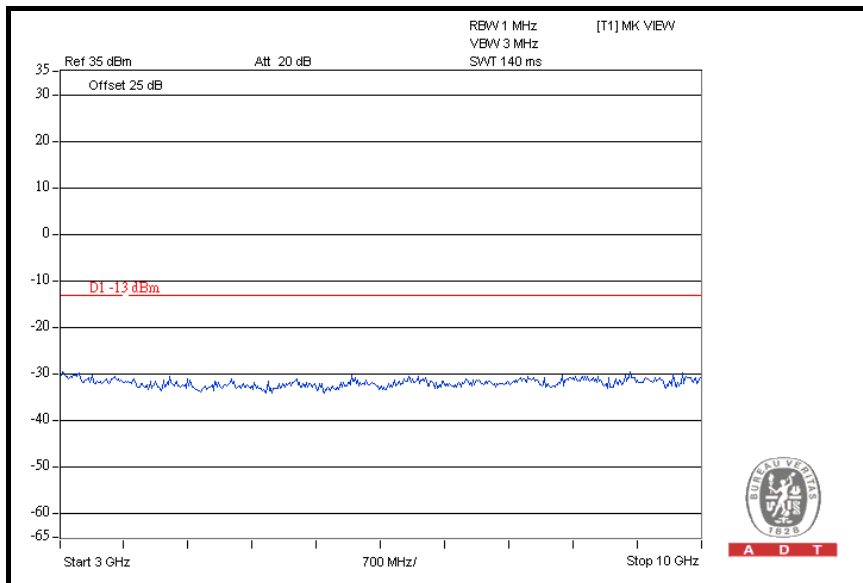



A D T

10GHz ~ 20GHz

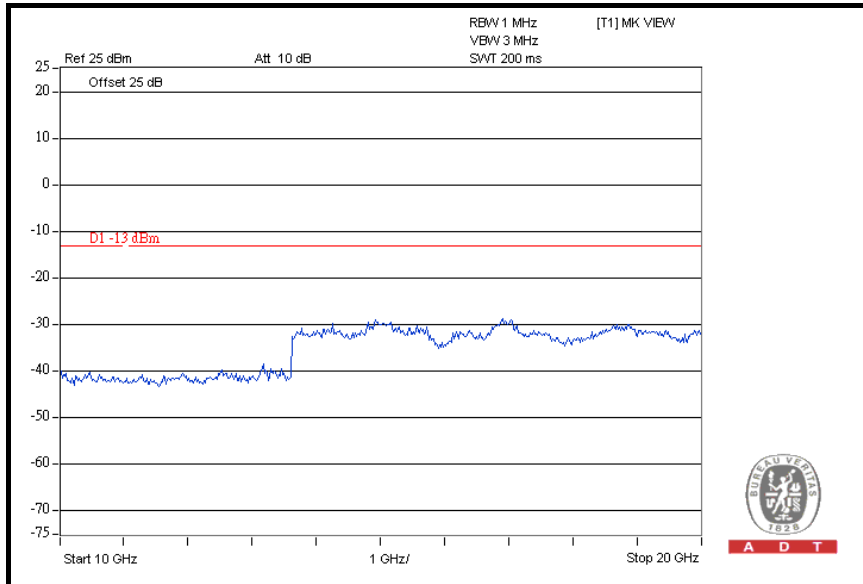

CH 661: 9kHz ~ 3GHz

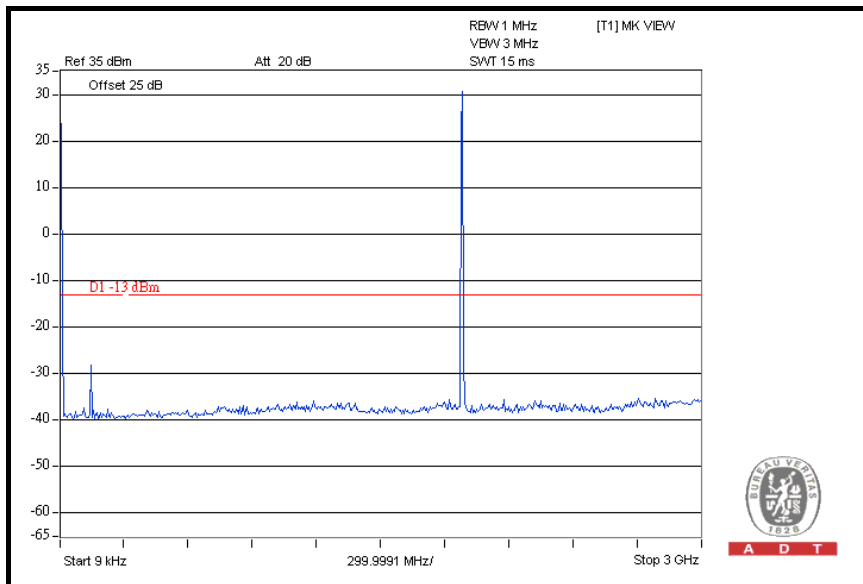



A D T

3GHz ~ 10GHz

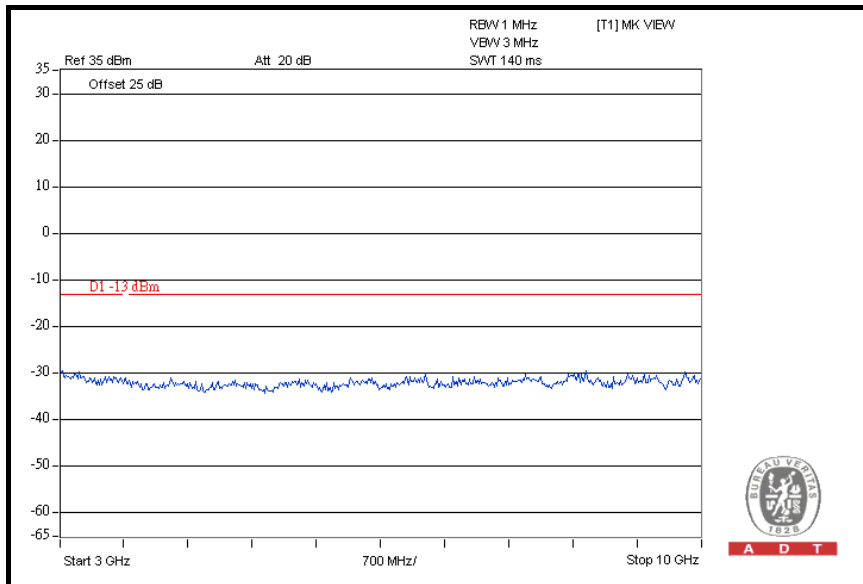

10GHz ~ 20GHz

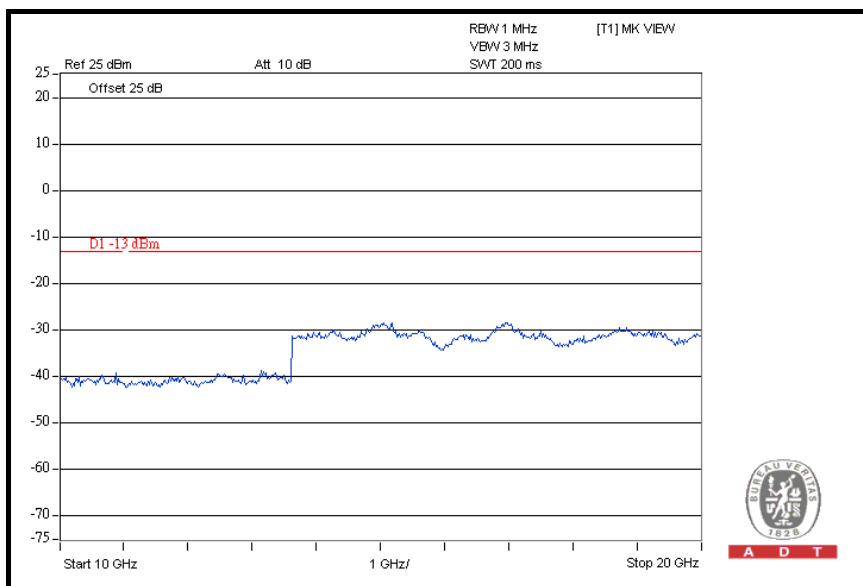



A D T

CH 810: 9kHz ~ 3GHz

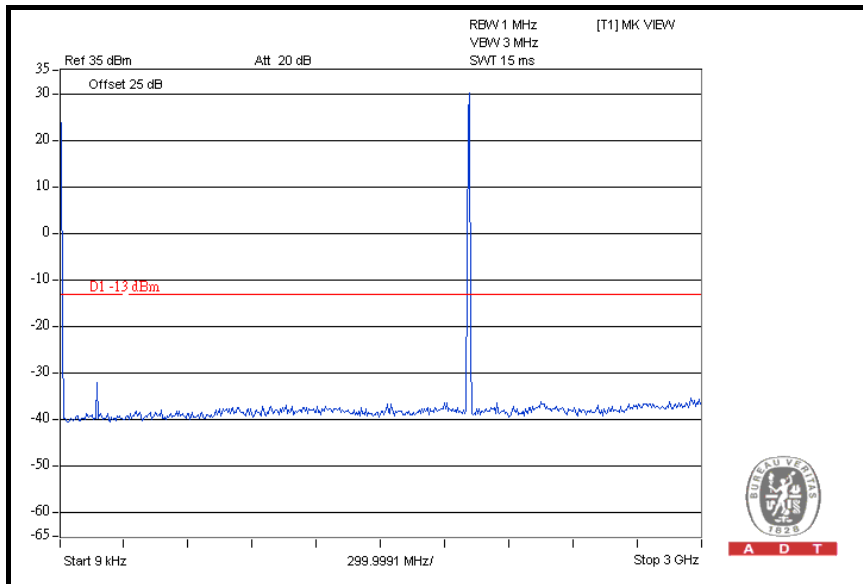

3GHz ~ 10GHz

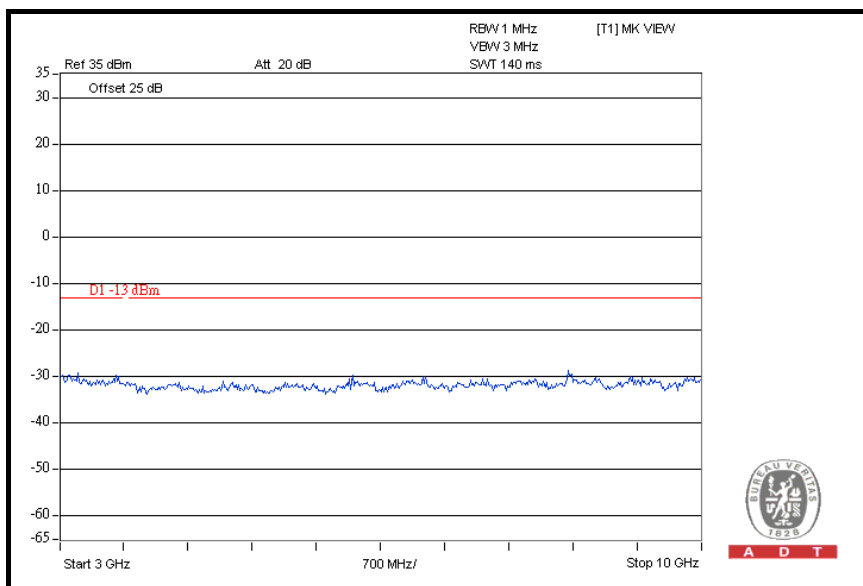



A D T

10GHz ~ 20GHz

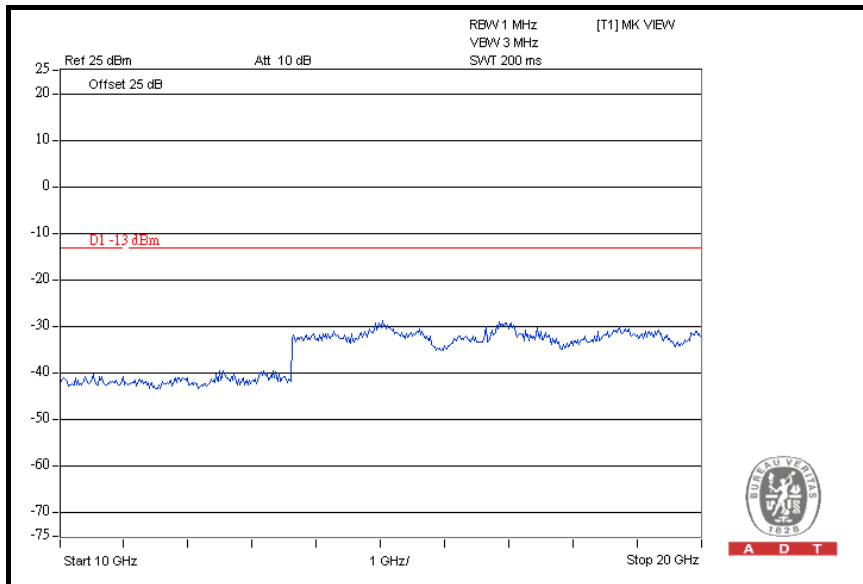

A D T

4.4 RADIATED EMISSION MEASUREMENT (BELOW 1GHz)

4.4.1 LIMITS OF RADIATED EMISSION MEASUREMENT

In the FCC 24.238(a), On any frequency outside a licensee’s frequency block within USPCS spectrum, the power of any emission shall be attenuated below the transmitter power (P) by at least $43 + 10 \log (P)$ dB. The emission of limit equal to -13 dBm. So the limit of emission is the same absolute specified line.

LIMIT (dBm)	EQUIVALENT FIELD STRENGTH AT 3m (dBuV/m) (NOTE)
-13	82.2

NOTE: The following formula is used to convert the equipment radiated power to field strength.

$$E = [1000000\sqrt{(30P)}] / 3 \text{ uV/m, where P is Watts.}$$

4.4.2 TEST INSTRUMENTS

Same as 4.1.2.

4.4.3 TEST PROCEDURES

- a. The EUT was placed on the top of a rotating table 0.8 meters above the ground at a 3 meters semi-anechoic chamber. The table was rotated 360 degrees to determine the position of the highest radiation.
- b. The EUT was set 3 meters away from the interference-receiving antenna, which was mounted on the top of a variable-height antenna tower.
- c. The antenna is a broadband antenna, and its height is varied from one meter to four meters above the ground to determine the maximum value of the field strength. Both horizontal and vertical polarizations of the antenna are set to make the measurement.
- d. For each suspected emission, the EUT was arranged to its worst case and then the antenna was tuned to heights from 1 meter to 4 meters and the rotatable table was turned from 0 degrees to 360 degrees to find the maximum reading.
- e. The test-receiver system was set to Peak Detect Function and Specified Bandwidth with Maximum Hold Mode.
- f. If the emission level of the EUT in peak mode was lower than the limit specified, then testing could be stopped and the peak values of the EUT would be reported. Otherwise the emissions would be re-tested one by one using peak, quasi-peak or average method as specified and then reported in a data sheet.

NOTE: The resolution bandwidth of spectrum analyzer is 1 MHz and the video bandwidth is 3 MHz.

4.4.4 DEVIATION FROM TEST STANDARD

No deviation

4.4.5 TEST SETUP

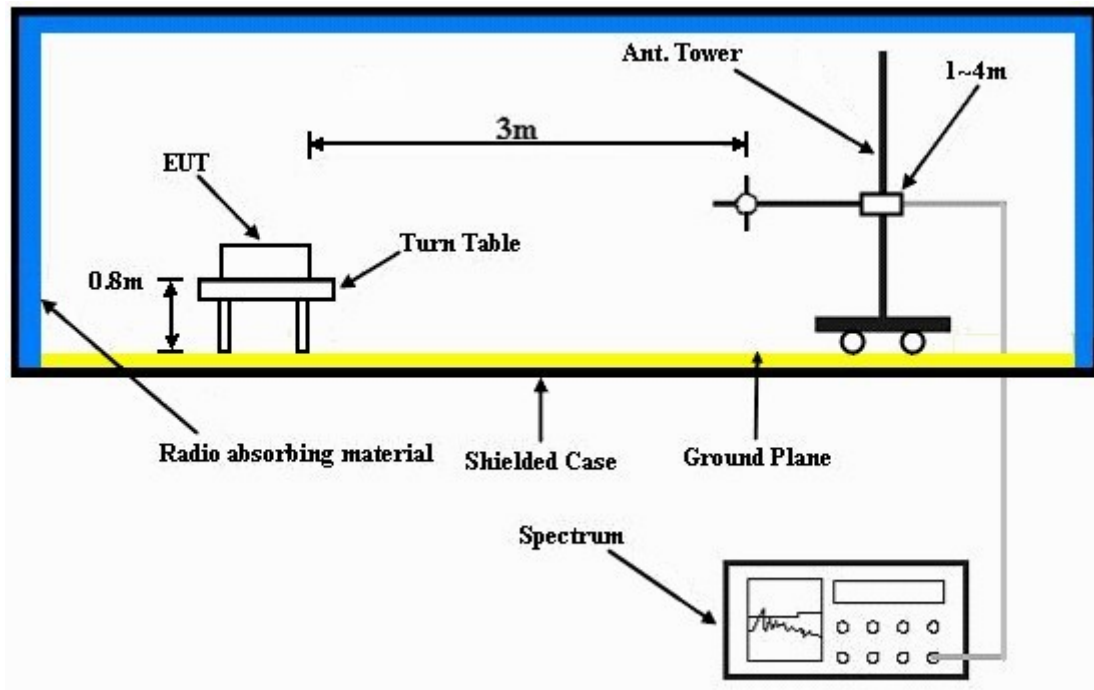

For the actual test configuration, please refer to the attached file (Test Setup Photo).

4.4.6 EUT OPERATING CONDITIONS

- a. The EUT makes a phone call to the communication simulator.
- b. The communication simulator station system controlled an EUT to export maximum output power under transmission mode and specific channel frequency.

4.4.7 TEST RESULTS

MODE	TX channel 810	DETECTOR FUNCTION	Peak
-------------	----------------	--------------------------	------

ANTENNA POLARITY & TEST DISTANCE: HORIZONTAL AT 3 M								
NO.	FREQ. (MHz)	EMISSION LEVEL (dBuV/m)	LIMIT (dBuV/m)	MARGIN (dB)	ANTENNA HEIGHT (m)	TABLE ANGLE (Degree)	RAW VALUE (dBuV)	CORRECTION FACTOR (dB/m)
1	76.65	35.9	82.2	-46.4	1.50 H	202	25.80	10.10
2	134.97	32.6	82.2	-49.7	1.50 H	10	19.00	13.60
3	471.26	30.1	82.2	-52.2	1.00 H	16	11.00	19.10
4	632.61	32.8	82.2	-49.5	2.00 H	139	10.30	22.50
5	776.45	34.1	82.2	-48.2	1.00 H	295	9.70	24.40
6	949.46	37.8	82.2	-44.5	1.00 H	10	11.10	26.70
ANTENNA POLARITY & TEST DISTANCE: VERTICAL AT 3 M								
NO.	FREQ. (MHz)	EMISSION LEVEL (dBuV/m)	LIMIT (dBuV/m)	MARGIN (dB)	ANTENNA HEIGHT (m)	TABLE ANGLE (Degree)	RAW VALUE (dBuV)	CORRECTION FACTOR (dB/m)
1	35.83	45.6	82.2	-36.7	1.00 V	10	32.90	12.70
2	72.77	40.2	82.2	-42.1	1.25 V	31	29.00	11.20
3	313.81	31.0	82.2	-51.3	1.25 V	247	16.00	15.00
4	348.80	27.3	82.2	-55.0	1.25 V	133	11.40	15.90
5	638.44	33.3	82.2	-49.0	1.50 V	175	10.70	22.60
6	902.81	36.8	82.2	-45.5	2.00 V	232	10.80	26.00

NOTE:

1. Emission level (dBuV/m) = Raw Value (dBuV) + Correction Factor (dB).
2. Correction Factor (dB/m) = Antenna Factor (dB/m) + Cable Factor (dB).
3. The other emission levels were very low against the limit.
4. Margin value = Emission level – Limit value.
5. This is valid for all 3 channels.

4.5 RADIATED EMISSION MEASUREMENT (ABOVE 1GHz)

4.5.1 LIMITS OF RADIATED EMISSION MEASUREMENT

In the FCC 24.238(a), On any frequency outside a licensee's frequency block within USPCS spectrum, the power of any emission shall be attenuated below the transmitter power (P) by at least $43 + 10 \log (P)$ dB. The specified minimum attenuation becomes 43dB and the limit of emission equal to -13dBm .

4.5.2 TEST INSTRUMENTS

Same as 4.1.2.

4.5.3 TEST PROCEDURES

- a. Substitution method is used for E.I.R.P measurement. In the semi-anechoic chamber, EUT placed on the 0.8m height of Turn Table, rotated the table around 360 degrees to search the maximum radiation power and receiver antenna shall be rotated vertical and horizontal polarization and moved height from 1m to 4m to find the maximum polar radiated power. The “Read Value” is the spectrum reading the maximum power value.
- b. The substitution horn antenna is substituted for EUT at the same position and signals generator export the CW signal to the substitution antenna via a TX cable. Rotated the Turn Table and moved receiving antenna to find the maximum radiation power. Adjust output power level of S.G to get a Value of spectrum reading equal to “Read Value” of step a. Record the power level of S.G
- c. $EIRP = \text{Output power level of S.G} - \text{TX cable loss} + \text{Antenna gain of substitution horn.}$

NOTE: The resolution bandwidth and video bandwidth of test receiver/spectrum analyzer is 1MHz/3MHz.

4.5.4 DEVIATION FROM TEST STANDARD

No deviation

4.5.5 TEST SETUP

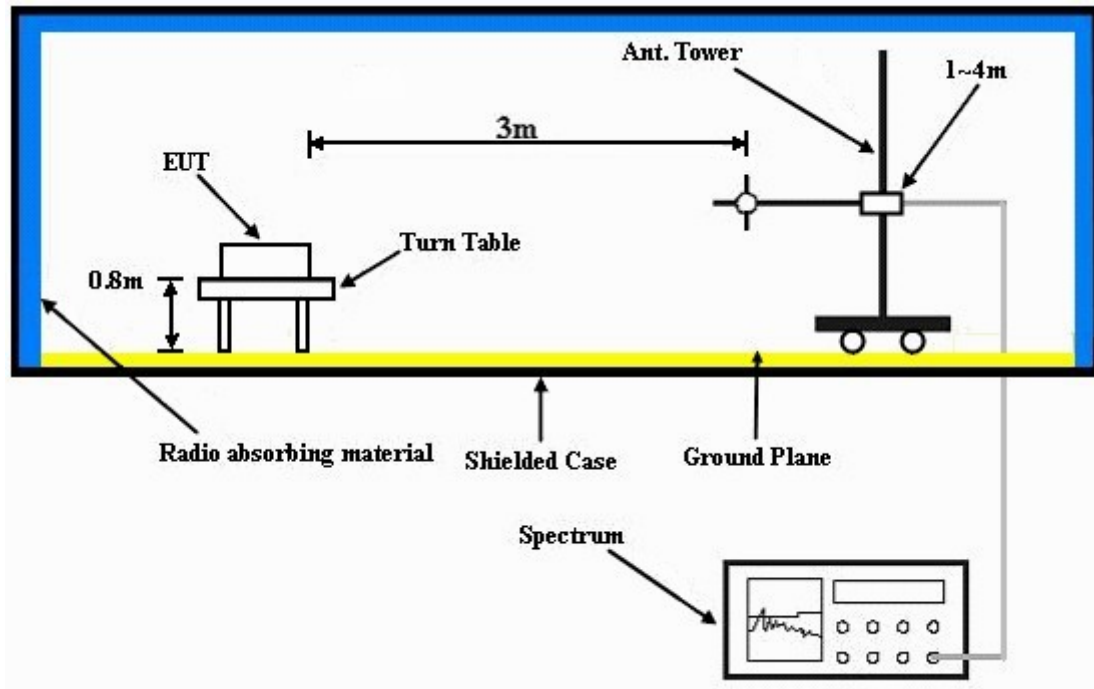

For the actual test configuration, please refer to the attached file (Test Setup Photo).

4.5.6 EUT OPERATING CONDITIONS

- a. The EUT makes a phone call to the communication simulator.
- b. The communication simulator station system controlled an EUT to export maximum output power under transmission mode and specific channel frequency.

4.5.7 TEST RESULTS

MODE	TX channel 512	FREQUENCY RANGE	Above 1000 MHz
-------------	----------------	------------------------	----------------

ANTENNA POLARITY & TEST DISTANCE: HORIZONTAL AT 3 M						
No.	Freq. (MHz)	Emission Level (dBuV)	Limit (dBm)	S.G Power Value (dBm)	Correction Factor (dB)	Power Value (dBm)
1	3700.4	50.0	-13.0	-54.7	9.9	-44.8
2	5550.6	52.8	-13.0	-51.8	9.7	-42.1
ANTENNA POLARITY & TEST DISTANCE: VERTICAL AT 3 M						
No.	Freq. (MHz)	Emission Level (dBuV)	Limit (dBm)	S.G Power Value (dBm)	Correction Factor (dB)	Power Value (dBm)
1	3700.4	46.1	-13.0	-58.7	9.9	-48.8
2	5550.6	50.4	-13.0	-54.2	9.7	-44.5

NOTE: Power Value (dBum) = S.G Power Value (dBm) + Correction Factor (dB).



MODE	TX channel 661	FREQUENCY RANGE	Above 1000 MHz
-------------	----------------	------------------------	----------------

ANTENNA POLARITY & TEST DISTANCE: HORIZONTAL AT 3 M						
No.	Freq. (MHz)	Emission Level (dBuV)	Limit (dBm)	S.G Power Value (dBm)	Correction Factor (dB)	Power Value (dBm)
1	3760.0	51.0	-13.0	-53.7	9.9	-43.8
2	5640.0	53.1	-13.0	-51.2	9.6	-41.6
ANTENNA POLARITY & TEST DISTANCE: VERTICAL AT 3 M						
No.	Freq. (MHz)	Emission Level (dBuV)	Limit (dBm)	S.G Power Value (dBm)	Correction Factor (dB)	Power Value (dBm)
1	3760.0	47.4	-13.0	-57.2	9.9	-47.3
2	5640.0	51.1	-13.0	-53.3	9.6	-43.7

NOTE: Power Value (dBum) = S.G Power Value (dBm) + Correction Factor (dB).



MODE	TX channel 810	FREQUENCY RANGE	Above 1000 MHz
-------------	----------------	------------------------	----------------

ANTENNA POLARITY & TEST DISTANCE: HORIZONTAL AT 3 M						
No.	Freq. (MHz)	Emission Level (dBuV)	Limit (dBm)	S.G Power Value (dBm)	Correction Factor (dB)	Power Value (dBm)
1	3819.6	52.6	-13.0	-52.1	9.9	-42.2
2	5729.4	53.6	-13.0	-50.7	9.6	-41.1

ANTENNA POLARITY & TEST DISTANCE: VERTICAL AT 3 M						
No.	Freq. (MHz)	Emission Level (dBuV)	Limit (dBm)	S.G Power Value (dBm)	Correction Factor (dB)	Power Value (dBm)
1	3819.6	49.8	-13.0	-54.9	9.9	-45.0
2	5729.4	50.6	-13.0	-53.9	9.6	-44.3

NOTE: Power Value (dBum) = S.G Power Value (dBm) + Correction Factor (dB).



A D T

5 PHOTOGRAPHS OF THE TEST CONFIGURATION

Please refer to the attached file (Test Setup Photo).



6 INFORMATION ON THE TESTING LABORATORIES

We, Bureau Veritas Consumer Products Services (H.K.) Ltd., Taoyuan Branch, were founded in 1988 to provide our best service in EMC, Radio, Telecom and Safety consultation. Our laboratories are accredited and approved according to ISO/IEC 17025.

Copies of accreditation certificates of our laboratories obtained from approval agencies can be downloaded from our web site: www.adt.com.tw/index.5/phtml. If you have any comments, please feel free to contact us at the following:

Linko EMC/RF Lab:

Tel: 886-2-26052180

Fax: 886-2-26051924

Hsin Chu EMC/RF Lab:

Tel: 886-3-5935343

Fax: 886-3-5935342

Hwa Ya EMC/RF/Safety/Telecom Lab:

Tel: 886-3-3183232

Fax: 886-3-3185050

Web Site: www.adt.com.tw

The address and road map of all our labs can be found in our web site also.

7 APPENDIX A – MODIFICATIONS RECORDERS FOR ENGINEERING CHANGES TO THE EUT BY THE LAB

No any modifications are made to the EUT by the lab during the test.

---END---