



FCC TEST REPORT (Bluetooth)

REPORT NO.: RF990429C05A
MODEL NO.: EX128, EX122, EX126, EX124G
FCC ID: IHDP56LJ2
RECEIVED: May 24, 2010
TESTED: Jul. 07 ~ Jul. 13, 2010
ISSUED: Jul. 16, 2010

APPLICANT: Motorola Inc

ADDRESS: Mobile Devices 600 N. U.S. Highway 45,
Libertyville, Illinois, United States, 60048-5343

ISSUED BY: Bureau Veritas Consumer Products Services
(H.K.) Ltd., Taoyuan Branch

LAB ADDRESS: No. 47, 14th Ling, Chia Pau Tsuen, Lin Kou
Hsiang, Taipei Hsien 244, Taiwan, R.O.C.

TEST LOCATION: No. 19, Hwa Ya 2nd Rd, Wen Hwa Tsuen,
Kwei Shan Hsiang, Taoyuan Hsien 333,
Taiwan, R.O.C.

This test report consists of 45 pages in total. It may be duplicated completely for legal use with the approval of the applicant. It should not be reproduced except in full, without the written approval of our laboratory. The client should not use it to claim product certification, approval or endorsement by TAF or any government agency. The test results in the report only apply to the tested sample.



Table of Contents

1.	CERTIFICATION	3
2.	SUMMARY OF TEST RESULTS	4
2.1	MEASUREMENT UNCERTAINTY	4
3.	GENERAL INFORMATION.....	5
3.1	GENERAL DESCRIPTION OF EUT	5
3.2	DESCRIPTION OF TEST MODES.....	7
3.2.1	CONFIGURATION OF SYSTEM UNDER TEST	8
3.2.2	TEST MODE APPLICABILITY AND TESTED CHANNEL DETAIL.....	9
3.3	GENERAL DESCRIPTION OF APPLIED STANDARDS	11
3.4	DESCRIPTION OF SUPPORT UNITS	11
4.	TEST TYPES AND RESULTS	12
4.1	RADIATED EMISSION MEASUREMENT	12
4.1.1	LIMITS OF RADIATED EMISSION MEASUREMENT.....	12
4.1.2	TEST INSTRUMENTS	13
4.1.3	TEST PROCEDURES	14
4.1.4	DEVIATION FROM TEST STANDARD	14
4.1.5	TEST SETUP	15
4.1.6	EUT OPERATING CONDITIONS.....	15
4.1.7	TEST RESULTS	16
4.2	CONDUCTED EMISSION MEASUREMENT	28
4.2.1	LIMITS OF CONDUCTED EMISSION MEASUREMENT	28
4.2.2	TEST INSTRUMENTS	28
4.2.3	TEST PROCEDURES	29
4.2.4	DEVIATION FROM TEST STANDARD	29
4.2.5	TEST SETUP	30
4.2.6	EUT OPERATING CONDITIONS.....	30
4.2.7	TEST RESULTS	31
5.	PHOTOGRAPHS OF THE TEST CONFIGURATION.....	43
6.	INFORMATION ON THE TESTING LABORATORIES.....	44
7.	APPENDIX A - MODIFICATIONS RECORDERS FOR ENGINEERING CHANGES TO THE EUT BY THE LAB.....	45



1. CERTIFICATION

PRODUCT: GSM / EGPRS Mobile Phone
MODEL NO.: EX128 (refer to item 3.1 for more detail)
BRAND: Motorola
APPLICANT: Motorola Inc
TESTED: Jul. 07 ~ Jul. 13, 2010
TEST SAMPLE: ENGINEERING SAMPLE
STANDARDS: FCC Part 15, Subpart C (Section 15.247)
ANSI C63.4-2003

This report is issued as a supplementary report of **RF990429C05**. This report shall be used combined together with its original report.

PREPARED BY : Pettie Chen , **DATE:** Jul. 16, 2010
Pettie Chen / Specialist

TECHNICAL ACCEPTANCE : Long Chen , **DATE:** Jul. 16, 2010
Responsible for RF Long Chen / Senior Engineer

APPROVED BY : Gary Chang , **DATE:** Jul. 16, 2010
Gary Chang / Assistant Manager

Note: Only Radiated Emissions test & Conducted Emission test were performed for this addendum. Other testing data refer to original report.



2. SUMMARY OF TEST RESULTS

The EUT has been tested according to the following specifications:

APPLIED STANDARD: FCC Part 15, Subpart C			
STANDARD SECTION	TEST TYPE AND LIMIT	RESULT	REMARK
15.207	AC Power Conducted Emission	PASS	Meet the requirement of limit. Minimum passing margin is -18.39dB at 1.496MHz.
15.247(a)(1) (iii)	Number of Hopping Frequency Used Spec.: At least 15 channels	NA	Not Applicable
15.247(a)(1) (iii)	Dwell Time on Each Channel Spec.: Max. 0.4 second within 31.6 second	NA	Not Applicable
15.247(a)(1)	1. Hopping Channel Separation Spec.: Min. 25 kHz or $\frac{2}{3}$ *20 dB bandwidth, whichever is greater 2. Spectrum Bandwidth of a Frequency Hopping Sequence Spread Spectrum System	NA	Not Applicable
15.247(b)	Maximum Output Power Spec.: max. 21dBm	NA	Not Applicable
15.247(d)	Transmitter Radiated Emissions Spec.: Table 15.209	PASS	Meet the requirement of limit. Minimum passing margin is -8.0dB at 53.23MHz.
15.247(d)	Band Edge Measurement	NA	Not Applicable
15.203	Antenna Requirement	PASS	No antenna connector is used.

NOTE: Only Radiated Emissions test & Conducted Emission test were performed for this addendum. Other testing data refer to original report.

2.1 MEASUREMENT UNCERTAINTY

Where relevant, the following measurement uncertainty levels have been estimated for tests performed on the EUT as specified in CISPR 16-4-2:

MEASUREMENT	FREQUENCY	UNCERTAINTY
Conducted emissions	150kHz~30MHz	2.44 dB
Radiated emissions	30MHz ~ 200MHz	3.34 dB
	200MHz ~1000MHz	3.35 dB
	1GHz ~ 18GHz	2.26 dB
	18GHz ~ 40GHz	1.94 dB

This uncertainty represents an expanded uncertainty expressed at approximately the 95% confidence level using a coverage factor of k=2.



3. GENERAL INFORMATION

3.1 GENERAL DESCRIPTION OF EUT

EUT	GSM / EGPRS Mobile Phone
MODEL NO.	EX128 (Refer to Note for the more details)
FCC ID	IHDP56LJ2
POWER SUPPLY	3.7Vdc (battery) 5.0Vdc (adapter)
MODULATION TYPE	GFSK, $\pi/4$ -DQPSK, 8DPSK
MODULATION TECHNOLOGY	FHSS
TRANSFER RATE	1/2/3Mbps
OPERATING FREQUENCY	2402 ~ 2480MHz
NUMBER OF CHANNEL	79
OUTPUT POWER	6.1mW
ANTENNA TYPE	Embedded inverted-F antenna
MAX. ANTENNA GAIN	-4dBi gain
ANTENNA CONNECTOR	NA
DATA CABLE	NA
I/O PORTS	Refer to user's manual
ACCESSORY DEVICES	Adapter, Battery, Earphone (1. Model: SYN2356A, 1.3m shielded cable without core; 2. Model: SJYN0394A, 1.4m shielded cable without core)

NOTE:

1. This report is issued as a supplementary report to the original BVADT report no.: RF990429C05.
2. This report is prepared for FCC class II permissive change. Differences compared with the original report are listed as below.

ITEM	ORIGINAL DESCRIPTION	CLASS II CHANGE DESCRIPTION
	Model: EX128, dual SIM with Stylus	-
1	Model: EX122, single SIM with Stylus.	Model: EX126, single SIM without stylus. (for North America generic & WE) Model: EX124G, single SIM without stylus. (for TF) Change sound receiver, speaker and new housing without stylus.
2	Earphone (Model: SYN2356A, 1.3m shielded cable without core)	Add a new earphone. (Model: SJYN0394A, 1.4m shielded cable without core)

** According to original report, the worst model EX128 and new model EX126 were selected for the final test configuration. Therefore, emission measurements listed as below had been re-tested.

1. Model: EX128 with new earphone.
2. Model: EX126 with original and new earphone.



A D T

3. The EUT were tested with the following lithium battery and adapter:

LITHIUM BATTERY	
BRAND :	MOTOROLA
MODEL :	BQ50
RATING :	3.7Vdc, 910mAh, 3.4Wh

ADAPTER	
BRAND :	MOTOROLA
MODEL :	DCH3-050US-0303
INPUT :	100-240Vac, 50/60Hz, 0.2A
OUTPUT :	5Vdc, 550mA

4. The test data are separated into following test reports.

	TEST STANDARD	REFERENCE REPORT
BLUETOOTH	FCC Part 15, Subpart C (Section 15.247)	RF990429C05A
GSM 850	FCC Part 22	RF990429C05A-1
PCS 1900	FCC Part 24	RF990429C05A-2

5. The above EUT information was declared by manufacturer and for more detailed features description, please refer to the manufacturer's specifications or user's manual.



A D T

3.2 DESCRIPTION OF TEST MODES

79 channels are provided to this EUT:

CHANNEL	FREQ. (MHz)	CHANNEL	FREQ. (MHz)	CHANNEL	FREQ. (MHz)	CHANNEL	FREQ. (MHz)
0	2402	20	2422	40	2442	60	2462
1	2403	21	2423	41	2443	61	2463
2	2404	22	2424	42	2444	62	2464
3	2405	23	2425	43	2445	63	2465
4	2406	24	2426	44	2446	64	2466
5	2407	25	2427	45	2447	65	2467
6	2408	26	2428	46	2448	66	2468
7	2409	27	2429	47	2449	67	2469
8	2410	28	2430	48	2450	68	2470
9	2411	29	2431	49	2451	69	2471
10	2412	30	2432	50	2452	70	2472
11	2413	31	2433	51	2453	71	2473
12	2414	32	2434	52	2454	72	2474
13	2415	33	2435	53	2455	73	2475
14	2416	34	2436	54	2456	74	2476
15	2417	35	2437	55	2457	75	2477
16	2418	36	2438	56	2458	76	2478
17	2419	37	2439	57	2459	77	2479
18	2420	38	2440	58	2460	78	2480
19	2421	39	2441	59	2461		

3.2.1 CONFIGURATION OF SYSTEM UNDER TEST

TEST MODE A1, B1, C1

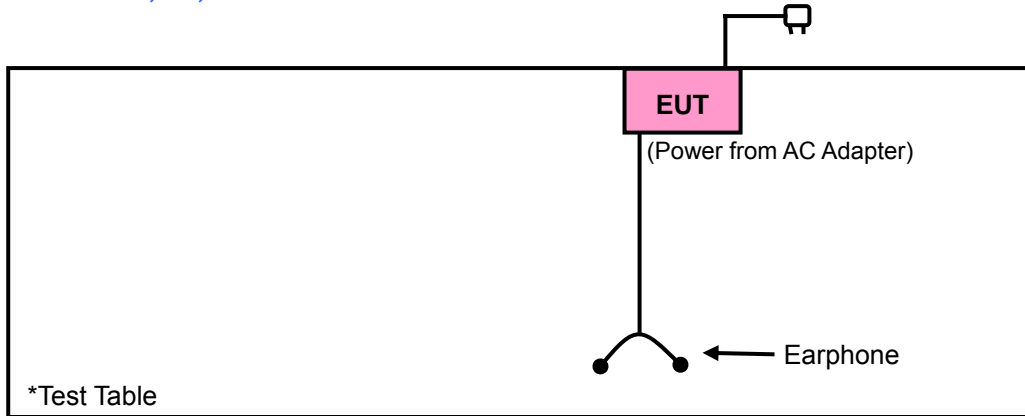

TEST MODE A2, B2, C2

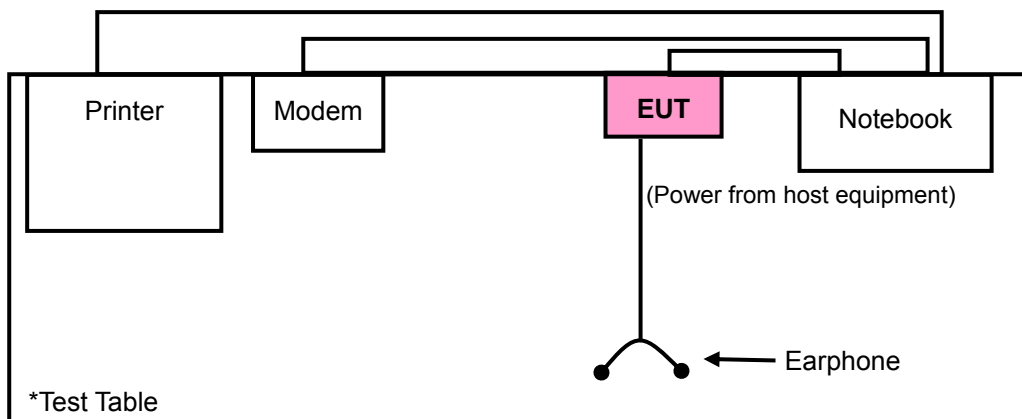



3.2.2 TEST MODE APPLICABILITY AND TESTED CHANNEL DETAIL

EUT CONFIGURE MODE	APPLICABLE TO			DESCRIPTION	
	RE≥1G	RE<1G	PLC	EUT	POWER
A1	√	√	√	EUT model: EX128 with earphone: SJYN0394A	Power from AC Adapter
A2	-	√	√		Power from host equipment
B1	√	√	√	EUT model: EX126 with earphone: SYN2356A	Power from AC Adapter
B2	-	√	√		Power from host equipment
C1	√	√	√	EUT model: EX126 with earphone: SJYN0394A	Power from AC Adapter
C2	-	√	√		Power from host equipment

Where **RE≥1G**: Radiated Emission above 1GHz
PLC: Power Line Conducted Emission

RE<1G: Radiated Emission below 1GHz
APCM: Antenna Port Conducted Measurement

NOTE: "-" means no effect.

RADIATED EMISSION TEST (ABOVE 1 GHz):

- Pre-Scan has been conducted to determine the worst-case mode from all possible combinations between available modulations, data rates, XYZ axis, antenna ports (if EUT with antenna diversity architecture) and packet type.
- Following channel(s) was (were) selected for the final test as listed below.

EUT CONFIGURE MODE	AVAILABLE CHANNEL	TESTED CHANNEL	MODULATION TECHNOLOGY	MODULATION TYPE	PACKET TYPE	AXIS
A1, B1, C1	0 to 78	0	FHSS	GFSK	DH5	X

RADIATED EMISSION TEST (BELOW 1 GHz):

- Pre-Scan has been conducted to determine the worst-case mode from all possible combinations between available modulations, data rates, XYZ axis, antenna ports (if EUT with antenna diversity architecture) and packet type.
- Following channel(s) was (were) selected for the final test as listed below.

EUT CONFIGURE MODE	AVAILABLE CHANNEL	TESTED CHANNEL	MODULATION TECHNOLOGY	MODULATION TYPE	PACKET TYPE	AXIS
A1, A2, B1, B2, C1, C2	0 to 78	0	FHSS	GFSK	DH5	X



A D T

POWER LINE CONDUCTED EMISSION TEST:

- Pre-Scan has been conducted to determine the worst-case mode from all possible combinations between available modulations, antenna ports (if EUT with antenna diversity architecture), and packet types.
- Following channel(s) was (were) selected for the final test as listed below.

EUT CONFIGURE MODE	AVAILABLE CHANNEL	TESTED CHANNEL	MODULATION TECHNOLOGY	MODULATION TYPE	PACKET TYPE
A1, A2, B1, B2, C1, C2	0 to 78	0	FHSS	GFSK	DH5

TEST CONDITION:

APPLICABLE TO	ENVIRONMENTAL CONDITIONS	INPUT POWER (SYSTEM)	TESTED BY
RE \geq 1G	25deg. C, 65%RH, 1002 hPa	120Vac, 60Hz	Brad Wu
RE $<$ 1G	25deg. C, 65%RH, 1002 hPa	120Vac, 60Hz	Brad Wu
PLC	24deg. C, 62%RH, 1018 hPa	120Vac, 60Hz	Antony Lee

3.3 GENERAL DESCRIPTION OF APPLIED STANDARDS

The EUT is a RF Product. According to the specifications of the manufacturer, it must comply with the requirements of the following standards:

FCC Part 15, Subpart C. (15.247)
ANSI C63.4-2003

All test items have been performed and recorded as per the above standards.

NOTE: The EUT is also considered as a kind of computer peripheral, because the connection to computer is necessary for typical use. It has been verified to comply with the requirements of FCC Part 15, Subpart B, Class B (DoC). The test report has been issued separately.

3.4 DESCRIPTION OF SUPPORT UNITS

The EUT has been tested as an independent unit together with other necessary accessories or support units. The following support units or accessories were used to form a representative test configuration during the tests.

NO.	PRODUCT	BRAND	MODEL NO.	SERIAL NO.	FCC ID
1	NOTEBOOK COMPUTER	DELL	D600	CN-0C3038-486 43-3A8-8646	QDS-BRCM1005-D
2	MODEM	ACEEX	1414V/3	0401008277	IFAXDM1414
3	PRINTER	EPSON	LQ-300+	DCGY054146	FCC DoC Approved

NO.	SIGNAL CABLE DESCRIPTION OF THE ABOVE SUPPORT UNITS
1	1.3m shielded cable w/o core.
2	1.2m braid shielded wire, DB25 & DB9 connector, w/o core.
3	1.8m braid shielded wire, DB25 connector, w/o core.

NOTE: All power cords of the above support units are non shielded (1.8m).

4. TEST TYPES AND RESULTS

4.1 RADIATED EMISSION MEASUREMENT

4.1.1 LIMITS OF RADIATED EMISSION MEASUREMENT

Emissions radiated outside of the specified bands, shall be according to the general radiated limits in 15.209 as following:

FREQUENCIES (MHz)	FIELD STRENGTH (microvolts/meter)	MEASUREMENT DISTANCE (meters)
0.009 ~ 0.490	2400/F(kHz)	300
0.490 ~ 1.705	24000/F(kHz)	30
1.705 ~ 30.0	30	30
30 ~ 88	100	3
88 ~ 216	150	3
216 ~ 960	200	3
Above 960	500	3

NOTE:

1. The lower limit shall apply at the transition frequencies.
2. Emission level (dBuV/m) = 20 log Emission level (uV/m).
3. As shown in 15.35(b), for frequencies above 1000MHz, the field strength limits are based on average detector, however, the peak field strength of any emission shall not exceed the maximum permitted average limits, specified above by more than 20dB under any condition of modulation.



4.1.2 TEST INSTRUMENTS

DESCRIPTION & MANUFACTURER	MODEL NO.	SERIAL NO.	DATE OF CALIBRATION	DUE DATE OF CALIBRATION
Test Receiver ROHDE & SCHWARZ	ESIB7	100188	Dec. 21, 2009	Dec. 20, 2010
Spectrum Analyzer ROHDE & SCHWARZ	FSP40	100269	Dec. 31, 2009	Dec. 30, 2010
BILOG Antenna SCHWARZBECK	VULB9168	9168-160	Apr. 27, 2010	Apr. 26, 2011
HORN Antenna SCHWARZBECK	9120D	9120D-405	Feb. 03, 2010	Feb. 02, 2011
HORN Antenna SCHWARZBECK	BBHA 9170	BBHA9170243	Dec. 25, 2009	Dec. 24, 2010
Preamplifier Agilent	8447D	2944A10633	Nov. 10, 2009	Nov. 09, 2010
Preamplifier Agilent	8449B	3008A01964	Nov. 09, 2009	Nov. 08, 2010
RF signal cable HUBER+SUHNNER	SUCOFLEX 104	238141/4	May 14, 2010	May 13, 2011
RF signal cable HUBER+SUHNNER	SUCOFLEX 104	12738/6	May 14, 2010	May 13, 2011
Software ADT.	ADT_Radiated_ V7.6.15.9.2	NA	NA	NA
Antenna Tower inn-co GmbH	MA 4000	013303	NA	NA
Antenna Tower Controller inn-co GmbH	CO2000	017303	NA	NA
Turn Table ADT.	TT100.	TT93021703	NA	NA
Turn Table Controller ADT.	SC100.	SC93021703	NA	NA

- NOTE:**
1. The calibration interval of the above test instruments is 12 months and the calibrations are traceable to NML/ROC and NIST/USA.
 2. The test was performed in HwaYa Chamber 3.
 3. The horn antenna and HP preamplifier (model: 8449B) are used only for the measurement of emission frequency above 1GHz if tested.
 4. The FCC Site Registration No. is 988962.
 5. The IC Site Registration No. is IC 7450F-3.

4.1.3 TEST PROCEDURES

- a. The EUT was placed on the top of a rotating table 0.8 meters above the ground at a 3 meter semi-anechoic chamber. The table was rotated 360 degrees to determine the position of the highest radiation.
- b. The EUT was set 3 meters away from the interference-receiving antenna, which was mounted on the top of a variable-height antenna tower.
- c. The antenna is a broadband antenna, and its height is varied from one meter to four meters above the ground to determine the maximum value of the field strength. Both horizontal and vertical polarizations of the antenna are set to make the measurement.
- d. For each suspected emission, the EUT was arranged to its worst case and then the antenna was tuned to heights from 1 meter to 4 meters and the rotatable table was turned from 0 degrees to 360 degrees to find the maximum reading.
- e. The test-receiver system was set to Peak Detect Function and Specified Bandwidth with Maximum Hold Mode.
- f. If the emission level of the EUT in peak mode was lower than the limit specified, then testing could be stopped and the peak values of the EUT would be reported. Otherwise the emissions would be re-tested one by one using peak, quasi-peak or average method as specified and then reported in a data sheet.

NOTE:

1. The resolution bandwidth and video bandwidth of test receiver/spectrum analyzer is 120kHz for Quasi-peak detection at frequency below 1GHz.
2. The resolution bandwidth of test receiver/spectrum analyzer is 1 MHz and video bandwidth is 3MHz for Peak detection at frequency above 1GHz.
3. All modes of operation were investigated and the worst-case emissions are reported.

4.1.4 DEVIATION FROM TEST STANDARD

No deviation

4.1.5 TEST SETUP

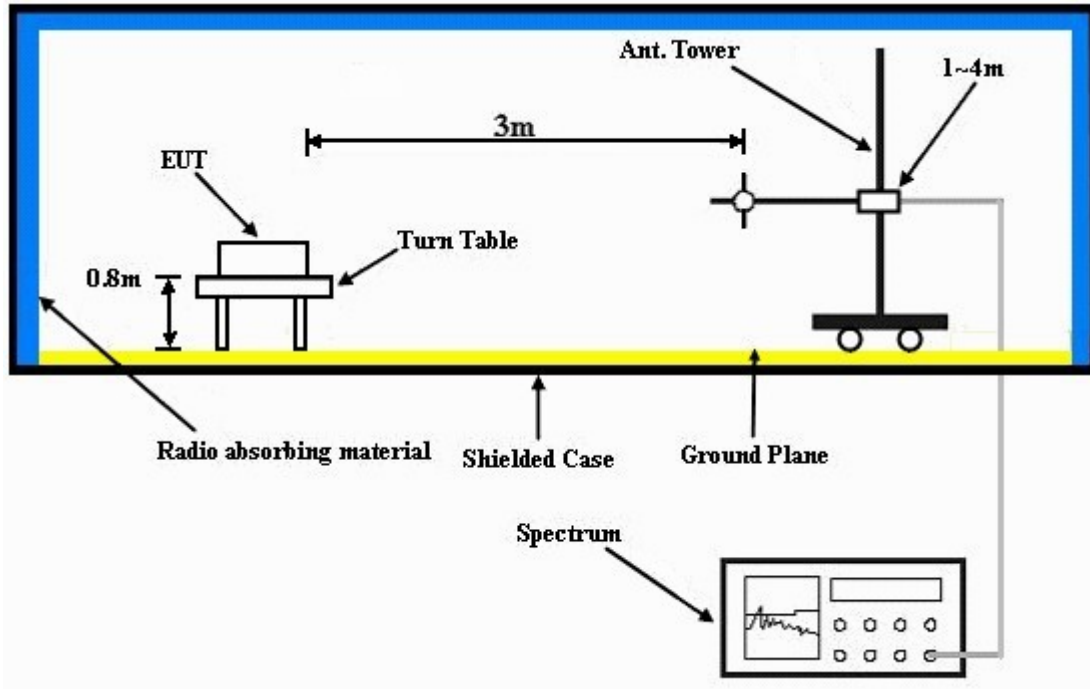

For the actual test configuration, please refer to the attached file (Test Setup Photo).

4.1.6 EUT OPERATING CONDITIONS

TEST MODE A1, B1, C1

- Placed EUT on a testing table.
- The EUT runs a test program (provided by manufacture) to transmit at specific channel.

TEST MODE A2, B2, C2

- Connected the EUT to a notebook via a USB cable and placed on a testing table.
- The EUT runs a test program (provided by manufacture) to transmit at specific channel.
- The necessary accessories enable the system in full functions.



A D T

4.1.7 TEST RESULTS

GFSK

EUT TEST CONDITION		MEASUREMENT DETAIL	
CHANNEL	Channel 0	FREQUENCY RANGE	1 ~ 25GHz
INPUT POWER (SYSTEM)	120Vac, 60Hz	DETECTOR FUNCTION	Peak (PK) Average (AV)
ENVIRONMENTAL CONDITIONS	25deg. C, 65%RH 1002 hPa	TESTED BY	Brad Wu
TEST MODE	A1		

ANTENNA POLARITY & TEST DISTANCE: HORIZONTAL AT 3 M								
NO.	FREQ. (MHz)	EMISSION LEVEL (dBuV/m)	LIMIT (dBuV/m)	MARGIN (dB)	ANTENNA HEIGHT (m)	TABLE ANGLE (Degree)	RAW VALUE (dBuV)	CORRECTION FACTOR (dB/m)
1	2390.00	48.0 PK	74.0	-26.0	1.28 H	121	17.50	30.50
2	2390.00	35.3 AV	54.0	-18.7	1.28 H	121	4.80	30.50
3	#2398.00	55.4 PK	86.3	-30.9	1.28 H	121	24.90	30.50
4	#2398.00	40.3 AV	56.2	-15.9	1.28 H	121	9.80	30.50
5	#2400.00	51.7 PK	86.3	-34.6	1.28 H	121	21.20	30.50
6	#2400.00	21.6 AV	56.2	-34.6	1.28 H	121	-8.90	30.50
7	*2402.00	106.3 PK			1.28 H	121	75.80	30.50
8	*2402.00	76.2 AV			1.28 H	121	45.70	30.50
9	4804.00	48.7 PK	74.0	-25.3	1.01 H	15	12.60	36.10
10	4804.00	18.6 AV	54.0	-35.4	1.01 H	15	-17.50	36.10

- REMARKS:**
- Emission level (dBuV/m) = Raw Value (dBuV) + Correction Factor (dB/m).
 - Correction Factor (dB/m) = Antenna Factor (dB/m) + Cable Factor (dB).
 - The other emission levels were very low against the limit.
 - Margin value = Emission level – Limit value.
 - * *: Fundamental frequency.
 - The DH5 packet was the worse case duty cycle for a transmit dwell time on a channel, based upon bluetooth theory the transmitter is on 0.625 * 5 per 296.25 ms per channel. Therefore, the duty cycle correlation factor be equal to: $20\log(3.125 / 100) = -30.1$ dB.
 - Average value = peak reading + $20\log(\text{duty cycle})$.



A D T

EUT TEST CONDITION		MEASUREMENT DETAIL	
CHANNEL	Channel 0	FREQUENCY RANGE	1 ~ 25GHz
INPUT POWER (SYSTEM)	120Vac, 60Hz	DETECTOR FUNCTION	Peak (PK) Average (AV)
ENVIRONMENTAL CONDITIONS	25deg. C, 65%RH 1002 hPa	TESTED BY	Brad Wu
TEST MODE	A1		

ANTENNA POLARITY & TEST DISTANCE: VERTICAL AT 3 M								
NO.	FREQ. (MHz)	EMISSION LEVEL (dBuV/m)	LIMIT (dBuV/m)	MARGIN (dB)	ANTENNA HEIGHT (m)	TABLE ANGLE (Degree)	RAW VALUE (dBuV)	CORRECTION FACTOR (dB/m)
1	2390.00	43.0 PK	74.0	-31.0	1.24 V	221	12.50	30.50
2	2390.00	30.8 AV	54.0	-23.2	1.24 V	221	0.30	30.50
3	#2398.00	50.5 PK	81.1	-30.6	1.24 V	221	20.00	30.50
4	#2398.00	35.4 AV	51.0	-15.6	1.24 V	221	4.90	30.50
5	#2400.00	46.5 PK	81.1	-34.6	1.24 V	221	16.00	30.50
6	#2400.00	16.4 AV	51.0	-34.6	1.24 V	221	-14.10	30.50
7	*2402.00	101.1 PK			1.24 V	221	70.60	30.50
8	*2402.00	71.0 AV			1.24 V	221	40.50	30.50
9	4804.00	48.5 PK	74.0	-25.5	1.01 V	29	12.40	36.10
10	4804.00	18.4 AV	54.0	-35.6	1.01 V	29	-17.70	36.10

- REMARKS:**
1. Emission level (dBuV/m) = Raw Value (dBuV) + Correction Factor (dB/m).
 2. Correction Factor (dB/m) = Antenna Factor (dB/m) + Cable Factor (dB).
 3. The other emission levels were very low against the limit.
 4. Margin value = Emission level – Limit value.
 5. “ * “: Fundamental frequency.
 6. The DH5 packet was the worse case duty cycle for a transmit dwell time on a channel, based upon bluetooth theory the transmitter is on 0.625 * 5 per 296.25 ms per channel. Therefore, the duty cycle correlation factor be equal to: $20\log(3.125 / 100) = -30.1$ dB.
 7. Average value = peak reading + $20\log(\text{duty cycle})$.
 8. "#":The radiated frequency is out the restricted band.



A D T

EUT TEST CONDITION		MEASUREMENT DETAIL	
CHANNEL	Channel 0	FREQUENCY RANGE	1 ~ 25GHz
INPUT POWER (SYSTEM)	120Vac, 60Hz	DETECTOR FUNCTION	Peak (PK) Average (AV)
ENVIRONMENTAL CONDITIONS	25deg. C, 65%RH 1002 hPa	TESTED BY	Brad Wu
TEST MODE	B1		

ANTENNA POLARITY & TEST DISTANCE: HORIZONTAL AT 3 M								
NO.	FREQ. (MHz)	EMISSION LEVEL (dBuV/m)	LIMIT (dBuV/m)	MARGIN (dB)	ANTENNA HEIGHT (m)	TABLE ANGLE (Degree)	RAW VALUE (dBuV)	CORRECTION FACTOR (dB/m)
1	2390.00	47.8 PK	74.0	-26.2	1.09 H	335	17.30	30.50
2	2390.00	34.9 AV	54.0	-19.1	1.09 H	335	4.40	30.50
3	#2398.00	55.3 PK	85.4	-30.1	1.09 H	335	24.80	30.50
4	#2398.00	39.8 AV	55.3	-15.5	1.09 H	335	9.30	30.50
5	#2400.00	50.5 PK	85.4	-34.9	1.09 H	335	20.00	30.50
6	#2400.00	20.4 AV	55.3	-34.9	1.09 H	335	-10.10	30.50
7	*2402.00	105.4 PK			1.09 H	335	74.90	30.50
8	*2402.00	75.3 AV			1.09 H	335	44.80	30.50
9	4804.00	48.5 PK	74.0	-25.5	1.01 H	241	12.40	36.10
10	4804.00	18.4 AV	54.0	-35.6	1.01 H	241	-17.70	36.10

- REMARKS:**
1. Emission level (dBuV/m) = Raw Value (dBuV) + Correction Factor (dB/m).
 2. Correction Factor (dB/m) = Antenna Factor (dB/m) + Cable Factor (dB).
 3. The other emission levels were very low against the limit.
 4. Margin value = Emission level – Limit value.
 5. “ * “: Fundamental frequency.
 6. The DH5 packet was the worse case duty cycle for a transmit dwell time on a channel, based upon bluetooth theory the transmitter is on 0.625 * 5 per 296.25 ms per channel. Therefore, the duty cycle correlation factor be equal to: $20\log(3.125 / 100) = -30.1$ dB.
 7. Average value = peak reading + $20\log(\text{duty cycle})$.



A D T

EUT TEST CONDITION		MEASUREMENT DETAIL	
CHANNEL	Channel 0	FREQUENCY RANGE	1 ~ 25GHz
INPUT POWER (SYSTEM)	120Vac, 60Hz	DETECTOR FUNCTION	Peak (PK) Average (AV)
ENVIRONMENTAL CONDITIONS	25deg. C, 65%RH 1002 hPa	TESTED BY	Brad Wu
TEST MODE	B1		

ANTENNA POLARITY & TEST DISTANCE: VERTICAL AT 3 M								
NO.	FREQ. (MHz)	EMISSION LEVEL (dBuV/m)	LIMIT (dBuV/m)	MARGIN (dB)	ANTENNA HEIGHT (m)	TABLE ANGLE (Degree)	RAW VALUE (dBuV)	CORRECTION FACTOR (dB/m)
1	2390.00	42.6 PK	74.0	-31.4	1.21 V	225	12.10	30.50
2	2390.00	30.3 AV	54.0	-23.7	1.21 V	225	-0.20	30.50
3	#2398.00	50.2 PK	80.3	-30.1	1.21 V	225	19.70	30.50
4	#2398.00	34.9 AV	50.2	-15.3	1.21 V	225	4.40	30.50
5	#2400.00	45.4 PK	80.3	-34.9	1.21 V	225	14.90	30.50
6	#2400.00	15.3 AV	50.2	-34.9	1.21 V	225	-15.20	30.50
7	*2402.00	100.3 PK			1.21 V	225	69.80	30.50
8	*2402.00	70.2 AV			1.21 V	225	39.70	30.50
9	4804.00	48.3 PK	74.0	-25.7	1.01 V	59	12.20	36.10
10	4804.00	18.2 AV	54.0	-35.8	1.01 V	59	-17.90	36.10

- REMARKS:**
1. Emission level (dBuV/m) = Raw Value (dBuV) + Correction Factor (dB/m).
 2. Correction Factor (dB/m) = Antenna Factor (dB/m) + Cable Factor (dB).
 3. The other emission levels were very low against the limit.
 4. Margin value = Emission level – Limit value.
 5. “ * “: Fundamental frequency.
 6. The DH5 packet was the worse case duty cycle for a transmit dwell time on a channel, based upon bluetooth theory the transmitter is on 0.625 * 5 per 296.25 ms per channel. Therefore, the duty cycle correlation factor be equal to: $20\log(3.125 / 100) = -30.1$ dB.
 7. Average value = peak reading + $20\log(\text{duty cycle})$.
 8. "#":The radiated frequency is out the restricted band.



A D T

EUT TEST CONDITION		MEASUREMENT DETAIL	
CHANNEL	Channel 0	FREQUENCY RANGE	1 ~ 25GHz
INPUT POWER (SYSTEM)	120Vac, 60Hz	DETECTOR FUNCTION	Peak (PK) Average (AV)
ENVIRONMENTAL CONDITIONS	25deg. C, 65%RH 1006 hPa	TESTED BY	Brad Wu
TEST MODE	C1		

ANTENNA POLARITY & TEST DISTANCE: HORIZONTAL AT 3 M								
NO.	FREQ. (MHz)	EMISSION LEVEL (dBuV/m)	LIMIT (dBuV/m)	MARGIN (dB)	ANTENNA HEIGHT (m)	TABLE ANGLE (Degree)	RAW VALUE (dBuV)	CORRECTION FACTOR (dB/m)
1	2390.00	47.5 PK	74.0	-26.5	1.06 H	332	17.00	30.50
2	2390.00	34.6 AV	54.0	-19.4	1.06 H	332	4.10	30.50
3	#2398.00	55.0 PK	85.2	-30.2	1.06 H	332	24.50	30.50
4	#2398.00	39.5 AV	55.1	-15.6	1.06 H	332	9.00	30.50
5	#2400.00	50.2 PK	85.2	-35.0	1.06 H	332	19.70	30.50
6	#2400.00	20.1 AV	55.1	-35.0	1.06 H	332	-10.40	30.50
7	*2402.00	105.2 PK			1.06 H	332	74.70	30.50
8	*2402.00	75.1 AV			1.06 H	332	44.60	30.50
9	4804.00	48.2 PK	74.0	-25.8	1.05 H	26	12.10	36.10
10	4804.00	18.1 AV	54.0	-35.9	1.05 H	26	-18.00	36.10

- REMARKS:**
1. Emission level (dBuV/m) = Raw Value (dBuV) + Correction Factor (dB/m).
 2. Correction Factor (dB/m) = Antenna Factor (dB/m) + Cable Factor (dB).
 3. The other emission levels were very low against the limit.
 4. Margin value = Emission level – Limit value.
 5. “ * “: Fundamental frequency.
 6. The DH5 packet was the worse case duty cycle for a transmit dwell time on a channel, based upon bluetooth theory the transmitter is on 0.625 * 5 per 296.25 ms per channel. Therefore, the duty cycle correlation factor be equal to: $20\log(3.125 / 100) = -30.1$ dB.
 7. Average value = peak reading + $20\log(\text{duty cycle})$.



A D T

EUT TEST CONDITION		MEASUREMENT DETAIL	
CHANNEL	Channel 0	FREQUENCY RANGE	1 ~ 25GHz
INPUT POWER (SYSTEM)	120Vac, 60Hz	DETECTOR FUNCTION	Peak (PK) Average (AV)
ENVIRONMENTAL CONDITIONS	25deg. C, 65%RH 1006 hPa	TESTED BY	Brad Wu
TEST MODE	C1		

ANTENNA POLARITY & TEST DISTANCE: VERTICAL AT 3 M								
NO.	FREQ. (MHz)	EMISSION LEVEL (dBuV/m)	LIMIT (dBuV/m)	MARGIN (dB)	ANTENNA HEIGHT (m)	TABLE ANGLE (Degree)	RAW VALUE (dBuV)	CORRECTION FACTOR (dB/m)
1	2390.00	42.3 PK	74.0	-31.7	1.20 V	224	11.80	30.50
2	2390.00	30.0 AV	54.0	-24.0	1.20 V	224	-0.50	30.50
3	#2398.00	50.0 PK	80.1	-30.1	1.20 V	224	19.50	30.50
4	#2398.00	34.6 AV	50.0	-15.4	1.20 V	224	4.10	30.50
5	#2400.00	45.1 PK	80.1	-35.0	1.20 V	224	14.60	30.50
6	#2400.00	15.0 AV	50.0	-35.0	1.20 V	224	-15.50	30.50
7	*2402.00	100.1 PK			1.20 V	224	69.60	30.50
8	*2402.00	70.0 AV			1.20 V	224	39.50	30.50
9	4804.00	48.1 PK	74.0	-25.9	1.00 V	62	12.00	36.10
10	4804.00	18.0 AV	54.0	-36.0	1.00 V	62	-18.10	36.10

- REMARKS:**
1. Emission level (dBuV/m) = Raw Value (dBuV) + Correction Factor (dB/m).
 2. Correction Factor (dB/m) = Antenna Factor (dB/m) + Cable Factor (dB).
 3. The other emission levels were very low against the limit.
 4. Margin value = Emission level – Limit value.
 5. “ * “: Fundamental frequency.
 6. The DH5 packet was the worse case duty cycle for a transmit dwell time on a channel, based upon bluetooth theory the transmitter is on 0.625 * 5 per 296.25 ms per channel. Therefore, the duty cycle correlation factor be equal to: $20\log(3.125 / 100) = -30.1$ dB.
 7. Average value = peak reading + $20\log(\text{duty cycle})$.
 8. "#": The radiated frequency is out the restricted band.



A D T

BELOW 1GHz WORST-CASE DATA : GFSK

EUT TEST CONDITION		MEASUREMENT DETAIL	
CHANNEL	Channel 0	FREQUENCY RANGE	Below 1000MHz
INPUT POWER (SYSTEM)	120Vac, 60Hz	DETECTOR FUNCTION	Quasi-Peak
ENVIRONMENTAL CONDITIONS	25deg. C, 65%RH 1002 hPa	TESTED BY	Brad Wu
TEST MODE	A1		

ANTENNA POLARITY & TEST DISTANCE: HORIZONTAL AT 3 M								
NO.	FREQ. (MHz)	EMISSION LEVEL (dBuV/m)	LIMIT (dBuV/m)	MARGIN (dB)	ANTENNA HEIGHT (m)	TABLE ANGLE (Degree)	RAW VALUE (dBuV)	CORRECTION FACTOR (dB/m)
1	140.72	23.8 QP	43.5	-19.7	1.50 H	163	10.80	13.00
2	226.27	21.1 QP	46.0	-24.9	1.50 H	106	8.80	12.30
3	344.87	17.7 QP	46.0	-28.3	1.50 H	61	1.90	15.80
4	558.75	20.5 QP	46.0	-25.5	1.50 H	304	-1.20	21.70
5	702.62	24.0 QP	46.0	-22.0	1.50 H	19	-1.10	25.10
6	790.12	24.8 QP	46.0	-21.2	1.00 H	112	-1.20	26.00

ANTENNA POLARITY & TEST DISTANCE: VERTICAL AT 3 M								
NO.	FREQ. (MHz)	EMISSION LEVEL (dBuV/m)	LIMIT (dBuV/m)	MARGIN (dB)	ANTENNA HEIGHT (m)	TABLE ANGLE (Degree)	RAW VALUE (dBuV)	CORRECTION FACTOR (dB/m)
1	53.23	29.0 QP	40.0	-11.0	1.50 V	136	15.90	13.10
2	96.01	22.4 QP	43.5	-21.1	1.00 V	280	12.20	10.20
3	140.72	21.6 QP	43.5	-21.9	1.50 V	133	8.50	13.10
4	490.70	20.2 QP	46.0	-25.8	1.00 V	10	-0.10	20.30
5	698.74	23.7 QP	46.0	-22.3	1.50 V	301	-1.40	25.10
6	778.45	24.8 QP	46.0	-21.2	2.00 V	292	-1.00	25.80

- REMARKS:**
1. Emission level (dBuV/m) = Raw Value (dBuV) + Correction Factor (dB/m).
 2. Correction Factor (dB/m) = Antenna Factor (dB/m) + Cable Factor (dB).
 3. The other emission levels were very low against the limit.
 4. Margin value = Emission level – Limit value.



A D T

EUT TEST CONDITION		MEASUREMENT DETAIL	
CHANNEL	Channel 0	FREQUENCY RANGE	Below 1000MHz
INPUT POWER (SYSTEM)	120Vac, 60Hz	DETECTOR FUNCTION	Quasi-Peak
ENVIRONMENTAL CONDITIONS	25deg. C, 65%RH 1002 hPa	TESTED BY	Brad Wu
TEST MODE	A2		

ANTENNA POLARITY & TEST DISTANCE: HORIZONTAL AT 3 M								
NO.	FREQ. (MHz)	EMISSION LEVEL (dBuV/m)	LIMIT (dBuV/m)	MARGIN (dB)	ANTENNA HEIGHT (m)	TABLE ANGLE (Degree)	RAW VALUE (dBuV)	CORRECTION FACTOR (dB/m)
1	132.95	32.3 QP	43.5	-11.2	1.50 H	298	19.90	12.40
2	255.44	34.6 QP	46.0	-11.4	1.00 H	271	20.70	13.90
3	309.88	33.8 QP	46.0	-12.2	1.00 H	316	19.60	14.20
4	465.42	31.6 QP	46.0	-14.4	1.50 H	355	11.90	19.70
5	558.75	32.6 QP	46.0	-13.4	1.00 H	265	10.90	21.70
6	865.94	31.5 QP	46.0	-14.5	1.00 H	121	4.20	27.30
ANTENNA POLARITY & TEST DISTANCE: VERTICAL AT 3 M								
NO.	FREQ. (MHz)	EMISSION LEVEL (dBuV/m)	LIMIT (dBuV/m)	MARGIN (dB)	ANTENNA HEIGHT (m)	TABLE ANGLE (Degree)	RAW VALUE (dBuV)	CORRECTION FACTOR (dB/m)
1	53.23	31.8 QP	40.0	-8.2	1.50 V	181	18.70	13.10
2	132.95	31.9 QP	43.5	-11.6	1.00 V	304	19.50	12.40
3	224.33	34.0 QP	46.0	-12.0	1.50 V	10	21.80	12.20
4	313.77	31.8 QP	46.0	-14.2	1.50 V	304	17.40	14.40
5	465.42	34.1 QP	46.0	-11.9	1.50 V	91	14.40	19.70
6	864.00	31.1 QP	46.0	-14.9	1.50 V	223	3.80	27.30

- REMARKS:**
1. Emission level (dBuV/m) = Raw Value (dBuV) + Correction Factor (dB/m).
 2. Correction Factor (dB/m) = Antenna Factor (dB/m) + Cable Factor (dB).
 3. The other emission levels were very low against the limit.
 4. Margin value = Emission level – Limit value.



A D T

EUT TEST CONDITION		MEASUREMENT DETAIL	
CHANNEL	Channel 0	FREQUENCY RANGE	Below 1000MHz
INPUT POWER (SYSTEM)	120Vac, 60Hz	DETECTOR FUNCTION	Quasi-Peak
ENVIRONMENTAL CONDITIONS	25deg. C, 65%RH 1002 hPa	TESTED BY	Brad Wu
TEST MODE	B1		

ANTENNA POLARITY & TEST DISTANCE: HORIZONTAL AT 3 M								
NO.	FREQ. (MHz)	EMISSION LEVEL (dBuV/m)	LIMIT (dBuV/m)	MARGIN (dB)	ANTENNA HEIGHT (m)	TABLE ANGLE (Degree)	RAW VALUE (dBuV)	CORRECTION FACTOR (dB/m)
1	37.68	20.5 QP	40.0	-19.5	1.50 H	298	5.70	14.80
2	173.78	16.4 QP	43.5	-27.1	1.50 H	256	2.90	13.50
3	247.66	20.1 QP	46.0	-25.9	1.00 H	265	6.40	13.70
4	428.48	18.7 QP	46.0	-27.3	1.50 H	55	-0.10	18.80
5	622.91	22.4 QP	46.0	-23.6	1.00 H	259	-0.70	23.10
6	803.73	25.4 QP	46.0	-20.6	1.00 H	214	-0.70	26.10
ANTENNA POLARITY & TEST DISTANCE: VERTICAL AT 3 M								
NO.	FREQ. (MHz)	EMISSION LEVEL (dBuV/m)	LIMIT (dBuV/m)	MARGIN (dB)	ANTENNA HEIGHT (m)	TABLE ANGLE (Degree)	RAW VALUE (dBuV)	CORRECTION FACTOR (dB/m)
1	33.80	30.0 QP	40.0	-10.0	1.00 V	217	16.20	13.80
2	53.23	28.1 QP	40.0	-11.9	1.00 V	166	15.00	13.10
3	99.89	24.9 QP	43.5	-18.6	1.00 V	10	13.30	11.60
4	222.38	18.3 QP	46.0	-27.7	1.50 V	358	6.30	12.00
5	654.02	23.1 QP	46.0	-22.9	1.00 V	250	-0.80	23.90
6	865.94	27.4 QP	46.0	-18.6	1.00 V	10	0.10	27.30

- REMARKS:**
1. Emission level (dBuV/m) = Raw Value (dBuV) + Correction Factor (dB/m).
 2. Correction Factor (dB/m) = Antenna Factor (dB/m) + Cable Factor (dB).
 3. The other emission levels were very low against the limit.
 4. Margin value = Emission level – Limit value.



A D T

EUT TEST CONDITION		MEASUREMENT DETAIL	
CHANNEL	Channel 0	FREQUENCY RANGE	Below 1000MHz
INPUT POWER (SYSTEM)	120Vac, 60Hz	DETECTOR FUNCTION	Quasi-Peak
ENVIRONMENTAL CONDITIONS	25deg. C, 65%RH 1002 hPa	TESTED BY	Brad Wu
TEST MODE	B2		

ANTENNA POLARITY & TEST DISTANCE: HORIZONTAL AT 3 M								
NO.	FREQ. (MHz)	EMISSION LEVEL (dBuV/m)	LIMIT (dBuV/m)	MARGIN (dB)	ANTENNA HEIGHT (m)	TABLE ANGLE (Degree)	RAW VALUE (dBuV)	CORRECTION FACTOR (dB/m)
1	134.89	32.3 QP	43.5	-11.2	1.50 H	217	19.70	12.60
2	300.16	26.9 QP	46.0	-19.1	1.00 H	58	13.10	13.80
3	432.37	33.6 QP	46.0	-12.4	1.50 H	91	14.70	18.90
4	463.48	31.1 QP	46.0	-14.9	1.50 H	85	11.40	19.70
5	632.63	29.9 QP	46.0	-16.1	1.50 H	160	6.50	23.40
6	862.06	30.7 QP	46.0	-15.3	1.50 H	136	3.50	27.20

ANTENNA POLARITY & TEST DISTANCE: VERTICAL AT 3 M								
NO.	FREQ. (MHz)	EMISSION LEVEL (dBuV/m)	LIMIT (dBuV/m)	MARGIN (dB)	ANTENNA HEIGHT (m)	TABLE ANGLE (Degree)	RAW VALUE (dBuV)	CORRECTION FACTOR (dB/m)
1	53.23	32.0 QP	40.0	-8.0	1.00 V	145	18.90	13.10
2	144.61	29.4 QP	43.5	-14.1	1.00 V	142	15.90	13.50
3	249.60	27.0 QP	46.0	-19.0	1.50 V	91	13.10	13.90
4	463.48	31.2 QP	46.0	-14.8	1.00 V	55	11.50	19.70
5	500.42	31.1 QP	46.0	-14.9	1.50 V	10	10.60	20.50
6	566.52	29.7 QP	46.0	-16.3	1.00 V	271	7.90	21.80

- REMARKS:**
1. Emission level (dBuV/m) = Raw Value (dBuV) + Correction Factor (dB/m).
 2. Correction Factor (dB/m) = Antenna Factor (dB/m) + Cable Factor (dB).
 3. The other emission levels were very low against the limit.
 4. Margin value = Emission level – Limit value.



A D T

EUT TEST CONDITION		MEASUREMENT DETAIL	
CHANNEL	Channel 0	FREQUENCY RANGE	Below 1000MHz
INPUT POWER (SYSTEM)	120Vac, 60Hz	DETECTOR FUNCTION	Quasi-Peak
ENVIRONMENTAL CONDITIONS	25deg. C, 65%RH 1006 hPa	TESTED BY	Brad Wu
TEST MODE	C1		

ANTENNA POLARITY & TEST DISTANCE: HORIZONTAL AT 3 M								
NO.	FREQ. (MHz)	EMISSION LEVEL (dBuV/m)	LIMIT (dBuV/m)	MARGIN (dB)	ANTENNA HEIGHT (m)	TABLE ANGLE (Degree)	RAW VALUE (dBuV)	CORRECTION FACTOR (dB/m)
1	37.68	19.7 QP	40.0	-20.3	1.50 H	238	4.90	14.80
2	127.11	21.6 QP	43.5	-21.9	1.50 H	355	9.70	11.90
3	173.78	16.6 QP	43.5	-26.9	1.50 H	241	3.10	13.50
4	424.59	19.3 QP	46.0	-26.7	1.50 H	55	0.60	18.70
5	646.24	22.6 QP	46.0	-23.4	1.00 H	82	-1.10	23.70
6	782.34	24.7 QP	46.0	-21.3	1.50 H	1	-1.20	25.90

ANTENNA POLARITY & TEST DISTANCE: VERTICAL AT 3 M								
NO.	FREQ. (MHz)	EMISSION LEVEL (dBuV/m)	LIMIT (dBuV/m)	MARGIN (dB)	ANTENNA HEIGHT (m)	TABLE ANGLE (Degree)	RAW VALUE (dBuV)	CORRECTION FACTOR (dB/m)
1	53.23	28.7 QP	40.0	-11.3	1.00 V	163	15.60	13.10
2	96.01	25.4 QP	43.5	-18.1	1.00 V	295	15.20	10.20
3	204.89	18.7 QP	43.5	-24.8	1.50 V	73	7.90	10.80
4	453.75	18.5 QP	46.0	-27.5	1.00 V	10	-0.90	19.40
5	681.24	23.4 QP	46.0	-22.6	1.00 V	88	-1.20	24.60
6	807.62	26.0 QP	46.0	-20.0	1.00 V	220	-0.20	26.20

- REMARKS:**
1. Emission level (dBuV/m) = Raw Value (dBuV) + Correction Factor (dB/m).
 2. Correction Factor (dB/m) = Antenna Factor (dB/m) + Cable Factor (dB).
 3. The other emission levels were very low against the limit.
 4. Margin value = Emission level – Limit value.



A D T

EUT TEST CONDITION		MEASUREMENT DETAIL	
CHANNEL	Channel 0	FREQUENCY RANGE	Below 1000MHz
INPUT POWER (SYSTEM)	120Vac, 60Hz	DETECTOR FUNCTION	Quasi-Peak
ENVIRONMENTAL CONDITIONS	25deg. C, 65%RH 1006 hPa	TESTED BY	Brad Wu
TEST MODE	C2		

ANTENNA POLARITY & TEST DISTANCE: HORIZONTAL AT 3 M								
NO.	FREQ. (MHz)	EMISSION LEVEL (dBuV/m)	LIMIT (dBuV/m)	MARGIN (dB)	ANTENNA HEIGHT (m)	TABLE ANGLE (Degree)	RAW VALUE (dBuV)	CORRECTION FACTOR (dB/m)
1	80.45	26.1 QP	40.0	-13.9	1.50 H	25	18.00	8.10
2	132.95	29.9 QP	43.5	-13.6	1.00 H	10	17.50	12.40
3	177.67	31.8 QP	43.5	-11.7	1.00 H	10	19.30	12.50
4	397.37	31.6 QP	46.0	-14.4	1.00 H	247	13.60	18.00
5	630.69	32.9 QP	46.0	-13.1	1.00 H	118	9.60	23.30
6	811.50	31.2 QP	46.0	-14.8	1.00 H	34	4.90	26.30
ANTENNA POLARITY & TEST DISTANCE: VERTICAL AT 3 M								
NO.	FREQ. (MHz)	EMISSION LEVEL (dBuV/m)	LIMIT (dBuV/m)	MARGIN (dB)	ANTENNA HEIGHT (m)	TABLE ANGLE (Degree)	RAW VALUE (dBuV)	CORRECTION FACTOR (dB/m)
1	53.23	31.4 QP	40.0	-8.6	1.00 V	154	18.30	13.10
2	144.61	28.4 QP	43.5	-15.1	1.00 V	109	14.90	13.50
3	467.36	31.3 QP	46.0	-14.7	1.00 V	61	11.60	19.70
4	566.52	31.4 QP	46.0	-14.6	1.00 V	262	9.60	21.80
5	731.79	31.1 QP	46.0	-14.9	1.50 V	10	5.70	25.40
6	795.95	35.9 QP	46.0	-10.1	1.00 V	106	9.90	26.00

- REMARKS:**
1. Emission level (dBuV/m) = Raw Value (dBuV) + Correction Factor (dB/m).
 2. Correction Factor (dB/m) = Antenna Factor (dB/m) + Cable Factor (dB).
 3. The other emission levels were very low against the limit.
 4. Margin value = Emission level – Limit value.

4.2 CONDUCTED EMISSION MEASUREMENT

4.2.1 LIMITS OF CONDUCTED EMISSION MEASUREMENT

FREQUENCY OF EMISSION (MHz)	CONDUCTED LIMIT (dB μ V)	
	Quasi-peak	Average
0.15 ~ 0.5	66 to 56	56 to 46
0.5 ~ 5	56	46
5 ~ 30	60	50

- NOTE:**
1. The lower limit shall apply at the transition frequencies.
 2. The limit decreases in line with the logarithm of the frequency in the range of 0.15 to 0.50 MHz.
 3. All emanations from a class A/B digital device or system, including any network of conductors and apparatus connected thereto, shall not exceed the level of field strengths specified above.

4.2.2 TEST INSTRUMENTS

DESCRIPTION & MANUFACTURER	MODEL NO.	SERIAL NO.	DATE OF CALIBRATION	DUE DATE OF CALIBRATION
Test Receiver ROHDE & SCHWARZ	ESCS30	100291	Dec. 16, 2009	Dec. 15, 2010
RF signal cable Woken	5D-FB	Cable-HYC01-01	Nov. 12, 2009	Nov. 11, 2010
LISN SCHWARZBECK	NNBL 8226-2	8226-142	Jun. 12, 2010	Jun. 12, 2011
LISN ROHDE & SCHWARZ	ESH3-Z5	835239/001	Feb. 10, 2010	Feb. 09, 2011
Software ADT	ADT_Cond_ V7.3.7	NA	NA	NA

- NOTE:**
1. The calibration interval of the above test instruments is 12 months and the calibrations are traceable to NML/ROC and NIST/USA.
 2. The test was performed in HwaYa Shielded Room 1.
 3. The VCCI Site Registration No. is C-2040.

4.2.3 TEST PROCEDURES

- a. The EUT was placed 0.4 meters from the conducting wall of the shielded room with EUT being connected to the power mains through a line impedance stabilization network (LISN). Other support units were connected to the power mains through another LISN. The two LISNs provide 50 ohm/ 50uH of coupling impedance for the measuring instrument.
- b. Both lines of the power mains connected to the EUT were checked for maximum conducted interference.
- c. The frequency range from 150kHz to 30MHz was searched. Emission levels under (Limit - 20dB) was not recorded.

NOTE: All modes of operation were investigated and the worst-case emissions are reported.

4.2.4 DEVIATION FROM TEST STANDARD

No deviation

4.2.5 TEST SETUP

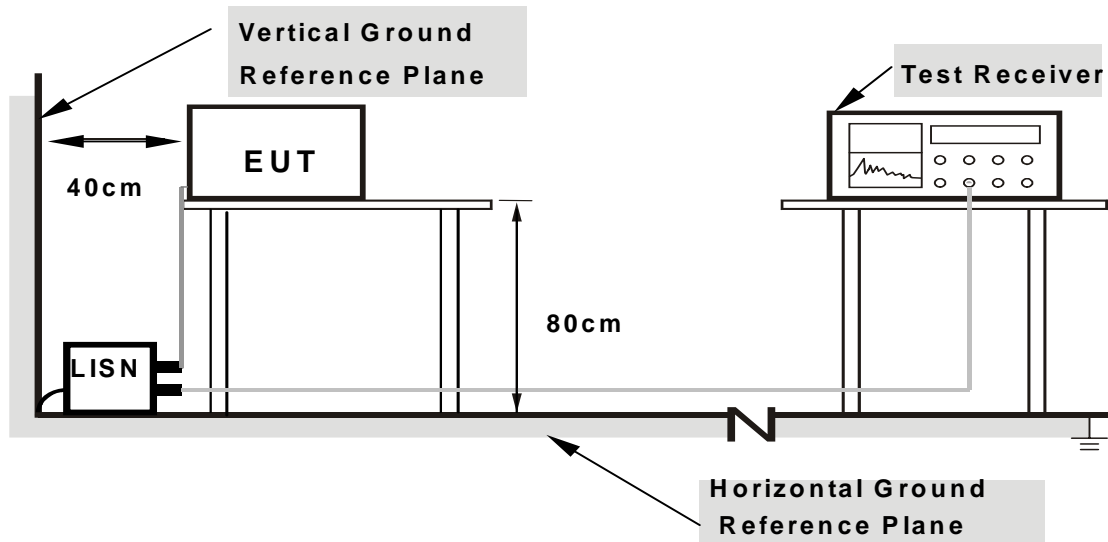

- Note:**
1. Support units were connected to second LISN.
 2. Both of LISNs (AMN) are 80 cm from EUT and at least 80 from other units and other metal planes

For the actual test configuration, please refer to the attached file (Test Setup Photo).

4.2.6 EUT OPERATING CONDITIONS

Same as 4.1.6



A D T

4.2.7 TEST RESULTS

CONDUCTED WORST CASE DATA: GFSK

PHASE	Line 1	6dB BANDWIDTH	9kHz
TEST MODE	A1		

No	Freq. [MHz]	Corr. Factor (dB)	Reading Value		Emission Level		Limit		Margin	
			[dB (uV)]		[dB (uV)]		[dB (uV)]		(dB)	
			Q.P.	AV.	Q.P.	AV.	Q.P.	AV.	Q.P.	AV.
1	0.154	0.12	43.94	-	44.06	-	65.79	55.79	-21.73	-
2	0.322	0.12	40.75	-	40.87	-	59.66	49.66	-18.79	-
3	0.533	0.14	34.95	-	35.09	-	56.00	46.00	-20.91	-
4	0.654	0.15	36.31	-	36.46	-	56.00	46.00	-19.54	-
5	1.496	0.21	37.40	-	37.61	-	56.00	46.00	-18.39	-
6	2.922	0.30	32.65	-	32.95	-	56.00	46.00	-23.05	-

- REMARKS:**
1. Q.P. and AV. are abbreviations of quasi-peak and average individually.
 2. "-": The Quasi-peak reading value also meets average limit and measurement with the average detector is unnecessary.
 3. The emission levels of other frequencies were very low against the limit.
 4. Margin value = Emission level - Limit value
 5. Correction factor = Insertion loss + Cable loss
 6. Emission Level = Correction Factor + Reading Value.

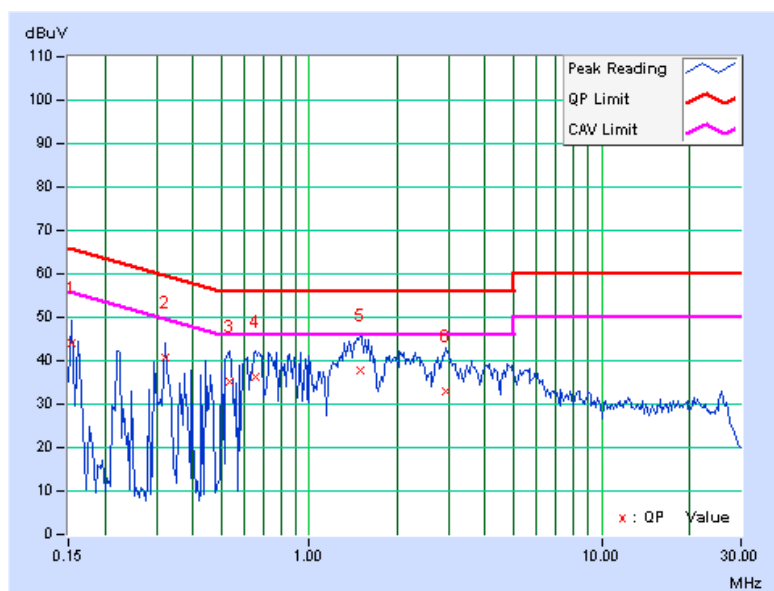



A D T

PHASE	Line 2	6dB BANDWIDTH	9kHz
TEST MODE	A1		

No	Freq. [MHz]	Corr. Factor (dB)	Reading Value		Emission Level		Limit		Margin	
			[dB (uV)]		[dB (uV)]		[dB (uV)]		(dB)	
			Q.P.	AV.	Q.P.	AV.	Q.P.	AV.	Q.P.	AV.
1	0.170	0.10	33.56	-	33.66	-	64.98	54.98	-31.32	-
2	0.216	0.10	35.89	-	35.99	-	62.96	52.96	-26.96	-
3	0.357	0.12	32.25	-	32.37	-	58.80	48.80	-26.43	-
4	0.459	0.12	30.61	-	30.73	-	56.72	46.72	-25.98	-
5	0.607	0.14	31.05	-	31.19	-	56.00	46.00	-24.81	-
6	1.367	0.20	32.63	-	32.83	-	56.00	46.00	-23.17	-

- REMARKS:**
1. Q.P. and AV. are abbreviations of quasi-peak and average individually.
 2. "-": The Quasi-peak reading value also meets average limit and measurement with the average detector is unnecessary.
 3. The emission levels of other frequencies were very low against the limit.
 4. Margin value = Emission level - Limit value
 5. Correction factor = Insertion loss + Cable loss
 6. Emission Level = Correction Factor + Reading Value.

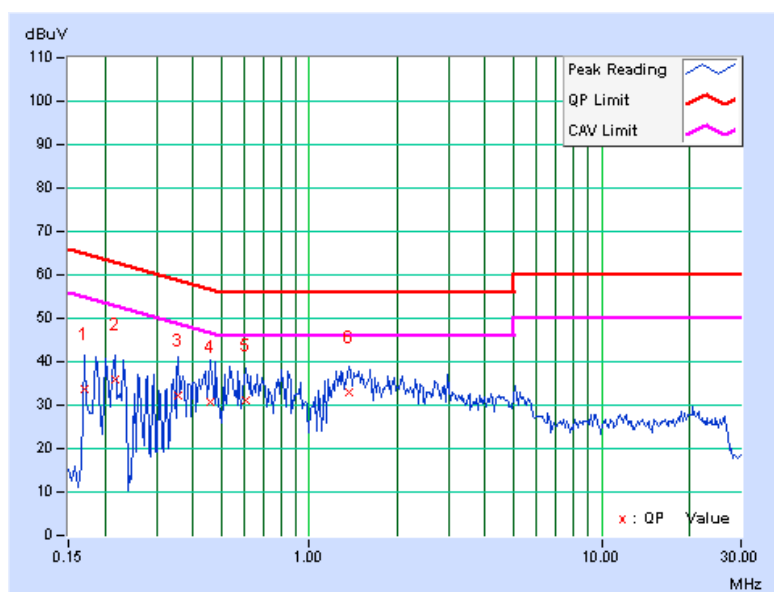

PHASE	Line 1	6dB BANDWIDTH	9kHz
TEST MODE	A2		

No	Freq. [MHz]	Corr. Factor (dB)	Reading Value		Emission Level		Limit		Margin	
			[dB (uV)]		[dB (uV)]		[dB (uV)]		(dB)	
			Q.P.	AV.	Q.P.	AV.	Q.P.	AV.	Q.P.	AV.
1	0.150	0.12	27.26	-	27.38	-	66.00	56.00	-38.62	-
2	0.255	0.12	39.10	-	39.22	-	61.58	51.58	-22.36	-
3	0.306	0.12	38.95	-	39.07	-	60.07	50.07	-21.00	-
4	1.180	0.19	28.26	-	28.45	-	56.00	46.00	-27.55	-
5	1.793	0.24	30.87	-	31.11	-	56.00	46.00	-24.89	-
6	3.477	0.32	27.77	-	28.09	-	56.00	46.00	-27.91	-

- REMARKS:**
1. Q.P. and AV. are abbreviations of quasi-peak and average individually.
 2. "-": The Quasi-peak reading value also meets average limit and measurement with the average detector is unnecessary.
 3. The emission levels of other frequencies were very low against the limit.
 4. Margin value = Emission level - Limit value
 5. Correction factor = Insertion loss + Cable loss
 6. Emission Level = Correction Factor + Reading Value.

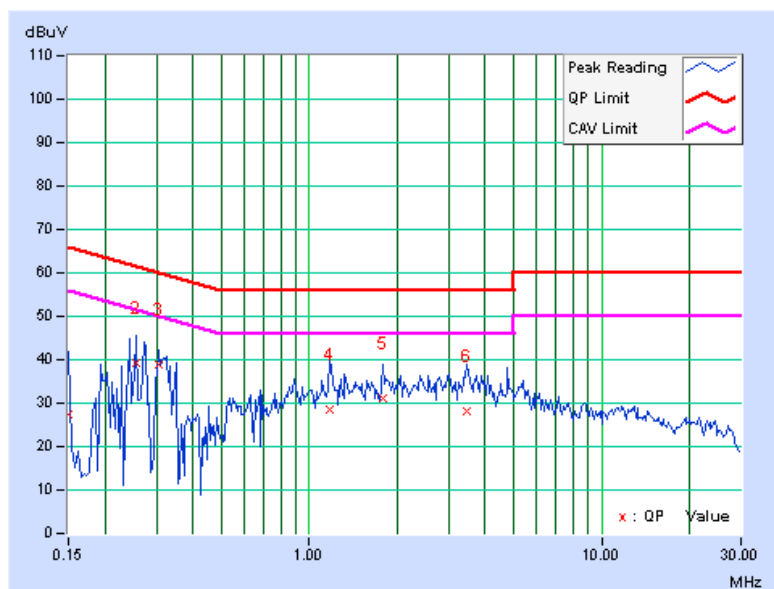

PHASE	Line 2	6dB BANDWIDTH	9kHz
TEST MODE	A2		

No	Freq. [MHz]	Corr. Factor (dB)	Reading Value		Emission Level		Limit		Margin	
			[dB (uV)]		[dB (uV)]		[dB (uV)]		(dB)	
			Q.P.	AV.	Q.P.	AV.	Q.P.	AV.	Q.P.	AV.
1	0.189	0.10	44.52	-	44.62	-	64.08	54.08	-19.46	-
2	0.308	0.11	39.06	-	39.17	-	60.04	50.04	-20.87	-
3	1.277	0.19	31.18	-	31.37	-	56.00	46.00	-24.63	-
4	1.578	0.21	29.63	-	29.84	-	56.00	46.00	-26.16	-
5	2.254	0.25	30.14	-	30.39	-	56.00	46.00	-25.61	-
6	3.785	0.31	28.46	-	28.77	-	56.00	46.00	-27.23	-

- REMARKS:**
1. Q.P. and AV. are abbreviations of quasi-peak and average individually.
 2. "-": The Quasi-peak reading value also meets average limit and measurement with the average detector is unnecessary.
 3. The emission levels of other frequencies were very low against the limit.
 4. Margin value = Emission level - Limit value
 5. Correction factor = Insertion loss + Cable loss
 6. Emission Level = Correction Factor + Reading Value.

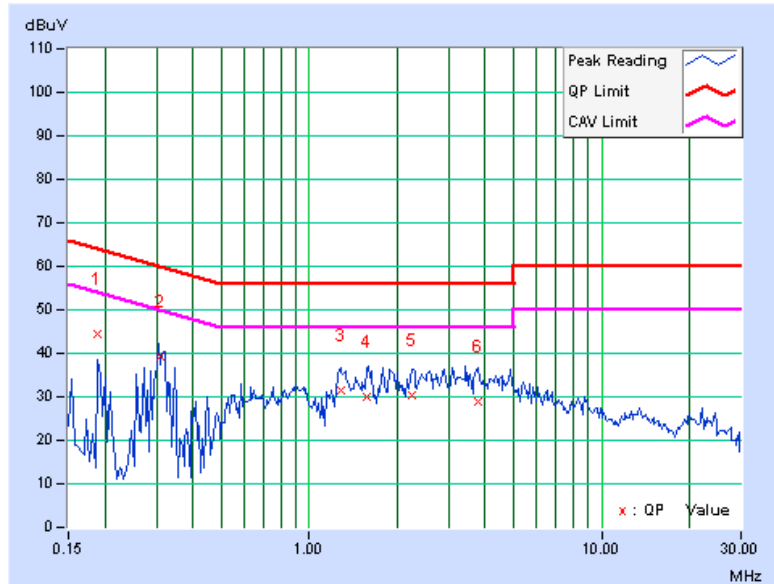

PHASE	Line 1	6dB BANDWIDTH	9kHz
TEST MODE	B1		

No	Freq. [MHz]	Corr. Factor (dB)	Reading Value		Emission Level		Limit		Margin	
			[dB (uV)]		[dB (uV)]		[dB (uV)]		(dB)	
			Q.P.	AV.	Q.P.	AV.	Q.P.	AV.	Q.P.	AV.
1	0.170	0.12	42.68	-	42.80	-	64.98	54.98	-22.19	-
2	0.396	0.13	38.15	-	38.28	-	57.93	47.93	-19.66	-
3	0.810	0.16	31.57	-	31.73	-	56.00	46.00	-24.27	-
4	1.477	0.21	35.28	-	35.49	-	56.00	46.00	-20.51	-
5	3.051	0.30	29.93	-	30.23	-	56.00	46.00	-25.77	-
6	4.715	0.38	32.18	-	32.56	-	56.00	46.00	-23.44	-

- REMARKS:**
1. Q.P. and AV. are abbreviations of quasi-peak and average individually.
 2. "-": The Quasi-peak reading value also meets average limit and measurement with the average detector is unnecessary.
 3. The emission levels of other frequencies were very low against the limit.
 4. Margin value = Emission level - Limit value
 5. Correction factor = Insertion loss + Cable loss
 6. Emission Level = Correction Factor + Reading Value.

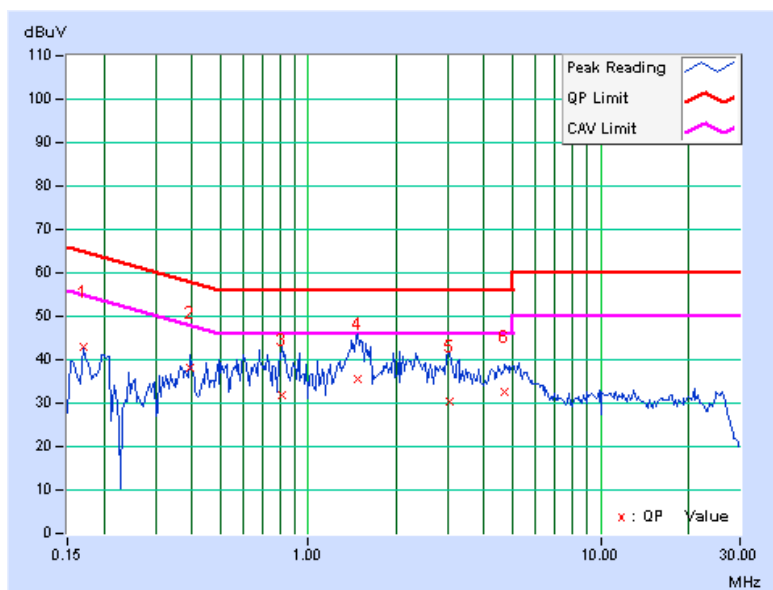

PHASE	Line 2	6dB BANDWIDTH	9kHz
TEST MODE	B1		

No	Freq. [MHz]	Corr. Factor (dB)	Reading Value		Emission Level		Limit		Margin	
			[dB (uV)]		[dB (uV)]		[dB (uV)]		(dB)	
			Q.P.	AV.	Q.P.	AV.	Q.P.	AV.	Q.P.	AV.
1	0.158	0.10	39.85	-	39.95	-	65.58	55.58	-25.63	-
2	0.205	0.10	43.20	-	43.30	-	63.42	53.42	-20.12	-
3	0.377	0.12	32.34	-	32.46	-	58.35	48.35	-25.90	-
4	0.970	0.17	27.09	-	27.26	-	56.00	46.00	-28.74	-
5	1.520	0.21	28.59	-	28.80	-	56.00	46.00	-27.20	-
6	1.898	0.23	26.86	-	27.09	-	56.00	46.00	-28.91	-

- REMARKS:**
1. Q.P. and AV. are abbreviations of quasi-peak and average individually.
 2. "-": The Quasi-peak reading value also meets average limit and measurement with the average detector is unnecessary.
 3. The emission levels of other frequencies were very low against the limit.
 4. Margin value = Emission level - Limit value
 5. Correction factor = Insertion loss + Cable loss
 6. Emission Level = Correction Factor + Reading Value.

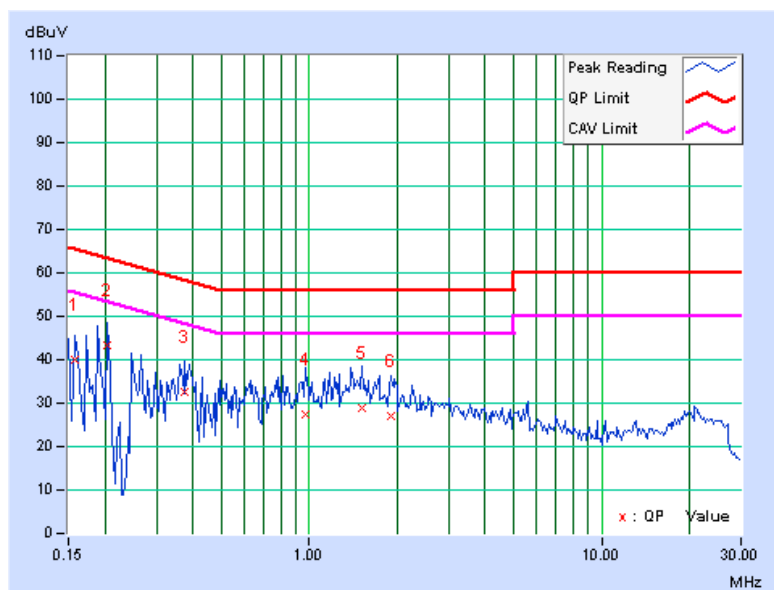

PHASE	Line 1	6dB BANDWIDTH	9kHz
TEST MODE	B2		

No	Freq. [MHz]	Corr. Factor (dB)	Reading Value		Emission Level		Limit		Margin	
			[dB (uV)]		[dB (uV)]		[dB (uV)]		(dB)	
			Q.P.	AV.	Q.P.	AV.	Q.P.	AV.	Q.P.	AV.
1	0.193	0.11	35.14	-	35.25	-	63.91	53.91	-28.66	-
2	0.255	0.12	36.30	-	36.42	-	61.58	51.58	-25.16	-
3	0.314	0.12	38.55	-	38.67	-	59.86	49.86	-21.19	-
4	1.305	0.20	31.51	-	31.71	-	56.00	46.00	-24.29	-
5	1.918	0.24	30.99	-	31.23	-	56.00	46.00	-24.77	-
6	4.844	0.39	28.24	-	28.63	-	56.00	46.00	-27.37	-

- REMARKS:**
1. Q.P. and AV. are abbreviations of quasi-peak and average individually.
 2. "-": The Quasi-peak reading value also meets average limit and measurement with the average detector is unnecessary.
 3. The emission levels of other frequencies were very low against the limit.
 4. Margin value = Emission level - Limit value
 5. Correction factor = Insertion loss + Cable loss
 6. Emission Level = Correction Factor + Reading Value.

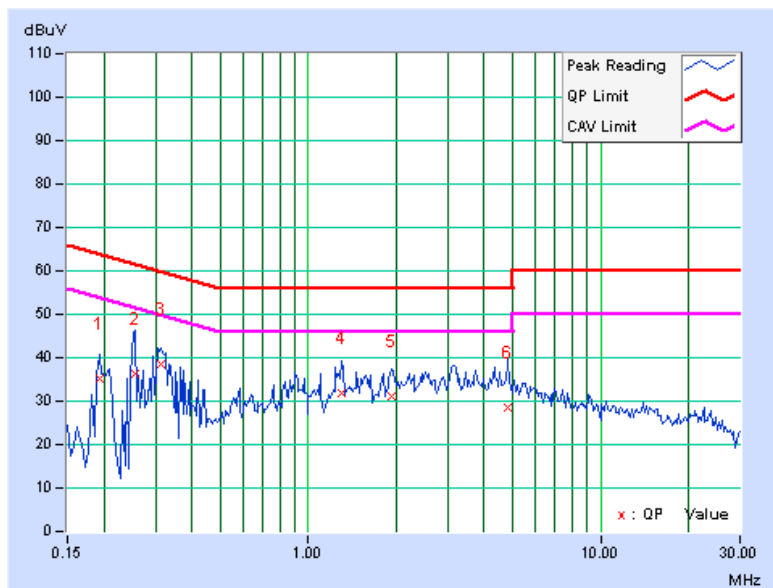

PHASE	Line 2	6dB BANDWIDTH	9kHz
TEST MODE	B2		

No	Freq. [MHz]	Corr. Factor (dB)	Reading Value		Emission Level		Limit		Margin	
			[dB (uV)]		[dB (uV)]		[dB (uV)]		(dB)	
			Q.P.	AV.	Q.P.	AV.	Q.P.	AV.	Q.P.	AV.
1	0.197	0.10	33.16	-	33.26	-	63.74	53.74	-30.48	-
2	0.252	0.11	29.29	-	29.40	-	61.71	51.71	-32.31	-
3	0.302	0.11	39.39	-	39.50	-	60.18	50.18	-20.68	-
4	0.716	0.15	27.05	-	27.20	-	56.00	46.00	-28.80	-
5	1.266	0.19	30.11	-	30.30	-	56.00	46.00	-25.70	-
6	2.535	0.26	30.80	-	31.06	-	56.00	46.00	-24.94	-

- REMARKS:**
1. Q.P. and AV. are abbreviations of quasi-peak and average individually.
 2. "-": The Quasi-peak reading value also meets average limit and measurement with the average detector is unnecessary.
 3. The emission levels of other frequencies were very low against the limit.
 4. Margin value = Emission level - Limit value
 5. Correction factor = Insertion loss + Cable loss
 6. Emission Level = Correction Factor + Reading Value.

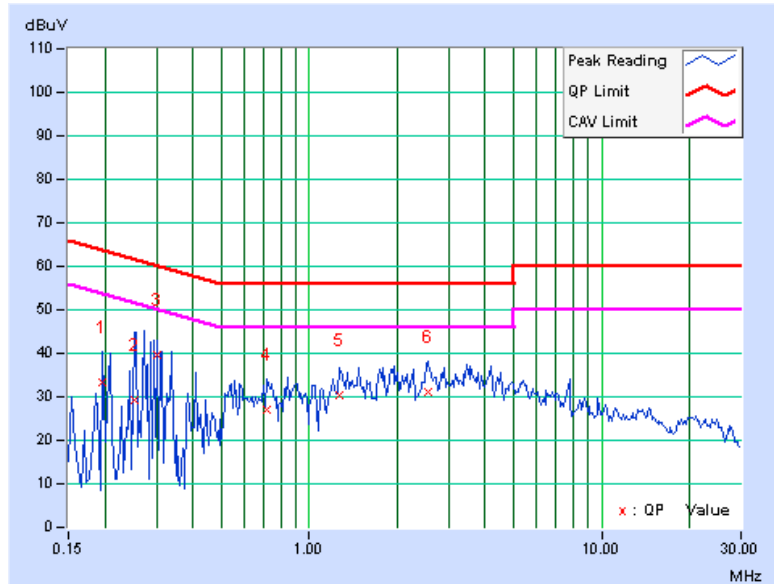

PHASE	Line 1	6dB BANDWIDTH	9kHz
TEST MODE	C1		

No	Freq. [MHz]	Corr. Factor (dB)	Reading Value		Emission Level		Limit		Margin	
			[dB (uV)]		[dB (uV)]		[dB (uV)]		(dB)	
			Q.P.	AV.	Q.P.	AV.	Q.P.	AV.	Q.P.	AV.
1	0.259	0.12	39.78	-	39.90	-	61.45	51.45	-21.56	-
2	0.533	0.14	36.34	-	36.48	-	56.00	46.00	-19.52	-
3	0.728	0.16	33.62	-	33.78	-	56.00	46.00	-22.22	-
4	1.305	0.20	36.52	-	36.72	-	56.00	46.00	-19.28	-
5	2.109	0.26	29.34	-	29.60	-	56.00	46.00	-26.40	-
6	4.953	0.40	23.96	-	24.36	-	56.00	46.00	-31.64	-

- REMARKS:**
1. Q.P. and AV. are abbreviations of quasi-peak and average individually.
 2. "-": The Quasi-peak reading value also meets average limit and measurement with the average detector is unnecessary.
 3. The emission levels of other frequencies were very low against the limit.
 4. Margin value = Emission level - Limit value
 5. Correction factor = Insertion loss + Cable loss
 6. Emission Level = Correction Factor + Reading Value.

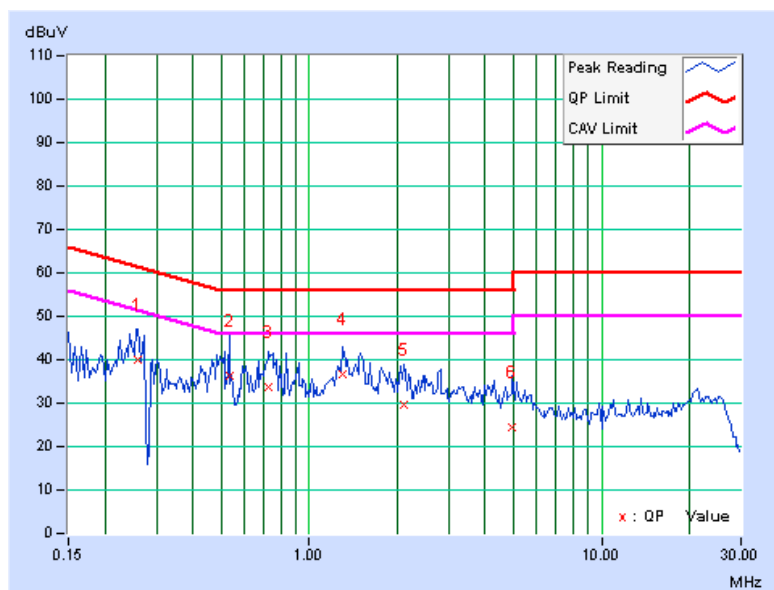



A D T

PHASE	Line 2	6dB BANDWIDTH	9kHz
TEST MODE	C1		

No	Freq. [MHz]	Corr. Factor (dB)	Reading Value		Emission Level		Limit		Margin	
			[dB (uV)]		[dB (uV)]		[dB (uV)]		(dB)	
			Q.P.	AV.	Q.P.	AV.	Q.P.	AV.	Q.P.	AV.
1	0.267	0.11	41.64	-	41.75	-	61.20	51.20	-19.46	-
2	0.545	0.13	34.09	-	34.22	-	56.00	46.00	-21.78	-
3	1.230	0.19	25.28	-	25.47	-	56.00	46.00	-30.53	-
4	1.723	0.22	24.67	-	24.89	-	56.00	46.00	-31.11	-
5	2.547	0.26	24.44	-	24.70	-	56.00	46.00	-31.30	-
6	4.609	0.34	18.60	-	18.94	-	56.00	46.00	-37.06	-

- REMARKS:**
1. Q.P. and AV. are abbreviations of quasi-peak and average individually.
 2. "-": The Quasi-peak reading value also meets average limit and measurement with the average detector is unnecessary.
 3. The emission levels of other frequencies were very low against the limit.
 4. Margin value = Emission level - Limit value
 5. Correction factor = Insertion loss + Cable loss
 6. Emission Level = Correction Factor + Reading Value.

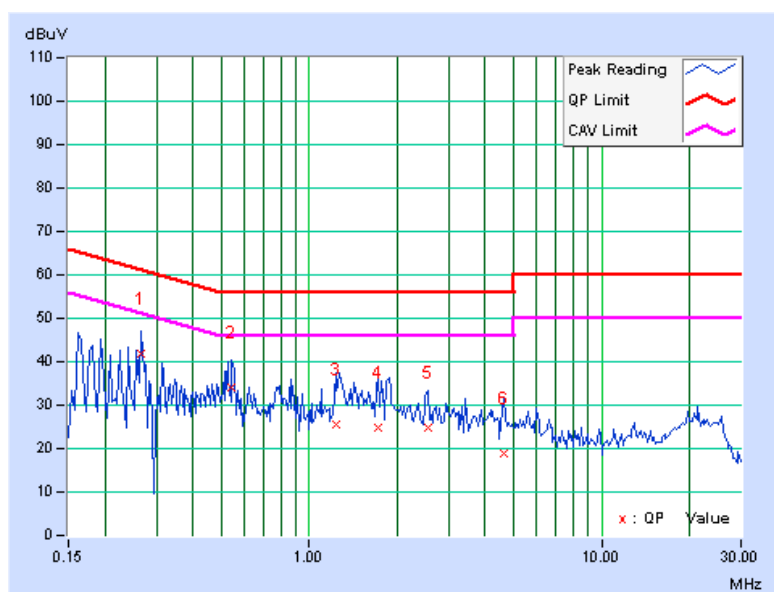

PHASE	Line 1	6dB BANDWIDTH	9kHz
TEST MODE	C2		

No	Freq. [MHz]	Corr. Factor (dB)	Reading Value		Emission Level		Limit		Margin	
			[dB (uV)]		[dB (uV)]		[dB (uV)]		(dB)	
			Q.P.	AV.	Q.P.	AV.	Q.P.	AV.	Q.P.	AV.
1	0.197	0.11	34.91	-	35.02	-	63.74	53.74	-28.72	-
2	0.310	0.12	38.88	-	39.00	-	59.97	49.97	-20.97	-
3	0.591	0.15	29.39	-	29.54	-	56.00	46.00	-26.46	-
4	1.293	0.20	32.85	-	33.05	-	56.00	46.00	-22.95	-
5	1.879	0.24	29.88	-	30.12	-	56.00	46.00	-25.88	-
6	3.379	0.32	29.18	-	29.50	-	56.00	46.00	-26.50	-

- REMARKS:**
1. Q.P. and AV. are abbreviations of quasi-peak and average individually.
 2. "-": The Quasi-peak reading value also meets average limit and measurement with the average detector is unnecessary.
 3. The emission levels of other frequencies were very low against the limit.
 4. Margin value = Emission level - Limit value
 5. Correction factor = Insertion loss + Cable loss
 6. Emission Level = Correction Factor + Reading Value.

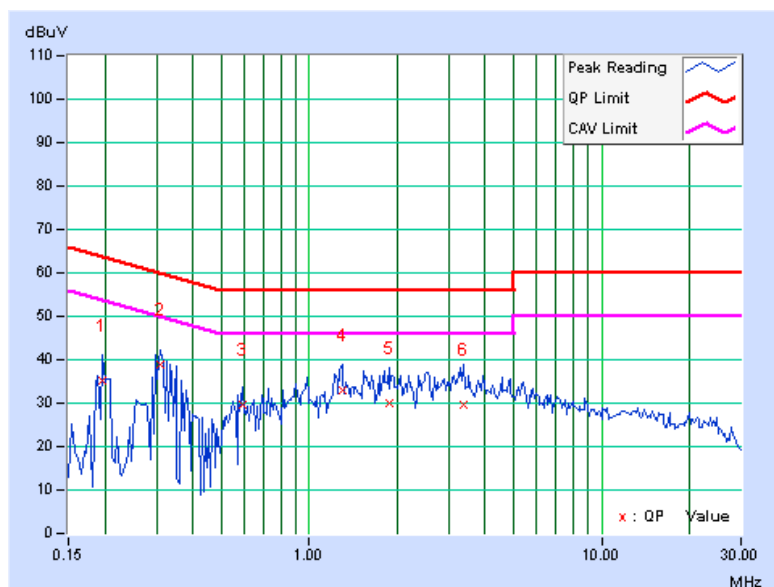

PHASE	Line 2	6dB BANDWIDTH	9kHz
TEST MODE	C2		

No	Freq. [MHz]	Corr. Factor (dB)	Reading Value		Emission Level		Limit		Margin	
			[dB (uV)]		[dB (uV)]		[dB (uV)]		(dB)	
			Q.P.	AV.	Q.P.	AV.	Q.P.	AV.	Q.P.	AV.
1	0.197	0.10	34.13	-	34.23	-	63.74	53.74	-29.51	-
2	0.298	0.11	39.60	-	39.71	-	60.29	50.29	-20.58	-
3	0.338	0.11	33.02	-	33.13	-	59.26	49.26	-26.13	-
4	1.758	0.22	27.26	-	27.48	-	56.00	46.00	-28.52	-
5	3.609	0.30	29.29	-	29.59	-	56.00	46.00	-26.41	-
6	4.742	0.35	26.81	-	27.16	-	56.00	46.00	-28.84	-

- REMARKS:**
1. Q.P. and AV. are abbreviations of quasi-peak and average individually.
 2. "-": The Quasi-peak reading value also meets average limit and measurement with the average detector is unnecessary.
 3. The emission levels of other frequencies were very low against the limit.
 4. Margin value = Emission level - Limit value
 5. Correction factor = Insertion loss + Cable loss
 6. Emission Level = Correction Factor + Reading Value.

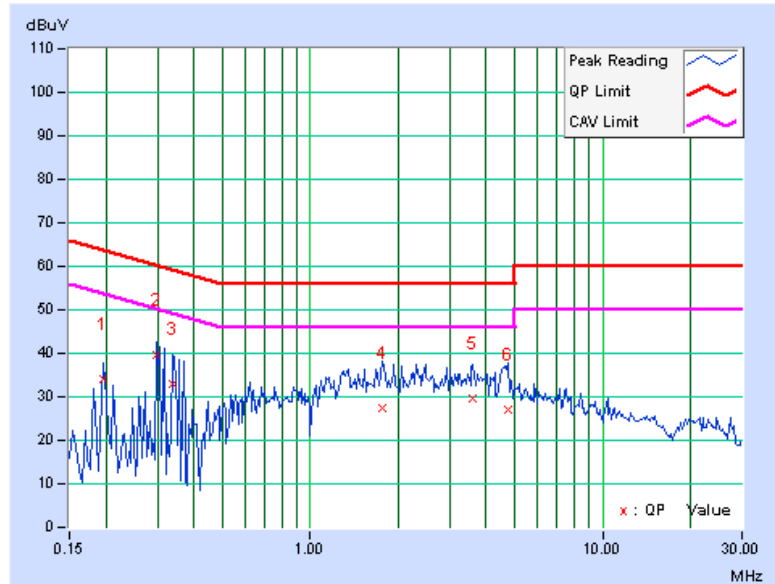

5. PHOTOGRAPHS OF THE TEST CONFIGURATION

Please refer to the attached file (Test Setup Photo).



6. INFORMATION ON THE TESTING LABORATORIES

We, Bureau Veritas Consumer Products Services (H.K.) Ltd., Taoyuan Branch, were founded in 1988 to provide our best service in EMC, Radio, Telecom and Safety consultation. Our laboratories are accredited and approved according to ISO/IEC 17025.

Copies of accreditation certificates of our laboratories obtained from approval agencies can be downloaded from our web site:

www.adt.com.tw/index.5/phtml. If you have any comments, please feel free to contact us at the following:

Linko EMC/RF Lab:

Tel: 886-2-26052180

Fax: 886-2-26051924

Hsin Chu EMC/RF Lab:

Tel: 886-3-5935343

Fax: 886-3-5935342

Hwa Ya EMC/RF/Safety Telecom Lab:

Tel: 886-3-3183232

Fax: 886-3-3185050

Web Site: www.adt.com.tw

The address and road map of all our labs can be found in our web site also.

7. APPENDIX A - MODIFICATIONS RECORDERS FOR ENGINEERING CHANGES TO THE EUT BY THE LAB

No any modifications are made to the EUT by the lab during the test.

--- END ---