



FCC 47 CFR PART 15 SUBPART C

TEST REPORT

For

Mobile phone

Model: EX245

Trade Name: Motorola

Issued to

**Motorola Inc.
600 N. U.S. Highway 45 Libertyville,
Illinois United states 60048-5343**

Issued by

**Compliance Certification Services Inc.
No. 11, Wu-Gong 6th Rd., Wugu Industrial Park,
Taipei Hsien 248, Taiwan (R.O.C.)
<http://www.ccsrf.com>
service@ccsrf.com**





TABLE OF CONTENTS

- 1. TEST RESULT CERTIFICATION.....3**
- 2. EUT DESCRIPTION4**
- 3. TEST METHODOLOGY5**
 - 3.1 EUT CONFIGURATION5
 - 3.2 EUT EXERCISE.....5
 - 3.3 GENERAL TEST PROCEDURES.....5
 - 3.4 FCC PART 15.205 RESTRICTED BANDS OF OPERATIONS6
 - 3.5 DESCRIPTION OF TEST MODES7
- 4. INSTRUMENT CALIBRATION.....8**
 - 4.1 MEASURING INSTRUMENT CALIBRATION8
 - 4.2 MEASUREMENT EQUIPMENT USED8
 - 4.3 MEASUREMENT UNCERTAINTY9
- 5. FACILITIES AND ACCREDITATIONS10**
 - 5.1 FACILITIES10
 - 5.2 EQUIPMENT.....10
 - 5.3 TABLE OF ACCREDITATIONS AND LISTINGS.....11
- 6. SETUP OF EQUIPMENT UNDER TEST12**
 - 6.1 SETUP CONFIGURATION OF EUT.....12
 - 6.2 SUPPORT EQUIPMENT12
- 7. FCC PART 15.247 REQUIREMENTS.....13**
 - 7.1 20 DB BANDWIDTH.....13
 - 7.2 PEAK POWER.....18
 - 7.3 AVERAGE POWER20
 - 7.4 BAND EDGES MEASUREMENT21
 - 7.5 PEAK POWER SPECTRAL DENSITY30
 - 7.6 FREQUENCY SEPARATION36
 - 7.7 NUMBER OF HOPPING FREQUENCY.....39
 - 7.8 TIME OF OCCUPANCY (DWELL TIME)42
 - 7.9 SPURIOUS EMISSIONS55
 - 7.10 POWERLINE CONDUCTED EMISSIONS.....71
- APPENDIX I RADIO FREQUENCY EXPOSURE.....76**
- APPENDIX II PHOTOGRAPHS OF TEST SETUP.....77**
- APPENDIX 1 - PHOTOGRAPHS OF EUT**



1. TEST RESULT CERTIFICATION

Applicant: Motorola Inc.
600 N. U.S. Highway 45 Libertyville,
Illinois United states 60048-5343

Equipment Under Test: Mobile phone

Trade Name: Motorola

Model: EX245

Date of Test: April 26 ~ 29, 2010

APPLICABLE STANDARDS	
STANDARD	TEST RESULT
FCC 47 CFR Part 15 Subpart C	No non-compliance noted

We hereby certify that:

The above equipment was tested by Compliance Certification Services Inc. The test data, data evaluation, test procedures, and equipment configurations shown in this report were made in accordance with the procedures given in **ANSI C63.4: 2003** and the energy emitted by the sample EUT tested as described in this report is in compliance with the requirements of FCC Rules Part 15.207, 15.209, 15.247.

The test results of this report relate only to the tested sample EUT identified in this report.

Approved by:

Reviewed by:

Rex Lai
Section Manager
Compliance Certification Services Inc.

Gina Lo
Section Manager
Compliance Certification Services Inc.



2. EUT DESCRIPTION

Product	Mobile phone
Trade Name	Motorola
Model Number	EX245
Model Discrepancy	N/A
Power Supply	1. Powered by Power Adapter I/P: 100-240VAC, 50-60Hz, 0.2A O/P: 5V, 550mA 2. Powered by host PC 3. Battery Model: BQ50 Rating: 3.7V, 910mAh
Frequency Range	2402 ~ 2480 MHz
Transmit Power	8.51 dBm
Modulation Technique	GFSK for 1Mbps; $\pi/4$ -DQPSK for 2Mbps; 8DPSK for 3Mbps
Transmit Data Rate	1, 2, 3Mbps
Number of Channels	79 Channels
Antenna Specification	Gain: -3.61 dBi
Antenna Designation	Embedded inverted-F antenna

Remark:

1. The sample selected for test was production product and was provided by manufacturer.
2. This submittal(s) (test report) is intended for FCC ID: **IHDP56LJ1** filing to comply with Section 15.207, 15.209 and 15.247 of the FCC Part 15, Subpart C Rules.



3. TEST METHODOLOGY

The tests documented in this report were performed in accordance with ANSI C63.4 and FCC CFR 47 Part 15.207, 15.209 and 15.247.

3.1 EUT CONFIGURATION

The EUT configuration for testing is installed on RF field strength measurement to meet the Commissions requirement and operating in a manner that intends to maximize its emission characteristics in a continuous normal application.

3.2 EUT EXERCISE

The EUT was operated in the engineering mode to fix the TX frequency that was for the purpose of the measurements.

According to its specifications, the EUT must comply with the requirements of the Section 15.207, 15.209 and 15.247 under the FCC Rules Part 15 Subpart C.

3.3 GENERAL TEST PROCEDURES

Conducted Emissions

The EUT is placed on the turntable, which is 0.8 m above ground plane. According to the requirements in Section 13.1.4.1 of ANSI C63.4 Conducted emissions from the EUT measured in the frequency range between 0.15 MHz and 30MHz using CISPR Quasi-peak and average detector modes.

Radiated Emissions

The EUT is placed on a turn table, which is 0.8 m above ground plane. The turntable shall rotate 360 degrees to determine the position of maximum emission level. EUT is set 3m away from the receiving antenna, which varied from 1m to 4m to find out the highest emission. And also, each emission was to be maximized by changing the polarization of receiving antenna both horizontal and vertical. In order to find out the maximum emissions, exploratory radiated emission measurements were made according to the requirements in Section 13.1.4.1 of ANSI C63.4.



3.4 FCC PART 15.205 RESTRICTED BANDS OF OPERATIONS

(a) Except as shown in paragraph (d) of this section, only spurious emissions are permitted in any of the frequency bands listed below:

MHz	MHz	MHz	GHz
0.090 - 0.110	16.42 - 16.423	399.9 - 410	4.5 - 5.15
¹ 0.495 - 0.505	16.69475 - 16.69525	608 - 614	5.35 - 5.46
2.1735 - 2.1905	16.80425 - 16.80475	960 - 1240	7.25 - 7.75
4.125 - 4.128	25.5 - 25.67	1300 - 1427	8.025 - 8.5
4.17725 - 4.17775	37.5 - 38.25	1435 - 1626.5	9.0 - 9.2
4.20725 - 4.20775	73 - 74.6	1645.5 - 1646.5	9.3 - 9.5
6.215 - 6.218	74.8 - 75.2	1660 - 1710	10.6 - 12.7
6.26775 - 6.26825	108 - 121.94	1718.8 - 1722.2	13.25 - 13.4
6.31175 - 6.31225	123 - 138	2200 - 2300	14.47 - 14.5
8.291 - 8.294	149.9 - 150.05	2310 - 2390	15.35 - 16.2
8.362 - 8.366	156.52475 -	2483.5 - 2500	17.7 - 21.4
8.37625 - 8.38675	156.52525	2655 - 2900	22.01 - 23.12
8.41425 - 8.41475	156.7 - 156.9	3260 - 3267	23.6 - 24.0
12.29 - 12.293	162.0125 - 167.17	3332 - 3339	31.2 - 31.8
12.51975 - 12.52025	167.72 - 173.2	3345.8 - 3358	36.43 - 36.5
12.57675 - 12.57725	240 - 285	3600 - 4400	(²)
13.36 - 13.41	322 - 335.4		

¹ Until February 1, 1999, this restricted band shall be 0.490-0.510 MHz.

² Above 38.6

(b) Except as provided in paragraphs (d) and (e), the field strength of emissions appearing within these frequency bands shall not exceed the limits shown in Section 15.209. At frequencies equal to or less than 1000 MHz, compliance with the limits in Section 15.209 shall be demonstrated using measurement instrumentation employing a CISPR quasi-peak detector. Above 1000 MHz, compliance with the emission limits in Section 15.209 shall be demonstrated based on the average value of the measured emissions. The provisions in Section 15.35 apply to these measurements.



3.5 DESCRIPTION OF TEST MODES

The EUT (model: EX245) had been tested under operating condition.

Test program used to control the EUT for staying in continuous transmitting mode was programmed.

Software used to control the EUT for staying in continuous transmitting mode was programmed.

The worst case data rate is determined as the data rate with highest output power.

After verification, all tests were carried out with the worst case test modes as shown below except radiated spurious emission below 1GHz and power line conducted emissions below 30MHz, which worst case was in normal link mode only.

During the preliminary test, GFSK, $\pi/4$ -QPSK & 8DPSK with DH1 were pre-tested and found that 8DPSK emits the highest output power. Then the tests were carried on with DH1 compare to DH3 & DH5 and found that 8DPSK with DH5 emit the highest output power, and therefore had been tested under operating condition.

Following channels were selected for the for radiated emission testing only as listed below:

Tested Channel	Modulation Type	Packet Type	Date Rate
Low, Mid, High	GFSK	DH 5	1
Low, Mid, High	8DPSK	DH 5	3

The field strength of spurious emission was measured in the following position: EUT stand-up position (Z axis), lie-down position (X, Y axis). The worst emission was found in lie-down position (Y axis) and the worst case was recorded.



4. INSTRUMENT CALIBRATION

4.1 MEASURING INSTRUMENT CALIBRATION

The measuring equipment, which was utilized in performing the tests documented herein, has been calibrated in accordance with the manufacturer's recommendations for utilizing calibration equipment, which is traceable to recognized national standards.

4.2 MEASUREMENT EQUIPMENT USED

Equipment Used for Emissions Measurement

Remark: Each piece of equipment is scheduled for calibration once a year.

Conducted Emissions Test Site				
Name of Equipment	Manufacturer	Model	Serial Number	Calibration Due
Spectrum Analyzer	Agilent	E4446A	MY43360131	03/03/2011
Power Meter	Agilent	E4416A	GB41291611	06/28/2010
Power Sensor	Agilent	E9327A	US40441097	06/28/2010

3M Semi Anechoic Chamber				
Name of Equipment	Manufacturer	Model	Serial Number	Calibration Due
Spectrum Analyzer	Agilent	E4446A	US42510252	10/26/2010
EMI Test Receiver	R&S	ESCI	100064	02/04/2011
Pre-Amplifier	Mini-Circuits	ZFL-1000LN	SF350700823	01/13/2011
Pre-Amplifier	MITEQ	AFS44-00102650-42-10P-44	1415367	11/20/2010
Bilog Antenna	Sunol Sciences	JB3	A030105	09/11/2010
Horn Antenna	EMCO	3117	00055165	12/07/2010
Loop Antenna	EMCO	6502	8905/2356	05/28/2010
Turn Table	CCS	CC-T-1F	N/A	N.C.R
Antenna Tower	CCS	CC-A-1F	N/A	N.C.R
Controller	CCS	CC-C-1F	N/A	N.C.R
Site NSA	CCS	N/A	N/A	12/31/2010
Test S/W	EZ-EMC (CCS-3A1RE)			

Powerline Conducted Emissions Test Site				
Name of Equipment	Manufacturer	Model	Serial Number	Calibration Due
EMI Test Receiver	R&S	ESHS30	828144/003	12/06/2010
LISN	EMCO	3825/2	9106-1809	05/02/2011
LISN	SCHAFFNER	NNB 41	03/10013	12/03/2010



4.3 MEASUREMENT UNCERTAINTY

PARAMETER	UNCERTAINTY
Powerline Conducted Emission	+/- 1.6202
3M Semi Anechoic Chamber / 30M~200M	+/- 4.0606
3M Semi Anechoic Chamber / 200M~1000M	+/- 3.9979
3M Semi Anechoic Chamber / 1G~8G	+/- 2.5790
3M Semi Anechoic Chamber / 8G~18G	+/- 2.5928
3M Semi Anechoic Chamber / 18G~26G	+/- 2.7212
3M Semi Anechoic Chamber / 26G~40G	+/- 2.9520

Remark: This uncertainty represents an expanded uncertainty expressed at approximately the 95% confidence level using a coverage factor of $k=2$.



5. FACILITIES AND ACCREDITATIONS

5.1 FACILITIES

All measurement facilities used to collect the measurement data are located at

No.199, Chunghsen Road, Hsintien City, Taipei Hsien, Taiwan, R.O.C.

Tel: 886-2-2217-0894 / Fax: 886-2-2217-1029

No.11, Wugong 6th Rd., Wugu Industrial Park, Taipei Hsien 248, Taiwan

Tel: 886-2-2299-9720 / Fax: 886-2-2298-4045

No.81-1, Lane 210, Bade 2nd Rd., Luchu Hsiang, Taoyuan Hsien 338, Taiwan

Tel: 886-3-324-0332 / Fax: 886-3-324-5235

The sites are constructed in conformance with the requirements of ANSI C63.7, ANSI C63.4 and CISPR Publication 22.

5.2 EQUIPMENT



Radiated emissions are measured with one or more of the following types of linearly polarized antennas: tuned dipole, biconical, log periodic, bi-log, and/or ridged waveguide, horn. Spectrum analyzers with pre-selectors and quasi-peak detectors are used to perform radiated measurements.

Conducted emissions are measured with Line Impedance Stabilization Networks and EMI Test Receivers.

Calibrated wideband preamplifiers, coaxial cables, and coaxial attenuators are also used for making measurements.

All receiving equipment conforms to CISPR Publication 16-1, "Radio Interference Measuring Apparatus and Measurement Methods."

5.3 TABLE OF ACCREDITATIONS AND LISTINGS

Country	Agency	Scope of Accreditation	Logo
USA	FCC	3M Semi Anechoic Chamber (FCC MRA: TW1039) to perform FCC Part 15 measurements	 FCC MRA: TW1039
Taiwan	TAF	LP0002, RTTE01, FCC Method-47 CFR Part 15 Subpart C, D, E, RSS-210, RSS-310 IDA TS SRD, AS/NZS 4268, AS/NZS 4771, TS 12.1 & 12.2, ETSI EN 300 440-1, ETSI EN 300 440-2, ETSI EN 300 328, ETSI EN 300 220-1, ETSI EN 300 220-2, ETSI EN 301 893, ETSI EN 301 489-1/3/7/17 FCC OET Bulletin 65 + Supplement C, EN 50360, EN 50361, EN 50371, RSS 102, EN 50383, EN 50385, EN 50392, IEC 62209, CNS 14958-1, CNS 14959 FCC Method -47 CFR Part 15 Subpart B IEC / EN 61000-3-2, IEC / EN 61000-3-3, IEC / EN 61000-4-2/3/4/5/6/8/11	
Canada	Industry Canada	3M Semi Anechoic Chamber (IC 2324G-1 / IC 2324G-2) to perform	 IC 2324G-1 IC 2324G-2

** No part of this report may be used to claim or imply product endorsement by A2LA or any agency of the US Government.*



6. SETUP OF EQUIPMENT UNDER TEST

6.1 SETUP CONFIGURATION OF EUT

See test photographs attached in Appendix II for the actual connections between EUT and support equipment.

6.2 SUPPORT EQUIPMENT

No.	Device Type	Brand	Model	Series No.	FCC ID	Data Cable	Power Cord
1.	Notebook PC	DELL	PP05L	CBNLD1S	E2K5HCKT	N/A	AC I/P: Unshielded, 1.8m DC O/P: Unshielded, 1.8m with a core
2.	LCD Monitor	DELL	2407WFPb	CN-0FC255-46633-675 -22TJS	FCC DoC	Shielded, 1.8m with 2 cores	Unshielded, 1.8m
3.	320GB 2.5" HDD	Seagate	9ZA2MG-500	2GE3NHH0	FCC DoC	Shielded, 1.8m	N/A
4.	USB Mouse	Logitech	M-UAG96B	HC8500L	FCC DoC	Shielded, 1.8m	N/A
5.	8960 Series 10 Wireless Communication test set (Remote)	Agilent	E5515C	GB44051665	N/A	N/A	Unshielded, 1.8m

Remark:

1. All the equipment/cables were placed in the worst-case configuration to maximize the emission during the test.
2. Grounding was established in accordance with the manufacturer's requirements and conditions for the intended use.

7. FCC PART 15.247 REQUIREMENTS

7.1 20 DB BANDWIDTH

LIMIT

None; for reporting purposes only.

Test Configuration

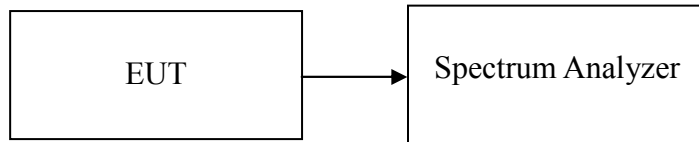

TEST PROCEDURE

1. Place the EUT on the table and set it in the transmitting mode.
2. Remove the antenna from the EUT and then connect a low loss RF cable from the antenna port to the spectrum analyzer.
3. Set the spectrum analyzer as RBW=10kHz, VBW = 30kHz, Span = 1.5MHz, Sweep = auto.
4. Mark the peak frequency and 20dB (upper and lower) frequency.
5. Repeat until all the rest channels are investigated.

TEST RESULTS

No non-compliance noted.

Test Data

For GFSK / DH5

Channel	Frequency (MHz)	20dB Bandwidth (MHz)
Low	2402	0.929
Mid	2441	0.928
High	2480	0.927

For 8DPSK / DH5

Channel	Frequency (MHz)	20dB Bandwidth (MHz)
Low	2402	1.197
Mid	2441	1.203
High	2480	1.197



Test Plot

For GFSK / DH5

20dB Bandwidth (CH Low)

Agilent 15:42:02 Apr 27, 2010

R T

Δ Mkr2 929 kHz
0.49 dB

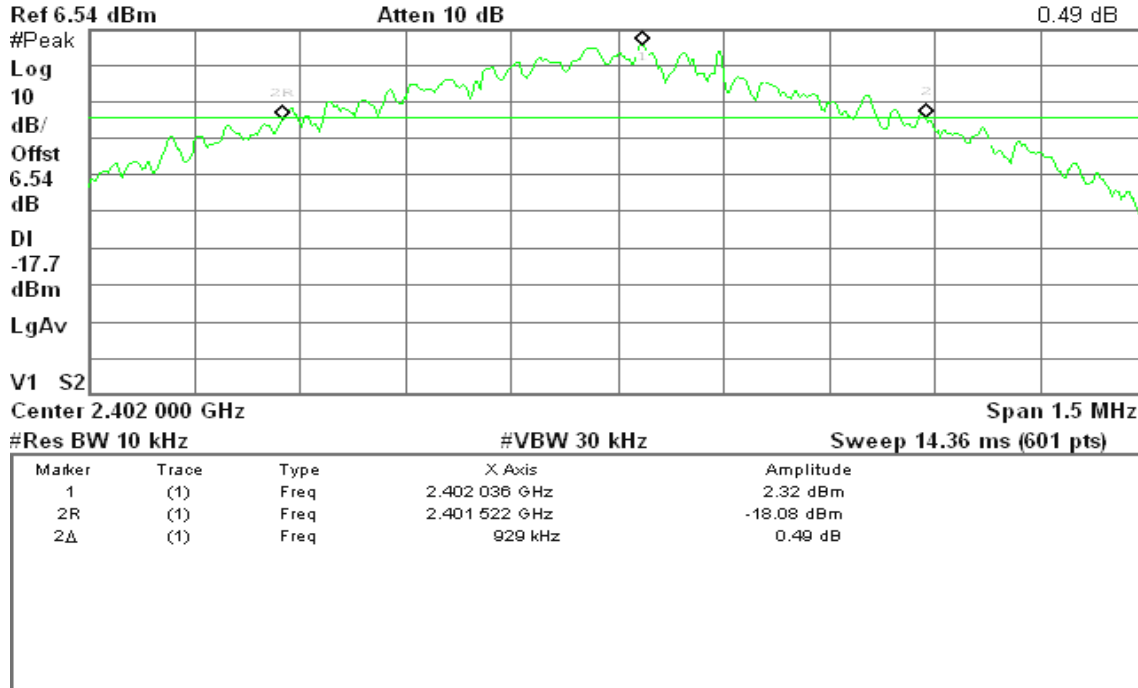

20dB Bandwidth (CH Mid)

Agilent 15:43:18 Apr 27, 2010

R T

Δ Mkr2 928 kHz
-0.58 dB

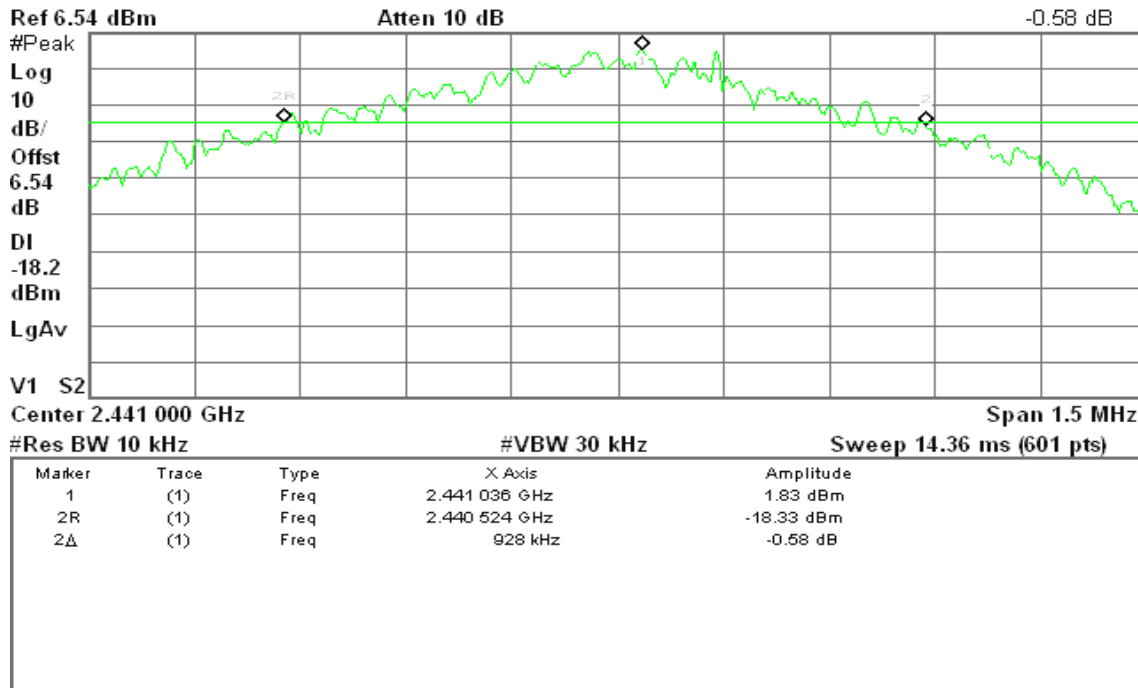



20dB Bandwidth (CH High)

Agilent 15:44:34 Apr 27, 2010

R T

Δ Mkr2 927 kHz
-0.39 dB

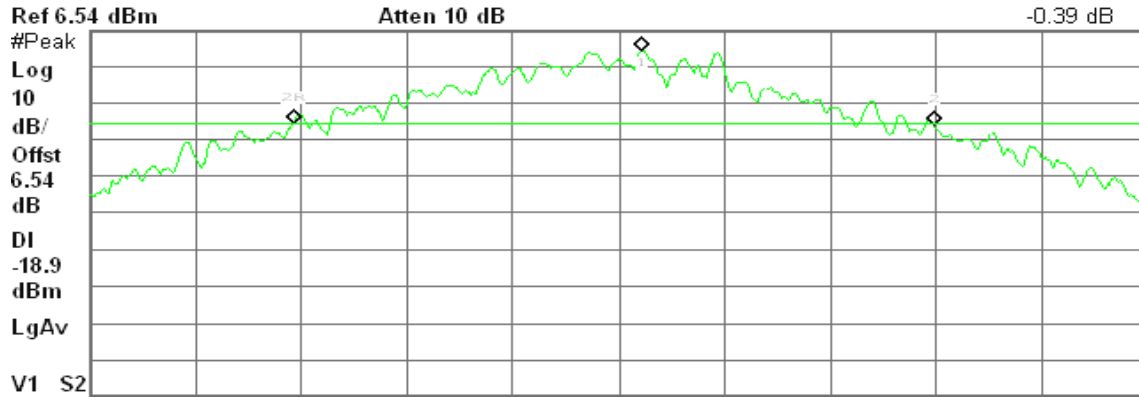

Center 2.480 000 GHz

Span 1.5 MHz

#Res BW 10 kHz

#VBW 30 kHz

Sweep 14.36 ms (601 pts)

Marker	Trace	Type	X Axis	Amplitude
1	(1)	Freq	2.480 033 GHz	1.08 dBm
2R	(1)	Freq	2.479 524 GHz	-19.14 dBm
2Δ	(1)	Freq	927 kHz	-0.39 dB



For 8DPSK / DH5

20dB Bandwidth (CH Low)

Agilent 17:54:01 Apr 27, 2010

R T

Δ Mkr2 1.197 MHz

-0.18 dB

Ref 15.54 dBm

#Atten 20 dB

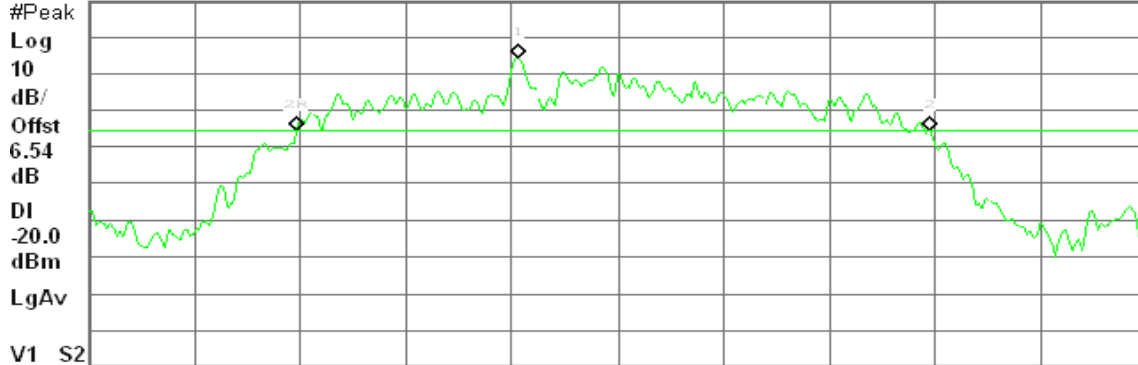

Center 2.402 000 GHz

Span 2 MHz

#Res BW 10 kHz

#VBW 30 kHz

Sweep 19.12 ms (601 pts)

Marker	Trace	Type	X Axis	Amplitude
1	(1)	Freq	2.401 813 GHz	0.01 dBm
2R	(1)	Freq	2.401 393 GHz	-19.88 dBm
2Δ	(1)	Freq	1.197 MHz	-0.18 dB

20dB Bandwidth (CH Mid)

Agilent 17:54:51 Apr 27, 2010

R T

Δ Mkr2 1.203 MHz

-2.50 dB

Ref 15.54 dBm

#Atten 20 dB

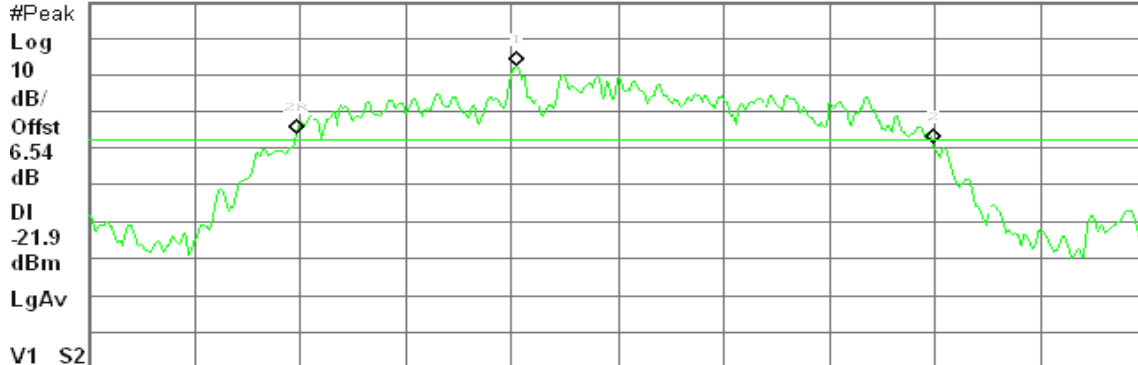

Center 2.441 000 GHz

Span 2 MHz

#Res BW 10 kHz

#VBW 30 kHz

Sweep 19.12 ms (601 pts)

Marker	Trace	Type	X Axis	Amplitude
1	(1)	Freq	2.440 810 GHz	-1.94 dBm
2R	(1)	Freq	2.440 393 GHz	-20.31 dBm
2Δ	(1)	Freq	1.203 MHz	-2.50 dB



20dB Bandwidth (CH High)

Agilent 17:56:37 Apr 27, 2010

R T

Δ Mkr2 1.197 MHz

-0.69 dB

Ref 15.54 dBm

#Atten 20 dB

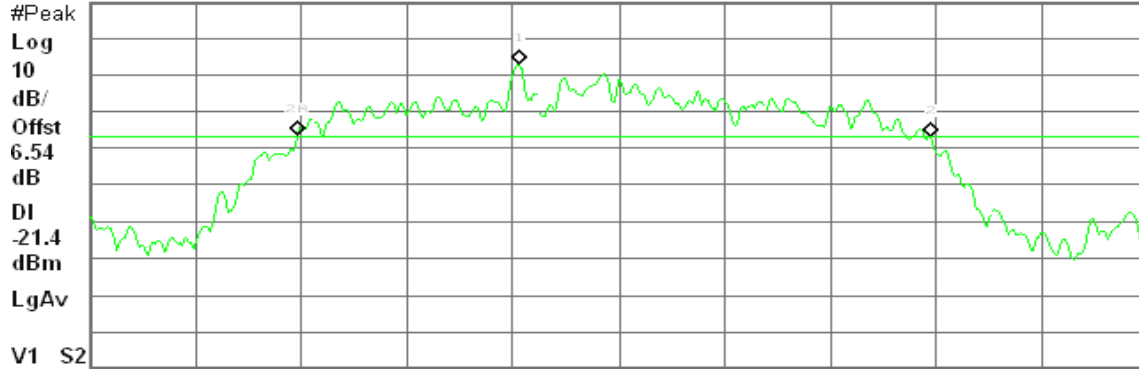

Center 2.480 000 GHz

Span 2 MHz

#Res BW 10 kHz

#VBW 30 kHz

Sweep 19.12 ms (601 pts)

Marker	Trace	Type	X Axis	Amplitude
1	(1)	Freq	2.479 813 GHz	-1.40 dBm
2R	(1)	Freq	2.479 393 GHz	-20.72 dBm
2Δ	(1)	Freq	1.197 MHz	-0.69 dB



7.2 PEAK POWER

LIMIT

The maximum peak output power of the intentional radiator shall not exceed the following:

1. According to §15.247(a)(1), Frequency hopping systems shall have hopping channel carrier frequencies separated by a minimum of 25 kHz or the 20 dB bandwidth of the hopping channel, whichever is greater. Alternatively, frequency hopping systems operating in the 2400-2483.5 MHz band may have hopping channel carrier frequencies that are separated by 25 kHz or two-thirds of the 20 dB bandwidth of the hopping channel, whichever is greater, provided the systems operate with an output power no greater than 125 mW.
2. According to §15.247(b)(3), for systems using digital modulation in the bands of 902-928 MHz, 2400-2483.5 MHz, and 5725-5850 MHz: 1 Watt.
3. According to §15.247(b)(4), the conducted output power limit specified in paragraph (b) of this section is based on the use of antennas with directional gains that do not exceed 6 dBi. Except as shown in paragraph (c) of this section, if transmitting antennas of directional gain greater than 6 dBi are used, the conducted output power from the intentional radiator shall be reduced below the stated values in paragraphs (b)(1), (b)(2), and (b)(3) of this section, as appropriate, by the amount in dB that the directional gain of the antenna exceeds 6 dBi.

Test Configuration

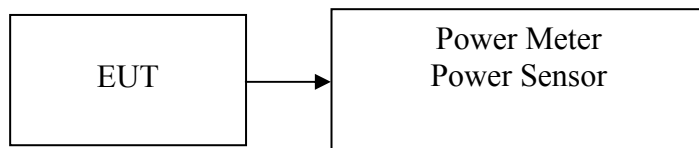

TEST PROCEDURE

The transmitter output is connected to the Power Meter. The Power Meter is set to the peak power detection.

TEST RESULTS

No non-compliance noted.



Test Data

For GFSK / DH5

Channel	Frequency (MHz)	Output Power (dBm)	Output Power (W)	Limit (W)	Result
Low	2402	8.51	0.0071	0.125	PASS
Mid	2441	7.79	0.0060		PASS
High	2480	6.82	0.0048		PASS

For 8DPSK / DH5

Channel	Frequency (MHz)	Output Power (dBm)	Output Power (W)	Limit (W)	Result
Low	2402	7.11	0.0051	0.125	PASS
Mid	2441	6.34	0.0043		PASS
High	2480	5.12	0.0033		PASS



7.3 AVERAGE POWER

LIMIT

None; for reporting purposes only.

Test Configuration

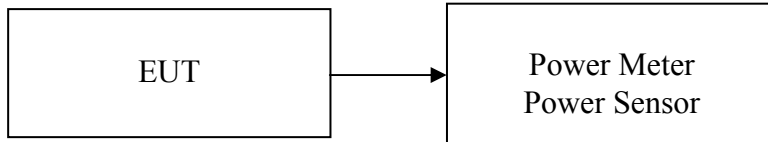

TEST PROCEDURE

The transmitter output is connected to the Power Meter. The Power Meter is set to the peak power detection.

TEST RESULTS

No non-compliance noted.

Test Data

For GFSK / DH5

Channel	Frequency (MHz)	Output Power (dBm)	Output Power (W)
Low	2402	7.34	0.0054
Mid	2441	6.56	0.0045
High	2480	5.57	0.0036

For 8DPSK / DH5

Channel	Frequency (MHz)	Output Power (dBm)	Output Power (W)
Low	2402	3.28	0.0021
Mid	2441	2.45	0.0018
High	2480	1.19	0.0013

7.4 BAND EDGES MEASUREMENT

LIMIT

According to §15.247(d), in any 100 kHz bandwidth outside the frequency bands in which the spread spectrum intentional radiator is operating, the radio frequency power that is produced by the intentional radiator shall be at least 20 dB below that in the 100 kHz bandwidth within the band that contains the highest level of the desired power, based on either an RF conducted or a radiated measurement, provided the transmitter demonstrates compliance with the peak conducted power limits. In addition, radiated emissions which fall in the restricted bands, as defined in §15.205(a), must also comply with the radiated emission limits specified in 15.209(a) (see Section 15.205(c)).

Test Configuration

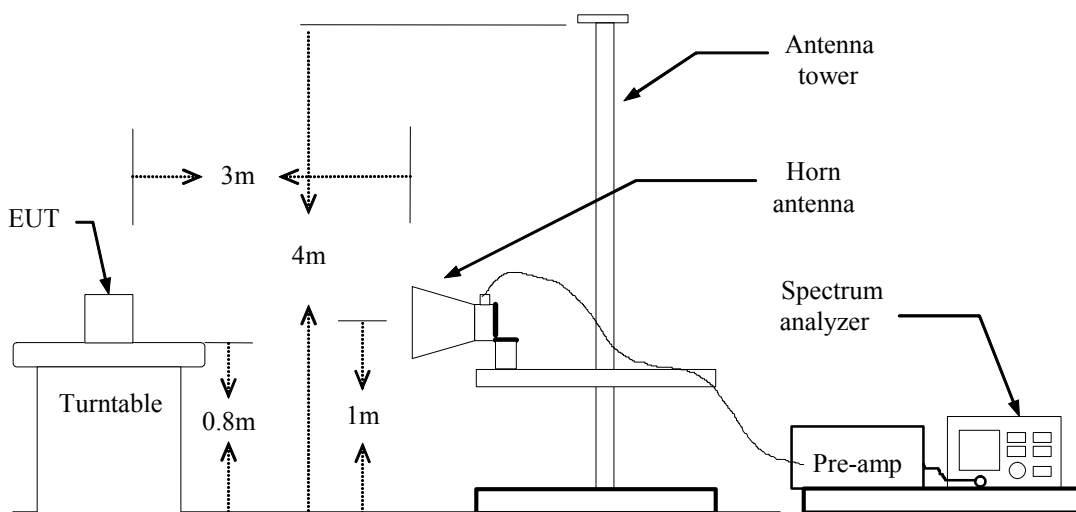

TEST PROCEDURE

1. The EUT is placed on a turntable, which is 0.8m above the ground plane.
2. The turntable shall be rotated for 360 degrees to determine the position of maximum emission level.
3. EUT is set 3m away from the receiving antenna, which is varied from 1m to 4m to find out the highest emission.
4. Set the spectrum analyzer in the following setting in order to capture the lower and upper band-edges of the emission:
 - (a) PEAK: RBW=VBW=1MHz / Sweep=AUTO
 - (b) AVERAGE: RBW=1MHz / VBW=10Hz / Sweep=AUTO
5. Repeat the procedures until all the PEAK and AVERAGE versus POLARIZATION are measured.

TEST RESULTS

Refer to attach spectrum analyzer data chart.



For GFSK / DH5

Band Edges (CH Low)

Detector mode: Peak

Polarity: Vertical

Agilent 15:16:26 Apr 28, 2010

R T

Mkr2 2.399 84 GHz
60.00 dBµV

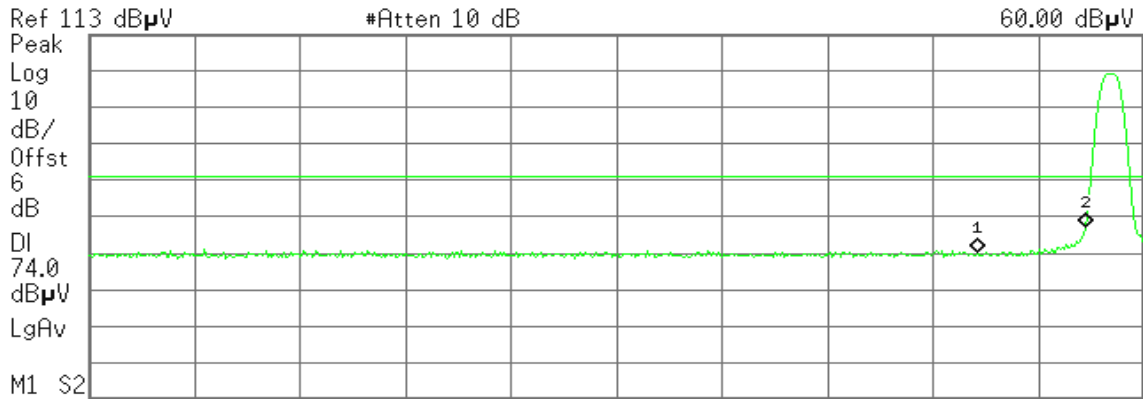

Start 2.310 00 GHz #Res BW 1 MHz #VBW 1 MHz Stop 2.405 00 GHz #Sweep 100 ms (601 pts)

Marker	Trace	Type	X Axis	Amplitude
1	(1)	Freq	2.390 00 GHz	53.06 dBµU
2	(1)	Freq	2.399 84 GHz	60.00 dBµU

Detector mode: Average

Polarity: Vertical

Agilent 15:16:40 Apr 28, 2010

R T

Mkr2 2.399 84 GHz
47.04 dBµV

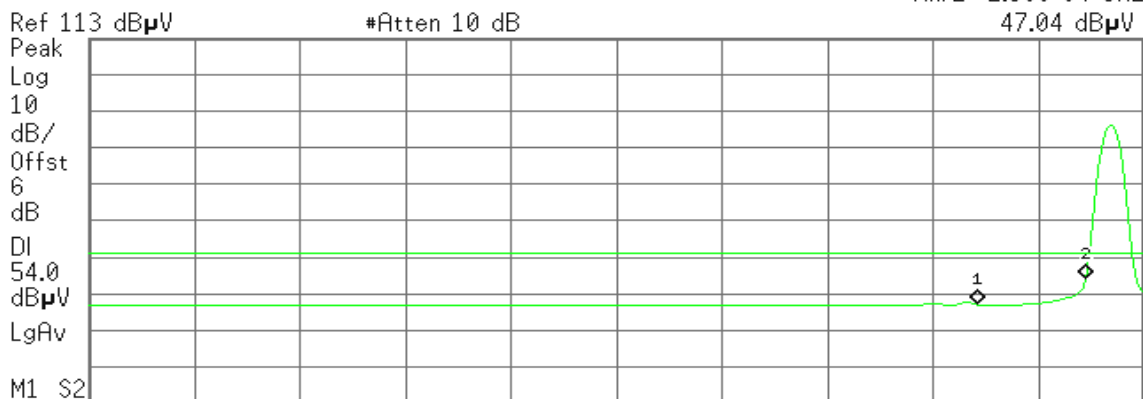

Start 2.310 00 GHz #Res BW 1 MHz #VBW 10 Hz Stop 2.405 00 GHz Sweep 7.408 s (601 pts)

Marker	Trace	Type	X Axis	Amplitude
1	(1)	Freq	2.390 00 GHz	40.04 dBµU
2	(1)	Freq	2.399 84 GHz	47.04 dBµU



Detector mode: Peak

Polarity: Horizontal

Agilent 15:23:01 Apr 28, 2010

R T

Mkr2 2.400 00 GHz
67.01 dBµV

Ref 113 dBµV

#Atten 10 dB

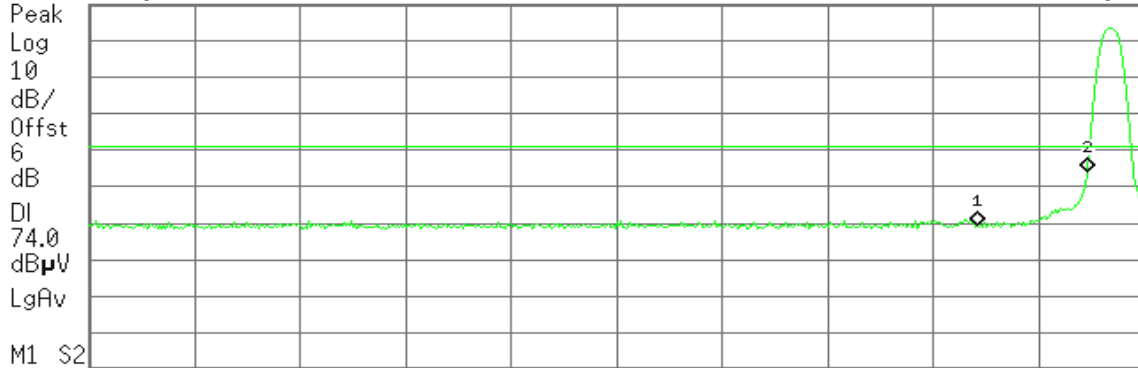

M1 S2 Start 2.310 00 GHz

Stop 2.405 00 GHz

#Res BW 1 MHz

#VBW 1 MHz

#Sweep 100 ms (601 pts)

Marker	Trace	Type	X Axis	Amplitude
1	(1)	Freq	2.390 00 GHz	52.49 dBµU
2	(1)	Freq	2.400 00 GHz	67.01 dBµU

Detector mode: Average

Polarity: Horizontal

Agilent 15:23:17 Apr 28, 2010

R T

Mkr2 2.400 00 GHz
53.06 dBµV

Ref 113 dBµV

#Atten 10 dB



M1 S2 Start 2.310 00 GHz

Stop 2.405 00 GHz

#Res BW 1 MHz

#VBW 10 Hz

Sweep 7.408 s (601 pts)

Marker	Trace	Type	X Axis	Amplitude
1	(1)	Freq	2.390 00 GHz	40.28 dBµU
2	(1)	Freq	2.400 00 GHz	53.06 dBµU



Band Edges (CH High)

Detector mode: Peak

Polarity: Vertical

Agilent 15:37:50 Apr 28, 2010

R T

Mkr1 2.483 50 GHz
54.07 dBμV

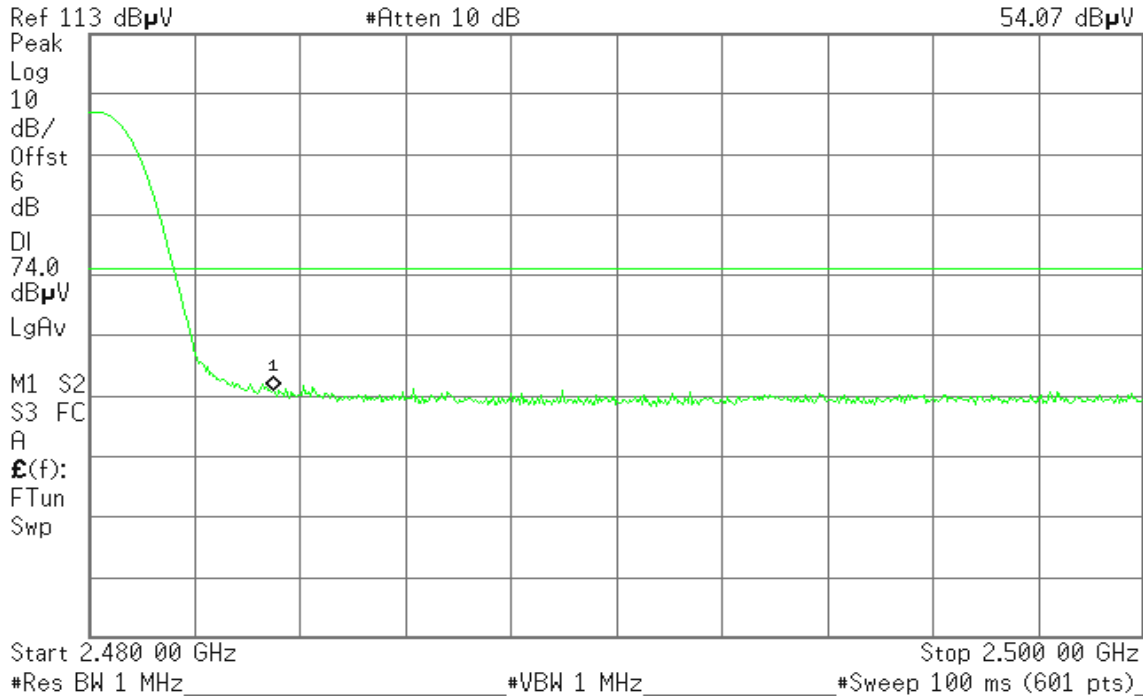

Detector mode: Average

Polarity: Vertical

Agilent 15:38:03 Apr 28, 2010

R T

Mkr1 2.483 50 GHz
41.46 dBμV

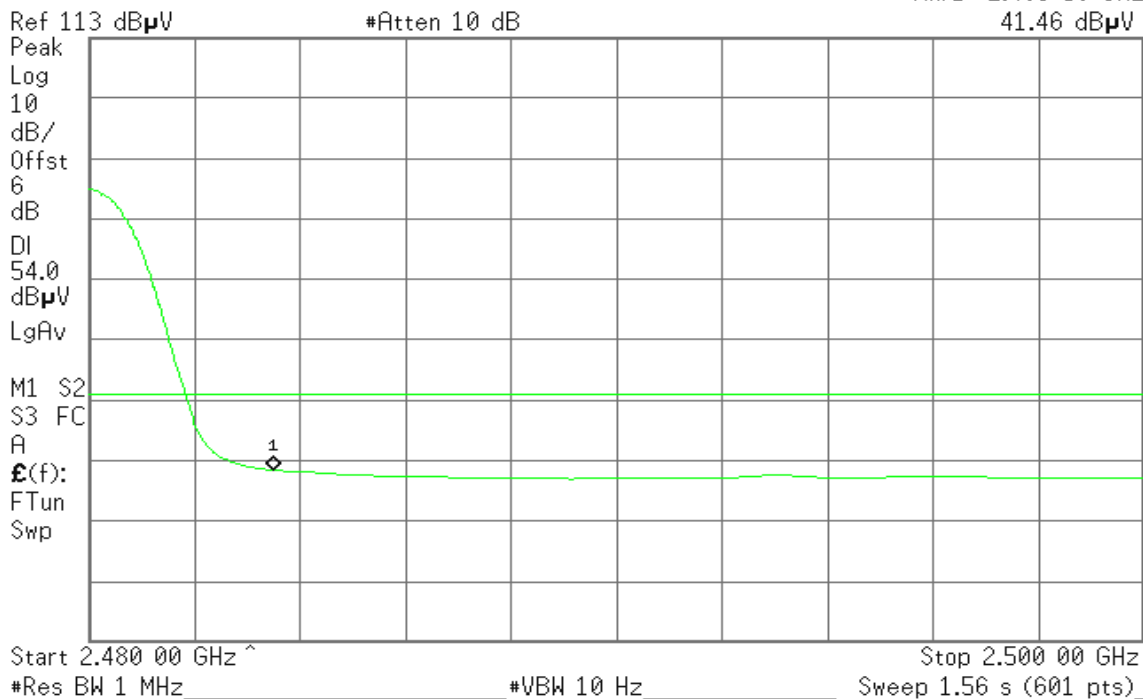



Detector mode: Peak

Polarity: Horizontal

Agilent 15:59:37 Apr 28, 2010

R T

Mkr1 2.483 50 GHz
56.53 dBµV

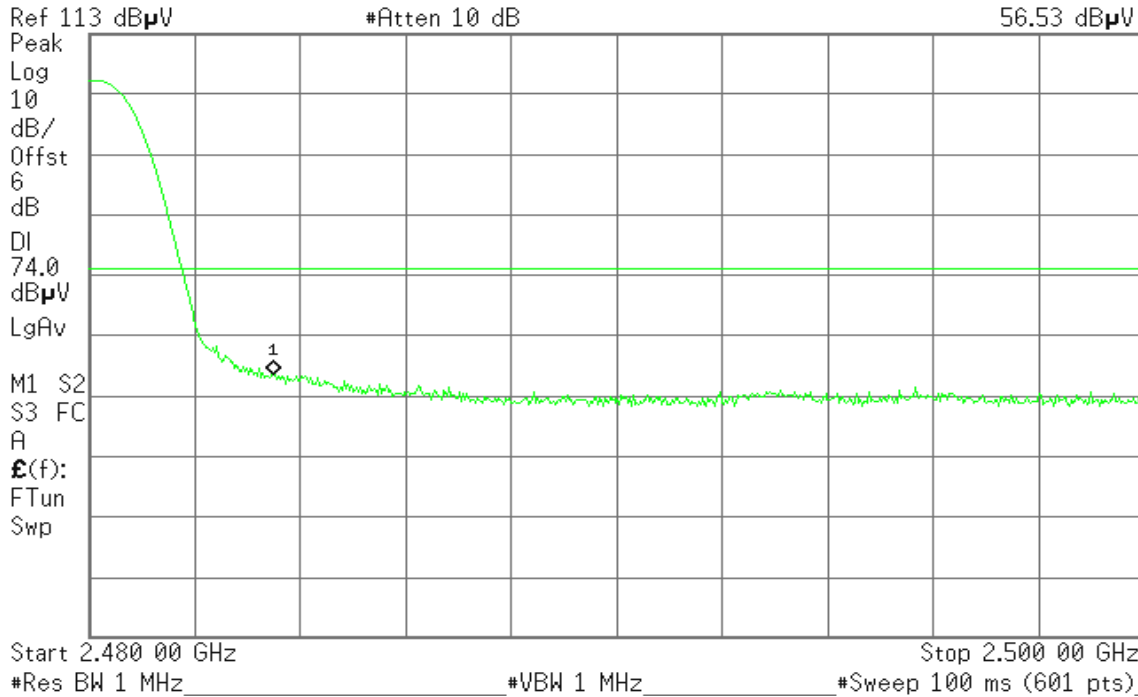

Detector mode: Average

Polarity: Horizontal

Agilent 15:59:48 Apr 28, 2010

R T

Mkr1 2.483 50 GHz
43.74 dBµV

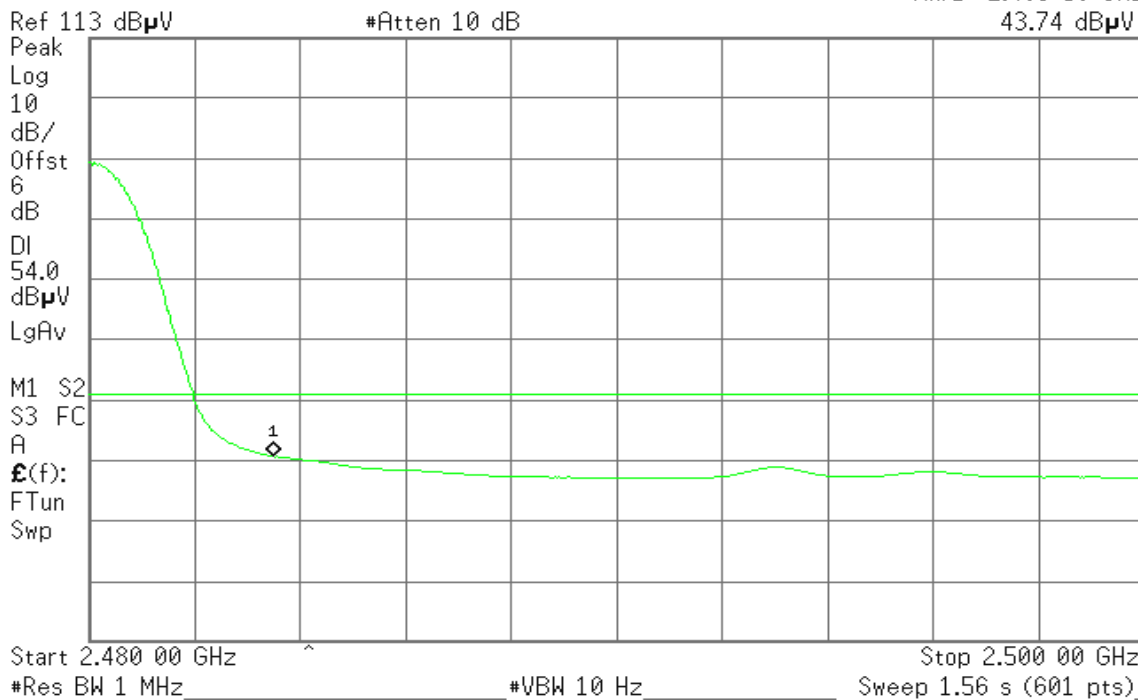



For 8DPSK / DH5

Band Edges (CH Low)

Detector mode: Peak

Polarity: Vertical

Agilent 17:28:58 Apr 29, 2010

R T

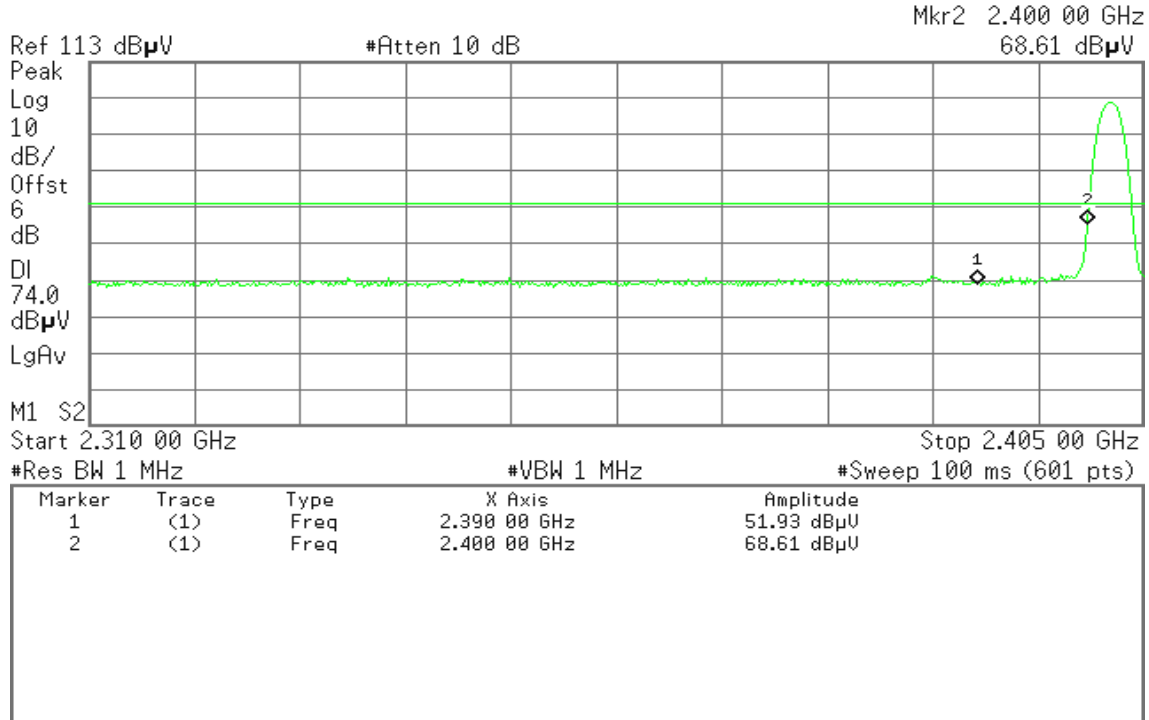

Detector mode: Average

Polarity: Vertical

Agilent 17:29:15 Apr 29, 2010

R T

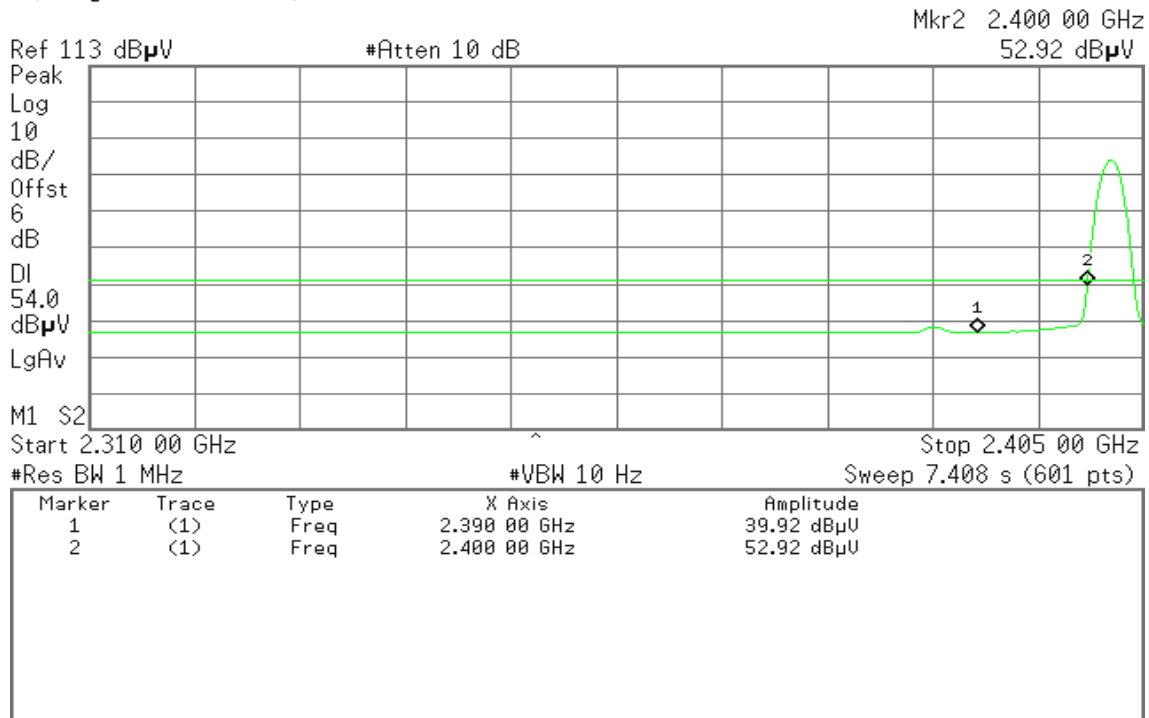



Detector mode: Peak

Polarity: Horizontal

Agilent 17:34:47 Apr 29, 2010

R T

Mkr2 2.400 00 GHz
70.94 dBµV

Ref 113 dBµV

#Atten 10 dB

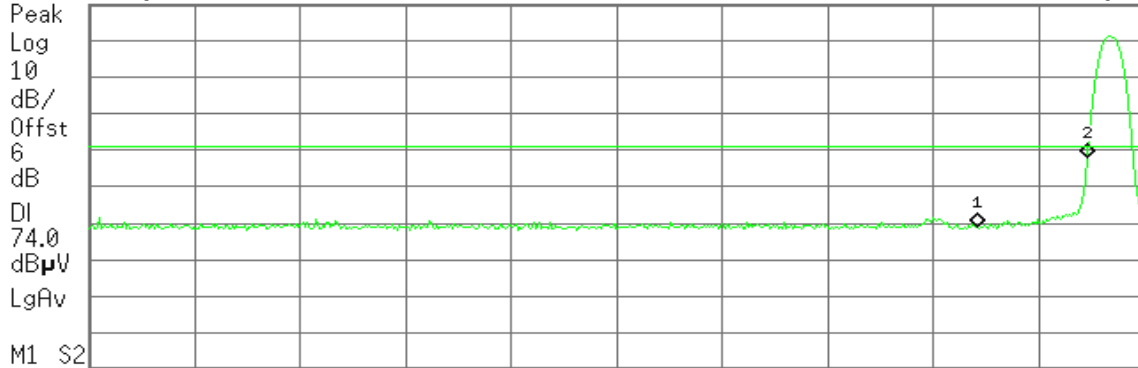

Start 2.310 00 GHz

Stop 2.405 00 GHz

#Res BW 1 MHz

#VBW 1 MHz

#Sweep 100 ms (601 pts)

Marker	Trace	Type	X Axis	Amplitude
1	(1)	Freq	2.390 00 GHz	51.86 dBµU
2	(1)	Freq	2.400 00 GHz	70.94 dBµU

Detector mode: Average

Polarity: Horizontal

Agilent 17:35:12 Apr 29, 2010

R T

Mkr2 2.400 00 GHz
55.13 dBµV

Ref 113 dBµV

#Atten 10 dB



Start 2.310 00 GHz

Stop 2.405 00 GHz

#Res BW 1 MHz

#VBW 10 Hz

Sweep 7.408 s (601 pts)

Marker	Trace	Type	X Axis	Amplitude
1	(1)	Freq	2.390 00 GHz	39.97 dBµU
2	(1)	Freq	2.400 00 GHz	55.13 dBµU



Band Edges (CH High)

Detector mode: Peak

Polarity: Vertical

Agilent 17:49:36 Apr 29, 2010

R T

Mkr1 2.483 50 GHz
53.33 dBμV

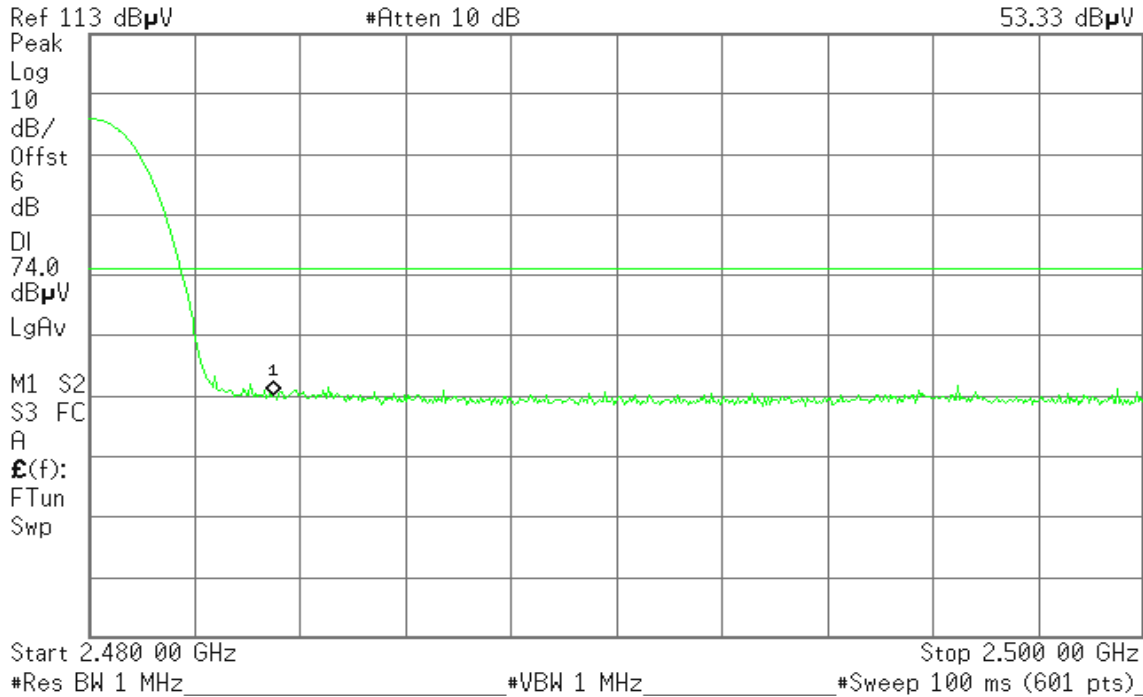

Detector mode: Average

Polarity: Vertical

Agilent 17:49:51 Apr 29, 2010

R T

Mkr1 2.483 50 GHz
40.85 dBμV

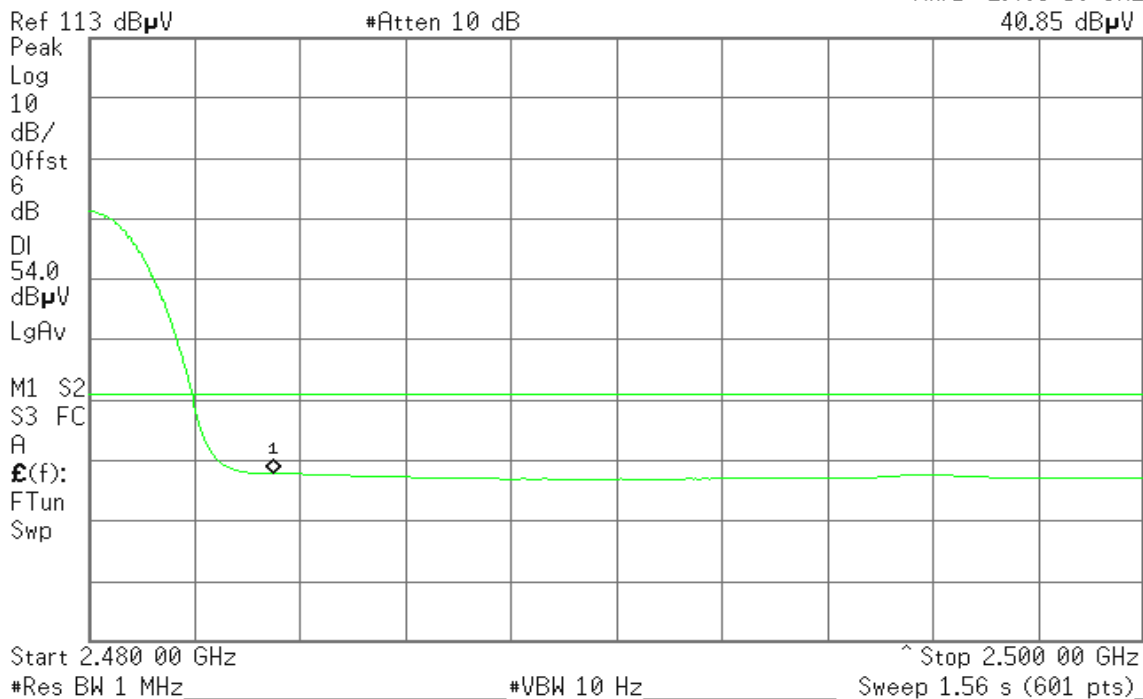



Detector mode: Peak

Polarity: Horizontal

Agilent 17:55:01 Apr 29, 2010

R T

Mkr1 2.483 50 GHz
53.74 dBµV

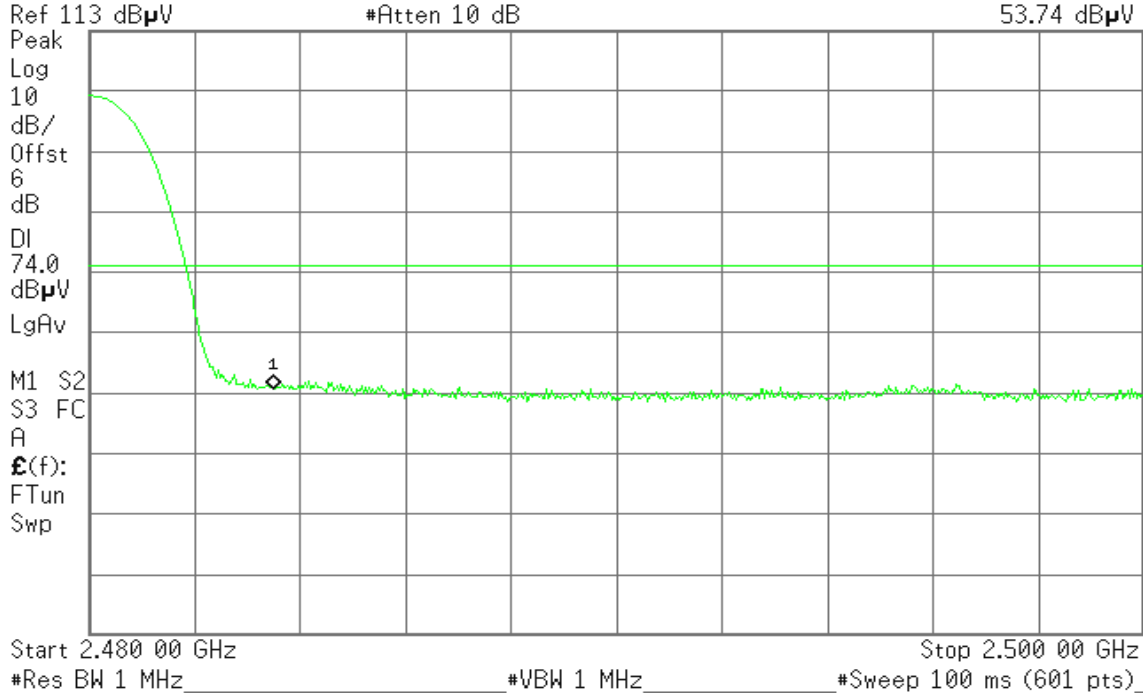

Detector mode: Average

Polarity: Horizontal

Agilent 17:55:12 Apr 29, 2010

R T

Mkr1 2.483 50 GHz
41.65 dBµV

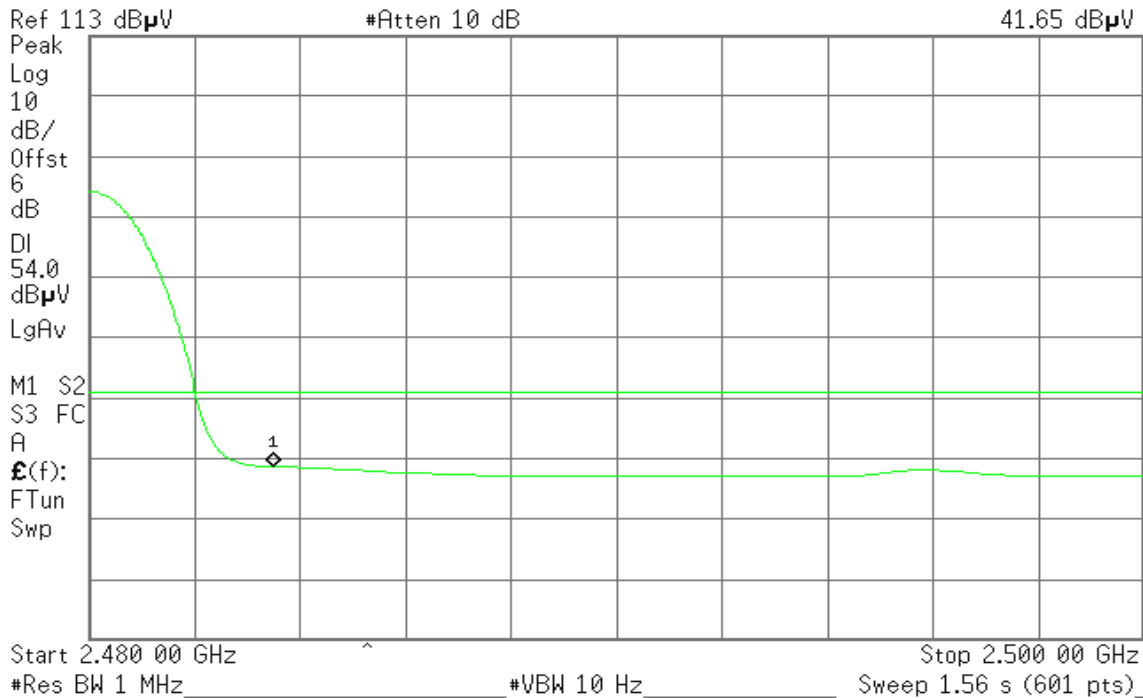

7.5 PEAK POWER SPECTRAL DENSITY

LIMIT

1. According to §15.247(e), for digitally modulated systems, the power spectral density conducted from the intentional radiator to the antenna shall not be greater than 8 dBm in any 3 kHz band during any time interval of continuous transmission.
2. According to §15.247(f), the digital modulation operation of the hybrid system, with the frequency hopping turned off, shall comply with the power density requirements of paragraph (d) of this section.

Test Configuration

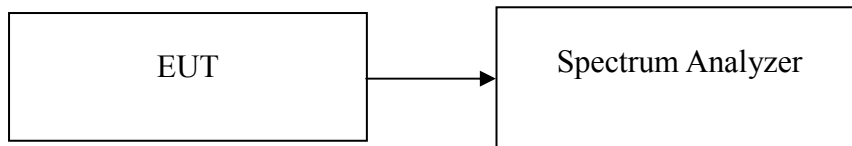

TEST PROCEDURE

1. Place the EUT on the table and set it in transmitting mode.
2. Remove the antenna from the EUT and then connect a low loss RF cable from the antenna port to the spectrum analyzer.
3. Set the spectrum analyzer as RBW = 3kHz, VBW = 10kHz, Span = 300kHz, Sweep=100s
4. Record the max. reading.
5. Repeat the above procedure until the measurements for all frequencies are completed.

TEST RESULTS

No non-compliance noted



Test Data

For GFSK / DH5

Channel	Frequency (MHz)	PPSD (dBm)	Limit (dBm)	Result
Low	2402	-3.71	8.00	PASS
Mid	2441	-4.15		PASS
High	2480	-4.83		PASS

For 8DPSK / DH5

Channel	Frequency (MHz)	PPSD (dBm)	Limit (dBm)	Result
Low	2402	-9.11	8.00	PASS
Mid	2441	-17.05		PASS
High	2480	-18.95		PASS



Test Plot

For GFSK / DH5

PPSD (CH Low)

Agilent 17:38:09 Apr 27, 2010

R T

Mkr1 2.401 948 9 GHz

-3.71 dBm

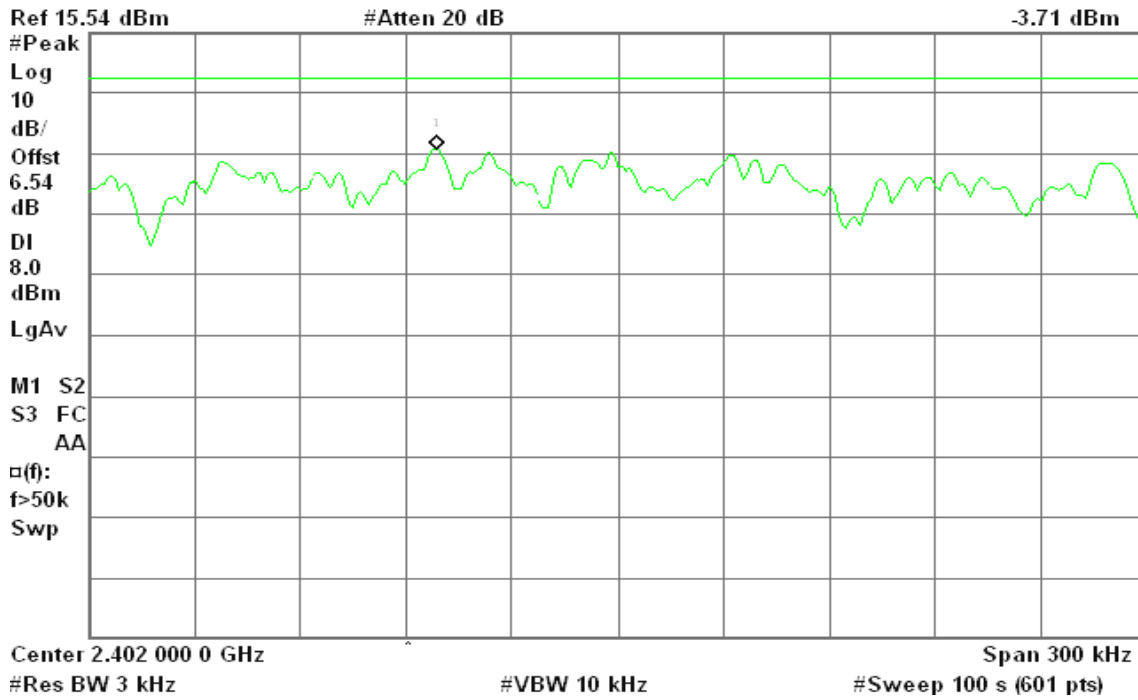

PPSD (CH Mid)

Agilent 17:41:01 Apr 27, 2010

R T

Mkr1 2.440 948 4 GHz

-4.15 dBm

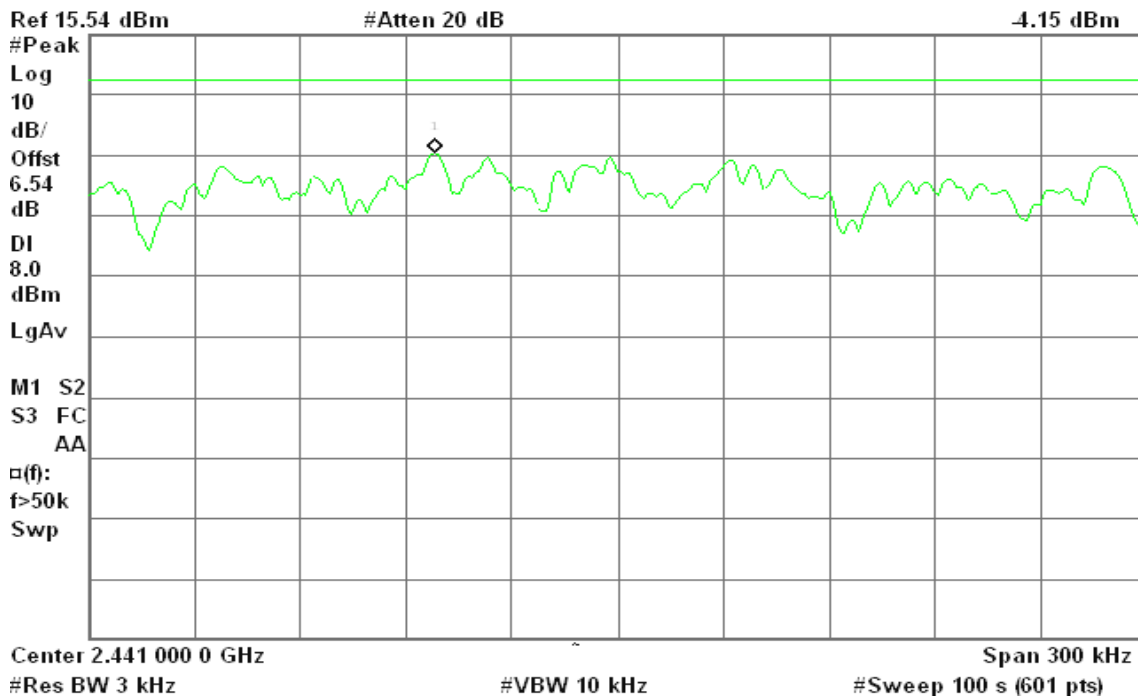



PPSD (CH High)

Agilent 17:43:49 Apr 27, 2010

R T

Mkr1 2.479 947 7 GHz

-4.83 dBm

Ref 15.54 dBm

#Atten 20 dB

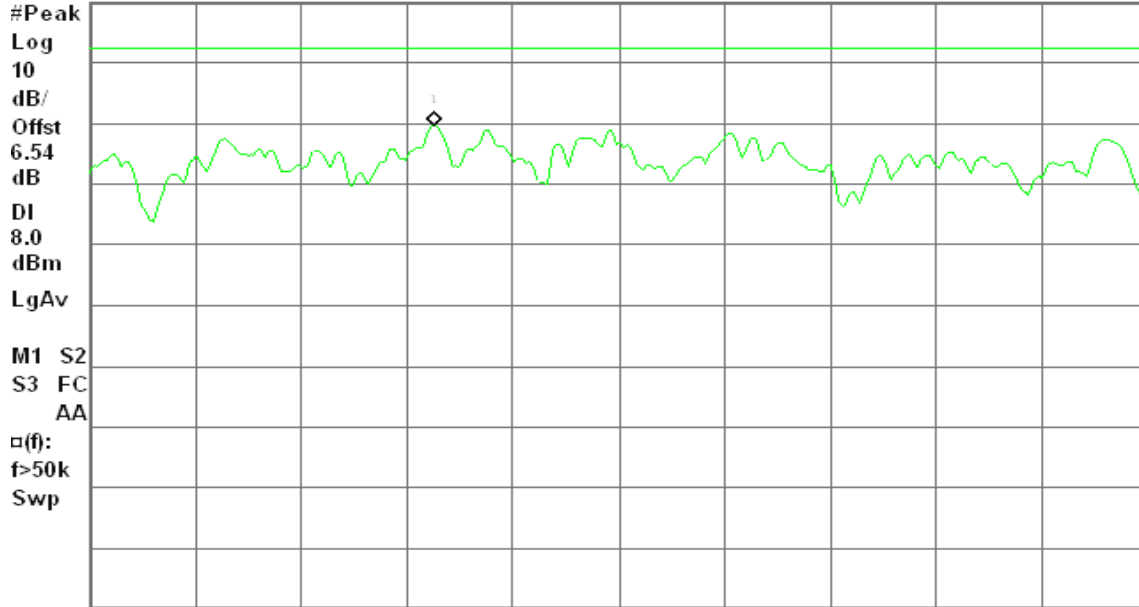

Center 2.480 000 0 GHz

Span 300 kHz

#Res BW 3 kHz

#VBW 10 kHz

#Sweep 100 s (601 pts)



For 8DPSK / DH5

PPSD (CH Low)

Agilent 18:24:34 Apr 27, 2010

R T

Mkr1 2.402 141 5 GHz

-9.11 dBm

Ref 15.54 dBm

#Atten 20 dB

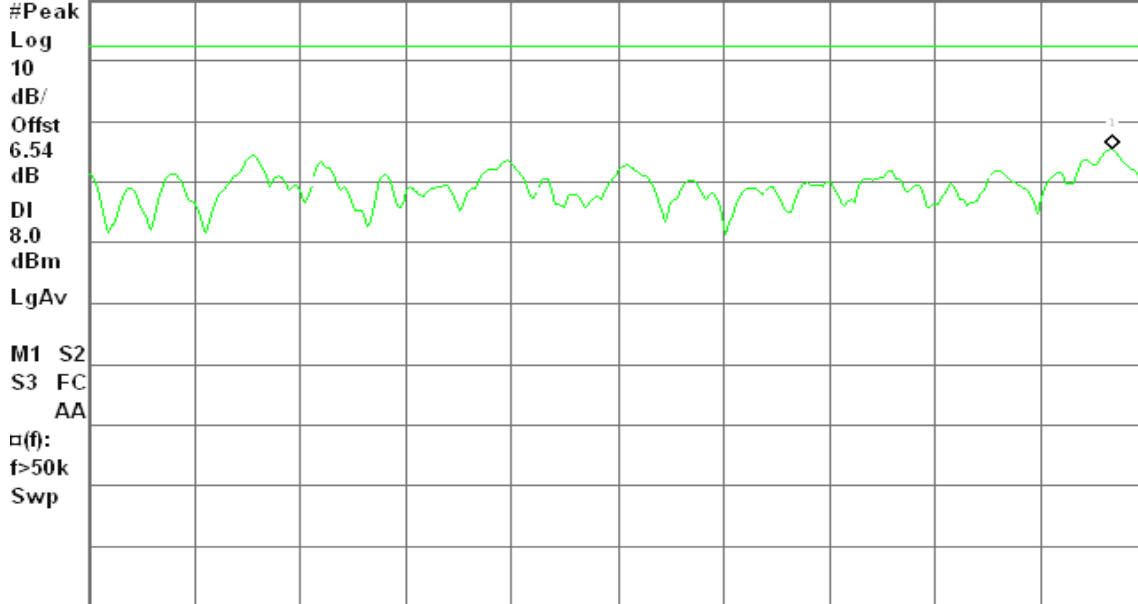

Center 2.402 000 0 GHz

Span 300 kHz

#Res BW 3 kHz

#VBW 10 kHz

#Sweep 100 s (601 pts)

PPSD (CH Mid)

Agilent 18:43:36 Apr 27, 2010

R T

Mkr1 2.440 911 9 GHz

-17.05 dBm

Ref 15.54 dBm

#Atten 20 dB

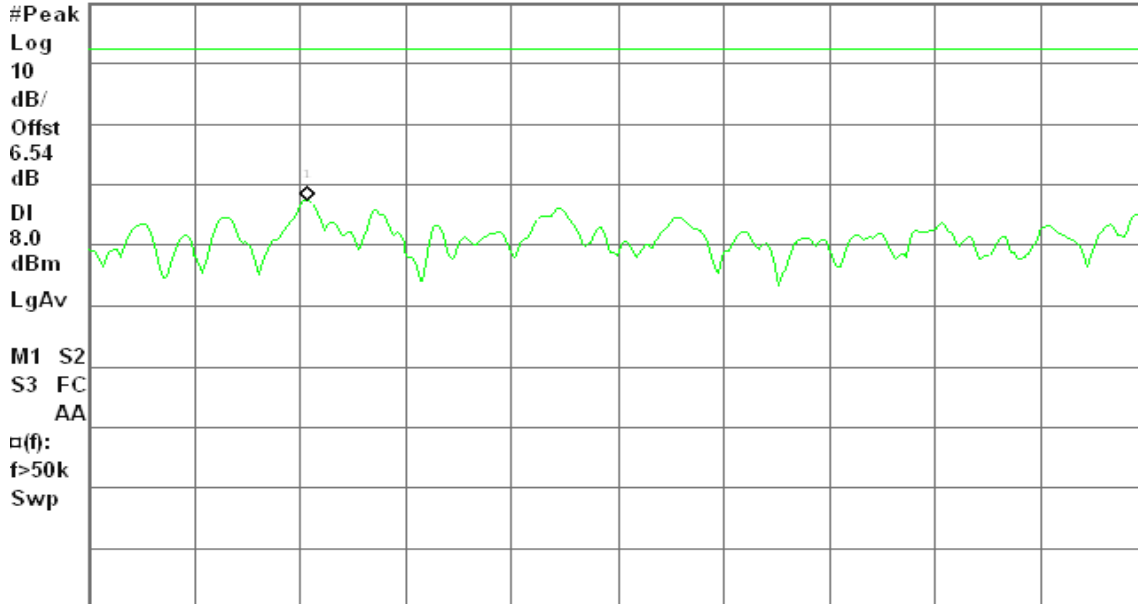

Center 2.441 000 0 GHz

Span 300 kHz

#Res BW 3 kHz

#VBW 10 kHz

#Sweep 100 s (601 pts)



PPSD (CH High)

Agilent 18:47:14 Apr 27, 2010

R T

Mkr1 2.479 910 9 GHz

-18.95 dBm

Ref 15.54 dBm

#Atten 20 dB

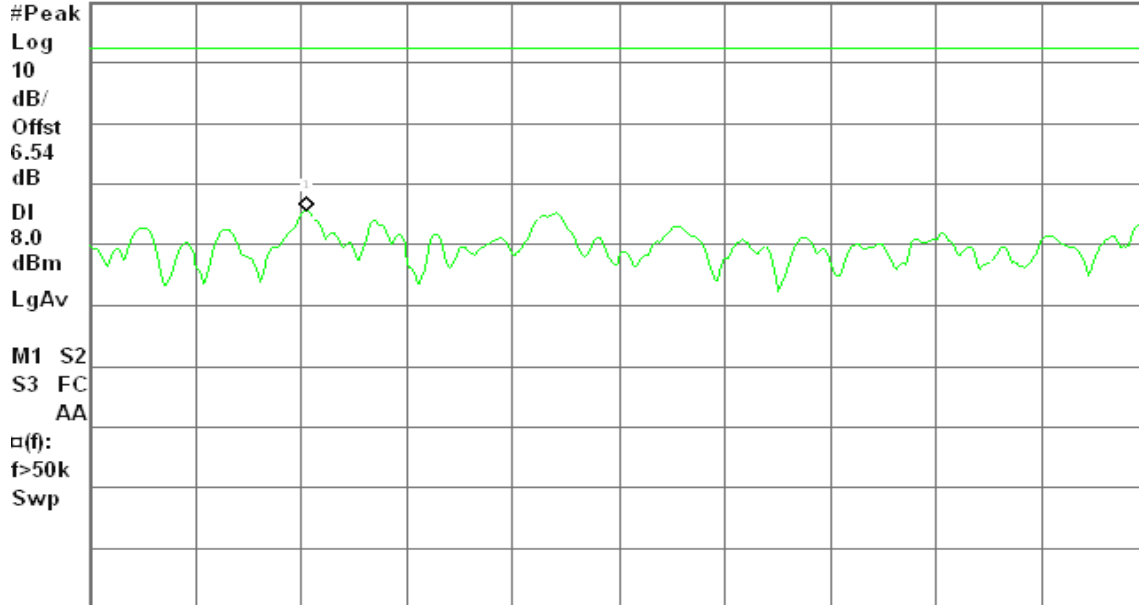

Center 2.480 000 0 GHz

Span 300 kHz

#Res BW 3 kHz

#VBW 10 kHz

#Sweep 100 s (601 pts)



7.6 FREQUENCY SEPARATION

LIMIT

According to §15.247(a)(1), Frequency hopping systems shall have hopping channel carrier frequencies separated by a minimum of 25 kHz or the 20 dB bandwidth of the hopping channel, whichever is greater. Alternatively, frequency hopping systems operating in the 2400-2483.5 MHz band may have hopping channel carrier frequencies that are separated by 25 kHz or two-thirds of the 20 dB bandwidth of the hopping channel, whichever is greater, provided the systems operate with an output power no greater than 125 mW.

Test Configuration

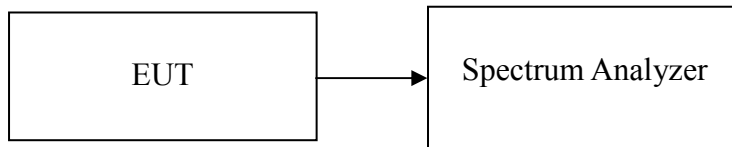

TEST PROCEDURE

1. Place the EUT on the table and set it in transmitting mode.
2. Remove the antenna from the EUT and then connect a low loss RF cable from the antenna port to the spectrum analyzer.
3. Set center frequency of spectrum analyzer = middle of hopping channel.
4. Set the spectrum analyzer as RBW = 30kHz, VBW = 100kHz, Span = 3MHz, Sweep = auto.
5. Max hold, mark 3 peaks of hopping channel and record the 3 peaks frequency.

TEST RESULTS

No non-compliance noted

Test Data

For GFSK / DH5

Channel Separation (MHz)	two-thirds of the 20 dB bandwidth (kHz)	Channel Separation Limit	Result
1.00	619.3	>two-thirds of the 20 dB bandwidth	Pass

For 8DPSK / DH5

Channel Separation (MHz)	two-thirds of the 20 dB bandwidth (kHz)	Channel Separation Limit	Result
1.00	802	>two-thirds of the 20 dB bandwidth	Pass



Test Plot

For GFSK / DH5

Measurement of Channel Separation

Agilent 17:49:54 Apr 27, 2010

R T

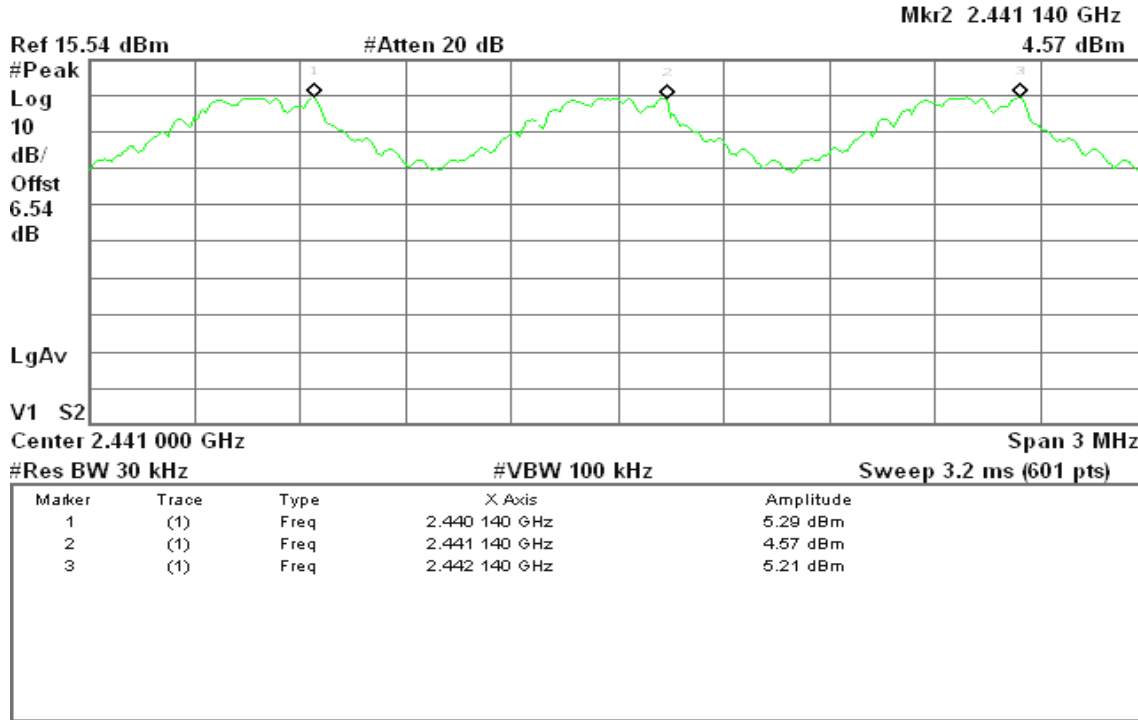

Measurement of 20dB Bandwidth

Agilent 15:42:02 Apr 27, 2010

R T

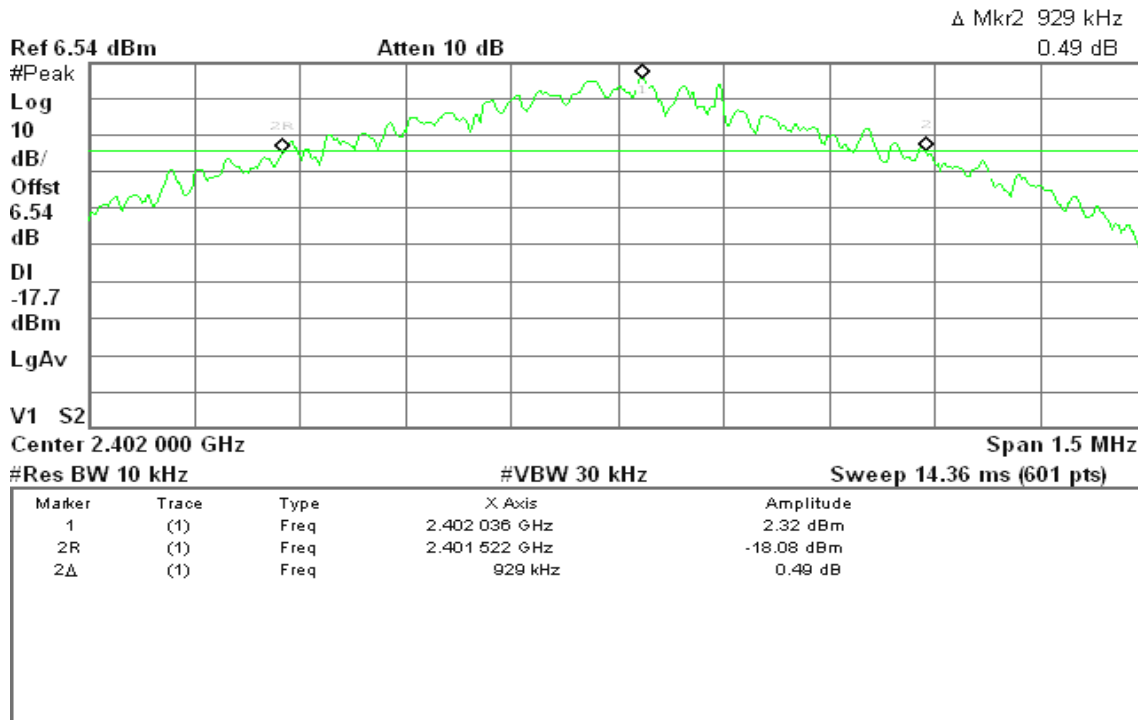



For 8DPSK / DH5

Measurement of Channel Separation

Agilent 17:52:40 Apr 27, 2010

R T

Mkr3 2.441 815 GHz

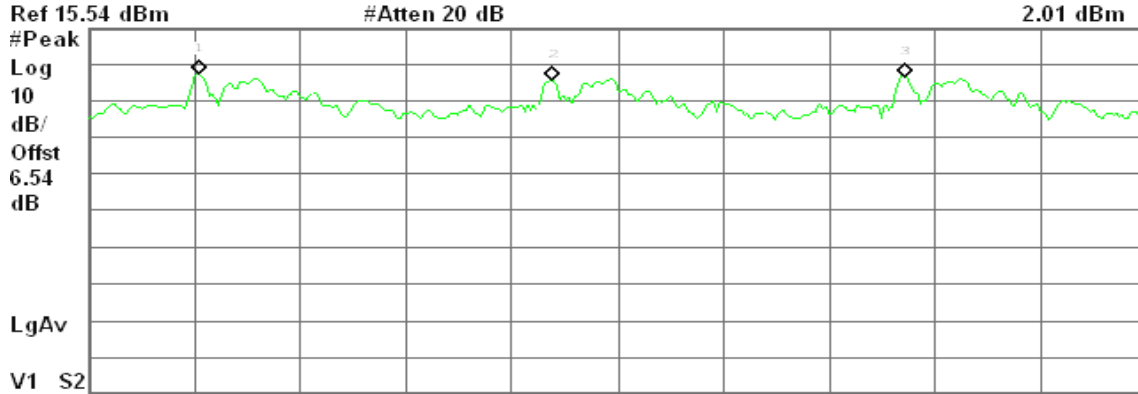

Center 2.441 000 GHz Span 3 MHz
 #Res BW 30 kHz #VBW 100 kHz Sweep 3.2 ms (601 pts)

Marker	Trace	Type	X Axis	Amplitude
1	(1)	Freq	2.439 815 GHz	3.12 dBm
2	(1)	Freq	2.440 815 GHz	1.27 dBm
3	(1)	Freq	2.441 815 GHz	2.01 dBm

Measurement of 20dB Bandwidth

Agilent 17:54:51 Apr 27, 2010

R T

Δ Mkr2 1.203 MHz

-2.50 dB

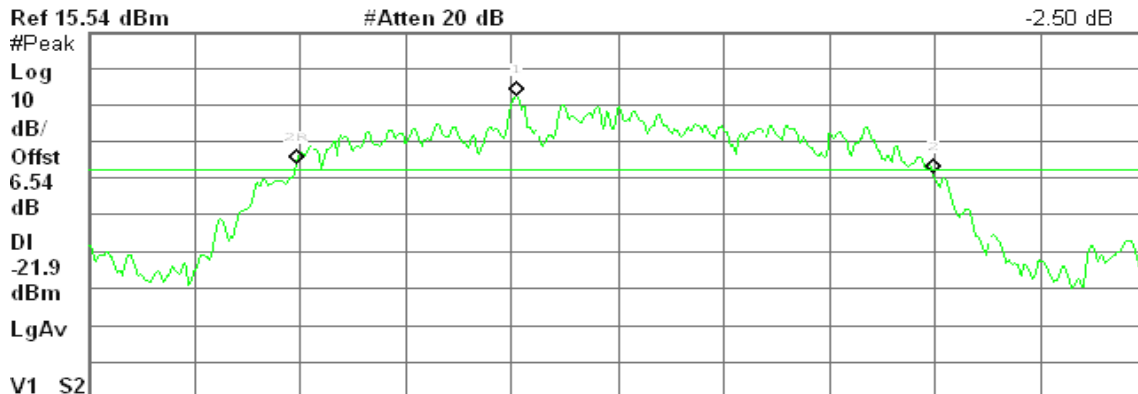

Center 2.441 000 GHz Span 2 MHz
 #Res BW 10 kHz #VBW 30 kHz Sweep 19.12 ms (601 pts)

Marker	Trace	Type	X Axis	Amplitude
1	(1)	Freq	2.440 810 GHz	-1.94 dBm
2R	(1)	Freq	2.440 393 GHz	-20.31 dBm
2Δ	(1)	Freq	1.203 MHz	-2.50 dB



7.7 NUMBER OF HOPPING FREQUENCY

LIMIT

According to §15.247(a)(1)(iii), Frequency hopping systems operating in the 2400MHz-2483.5 MHz bands shall use at least 15 hopping frequencies.

Test Configuration

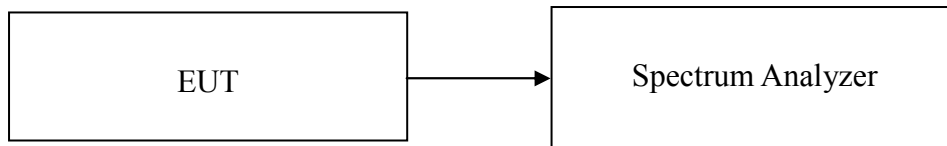

TEST PROCEDURE

1. Place the EUT on the table and set it in transmitting mode.
2. Remove the antenna from the EUT and then connect a low loss RF cable from the antenna port to the spectrum analyzer.
3. Set spectrum analyzer Start=2400MHz, Stop = 2441.5MHz, Sweep = auto and Start=2441.5MHz, Stop = 2483.5MHz, Sweep = auto.
4. Set the spectrum analyzer as RBW, VBW=510kHz.
5. Max hold, view and count how many channel in the band.

TEST RESULTS

No non-compliance noted

Test Data

For GFSK / 8DPSK

Result (No. of CH)	Limit (No. of CH)	Result
79	>15	PASS



Test Plot

For GFSK

Channel Number

2.4 GHz – 2.4415 GHz

Agilent 17:22:19 Apr 27, 2010

R T

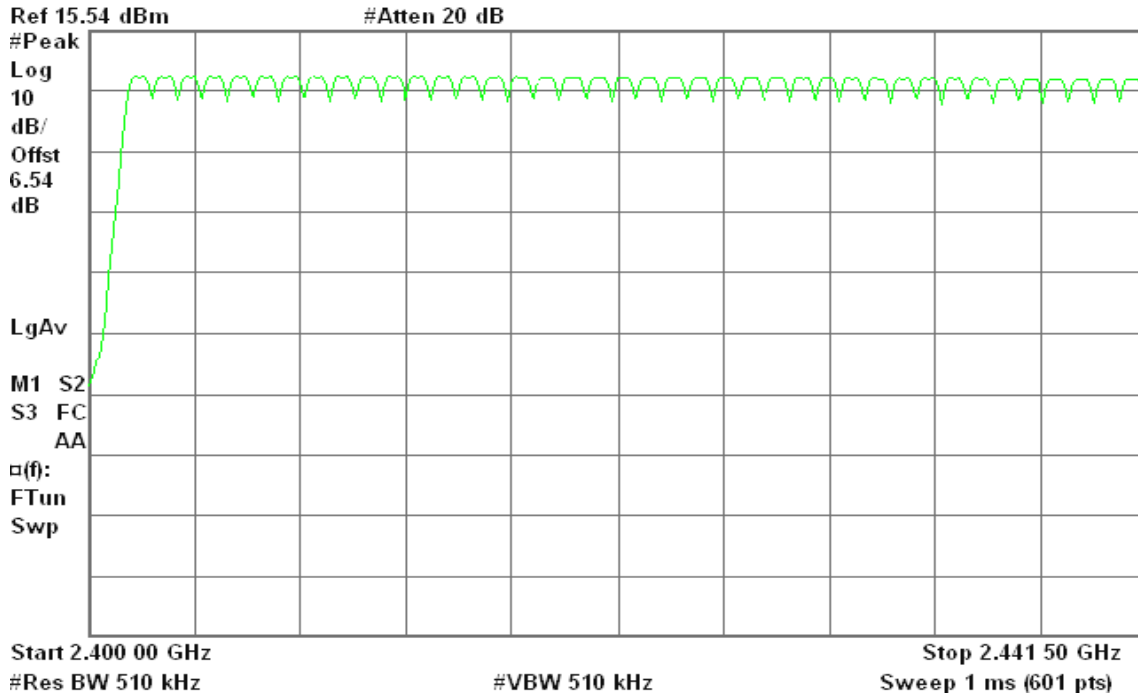

2.4415 GHz – 2.4835 GHz

Agilent 17:29:06 Apr 27, 2010

R T

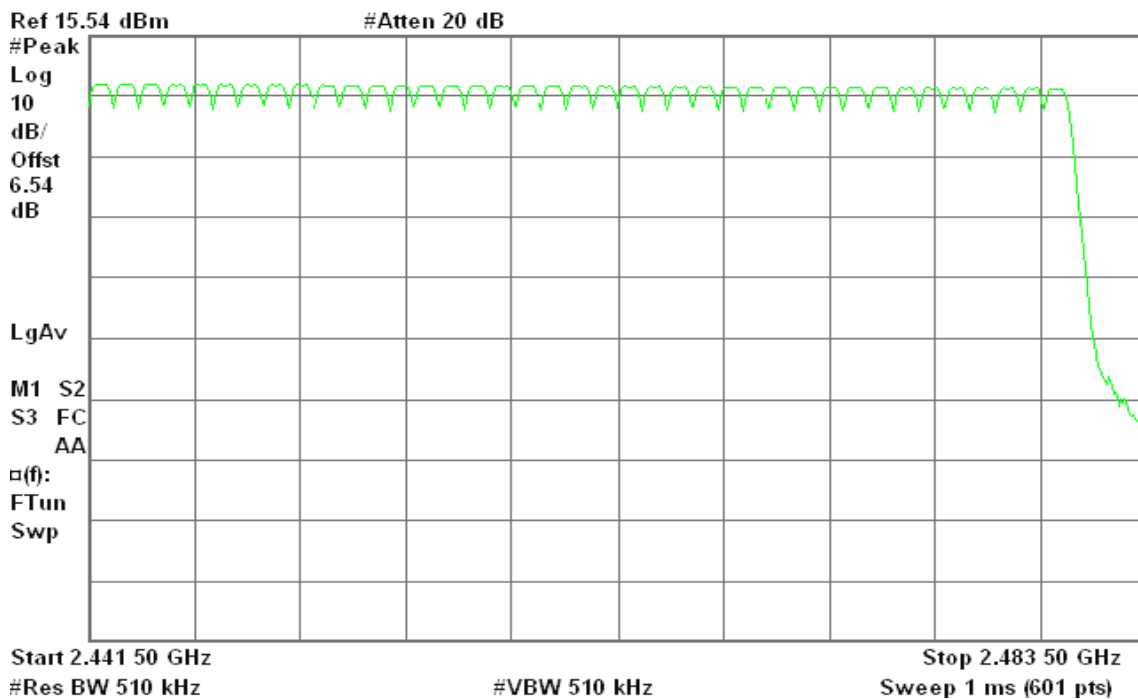



For 8DPSK

Channel Number

2.4 GHz – 2.4415 GHz

* Agilent 18:19:11 Apr 27, 2010

R T

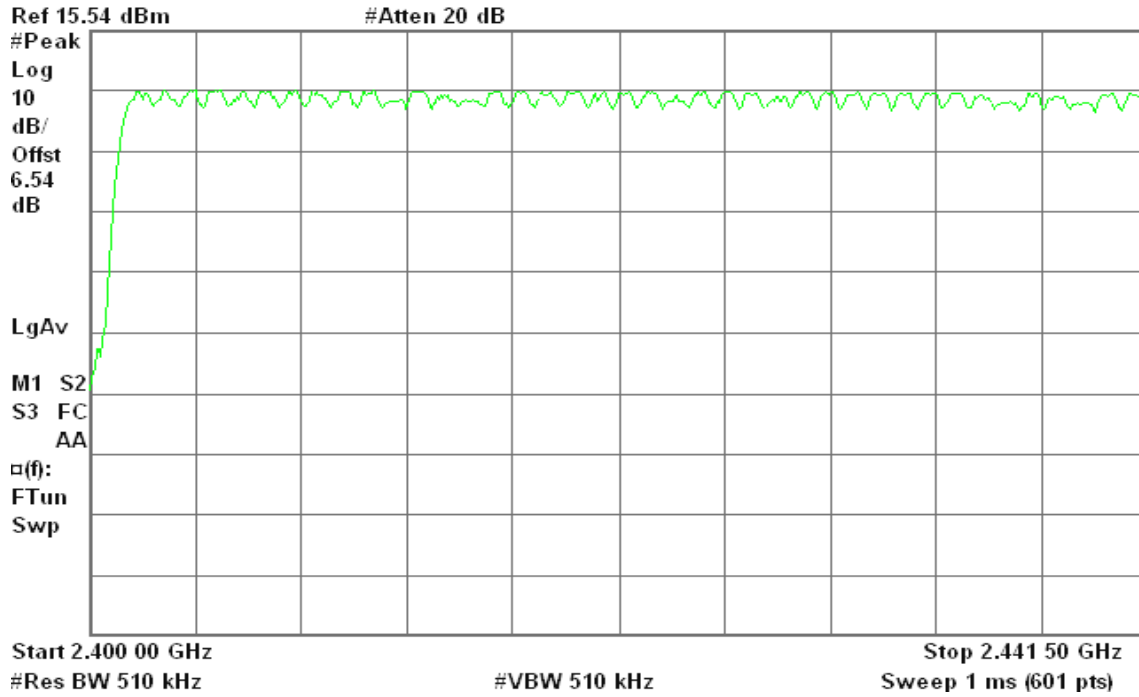

2.4415 GHz – 2.4835 GHz

* Agilent 18:21:40 Apr 27, 2010

R T

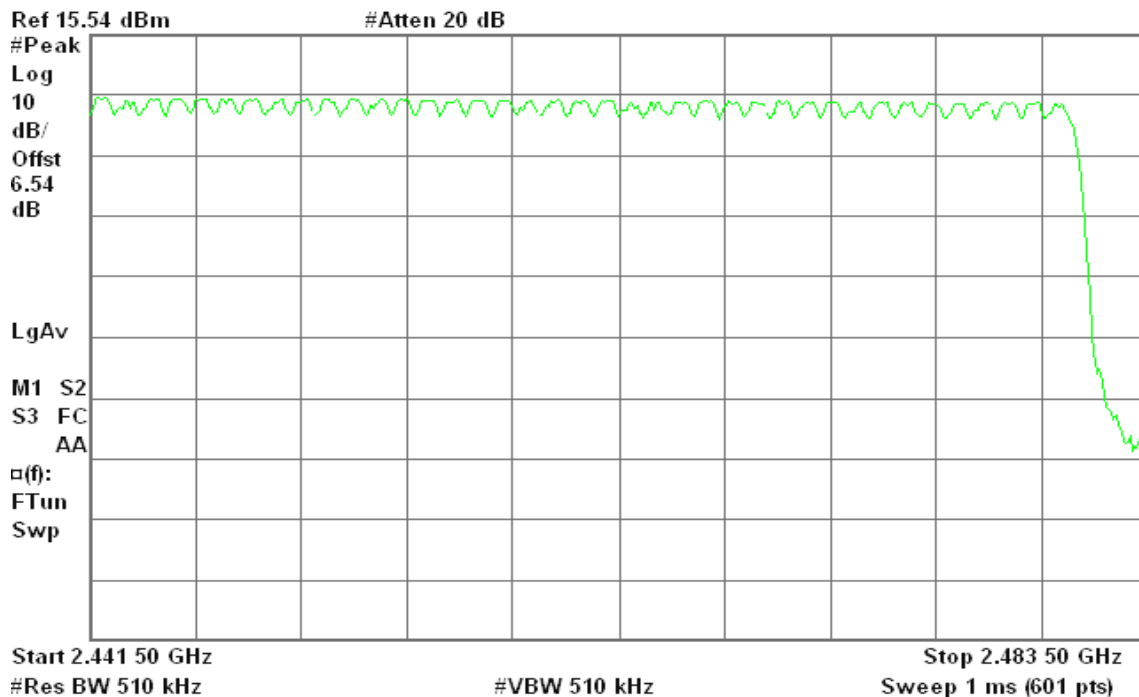



7.8 TIME OF OCCUPANCY (DWELL TIME)

LIMIT

According to §15.247(a)(1)(iii), Frequency hopping systems operating in the 2400MHz-2483.5 MHz bands. The average time of occupancy on any channels shall not greater than 0.4 s within a period 0.4 s multiplied by the number of hopping channels employed.

Test Configuration

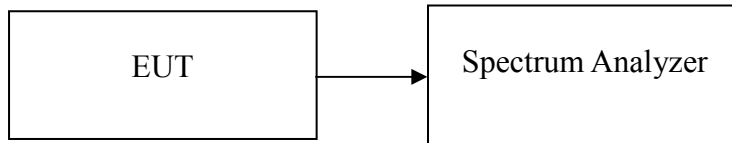

TEST PROCEDURE

1. Place the EUT on the table and set it in transmitting mode.
2. Remove the antenna from the EUT and then connect a low loss RF cable from the antenna port to the spectrum analyzer.
3. Set center frequency of spectrum analyzer = operating frequency.
4. Set the spectrum analyzer as RBW, VBW=1MHz, Span = 0Hz, Sweep = auto.
5. Repeat above procedures until all frequency measured were complete.



Test Data

For GFSK

DH 1

CH Low: $0.350 * (1600/2)/79 * 31.6 = 112.000$ (ms)

CH Mid: $0.350 * (1600/2)/79 * 31.6 = 112.000$ (ms)

CH High: $0.383 * (1600/2)/79 * 31.6 = 122.560$ (ms)

CH	Pulse Time (ms)	Total of Dwell (ms)	Period Time (s)	Limit (ms)	Result
Low	0.350	112.000	31.60	400.00	PASS
Mid	0.350	112.000	31.60		PASS
High	0.383	122.560	31.60		PASS

DH 3

CH Low: $1.617 * (1600/4)/79 * 31.6 = 258.720$ (ms)

CH Mid: $1.617 * (1600/4)/79 * 31.6 = 258.720$ (ms)

CH High: $1.633 * (1600/4)/79 * 31.6 = 261.280$ (ms)

CH	Pulse Time (ms)	Total of Dwell (ms)	Period Time (s)	Limit (ms)	Result
Low	1.617	258.720	31.60	400.00	PASS
Mid	1.617	258.720	31.60		PASS
High	1.633	261.280	31.60		PASS

DH 5

CH Low: $2.883 * (1600/6)/79 * 31.6 = 307.520$ (ms)

CH Mid: $2.883 * (1600/6)/79 * 31.6 = 307.520$ (ms)

CH High: $2.883 * (1600/6)/79 * 31.6 = 307.520$ (ms)

CH	Pulse Time (ms)	Total of Dwell (ms)	Period Time (s)	Limit (ms)	Result
Low	2.883	307.520	31.60	400.00	PASS
Mid	2.883	307.520	31.60		PASS
High	2.883	307.520	31.60		PASS



Test Plot

For GFSK

DH 1

CH Low

Agilent 16:33:41 Apr 27, 2010

R T

Δ Mkr1 350 μs
-0.08 dB

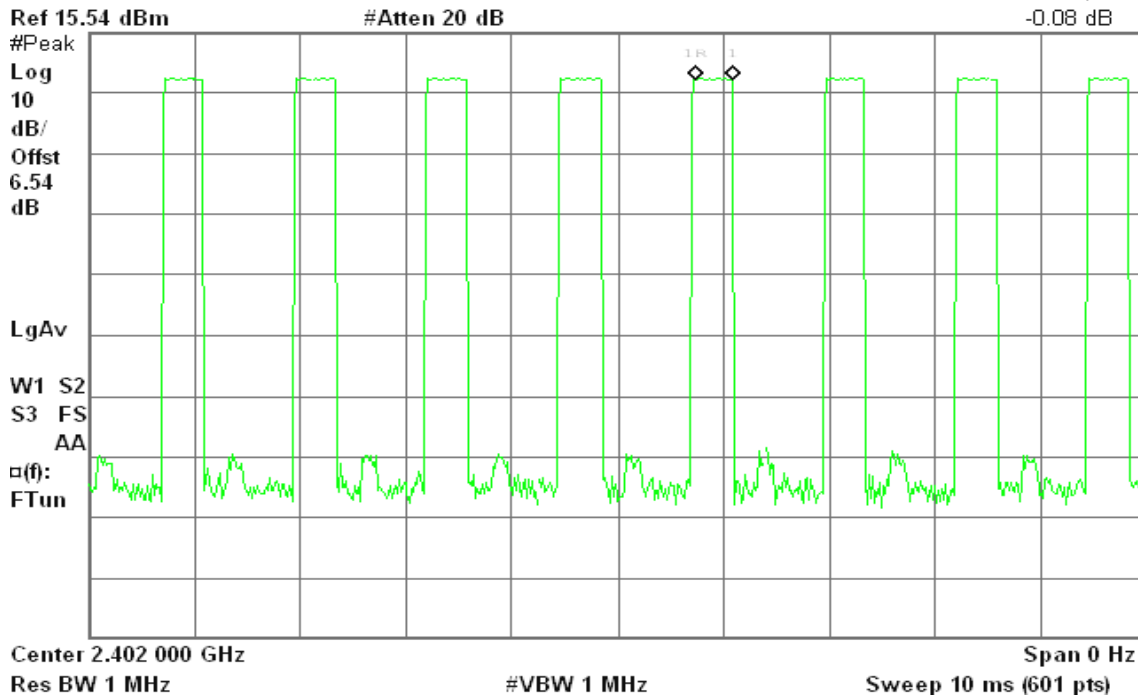

CH Mid

Agilent 16:27:26 Apr 27, 2010

R T

Δ Mkr1 350 μs
0.04 dB

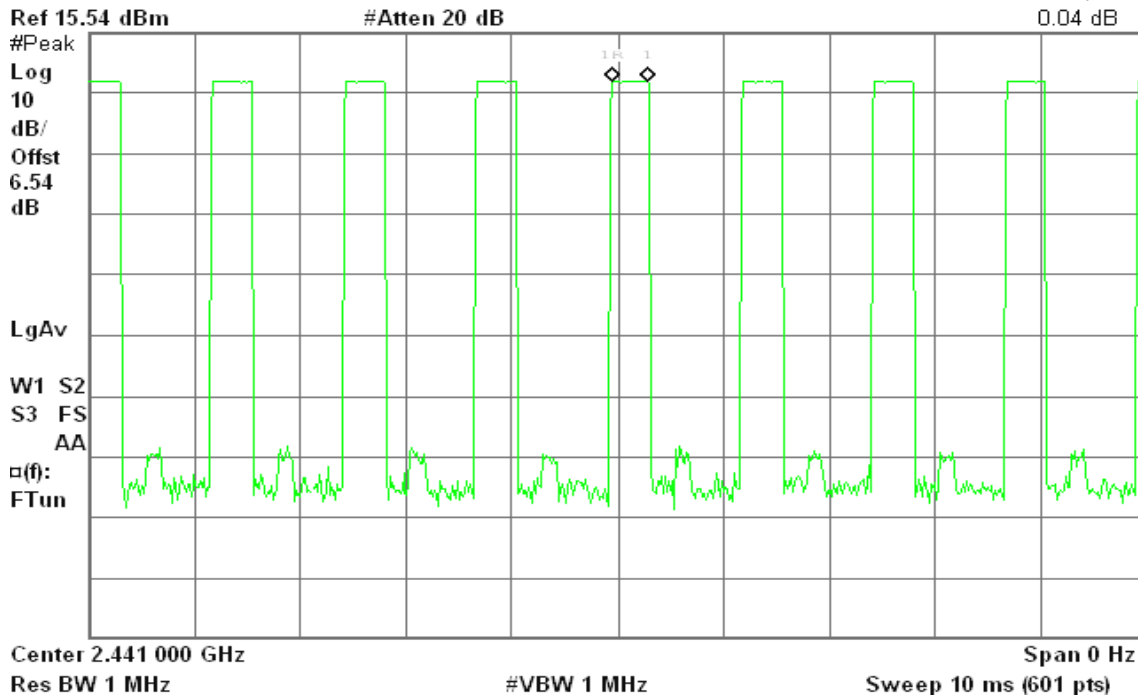



CH High

Agilent 15:54:46 Apr 27, 2010

R T

Δ Mkr1 383.3 μs
-2.60 dB

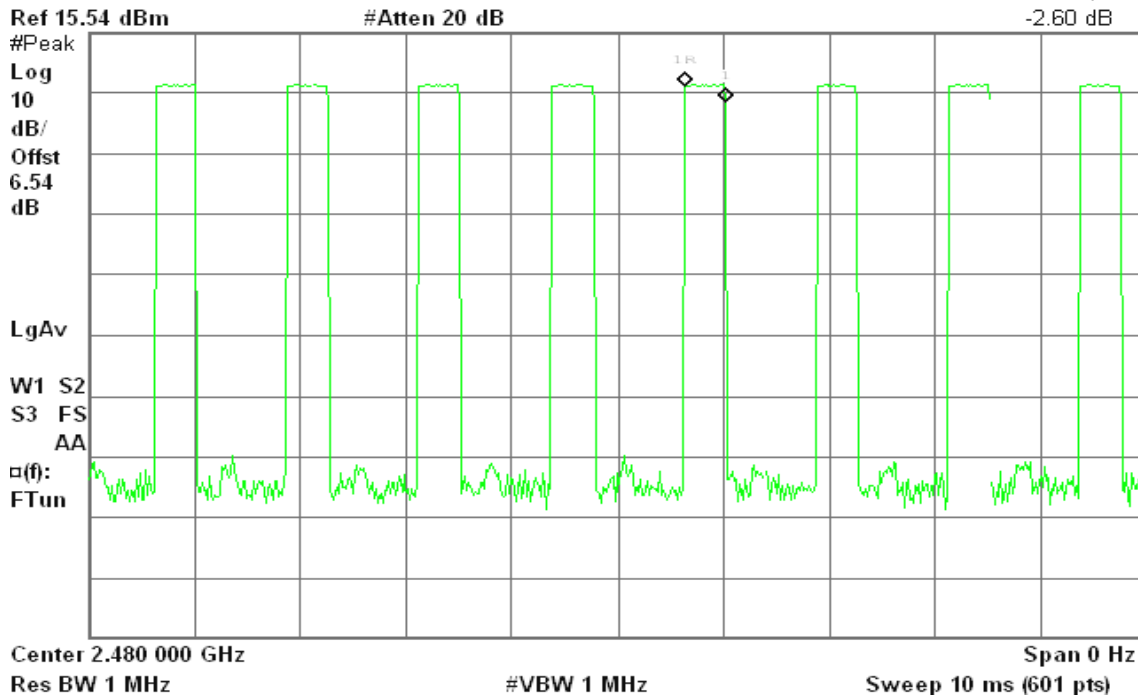

DH 3

CH Low

Agilent 16:34:04 Apr 27, 2010

R T

Δ Mkr1 1.617 ms
-0.21 dB

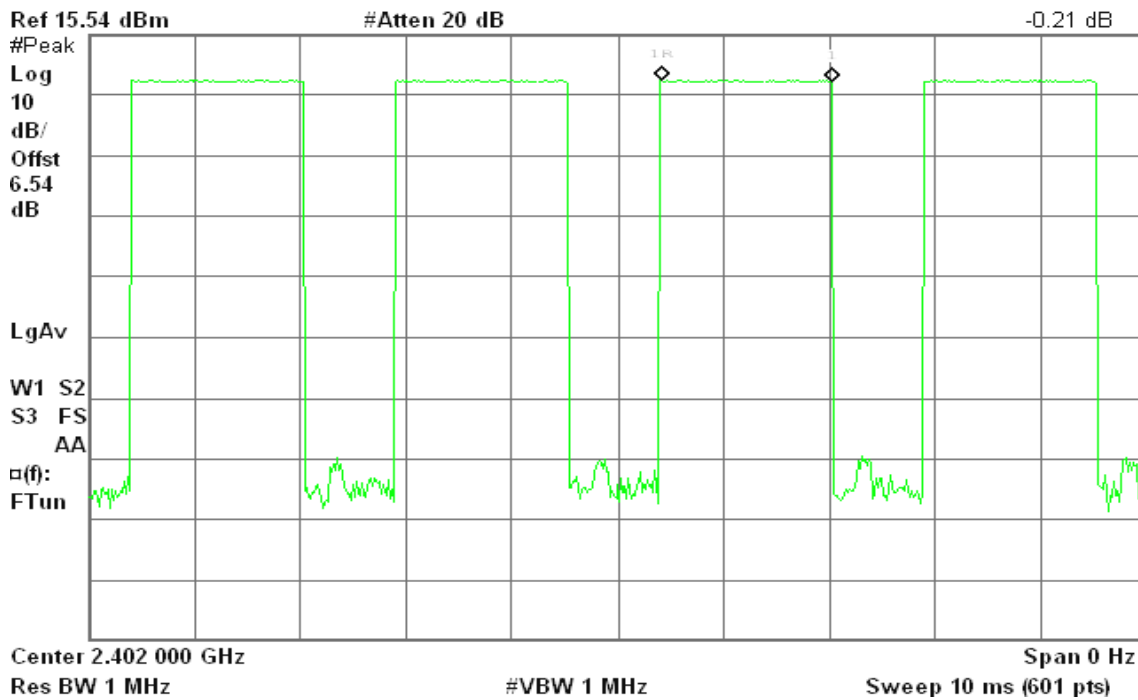



CH Mid

Agilent 16:28:45 Apr 27, 2010

R T

Δ Mkr1 1.617 ms
-0.12 dB

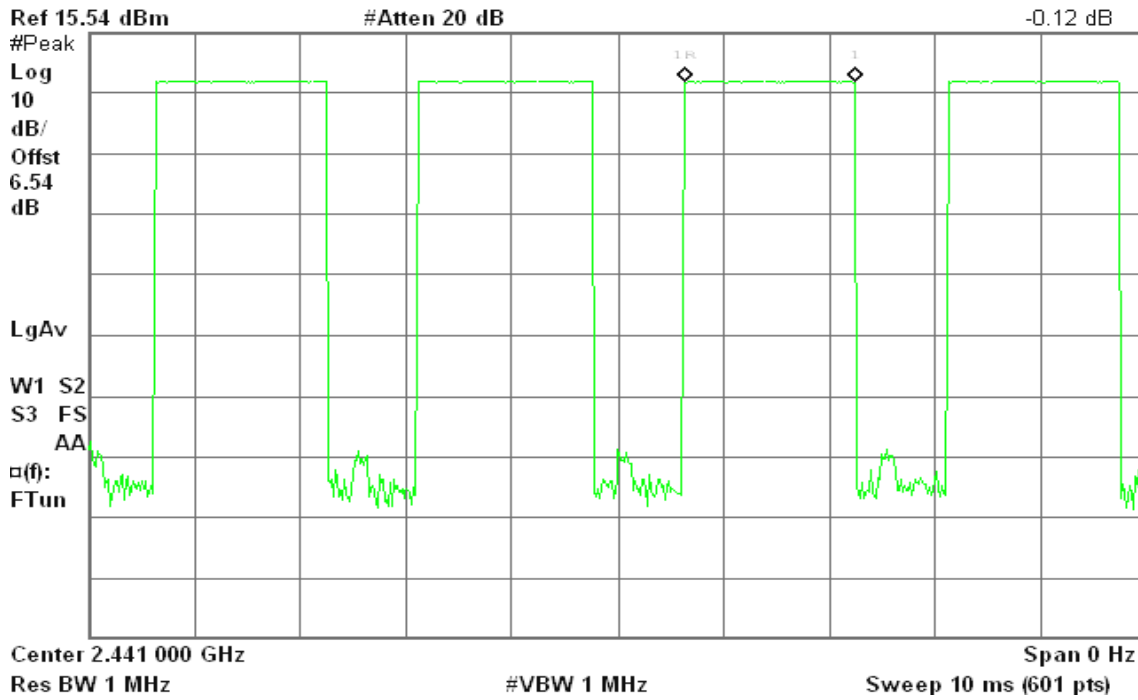

CH High

Agilent 15:55:24 Apr 27, 2010

R T

Δ Mkr1 1.633 ms
-0.09 dB

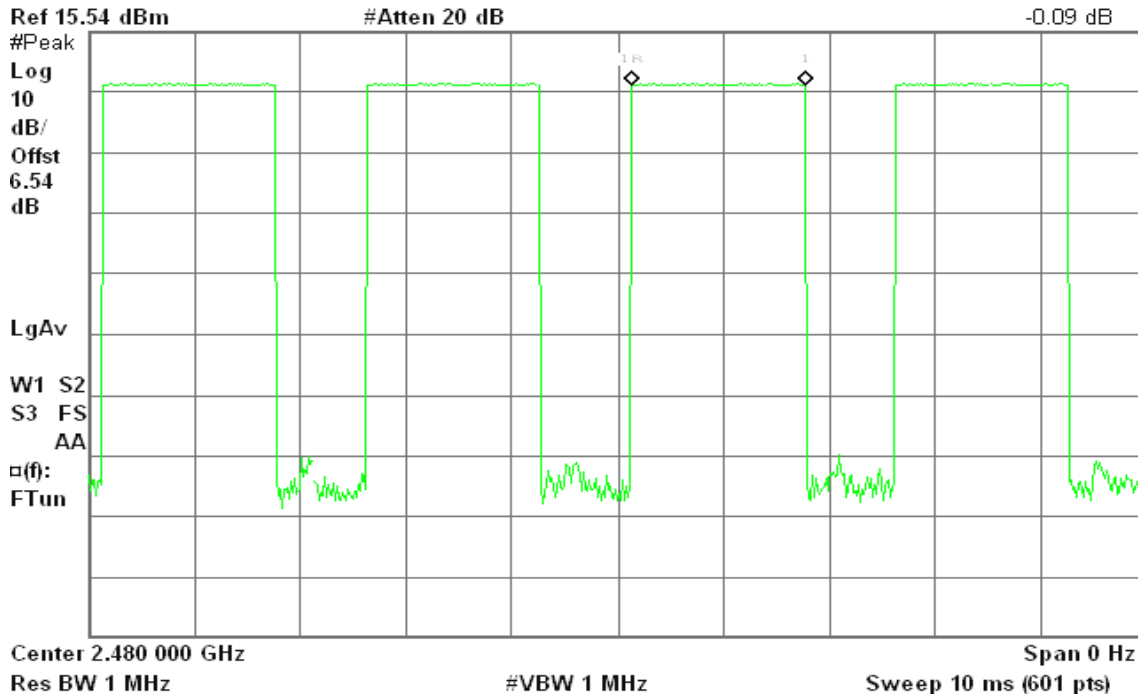



DH 5

CH Low

Agilent 16:34:29 Apr 27, 2010

R T

Δ Mkr1 2.883 ms
0.59 dB

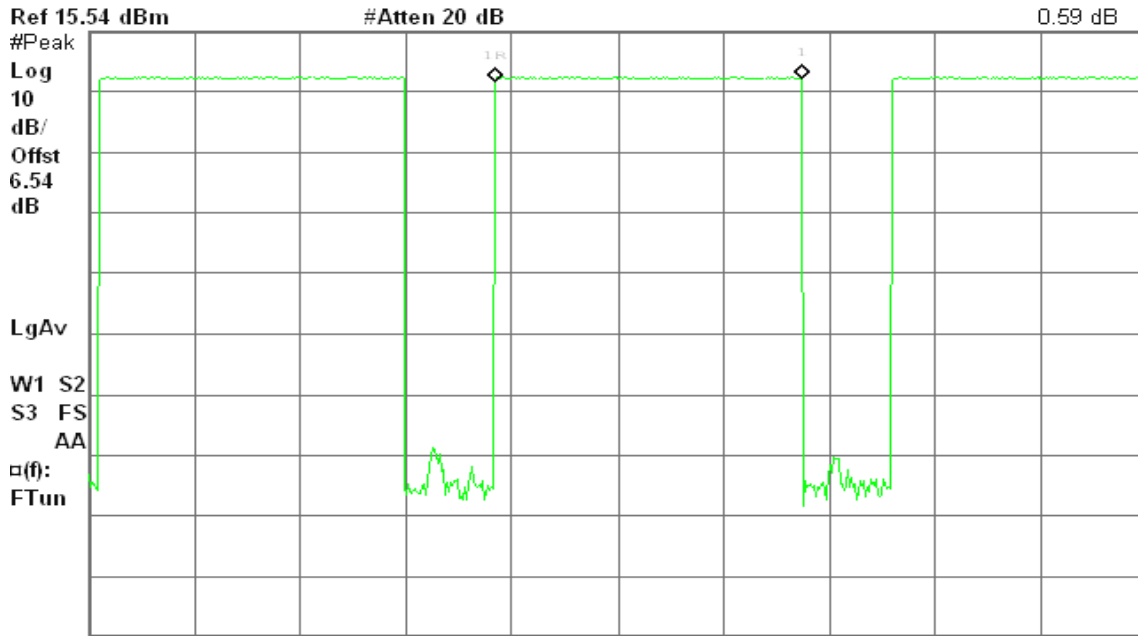

Center 2.402 000 GHz Span 0 Hz
Res BW 1 MHz #VBW 1 MHz Sweep 10 ms (601 pts)

CH Mid

Agilent 16:29:47 Apr 27, 2010

R T

Δ Mkr1 2.883 ms
0.26 dB

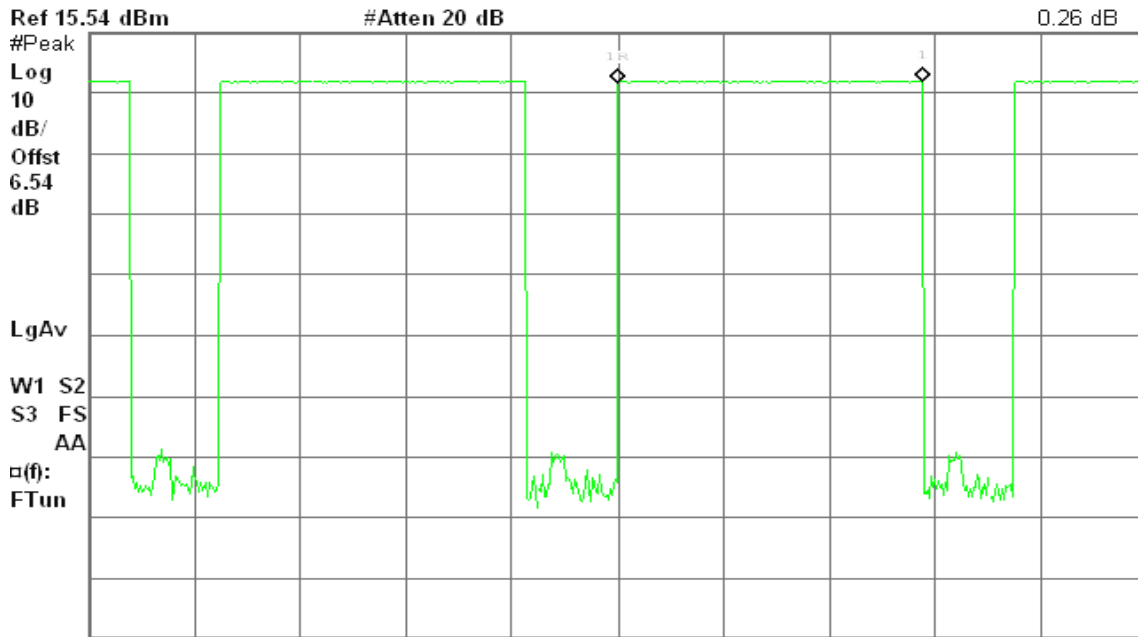

Center 2.441 000 GHz Span 0 Hz
Res BW 1 MHz #VBW 1 MHz Sweep 10 ms (601 pts)



CH High

Agilent 15:54:05 Apr 27, 2010

R T

Δ Mkr1 2.883 ms

0.01 dB

Ref 15.54 dBm

#Atten 20 dB

#Peak

Log

10

dB/

Offst

6.54

dB

LgAv

W1 S2

S3 FS

AA

□(f):

FTun

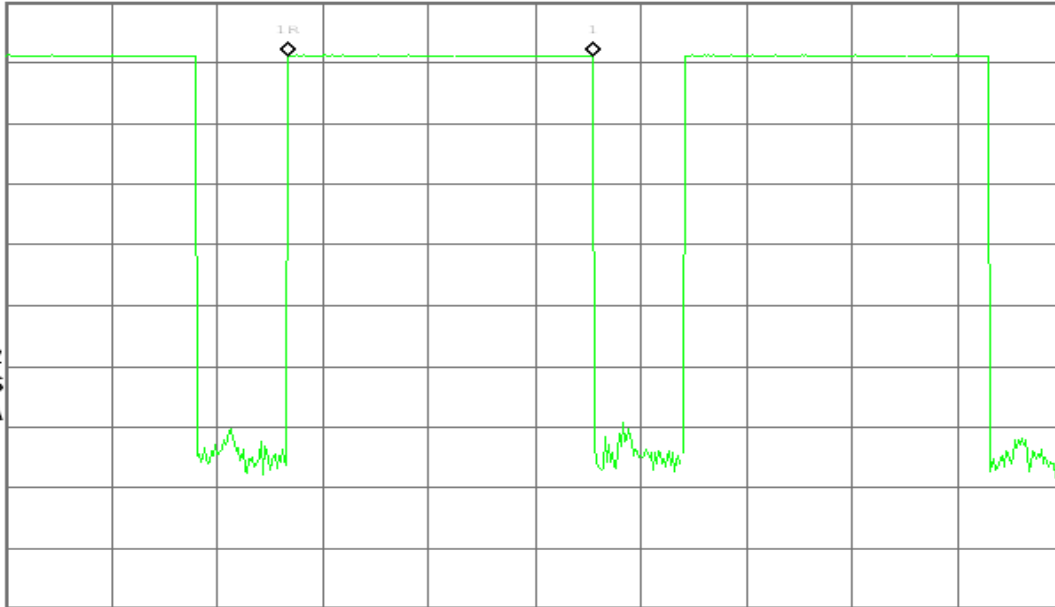

Center 2.480 000 GHz

Span 0 Hz

Res BW 1 MHz

#VBW 1 MHz

Sweep 10 ms (601 pts)



Test Data

For 8DPSK

DH 1

CH Low: $0.383 * (1600/2)/79 * 31.6 = 122.560$ (ms)

CH Mid: $0.383 * (1600/2)/79 * 31.6 = 122.560$ (ms)

CH High: $0.383 * (1600/2)/79 * 31.6 = 122.560$ (ms)

CH	Pulse Time (ms)	Total of Dwell (ms)	Period Time (s)	Limit (ms)	Result
Low	0.383	122.560	31.60	400.00	PASS
Mid	0.383	122.560	31.60		PASS
High	0.383	122.560	31.60		PASS

DH 3

CH Low: $1.617 * (1600/4)/79 * 31.6 = 258.720$ (ms)

CH Mid: $1.617 * (1600/4)/79 * 31.6 = 258.720$ (ms)

CH High: $1.633 * (1600/4)/79 * 31.6 = 261.280$ (ms)

CH	Pulse Time (ms)	Total of Dwell (ms)	Period Time (s)	Limit (ms)	Result
Low	1.617	258.720	31.60	400.00	PASS
Mid	1.617	258.720	31.60		PASS
High	1.633	261.280	31.60		PASS

DH 5

CH Low: $2.867 * (1600/6)/79 * 31.6 = 305.813$ (ms)

CH Mid: $2.850 * (1600/6)/79 * 31.6 = 304.000$ (ms)

CH High: $2.883 * (1600/6)/79 * 31.6 = 307.520$ (ms)

CH	Pulse Time (ms)	Total of Dwell (ms)	Period Time (s)	Limit (ms)	Result
Low	2.867	305.813	31.60	400.00	PASS
Mid	2.850	304.000	31.60		PASS
High	2.883	307.520	31.60		PASS



For 8DPSK

DH 1

CH Low

Agilent 18:10:06 Apr 27, 2010

R T

Δ Mkr1 383.3 μs
-1.64 dB

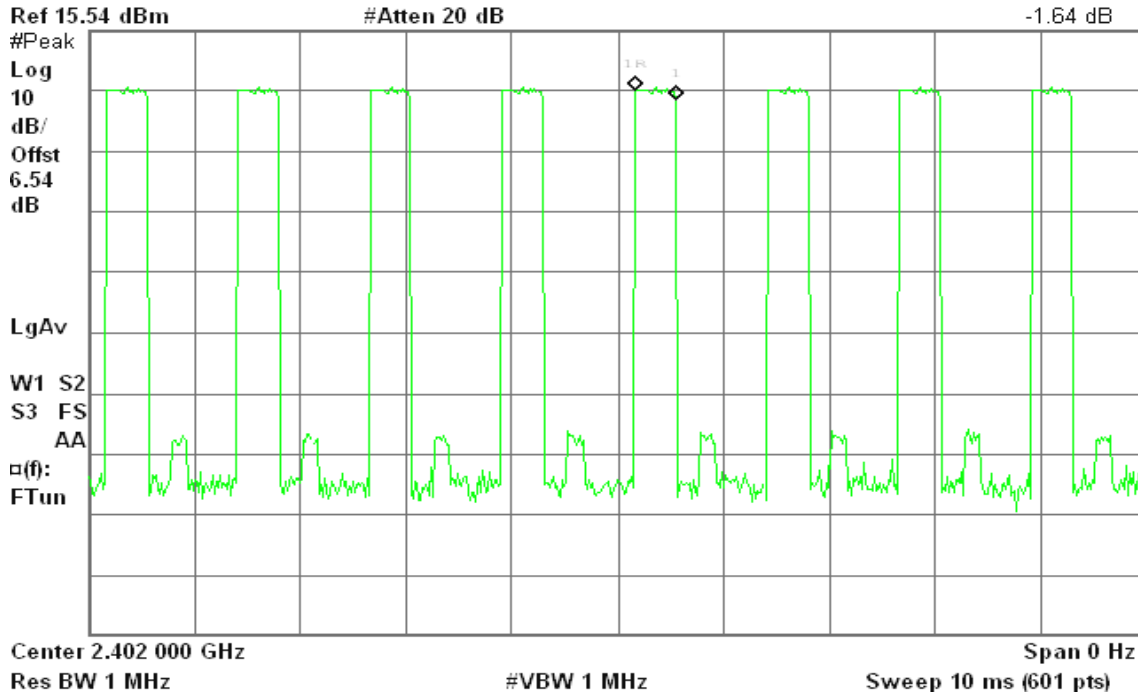

CH Mid

Agilent 18:12:38 Apr 27, 2010

R T

Δ Mkr1 383.3 μs
-0.27 dB





CH High

Agilent 18:14:15 Apr 27, 2010

R T

Δ Mkr1 383.3 μs
1.95 dB

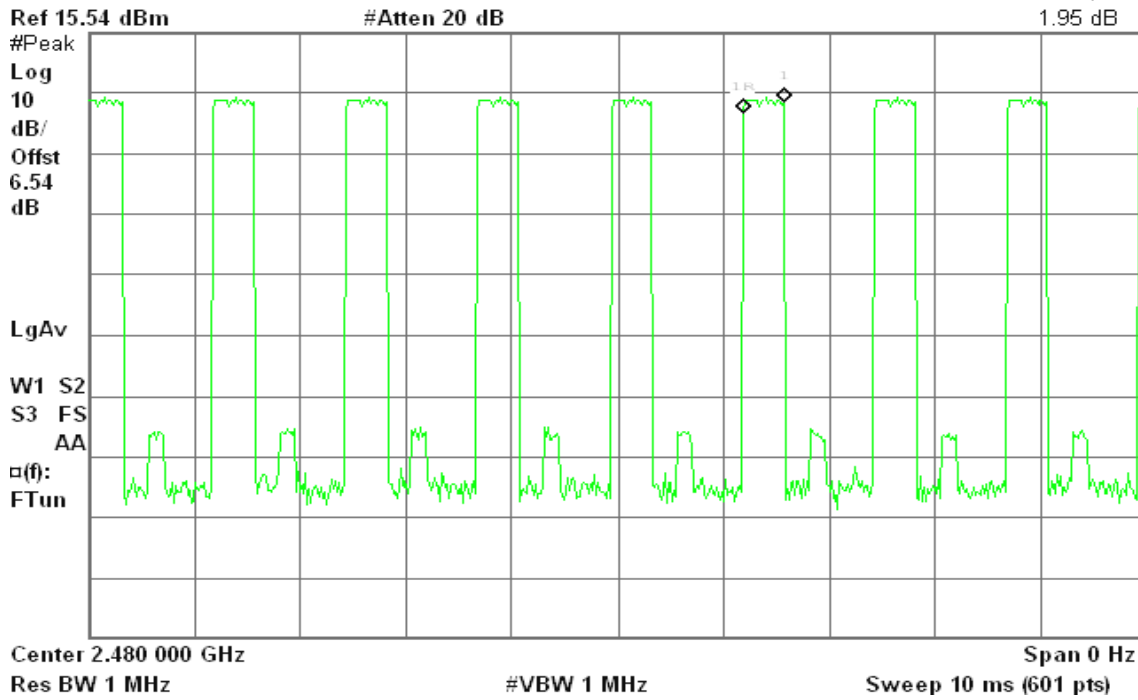

DH 3

CH Low

Agilent 18:10:56 Apr 27, 2010

R T

Δ Mkr1 1.617 ms
-0.62 dB

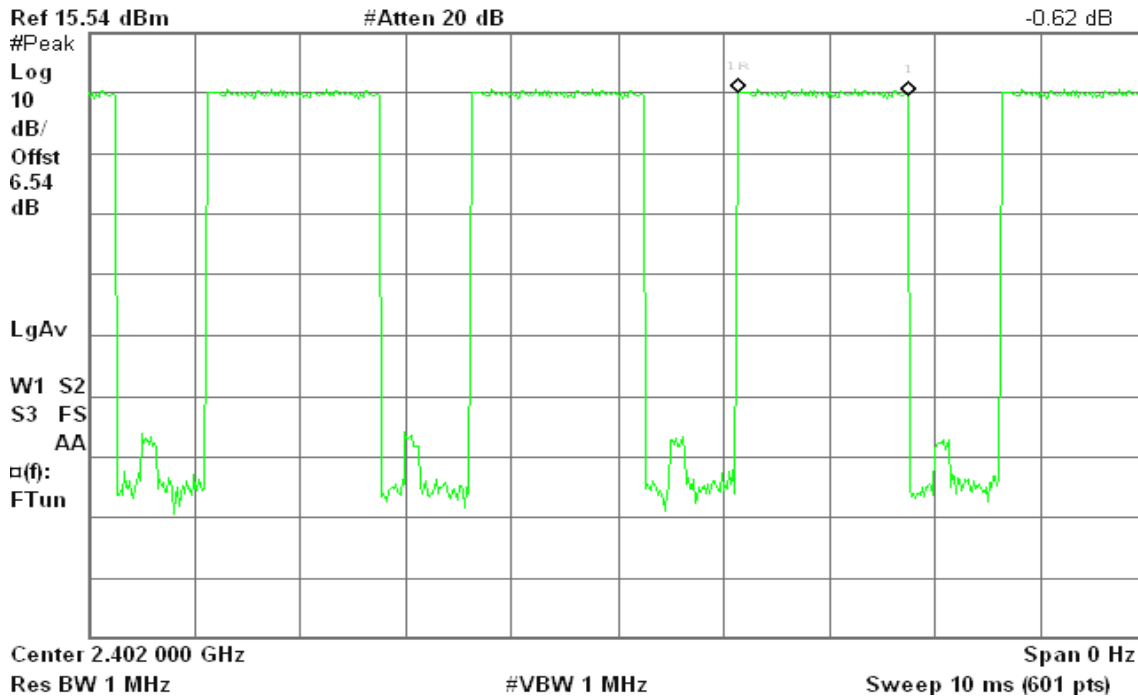



CH Mid

Agilent 18:13:21 Apr 27, 2010

R T

Δ Mkr1 1.617 ms
-0.33 dB

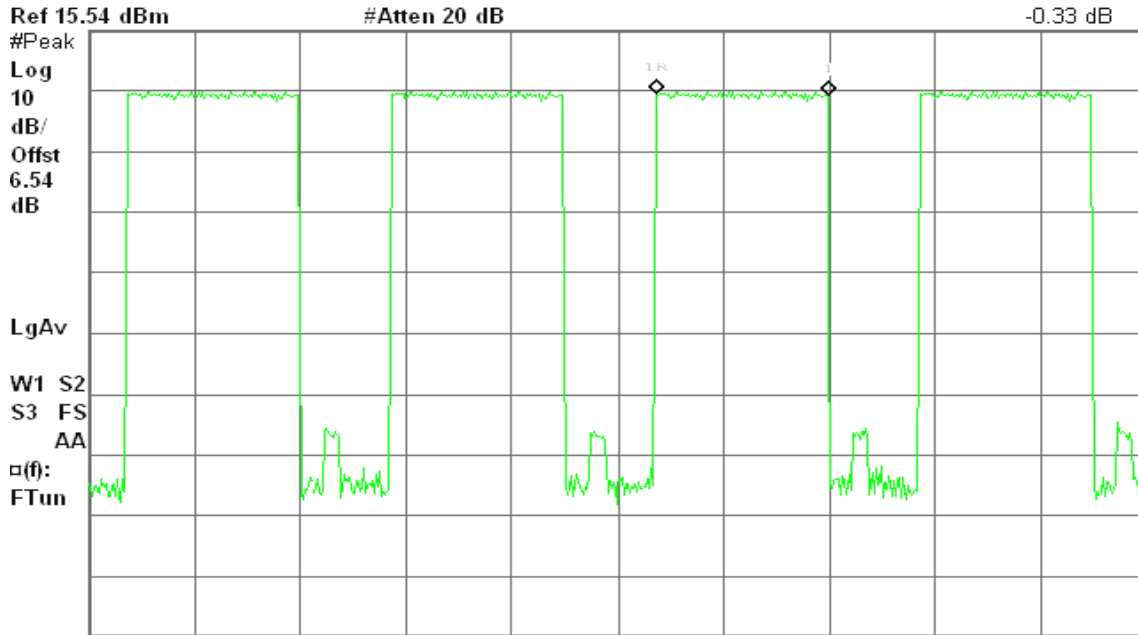

Center 2.441 000 GHz

Res BW 1 MHz

#VBW 1 MHz

Span 0 Hz
Sweep 10 ms (601 pts)

CH High

Agilent 18:15:09 Apr 27, 2010

R T

Δ Mkr1 1.633 ms
-0.53 dB

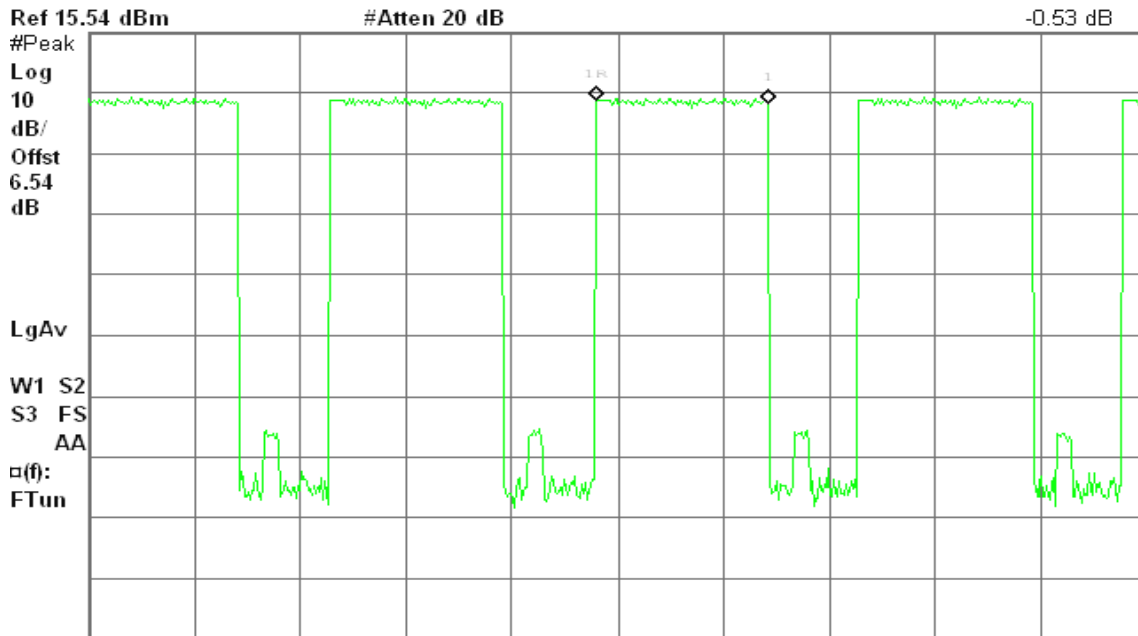

Center 2.480 000 GHz

Res BW 1 MHz

#VBW 1 MHz

Span 0 Hz
Sweep 10 ms (601 pts)



DH 5

CH Low

Agilent 18:11:21 Apr 27, 2010

R T

Δ Mkr1 2.867 ms
-0.49 dB

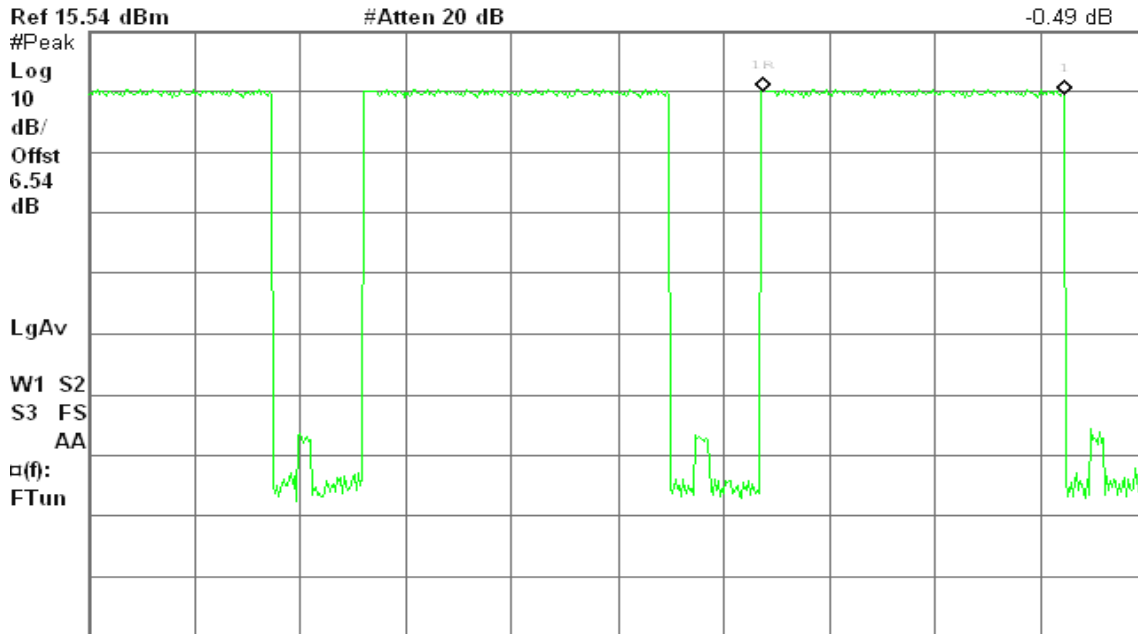

Center 2.402 000 GHz Span 0 Hz
Res BW 1 MHz #VBW 1 MHz Sweep 10 ms (601 pts)

CH Mid

Agilent 18:11:52 Apr 27, 2010

R T

Δ Mkr1 2.85 ms
-0.14 dB

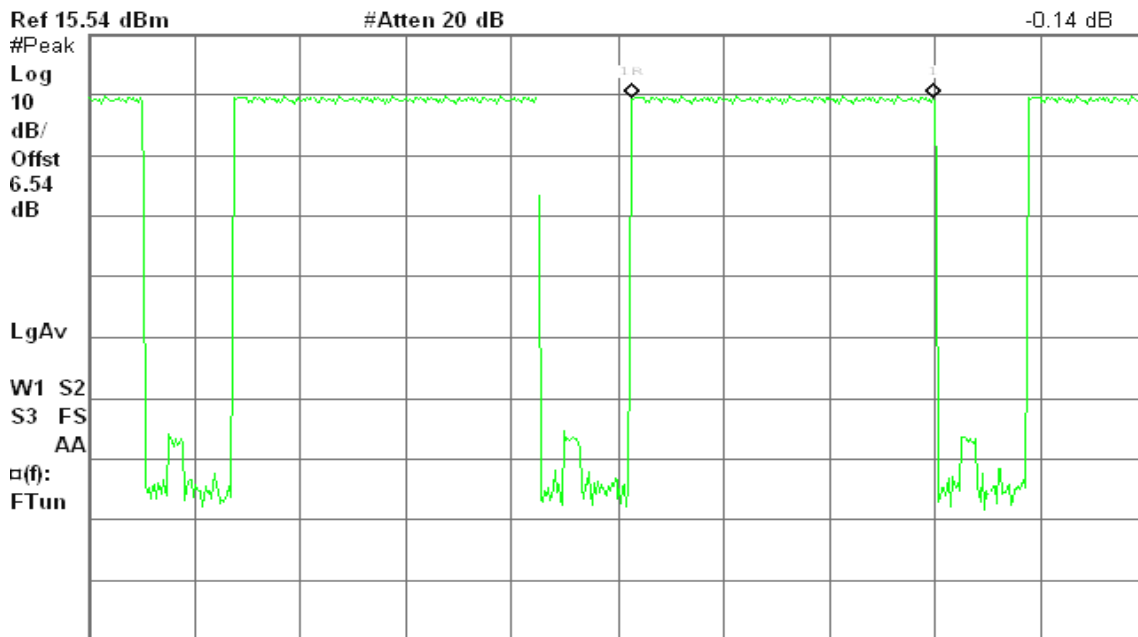

Center 2.441 000 GHz Span 0 Hz
Res BW 1 MHz #VBW 1 MHz Sweep 10 ms (601 pts)



CH High

Agilent 18:16:08 Apr 27, 2010

R T

Δ Mkr1 2.883 ms
-1.57 dB

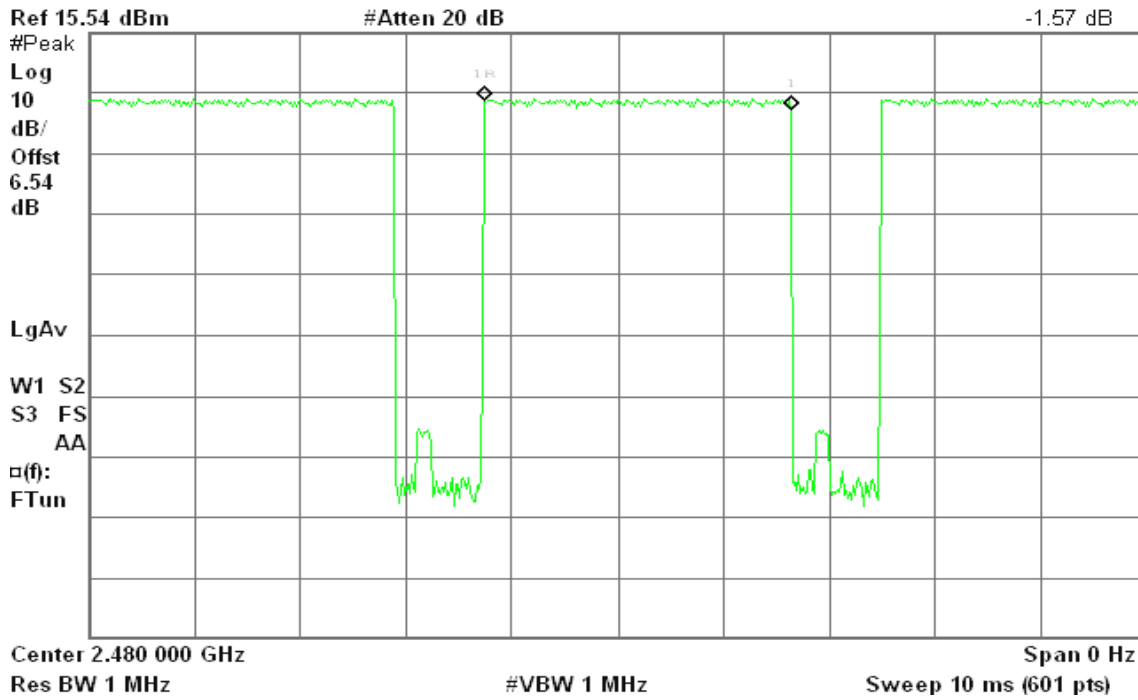



7.9 SPURIOUS EMISSIONS

7.9.1 Conducted Measurement

LIMIT

According to §15.247(d), in any 100 kHz bandwidth outside the frequency bands in which the spread spectrum intentional radiator is operating, the radio frequency power that is produced by the intentional radiator shall be at least 20 dB below that in the 100 kHz bandwidth within the band that contains the highest level of the desired power, based on either an RF conducted or a radiated measurement, provided the transmitter demonstrates compliance with the peak conducted power limits. In addition, radiated emissions which fall in the restricted bands, as defined in §15.205(a), must also comply with the radiated emission limits specified in 15.209(a) (see Section 15.205(c)).

Test Configuration

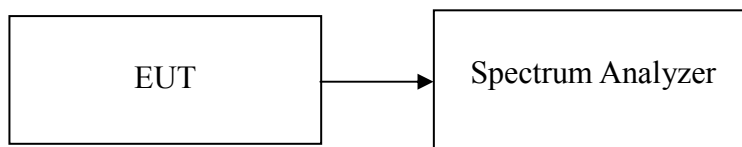

TEST PROCEDURE

Conducted RF measurements of the transmitter output were made to confirm that the EUT antenna port conducted emissions meet the specified limit and to identify any spurious signals that require further investigation or measurements on the radiated emissions site.

The transmitter output is connected to the spectrum analyzer. The resolution bandwidth is set to 100 kHz. The video bandwidth is set to 100 kHz.

Measurements are made over the 30MHz to 26GHz range with the transmitter set to the lowest, middle, and highest channels.

TEST RESULTS

No non-compliance noted



Test Plot

For GFSK / DH5

CH Low

Agilent 17:45:09 Apr 27, 2010

R T

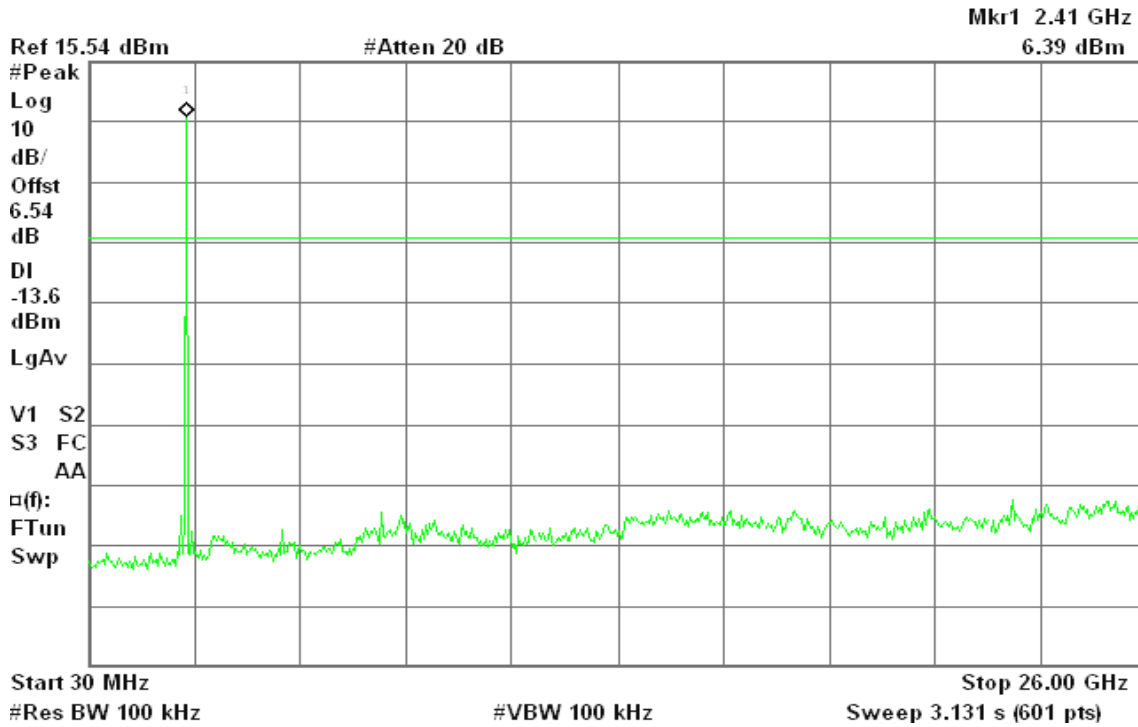

CH Mid

Agilent 17:45:35 Apr 27, 2010

R T

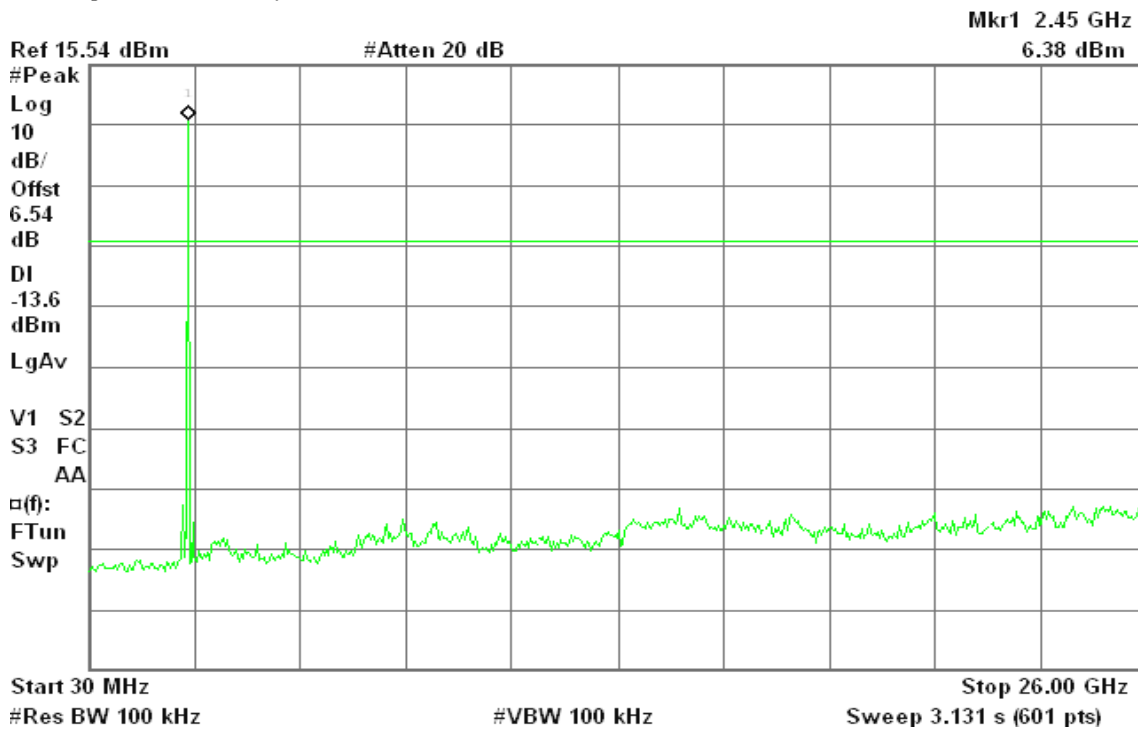



CH High

Agilent 17:46:26 Apr 27, 2010

R T

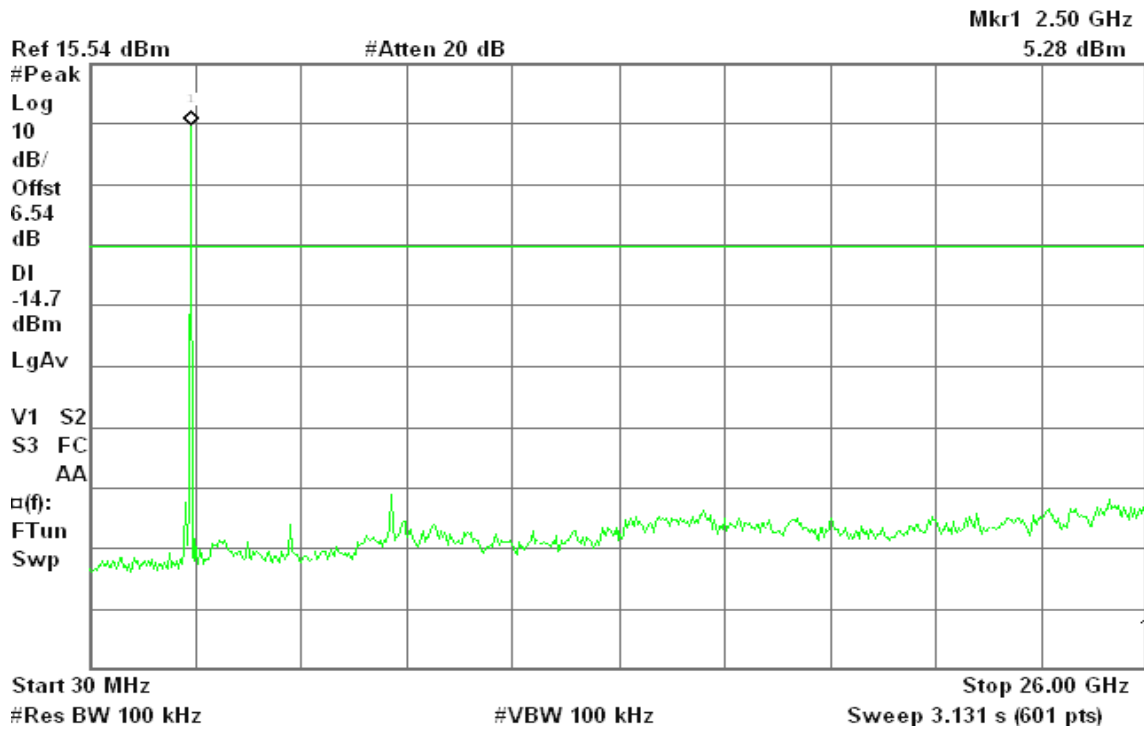



For 8DPSK / DH5

CH Low

Agilent 18:49:03 Apr 27, 2010

R T

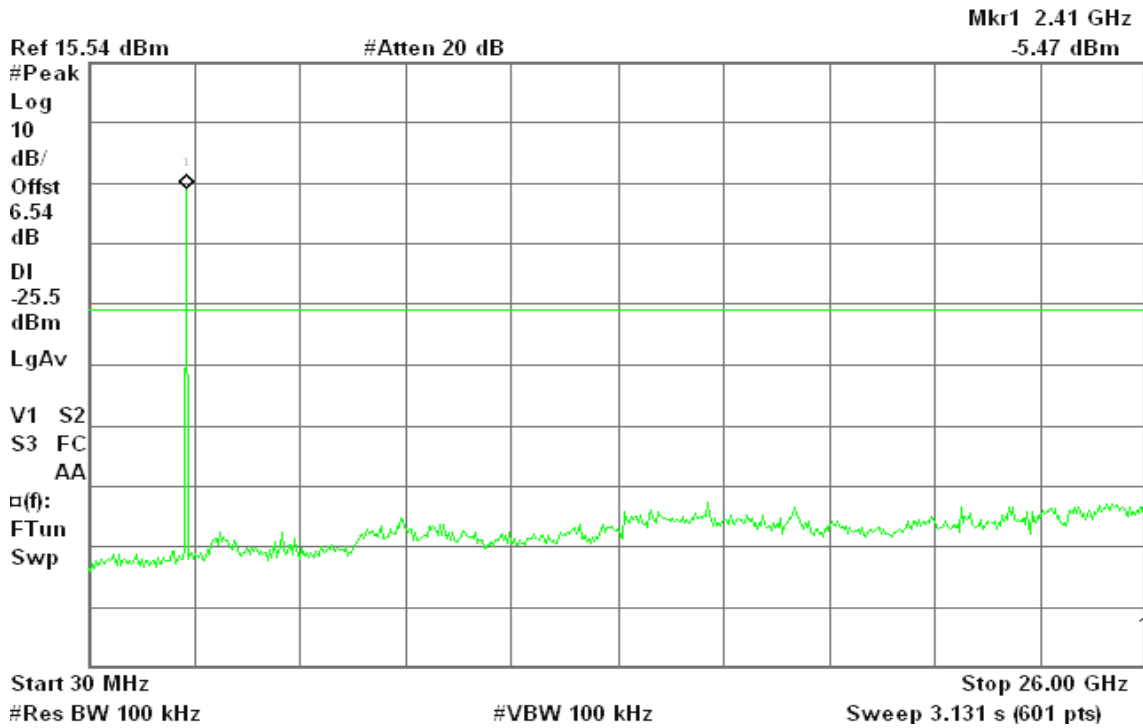

CH Mid

Agilent 18:49:38 Apr 27, 2010

R T

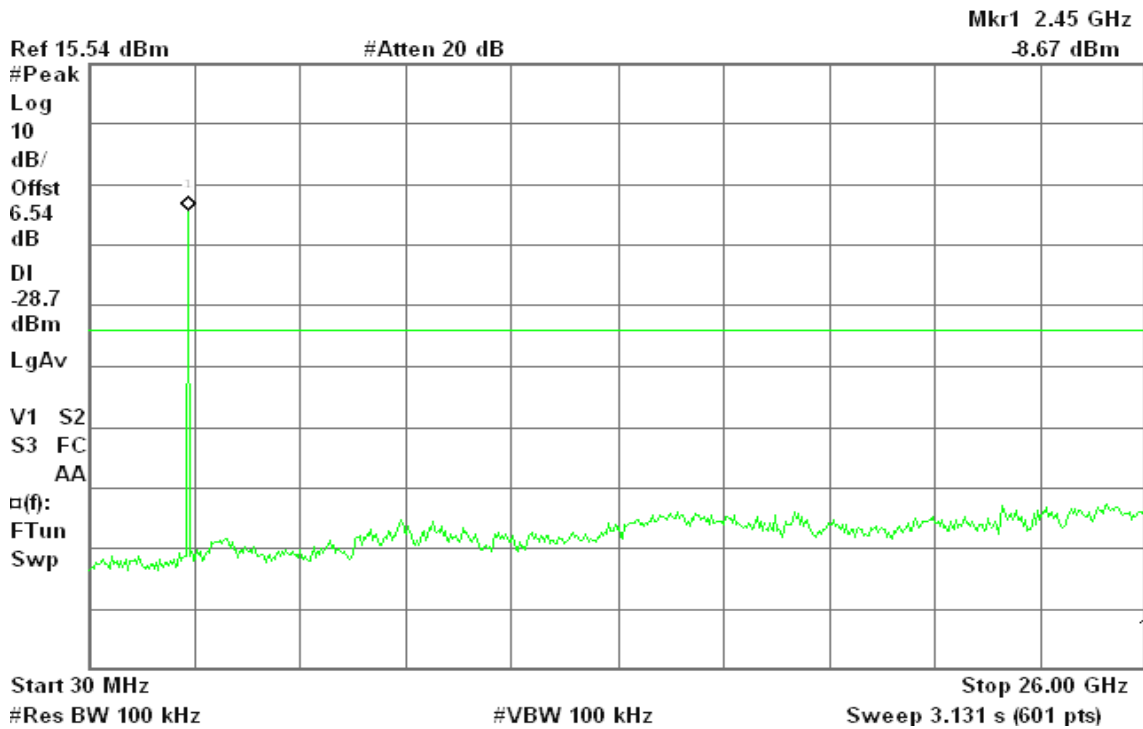



CH High

Agilent 18:47:56 Apr 27, 2010

R T

Mkr1 2.50 GHz
-8.06 dBm

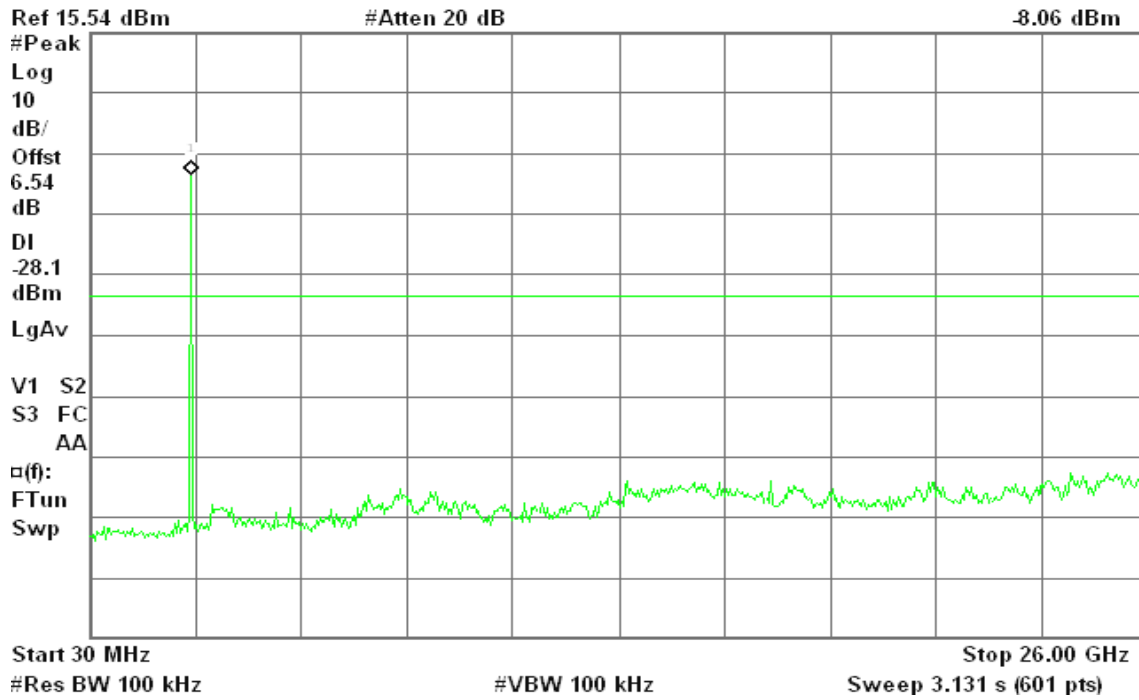



7.9.2 Radiated Emissions

LIMIT

1. According to §15.209(a), except as provided elsewhere in this Subpart, the emissions from an intentional radiator shall not exceed the field strength levels specified in the following table:

Frequency (MHz)	Field Strength ($\mu\text{V/m}$)	Measurement Distance (m)
30-88	100*	3
88-216	150*	3
216-960	200*	3
Above 960	500	3

Remark: Except as provided in paragraph (g), fundamental emissions from intentional radiators operating under this Section shall not be located in the frequency bands 54-72 MHz, 76-88 MHz, 174-216 MHz or 470-806 MHz. However, operation within these frequency bands is permitted under other sections of this Part, e.g., Sections 15.231 and 15.241.

2. In the emission table above, the tighter limit applies at the band edges.

Frequency (MHz)	Field Strength ($\mu\text{V/m}$ at 3-meter)	Field Strength (dB $\mu\text{V/m}$ at 3-meter)
30-88	100	40
88-216	150	43.5
216-960	200	46
Above 960	500	54

Test Configuration

9kHz ~ 30MHz

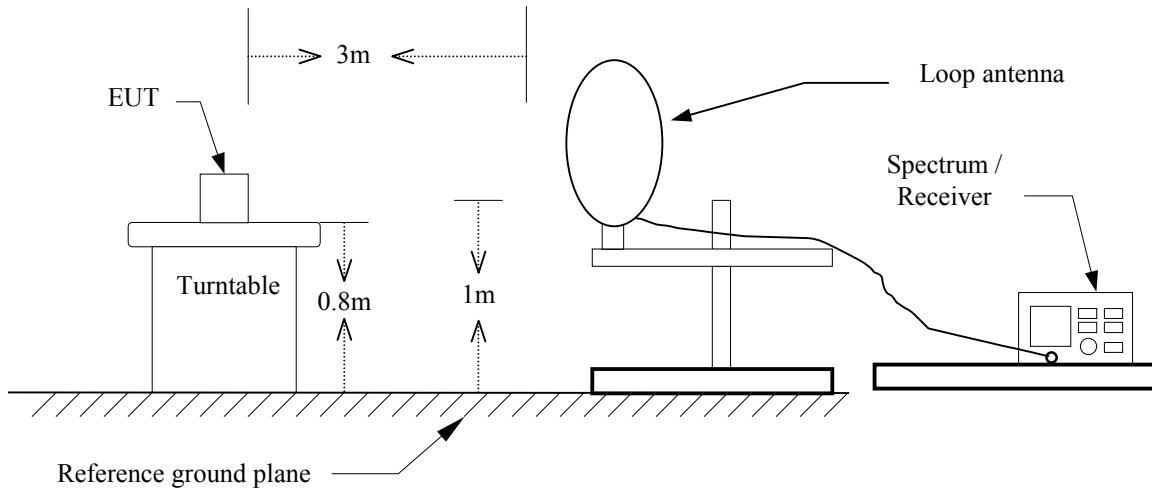

30MHz ~ 1GHz

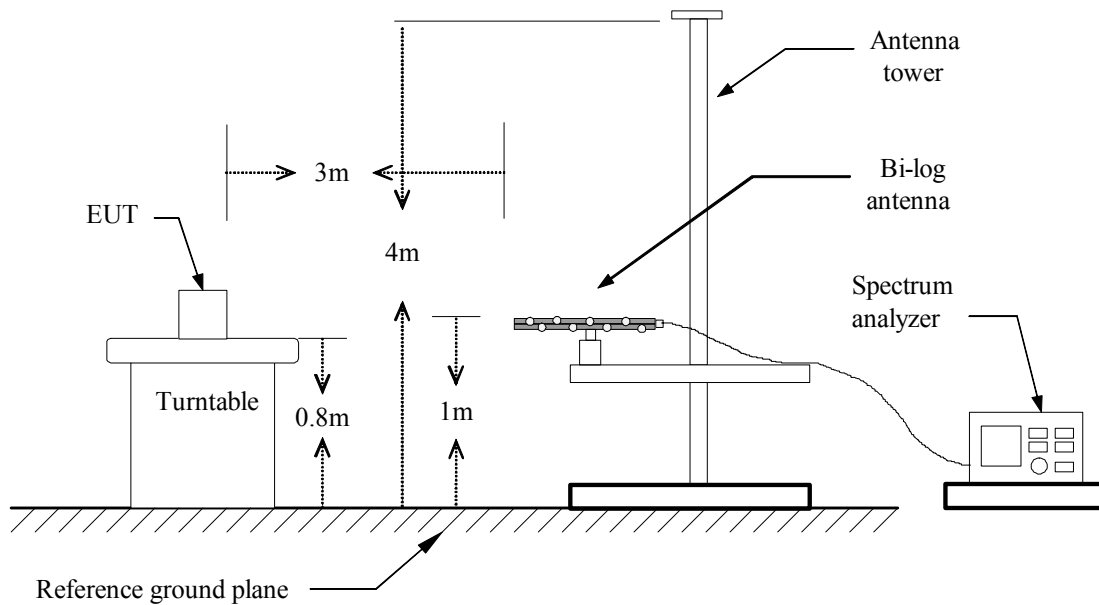



Above 1 GHz

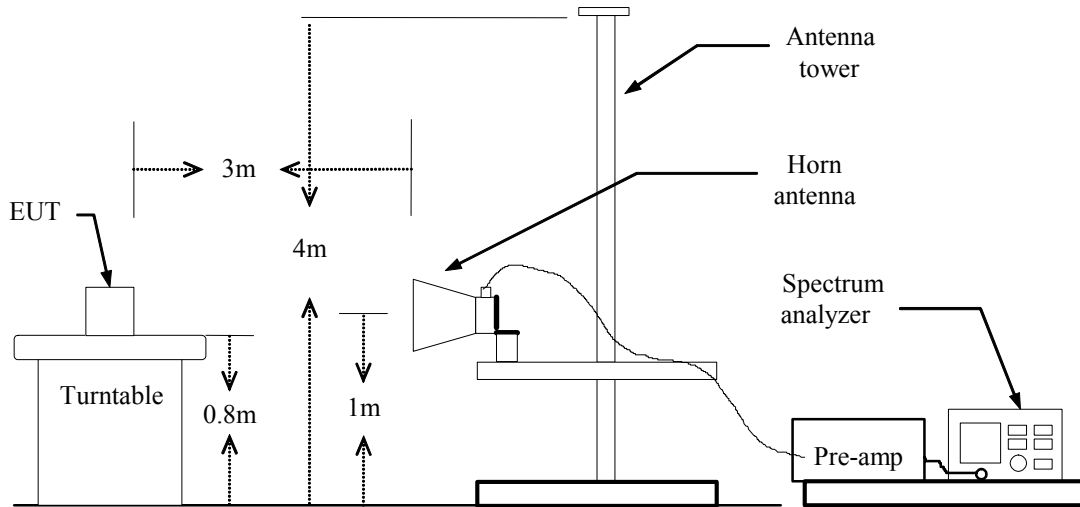



TEST PROCEDURE

1. The EUT is placed on a turntable, which is 0.8m above ground plane.
2. The turntable shall be rotated for 360 degrees to determine the position of maximum emission level.
3. EUT is set 3m away from the receiving antenna, which is varied from 1m to 4m to find out the highest emissions.
4. Maximum procedure was performed on the six highest emissions to ensure EUT compliance.
5. And also, each emission was to be maximized by changing the polarization of receiving antenna both horizontal and vertical.
6. Set the spectrum analyzer in the following setting as:
Below 1GHz:
RBW=100kHz / VBW=300kHz / Sweep=AUTO
Above 1GHz:
(a) PEAK: RBW=VBW=1MHz / Sweep=AUTO
(b) AVERAGE: RBW=1MHz / VBW=10Hz / Sweep=AUTO
7. Repeat above procedures until the measurements for all frequencies are complete.



Below 1 GHz

Operation Mode: Normal Link

Test Date: April 29, 2010

Temperature: 23°C

Tested by: Mimic Yang

Humidity: 53 % RH

Polarity: Ver. / Hor.

Frequency (MHz)	Ant.Pol. (H/V)	Reading (dBuV)	Correction Factor (dB/m)	Result (dBuV/m)	Limit (dBuV/m)	Margin (dB)	Remark
33.23	V	35.30	-4.19	31.11	40.00	-8.89	Peak
52.63	V	48.91	-15.24	33.67	40.00	-6.33	Peak
63.95	V	50.39	-15.44	34.96	40.00	-5.04	Peak
102.75	V	39.02	-12.56	26.46	43.50	-17.04	Peak
296.75	V	37.10	-9.27	27.82	46.00	-18.18	Peak
434.17	V	35.05	-6.25	28.80	46.00	-17.20	Peak
52.63	H	38.42	-15.24	23.18	40.00	-16.82	Peak
68.80	H	40.11	-14.76	25.35	40.00	-14.65	Peak
105.98	H	30.75	-12.00	18.75	43.50	-24.75	Peak
144.78	H	32.82	-10.06	22.76	43.50	-20.74	Peak
162.57	H	27.76	-10.69	17.07	43.50	-26.43	Peak
296.75	H	32.08	-9.27	22.81	46.00	-23.19	Peak

Remark:

1. No emission found between lowest internal used/generated frequency to 30MHz (9kHz~30MHz).
2. Radiated emissions measured were made with an instrument using peak/quasi-peak detector mode.
3. Quasi-peak test would be performed if the peak result were greater than the quasi-peak limit or as required by the applicant.
4. Measurements above show only up to 6 maximum emissions noted, or would be lesser, with " N/A " remark, if no specific emissions from the EUT are recorded (ie: margin>20dB from the applicable limit) and considered that's already beyond the background noise floor.
5. Margin (dB) = Remark result (dBuV/m) – Quasi-peak limit (dBuV/m).



Above 1 GHz

Operation Mode: TX / GFSK / DH5 / CH Low

Test Date: April 28, 2010

Temperature: 23°C

Tested by: Mimic Yang

Humidity: 53 % RH

Polarity: Ver. / Hor.

Frequency (MHz)	Ant.Pol. (H/V)	Reading (Peak) (dBuV)	Reading (Average) (dBuV)	Correction Factor (dB/m)	Result (Peak) (dBuV/m)	Result (Average) (dBuV/m)	Limit (Peak) (dBuV/m)	Limit (Average) (dBuV/m)	Margin (dB)	Remark
1393.33	V	56.84	---	-8.94	47.90	---	74.00	54.00	-6.10	Peak
N/A										
1370.00	H	56.69	---	-8.98	47.72	---	74.00	54.00	-6.28	Peak
N/A										

Remark:

1. Measuring frequencies from 1 GHz to the 10th harmonic of highest fundamental frequency.
2. Radiated emissions measured in frequency above 1000MHz were made with an instrument using peak/average detector mode.
3. Average test would be performed if the peak result were greater than the average limit or as required by the applicant.
4. Data of measurement within this frequency range shown “ --- ” in the table above means the reading of emissions are attenuated more than 20dB below the permissible limits or the field strength is too small to be measured.
5. Measurements above show only up to 6 maximum emissions noted, or would be lesser, with “ N/A ” remark, if no specific emissions from the EUT are recorded (ie: margin>20dB from the applicable limit) and considered that's already beyond the background noise floor.
6. Margin (dB) = Remark result (dBuV/m) – Average limit (dBuV/m).



Operation Mode: TX / GFSK / DH5 / CH Mid

Test Date: April 28, 2010

Temperature: 23°C

Tested by: Mimic Yang

Humidity: 53 % RH

Polarity: Ver. / Hor.

Frequency (MHz)	Ant.Pol. (H/V)	Reading (Peak) (dBuV)	Reading (Average) (dBuV)	Correction Factor (dB/m)	Result (Peak) (dBuV/m)	Result (Average) (dBuV/m)	Limit (Peak) (dBuV/m)	Limit (Average) (dBuV/m)	Margin (dB)	Remark
1476.67	V	57.66	---	-8.80	48.86	---	74.00	54.00	-5.14	Peak
N/A										
1300.00	H	57.86	---	-9.09	48.77	---	74.00	54.00	-5.23	Peak
N/A										

Remark:

1. Measuring frequencies from 1 GHz to the 10th harmonic of highest fundamental frequency.
2. Radiated emissions measured in frequency above 1000MHz were made with an instrument using peak/average detector mode.
3. Average test would be performed if the peak result were greater than the average limit or as required by the applicant.
4. Data of measurement within this frequency range shown " --- " in the table above means the reading of emissions are attenuated more than 20dB below the permissible limits or the field strength is too small to be measured.
5. Measurements above show only up to 6 maximum emissions noted, or would be lesser; with " N/A " remark, if no specific emissions from the EUT are recorded (ie: margin>20dB from the applicable limit) and considered that's already beyond the background noise floor.
6. Margin (dB) = Remark result (dBuV/m) – Average limit (dBuV/m).



Operation Mode: TX / GFSK / DH5 / CH High

Test Date: April 28, 2010

Temperature: 23°C

Tested by: Mimic Yang

Humidity: 53 % RH

Polarity: Ver. / Hor.

Frequency (MHz)	Ant.Pol. (H/V)	Reading (Peak) (dBuV)	Reading (Average) (dBuV)	Correction Factor (dB/m)	Result (Peak) (dBuV/m)	Result (Average) (dBuV/m)	Limit (Peak) (dBuV/m)	Limit (Average) (dBuV/m)	Margin (dB)	Remark
1393.33	V	56.89	---	-8.94	47.95	---	74.00	54.00	-6.05	Peak
N/A										
1313.33	H	58.18	---	-9.07	49.11	---	74.00	54.00	-4.89	Peak
N/A										

Remark:

1. Measuring frequencies from 1 GHz to the 10th harmonic of highest fundamental frequency.
2. Radiated emissions measured in frequency above 1000MHz were made with an instrument using peak/average detector mode.
3. Average test would be performed if the peak result were greater than the average limit or as required by the applicant.
4. Data of measurement within this frequency range shown " --- " in the table above means the reading of emissions are attenuated more than 20dB below the permissible limits or the field strength is too small to be measured.
5. Measurements above show only up to 6 maximum emissions noted, or would be lesser; with " N/A " remark, if no specific emissions from the EUT are recorded (ie: margin > 20dB from the applicable limit) and considered that's already beyond the background noise floor.
6. Margin (dB) = Remark result (dBuV/m) – Average limit (dBuV/m).



Operation Mode: TX / 8DPSK / DH5 / CH Low

Test Date: April 29, 2010

Temperature: 23°C

Tested by: Mimic Yang

Humidity: 53 % RH

Polarity: Ver. / Hor.

Frequency (MHz)	Ant.Pol. (H/V)	Reading (Peak) (dBuV)	Reading (Average) (dBuV)	Correction Factor (dB/m)	Result (Peak) (dBuV/m)	Result (Average) (dBuV/m)	Limit (Peak) (dBuV/m)	Limit (Average) (dBuV/m)	Margin (dB)	Remark
1326.67	V	57.73	---	-9.05	48.68	---	74.00	54.00	-5.32	Peak
N/A										
1396.67	H	56.95	---	-8.93	48.01	---	74.00	54.00	-5.99	Peak
N/A										

Remark:

1. Measuring frequencies from 1 GHz to the 10th harmonic of highest fundamental frequency.
2. Radiated emissions measured in frequency above 1000MHz were made with an instrument using peak/average detector mode.
3. Average test would be performed if the peak result were greater than the average limit or as required by the applicant.
4. Data of measurement within this frequency range shown " --- " in the table above means the reading of emissions are attenuated more than 20dB below the permissible limits or the field strength is too small to be measured.
5. Measurements above show only up to 6 maximum emissions noted, or would be lesser; with " N/A " remark, if no specific emissions from the EUT are recorded (ie: margin>20dB from the applicable limit) and considered that's already beyond the background noise floor.
6. Margin (dB) = Remark result (dBuV/m) – Average limit (dBuV/m).



Operation Mode: TX / 8DPSK / DH5 / CH Mid

Test Date: April 29, 2010

Temperature: 23°C

Tested by: Mimic Yang

Humidity: 53 % RH

Polarity: Ver. / Hor.

Frequency (MHz)	Ant.Pol. (H/V)	Reading (Peak) (dBuV)	Reading (Average) (dBuV)	Correction Factor (dB/m)	Result (Peak) (dBuV/m)	Result (Average) (dBuV/m)	Limit (Peak) (dBuV/m)	Limit (Average) (dBuV/m)	Margin (dB)	Remark
1310.00	V	57.17	---	-9.08	48.09	---	74.00	54.00	-5.91	Peak
N/A										
1410.00	H	57.24	---	-8.91	48.33	---	74.00	54.00	-5.67	Peak
N/A										

Remark:

1. Measuring frequencies from 1 GHz to the 10th harmonic of highest fundamental frequency.
2. Radiated emissions measured in frequency above 1000MHz were made with an instrument using peak/average detector mode.
3. Average test would be performed if the peak result were greater than the average limit or as required by the applicant.
4. Data of measurement within this frequency range shown " --- " in the table above means the reading of emissions are attenuated more than 20dB below the permissible limits or the field strength is too small to be measured.
5. Measurements above show only up to 6 maximum emissions noted, or would be lesser; with " N/A " remark, if no specific emissions from the EUT are recorded (ie: margin > 20dB from the applicable limit) and considered that's already beyond the background noise floor.
6. Margin (dB) = Remark result (dBuV/m) – Average limit (dBuV/m).



Operation Mode: TX / 8DPSK / DH5 / CH High

Test Date: April 29, 2010

Temperature: 23°C

Tested by: Mimic Yang

Humidity: 53 % RH

Polarity: Ver. / Hor.

Frequency (MHz)	Ant.Pol. (H/V)	Reading (Peak) (dBuV)	Reading (Average) (dBuV)	Correction Factor (dB/m)	Result (Peak) (dBuV/m)	Result (Average) (dBuV/m)	Limit (Peak) (dBuV/m)	Limit (Average) (dBuV/m)	Margin (dB)	Remark
1316.67	V	57.20	---	-9.06	48.14	---	74.00	54.00	-5.86	Peak
N/A										
1346.67	H	57.50	---	-9.01	48.48	---	74.00	54.00	-5.52	Peak
N/A										

Remark:

1. Measuring frequencies from 1 GHz to the 10th harmonic of highest fundamental frequency.
2. Radiated emissions measured in frequency above 1000MHz were made with an instrument using peak/average detector mode.
3. Average test would be performed if the peak result were greater than the average limit or as required by the applicant.
4. Data of measurement within this frequency range shown " --- " in the table above means the reading of emissions are attenuated more than 20dB below the permissible limits or the field strength is too small to be measured.
5. Measurements above show only up to 6 maximum emissions noted, or would be lesser; with " N/A " remark, if no specific emissions from the EUT are recorded (ie: margin>20dB from the applicable limit) and considered that's already beyond the background noise floor.
6. Margin (dB) = Remark result (dBuV/m) – Average limit (dBuV/m).



7.10 POWERLINE CONDUCTED EMISSIONS

LIMIT

According to §15.207(a), except as shown in paragraphs (b) and (c) of this section, for an intentional radiator that is designed to be connected to the public utility (AC) power line, the radio frequency voltage that is conducted back onto the AC power line on any frequency or frequencies within the band 150 kHz to 30 MHz shall not exceed the limits in the following table, as measured using a 50 μ H/50 ohms line impedance stabilization network (LISN). Compliance with the provisions of this paragraph shall be based on the measurement of the radio frequency voltage between each power line and ground at the power terminal. The lower limit applies at the boundary between the frequency ranges.

Frequency Range (MHz)	Limits (dB μ V)	
	Quasi-peak	Average
0.15 to 0.50	66 to 56*	56 to 46*
0.50 to 5	56	46
5 to 30	60	50

* Decreases with the logarithm of the frequency.

Test Configuration

See test photographs attached in Appendix II for the actual connections between EUT and support equipment.

TEST PROCEDURE

1. The EUT was placed on a table, which is 0.8m above ground plane.
2. Maximum procedure was performed on the six highest emissions to ensure EUT compliance.
3. Repeat above procedures until all frequency measured were complete.



TEST RESULTS

The initial step in collecting conducted data is a spectrum analyzer peak scan of the measurement range. Significant peaks are then marked as shown on the following data page, and these signals are then quasi-peaked.

Test Data

Operation Mode: Power Adapter Mode **Test Date:** April 26, 2010
Temperature: 26°C **Tested by:** Lawrence Lee
Humidity: 60% RH

Freq. (MHz)	QP Reading (dBuV)	AV Reading (dBuV)	Corr. factor (dB)	QP Result (dBuV)	AV Result (dBuV)	QP Limit (dBuV)	AV Limit (dBuV)	QP Margin (dB)	AV Margin (dB)	Note
0.5500	40.44	28.34	0.06	40.50	28.40	56.00	46.00	-15.50	-17.60	L1
0.6300	42.14	27.74	0.06	42.20	27.80	56.00	46.00	-13.80	-18.20	L1
1.1500	34.55	17.05	0.05	34.60	17.10	56.00	46.00	-21.40	-28.90	L1
1.3450	44.45	25.55	0.05	44.50	25.60	56.00	46.00	-11.50	-20.40	L1
1.8150	43.25	25.45	0.05	43.30	25.50	56.00	46.00	-12.70	-20.50	L1
2.7650	40.92	22.92	0.08	41.00	23.00	56.00	46.00	-15.00	-23.00	L1
0.5300	39.32	26.42	0.08	39.40	26.50	56.00	46.00	-16.60	-19.50	L2
0.7600	38.22	24.32	0.08	38.30	24.40	56.00	46.00	-17.70	-21.60	L2
1.2100	41.32	28.02	0.08	41.40	28.10	56.00	46.00	-14.60	-17.90	L2
1.4500	39.92	26.82	0.08	40.00	26.90	56.00	46.00	-16.00	-19.10	L2
1.8900	40.22	28.42	0.08	40.30	28.50	56.00	46.00	-15.70	-17.50	L2
2.5800	37.40	26.90	0.10	37.50	27.00	56.00	46.00	-18.50	-19.00	L2

Remark:

1. Measuring frequencies from 0.15 MHz to 30MHz.
2. The emissions measured in frequency range from 0.15 MHz to 30MHz were made with an instrument using Quasi-peak detector and average detector.
3. The IF bandwidth of SPA between 0.15MHz and 30MHz was 10kHz; the IF bandwidth of Test Receiver between 0.15MHz and 30MHz was 9kHz;
4. L1 = Line One (Live Line) / L2 = Line Two (Neutral Line)



Test Plots

Conducted emissions (Line 1)

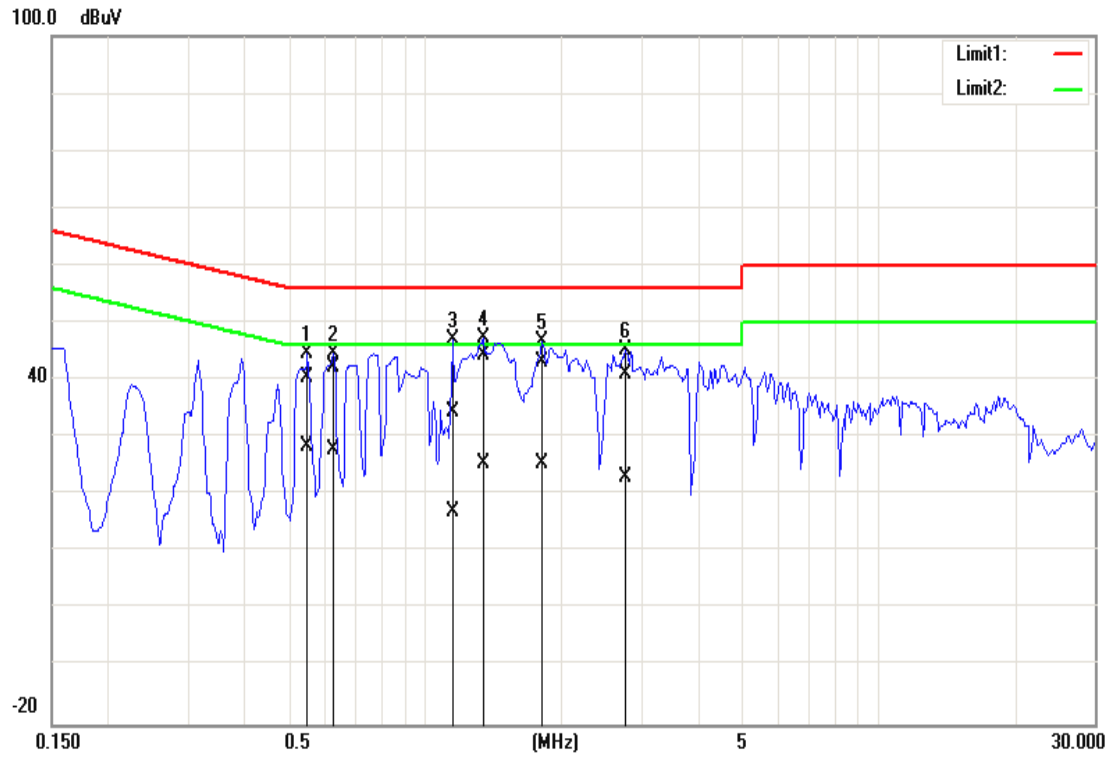

Conducted emissions (Line 2)

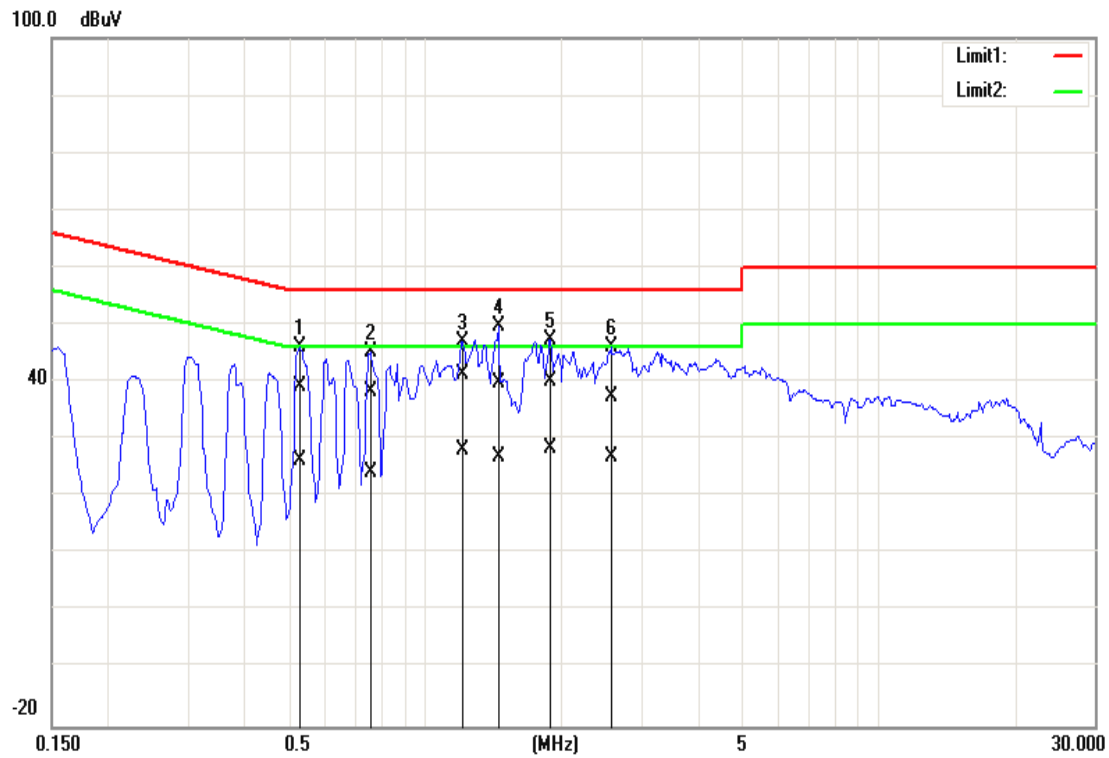



Test Data

Operation Mode: USB Cable Mode

Test Date: April 26, 2010

Temperature: 26°C

Tested by: Lawrence Lee

Humidity: 60% RH

Freq. (MHz)	QP Reading (dBuV)	AV Reading (dBuV)	Corr. factor (dB)	QP Result (dBuV)	AV Result (dBuV)	QP Limit (dBuV)	AV Limit (dBuV)	QP Margin (dB)	AV Margin (dB)	Note
0.2000	47.02	41.92	0.18	47.20	42.10	63.61	53.61	-16.41	-11.51	L1
0.2650	41.55	35.85	0.15	41.70	36.00	61.27	51.27	-19.57	-15.27	L1
0.3350	37.67	32.77	0.13	37.80	32.90	59.33	49.33	-21.53	-16.43	L1
0.4000	33.40	26.90	0.10	33.50	27.00	57.85	47.85	-24.35	-20.85	L1
0.4650	32.93	29.73	0.07	33.00	29.80	56.60	46.60	-23.60	-16.80	L1
6.1450	40.95	35.15	0.25	41.20	35.40	60.00	50.00	-18.80	-14.60	L1
0.2000	47.20	42.30	0.20	47.40	42.50	63.61	53.61	-16.21	-11.11	L2
0.2650	42.23	36.63	0.17	42.40	36.80	61.27	51.27	-18.87	-14.47	L2
0.3321	38.55	31.85	0.15	38.70	32.00	59.40	49.40	-20.70	-17.40	L2
0.4000	35.18	29.78	0.12	35.30	29.90	57.85	47.85	-22.55	-17.95	L2
0.4650	33.31	25.51	0.09	33.40	25.60	56.60	46.60	-23.20	-21.00	L2
6.0100	41.92	36.82	0.28	42.20	37.10	60.00	50.00	-17.80	-12.90	L2

Remark:

1. Measuring frequencies from 0.15 MHz to 30MHz.
2. The emissions measured in frequency range from 0.15 MHz to 30MHz were made with an instrument using Quasi-peak detector and average detector.
3. The IF bandwidth of SPA between 0.15MHz and 30MHz was 10kHz; the IF bandwidth of Test Receiver between 0.15MHz and 30MHz was 9kHz;
4. L1 = Line One (Live Line) / L2 = Line Two (Neutral Line)



Test Plots

Conducted emissions (Line 1)

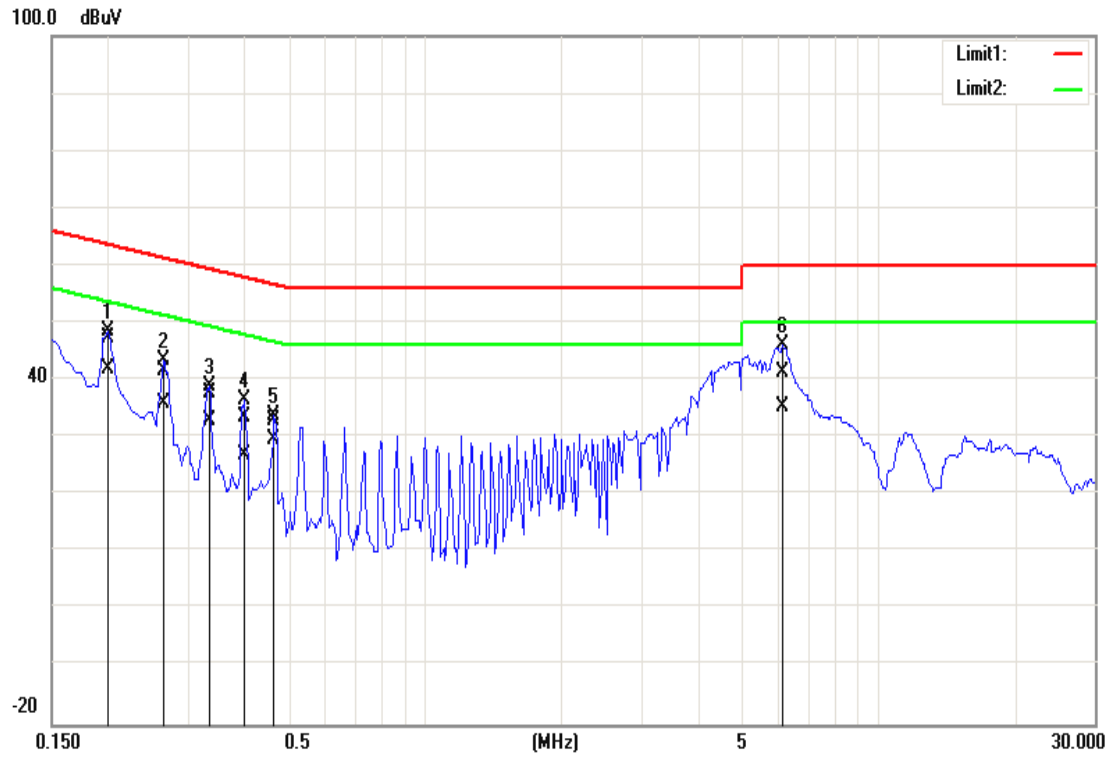

Conducted emissions (Line 2)

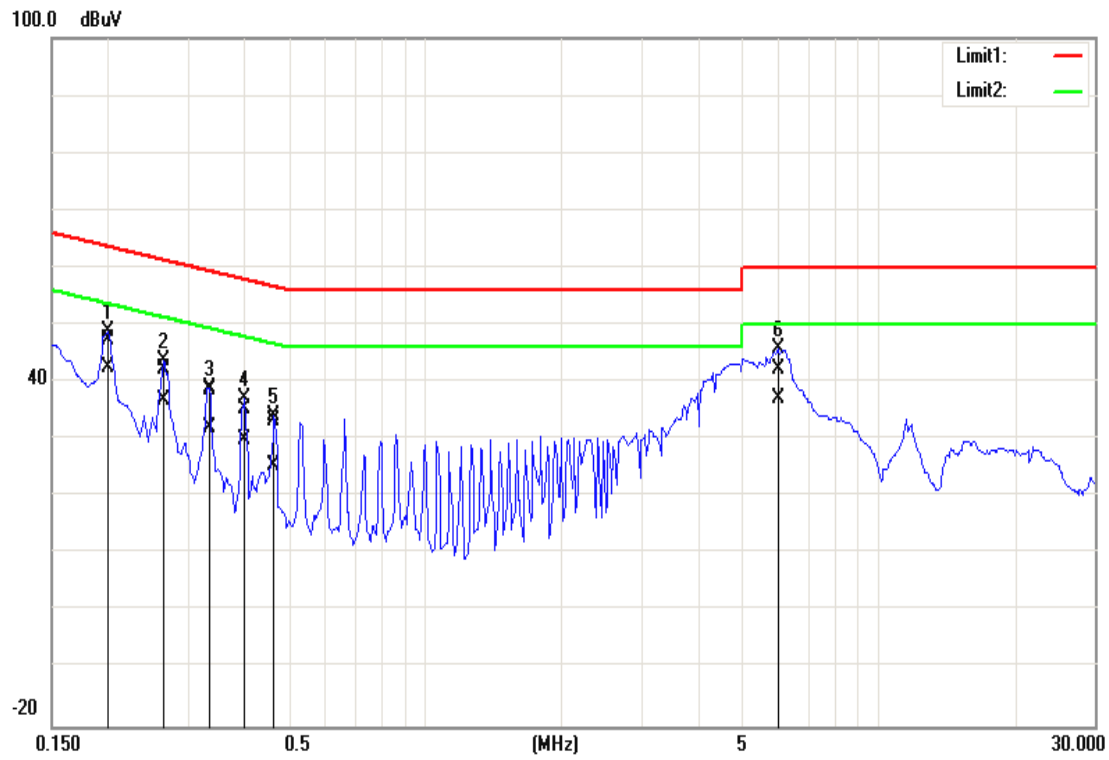



APPENDIX I RADIO FREQUENCY EXPOSURE

LIMIT

According to §15.247(i), systems operating under the provisions of this section shall be operated in a manner that ensures that the public is not exposed to radio frequency energy levels in excess of the Commission's guidelines. See § 1.1307(b)(1) of this chapter.

EUT Specification

EUT	Mobile phone
Frequency band (Operating)	<input type="checkbox"/> WLAN: 2.412GHz ~ 2.462GHz <input type="checkbox"/> WLAN: 5.18GHz ~ 5.32GHz / 5.50GHz ~ 5.70GHz <input type="checkbox"/> WLAN: 5.745GHz ~ 5.825GHz <input checked="" type="checkbox"/> Others: <u>Bluetooth: 2.402GHz ~ 2.480GHz</u>
Device category	<input checked="" type="checkbox"/> Portable (<20cm separation) <input type="checkbox"/> Mobile (>20cm separation) <input type="checkbox"/> Others _____
Exposure classification	<input type="checkbox"/> Occupational/Controlled exposure ($S = 5mW/cm^2$) <input checked="" type="checkbox"/> General Population/Uncontrolled exposure ($S = 1mW/cm^2$)
Antenna diversity	<input checked="" type="checkbox"/> Single antenna <input type="checkbox"/> Multiple antennas <input type="checkbox"/> Tx diversity <input type="checkbox"/> Rx diversity <input type="checkbox"/> Tx/Rx diversity
Max. output power	8.51 dBm (7.09mW)
Antenna gain (Max)	-3.61 dBi (Numeric gain: 0.43)
Evaluation applied	<input type="checkbox"/> MPE Evaluation <input checked="" type="checkbox"/> SAR Evaluation* <input type="checkbox"/> N/A

Remark:

- The maximum output power is 8.51 dBm (7.09mW) at 2402MHz (with 0.43 numeric antenna gain.)
- DTS device is not subject to routine RF evaluation; MPE estimate is used to justify the compliance.

TEST RESULTS

No non-compliance noted.

Remark: Please refer to the separated SAR report.