



**MOTOROLA**

## HAC Test Report for Near Field Emissions IHDP56JM2

**Date of test:** 09/02/2008 thru 09/04/2008  
**Date of Report:** 09/12/2008

**Laboratory:** Motorola Mobile Devices Business Product Safety & Compliance Laboratory  
11th Floor, Hibrand Living Hall,  
215, Yanjae-Dong, Seocho-Gu, Seoul, South Korea, 137-130

**Test Responsible:** DH Moon  
RF Engineer

**Statement of Compliance:** Motorola declares under its sole responsibility that portable cellular telephone FCC IHDP56JM2 to which this declaration relates, complies with recommendations and guidelines FCC 47 CFR §20.19. The measurements were performed to ensure compliance to the ANSI C63.19-2007. It also declares that the product was tested in accordance with the appropriate measurement standards, guidelines and recommended practices. Any deviations from these standards, guidelines and recommended practices are noted below:

(none)

**Results Summary:** M Category = M4

©Motorola, Inc. 2008

This test report shall not be reproduced except in full, without written approval of the laboratory.

The results and statements contained herein relate only to the items tested. The names of individuals involved may be mentioned only in connection with the statements or results from this report.

Motorola encourages all feedback, both positive and negative, on this test report.

**Table of Contents**

**1. INTRODUCTION .....3**

**2. DESCRIPTION OF THE DEVICE UNDER TEST .....3**

**3. TEST EQUIPMENT USED .....4**

**4. VALIDATION .....5**

**5. PROBE MODULATION FACTOR .....6**

**6. TEST RESULTS .....8**

**7. MEASUREMENTS FOR CERTIFICATION OF 3G DEVICES .....11**

**APPENDIX 1: DETAILS JUSTIFYING THE CONVERSION TO PEAK .....12**

**A1.1 Procedure for PMF measurements .....13**

**A1.2 0 Span Spectrum Plots for PMF measurements.....14**

**APPENDIX 2: HAC DISTRIBUTION PLOTS FOR VALIDATION .....17**

**APPENDIX 3: HAC DISTRIBUTION PLOTS FOR E-FIELD AND H-FIELD.....18**

**APPENDIX 4: MOTOROLA UNCERTAINTY BUDGET .....19**

**A4.1 Motorola Uncertainty Budget for RF HAC Testing.....20**

**A4.2 Probe Rotation Contributions to Isotropy Error.....20**

**APPENDIX 5: PICTURES OF TEST SETUP .....21**

**APPENDIX 6: PROBE CALIBRATION CERTIFICATES.....22**

**APPENDIX 7: DIPOLE CHARACTERIZATION CERTIFICATE .....23**

**1. Introduction**

The Motorola Mobile Devices Business Product Safety Laboratory has performed Hearing Aid Compatibility (HAC) measurements for the portable cellular phone (FCC ID IHDP56JM2). The portable cellular phone was tested in accordance with ANSI PC63.19-2007 standard. The test results presented herein clearly demonstrate compliance FCC 47 CFR § 20.19. This report demonstrates compliance for near field emissions only and not for the T-coil performance compliance.

**2. Description of the Device Under Test**

**Table 1: Information for the Device Under Test**

<b>FCC ID Number</b>	IHDP56JM2			
<b>Serial number</b>	A0000002C6673A			
<b>Mode(s) of Operation</b>	800 CDMA	1900 CDMA	1700 CDMA	BlueTooth
<b>Modulation Mode(s)</b>	QPSK	QPSK	QPSK	GFSK
<b>Maximum Output Power Setting</b>	25.0 dBm	25.0 dBm	25.0 dBm	8.0 dBm
<b>Duty Cycle</b>	1:1	1:1	1:1	1:1
<b>Transmitting Frequency Range(s)</b>	824-849MHz	1851-1909MHz	1711-1754MHz	2400-2483.5MHz
<b>Production Unit or Identical Prototype (47 CFR §2..908)</b>	Identical Prototype			
<b>Device Category</b>	Portable			

Note: No Bluetooth profile exists in this phone that will allow a Bluetooth link while in a cellular call that passes audio to the earpiece. If the user had Bluetooth enabled and a link established, they could not be listening to the phone through the earpiece.

**3. Test Equipment Used**

The Motorola Mobile Devices Business Product Safety & Compliance Laboratory utilizes a Dosimetric Assessment System (Dasy4™ v4.7) manufactured by Schmid & Partner Engineering AG (SPEAG™), of Zurich Switzerland. All the HAC measurements are taken within a shielded enclosure. The measurement uncertainty budget is given in Appendix 4. The list of calibrated equipment used for the measurements is shown below.

**Table 2: Dosimetric System Equipment**

Description	Serial Number	Cal Due Date
E-Field Probe ER3DV6R	2249	03/17/2009
H-Field Probe H3DV6	6209	01/28/2009
DAE3	398	11/20/2008
DAE4	719	01/29/2009
835 MHz Dipole CD835V3	1103	01/21/2009
1880 MHz Dipole CD1880V3	1071	01/22/2009

**Table 3: Additional Test Equipment**

Description	Serial Number	Cal Due Date
Power Supply 6632B	MY43002724	01/28/2009
Signal Generator E4438C	MY45093832	01/28/2009
Amplifier ZHL-42-SMA	1046	Not required
3db Attenuator 8491A	MY39263438	Not required
Directional Coupler 778D	20076	01/29/2009
Power Meter E4417A	MY45100675	01/29/2009
Power Sensor #1 – E9323A	MY44421065	01/29/2009
Power Sensor #2 - E9323A	MY44421009	01/29/2009
10db attenuator 8491A	MY39263627	Not required
Spectrum Analyzer E4403B	MY45110615	01/29/2009

**4. Validation**

Validations of the DASY4 v4.7 test system were performed using the measurement equipment listed in Section 3.1. All validations occur in free space using the DASY4 test arch. Note that the 10mm probe to dipole separation is measured from the top edge of the dipole to the calibration reference point of the probe. SPEAG uses the center point of the probe sensor(s) as the reference point when establishing targets for their dipoles. Therefore, because SPEAG’s dipoles and targets are used, it is appropriate to measure the 10mm separation distance to the center of the sensors as they do. This reference point was used for validation only. Validations were performed at 835 MHz and/or 1880 MHz. These frequencies are within each operating band and are within 2MHz of the mid-band frequency of the test device. The obtained results from the validations are displayed in the table below. The field contour plots are included in Appendix 2.

Validations were performed to verify that measured E-field and H-field values are within +/- 25% from the target reference values provided by the manufacturer (Ref: Appendix 7). Per Section 4.3.2.1 of the C63.19 standard, “Values within +/-25% are acceptable, of which 12% is deviation and 13% is measurement uncertainty.” Therefore, the E- and H-Field dipole verification results, shown in Table 4, are in accordance with the acceptable parameters defined by the standard.

**Table 4: Dipole Measurement Summary**

Dipole	F (MHz)	Protocol	Input Power (mW)	E-Field Results (V/m)	Target for Dipole (V/m)	% Deviation
SN 1103	835	CW	100	170.9	159.0	7.5
SN 1071	1880	CW	100	136.4	139.2	-2.0
SN 1071	1730	CW	100	145.6	149.3	-2.5

Dipole	F (MHz)	Protocol	Input Power (mW)	H-Field Results (A/m)	Target for Dipole (A/m)	% Deviation
SN 1103	835	CW	100	0.473	0.443	6.8
SN 1071	1880	CW	100	0.425	0.467	-9.0
SN 1071	1730	CW	100	0.455	0.489	-7.0

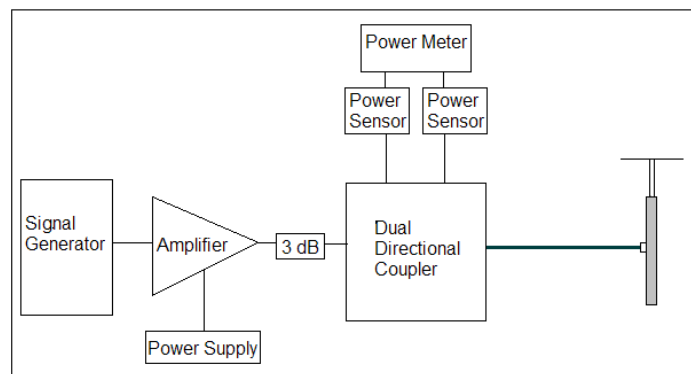

**Figure 1: Setup for Validation**

**5. Probe Modulation Factor**

After every probe calibration, the response of the probe to each applicable modulated signal (CDMA, GSM, etc) must be assessed at both 835 MHz and 1880 MHz. The response of the probe system to a CW field at the frequency(s) of interest is compared to its response to a modulated signal with equal peak amplitude. For each PMF assessment, a Signal Generator was used to replace the original CW signal with the desired modulated signal. The PMF results applicable to this test document are shown in Tables 5.

RF Field Probe Modulation Response was measured with the field probe and associated measurement equipment. The PMF was measured using a signal generator as follows:

1. Illuminate a dipole with a CW signal at the intended measured frequency.
2. Fix the probe at a set location relative to the dipole; typically located at the field reference point.
3. Record the reading of the probe measurement system of the CW signal.
4. Substitute a modulated signal of the same amplitude, using the same modulation as that used by the intended WD for the CW signal.
5. Record the reading of the probe measurement system of the modulated signal.
6. The ratio of the CW to modulated signal reading is the probe modulation factor.

Using dual directional coupler, the forward power and reverse power are measured and adjusted when connected to the dipole.

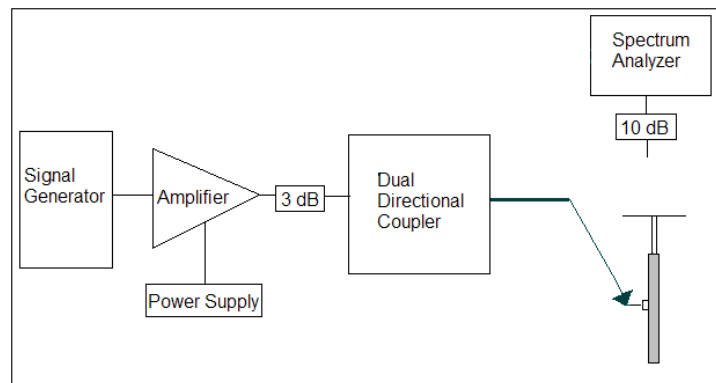

**Figure 2a: Setup to Dipole**

A spectrum analyzer is used to set the peak amplitude of the modulated signal equal to the amplitude of the CW signal. The procedure, used to ensure that the amplitude is the same, is shown in Appendix 1. The 0 span spectrum plots are also provided in Appendix 1.

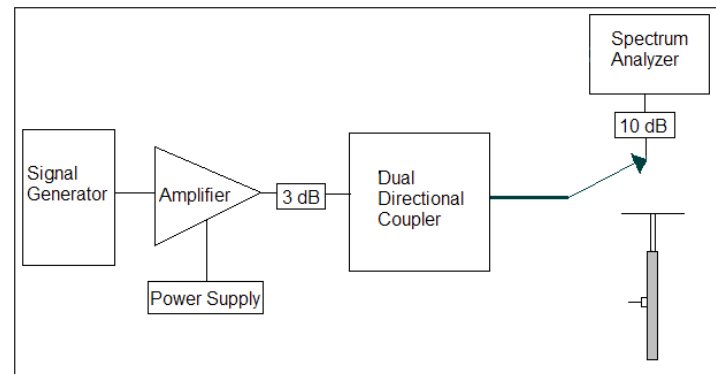

**Figure 2b: Setup for Desired Peak Power using Spectrum Analyzer**

When measuring PMFs, the signal is injected into the dipole. When peak power level produces the field strength less or around M3 limit, the peak power level is used. When peak power level produces the field strength much greater than M3 limit, the power level which gives the field strength around M3 limit is used.

**Table 5: PMF Measurement Summary**

f (MHz)	Protocol	E-Field Probe SN 2249		H-Field Probe SN 6209	
		E-Field (V/m)	E-Field Modulation Factor	H-Field (A/m)	H-Field Modulation Factor
835	CW	195.5		0.8892	
	CDMA	183.8	1.06	0.8994	0.99
	CW	192.2		0.8923	
	CDMA 1/8	67.93	2.83	0.3753	2.38
1730	CW	120.9		0.3532	
	CDMA	112.5	1.07	0.339	1.04
	CW	120.2		0.3486	
	CDMA 1/8	40.79	2.95	0.1306	2.67
1880	CW	110.1		0.3276	
	CDMA	104.4	1.05	0.3129	1.05
	CW	110.9		0.3276	
	CDMA 1/8	37.89	2.93	0.1234	2.65

f (MHz)	Protocol	E-Field Probe SN 2249		H-Field Probe SN 6209	
		E-Field (V/m)	E-Field Modulation Factor	H-Field (A/m)	H-Field Modulation Factor
835	CW	108.6		0.4967	
	AM	67.47	1.61	0.3176	1.56
1730	CW	171.9		0.4981	
	AM	104.4	1.65	0.3277	1.52
1880	CW	158.2		0.4648	
	AM	98.17	1.61	0.3062	1.52

## 6. Test Results

The phone was tested in all normal configurations for the ear use. When applicable, configurations are tested with the antenna in its fully extended position. These test configurations are tested at the high, middle and low frequency channels of each applicable operating mode; for example, GSM, CDMA, and TDMA.

The signal was setup by creating and maintaining an over the air connection between the DUT and an Agilent 8960 or Rohde&Schwarz CMU200 Wireless Communications Test Set. The CDMA radio is available on CDMA 2000(1X) and IS-95. The test equipment was configured to use "all up bits" for RC1 / SO2 on J-STD-008 for CDMA 1900 and TSB-84 for CDMA 800 MHz.

The Cellular Phone model covered by this report has the following battery options:

- Battery #1 – SNN5826A is 1800 mAH Battery
- Battery #2 – SNN5744C is 1000 mAH Battery
- Battery #3 – SNN5813A is 910 mAH Battery

The DASY4 v4.7 measurement system specified in section 3.1 was utilized within the intended operations as set by the SPEAG™ setup. The default settings for the grid spacing of the scan were set to 5mm as shown in the Field plots included in Appendix 2 and 3. The 5cm x 5cm area measurement grid is centered on the acoustic output of the device.

The Test Arch provided by SPEAG is used to position the DUT. The pictures for both positioning and measurement are included in Appendix 5.

The WD reference plane is parallel to the device and contains the highest point on its contour in the area of the phone that normally rests against the user's ear. The measurement plane contains the center point of the probe sensor(s). The device is positioned such that the WD reference plane is located 15mm from, and parallel to, the measurement plane. This is in accordance with section 4.4 of the standard, which states that "The WD reference plane is a plane parallel with the front "face" of the WD and containing the highest point on its contour in the area of the phone that normally rests against the user's ear."

The HAC Rating results for E-Field and H-field are shown in Tables 6 and 9. Also shown are the measured conducted output powers, the measured drifts, excluded areas, and the peak fields. PMF measurements are taken from Section 5. The worst-case test conditions are indicated with **bold numbers** in the tables and are detailed in Appendix 3: HAC distribution plots for E-Field and H-Field.

Drift was measured using the typical DASY4 v4.7 measurement routines. The field is measured at the reference location (center of the ear piece) at the beginning of the test. Then after completion of the E or H field measurement, the probe returns to the same reference location and takes another measurement. The drift is the delta between these two values and is included in the test report scans.

Per SPEAG's recommendation, the phone plots in Appendix 3 use the standard GSM transmitter ratio 1:8 and standard CDMA transmitter ratio 1:1 as "Duty Cycle." Per SPEAG's recommendation, in order to account for probe modulation response, PMF is applied during the SEMCAD (post-processing) portion. PMF also appears in the phone plots in Appendix 3.

CDMA 800 Emissions Limits	
Rating	E-Field
M3	199.5 – 354.8 V/m
M4	< 199.5 V/m

CDMA 1900 Emissions Limits	
Rating	E-Field
M3	63.1 – 112.2 V/m
M4	< 63.1 V/m

**Table 6: HAC E-Field measurement results for the portable cellular telephone at highest possible output power (Full Rate).**

Frequency Band (MHz)	Antenna position	Channel Setting	Measured PMF	Drift (dB)	Excluded Cells	Peak Field (V/m)	Rating
CDMA 800MHz	Internal	1013	1.06	0.05	8, 9	98.9	M4
		384		-0.08	8, 9	89.2	M4
		777		-0.04	8, 9	96.0	M4
		1013 w/ Bat2		0.04	8,9	100.3	M4
		<b>1013 w/ Bat3</b>		<b>0.13</b>	<b>8,9</b>	<b>101.5</b>	<b>M4</b>
CDMA 1900MHz	Internal	25	1.05	0.11	2, 3, 6	38.8	M4
		600		0	2, 3, 6	32.9	M4
		1175		0.01	2, 3, 6	32.6	M4
		25 w/ Bat2		0.02	2, 3, 6	40.5	M4
		<b>25 w/ Bat3</b>		<b>0.12</b>	<b>2, 3, 6</b>	<b>41.3</b>	<b>M4</b>
CDMA 1700MHz	Internal	25	1.07	0.1	2, 3, 6	40.4	M4
		450		0.02	2, 3, 6	42.2	M4
		875		0	2, 3, 6	36.9	M4
		450 w/ Bat2		0.1	2, 3, 6	46.0	M4
		450 w/ Bat3		-0.02	2, 3, 6	45.9	M4

**Table 7: HAC E-Field measurement results for the portable cellular telephone at highest possible output power (1/8 Rate).**

Frequency Band (MHz)	Antenna position	Channel Setting	Measured PMF	Drift (dB)	Excluded Cells	Peak Field (V/m)	Rating
CDMA 800MHz	Internal	1013	2.83	-0.17	4, 7, 8	97	M4
		384		-0.01	8, 9	85.5	M4
		777		-0.03	8, 9	96.2	M4
		1013 w/ Bat2		0	8, 9	97.9	M4
		1013 w/ Bat3		-0.15	8, 9	96.6	M4
CDMA 1900MHz	Internal	25	2.93	-0.28	2, 3, 6	38.2	M4
		600		0.09	2, 3, 6	33.3	M4
		1175		0.08	2, 3, 6	33	M4
		25 w/ Bat2		-0.05	2, 3, 6	40	M4
		25 w/ Bat3		-0.01	2, 3, 6	39.9	M4
CDMA 1700MHz	Internal	25	2.95	0.01	2, 3, 6	38.7	M4
		450		-0.09	2, 3, 6	41.7	M4
		875		0.01	2, 3, 6	40.6	M4
		<b>450 w/ Bat2</b>		<b>0.15</b>	<b>2, 3, 6</b>	<b>48.6</b>	<b>M4</b>
		450 w/ Bat3		-0.06	2, 3, 6	45.4	M4

CDMA 800 Emissions Limits	
Rating	H-Field
M3	0.60 – 1.07 A/m
M4	< 0.60 A/m

CDMA 1900 Emissions Limits	
Rating	H-Field
M3	0.19 – 0.34 A/m
M4	< 0.19 A/m

**Table 8: HAC H-Field measurement results for the portable cellular telephone at highest possible output power (Full Rate).**

Frequency Band (MHz)	Antenna position	Channel Setting	Measured PMF	Drift (dB)	Excluded Cells	Peak Field (A/m)	Rating
CDMA 800MHz	Internal	1013	0.99	-0.16	1, 4, 7	0.134	M4
		384		-0.16	1, 4, 7	0.128	M4
		777		-0.16	1, 4, 7	0.133	M4
		1013 w/ Bat2		-0.11	1, 4, 7	0.138	M4
		<b>1013 w/ Bat3</b>		<b>-0.07</b>	<b>1, 4, 7</b>	<b>0.140</b>	<b>M4</b>
CDMA 1900MHz	Internal	25	1.05	0.1	1, 2, 4	0.119	M4
		600		-0.1	1, 2, 4	0.095	M4
		1175		0.08	1, 2, 4	0.091	M4
		25 w/ Bat2		0.04	1, 2, 4	0.128	M4
		25 w/ Bat3		0.08	1, 2, 4	0.123	M4
CDMA 1700MHz	Internal	25	1.04	0.3	1, 2, 4	0.106	M4
		450		-0.06	1, 2, 4	0.109	M4
		875		-0.12	1, 2, 4	0.112	M4
		<b>875 w/ Bat2</b>		<b>-0.02</b>	<b>1, 2, 4</b>	<b>0.132</b>	<b>M4</b>
		875 w/ Bat3		-0.12	1, 2, 4	0.128	M4

**Table 9: HAC H-Field measurement results for the portable cellular telephone at highest possible output power (1/8 Rate).**

Frequency Band (MHz)	Antenna position	Channel Setting	Measured PMF	Drift (dB)	Excluded Cells	Peak Field (A/m)	Rating
CDMA 800MHz	Internal	1013	2.38	-0.01	1, 4, 7	0.118	M4
		384		0	1, 4, 7	0.109	M4
		777		-0.2	1, 4, 7	0.121	M4
		777 w/ Bat2		-0.17	1, 4, 7	0.122	M4
		777 w/ Bat3		-0.06	1, 4, 7	0.128	M4
CDMA 1900MHz	Internal	<b>25</b>	2.65	<b>-0.21</b>	<b>1, 2, 4</b>	<b>0.133</b>	<b>M4</b>
		600		0.2	1, 2, 4	0.095	M4
		1175		0.02	1, 2, 4	0.098	M4
		25 w/ Bat2		0.04	1, 2, 4	0.115	M4
		25 w/ Bat3		-0.02	1, 2, 4	0.111	M4
CDMA 1700MHz	Internal	25	2.67	0.11	1, 2, 4	0.095	M4
		450		0.17	1, 2, 4	0.1	M4
		875		-0.03	1, 2, 4	0.109	M4
		875 w/ Bat2		0.24	1, 2, 4	0.129	M4
		875 w/ Bat3		-0.21	1, 2, 4	0.124	M4

**7. Measurements for Certification of 3G Devices**

For CDMA devices, RC1 and RC3 CDMA modes are considered in S055 service option. In addition, RC1 and RC3 modes are considered in S02 service option. The conducted power measurements for each mode are shown in the table below.

Conducted Power (dBm) for CDMA modes					
	Channel	RC1		RC3	
		S02	S055	S02	S055
800CDMA	1013	24.91	25.01	25.00	25.00
	384	25.03	25.07	25.08	25.09
	777	24.87	24.98	25.01	25.08
1900CDMA	25	25.15	25.06	25.19	25.14
	600	24.88	24.80	24.93	24.98
	1175	25.13	25.13	25.24	25.18
1700CDMA	25	25.07	24.99	24.97	25.06
	450	24.85	24.87	24.88	24.95
	875	24.72	24.74	24.79	24.86

**Appendix 1**

**Details justifying the conversion to peak**

### A1.1 Procedure for PMF measurements

1. Setup the HAC validation rack as you would for a normal CW HAC validation with forward power = 100mW
2. Setup the dipole and phantom as you would for a normal CW HAC validation.
3. Open the "HAC Probe Mod Factor" template and verify the following parameters:  
Medium = "Air";  
Communication System = "HAC – Dipole";  
Ensure the proper probe & DAE are installed and laser aligned
4. **MEASURE CW:** Using the original CW signal, run the jobs in the "CW Measurement" procedure.
5. Do **not** turn off the signal generator power
6. **Setting the CW Reference Level on the Spectrum Analyzer:** To set the Reference level on the Spectrum Analyzer, remove the Validation Rack's Main Cable from the dipole and connect to the Spectrum Analyzer INPUT using a 10 dB attenuator and an adapter.
7. Set-Up the Spectrum Analyzer for the following Settings:  
Frequency: Freq. being tested (EX: 835/1880)  
Span: Zero Span  
Res BW: iDEN – 100 kHz; GSM – 300 kHz; CDMA – 3 MHz; WCDMA – 5 MHz;  
Video BW: iDEN – 300 kHz; GSM – 1MHz; CDMA and WCDMA – 30 kHz\*\*;  
Sweep Time: 20 ms; 120 ms for iDEN  
Scale: 1dB  
Detector: PEAK / Manual
8. Adjust REF level until the CW signal is aligned with the Center Line (approx. 15dB). NOTE: After this point, the Reference Line must remain fixed. Do not change it.
9. **MEASURE THE MODULATED SIGNAL(S):**
  - 9.1. Change the signal generator to the desired modulation.
  - 9.2. Set the Spectrum Analyzer Sweep Time to 20ms.
  - 9.3. With the Main cable still connected to the Spectrum Analyzer, adjust the amplitude of the power on the signal generator so that the PEAK of the modulated signal is at the CW Reference Line:
    - 9.3.1 On the Spectrum Analyzer, press the [View Trace] button and then select (Max Hold), this will show only the Peak output.
    - 9.3.2 Press (Clear Write) and then (Max Hold) each time an amplitude adjustment is made.
  - 9.4. Allow the Max Hold line to stabilize. Then check that the highest peak of the Max Hold line corresponds with the CW Reference Line (without going over). If not correct, repeat section 6.
  - 9.5. Remove the validation main cable from the spectrum analyzer and re-connect it to the Dipole.
10. Repeat 9 until all remaining modulation(S) have been completed.

\*\* The use of 30 kHz VBW is validated. The power measurements are verified using an average power meter.

**A1.2 0 Span Spectrum Plots for PMF measurements**

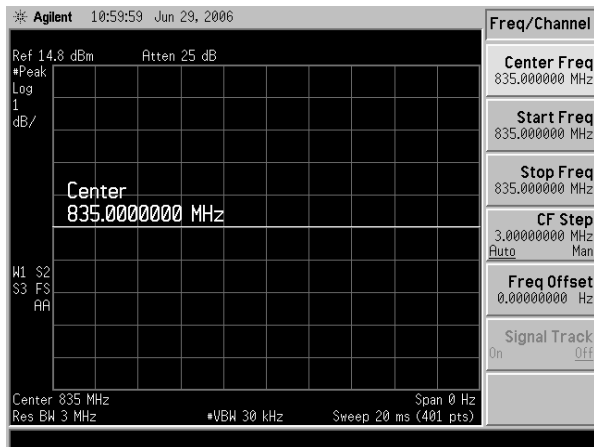

CW 835 MHz

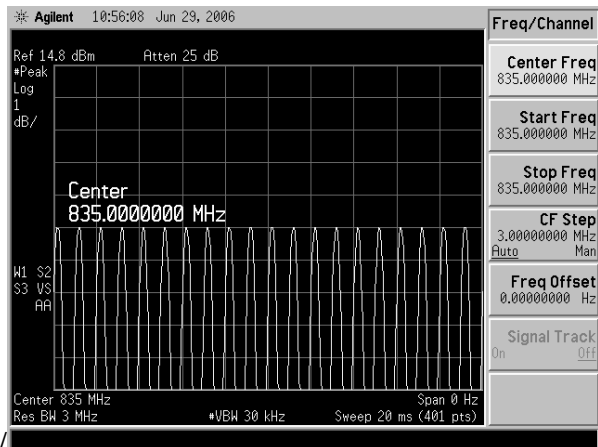

80% AM 835 MHz

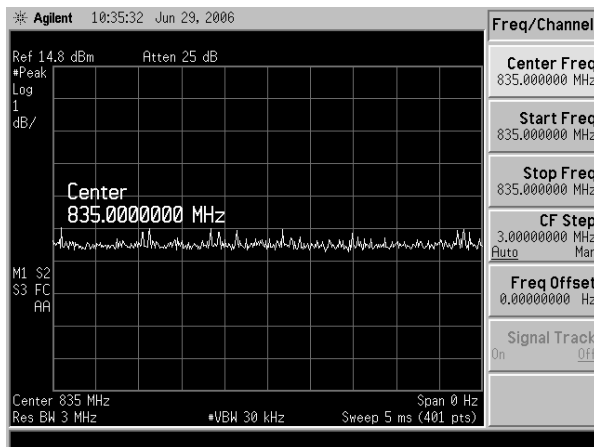

CDMA 835 MHz (full rate)

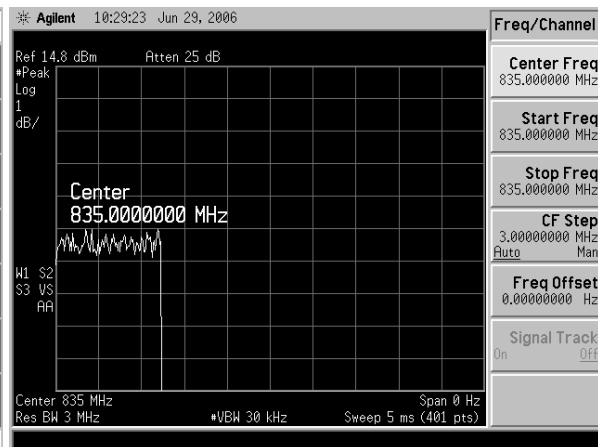

CDMA 835 MHz (1/8 rate)

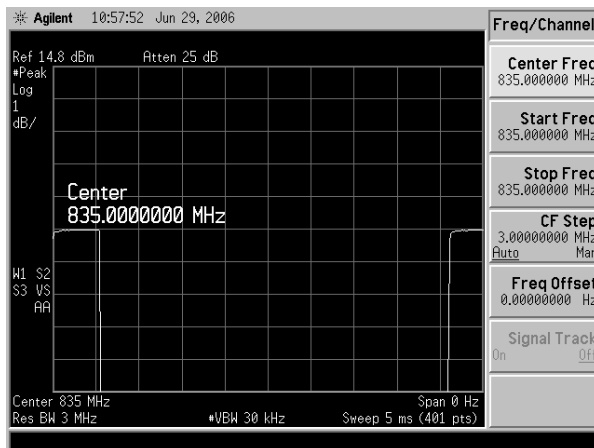

GSM 835 MHz

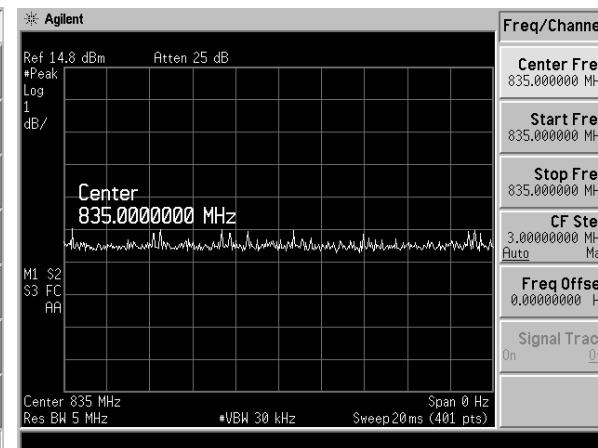

WCDMA 835 MHz

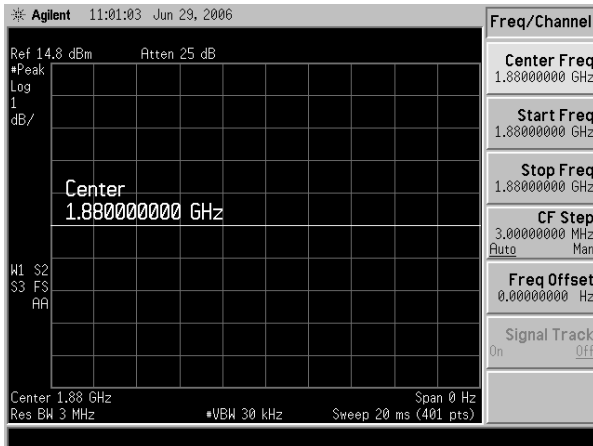

CW 1880 MHz

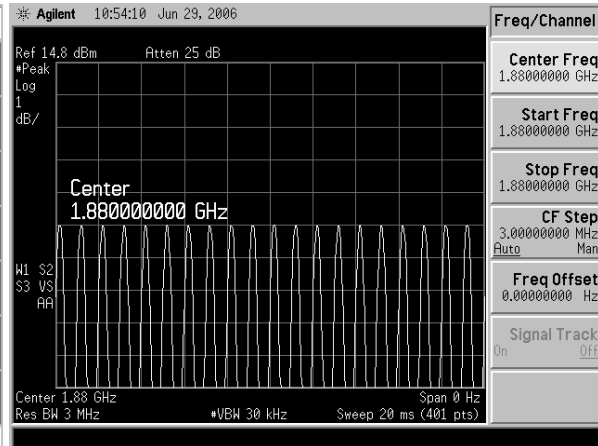

80% AM 1880 MHz

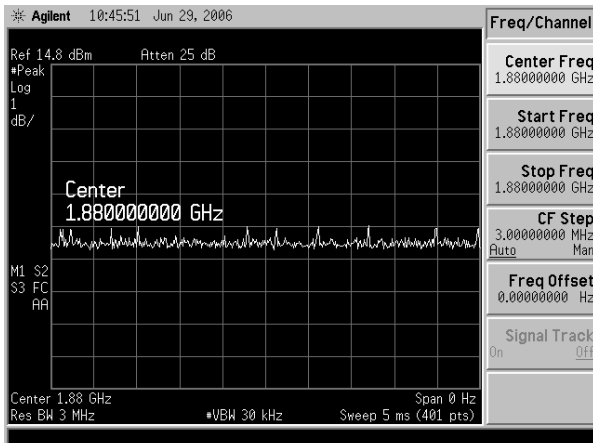

CDMA 1880 MHz (full rate)

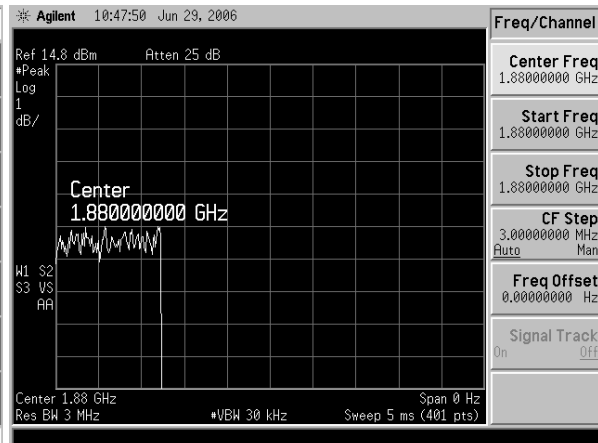

CDMA 1880 MHz (1/8 rate)

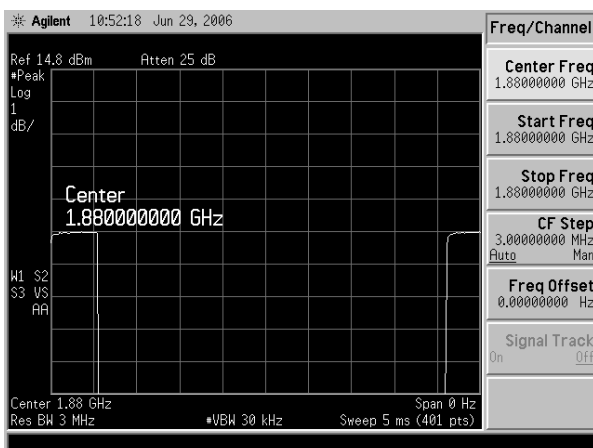

GSM 1880 MHz

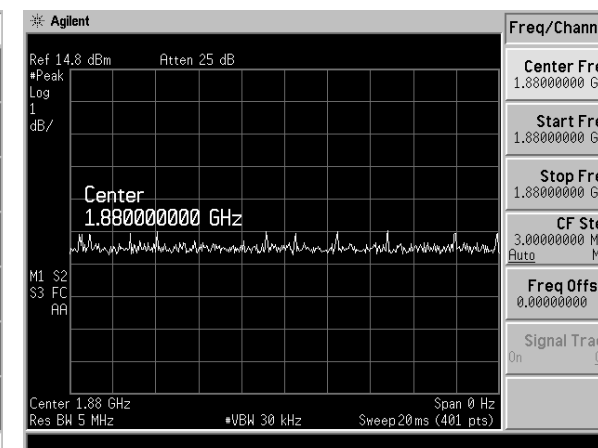

WCDMA 1880 MHz

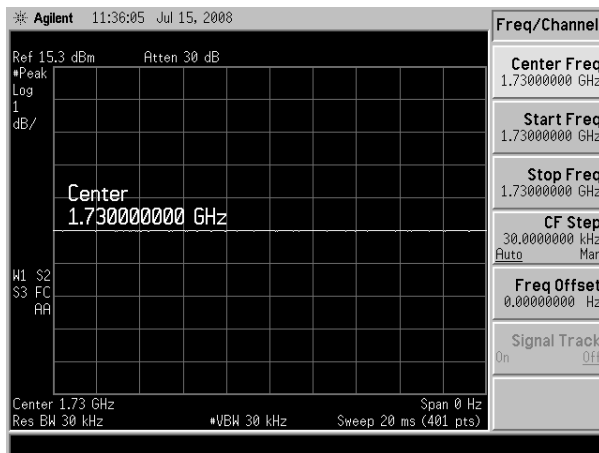

CW 1730 MHz

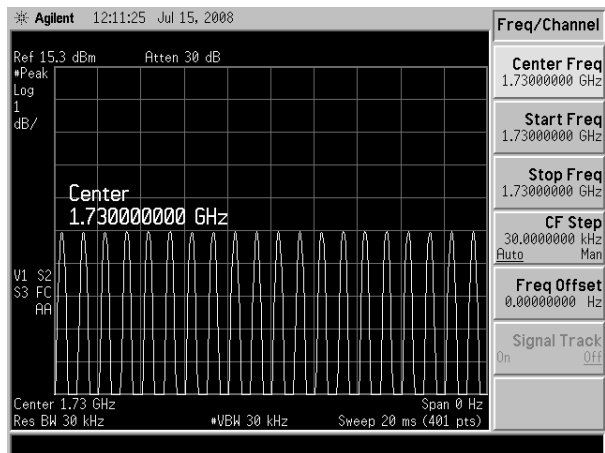

80% AM 1730 MHz

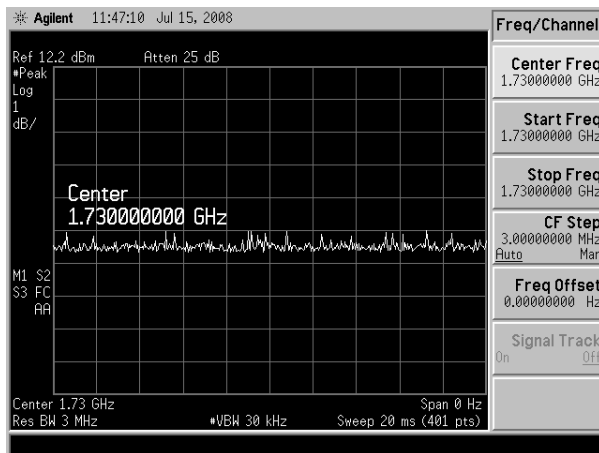

CDMA 1730 MHz (full rate)

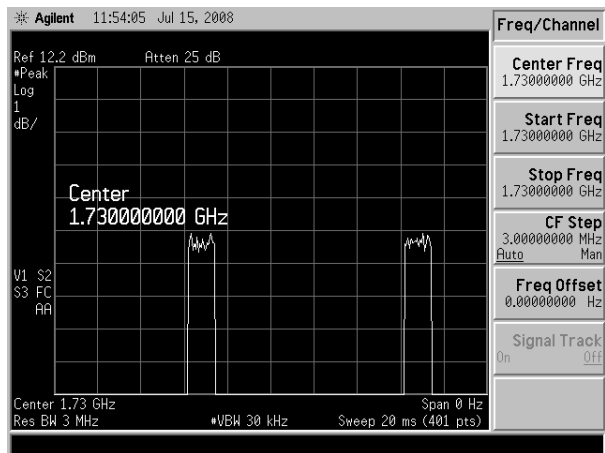

CDMA 1730 MHz (1/8 rate)

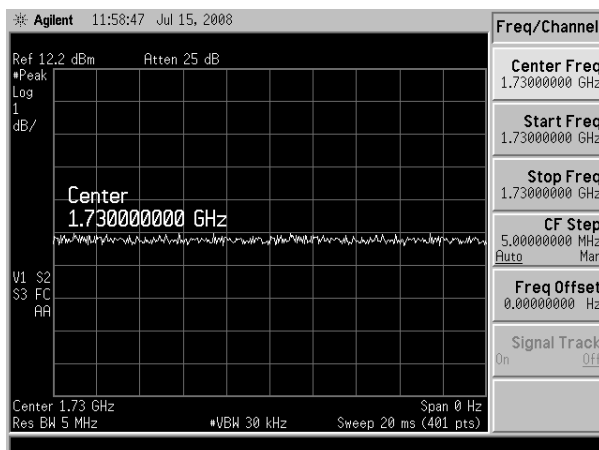

WCDMA 1730 MHz

**Appendix 2**

**HAC distribution plots for Validation**

# Test Laboratory: Motorola 20080902, E- 835 CW +7.5% GOOD

**DUT: HAC-Dipole 835 MHz; Type: CD835V3; Serial: 1103**

Procedure Notes: 835MHz HAC Validation / Dipole Sn# 1103 PM1(A) Power = 100 mW

Communication System: CW - HAC; Frequency: 835 MHz; Duty Cycle: 1:1

Medium: Air; Medium parameters used:  $\sigma = 0$  mho/m,  $\epsilon_r = 1$ ;  $\rho = 0$  kg/m<sup>3</sup>

DASY4 Configuration:

- Probe: ER3DV6R - SN2249; ConvF(1, 1, 1); Calibrated: 03/17/2008
- Sensor-Surface: 0mm (Fix Surface)Sensor-Surface: (Fix Surface)
- Electronics: DAE3 Sn398; Calibrated: 11/20/2007
- Phantom: R-8, HAC Test Arch (rev.2); Type: SD HAC P01 BA; Serial: 1072;
- Measurement SW: DASY4, V4.7 Build 71; Postprocessing SW: SEMCAD, V1.8 Build 184

## E Scan - ER probe center 10mm above CD835 Dipole/Hearing Aid Compatibility Test, 835 Dipole

**(41x361x1):** Measurement grid: dx=5mm, dy=5mm

Maximum value of peak Total field = 175.7 V/m

Probe Modulation Factor = 1.00

Device Reference Point: 0.000, 0.000, -6.30 mm

Reference Value = 111.3 V/m; Power Drift = -0.017 dB

Average value of Total (interpolated) = ( 166.1 + 175.7 )/2 = 170.9 V/m

Peak E-field in V/m

Grid 1 <b>164.1 M4</b>	Grid 2 <b>166.1 M4</b>	Grid 3 <b>161.3 M4</b>
Grid 4 <b>89.2 M4</b>	Grid 5 <b>90.9 M4</b>	Grid 6 <b>88.8 M4</b>
Grid 7 <b>169.9 M4</b>	Grid 8 <b>175.7 M4</b>	Grid 9 <b>169.5 M4</b>

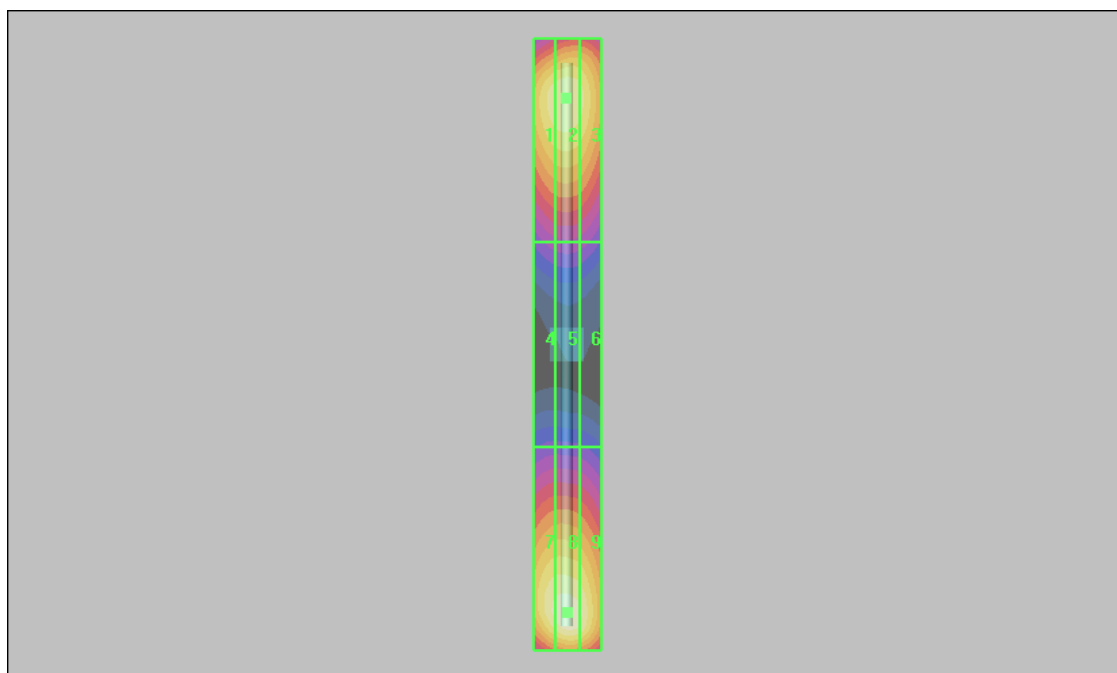
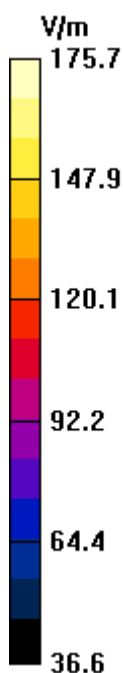

# Test Laboratory: Motorola 20080902, E- 1880 CW -2.0% GOOD

**DUT: HAC Dipole 1880 MHz; Type: CD1880V3; Serial: 1071;**

Procedure Notes: 1880MHz HAC Validation / Dipole Sn# 1071 PM1(A) Power = 100 mW

Communication System: CW - HAC; Frequency: 1880 MHz; Duty Cycle: 1:1

Medium: Air; Medium parameters used:  $\sigma = 0$  mho/m,  $\epsilon_r = 1$ ;  $\rho = 0$  kg/m<sup>3</sup>

DASY4 Configuration:

- Probe: ER3DV6R - SN2249; ConvF(1, 1, 1); Calibrated: 03/17/2008
- Sensor-Surface: 0mm (Fix Surface)Sensor-Surface: (Fix Surface)
- Electronics: DAE3 Sn398; Calibrated: 11/20/2007
- Phantom: R-8, HAC Test Arch (rev.2); Type: SD HAC P01 BA; Serial: 1072;
- Measurement SW: DASY4, V4.7 Build 71; Postprocessing SW: SEMCAD, V1.8 Build 184

## E Scan - ER probe center 10mm above CD1880 Dipole/Hearing Aid Compatibility Test, 1880

**Dipole (41x181x1):** Measurement grid: dx=5mm, dy=5mm

Maximum value of peak Total field = 141.6 V/m

Probe Modulation Factor = 1.00

Device Reference Point: 0.000, 0.000, -6.30 mm

Reference Value = 159.7 V/m; Power Drift = 0.001 dB

Average value of Total (interpolated) = ( 131.2 + 141.6 )/2 = 136.4 V/m

Peak E-field in V/m

Grid 1 <b>128.6 M2</b>	Grid 2 <b>131.2 M2</b>	Grid 3 <b>128.4 M2</b>
Grid 4 <b>89.4 M3</b>	Grid 5 <b>91.1 M3</b>	Grid 6 <b>88.2 M3</b>
Grid 7 <b>134.7 M2</b>	Grid 8 <b>141.6 M2</b>	Grid 9 <b>138.8 M2</b>

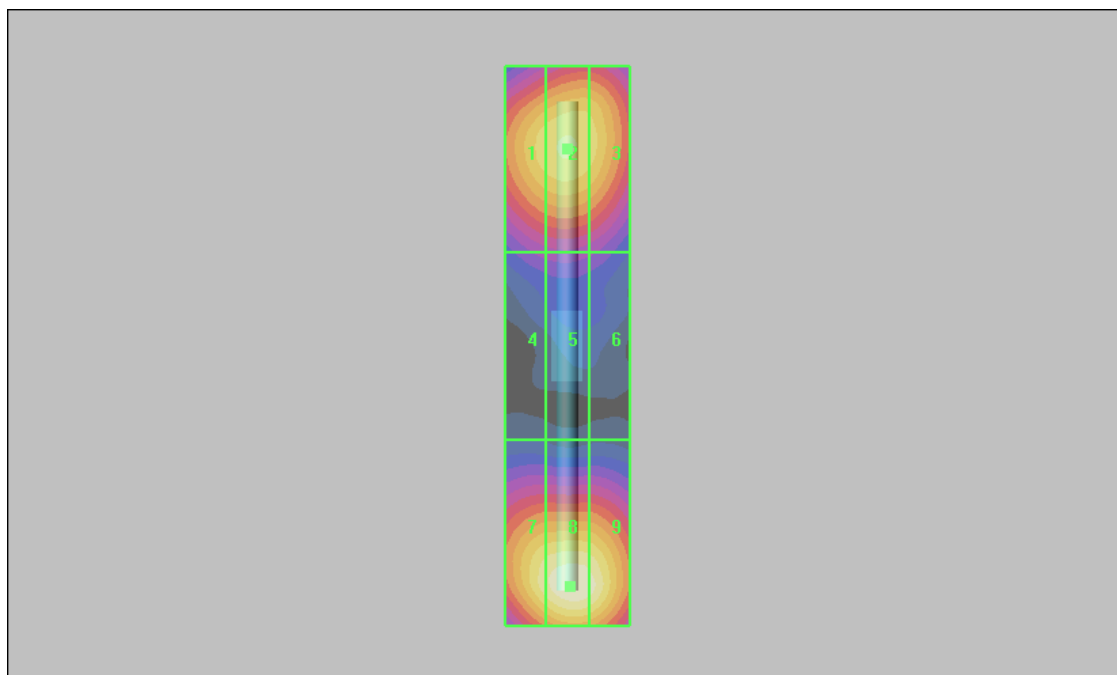
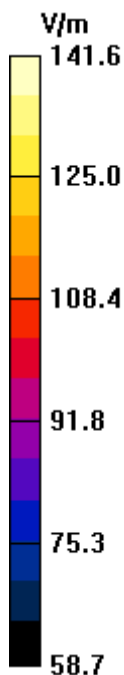

# Test Laboratory: Motorola 20080902, E- 1730 CW -2.5% GOOD

**DUT: HAC Dipole 1880 MHz; Type: CD1880V3; Serial: 1071**

Procedure Notes: 1730 MHz HAC Validation / Dipole Sn# 1071-1730 PM1(A) Power = 100 mW

Communication System: CW - HAC; Frequency: 1730 MHz; Duty Cycle: 1:1

Medium: Air; Medium parameters used:  $\sigma = 0$  mho/m,  $\epsilon_r = 1$ ;  $\rho = 0$  kg/m<sup>3</sup>

DASY4 Configuration:

- Probe: ER3DV6R - SN2249; ConvF(1, 1, 1); Calibrated: 03/17/2008
- Sensor-Surface: 0mm (Fix Surface)Sensor-Surface: (Fix Surface)
- Electronics: DAE3 Sn398; Calibrated: 11/20/2007
- Phantom: R-8, HAC Test Arch (rev.2); Type: SD HAC P01 BA; Serial: 1072;
- Measurement SW: DASY4, V4.7 Build 71; Postprocessing SW: SEMCAD, V1.8 Build 184

## E Scan - ER probe center 10mm above CD1880 Dipole/Hearing Aid Compatibility Test, 1880

**Dipole (41x181x1):** Measurement grid: dx=5mm, dy=5mm

Maximum value of peak Total field = 151.8 V/m

Probe Modulation Factor = 1.00

Device Reference Point: 0.000, 0.000, -6.30 mm

Reference Value = 170.7 V/m; Power Drift = -0.001 dB

Average value of Total (interpolated) = ( 139.4 + 151.8 )/2 = 145.6 V/m

Peak E-field in V/m

Grid 1 <b>137.1 M2</b>	Grid 2 <b>139.4 M2</b>	Grid 3 <b>136.2 M2</b>
Grid 4 <b>100.1 M3</b>	Grid 5 <b>102.0 M3</b>	Grid 6 <b>98.6 M3</b>
Grid 7 <b>144.8 M2</b>	Grid 8 <b>151.8 M2</b>	Grid 9 <b>148.2 M2</b>

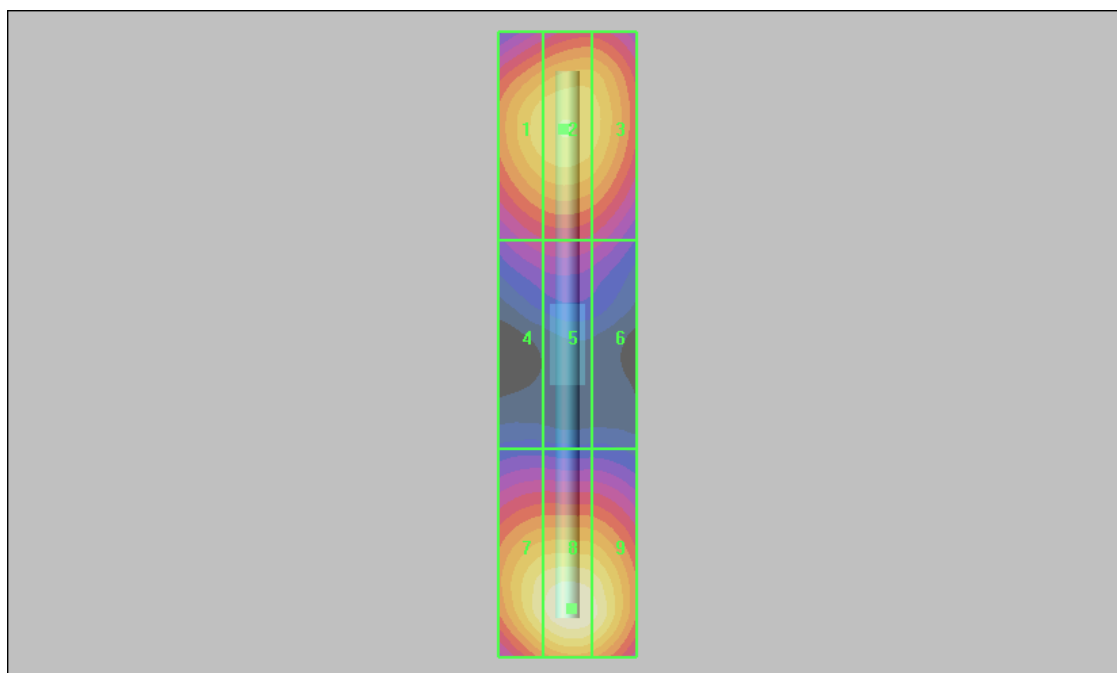
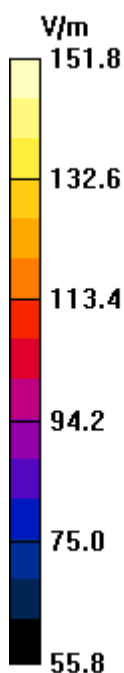

# Test Laboratory: Motorola 20080902, H- 835 CW +6.8% GOOD

**DUT: HAC-Dipole 835 MHz; Type: CD835V3; Serial: 1103;**

Procedure Notes: 835MHz HAC Validation / Dipole Sn# 1103 PM1(A) Power = 100 mW

Communication System: CW - HAC; Frequency: 835 MHz; Duty Cycle: 1:1

Medium: Air; Medium parameters used:  $\sigma = 0$  mho/m,  $\epsilon_r = 1$ ;  $\rho = 0$  kg/m<sup>3</sup>

DASY4 Configuration:

- Probe: H3DV6 - SN6209; ; Calibrated: 01/28/2008
- Sensor-Surface: 0mm (Fix Surface)Sensor-Surface: (Fix Surface)
- Electronics: DAE4 Sn719; Calibrated: 01/29/2008
- Phantom: R-8, HAC Test Arch (rev.2); Type: SD HAC P01 BA; Serial: 1072;
- Measurement SW: DASY4, V4.7 Build 71; Postprocessing SW: SEMCAD, V1.8 Build 184

## H Scan - H3DV6 probe center 10mm above CD835 Dipole/Hearing Aid Compatibility Test, 835

**Dipole (41x361x1):** Measurement grid: dx=5mm, dy=5mm

**Maximum value of peak Total field = 0.473 A/m**

Probe Modulation Factor = 1.00

Device Reference Point: 0.000, 0.000, -6.30 mm

Reference Value = 0.500 A/m; Power Drift = 0.012 dB

Peak H-field in A/m

Grid 1 <b>0.390 M4</b>	Grid 2 <b>0.406 M4</b>	Grid 3 <b>0.388 M4</b>
Grid 4 <b>0.451 M4</b>	Grid 5 <b>0.473 M4</b>	Grid 6 <b>0.451 M4</b>
Grid 7 <b>0.406 M4</b>	Grid 8 <b>0.428 M4</b>	Grid 9 <b>0.408 M4</b>

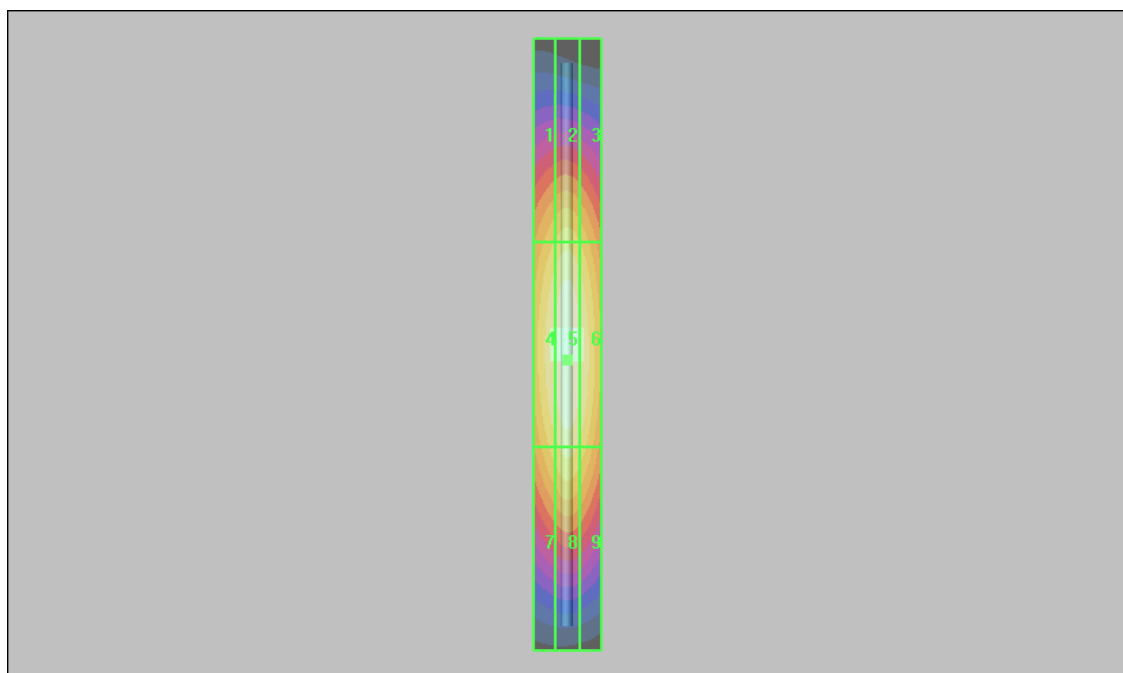
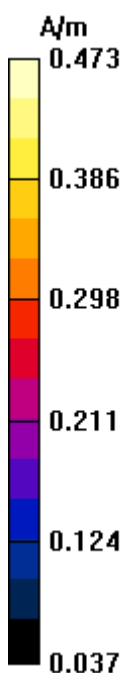

# Test Laboratory: Motorola 20080902, H- 1880 CW -9.0% GOOD

**DUT: HAC Dipole 1880 MHz; Type: CD1880V3; Serial: 1071;**

Procedure Notes: 1880MHz HAC Validation / Dipole Sn# 1071 PM1(A) Power = 100 mW

Communication System: CW - HAC; Frequency: 1880 MHz; Duty Cycle: 1:1

Medium: Air; Medium parameters used:  $\sigma = 0$  mho/m,  $\epsilon_r = 1$ ;  $\rho = 0$  kg/m<sup>3</sup>

DASY4 Configuration:

- Probe: H3DV6 - SN6209; ; Calibrated: 01/28/2008
- Sensor-Surface: 0mm (Fix Surface)Sensor-Surface: (Fix Surface)
- Electronics: DAE4 Sn719; Calibrated: 01/29/2008
- Phantom: R-8, HAC Test Arch (rev.2); Type: SD HAC P01 BA; Serial: 1072;
- Measurement SW: DASY4, V4.7 Build 71; Postprocessing SW: SEMCAD, V1.8 Build 184

## H Scan - H3DV6 probe center 10mm above CD1880 Dipole/Hearing Aid Compatibility Test, 1880

**Dipole (41x181x1):** Measurement grid: dx=5mm, dy=5mm

**Maximum value of peak Total field = 0.425 A/m**

Probe Modulation Factor = 1.00

Device Reference Point: 0.000, 0.000, -6.30 mm

Reference Value = 0.447 A/m; Power Drift = 0.004 dB

Peak H-field in A/m

Grid 1 <b>0.359 M2</b>	Grid 2 <b>0.371 M2</b>	Grid 3 <b>0.354 M2</b>
Grid 4 <b>0.409 M2</b>	Grid 5 <b>0.425 M2</b>	Grid 6 <b>0.406 M2</b>
Grid 7 <b>0.385 M2</b>	Grid 8 <b>0.403 M2</b>	Grid 9 <b>0.383 M2</b>

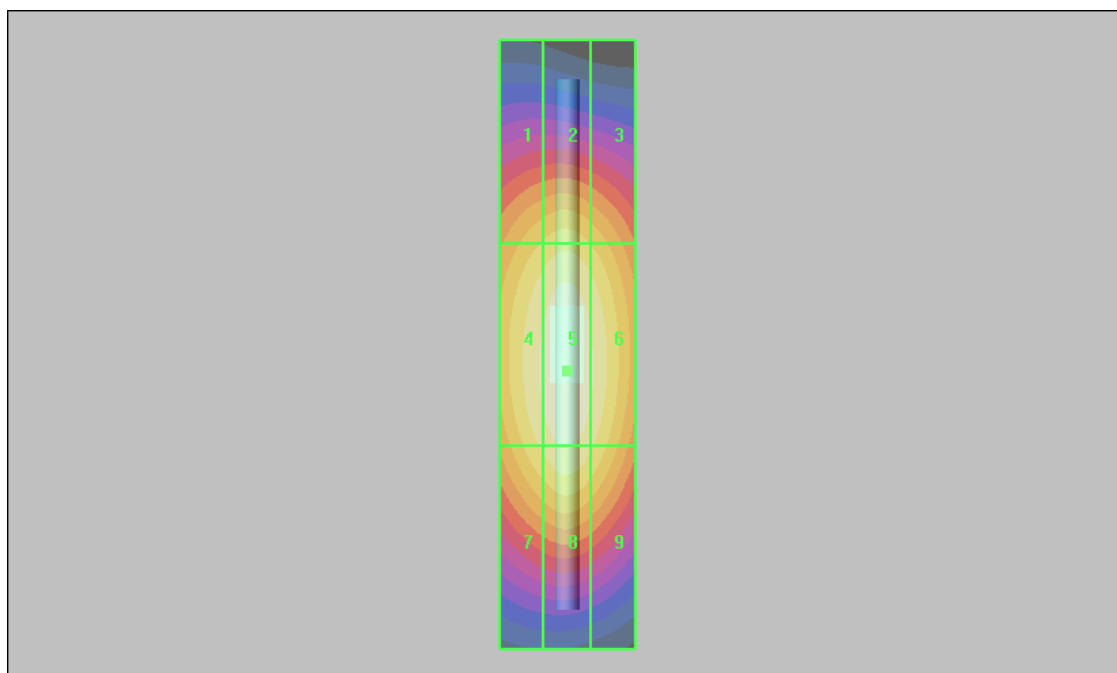
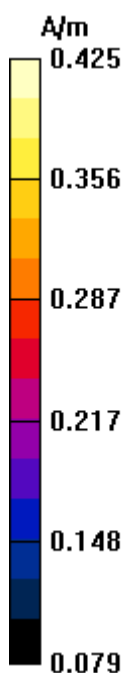

# Test Laboratory: Motorola 20080902, H- 1730 CW -7.0% GOOD

**DUT: HAC Dipole 1880 MHz; Type: CD1880V3; Serial: 1071-1730;**

Procedure Notes: 1730 MHz HAC Validation / Dipole Sn# 1071-1730 PM1(A) Power = 100 mW

Communication System: CW - HAC; Frequency: 1730 MHz; Duty Cycle: 1:1

Medium: Air; Medium parameters used:  $\sigma = 0$  mho/m,  $\epsilon_r = 1$ ;  $\rho = 0$  kg/m<sup>3</sup>

DASY4 Configuration:

- Probe: H3DV6 - SN6209; ; Calibrated: 01/28/2008
- Sensor-Surface: 0mm (Fix Surface)Sensor-Surface: (Fix Surface)
- Electronics: DAE4 Sn719; Calibrated: 01/29/2008
- Phantom: R-8, HAC Test Arch (rev.2); Type: SD HAC P01 BA; Serial: 1072;
- Measurement SW: DASY4, V4.7 Build 71; Postprocessing SW: SEMCAD, V1.8 Build 184

## H Scan - H3DV6 probe center 10mm above CD1880 Dipole/Hearing Aid Compatibility Test, 1880

**Dipole (41x181x1):** Measurement grid: dx=5mm, dy=5mm

**Maximum value of peak Total field = 0.455 A/m**

Probe Modulation Factor = 1.00

Device Reference Point: 0.000, 0.000, -6.30 mm

Reference Value = 0.482 A/m; Power Drift = -0.027 dB

Peak H-field in A/m

Grid 1 <b>0.369 M2</b>	Grid 2 <b>0.384 M2</b>	Grid 3 <b>0.369 M2</b>
Grid 4 <b>0.433 M2</b>	Grid 5 <b>0.455 M2</b>	Grid 6 <b>0.435 M2</b>
Grid 7 <b>0.394 M2</b>	Grid 8 <b>0.416 M2</b>	Grid 9 <b>0.394 M2</b>

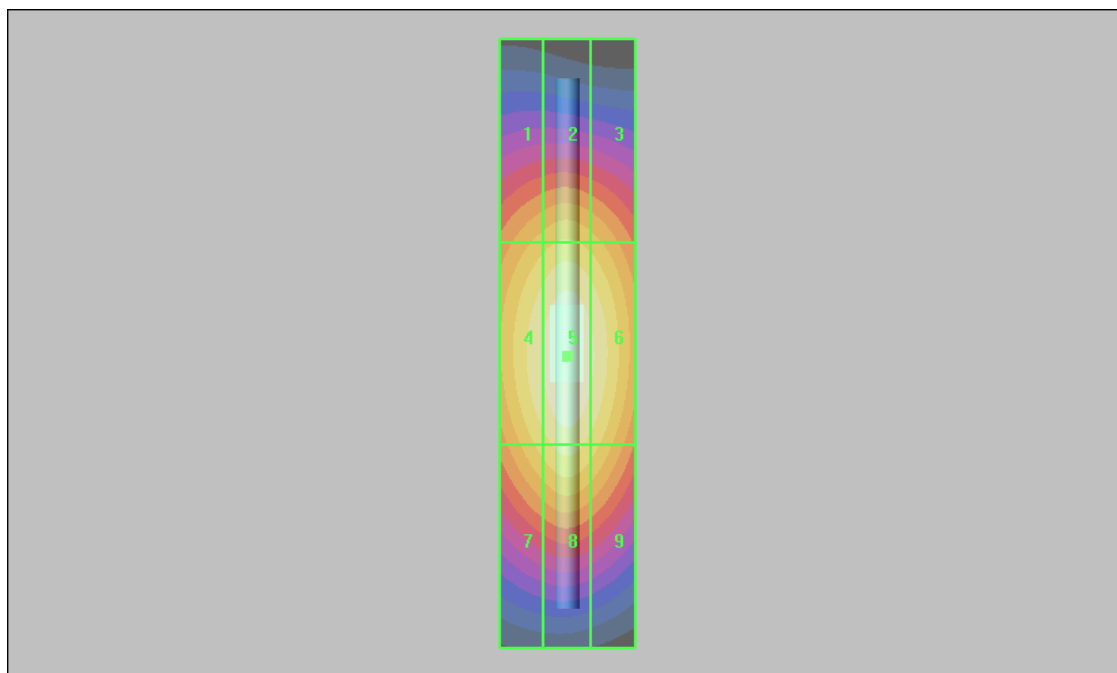
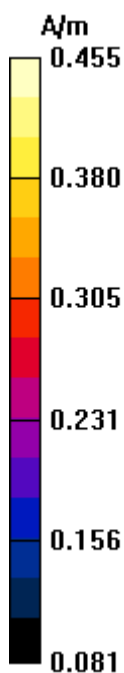

**Appendix 3**

**HAC distribution plots for E-Field and H-Field**

# Test Laboratory: Motorola CDMA800 E-Field (Full Rate)

**Serial: A0000002C6673A**

Procedure Notes: Pwr Step: All Up(OTA); Antenna Position: Internal; Battery Model#: SNN5813A  
 Communication System: CDMA 835; Frequency: 824.7 MHz; Channel Number: 1013; Duty Cycle: 1:1  
 Medium: Air; Medium parameters used:  $\sigma = 0$  mho/m,  $\epsilon_r = 1$ ;  $\rho = 0$  kg/m<sup>3</sup>

DASY4 Configuration:

- Probe: ER3DV6R - SN2249; ConvF(1, 1, 1); Calibrated: 03/17/2008
- Sensor-Surface: (Fix Surface)
- Electronics: DAE3 Sn398; Calibrated: 11/20/2007
- Phantom: R-8, HAC Test Arch (rev.2); Type: SD HAC P01 BA; Serial: 1072;
- Measurement SW: DASY4, V4.7 Build 71; Postprocessing SW: SEMCAD, V1.8 Build 184

## E Scan - ER sensor center 15mm above WD Ref/LOW CH, Hearing Aid Compatibility Test

**(101x101x1):** Measurement grid: dx=5mm, dy=5mm

**Maximum value of peak Total field = 101.5 V/m**

Probe Modulation Factor = 1.06

Device Reference Point: 0.000, 0.000, -6.30 mm

Reference Value = 123.5 V/m; Power Drift = 0.134 dB

**Hearing Aid Near-Field Category: M4 (AWF 0 dB)**

Peak E-field in V/m

Grid 1 <b>91.9 M4</b>	Grid 2 <b>97.1 M4</b>	Grid 3 <b>92.6 M4</b>
Grid 4 <b>94.3 M4</b>	Grid 5 <b>101.5 M4</b>	Grid 6 <b>98.2 M4</b>
Grid 7 <b>92.7 M4</b>	Grid 8 <b>100.0 M4</b>	Grid 9 <b>95.1 M4</b>

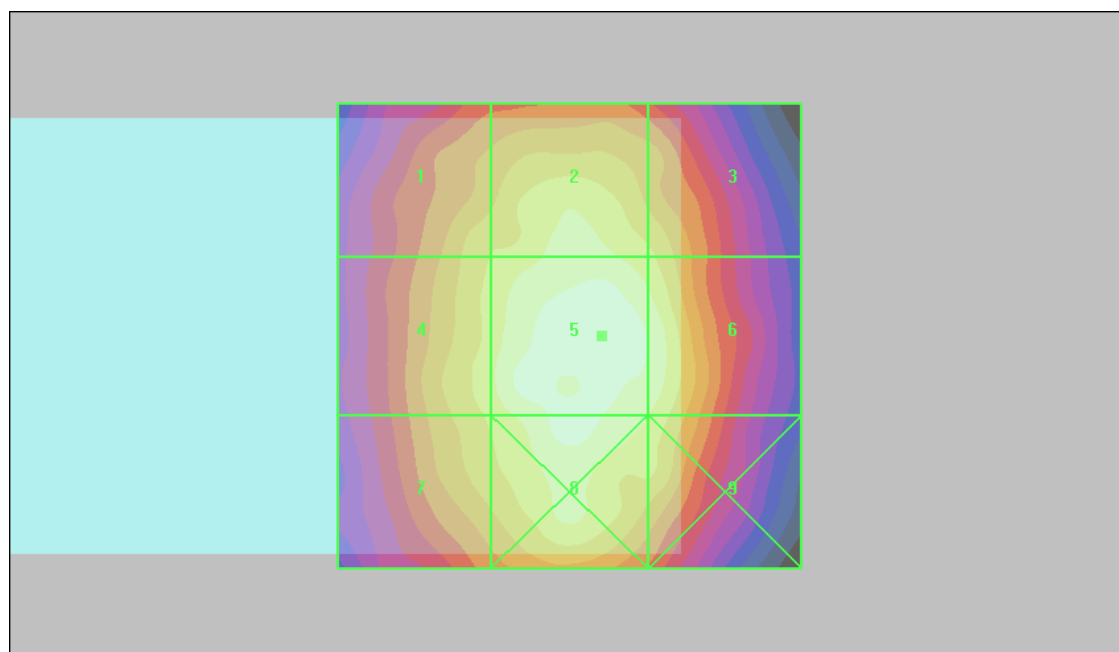
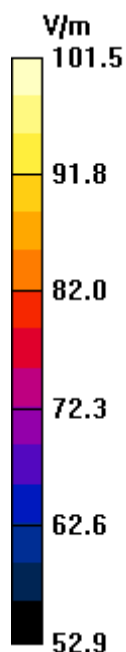

# Test Laboratory: MotorolaCD MA1900 E-Field(Full Rate)

**Serial: A0000002C6673A**

Procedure Notes: Pwr Step: All Up(OTA); Antenna Position: Internal; Battery Model#: SNN5813A

Communication System: CDMA 1900; Frequency: 1851.25 MHz; Channel Number: 25; Duty Cycle: 1:1

Medium: Air; Medium parameters used:  $\sigma = 0$  mho/m,  $\epsilon_r = 1$ ;  $\rho = 0$  kg/m<sup>3</sup>

DASY4 Configuration:

- Probe: ER3DV6R - SN2249; ConvF(1, 1, 1); Calibrated: 03/17/2008
- Sensor-Surface: (Fix Surface)
- Electronics: DAE3 Sn398; Calibrated: 11/20/2007
- Phantom: R-8, HAC Test Arch (rev.2); Type: SD HAC P01 BA; Serial: 1072;
- Measurement SW: DASY4, V4.7 Build 71; Postprocessing SW: SEMCAD, V1.8 Build 184

## E Scan - ER sensor center 15mm above WD Ref/LOW CH, Hearing Aid Compatibility Test

**(101x101x1):** Measurement grid: dx=5mm, dy=5mm

**Maximum value of peak Total field = 41.3 V/m**

Probe Modulation Factor = 1.05

Device Reference Point: 0.000, 0.000, -6.30 mm

Reference Value = 46.5 V/m; Power Drift = 0.122 dB

**Hearing Aid Near-Field Category: M4 (AWF 0 dB)**

Peak E-field in V/m

Grid 1 <b>29.7 M4</b>	Grid 2 <b>41.3 M4</b>	Grid 3 <b>41.5 M4</b>
Grid 4 <b>26.7 M4</b>	Grid 5 <b>41.3 M4</b>	Grid 6 <b>41.5 M4</b>
Grid 7 <b>22.1 M4</b>	Grid 8 <b>36.3 M4</b>	Grid 9 <b>36.5 M4</b>

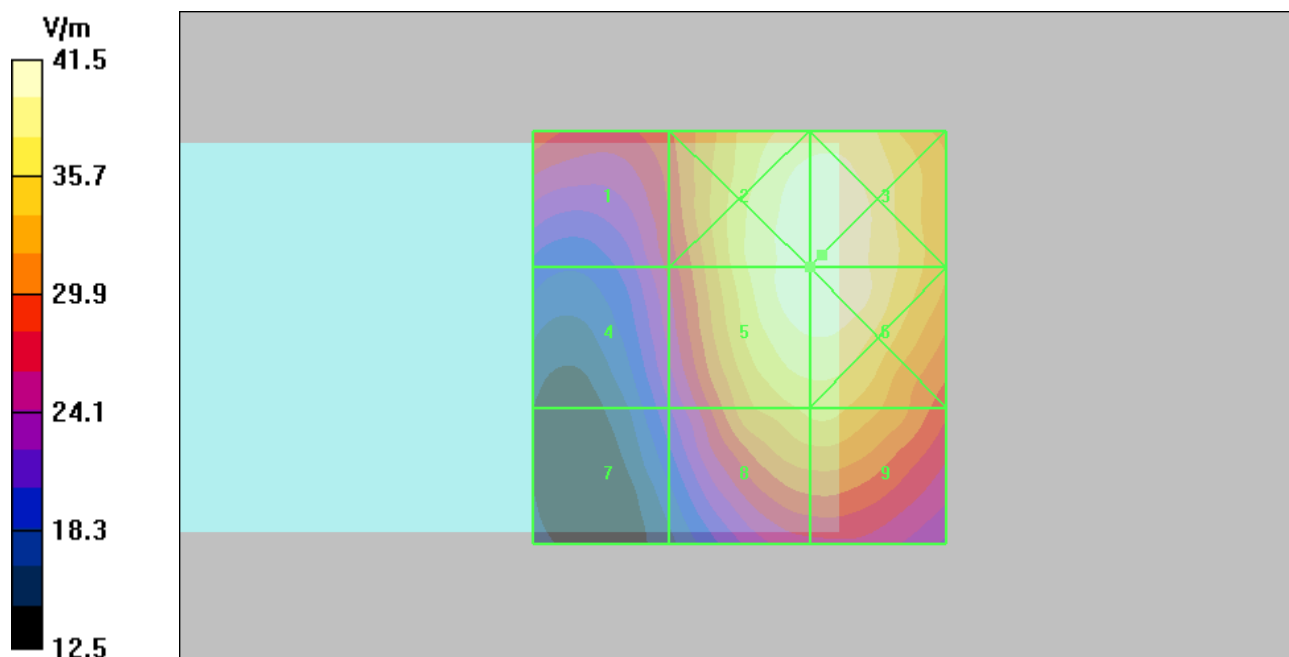

# Test Laboratory: Motorola CDMA1700 E-Field(1/8 Rate)

**Serial: A0000002C6673A ;**

Procedure Notes: Pwr Step: All Up(OTA); Antenna Position: Internal; Battery Model#: SNN5782A

Communication System: CDMA 1700 - 8th Vocoder (HAC); Frequency: 1732.5 MHz;

Channel Number: 450; Duty Cycle: 1:8

Medium: Air; Medium parameters used:  $\sigma = 0$  mho/m,  $\epsilon_r = 1$ ;  $\rho = 0$  kg/m<sup>3</sup>

DASY4 Configuration:

- Probe: ER3DV6R - SN2249; ConvF(1, 1, 1); Calibrated: 03/17/2008
- Sensor-Surface: (Fix Surface)
- Electronics: DAE3 Sn398; Calibrated: 11/20/2007
- Phantom: R-8, HAC Test Arch (rev.2); Type: SD HAC P01 BA; Serial: 1072;
- Measurement SW: DASY4, V4.7 Build 71; Postprocessing SW: SEMCAD, V1.8 Build 184

## E Scan - ER sensor center 15mm above WD Ref 2/MID CH, Hearing Aid Compatibility Test

**(101x101x1):** Measurement grid: dx=5mm, dy=5mm

**Maximum value of peak Total field = 48.6 V/m**

Probe Modulation Factor = 2.95

Device Reference Point: 0.000, 0.000, -6.30 mm

Reference Value = 18.0 V/m; Power Drift = 0.154 dB

**Hearing Aid Near-Field Category: M4 (AWF 0 dB)**

Peak E-field in V/m

Grid 1 <b>33.7 M4</b>	Grid 2 <b>45.9 M4</b>	Grid 3 <b>46.0 M4</b>
Grid 4 <b>32.8 M4</b>	Grid 5 <b>48.6 M4</b>	Grid 6 <b>49.8 M4</b>
Grid 7 <b>29.4 M4</b>	Grid 8 <b>42.0 M4</b>	Grid 9 <b>42.0 M4</b>

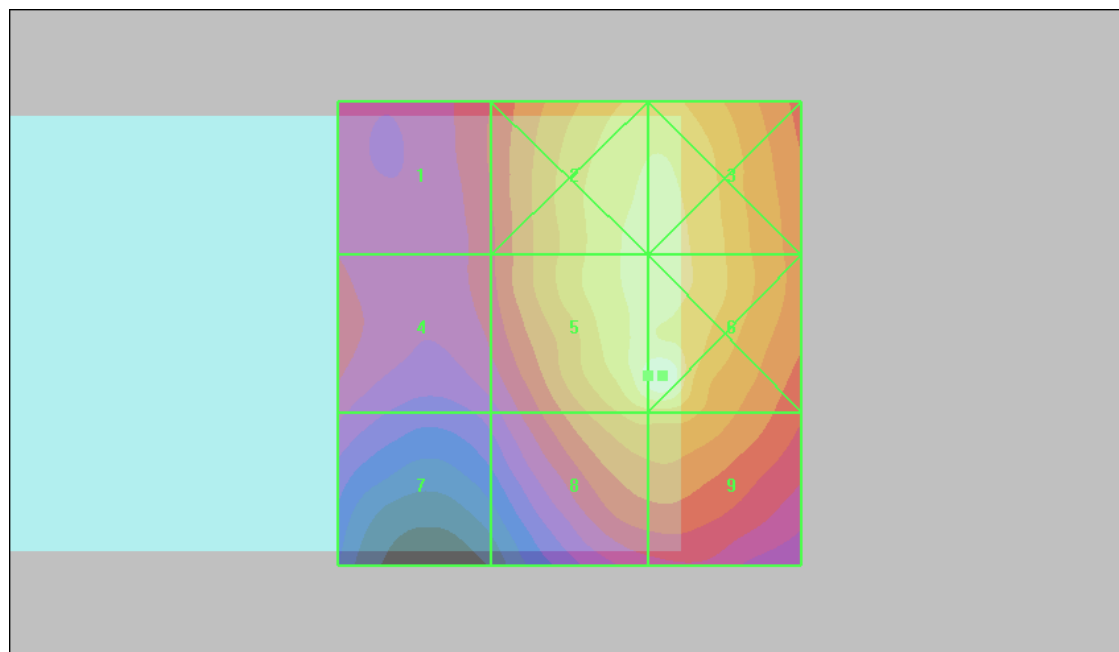
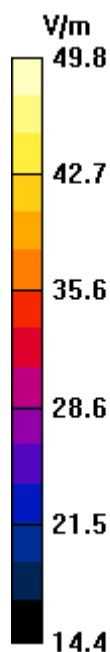

# Test Laboratory: Motorola CDMA800 H-Field (Full Rate)

**Serial: A0000002C6673A**

Procedure Notes: Pwr Step: All Up(OTA); Antenna Position: Internal; Battery Model#: SNN5813A  
 Communication System: CDMA 835; Frequency: 824.7 MHz; Channel Number: 1013; Duty Cycle: 1:1  
 Medium: Air; Medium parameters used:  $\sigma = 0$  mho/m,  $\epsilon_r = 1$ ;  $\rho = 0$  kg/m<sup>3</sup>

DASY4 Configuration:

- Probe: H3DV6 - SN6209; ; Calibrated: 01/28/2008
- Sensor-Surface: (Fix Surface)
- Electronics: DAE4 Sn719; Calibrated: 01/29/2008
- Phantom: R-8, HAC Test Arch (rev.2); Type: SD HAC P01 BA; Serial: 1072;
- Measurement SW: DASY4, V4.7 Build 71; Postprocessing SW: SEMCAD, V1.8 Build 184

## H Scan - H3DV6 sensor center 15mm above WD Ref/LOW CH, Hearing Aid Compatibility Test

**(101x101x1):** Measurement grid: dx=5mm, dy=5mm

**Maximum value of peak Total field = 0.140 A/m**

Probe Modulation Factor = 0.990

Device Reference Point: 0.000, 0.000, -6.30 mm

Reference Value = 0.108 A/m; Power Drift = -0.068 dB

**Hearing Aid Near-Field Category: M4 (AWF 0 dB)**

Peak H-field in A/m

Grid 1 <b>0.186 M4</b>	Grid 2 <b>0.135 M4</b>	Grid 3 <b>0.084 M4</b>
Grid 4 <b>0.190 M4</b>	Grid 5 <b>0.135 M4</b>	Grid 6 <b>0.087 M4</b>
Grid 7 <b>0.195 M4</b>	Grid 8 <b>0.140 M4</b>	Grid 9 <b>0.092 M4</b>

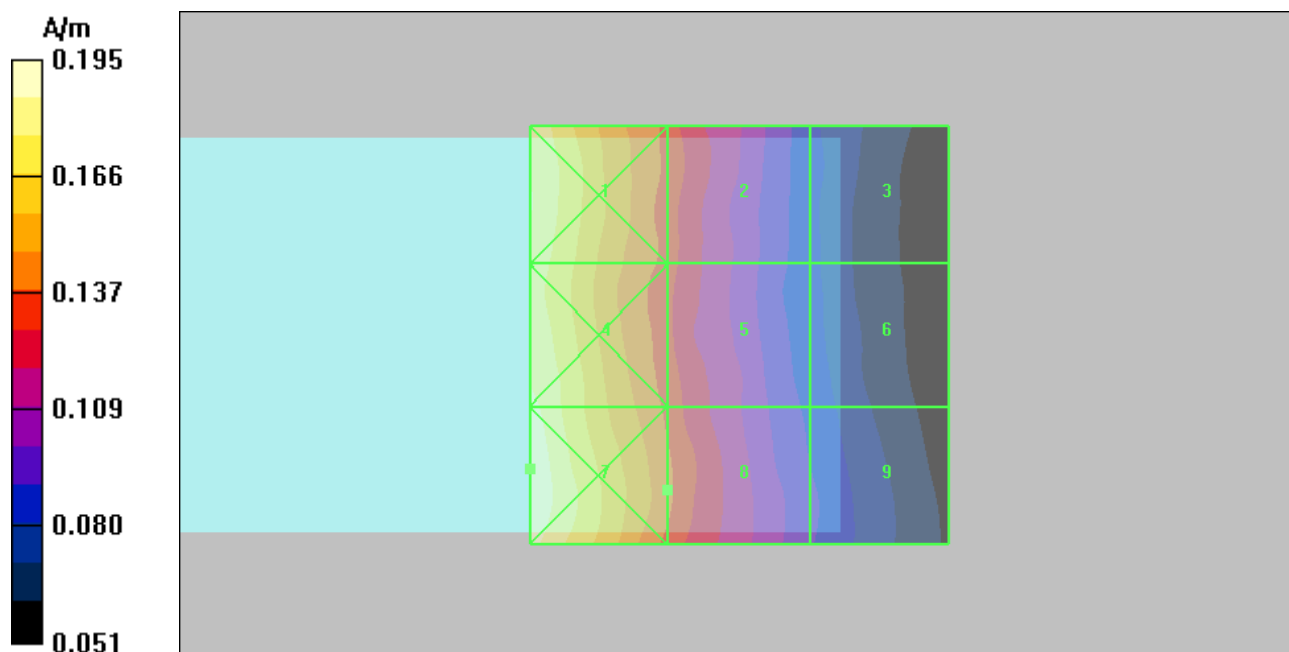

# Test Laboratory: Motorola CDMA1900 H-Field(1/8 Rate)

**Serial: A0000002C6673A ;**

Procedure Notes: Pwr Step: All Up(OTA); Antenna Position: Internal; Battery Model#: SNN5826A

Communication System: CDMA 1900, 8th Vocoder; Frequency: 1851.25 MHz; Channel Number: 25; Duty Cycle: 1:8

Medium: Air; Medium parameters used:  $\sigma = 0$  mho/m,  $\epsilon_r = 1$ ;  $\rho = 0$  kg/m<sup>3</sup>

DASY4 Configuration:

- Probe: H3DV6 - SN6209; ; Calibrated: 01/28/2008
- Sensor-Surface: (Fix Surface)
- Electronics: DAE4 Sn719; Calibrated: 01/29/2008
- Phantom: R-8, HAC Test Arch (rev.2); Type: SD HAC P01 BA; Serial: 1072;
- Measurement SW: DASY4, V4.7 Build 71; Postprocessing SW: SEMCAD, V1.8 Build 184

## H Scan - H3DV6 sensor center 15mm above WD Ref/LOW CH, Hearing Aid Compatibility Test

**(101x101x1):** Measurement grid: dx=5mm, dy=5mm

**Maximum value of peak Total field = 0.133 A/m**

Probe Modulation Factor = 2.65

Device Reference Point: 0.000, 0.000, -6.30 mm

Reference Value = 0.042 A/m; Power Drift = -0.214 dB

**Hearing Aid Near-Field Category: M4 (AWF 0 dB)**

Peak H-field in A/m

Grid 1 <b>0.161 M4</b>	Grid 2 <b>0.151 M4</b>	Grid 3 <b>0.110 M4</b>
Grid 4 <b>0.129 M4</b>	Grid 5 <b>0.133 M4</b>	Grid 6 <b>0.098 M4</b>
Grid 7 <b>0.105 M4</b>	Grid 8 <b>0.111 M4</b>	Grid 9 <b>0.090 M4</b>

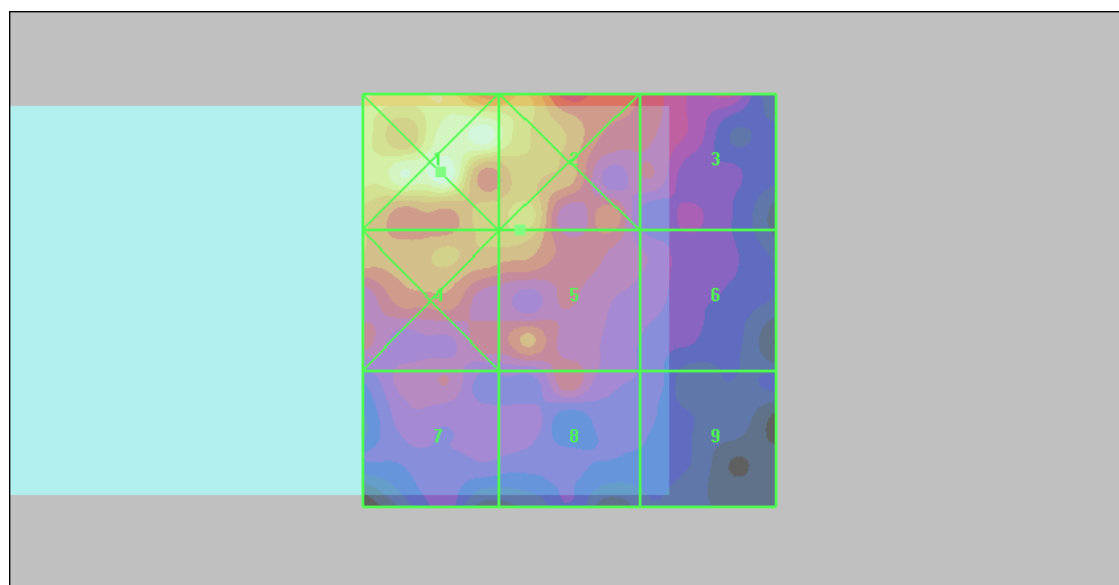
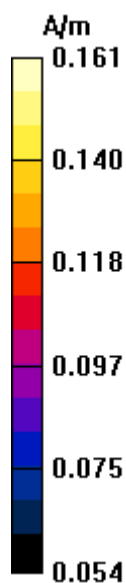

# Test Laboratory: Motorola CDMA1700 H-Field(Full Rate)

**Serial: A0000002C6673A ;**

Procedure Notes: Pwr Step: All Up(OTA); Antenna Position: Internal; Battery Model#: SNN5782A

Communication System: CDMA 1700; Frequency: 1753.75 MHz; Channel Number: 875; Duty Cycle: 1:1

Medium: Air; Medium parameters used:  $\sigma = 0$  mho/m,  $\epsilon_r = 1$ ;  $\rho = 0$  kg/m<sup>3</sup>

DASY4 Configuration:

- Probe: H3DV6 - SN6209; ; Calibrated: 01/28/2008
- Sensor-Surface: (Fix Surface)
- Electronics: DAE4 Sn719; Calibrated: 01/29/2008
- Phantom: R-8, HAC Test Arch (rev.2); Type: SD HAC P01 BA; Serial: 1072;
- Measurement SW: DASY4, V4.7 Build 71; Postprocessing SW: SEMCAD, V1.8 Build 184

## H Scan - H3DV6 sensor center 15mm above WD Ref 3/HIGH CH, Hearing Aid Compatibility

**Test (101x101x1):** Measurement grid: dx=5mm, dy=5mm

**Maximum value of peak Total field = 0.132 A/m**

Probe Modulation Factor = 1.04

Device Reference Point: 0.000, 0.000, -6.30 mm

Reference Value = 0.117 A/m; Power Drift = -0.022 dB

**Hearing Aid Near-Field Category: M4 (AWF 0 dB)**

Peak H-field in A/m

Grid 1 <b>0.159 M4</b>	Grid 2 <b>0.138 M4</b>	Grid 3 <b>0.098 M4</b>
Grid 4 <b>0.151 M4</b>	Grid 5 <b>0.131 M4</b>	Grid 6 <b>0.100 M4</b>
Grid 7 <b>0.132 M4</b>	Grid 8 <b>0.125 M4</b>	Grid 9 <b>0.101 M4</b>

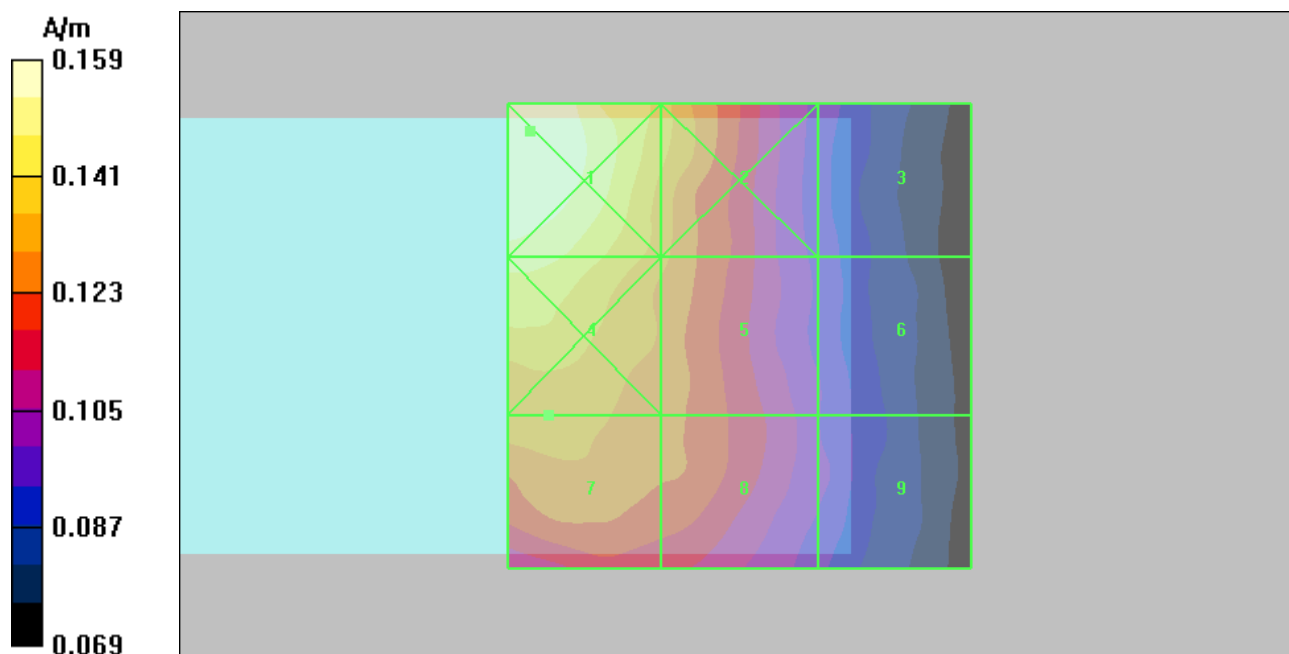

**Appendix 4**

**Measurement Uncertainty Budget**

**A4.1 Motorola Uncertainty Budget for RF HAC Testing**

**TABLE A4.1: Motorola Uncertainty Budget**

UNCERTAINTY DESCRIPTION	Uncertainty Value (+/- %)	Prob. Dist.	Div.	(ci) E	(ci) H	Std. Unc. E	Std. Unc. H
<b>MEASUREMENT SYSTEM</b>							
Probe Calibration	5.1%	N	1.0000	1	1	5.1%	5.1%
Axial Isotropy	7.8%	R	1.7321	1	0.786	4.5%	3.5%
Sensor Displacement	16.5%	R	1.7321	1	0.145	9.5%	1.4%
Boundary Effects	2.4%	R	1.7321	1	1	1.4%	1.4%
Linearity	4.7%	R	1.7321	1	1	2.7%	2.7%
Scaling to Peak Envelope Power	2.0%	R	1.7321	1	1	1.2%	1.2%
System Detection Limit	1.0%	R	1.7321	1	1	0.6%	0.6%
Readout Electronics	0.3%	N	1.0000	1	1	0.3%	0.3%
Response Time	0.8%	R	1.7321	1	1	0.5%	0.5%
Integration Time	2.6%	R	1.7321	1	1	1.5%	1.5%
RF Reflections	5.6%	R	1.7321	1	1	3.2%	3.2%
Probe Positioner	1.2%	R	1.7321	1	0.67	0.7%	0.5%
Probe Positioning	4.7%	R	1.7321	1	0.67	2.7%	1.8%
Extrap. & Interpolation	1.0%	R	1.7321	1	1	0.6%	0.6%
<b>TEST SAMPLE RELATED</b>							
Total Device Positioning	3.2%	R	1.7321	1	1.306	1.8%	2.4%
Device Holder & Phantom	2.4%	R	1.7321	1	1	1.4%	1.4%
Power Drift	5.0%	R	1.7321	1	1	2.9%	2.9%
<b>PHANTOM AND SETUP RELATED</b>							
Phantom Thickness	2.4%	R	1.7321	1	0.67	1.4%	0.9%
<b>Combined Std.Uncertainty</b>						<b>13.6%</b>	<b>9.2%</b>
<b>Expanded Std. Uncertainty on Power</b>						<b>27.2%</b>	<b>18.4%</b>

**A4.2 Probe Rotation Contributions to Isotropy Error**

Probe rotation data was taken “for special focus on spherical isotropicity in measurement uncertainty and perturbation of EM fields.” This data was taken at the interpolated maximum and directly accounted for in the uncertainty budget as “Axial Isotropy.” Thirteen mobile devices were used to determine the probe isotropy uncertainty factors in section A4.1. Based on the resulting 82 E-Field probe rotations and 82 H-Field probe rotations, the upper 95% confidence interval value was calculated for each. These values represent a conservative assessment of the effect of the probe isotropy and have been appropriately included in the respective E- and H-uncertainty budgets.

**TABLE A4.2: Probe Rotation Data Summary**

	AVE	ST.DEV	Sample Size (n)	2σ	(ci)	Standard Uncertainty
E-field	4.4%	1.7%	82	7.8%	1	4.5%
H-field	3.8%	1.2%	82	6.1%	0.786	3.5%

Isotropy error measurements were taken for 13 products across the respective frequency bands. The +2σ values of all measurements was used as a worst case value for the uncertainty budget. Any significant differences between bands were also evaluated.

**Appendix 5**  
**Pictures of Test Setup**

See Exhibit 7B

**Appendix 6**

**Probe Calibration Certificates**



Accredited by the Swiss Accreditation Service (SAS)  
The Swiss Accreditation Service is one of the signatories to the EA  
Multilateral Agreement for the recognition of calibration certificates

Accreditation No.: **SCS 108**

Client **Motorola MDb**

Certificate No: **ER3-2249\_Mar08**

**CALIBRATION CERTIFICATE**

Object **ER3DV6R- SN:2249**

Calibration procedure(s) **QA-CAL-02.v5  
Calibration procedure for E-field probes optimized for close near field  
evaluations in air**

Calibration date: **March 17, 2008**

Condition of the calibrated item **In Tolerance**

This calibration certificate documents the traceability to national standards, which realize the physical units of measurements (SI).  
The measurements and the uncertainties with confidence probability are given on the following pages and are part of the certificate.

All calibrations have been conducted in the closed laboratory facility: environment temperature (22 ± 3)°C and humidity < 70%.

Calibration Equipment used (M&TE critical for calibration)

Primary Standards	ID #	Cal Date (Calibrated by, Certificate No.)	Scheduled Calibration
Power meter E4419B	GB41293874	29-Mar-07 (METAS, No. 217-00670)	Mar-08
Power sensor E4412A	MY41495277	29-Mar-07 (METAS, No. 217-00670)	Mar-08
Power sensor E4412A	MY41498087	29-Mar-07 (METAS, No. 217-00670)	Mar-08
Reference 3 dB Attenuator	SN: S5054 (3c)	8-Aug-07 (METAS, No. 217-00719)	Aug-08
Reference 20 dB Attenuator	SN: S5086 (20b)	29-Mar-07 (METAS, No. 217-00671)	Mar-08
Reference 30 dB Attenuator	SN: S5129 (30b)	8-Aug-07 (METAS, No. 217-00720)	Aug-08
Reference Probe ER3DV6	SN: 2328	2-Oct-07 (SPEAG, No. ER3-2328_Oct07)	Oct-08
DAE4	SN: 654	20-Apr-07 (SPEAG, No. DAE4-654_Apr07)	Apr-08
Secondary Standards	ID #	Check Date (in house)	Scheduled Check
RF generator HP 8648C	US3642U01700	4-Aug-99 (SPEAG, in house check Oct-07)	In house check: Oct-09
Network Analyzer HP 8753E	US37390585	18-Oct-01 (SPEAG, in house check Oct-07)	In house check: Oct-08

Calibrated by:	Name	Function	Signature
	Katja Pokovic	Technical Manager	
Approved by:	Name	Function	Signature
	Niels Kuster	Quality Manager	

Issued: March 17, 2008

This calibration certificate shall not be reproduced except in full without written approval of the laboratory.



Accredited by the Swiss Accreditation Service (SAS)

The Swiss Accreditation Service is one of the signatories to the EA  
Multilateral Agreement for the recognition of calibration certificates

Accreditation No.: **SCS 108**

**Glossary:**

NORM <sub>x,y,z</sub>	sensitivity in free space
DCP	diode compression point
Polarization $\phi$	$\phi$ rotation around probe axis
Polarization $\vartheta$	$\vartheta$ rotation around an axis that is in the plane normal to probe axis (at measurement center), i.e., $\vartheta = 0$ is normal to probe axis
Connector Angle	information used in DASY system to align probe sensor X to the robot coordinate system

**Calibration is Performed According to the Following Standards:**

- a) IEEE Std 1309-2005, "IEEE Standard for calibration of electromagnetic field sensors and probes, excluding antennas, from 9 kHz to 40 GHz", December 2005.

**Methods Applied and Interpretation of Parameters:**

- *NORM<sub>x,y,z</sub>*: Assessed for E-field polarization  $\vartheta = 0$  for XY sensors and  $\vartheta = 90$  for Z sensor ( $f \leq 900$  MHz in TEM-cell;  $f > 1800$  MHz: R22 waveguide).
- *NORM(f)<sub>x,y,z</sub>* = *NORM<sub>x,y,z</sub>* \* *frequency\_response* (see Frequency Response Chart).
- *DCP<sub>x,y,z</sub>*: DCP are numerical linearization parameters assessed based on the data of power sweep (no uncertainty required). DCP does not depend on frequency.
- *Spherical isotropy (3D deviation from isotropy)*: in a locally homogeneous field realized using an open waveguide setup.
- *Sensor Offset*: The sensor offset corresponds to the offset of virtual measurement center from the probe tip (on probe axis). No tolerance required.
- *Connector Angle*: The angle is assessed using the information gained by determining the *NORM<sub>x</sub>* (no uncertainty required).

# Probe ER3DV6R

## SN:2249

Manufactured:	February 1, 2000
Last calibrated:	January 23, 2007
Recalibrated:	March 17, 2008

Calibrated for DASYS Systems

(Note: non-compatible with DASYS2 system!)

**DASY - Parameters of Probe: ER3DV6R SN:2249**

Sensitivity in Free Space [ $\mu\text{V}/(\text{V}/\text{m})^2$ ]		Diode Compression <sup>A</sup>	
NormX	<b>1.70 ± 10.1 % (k=2)</b>	DCP X	<b>94 mV</b>
NormY	<b>1.87 ± 10.1 % (k=2)</b>	DCP Y	<b>94 mV</b>
NormZ	<b>2.00 ± 10.1 % (k=2)</b>	DCP Z	<b>99 mV</b>

## Frequency Correction

X	<b>0.0</b>
Y	<b>0.0</b>
Z	<b>0.0</b>

## Sensor Offset (Probe Tip to Sensor Center)

X	<b>2.5 mm</b>
Y	<b>2.5 mm</b>
Z	<b>2.5 mm</b>

Connector Angle **-324 °**

**The reported uncertainty of measurement is stated as the standard uncertainty of measurement multiplied by the coverage factor k=2, which for a normal distribution corresponds to a coverage probability of approximately 95%.**

<sup>A</sup> numerical linearization parameter: uncertainty not required

# Frequency Response of E-Field

(TEM-Cell:ifi110 EXX, Waveguide R22)

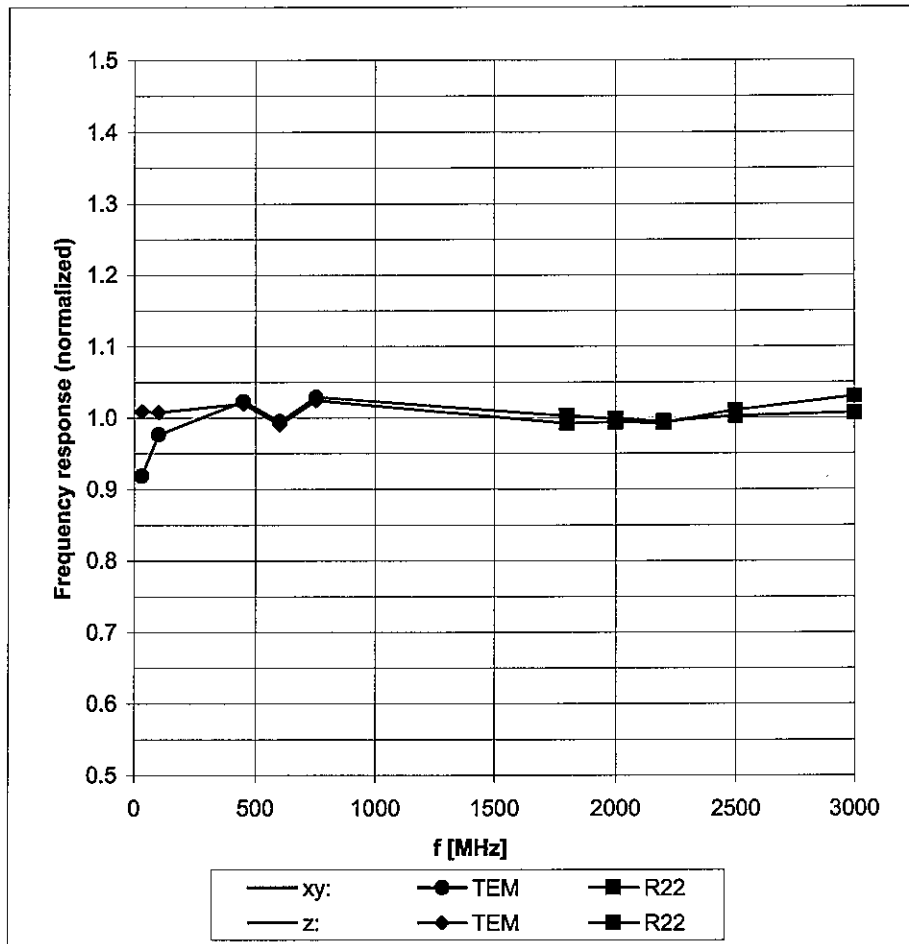

Uncertainty of Frequency Response of E-field:  $\pm 6.3\%$  (k=2)

### Receiving Pattern ( $\phi$ ), $\vartheta = 0^\circ$

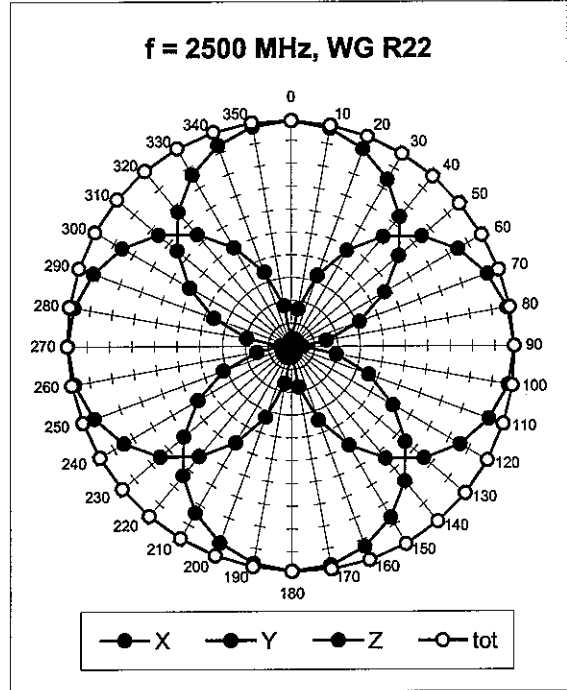
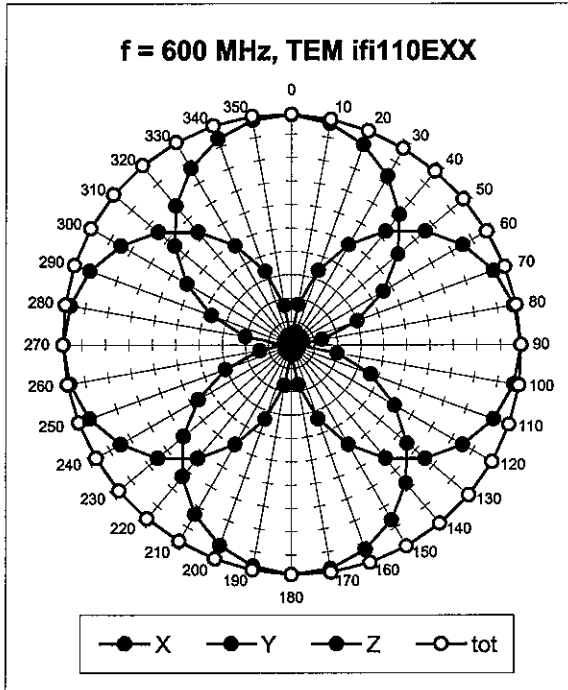

### Receiving Pattern ( $\phi$ ), $\vartheta = 90^\circ$

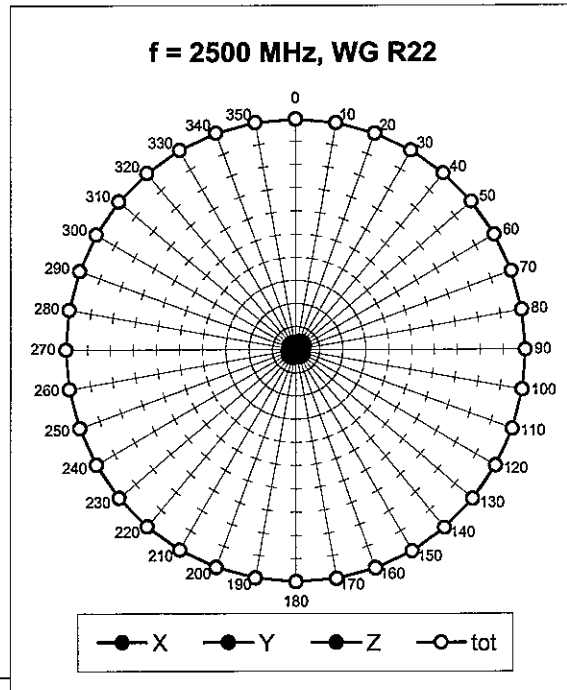
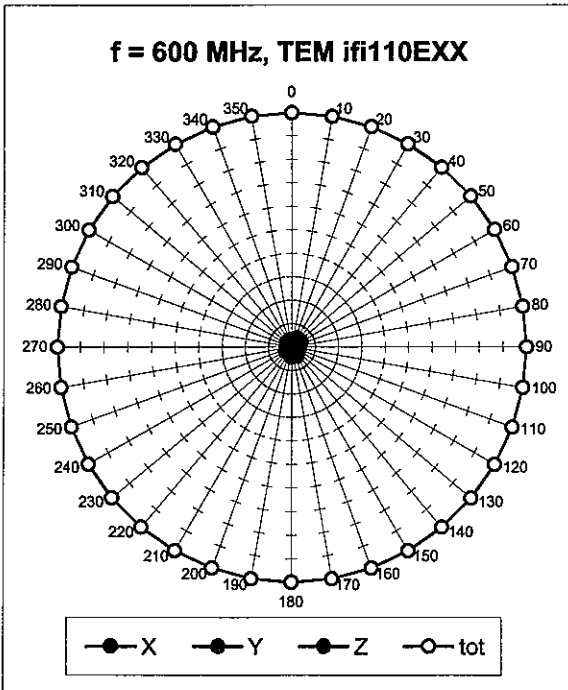

### Receiving Pattern ( $\phi$ ), $\vartheta = 0^\circ$

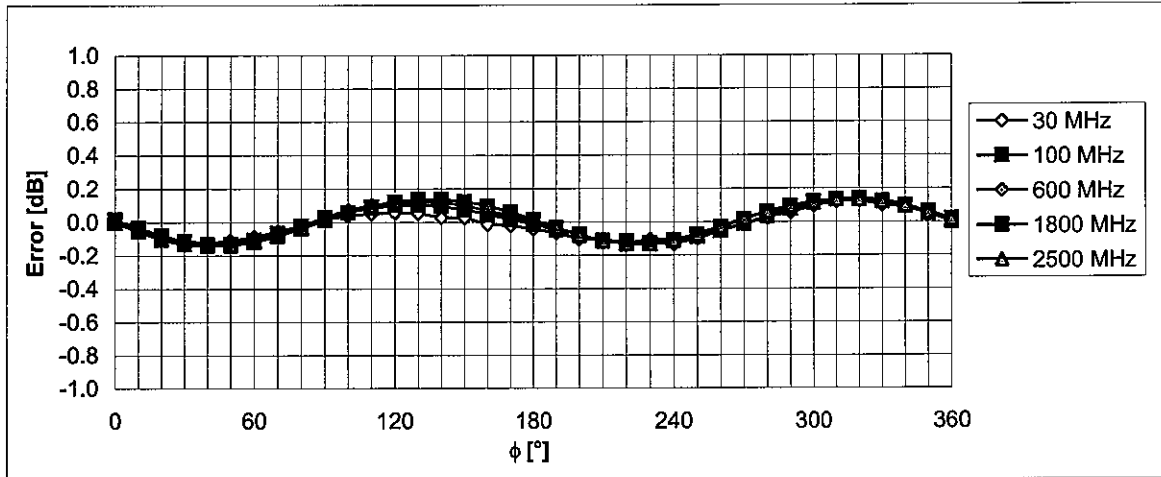

Uncertainty of Axial Isotropy Assessment:  $\pm 0.5\%$  ( $k=2$ )

### Receiving Pattern ( $\phi$ ), $\vartheta = 90^\circ$

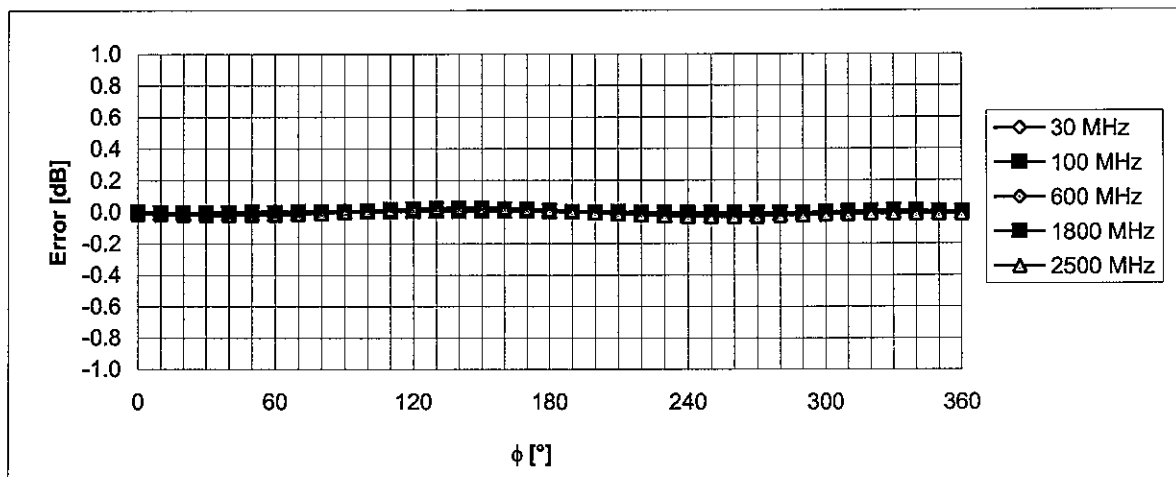

Uncertainty of Axial Isotropy Assessment:  $\pm 0.5\%$  ( $k=2$ )

### Dynamic Range f(E-field) (Waveguide R22, f = 1800 MHz)

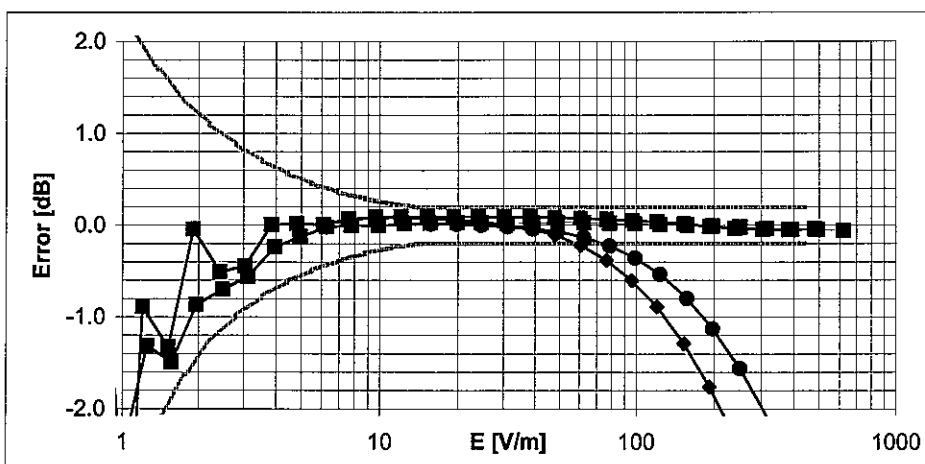
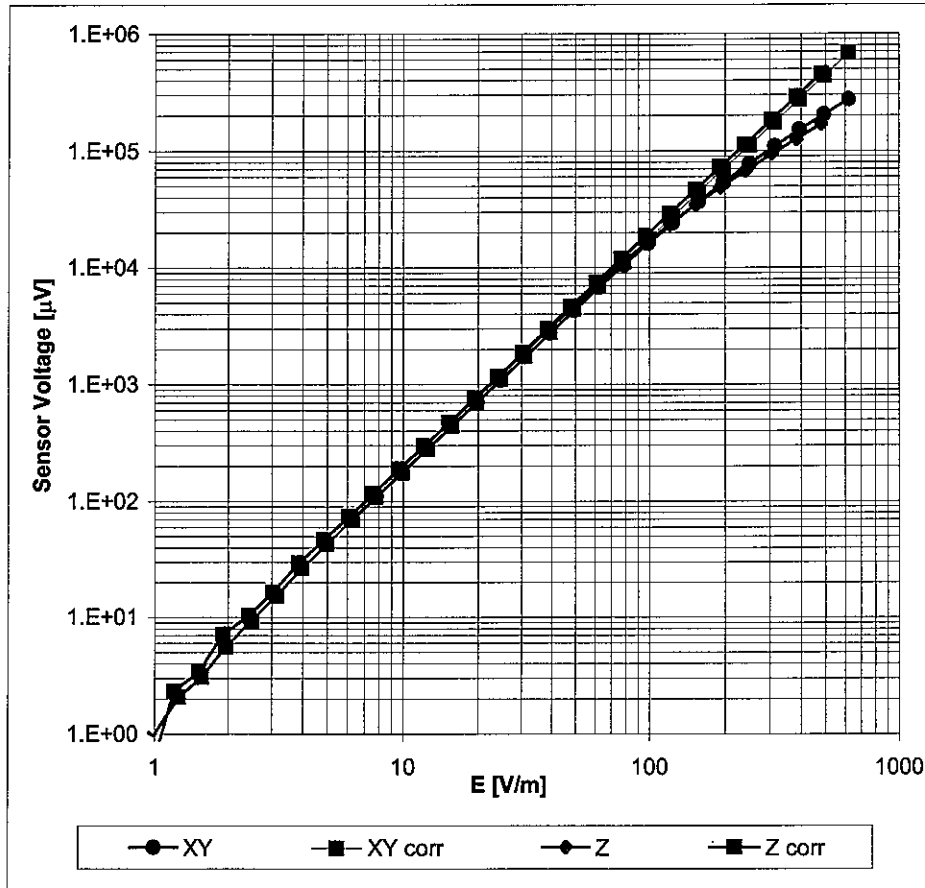

Uncertainty of Linearity Assessment:  $\pm 0.6\%$  ( $k=2$ )

### Deviation from Isotropy in Air Error ( $\phi, \vartheta$ ), $f = 900$ MHz

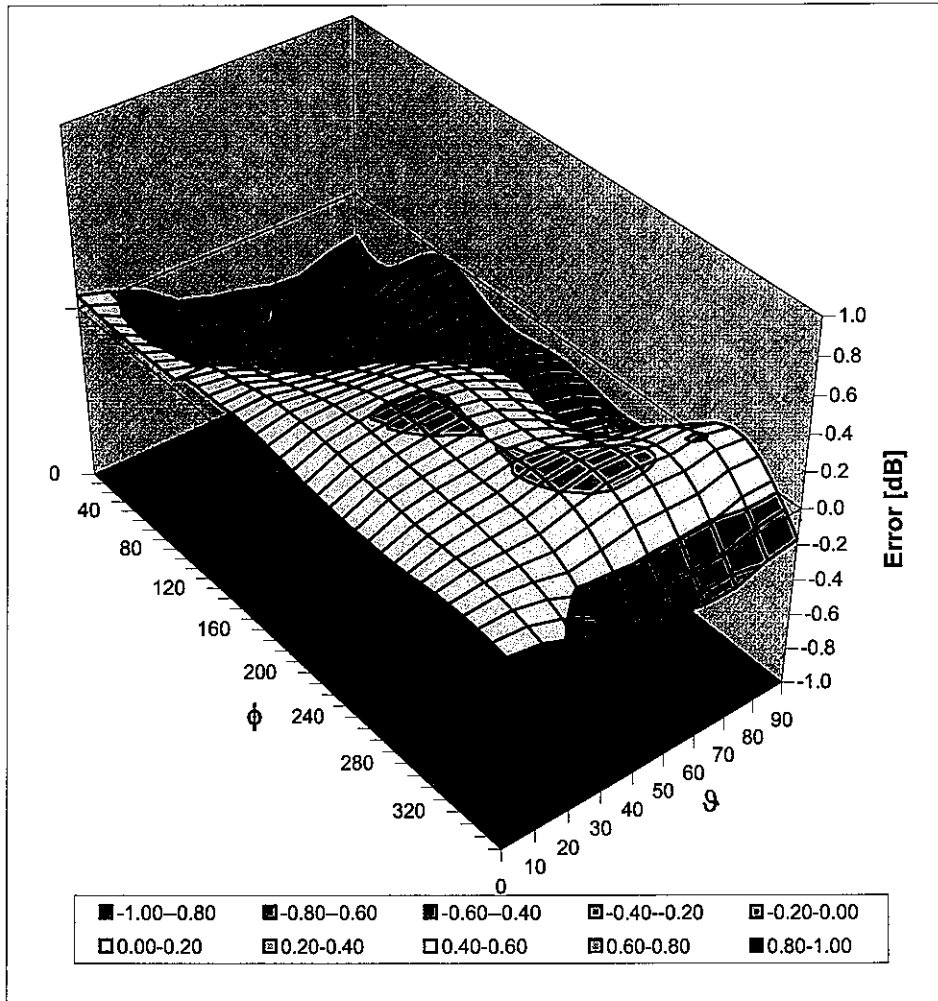

Uncertainty of Spherical Isotropy Assessment:  $\pm 2.6\%$  ( $k=2$ )



Accredited by the Swiss Accreditation Service (SAS)  
The Swiss Accreditation Service is one of the signatories to the EA  
Multilateral Agreement for the recognition of calibration certificates

Accreditation No.: **SCS 108**

Client **Motorola Korea**

Certificate No: **H3-6209\_Jan08**

## CALIBRATION CERTIFICATE

Object: **H3DV6 - SN:6209**

Calibration procedure(s): **QA-CAL-03.v5  
Calibration procedure for H-field probes optimized for close near field  
evaluations in air**

Calibration date: **January 28, 2008**

Condition of the calibrated item: **In Tolerance**

This calibration certificate documents the traceability to national standards, which realize the physical units of measurements (SI).  
The measurements and the uncertainties with confidence probability are given on the following pages and are part of the certificate.

All calibrations have been conducted in the closed laboratory facility: environment temperature (22 ± 3)°C and humidity < 70%.

Calibration Equipment used (M&TE critical for calibration)

Primary Standards	ID #	Cal Date (Calibrated by, Certificate No.)	Scheduled Calibration
Power meter E4419B	GB41293874	29-Mar-07 (METAS, No. 217-00670)	Mar-08
Power sensor E4412A	MY41495277	29-Mar-07 (METAS, No. 217-00670)	Mar-08
Power sensor E4412A	MY41498087	29-Mar-07 (METAS, No. 217-00670)	Mar-08
Reference 3 dB Attenuator	SN: S5054 (3c)	8-Aug-07 (METAS, No. 217-00719)	Aug-08
Reference 20 dB Attenuator	SN: S5086 (20b)	29-Mar-07 (METAS, No. 217-00671)	Mar-08
Reference 30 dB Attenuator	SN: S5129 (30b)	8-Aug-07 (METAS, No. 217-00720)	Aug-08
Reference Probe H3DV6	SN: 6182	2-Oct-07 (SPEAG, No. H3-6182_Oct07)	Oct-08
DAE4	SN: 654	20-Apr-07 (SPEAG, No. DAE4-654_Apr07)	Apr-08
Secondary Standards	ID #	Check Date (in house)	Scheduled Check
RF generator HP 8648C	US3642U01700	4-Aug-99 (SPEAG, in house check Oct-07)	In house check: Oct-09
Network Analyzer HP 8753E	US37390585	18-Oct-01 (SPEAG, in house check Oct-07)	In house check: Oct-08

	Name	Function	Signature
Calibrated by:	Katja Pokovic	Technical Manager	
Approved by:	Niels Kuster	Quality Manager	

Issued: January 28, 2008

This calibration certificate shall not be reproduced except in full without written approval of the laboratory.



Accredited by the Swiss Accreditation Service (SAS)  
The Swiss Accreditation Service is one of the signatories to the EA  
Multilateral Agreement for the recognition of calibration certificates

Accreditation No.: **SCS 108**

**Glossary:**

NORM <sub>x,y,z</sub>	sensitivity in free space
DCP	diode compression point
Polarization $\phi$	$\phi$ rotation around probe axis
Polarization $\vartheta$	$\vartheta$ rotation around an axis that is in the plane normal to probe axis (at measurement center), i.e., $\vartheta = 0$ is normal to probe axis
Connector Angle	information used in DASY system to align probe sensor X to the robot coordinate system

**Calibration is Performed According to the Following Standards:**

- a) IEEE Std 1309-2005, "IEEE Standard for calibration of electromagnetic field sensors and probes, excluding antennas, from 9 kHz to 40 GHz", December 2005.

**Methods Applied and Interpretation of Parameters:**

- $X, Y, Z_{a0a1a2}$ : Assessed for E-field polarization  $\vartheta = 90$  for XY sensors and  $\vartheta = 0$  for Z sensor ( $f \leq 900$  MHz in TEM-cell;  $f > 1800$  MHz: R22 waveguide).
- $X, Y, Z(f)_{a0a1a2} = X, Y, Z_{a0a1a2} * \text{frequency\_response}$  (see Frequency Response Chart).
- $DCP_{x,y,z}$ : DCP are numerical linearization parameters assessed based on the data of power sweep (no uncertainty required). DCP does not depend on frequency.
- *Spherical isotropy (3D deviation from isotropy)*: in a locally homogeneous field realized using an open waveguide setup.
- *Sensor Offset*: The sensor offset corresponds to the offset of virtual measurement center from the probe tip (on probe axis). No tolerance required.
- *Connector Angle*: The angle is assessed using the information gained by determining the  $X_{a0a1a2}$  (no uncertainty required).

# Probe H3DV6

## SN:6209

Manufactured:	June 12, 2006
Last calibrated:	June 14, 2007
Recalibrated:	January 28, 2008

Calibrated for DASY Systems

(Note: non-compatible with DASY2 system!)

**DASY - Parameters of Probe: H3DV6 SN:6209**Sensitivity in Free Space [A/m /  $\sqrt{\mu\text{V}}$ ]

	a0	a1	a2
X	<b>2.277E-03</b>	<b>5.180E-4</b>	<b>1.721E-4 ± 5.1 % (k=2)</b>
Y	<b>2.360E-03</b>	<b>2.945E-4</b>	<b>1.565E-4 ± 5.1 % (k=2)</b>
Z	<b>2.787E-03</b>	<b>2.951E-4</b>	<b>1.811E-4 ± 5.1 % (k=2)</b>

Diode Compression<sup>1</sup>

DCP X	<b>85 mV</b>
DCP Y	<b>85 mV</b>
DCP Z	<b>85 mV</b>

Sensor Offset (Probe Tip to Sensor Center)

X	<b>3.0 mm</b>
Y	<b>3.0 mm</b>
Z	<b>3.0 mm</b>

Connector Angle **-311 °**

**The reported uncertainty of measurement is stated as the standard uncertainty of measurement multiplied by the coverage factor k=2, which for a normal distribution corresponds to a coverage probability of approximately 95%.**

<sup>1</sup> numerical linearization parameter: uncertainty not required

# Frequency Response of H-Field

(TEM-Cell:ifi110, Waveguide R22)

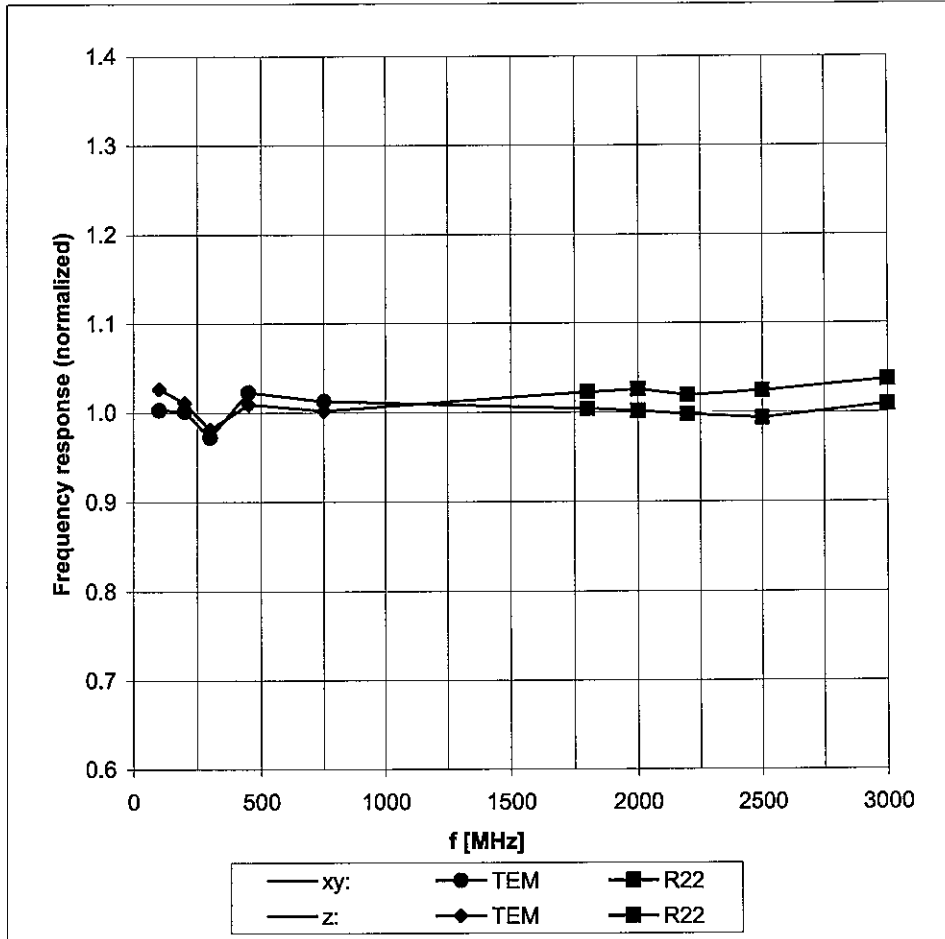

Uncertainty of Frequency Response of E-field:  $\pm 6.3\%$  (k=2)

### Receiving Pattern ( $\phi$ ), $\vartheta = 90^\circ$

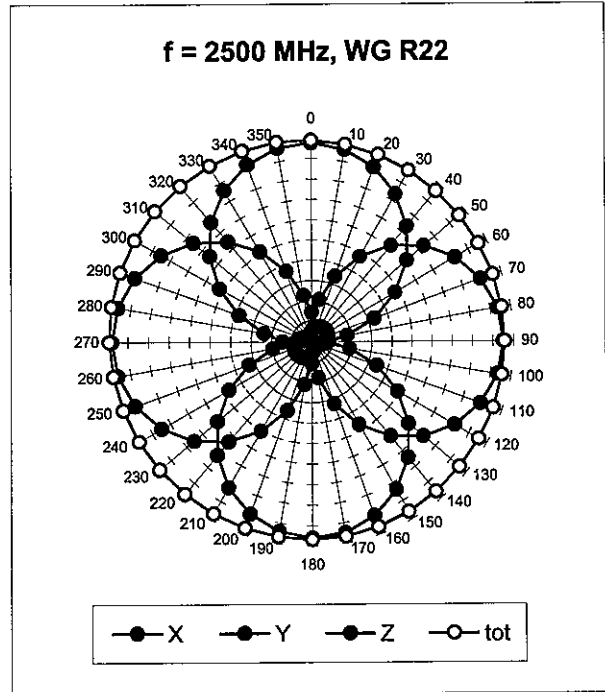
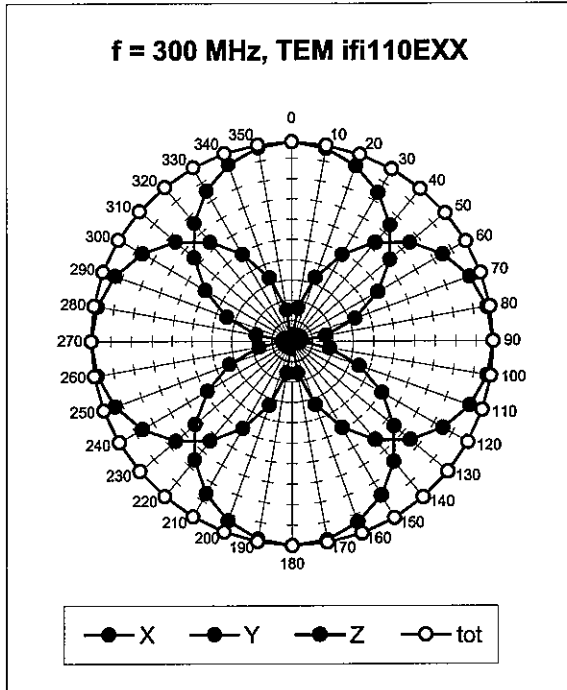

### Receiving Pattern ( $\phi$ ), $\vartheta = 0^\circ$

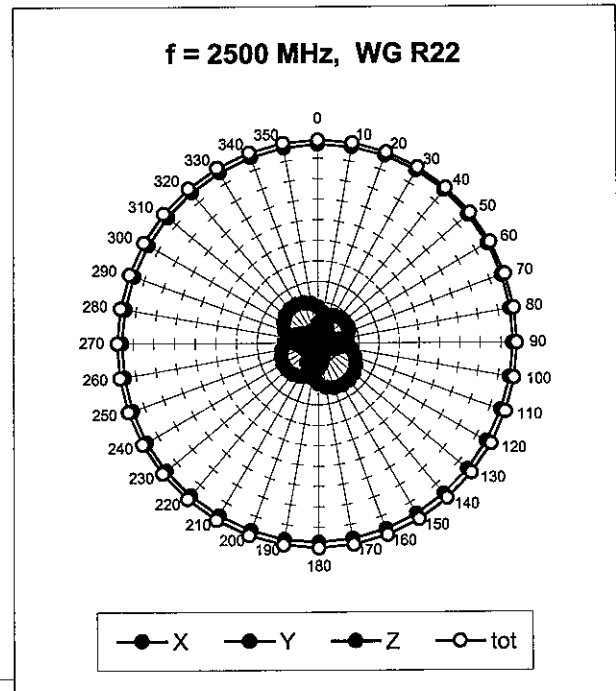
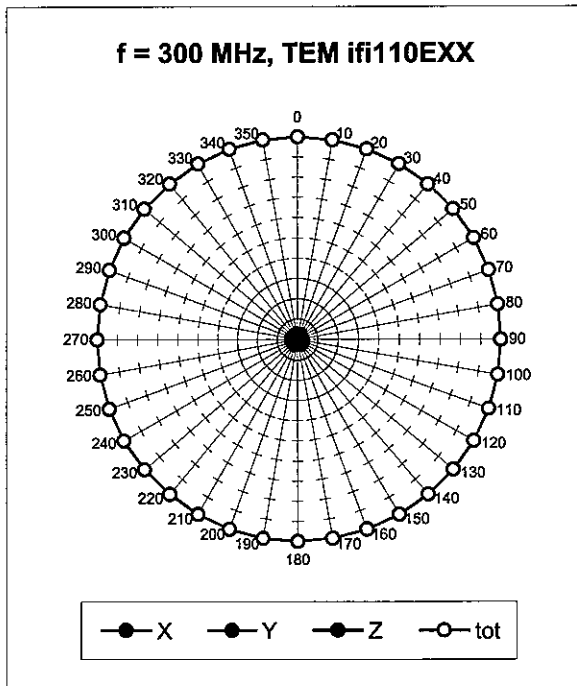

### Receiving Pattern ( $\phi$ ), $\vartheta = 90^\circ$

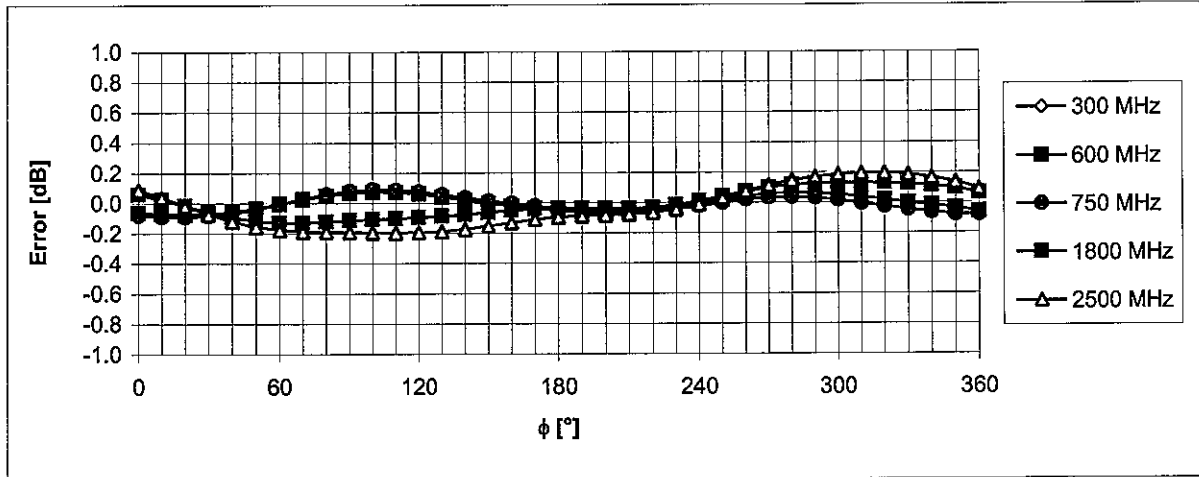

Uncertainty of Axial Isotropy Assessment:  $\pm 0.5\%$  ( $k=2$ )

### Receiving Pattern ( $\phi$ ), $\vartheta = 0^\circ$

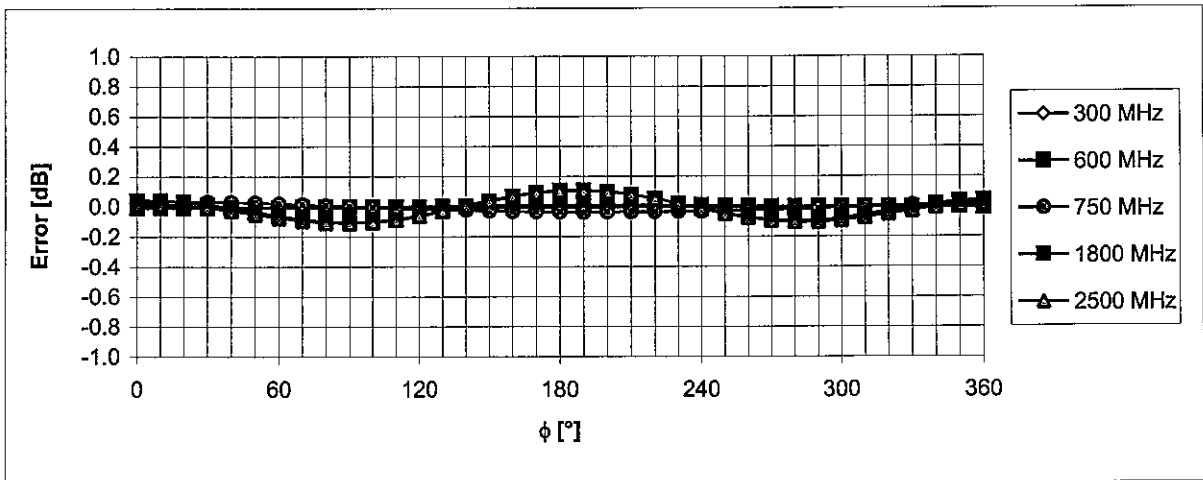

Uncertainty of Axial Isotropy Assessment:  $\pm 0.5\%$  ( $k=2$ )

### Dynamic Range f(H-field) (Waveguide R22, f = 1800 MHz)

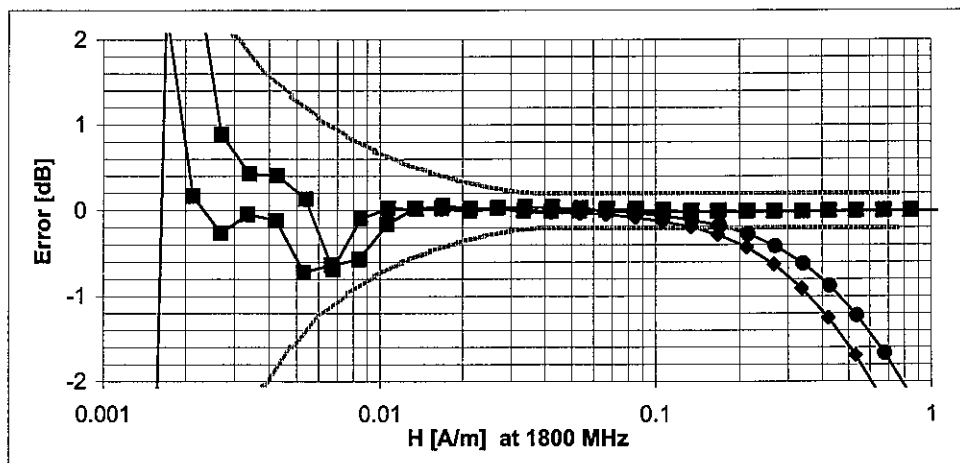
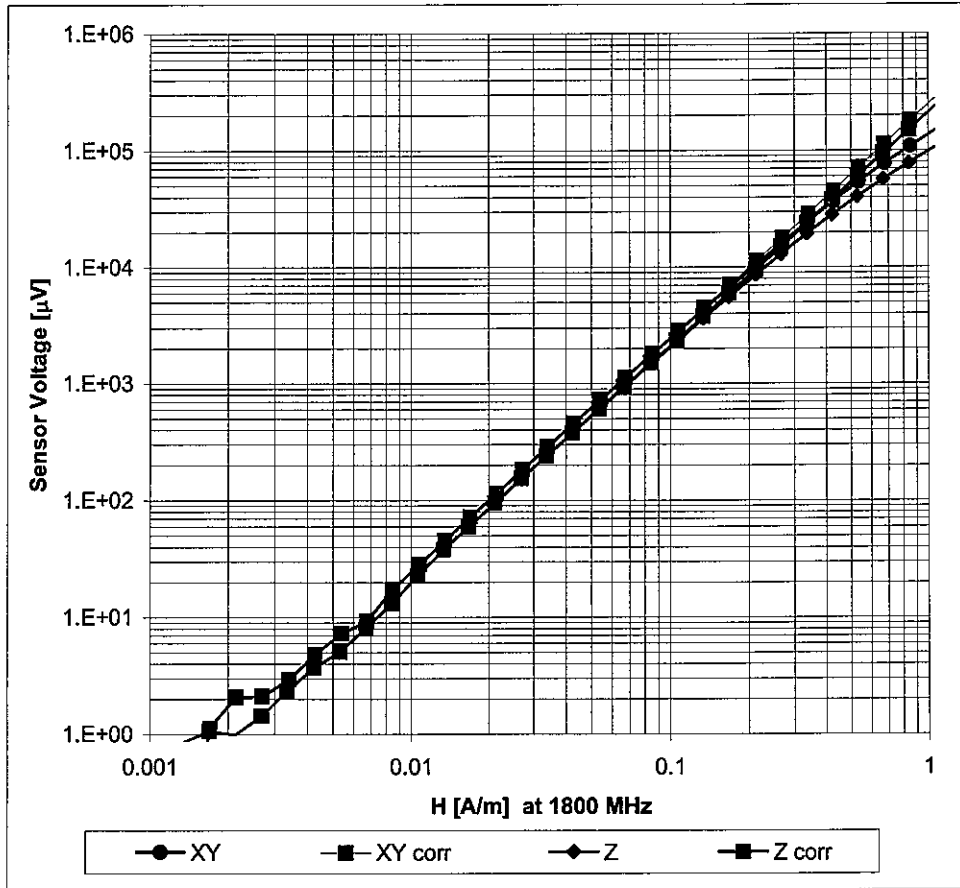

Uncertainty of Linearity Assessment:  $\pm 0.6\%$  (k=2)

**Appendix 7**

**Dipole Characterization Certificate**



Accredited by the Swiss Accreditation Service (SAS)  
The Swiss Accreditation Service is one of the signatories to the EA  
Multilateral Agreement for the recognition of calibration certificates

Accreditation No.: **SCS 108**

Client **Motorola Korea**

Certificate No.: **CD835V3-1103\_Jan08**

## CALIBRATION CERTIFICATE

Object **CD835V3 - SN: 1103**

Calibration procedure(s) **QA CAL-20 v4  
Calibration procedure for dipoles in air**

Calibration date: **January 21, 2008**

Condition of the calibrated item **In Tolerance**

This calibration certificate documents the traceability to national standards, which realize the physical units of measurements (SI).  
All calibrations have been conducted in the closed laboratory facility: environment temperature (22 ± 3)°C and humidity < 70%.

Calibration Equipment used (M&TE critical for calibration)

Primary Standards	ID #	Cal Date (Calibrated by, Certificate No.)	Scheduled Calibration
Power meter EPM-442A	GB37480704	04-Oct-07 (METAS, No. 217-00736)	Oct-08
Power sensor HP 8481A	US37292783	04-Oct-07 (METAS, No. 217-00736)	Oct-08
Probe ER3DV6	SN: 2336	31-Dec-07 (SPEAG, No. ER3-2336_Dec07)	Dec-08
Probe H3DV6	SN: 6065	31-Dec-07 (SPEAG, No. H3-6065_-Dec07)	Dec-08
DAE4	SN: 781	2-Oct-07 (SPEAG, No. DAE4-781_Oct07)	Oct-08
Secondary Standards	ID #	Check Date (in house)	Scheduled Check
Power meter EPM-4419B	GB42420191	11-May-05 (SPEAG, in house check Oct -07)	In house check: Nov-08
Power sensor HP 8482A	US37295597	11-May-05 (SPEAG, in house check Oct -07)	In house check: Nov-08
Power sensor HP 8482H	3318A09450	08-Jan-02 (SPEAG, in house check Oct -07)	In house check: Nov-08
Network Analyzer HP 8753E	US37390585	18-Oct-01 (SPEAG, in house check Oct-07)	In house check: Nov-09
RF generator E4433B	MY 41310391	22-Nov-04 (SPEAG, in house check Oct-07)	In house check: Nov-09

Calibrated by: **Claudio Leubler**      **Laboratory Technician**      Signature

Approved by: **Fin Bomholt**      **Technical Director**

Issued: January 29, 2008

This calibration certificate shall not be reproduced except in full without written approval of the laboratory.



Accredited by the Swiss Accreditation Service (SAS)  
The Swiss Accreditation Service is one of the signatories to the EA  
Multilateral Agreement for the recognition of calibration certificates

Accreditation No.: **SCS 108**

## References

- [1] ANSI-C63.19-2006  
American National Standard for Methods of Measurement of Compatibility between Wireless Communications Devices and Hearing Aids.

## Methods Applied and Interpretation of Parameters:

- **Coordinate System:** y-axis is in the direction of the dipole arms. z-axis is from the basis of the antenna (mounted on the table) towards its feed point between the two dipole arms. x-axis is normal to the other axes. In coincidence with standard [1], the measurement planes (probe sensor center) are selected to be at a distance of 10 mm above the top edge of the dipole arms.
- **Measurement Conditions:** Further details are available from the hardcopies at the end of the certificate. All figures stated in the certificate are valid at the frequency indicated. The forward power to the dipole connector is set with a calibrated power meter connected and monitored with an auxiliary power meter connected to a directional coupler. While the dipole under test is connected, the forward power is adjusted to the same level.
- **Antenna Positioning:** The dipole is mounted on a HAC Test Arch phantom using the matching dipole positioner with the arms horizontal and the feeding cable coming from the floor. The measurements are performed in a shielded room with absorbers around the setup to reduce the reflections. It is verified before the mounting of the dipole under the Test Arch phantom, that its arms are perfectly in a line. It is installed on the HAC dipole positioner with its arms parallel below the dielectric reference wire and able to move elastically in vertical direction without changing its relative position to the top center of the Test Arch phantom. The vertical distance to the probe is adjusted after dipole mounting with a DASY4 Surface Check job. Before the measurement, the distance between phantom surface and probe tip is verified. The proper measurement distance is selected by choosing the matching section of the HAC Test Arch phantom with the proper device reference point (upper surface of the dipole) and the matching grid reference point (tip of the probe) considering the probe sensor offset. The vertical distance to the probe is essential for the accuracy.
- **Feed Point Impedance and Return Loss:** These parameters are measured using a HP 8753E Vector Network Analyzer. The impedance is specified at the SMA connector of the dipole. The influence of reflections was eliminated by applying the averaging function while moving the dipole in the air, at least 70cm away from any obstacles.
- **E-field distribution:** E field is measured in the x-y-plane with an isotropic ER3D-field probe with 100 mW forward power to the antenna feed point. In accordance with [1], the scan area is 20mm wide, its length exceeds the dipole arm length (180 or 90mm). The sensor center is 10 mm (in z) above the top of the dipole arms. Two 3D maxima are available near the end of the dipole arms. Assuming the dipole arms are perfectly in one line, the average of these two maxima (in subgrid 2 and subgrid 8) is determined to compensate for any non-parallelity to the measurement plane as well as the sensor displacement. The E-field value stated as calibration value represents the maximum of the interpolated 3D-E-field, 10mm above the dipole surface.
- **H-field distribution:** H-field is measured with an isotropic H-field probe with 100mW forward power to the antenna feed point, in the x-y-plane. The scan area and sensor distance is equivalent to the E-field scan. The maximum of the field is available at the center (subgrid 5) above the feed point. The H-field value stated as calibration value represents the maximum of the interpolated H-field, 10mm above the dipole surface at the feed point.

## 1 Measurement Conditions

DASY system configuration, as far as not given on page 1.

<b>DASY Version</b>	DASY4	V4.7 B55
<b>DASY PP Version</b>	SEMCAD	V1.8 B176
<b>Phantom</b>	HAC Test Arch	SD HAC P01 BA, #1070
<b>Distance Dipole Top - Probe Center</b>	10 mm	
<b>Scan resolution</b>	dx, dy = 5 mm	area = 20 x 180 mm
<b>Frequency</b>	<b>835 MHz ± 1 MHz</b>	
<b>Forward power at dipole connector</b>	20.0 dBm = 100mW	
<b>Input power drift</b>	< 0.05 dB	

## 2 Maximum Field values

<b>H-field 10 mm above dipole surface</b>	condition	<b>interpolated maximum</b>
Maximum measured	100 mW forward power	<b>0.443 A/m</b>

Uncertainty for H-field measurement: 8.2% (k=2)

<b>E-field 10 mm above dipole surface</b>	condition	<b>Interpolated maximum</b>
Maximum measured above high end-	100 mW forward power	159.5 V/m
Maximum measured above low end	100 mW forward power	158.5 V/m
Averaged maximum above arm	100 mW forward power	<b>159.0 V/m</b>

Uncertainty for E-field measurement: 12.8% (k=2)

## 3 Appendix

### 3.1 Antenna Parameters

<b>Frequency</b>	<b>Return Loss</b>	<b>Impedance</b>
800 MHz	15.8 dB	( 42.1 – j12.9 ) Ohm
<b>835 MHz</b>	<b>26.0 dB</b>	<b>( 49.3 + j4.9 ) Ohm</b>
900 MHz	17.3 dB	( 54.6 – j13.7 ) Ohm
950 MHz	19.1 dB	( 45.3 + j9.6 ) Ohm
960 MHz	15.2 dB	( 53.7 + j17.9 ) Ohm

### 3.2 Antenna Design and Handling

The calibration dipole has a symmetric geometry with a built-in two stub matching network, which leads to the enhanced bandwidth.

The dipole is built of standard semirigid coaxial cable. The internal matching line is open ended. The antenna is therefore open for DC signals.

Do not apply force to dipole arms, as they are liable to bend. The soldered connections near the feedpoint may be damaged. After excessive mechanical stress or overheating, check the impedance characteristics to ensure that the internal matching network is not affected.

After long term use with 40W radiated power, only a slight warming of the dipole near the feedpoint can be measured.

### 3.3 Measurement Sheets

#### 3.3.1 Return Loss and Smith Chart

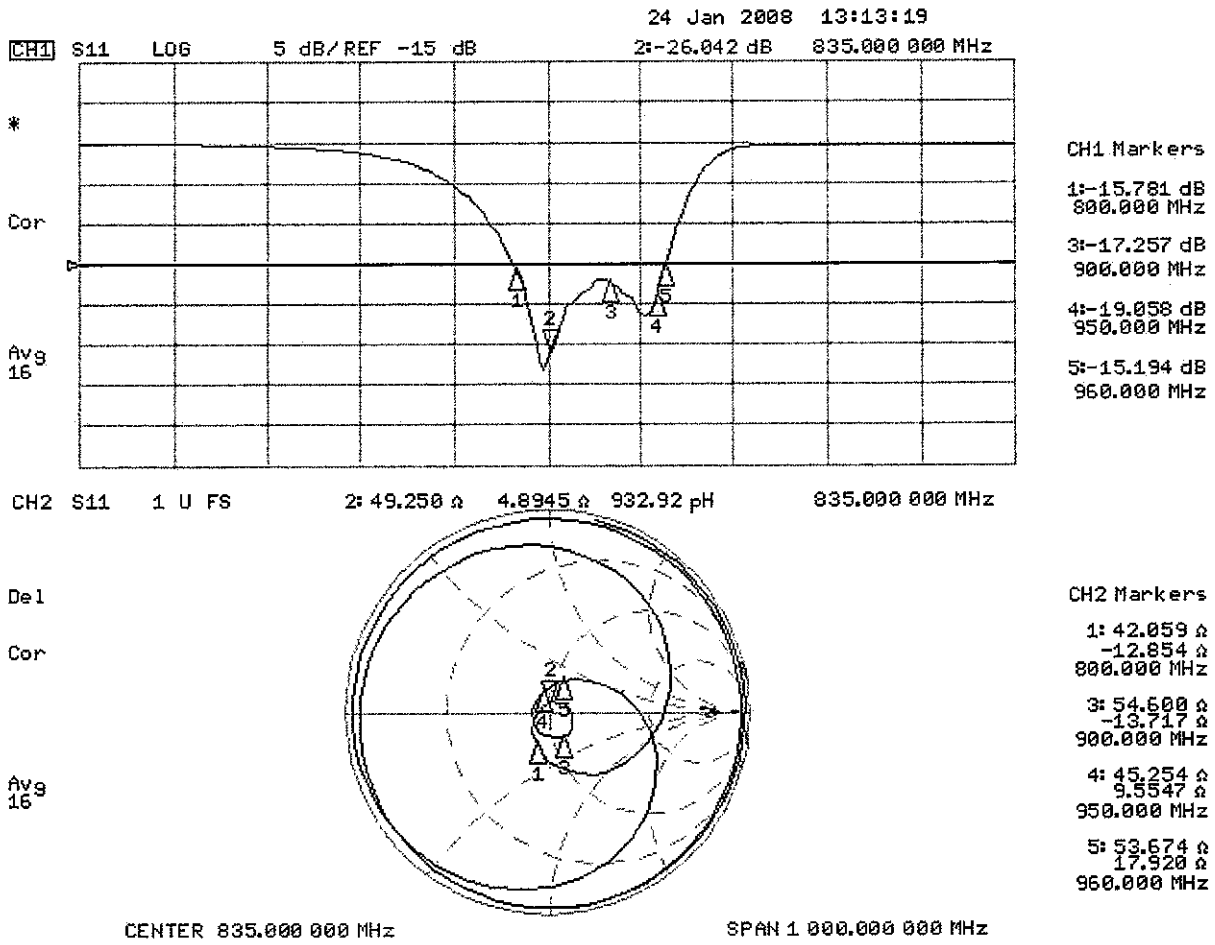

**3.3.2 DASY4 H-field result**

Date/Time: 21.01.2008 12:40:51

Test Laboratory: SPEAG Lab 2

**H\_CD835\_1103\_080121**

**DUT: HAC-Dipole 835 MHz; Type: CD835V3; Serial: 1103**

Communication System: CW; Frequency: 835 MHz; Duty Cycle: 1:1

Medium parameters used:  $\sigma = 0$  mho/m,  $\epsilon_r = 1$ ;  $\rho = 1$  kg/m<sup>3</sup>

Phantom section: H Dipole Section

Measurement Standard: DASY4 (High Precision Assessment)

DASY4 Configuration:

- Probe: H3DV6 - SN6065; ; Calibrated: 31.12.2007
- Sensor-Surface: (Fix Surface)
- Electronics: DAE4 Sn781; Calibrated: 02.10.2007
- Phantom: HAC Test Arch with Coil; Type: SD HAC P01 BA; Serial: 1070
- Measurement SW: DASY4, V4.7 Build 44; Postprocessing SW: SEMCAD, V1.8 Build 174

**H Scan - Sensor Center 10mm above CD835 Dipole/Hearing Aid Compatibility Test (41x361x1):**

Measurement grid: dx=5mm, dy=5mm

Maximum value of peak Total field = 0.443 A/m

Probe Modulation Factor = 1.00

Reference Value = 0.471 A/m; Power Drift = 0.017 dB

**Hearing Aid Near-Field Category: M4 (AWF 0 dB)**

Peak H-field in A/m

Grid 1 <b>0.377 M4</b>	Grid 2 <b>0.387 M4</b>	Grid 3 <b>0.354 M4</b>
Grid 4 <b>0.426 M4</b>	Grid 5 <b>0.443 M4</b>	Grid 6 <b>0.411 M4</b>
Grid 7 <b>0.381 M4</b>	Grid 8 <b>0.398 M4</b>	Grid 9 <b>0.369 M4</b>

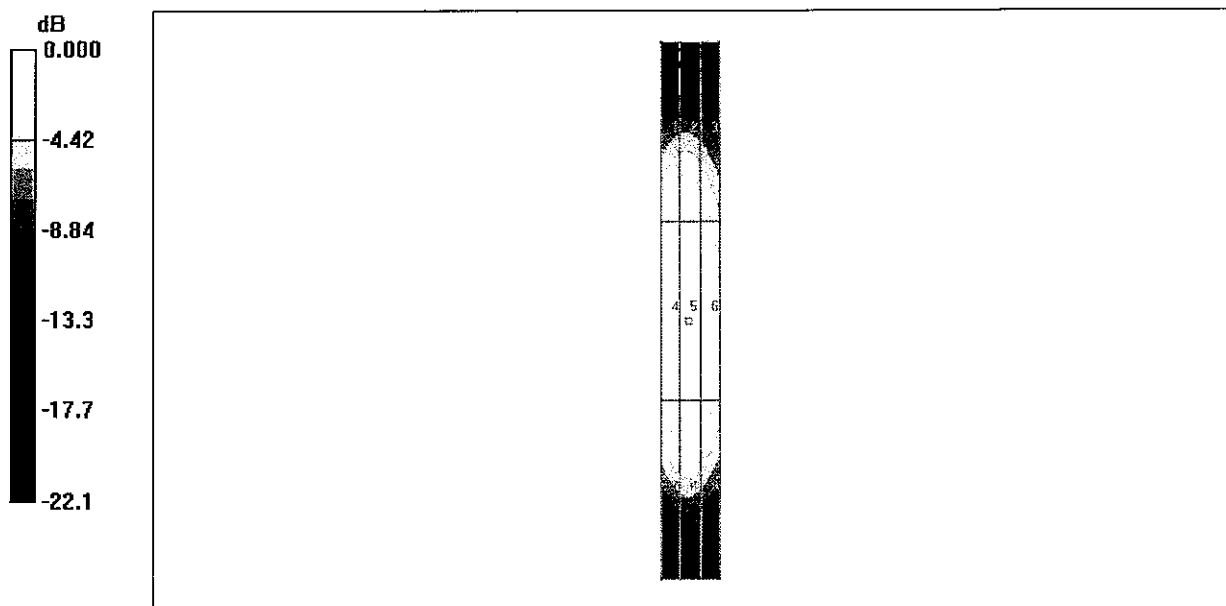

**3.3.3 DASY4 E-Field result**

Date/Time: 21.01.2008 15:42:00

Test Laboratory: SPEAG Lab 2

**E\_CD835\_1103\_080121**

**DUT: HAC-Dipole 835 MHz; Type: D835V3; Serial: 1103**

Communication System: CW; Frequency: 835 MHz; Duty Cycle: 1:1

Medium parameters used:  $\sigma = 0$  mho/m,  $\epsilon_r = 1$ ;  $\rho = 1000$  kg/m<sup>3</sup>

Phantom section: E Dipole Section

Measurement Standard: DASY4 (High Precision Assessment)

DASY4 Configuration:

- Probe: ER3DV6 - SN2336; ConvF(1, 1, 1); Calibrated: 31.12.2007
- Sensor-Surface: (Fix Surface)
- Electronics: DAE4 Sn781; Calibrated: 02.10.2007
- Phantom: HAC Test Arch with Coil; Type: SD HAC P01 BA; Serial: 1070
- Measurement SW: DASY4, V4.7 Build 44; Postprocessing SW: SEMCAD, V1.8 Build 174

**E Scan - Sensor Center 10mm above CD835 Dipole/Hearing Aid Compatibility Test (41x361x1):**

Measurement grid: dx=5mm, dy=5mm

Maximum value of peak Total field = 159.5 V/m

Probe Modulation Factor = 1.00

Reference Value = 103.8 V/m; Power Drift = -0.011 dB

**Hearing Aid Near-Field Category: M4 (AWF 0 dB)**

Peak E-field in V/m

Grid 1 <b>154.8 M4</b>	Grid 2 <b>159.5 M4</b>	Grid 3 <b>155.7 M4</b>
Grid 4 <b>84.0 M4</b>	Grid 5 <b>85.8 M4</b>	Grid 6 <b>82.8 M4</b>
Grid 7 <b>155.5 M4</b>	Grid 8 <b>158.5 M4</b>	Grid 9 <b>149.9 M4</b>

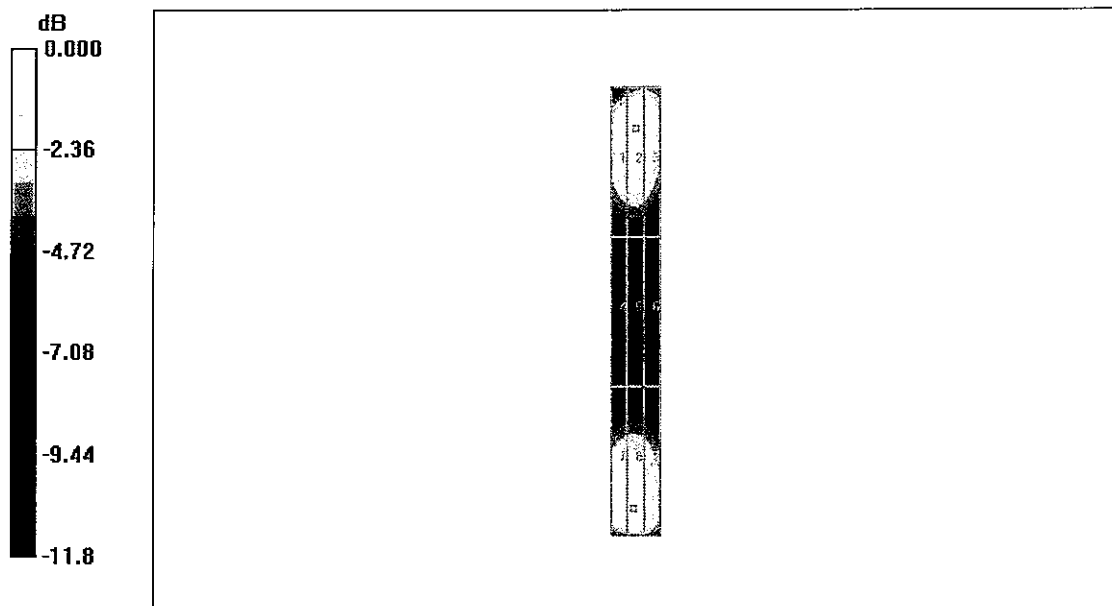

0 dB = 159.5V/m

#### 4. Additional Measurements

##### 4.1 Measurement Conditions

DASY system configuration, as far as not given on page 1.

<b>DASY Version</b>	DASY4	V4.7 B55
<b>DASY PP Version</b>	SEMCAD	V1.8 B176
<b>Phantom</b>	HAC Test Arch	SD HAC P01 BA, #1070
<b>Distance Dipole Top - Probe Center</b>	10 mm	
<b>Scan resolution</b>	dx, dy = 5 mm	area = 20 x 180 mm
<b>Frequency</b>	<b>813 MHz ± 1 MHz</b>	
<b>Forward power at dipole connector</b>	20.0 dBm = 100mW	
<b>Input power drift</b>	< 0.05 dB	

##### 4.1.1 Maximum Field values

<b>H-field 10 mm above dipole surface</b>	condition	<b>interpolated maximum</b>
Maximum measured	100 mW forward power	<b>0.454 A/m</b>

Uncertainty for H-field measurement: 8.2% (k=2)

<b>E-field 10 mm above dipole surface</b>	condition	<b>Interpolated maximum</b>
Maximum measured above high end	100 mW forward power	165.3 V/m
Maximum measured above low end	100 mW forward power	162.6 V/m
Averaged maximum above arm	100 mW forward power	<b>164.0 V/m</b>

Uncertainty for E-field measurement: 12.8% (k=2)

**4.1.2 DASY4 H-field result**

Date/Time: 21.01.2008 12:56:12

Test Laboratory: SPEAG Lab 2

**H\_CD835\_1103\_080121**

**DUT: HAC-Dipole 813 MHz; Type: CD835V3; Serial: 1103**

Communication System: CW; Frequency: 813 MHz; Duty Cycle: 1:1

Medium parameters used:  $\sigma = 0$  mho/m,  $\epsilon_r = 1$ ;  $\rho = 1$  kg/m<sup>3</sup>

Phantom section: H Dipole Section

Measurement Standard: DASY4 (High Precision Assessment)

DASY4 Configuration:

- Probe: H3DV6 - SN6065; ; Calibrated: 31.12.2007
- Sensor-Surface: (Fix Surface)
- Electronics: DAE4 Sn781; Calibrated: 02.10.2007
- Phantom: HAC Test Arch with Coil; Type: SD HAC P01 BA; Serial: 1070
- Measurement SW: DASY4, V4.7 Build 44; Postprocessing SW: SEMCAD, V1.8 Build 174

**H Scan - Sensor Center 10mm above CD835 Dipole @ 813MHz/Hearing Aid Compatibility Test (41x361x1):**

Measurement grid: dx=5mm, dy=5mm

Maximum value of peak Total field = 0.454 A/m

Probe Modulation Factor = 1.00

Reference Value = 0.482 A/m; Power Drift = 0.010 dB

**Hearing Aid Near-Field Category: M4 (AWF 0 dB)**

Peak H-field in A/m

Grid 1 <b>0.387 M4</b>	Grid 2 <b>0.397 M4</b>	Grid 3 <b>0.362 M4</b>
Grid 4 <b>0.436 M4</b>	Grid 5 <b>0.454 M4</b>	Grid 6 <b>0.421 M4</b>
Grid 7 <b>0.388 M4</b>	Grid 8 <b>0.405 M4</b>	Grid 9 <b>0.375 M4</b>

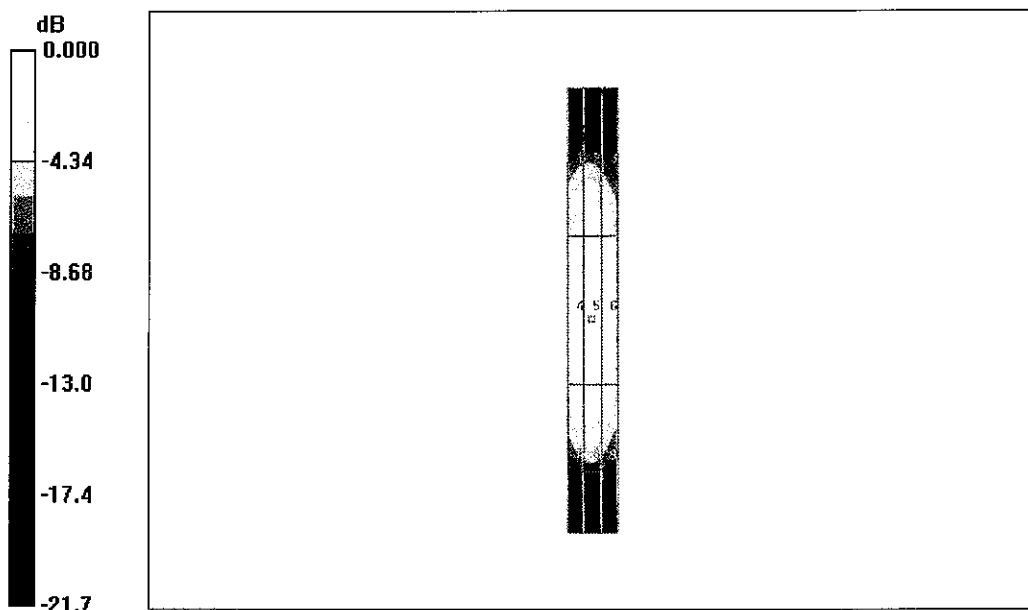

0 dB = 0.454A/m

**4.1.3 DASY4 E-field result**

Date/Time: 21.01.2008 16:01:27

Test Laboratory: SPEAG Lab 2

**E\_CD835\_1103\_080121**

**DUT: HAC-Dipole 813 MHz; Type: D835V3; Serial: 1103**

Communication System: CW; Frequency: 813 MHz; Duty Cycle: 1:1

Medium parameters used:  $\sigma = 0$  mho/m,  $\epsilon_r = 1$ ;  $\rho = 1000$  kg/m<sup>3</sup>

Phantom section: E Dipole Section

Measurement Standard: DASY4 (High Precision Assessment)

DASY4 Configuration:

- Probe: ER3DV6 - SN2336; ConvF(1, 1, 1); Calibrated: 31.12.2007
- Sensor-Surface: (Fix Surface)
- Electronics: DAE4 Sn781; Calibrated: 02.10.2007
- Phantom: HAC Test Arch with Coil; Type: SD HAC P01 BA; Serial: 1070
- Measurement SW: DASY4, V4.7 Build 44; Postprocessing SW: SEMCAD, V1.8 Build 174

**E Scan - Sensor Center 10mm above CD835 Dipole @ 813MHz/Hearing Aid Compatibility Test (41x361x1):**

Measurement grid: dx=5mm, dy=5mm

Maximum value of peak Total field = 165.3 V/m

Probe Modulation Factor = 1.00

Reference Value = 106.8 V/m; Power Drift = -0.021 dB

**Hearing Aid Near-Field Category: M4 (AWF 0 dB)**

Peak E-field in V/m

Grid 1 <b>160.1 M4</b>	Grid 2 <b>165.3 M4</b>	Grid 3 <b>161.3 M4</b>
Grid 4 <b>86.1 M4</b>	Grid 5 <b>88.2 M4</b>	Grid 6 <b>85.4 M4</b>
Grid 7 <b>159.4 M4</b>	Grid 8 <b>162.6 M4</b>	Grid 9 <b>154.1 M4</b>

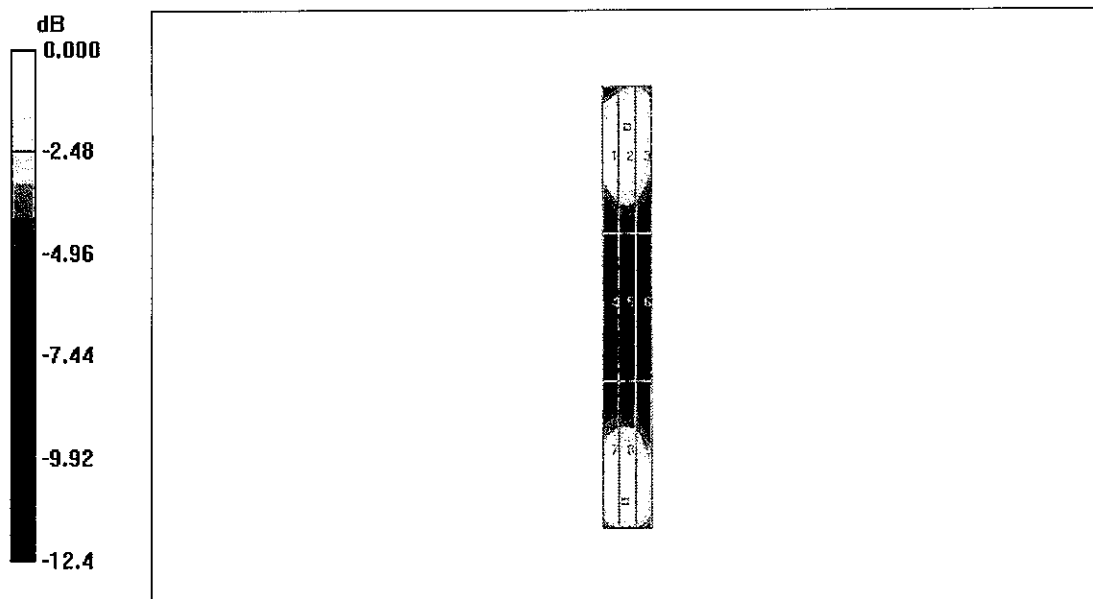

0 dB = 165.3V/m

## 4.2 Measurement Conditions

DASY system configuration, as far as not given on page 1.

<b>DASY Version</b>	DASY4	V4.7 B55
<b>DASY PP Version</b>	SEMCAD	V1.8 B176
<b>Phantom</b>	HAC Test Arch	SD HAC P01 BA, #1070
<b>Distance Dipole Top - Probe Center</b>	10 mm	
<b>Scan resolution</b>	dx, dy = 5 mm	area = 20 x 180 mm
<b>Frequency</b>	<b>898 MHz ± 1 MHz</b>	
<b>Forward power at dipole connector</b>	20.0 dBm = 100mW	
<b>Input power drift</b>	< 0.05 dB	

### 4.2.1 Maximum Field values

<b>H-field 10 mm above dipole surface</b>	condition	<b>Interpolated maximum</b>
Maximum measured	100 mW forward power	<b>0.440 A/m</b>

Uncertainty for H-field measurement: 8.2% (k=2)

<b>E-field 10 mm above dipole surface</b>	condition	<b>Interpolated maximum</b>
Maximum measured above high end	100 mW forward power	158.1 V/m
Maximum measured above low end	100 mW forward power	158.0 V/m
Averaged maximum above arm	100 mW forward power	<b>158.1 V/m</b>

Uncertainty for E-field measurement: 12.8% (k=2)

**4.2.2 DASY4 H-field result**

Date/Time: 21.01.2008 13:07:11

Test Laboratory: SPEAG Lab 2

**H\_CD835\_1103\_080121**

**DUT: HAC-Dipole 898 MHz; Type: CD835V3; Serial: 1103**

Communication System: CW; Frequency: 898 MHz; Duty Cycle: 1:1

Medium parameters used:  $\sigma = 0$  mho/m,  $\epsilon_r = 1$ ;  $\rho = 1$  kg/m<sup>3</sup>

Phantom section: H Dipole Section

Measurement Standard: DASY4 (High Precision Assessment)

DASY4 Configuration:

- Probe: H3DV6 - SN6065; ; Calibrated: 31.12.2007
- Sensor-Surface: (Fix Surface)
- Electronics: DAE4 Sn781; Calibrated: 02.10.2007
- Phantom: HAC Test Arch with Coil; Type: SD HAC P01 BA; Serial: 1070
- Measurement SW: DASY4, V4.7 Build 44; Postprocessing SW: SEMCAD, V1.8 Build 174

**H Scan - Sensor Center 10mm above CD835 Dipole @ 898MHz/Hearing Aid Compatibility Test (41x361x1):**

Measurement grid: dx=5mm, dy=5mm

Maximum value of peak Total field = 0.440 A/m

Probe Modulation Factor = 1.00

Reference Value = 0.459 A/m; Power Drift = -0.019 dB

**Hearing Aid Near-Field Category: M4 (AWF 0 dB)**

Peak H-field in A/m

Grid 1 <b>0.396 M4</b>	Grid 2 <b>0.405 M4</b>	Grid 3 <b>0.367 M4</b>
Grid 4 <b>0.424 M4</b>	Grid 5 <b>0.440 M4</b>	Grid 6 <b>0.405 M4</b>
Grid 7 <b>0.398 M4</b>	Grid 8 <b>0.415 M4</b>	Grid 9 <b>0.381 M4</b>

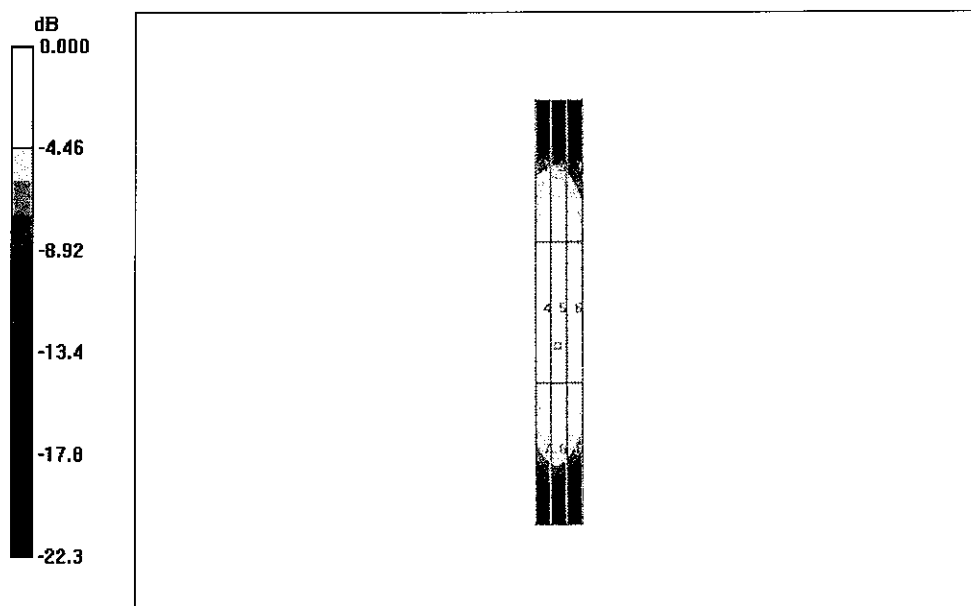

0 dB = 0.440A/m

**4.2.3 DASY4 E-field result**

Date/Time: 21.01.2008 16:11:50

Test Laboratory: SPEAG Lab 2

**E\_CD835\_1103\_080121**

**DUT: HAC-Dipole 898 MHz; Type: D835V3; Serial: 1103**

Communication System: CW; Frequency: 898 MHz; Duty Cycle: 1:1

Medium parameters used:  $\sigma = 0$  mho/m,  $\epsilon_r = 1$ ;  $\rho = 1000$  kg/m<sup>3</sup>

Phantom section: E Dipole Section

Measurement Standard: DASY4 (High Precision Assessment)

DASY4 Configuration:

- Probe: ER3DV6 - SN2336; ConvF(1, 1, 1); Calibrated: 31.12.2007
- Sensor-Surface: (Fix Surface)
- Electronics: DAE4 Sn781; Calibrated: 02.10.2007
- Phantom: HAC Test Arch with Coil; Type: SD HAC P01 BA; Serial: 1070
- Measurement SW: DASY4, V4.7 Build 44; Postprocessing SW: SEMCAD, V1.8 Build 174

**E Scan - Sensor Center 10mm above CD835 Dipole @ 898MHz/Hearing Aid Compatibility Test (41x361x1):**

Measurement grid: dx=5mm, dy=5mm

Maximum value of peak Total field = 158.1 V/m

Probe Modulation Factor = 1.00

Reference Value = 94.7 V/m; Power Drift = 0.008 dB

**Hearing Aid Near-Field Category: M4 (AWF 0 dB)**

Peak E-field in V/m

Grid 1 <b>153.9 M4</b>	Grid 2 <b>158.1 M4</b>	Grid 3 <b>154.3 M4</b>
Grid 4 <b>75.1 M4</b>	Grid 5 <b>76.7 M4</b>	Grid 6 <b>74.1 M4</b>
Grid 7 <b>155.2 M4</b>	Grid 8 <b>158.0 M4</b>	Grid 9 <b>149.1 M4</b>

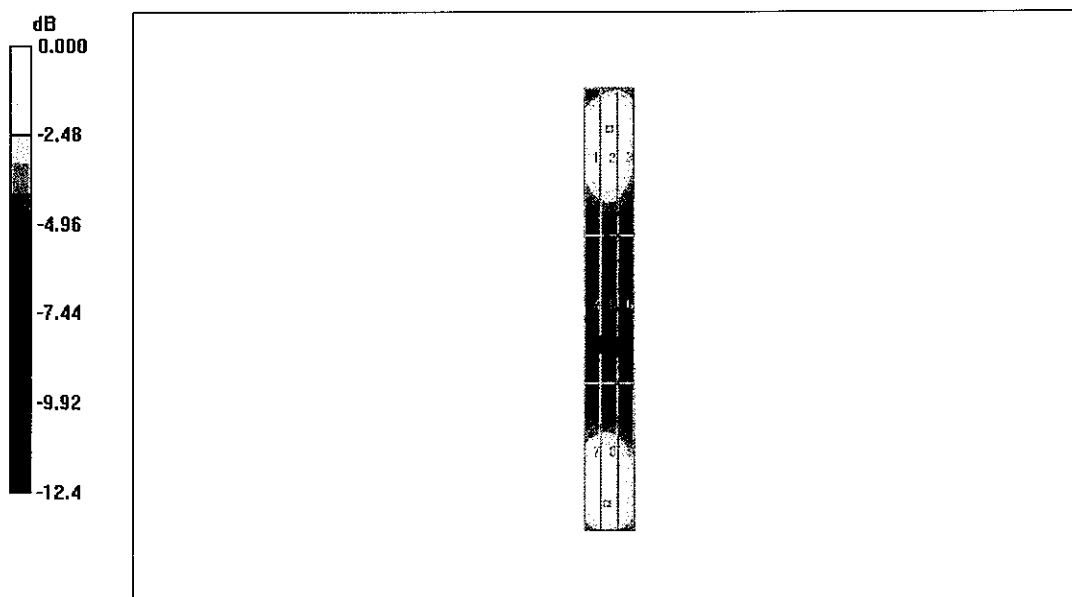

0 dB = 158.1V/m



Accredited by the Swiss Accreditation Service (SAS)  
The Swiss Accreditation Service is one of the signatories to the EA  
Multilateral Agreement for the recognition of calibration certificates

Accreditation No.: **SCS 108**

Client **Motorola Korea**

Certificate No. **CD1880V3-1071\_Jan08**

## CALIBRATION CERTIFICATE

Object **CD1880V3 - SN: 1071**

Calibration procedure(s) **QA CAL-20.v4  
Calibration procedure for dipoles in air**

Calibration date: **January 22, 2008**

Condition of the calibrated item **In Tolerance**

This calibration certificate documents the traceability to national standards, which realize the physical units of measurements (SI).  
All calibrations have been conducted in the closed laboratory facility: environment temperature ( $22 \pm 3$ )°C and humidity < 70%.

Calibration Equipment used (M&TE critical for calibration)

Primary Standards	ID #	Cal Date (Calibrated by, Certificate No.)	Scheduled Calibration
Power meter EPM-442A	GB37480704	04-Oct-07 (METAS, No. 217-00736)	Oct-08
Power sensor HP 8481A	US37292783	04-Oct-07 (METAS, No. 217-00736)	Oct-08
Probe ER3DV6	SN: 2336	31-Dec-07 (SPEAG, No. ER3-2336_Dec07)	Dec-08
Probe H3DV6	SN: 6065	31-Dec-07 (SPEAG, No. H3-6065_-Dec07)	Dec-08
DAE4	SN: 781	2-Oct-07 (SPEAG, No. DAE4-781_Oct07)	Oct-08

Secondary Standards	ID #	Check Date (in house)	Scheduled Check
Power meter EPM-4419B	GB42420191	11-May-05 (SPEAG, in house check Oct-07)	In house check: Nov-08
Power sensor HP 8482A	US37295597	11-May-05 (SPEAG, in house check Oct-07)	In house check: Nov-08
Power sensor HP 8482H	3318A09450	08-Jan-02 (SPEAG, in house check Oct-07)	In house check: Nov-08
Network Analyzer HP 8753E	US37390585	18-Oct-01 (SPEAG, in house check Oct-07)	In house check: Nov-09
RF generator E4433B	MY 41310391	22-Nov-04 (SPEAG, in house check Oct-07)	In house check: Nov-09

Calibrated by: **Claudio Leubler**      **Laboratory Technician**      *[Signature]*

Approved by: **Fin Bommholt**      **Technical Director**      *[Signature]*

Issued: January 29, 2008

This calibration certificate shall not be reproduced except in full without written approval of the laboratory.



Accredited by the Swiss Accreditation Service (SAS)  
The Swiss Accreditation Service is one of the signatories to the EA  
Multilateral Agreement for the recognition of calibration certificates

## References

- [1] ANSI-C63.19-2006  
American National Standard for Methods of Measurement of Compatibility between Wireless Communications Devices and Hearing Aids.

## Methods Applied and Interpretation of Parameters:

- **Coordinate System:** y-axis is in the direction of the dipole arms. z-axis is from the basis of the antenna (mounted on the table) towards its feed point between the two dipole arms. x-axis is normal to the other axes. In coincidence with standard [1], the measurement planes (probe sensor center) are selected to be at a distance of 10 mm above the top edge of the dipole arms.
- **Measurement Conditions:** Further details are available from the hardcopies at the end of the certificate. All figures stated in the certificate are valid at the frequency indicated. The forward power to the dipole connector is set with a calibrated power meter connected and monitored with an auxiliary power meter connected to a directional coupler. While the dipole under test is connected, the forward power is adjusted to the same level.
- **Antenna Positioning:** The dipole is mounted on a HAC Test Arch phantom using the matching dipole positioner with the arms horizontal and the feeding cable coming from the floor. The measurements are performed in a shielded room with absorbers around the setup to reduce the reflections. It is verified before the mounting of the dipole under the Test Arch phantom, that its arms are perfectly in a line. It is installed on the HAC dipole positioner with its arms parallel below the dielectric reference wire and able to move elastically in vertical direction without changing its relative position to the top center of the Test Arch phantom. The vertical distance to the probe is adjusted after dipole mounting with a DASY4 Surface Check job. Before the measurement, the distance between phantom surface and probe tip is verified. The proper measurement distance is selected by choosing the matching section of the HAC Test Arch phantom with the proper device reference point (upper surface of the dipole) and the matching grid reference point (tip of the probe) considering the probe sensor offset. The vertical distance to the probe is essential for the accuracy.
- **Feed Point Impedance and Return Loss:** These parameters are measured using a HP 8753E Vector Network Analyzer. The impedance is specified at the SMA connector of the dipole. The influence of reflections was eliminated by applying the averaging function while moving the dipole in the air, at least 70cm away from any obstacles.
- **E-field distribution:** E field is measured in the x-y-plane with an isotropic ER3D-field probe with 100 mW forward power to the antenna feed point. In accordance with [1], the scan area is 20mm wide, its length exceeds the dipole arm length (180 or 90mm). The sensor center is 10 mm (in z) above the top of the dipole arms. Two 3D maxima are available near the end of the dipole arms. Assuming the dipole arms are perfectly in one line, the average of these two maxima (in subgrid 2 and subgrid 8) is determined to compensate for any non-parallelity to the measurement plane as well as the sensor displacement. The E-field value stated as calibration value represents the maximum of the interpolated 3D-E-field, 10mm above the dipole surface.
- **H-field distribution:** H-field is measured with an isotropic H-field probe with 100mW forward power to the antenna feed point, in the x-y-plane. The scan area and sensor distance is equivalent to the E-field scan. The maximum of the field is available at the center (subgrid 5) above the feed point. The H-field value stated as calibration value represents the maximum of the interpolated H-field, 10mm above the dipole surface at the feed point.

## 1 Measurement Conditions

DASY system configuration, as far as not given on page 1.

<b>DASY Version</b>	DASY4	V4.7 B55
<b>DASY PP Version</b>	SEMCAD	V1.8 B176
<b>Phantom</b>	HAC Test Arch	SD HAC P01 BA, #1070
<b>Distance Dipole Top - Probe Center</b>	10 mm	
<b>Scan resolution</b>	dx, dy = 5 mm	area = 20 x 90 mm
<b>Frequency</b>	<b>1880 MHz ± 1 MHz</b>	
<b>Forward power at dipole connector</b>	20.0 dBm = 100mW	
<b>Input power drift</b>	< 0.05 dB	

## 2 Maximum Field values

<b>H-field 10 mm above dipole surface</b>	condition	<b>Interpolated maximum</b>
Maximum measured	100 mW forward power	<b>0.467 A/m</b>

Uncertainty for H-field measurement: 8.2% (k=2)

<b>E-field 10 mm above dipole surface</b>	condition	<b>Interpolated maximum</b>
Maximum measured above high end	100 mW forward power	139.2 V/m
Maximum measured above low end	100 mW forward power	139.1 V/m
Averaged maximum above arm	100 mW forward power	<b>139.2 V/m</b>

Uncertainty for E-field measurement: 12.8% (k=2)

## 3 Appendix

### 3.1 Antenna Parameters

<b>Frequency</b>	<b>Return Loss</b>	<b>Impedance</b>
1710 MHz	19.0 dB	( 49.7 + j11.2 ) Ohm
<b>1880 MHz</b>	<b>22.5 dB</b>	<b>( 51.0 + j7.6 ) Ohm</b>
1900 MHz	21.9 dB	( 53.7 + j7.5 ) Ohm
1950 MHz	32.4 dB	( 52.4 - j0.0 ) Ohm
2000 MHz	20.8 dB	( 42.0 + j2.8 ) Ohm

### 3.2 Antenna Design and Handling

The calibration dipole has a symmetric geometry with a built-in two stub matching network, which leads to the enhanced bandwidth.

The dipole is built of standard semirigid coaxial cable. The internal matching line is open ended. The antenna is therefore open for DC signals.

Do not apply force to dipole arms, as they are liable to bend. The soldered connections near the feedpoint may be damaged. After excessive mechanical stress or overheating, check the impedance characteristics to ensure that the internal matching network is not affected.

After long term use with 40W radiated power, only a slight warming of the dipole near the feedpoint can be measured.

### 3.3 Measurement Sheets

#### 3.3.1 Return Loss and Smith Chart

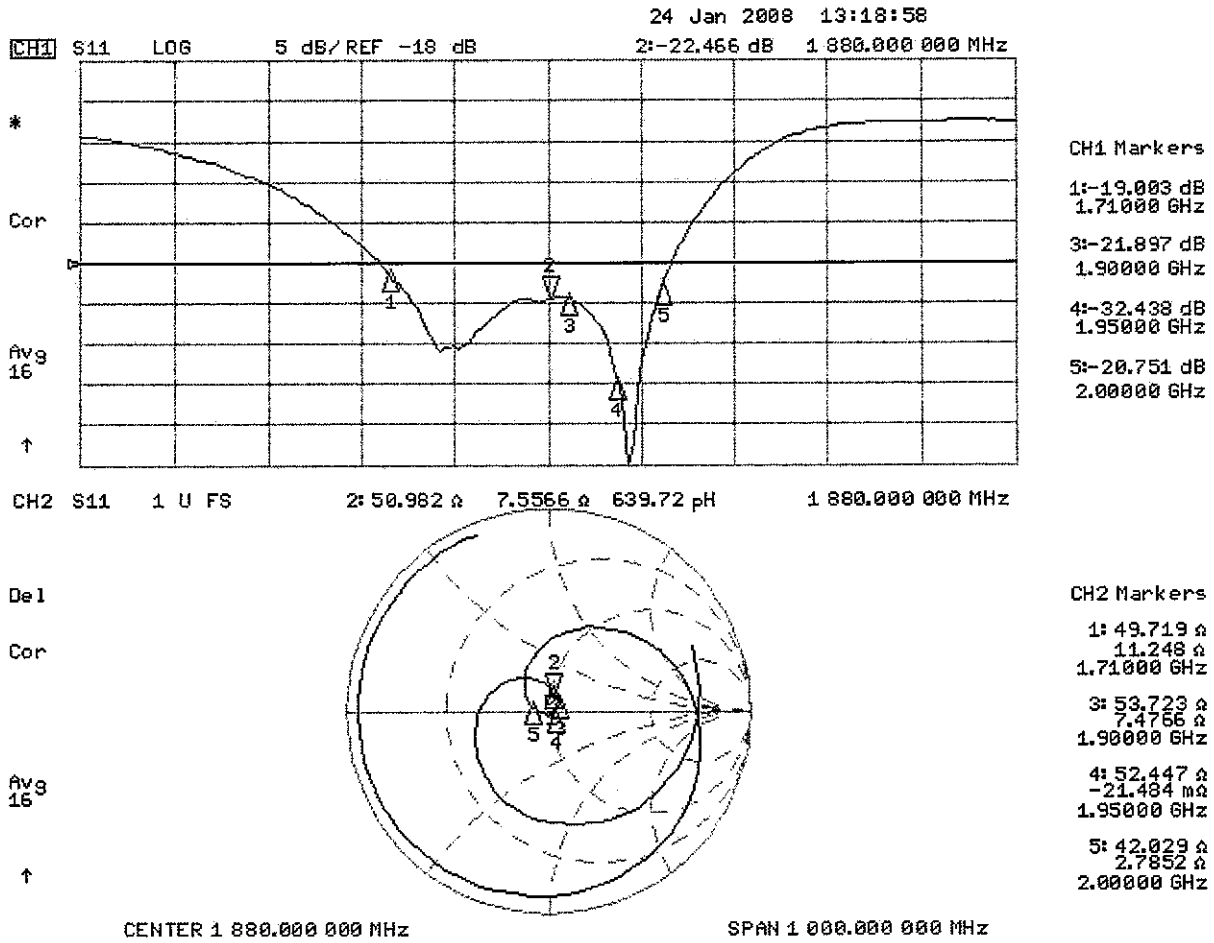

**3.3.2 DASY4 H-Field Result**

Date/Time: 22.01.2008 12:49:07

Test Laboratory: SPEAG Lab 2

**H\_CD1880\_1071\_080122**

**DUT: HAC Dipole 1880 MHz; Type: CD1880V3; Serial: 1071**  
 Communication System: CW; Frequency: 1880 MHz Duty Cycle: 1:1  
 Medium parameters used:  $\sigma = 0$  mho/m,  $\epsilon_r = 1$ ;  $\rho = 1$  kg/m<sup>3</sup>  
 Phantom section: H Dipole Section  
 Measurement Standard: DASY4 (High Precision Assessment)  
 DASY4 Configuration:

- Probe: H3DV6 - SN6065; ; Calibrated: 31.12.2007
- Sensor-Surface: (Fix Surface)
- Electronics: DAE4 Sn781; Calibrated: 02.10.2007
- Phantom: HAC Test Arch with Coil; Type: SD HAC P01 BA; Serial: 1070
- Measurement SW: DASY4, V4.7 Build 44; Postprocessing SW: SEMCAD, V1.8 Build 174

**H Scan - Sensor Center 10mm above CD1880V3 Dipole/Hearing Aid Compatibility Test (41x181x1):**

Measurement grid: dx=5mm, dy=5mm  
 Maximum value of peak Total field = 0.467 A/m  
 Probe Modulation Factor = 1.00  
 Reference Value = 0.493 A/m; Power Drift = 0.015 dB  
**Hearing Aid Near-Field Category: M2 (AWF 0 dB)**

Peak H-field in A/m

Grid 1 <b>0.408 M2</b>	Grid 2 <b>0.421 M2</b>	Grid 3 <b>0.394 M2</b>
Grid 4 <b>0.450 M2</b>	Grid 5 <b>0.467 M2</b>	Grid 6 <b>0.439 M2</b>
Grid 7 <b>0.414 M2</b>	Grid 8 <b>0.434 M2</b>	Grid 9 <b>0.405 M2</b>

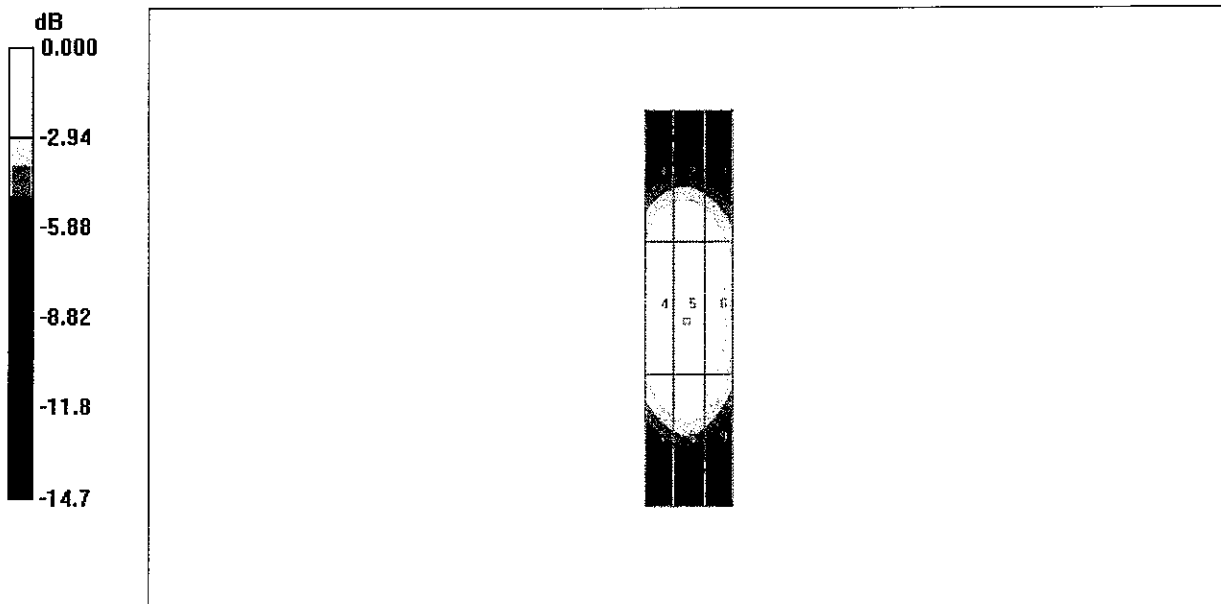

0 dB = 0.467A/m

**3.3.2 DASY4 E-Field Result**

Date/Time: 22.01.2008 13:59:46

Test Laboratory: SPEAG Lab 2

**E\_CD1880\_1071\_080122**

**DUT: HAC Dipole 1880 MHz; Type: CD1880V3; Serial: 1071**

Communication System: CW; Frequency: 1880 MHz; Duty Cycle: 1:1

Medium parameters used:  $\sigma = 0$  mho/m,  $\epsilon_r = 1$ ;  $\rho = 1000$  kg/m<sup>3</sup>

Phantom section: E Dipole Section

Measurement Standard: DASY4 (High Precision Assessment)

DASY4 Configuration:

- Probe: ER3DV6 - SN2336; ConvF(1, 1, 1); Calibrated: 31.12.2007
- Sensor-Surface: (Fix Surface)
- Electronics: DAE4 Sn781; Calibrated: 02.10.2007
- Phantom: HAC Test Arch with Coil; Type: SD HAC P01 BA; Serial: 1070
- Measurement SW: DASY4, V4.7 Build 44; Postprocessing SW: SEMCAD, V1.8 Build 174

**E Scan - Sensor Center 10mm above CD1880V3 Dipole/Hearing Aid Compatibility Test (41x181x1):**

Measurement grid: dx=5mm, dy=5mm

Maximum value of peak Total field = 139.2 V/m

Probe Modulation Factor = 1.00

Reference Value = 157.4 V/m; Power Drift = 0.017 dB

**Hearing Aid Near-Field Category: M2 (AWF 0 dB)**

Peak E-field in V/m

Grid 1 <b>134.6 M2</b>	Grid 2 <b>139.1 M2</b>	Grid 3 <b>135.0 M2</b>
Grid 4 <b>91.4 M3</b>	Grid 5 <b>93.6 M3</b>	Grid 6 <b>89.4 M3</b>
Grid 7 <b>133.5 M2</b>	Grid 8 <b>139.2 M2</b>	Grid 9 <b>133.4 M2</b>

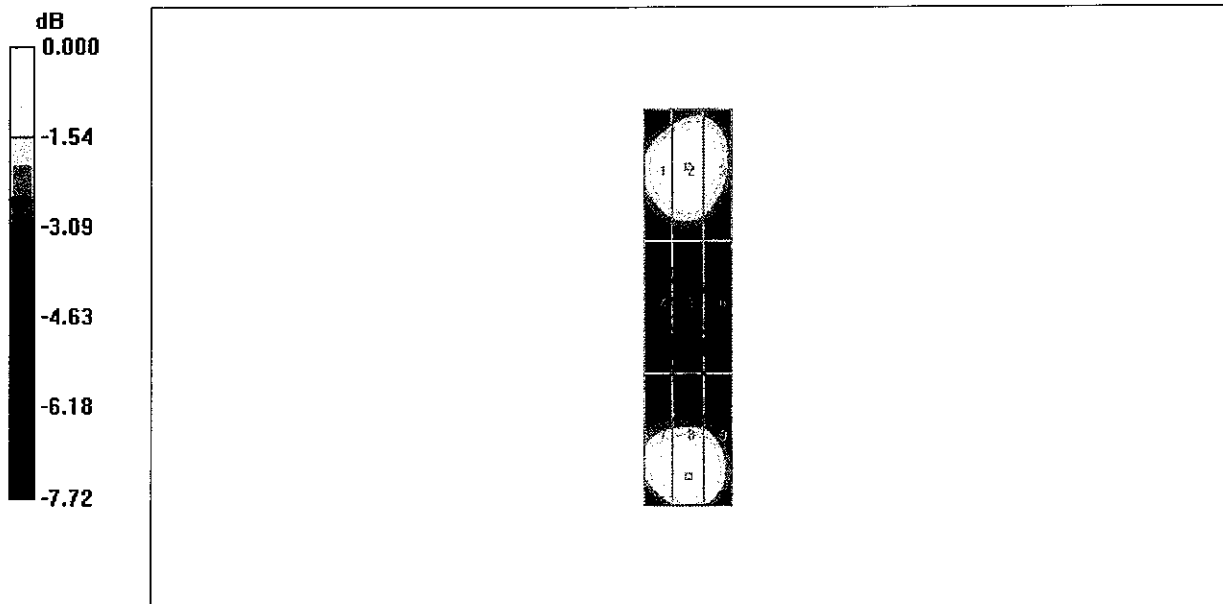

0 dB = 139.2V/m

## 4 Additional Measurements

### 4.1 Measurement Conditions

DASY system configuration, as far as not given on page 1.

<b>DASY Version</b>	DASY4	V4.7 B55
<b>DASY PP Version</b>	SEMCAD	V1.8 B176
<b>Phantom</b>	HAC Test Arch	SD HAC P01 BA, #1070
<b>Distance Dipole Top - Probe Center</b>	10 mm	
<b>Scan resolution</b>	dx, dy = 5 mm	area = 20 x 90 mm
<b>Frequency</b>	1730 MHz $\pm$ 1 MHz	
<b>Forward power at dipole connector</b>	20.0 dBm = 100mW	
<b>Input power drift</b>	< 0.05 dB	

### 4.2 Maximum Field values

<b>H-field 10 mm above dipole surface</b>	condition	<b>Interpolated maximum</b>
Maximum measured	100 mW forward power	<b>0.489 A/m</b>

Uncertainty for H-field measurement: 8.2% (k=2)

<b>E-field 10 mm above dipole surface</b>	condition	<b>Interpolated maximum</b>
Maximum measured above high end	100 mW forward power	150.5 V/m
Maximum measured above low end	100 mW forward power	148.0 V/m
Averaged maximum above arm	100 mW forward power	<b>149.3 V/m</b>

Uncertainty for E-field measurement: 12.8% (k=2)

**4.3.1 DASY4 H-Field Result**

Date/Time: 24.01.2008 11:39:10

Test Laboratory: SPEAG Lab 2

**H\_CD1730\_1071\_080122**

**DUT: HAC Dipole 1880 MHz; Type: CD1880V3; Serial: 1071**  
 Communication System: CW; Frequency: 1730 MHz; Duty Cycle: 1:1  
 Medium parameters used:  $\sigma = 0$  mho/m,  $\epsilon_r = 1$ ;  $\rho = 1$  kg/m<sup>3</sup>  
 Phantom section: H Dipole Section  
 Measurement Standard: DASY4 (High Precision Assessment)  
 DASY4 Configuration:

- Probe: H3DV6 - SN6065; ; Calibrated: 31.12.2007
- Sensor-Surface: (Fix Surface)
- Electronics: DAE4 Sn781; Calibrated: 02.10.2007
- Phantom: HAC Test Arch with Coil; Type: SD HAC P01 BA; Serial: 1070
- Measurement SW: DASY4, V4.7 Build 44; Postprocessing SW: SEMCAD, V1.8 Build 174

**H Scan - Sensor Center 10mm above CD1880V3 Dipole 2/Hearing Aid Compatibility Test (41x181x1):**

Measurement grid: dx=5mm, dy=5mm  
 Maximum value of peak Total field = 0.489 A/m  
 Probe Modulation Factor = 1.00  
 Reference Value = 0.520 A/m; Power Drift = -0.003 dB  
**Hearing Aid Near-Field Category: M2 (AWF 0 dB)**

Peak H-field in A/m

Grid 1 <b>0.405 M2</b>	Grid 2 <b>0.423 M2</b>	Grid 3 <b>0.400 M2</b>
Grid 4 <b>0.465 M2</b>	Grid 5 <b>0.489 M2</b>	Grid 6 <b>0.464 M2</b>
Grid 7 <b>0.416 M2</b>	Grid 8 <b>0.439 M2</b>	Grid 9 <b>0.414 M2</b>

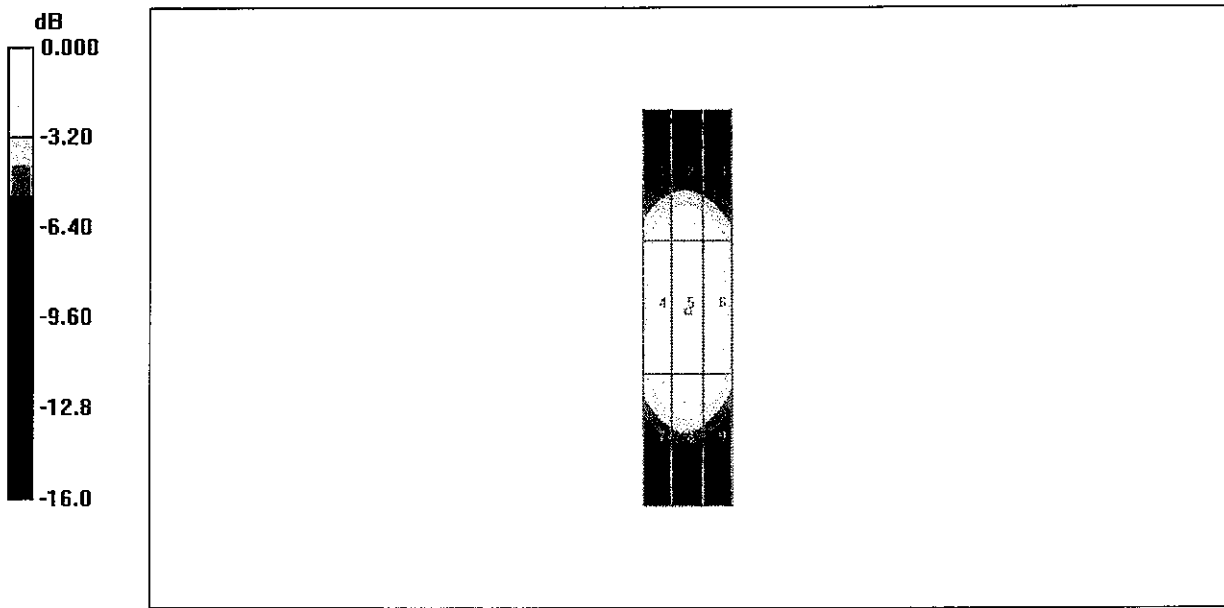

0 dB = 0.489A/m

**4.3.2 DASY4 E-Field Result**

Date/Time: 24.01.2008 11:20:26

Test Laboratory: SPEAG Lab 2

**E\_CD1730\_1071\_080122**

**DUT: HAC Dipole 1880 MHz; Type: CD1880V3; Serial: 1071**

Communication System: CW; Frequency: 1730 MHz; Duty Cycle: 1:1

Medium parameters used:  $\sigma = 0$  mho/m,  $\epsilon_r = 1$ ;  $\rho = 1000$  kg/m<sup>3</sup>

Phantom section: E Dipole Section

Measurement Standard: DASY4 (High Precision Assessment)

DASY4 Configuration:

- Probe: ER3DV6 - SN2336; ConvF(1, 1, 1); Calibrated: 31.12.2007
- Sensor-Surface: (Fix Surface)
- Electronics: DAE4 Sn781; Calibrated: 02.10.2007
- Phantom: HAC Test Arch with Coil; Type: SD HAC P01 BA; Serial: 1070
- Measurement SW: DASY4, V4.7 Build 44; Postprocessing SW: SEMCAD, V1.8 Build 174

**E Scan - Sensor Center 10mm above CD1880V3 Dipole 2/Hearing Aid Compatibility Test (41x181x1):**

Measurement grid: dx=5mm, dy=5mm

Maximum value of peak Total field = 150.5 V/m

Probe Modulation Factor = 1.00

Reference Value = 170.3 V/m; Power Drift = -0.011 dB

**Hearing Aid Near-Field Category: M2 (AWF 0 dB)**

Peak E-field in V/m

Grid 1 <b>143.6 M2</b>	Grid 2 <b>148.0 M2</b>	Grid 3 <b>143.1 M2</b>
Grid 4 <b>103.5 M3</b>	Grid 5 <b>106.0 M3</b>	Grid 6 <b>101.5 M3</b>
Grid 7 <b>143.3 M2</b>	Grid 8 <b>150.5 M2</b>	Grid 9 <b>145.1 M2</b>

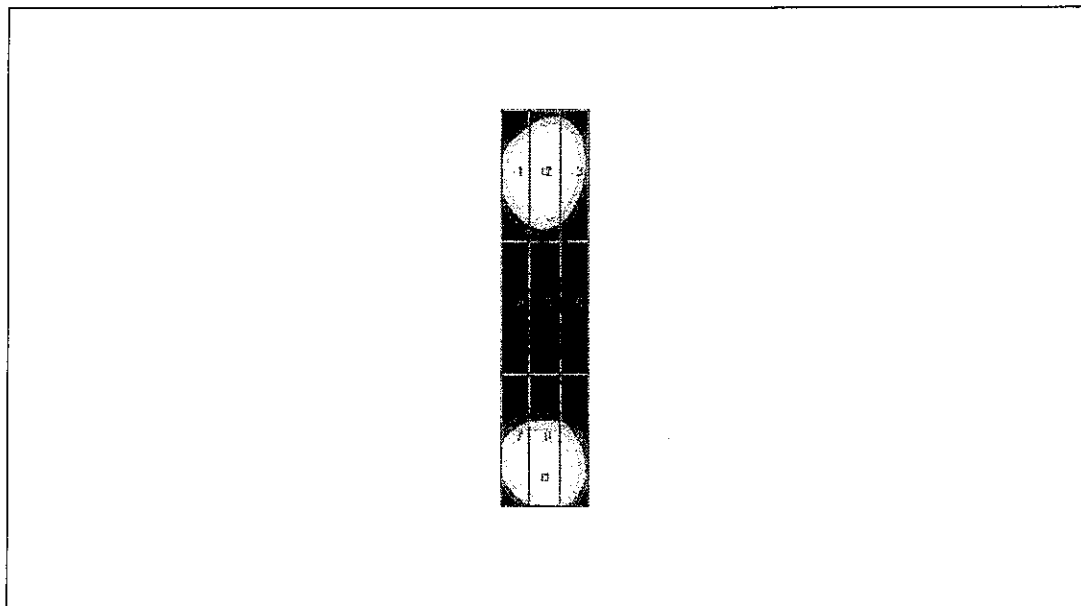

0 dB = 150.5V/m