

FCC Test Report (Part 96)

Report No.: RF200505E03-1

FCC ID: I88LTE7485-S905

Test Model: LTE7485-S905

Received Date: May 11, 2020

Test Date: June 11 to July 06, 2020

Issued Date: July 09, 2020

Applicant: Zyxel Communications Corporation

Address: No.2 Industry East RD. IX, Hsinchu Science Park, Hsinchu 30075, Taiwan

Issued By: Bureau Veritas Consumer Products Services (H.K.) Ltd., Taoyuan Branch
Hsin Chu Laboratory

Lab Address: E-2, No.1, Li Hsin 1st Road, Hsinchu Science Park, Hsinchu City 300,
Taiwan

Test Location : E-2, No.1, Li Hsin 1st Road, Hsinchu Science Park, Hsinchu City 300,
Taiwan

**FCC Registration /
Designation Number:** 723255 / TW2022



This report is for your exclusive use. Any copying or replication of this report to or for any other person or entity, or use of our name or trademark, is permitted only with our prior written permission. This report sets forth our findings solely with respect to the test samples identified herein. The results set forth in this report are not indicative or representative of the quality or characteristics of the lot from which a test sample was taken or any similar or identical product specifically and expressly noted. Our report includes all of the tests requested by you and the results thereof based upon the information that you provided to us. You have 60 days from date of issuance of this report to notify us of any material error or omission caused by our negligence, provided, however, that such notice shall be in writing and shall specifically address the issue you wish to raise. A failure to raise such issue within the prescribed time shall constitute your unqualified acceptance of the completeness of this report, the tests conducted and the correctness of the report contents. Unless specific mention, the uncertainty of measurement has been explicitly taken into account to declare the compliance or non-compliance to the specification.

Table of Contents

Release Control Record	4
1 Certificate of Conformity	5
2 Summary of Test Results	6
2.1 Measurement Uncertainty.....	6
2.2 Modification Record.....	6
3 General Information	7
3.1 General Description of EUT.....	7
3.1.1 Test Mode Applicability and Tested Channel Detail.....	9
3.2 Description of Support Units.....	11
3.2.1 Configuration of System under Test.....	12
3.3 General Description of Applied Standards and References.....	13
4 Test Types and Results	14
4.1 Maximum EIRP Measurement.....	14
4.1.1 Limits of Maximum EIRP Measurement.....	14
4.1.2 Test Setup.....	14
4.1.3 Test Instruments.....	15
4.1.4 Test Procedures.....	17
4.1.5 Deviation from Test Standard.....	17
4.1.6 EUT Operating Conditions.....	17
4.1.7 Test Results.....	18
4.2 Modulation Characteristics Measurement.....	27
4.2.1 Limits of Modulation Characteristics.....	27
4.2.2 Test Procedure.....	27
4.2.3 Test Setup.....	27
4.2.4 Test Results.....	28
4.3 Maximum Power Spectral Density Measurement.....	29
4.3.1 Limits of Maximum Power Spectral Density Measurement.....	29
4.3.2 Test Setup.....	29
4.3.3 Test Instruments.....	29
4.3.4 Test Procedure.....	29
4.3.5 Deviation from Test Standard.....	29
4.3.6 EUT Operating Condition.....	29
4.3.7 Test Results.....	30
4.4 Frequency Stability Measurement.....	36
4.4.1 Limits of Frequency Stability Measurement.....	36
4.4.2 Test Procedure.....	36
4.4.3 Test Instruments.....	36
4.4.4 Test Setup.....	36
4.4.5 Test Results.....	37
4.5 Emission Bandwidth Measurement.....	39
4.5.1 Limit of Emission Bandwidth Measurement.....	39
4.5.2 Test Setup.....	39
4.5.3 Test Instruments.....	39
4.5.4 Test Procedure.....	39
4.5.5 Deviation from Test Standard.....	39
4.5.6 EUT Operating Conditions.....	39
4.5.7 Test Result (-26dB Bandwidth).....	40
4.5.8 Test Result (Occupied Bandwidth).....	54
4.6 Peak to Average Ratio.....	68
4.6.1 Limits of Peak to Average Ratio Measurement.....	68
4.6.2 Test Setup.....	68
4.6.3 Test Procedures.....	68

4.6.4	Test Results	69
4.7	Conducted Spurious Emissions	84
4.7.1	Limits of Conducted Spurious Emissions Measurement	84
4.7.2	Test Setup	84
4.7.3	Test Instruments	84
4.7.4	Test Procedure	85
4.7.5	Test Results	86
4.8	Radiated Emission Measurement	125
4.8.1	Limits of Radiated Emission Measurement	125
4.8.2	Test Instruments	125
4.8.3	Test Procedures.....	125
4.8.4	Deviation from Test Standard	125
4.8.5	Test Setup.....	126
4.8.6	Test Results	127
5	Pictures of Test Arrangements.....	153
	Appendix – Information of the Testing Laboratories	154

Release Control Record

Issue No.	Description	Date Issued
RF200505E03-1	Original release.	July 09, 2020

1 Certificate of Conformity

Product: 4G LTE-A Outdoor Router
Brand: ZYXEL
Test Model: LTE7485-S905
Sample Status: ENGINEERING SAMPLE
Applicant: Zyxel Communications Corporation
Test Date: June 11 to July 06, 2020
Standards: 47 CFR FCC Part 96, Subpart E

The above equipment has been tested by **Bureau Veritas Consumer Products Services (H.K.) Ltd., Taoyuan Branch**, and found compliance with the requirement of the above standards. The test record, data evaluation & Equipment Under Test (EUT) configurations represented herein are true and accurate accounts of the measurements of the sample's RF characteristics under the conditions specified in this report.

Prepared by : Vivian Huang , **Date:** July 09, 2020
Vivian Huang / Specialist

Approved by : Clark Lin , **Date:** July 09, 2020
Clark Lin / Technical Manager

2 Summary of Test Results

47 CFR FCC Part 96			
FCC Clause	Test Item	Result	Remarks
2.1046 96.41(b)	Maximum Peak Output Power and Maximum EIRP	Pass	Meet the requirement of limit.
2.1046 96.41(b)	Maximum Power Spectral Density	Pass	Meet the requirement of limit.
2.1047 96.41(a)	Modulation characteristics	Pass	Meet the requirement.
96.41(g)	Peak to Average Ration	Pass	Meet the requirement of limit.
2.1049	Emission Bandwidth	Pass	Meet the requirement of limit.
2.1055	Frequency Stability	Pass	Meet the requirement of limit.
2.1051 96.41(e)	Conducted Spurious Emissions	Pass	Meet the requirement of limit.
2.1053 96.41(e)	Radiated Spurious Emissions	Pass	Meet the requirement of limit. Minimum passing margin is -6.74dB at 17762.5MHz.

Note:

Determining compliance based on the results of the compliance measurement, not taking into account measurement instrumentation uncertainty.

2.1 Measurement Uncertainty

Where relevant, the following measurement uncertainty levels have been estimated for tests performed on the EUT as specified in CISPR 16-4-2:

Measurement	Frequency	Expanded Uncertainty (k=2) (±)
Radiated Emissions up to 1 GHz	9kHz ~ 30MHz	3.1 dB
	30MHz ~ 1GHz	5.1 dB
Radiated Emissions above 1 GHz	1GHz ~ 18GHz	5.1 dB
	18GHz ~ 40GHz	5.3 dB

2.2 Modification Record

There were no modifications required for compliance.

3 General Information

3.1 General Description of EUT

Product	4G LTE-A Outdoor Router	
Brand	ZYXEL	
Test Model	LTE7485-S905	
CPU Model No.	MT7621AT	
WiFi Chip Model No.	MT7603EN	
LTE Chip Model No.	EG16-AC	
FW version	1.00(ABVN.0)C0	
Status of EUT	ENGINEERING SAMPLE	
Power Supply Rating	Refer to Note 3	
Modulation Type	QPSK, 16QAM, 64QAM	
Operating Frequency	LTE Band 48	TX: 3552.5 ~ 3697.5 MHz
		RX: 3552.5 ~ 3697.5 MHz
Channel Bandwidth	5MHz, 10MHz, 15MHz & 20MHz	
Max. EIRP Power	Channel Bandwidth 5MHz	36.80 dBm
	Channel Bandwidth 10MHz	36.61 dBm
	Channel Bandwidth 15MHz	37.02 dBm
	Channel Bandwidth 20MHz	37.12 dBm
	Channel Bandwidth 20MHz+20MHz	36.64 dBm
Emission Designator	Channel Bandwidth 5MHz	QPSK: 4M47G7D
		16QAM: 4M48D7W
		64QAM: 4M48D7W
	Channel Bandwidth 10MHz	QPSK: 8M96G7D
		16QAM: 8M96D7W
		64QAM: 8M96D7W
	Channel Bandwidth 15MHz	QPSK: 13M4G7D
		16QAM: 13M4D7W
		64QAM: 13M4D7W
	Channel Bandwidth 20MHz	QPSK: 17M9G7D
		16QAM: 17M8D7W
		64QAM: 17M9D7W
Channel Bandwidth 20MHz+20MHz	QPSK: 37M4G7D	
	16QAM: 37M5D7W	
	64QAM: 37M2D7W	
Antenna Type	Refer to note as below	
Antenna Connector	Refer to note as below	
Accessory Device	Adapter (PoE) x 1	
Data Cable Supplied	RJ45 cable (Unshielded, 1.8m)	

Note:

1. The EUT has two radios as following table:

Radio 1	Radio 2
WLAN (2.4GHz)	WWAN

2. Simultaneously transmission condition.

Condition	Technology	
1	WLAN (2.4GHz)	WWAN

Note: The emission of the simultaneous operation has been evaluated and no non-compliance was found.

3. The EUT must be supplied with an Adapter (POE), please refer to the following table:

Brand	Model	Spec.
RISUNIC	RP020-4800500USG	Input: 100-240Vac, 0.7A, 50/60Hz Output: 48Vdc, 0.5A

4. The antennas provided to the EUT, please refer to the following table:

RF Chain NO	Antenna Net Gain(dBi)	Frequency range	Antenna Type	Connector Type
WLAN-ANT0	6	2.4~2.4835GHz	PIFA	iPEX
WLAN-ANT1	5	2.4~2.4835GHz	PIFA	iPEX
WWAN_0(TX&RX)	13	3550 MHz to 3700 MHz	Dipole	iPEX
WWAN_1(RX only)	13	3550 MHz to 3700 MHz	Dipole	iPEX
WWAN_2(RX only)	13	3550 MHz to 3700 MHz	Dipole	iPEX
WWAN_3(RX only)	13	3550 MHz to 3700 MHz	Dipole	iPEX

5. This device is UE LTE Router that can support carrier aggregation (two carrier) uplink Intra-Band contiguous, specification following as below:

Uplink CA Configurations	Component carriers in order of increasing carrier frequency		Maximum Aggregated Bandwidth [MHz]
	Channel bandwidths for carrier-1 [MHz]	Channel bandwidths for carrier-2 [MHz]	
CA_48C	20	20	40

6. The above EUT information is declared by manufacturer and for more detailed features description, please refer to the manufacturer's specifications or user's manual.

7. The above Antenna information is declared by manufacturer and for more detailed features description, please refer to the manufacturer's specifications, the laboratory shall not be held responsible.

3.1.1 Test Mode Applicability and Tested Channel Detail

Pre-Scan has been conducted to determine the worst-case mode from all possible combinations between available modulations, data rates, 0 degree, Vertical +30 degree, Vertical -30 degree, 0 degree clockwise 45 degree and 0 degree counterclockwise 45 degree antenna ports and RB configs

The worst case was found when positioned on 0 degree and RB configs worst case is 1RB. Following channel(s) was (were) selected for the final test as listed below:

Test Item	Available Frequency (MHz)	Tested Frequency (MHz)	Channel Bandwidth	Modulation
EIRP	3552.5 to 3697.5	3552.5, 3625, 3697.5	5MHz	QPSK, 16QAM, 64QAM
	3555 to 3695	3555, 3625, 3695	10MHz	QPSK, 16QAM, 64QAM
	3557.5 to 3692.5	3557.5, 3625, 3692.5	15MHz	QPSK, 16QAM, 64QAM
	3560 to 3690	3560, 3625, 3690	20MHz	QPSK, 16QAM, 64QAM
Modulation Characteristics	3552.5 to 3697.5	3625	5MHz	QPSK, 16QAM, 64QAM
Power Spectral Density	3552.5 to 3697.5	3552.5, 3625, 3697.5	5MHz	QPSK
	3555 to 3695	3555, 3625, 3695	10MHz	QPSK
	3557.5 to 3692.5	3557.5, 3625, 3692.5	15MHz	QPSK
	3560 to 3690	3560, 3625, 3690	20MHz	QPSK
Frequency Stability	3552.5 to 3697.5	3625	5MHz	QPSK
	3555 to 3695	3625	10MHz	QPSK
	3557.5 to 3692.5	3625	15MHz	QPSK
	3560 to 3690	3625	20MHz	QPSK
Occupied Bandwidth	3552.5 to 3697.5	3552.5, 3625, 3697.5	5MHz	QPSK, 16QAM, 64QAM
	3555 to 3695	3555, 3625, 3695	10MHz	QPSK, 16QAM, 64QAM
	3557.5 to 3692.5	3557.5, 3625, 3692.5	15MHz	QPSK, 16QAM, 64QAM
	3560 to 3690	3560, 3625, 3690	20MHz	QPSK, 16QAM, 64QAM
Peak to Average Ratio	3552.5 to 3697.5	3552.5, 3625, 3697.5	5MHz	QPSK
	3555 to 3695	3555, 3625, 3695	10MHz	QPSK
	3557.5 to 3692.5	3557.5, 3625, 3692.5	15MHz	QPSK
	3560 to 3690	3560, 3625, 3690	20MHz	QPSK
Conducted Emission	3552.5 to 3697.5	3552.5, 3625, 3697.5	5MHz	QPSK
	3555 to 3695	3555, 3625, 3695	10MHz	QPSK
	3557.5 to 3692.5	3557.5, 3625, 3692.5	15MHz	QPSK
	3560 to 3690	3560, 3625, 3690	20MHz	QPSK
Radiated Emission	3552.5 to 3697.5	3552.5, 3625, 3697.5	5MHz	QPSK
	3555 to 3695	3555, 3625, 3695	10MHz	QPSK
	3557.5 to 3692.5	3557.5, 3625, 3692.5	15MHz	QPSK
	3560 to 3690	3560, 3625, 3690	20MHz	QPSK

NOTE: All supported modulation types were evaluated. The Worst case of QPSK was selected. Therefore, the Frequency Stability, Peak to Average Ratio, Conducted Emission and Radiated Emission were presented under QPSK mode only.

LTE CA_48C

Test Item	Modulation	PCC			SCC		
		Channel Bandwidth	Tested Freq. (MHz)	Mode	Channel Bandwidth	Tested Freq. (MHz)	Mode
EIRP	QPSK 16QAM	20MHz	3560	1RB / 0 RB offset	20MHz	3579.8	0RB / 0 RB offset
Power Spectral Density	QPSK	20MHz	3560	1RB / 0 RB offset	20MHz	3579.8	0RB / 0 RB offset
Frequency Stability	QPSK	20MHz	3560	-	20MHz	3579.8	-
Occupied Bandwidth	QPSK, 16QAM, 64QAM	20MHz	3560	100RB / 0 RB offset	20MHz	3579.8	100RB / 0 RB offset
Peak to Average Ratio	QPSK, 16QAM, 64QAM	20MHz	3560	100RB / 0 RB offset	20MHz	3579.8	100RB / 0 RB offset
Band Edge	QPSK	20MHz	3560	1RB / 0 RB offset	20MHz	3579.8	0RB / 0 RB offset
				0RB / 0 RB offset			1RB / 99 RB offset
				100RB / 0 RB offset			100RB / 0 RB offset
Conducted Emission	QPSK	20MHz	3560	1RB / 0 RB offset	20MHz	3579.8	0RB / 0 RB offset
Radiated Emission	QPSK	20MHz	3560	1RB / 0 RB offset	20MHz	3579.8	0RB / 0 RB offset

Note: This product supports multiple carriers in intra-band contiguous spectrum operation, therefore worst case of test mode and test configurations was selected.

Test Condition:

Test Item	Environmental Conditions	Input Power	Tested By
EIRP	24deg. C, 58%RH	120Vac, 60Hz	Allen Chuang
Modulation Characteristics	20deg. C, 76%RH	120Vac, 60Hz	Allen Chuang
Frequency Stability	20deg. C, 76%RH	120Vac, 60Hz	Allen Chuang
Occupied Bandwidth	20deg. C, 76%RH	120Vac, 60Hz	Allen Chuang
Peak to Average Ratio	20deg. C, 76%RH	120Vac, 60Hz	Allen Chuang
Conducted Emission	20deg. C, 76%RH	120Vac, 60Hz	Allen Chuang
Radiated Emission	22deg. C, 64%RH	120Vac, 60Hz	Nelson Teng

3.2 Description of Support Units

The EUT has been tested as an independent unit together with other necessary accessories or support units. The following support units or accessories were used to form a representative test configuration during the tests.

ID	Product	Brand	Model No.	Serial No.	FCC ID	Remarks
A.	Laptop	DELL	E5430	GM1SKV1	FCC DoC	Provided by Lab
B.	SIM Card	Keysight	E7515-10910	NA	NA	Provided by Lab
C.	Simulator	Keysight	E7515A	MY55340229	NA	Provided by Lab

Note:

1. All power cords of the above support units are non-shielded (1.8m).

ID	Descriptions	Qty.	Length (m)	Shielding (Yes/No)	Cores (Qty.)	Remarks
1.	RJ-45 Cable	1	1.8	No	0	Supplied by client
2.	RJ-45 Cable	1	10	No	0	Provided by Lab
3.	GND cable	1	1	No	0	Supplied by client
4.	GND cable	1	1.9	No	0	Provided by Lab

3.2.1 Configuration of System under Test

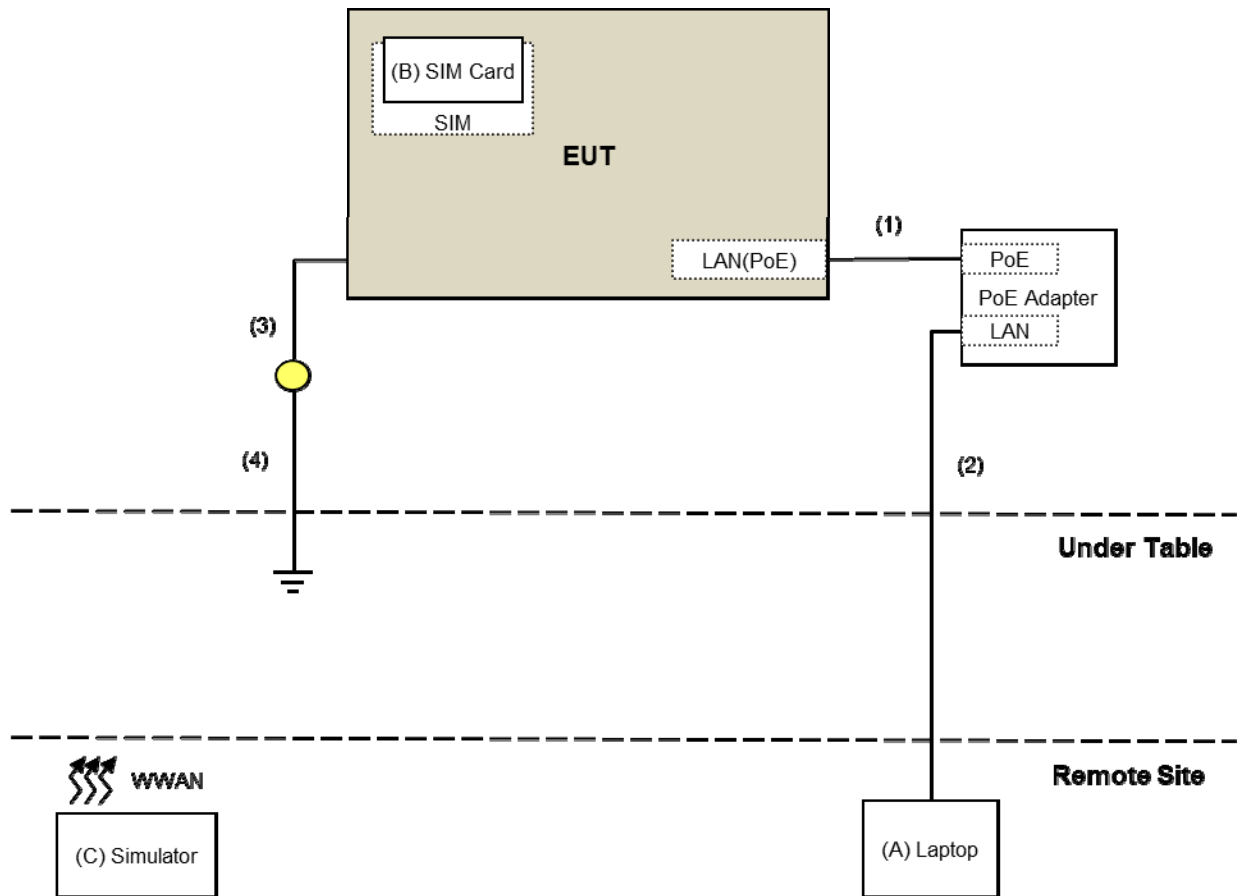

3.3 General Description of Applied Standards and References

The EUT is a RF Product. According to the specifications of the manufacturer, it must comply with the requirements of the following standards and references:

Test Standard:

47 CFR FCC Part 2

47 CFR FCC Part 96, Subpart E

ANSI/TIA/EIA-603-E 2016

ANSI 63.26-2015

All test items have been performed and recorded as per the above standards.

References Test Guidance:

KDB 971168 D01 Power Meas License Digital Systems v03r01

All test items have been performed and recorded as per the above standards and KDB test guidance.

4 Test Types and Results

4.1 Maximum EIRP Measurement

4.1.1 Limits of Maximum EIRP Measurement

Device		Maximum EIRP (dBm/10 MHz)
<input type="checkbox"/>	End User Device	23
<input type="checkbox"/>	Category A CBSD	30
<input checked="" type="checkbox"/>	Category B CBSD	47

4.1.2 Test Setup

Conducted / EIRP Power Measurement:

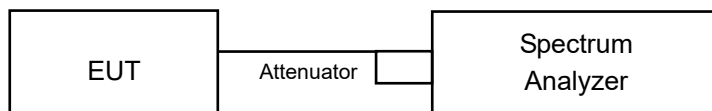

Full Power Measurement:

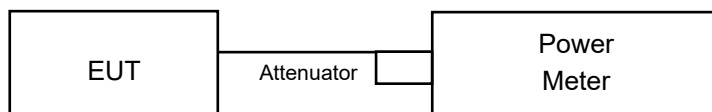

4.1.3 Test Instruments

For radiated emissions test:

DESCRIPTION & MANUFACTURER	MODEL NO.	SERIAL NO.	CALIBRATED DATE	CALIBRATED UNTIL
Test Receiver R&S	ESR7	102026	Apr. 22, 2020	Apr. 21, 2021
Spectrum Analyzer Keysight	N9030B	MY57141948	May 22, 2020	May 21, 2021
Pre-Amplifier EMCI	EMC001340	980142	May 25, 2020	May 24, 2021
Loop Antenna Electro-Metrics	EM-6879	264	Feb. 18, 2020	Feb. 17, 2021
RF Cable	NA	LOOPCAB-001	Jan. 08, 2020	Jan. 07, 2021
RF Cable	NA	LOOPCAB-002	Jan. 08, 2020	Jan. 07, 2021
Pre-Amplifier EMCI	EMC330N	980538	Apr. 28, 2020	Apr. 27, 2021
Trilog Broadband Antenna SCHWARZBECK	VULB9168	9168-0842	Nov. 08, 2019	Nov. 07, 2020
RF Cable	8D	966-5-1	Apr. 29, 2020	Apr. 28, 2021
RF Cable	8D	966-5-2	Apr. 29, 2020	Apr. 28, 2021
RF Cable	8D	966-5-3	Apr. 29, 2020	Apr. 28, 2021
Fixed attenuator Mini-Circuits	UNAT-5+	PAD-ATT5-02	Jan. 14, 2020	Jan. 13, 2021
Horn_Antenna SCHWARZBECK	BBHA 9120D	9120D-1819	Nov. 24, 2019	Nov. 23, 2020
Pre-Amplifier EMCI	EMC12630SE	980509	Apr. 29, 2020	Apr. 28, 2021
RF Cable EMCI	EMC104-SM-SM-1500	180503	Apr. 29, 2020	Apr. 28, 2021
RF Cable EMCI	EMC104-SM-SM-2000	180501	Apr. 29, 2020	Apr. 28, 2021
RF Cable EMCI	EMC104-SM-SM-6000	180506	Apr. 29, 2020	Apr. 28, 2021
Pre-Amplifier EMCI	EMC184045SE	980387	Jan. 15, 2020	Jan. 14, 2021
Horn_Antenna SCHWARZBECK	BBHA 9170	BBHA9170519	Nov. 24, 2019	Nov. 23, 2020
RF Cable	EMC102-KM-KM-1200	160924	Jan. 15, 2020	Jan. 14, 2021
RF Cable	EMC-KM-KM-4000	200214	Mar. 11, 2020	Mar. 10, 2021
Software	ADT_Radiated_V8.7.08	NA	NA	NA
Boresight Antenna Tower & Turn Table Max-Full	MF-7802BS	MF780208530	NA	NA

Note:

1. The calibration interval of the above test instruments is 12 months and the calibrations are traceable to NML/ROC and NIST/USA.
2. The test was performed in 966 Chamber No. 5.
3. Tested Date: June 11, 2020

For other test items:

DESCRIPTION & MANUFACTURER	MODEL NO.	SERIAL NO.	CALIBRATED DATE	CALIBRATED UNTIL
Power meter Anritsu	ML2495A	1529002	July 26, 2019	July 25, 2020
Spectrum Analyzer Keysight	N9030A	MY54490679	July 17, 2019	July 16, 2020
AC Power Source Extech Electronics	6205	1440452	NA	NA
Temperature & Humidity Chamber Giant Force	GTH-150-40-SP-AR	MAA0812-008	Jan. 16, 2020	Jan. 15, 2021
Voltage Meter FLUKE	179	89610322	Sep. 25, 2019	Sep. 24, 2020
Mech Switch Absorptive Mini-Circuits	MSP4TA-18+	0140	Feb. 10, 2020	Feb. 09, 2021
FXD ATTEN Mini-Circuits	BW-S3W2+	MN71981	Feb. 10, 2020	Feb. 09, 2021
Software	ADT_RF Test Software V6.6.5.4	NA	NA	NA

- NOTE:**
1. The test was performed in Oven room 2.
 2. The calibration interval of the above test instruments is 12 months and the calibrations are traceable to NML/ROC and NIST/USA.
 3. Tested Date: June 17, 2020

4.1.4 Test Procedures

Conducted / EIRP Power Measurement:

1. Connect the DUT transmitter output to the spectrum analyzer via coaxial cable while ensuring proper impedance matching.
2. Set span to at least 2 times the OBW.
3. Set RBW = 1-5% of the OBW, not to exceed 1 MHz.
4. Set VBW $\geq 3 \times$ RBW.
5. Set number of points in sweep $\geq 2 \times$ span / RBW.
6. Sweep time = auto-couple.
7. Detector = RMS (power averaging).
8. If the EUT can be configured to transmit continuously (i.e., burst duty cycle $\geq 98\%$), then set the trigger to free run.
9. If the EUT cannot be configured to transmit continuously (i.e., burst duty cycle $< 98\%$), then use a sweep trigger with the level set to enable triggering only on full power bursts and configure the EUT to transmit at full power for the entire duration of each sweep. Ensure that the sweep time is less than or equal to the transmission burst duration.
10. Trace average at least 100 traces in power averaging (i.e., RMS) mode.
11. Compute the power by integrating the spectrum across the 10 MHz of the signal using the instrument's band power measurement function. If the instrument does not have a band power function, then sum the spectrum levels (in linear power units) at intervals equal to the RBW extending across the 10MHz of the spectrum
12. RBW set and integrating spectrum set to the reference bandwidth specified by the applicable regulatory requirement.

Full Power Measurement:

The EUT was set up for the maximum power with link data modulation and link up with simulator. Set the EUT to transmit under worse configuration and record the power level shown on power meter.

4.1.5 Deviation from Test Standard

No deviation.

4.1.6 EUT Operating Conditions

The software provided by client to enable the EUT under transmission condition continuously at lowest, middle and highest channel frequencies individually.

4.1.7 Test Results

CONDUCTED OUTPUT POWER (dBm/10MHz)

Single Carrier

Band / BW	RB Size	RB Offset	QPSK			3GPP MPR (dB)	16QAM			3GPP MPR (dB)	64QAM			3GPP MPR (dB)
			Low CH	Mid CH	High CH		Low CH	Mid CH	High CH		Low CH	Mid CH	High CH	
			55265	55990	56715		55265	55990	56715		55265	55990	56715	
			3552.5	3625	3697.5		3552.5	3625	3697.5		3552.5	3625	3697.5	
			MHz	MHz	MHz		MHz	MHz	MHz		MHz	MHz	MHz	
48 / 5M	1	0	23.80	23.56	22.18	0	22.95	22.67	21.34	1	21.97	21.71	20.27	2
	1	12	23.70	23.58	22.15	0	22.94	22.78	21.41	1	21.89	21.72	20.31	2
	1	24	23.61	23.62	22.31	0	22.84	22.85	21.47	1	21.76	21.88	20.37	2
	12	0	22.61	22.69	21.25	1	21.76	21.61	20.29	2	20.94	20.77	19.53	3
	12	6	22.71	22.71	21.33	1	21.67	21.51	20.26	2	20.95	20.69	19.50	3
	12	13	22.69	22.62	21.31	1	21.73	21.77	20.35	2	20.79	20.83	19.58	3
	25	0	22.75	22.58	21.28	1	21.82	21.62	20.37	2	20.84	20.65	19.43	3

Band / BW	RB Size	RB Offset	QPSK			3GPP MPR (dB)	16QAM			3GPP MPR (dB)	64QAM			3GPP MPR (dB)
			Low CH	Mid CH	High CH		Low CH	Mid CH	High CH		Low CH	Mid CH	High CH	
			55290	55990	56690		55290	55990	56690		55290	55990	56690	
			3555	3625	3695		3555	3625	3695		3555	3625	3695	
			MHz	MHz	MHz		MHz	MHz	MHz		MHz	MHz	MHz	
48 / 10M	1	0	23.61	23.24	21.80	0	22.79	22.54	21.07	1	21.70	21.31	19.94	2
	1	24	23.14	23.07	21.86	0	22.49	22.40	21.03	1	21.35	21.28	19.87	2
	1	49	23.05	23.30	21.99	0	22.38	22.61	21.17	1	21.15	21.38	20.02	2
	25	0	22.54	22.28	20.93	1	21.65	21.39	19.94	2	20.64	20.49	18.99	3
	25	12	22.41	22.31	20.96	1	21.53	21.42	19.96	2	20.52	20.52	19.10	3
	25	25	22.21	22.37	21.00	1	21.42	21.47	20.01	2	20.42	20.46	19.06	3
	50	0	22.50	22.29	20.95	1	21.55	21.42	20.03	2	20.52	20.39	19.09	3

Band / BW	RB Size	RB Offset	QPSK			3GPP MPR (dB)	16QAM			3GPP MPR (dB)	64QAM			3GPP MPR (dB)
			Low CH	Mid CH	High CH		Low CH	Mid CH	High CH		Low CH	Mid CH	High CH	
			55315	55990	56665		55315	55990	56665		55315	55990	56665	
			3557.5	3625	3692.5		3557.5	3625	3692.5		3557.5	3625	3692.5	
			MHz	MHz	MHz		MHz	MHz	MHz		MHz	MHz	MHz	
48 / 15M	1	0	24.02	23.43	21.90	0	23.30	22.70	21.14	1	22.10	21.49	20.02	2
	1	37	22.60	23.39	21.85	0	22.90	22.67	21.01	1	21.69	21.44	19.87	2
	1	74	23.29	23.48	22.07	0	22.59	22.76	21.24	1	21.36	21.53	20.10	2
	36	0	22.80	22.40	20.97	1	21.85	21.43	20.08	2	20.93	20.50	19.21	3
	36	19	22.64	22.47	21.20	1	21.68	21.59	20.10	2	20.76	20.58	19.25	3
	36	39	22.47	22.40	21.24	1	21.41	21.45	20.15	2	20.59	20.63	19.36	3
	75	0	22.65	22.34	20.13	1	21.78	21.59	20.25	2	20.72	20.53	19.24	3

Band / BW	RB Size	RB Offset	QPSK			3GPP MPR (dB)	16QAM			3GPP MPR (dB)	64QAM			3GPP MPR (dB)
			Low CH	Mid CH	High CH		Low CH	Mid CH	High CH		Low CH	Mid CH	High CH	
			55340	55990	56640		55340	55990	56640		55340	55990	56640	
			3560	3625	3690		3560	3625	3690		3560	3625	3690	
			MHz	MHz	MHz		MHz	MHz	MHz		MHz	MHz	MHz	
48 / 20M	1	0	24.12	23.37	22.05	0	23.37	22.62	21.22	1	22.19	21.43	20.07	2
	1	50	23.66	23.37	21.77	0	22.84	22.64	21.91	1	21.63	21.43	19.87	2
	1	99	23.10	23.47	22.13	0	22.38	22.74	21.38	1	21.27	21.53	20.20	2
	50	0	22.96	22.47	20.95	1	22.09	21.59	20.06	2	22.96	20.57	19.16	3
	50	25	22.69	22.52	21.02	1	21.81	21.64	20.12	2	20.78	20.60	19.12	3
	50	50	22.43	22.54	21.08	1	21.54	21.67	20.17	2	20.64	20.63	19.18	3
	100	0	19.65	19.44	21.05	1	19.70	19.49	20.04	2	19.85	19.62	19.10	3

CA Contiguous
 LTE CA_48C (PCC/SCC: 20M+20M)

Intra Band-Contiguous CA															
PCC							SCC							MPR	
Band	BW (MHz)	Modulation	RB Size	RB Offset	UL Channel	UL Frequency (MHz)	Band	BW (MHz)	Modulation	RB Size	RB Offset	UL Channel	UL Frequency (MHz)	MPR Level (dB)	Tx Power with UL-CA (dBm/10MHz)
48	20	QPSK	0	0	55340	3560	48	20	QPSK	1	99	55538	3579.8	0	22.53
			1	0						0	0			0	23.64
			100	0						0	0			0-1	21.1
			100	0						100	0			0-2	20.96
			1	0						1	99			0-8.5	14.78
			1	0						1	0			0-4.5	18.7
			1	99						1	0			0	22.56
			100	0						1	99			0-3.5	19.31
48	20	QPSK	0	0	55891	3615.1	48	20	QPSK	1	99	56089	3634.9	0	18.5
			1	0						0	0			0	20.07
			100	0						0	0			0-1	18.82
			100	0						100	0			0-2	20.7
			1	0						1	99			0-8.5	14.44
			1	0						1	0			0-4.5	18.53
			1	99						1	0			0	22.47
			100	0						1	99			0-3.5	19.17
48	20	QPSK	0	0	56442	3670.2	48	20	QPSK	1	99	56640	3690	0	18.04
			1	0						0	0			0	20.01
			100	0						0	0			0-1	18.54
			100	0						100	0			0-2	20.47
			1	0						1	99			0-8.5	14.25
			1	0						1	0			0-4.5	18.28
			1	99						1	0			0	21.63
			100	0						1	99			0-3.5	18.98

Intra Band-Contiguous CA															
PCC						SCC						MPR			
Band	BW (MHz)	Modulation	RB Size	RB Offset	UL Channel	UL Frequency (MHz)	Band	BW (MHz)	Modulation	RB Size	RB Offset	UL Channel	UL Frequency (MHz)	MPR Level (dB)	Tx Power with UL-CA (dBm/10MHz)
48	20	16QAM	0	0	55340	3560	48	20	16QAM	1	99	55538	3579.8	0	21.21
			1	0						0	0			0	22.31
			100	0						0	0			0-1	20.34
			100	0						100	0			0-2	19.21
			1	0						1	99			0-8.5	13.75
			1	0						1	0			0-4.5	17.81
			1	99						1	0			0	21.31
			100	0						1	99			0-3.5	18.5
48	20	16QAM	0	0	55891	3615.1	48	20	16QAM	1	99	56089	3634.9	0	18.03
			1	0						0	0			0	19.83
			100	0						0	0			0-1	18.65
			100	0						100	0			0-2	18.65
			1	0						1	99			0-8.5	13.15
			1	0						1	0			0-4.5	17.28
			1	99						1	0			0	21.07
			100	0						1	99			0-3.5	18.09
48	20	16QAM	0	0	56442	3670.2	48	20	16QAM	1	99	56640	3690	0	18.02
			1	0						0	0			0	19.93
			100	0						0	0			0-1	18.36
			100	0						100	0			0-2	18.57
			1	0						1	99			0-8.5	13.64
			1	0						1	0			0-4.5	17.44
			1	99						1	0			0	20.86
			100	0						1	99			0-3.5	18.08

Full Power (dBm)
Single Carrier

Channel	Freq. (MHz)	5MHz		
		QPSK		
		Conducted Total Average Power (dBm)	Gain(dBi)	13
EIRP				
Low	3552.5	23.97	36.97	
Middle	3625	23.65	36.65	
High	3697.5	22.48	35.48	

Channel	Freq. (MHz)	10MHz		
		QPSK		
		Conducted Total Average Power (dBm)	Gain(dBi)	13
EIRP				
Low	3555	23.81	36.81	
Middle	3625	23.49	36.49	
High	3695	22.05	35.05	

Channel	Freq. (MHz)	15MHz		
		QPSK		
		Conducted Total Average Power (dBm)	Gain(dBi)	13
EIRP				
Low	3557.5	24.03	37.03	
Middle	3625	23.51	36.51	
High	3692.5	22.05	35.05	

Channel	Freq. (MHz)	20MHz		
		QPSK		
		Conducted Total Average Power (dBm)	Gain(dBi)	13
EIRP				
Low	3560	24.29	37.29	
Middle	3625	23.49	36.49	
High	3690	22.06	35.06	

CA Contiguous

Channel	Freq. (MHz)	20MHz+20MHz		
		QPSK		
		Conducted Total Average Power (dBm)	Gain(dBi)	13
			EIRP	
Worst case	3560+3579.8	23.66	36.66	

Channel	Freq. (MHz)	20MHz+20MHz		
		16QAM		
		Conducted Total Average Power (dBm)	Gain(dBi)	13
			EIRP	
Worst case	3560+3579.8	22.38	35.38	

EIRP POWER
Single Carrier

Channel	Freq. (MHz)	5MHz			Limit (dBm/10MHz)	Pass /Fail
		QPSK				
		Conducted Average Power (dBm/10MHz)	Gain(dBi)	13	EIRP	
Low	3552.5		23.80	36.80		47.0
Middle	3625	23.62	36.62	47.0	Pass	
High	3697.5	22.31	35.31	47.0	Pass	

Channel	Freq. (MHz)	10MHz			Limit (dBm/10MHz)	Pass /Fail
		QPSK				
		Conducted Average Power (dBm/10MHz)	Gain(dBi)	13	EIRP	
Low	3555		23.61	36.61		47.0
Middle	3625	23.30	36.30	47.0	Pass	
High	3695	21.99	34.99	47.0	Pass	

Channel	Freq. (MHz)	15MHz			Limit (dBm/10MHz)	Pass /Fail
		QPSK				
		Conducted Average Power (dBm/10MHz)	Gain(dBi)	13	EIRP	
Low	3557.5		24.02	37.02		47.0
Middle	3625	23.48	36.48	47.0	Pass	
High	3692.5	22.07	35.07	47.0	Pass	

Channel	Freq. (MHz)	20MHz			Limit (dBm/10MHz)	Pass /Fail
		QPSK				
		Conducted Average Power (dBm/10MHz)	Gain(dBi)	13	EIRP	
Low	3560		24.12	37.12		47.0
Middle	3625	23.47	36.47	47.0	Pass	
High	3690	22.13	35.13	47.0	Pass	

CA Contiguous

Channel	Freq. (MHz)	20MHz+20MHz			Limit (dBm/10MHz)	Pass /Fail
		QPSK				
		Conducted Average Power (dBm/10MHz)	Gain(dBi)	13		
			EIRP		Maximum	
Worst case	3560+3579.8	23.64	36.64	47.0	Pass	

Channel	Freq. (MHz)	20MHz+20MHz			Limit (dBm/10MHz)	Pass /Fail
		16QAM				
		Conducted Average Power (dBm/10MHz)	Gain(dBi)	13		
			EIRP		Maximum	
Worst case	3560+3579.8	22.31	35.31	47.0	Pass	

Single Carrier

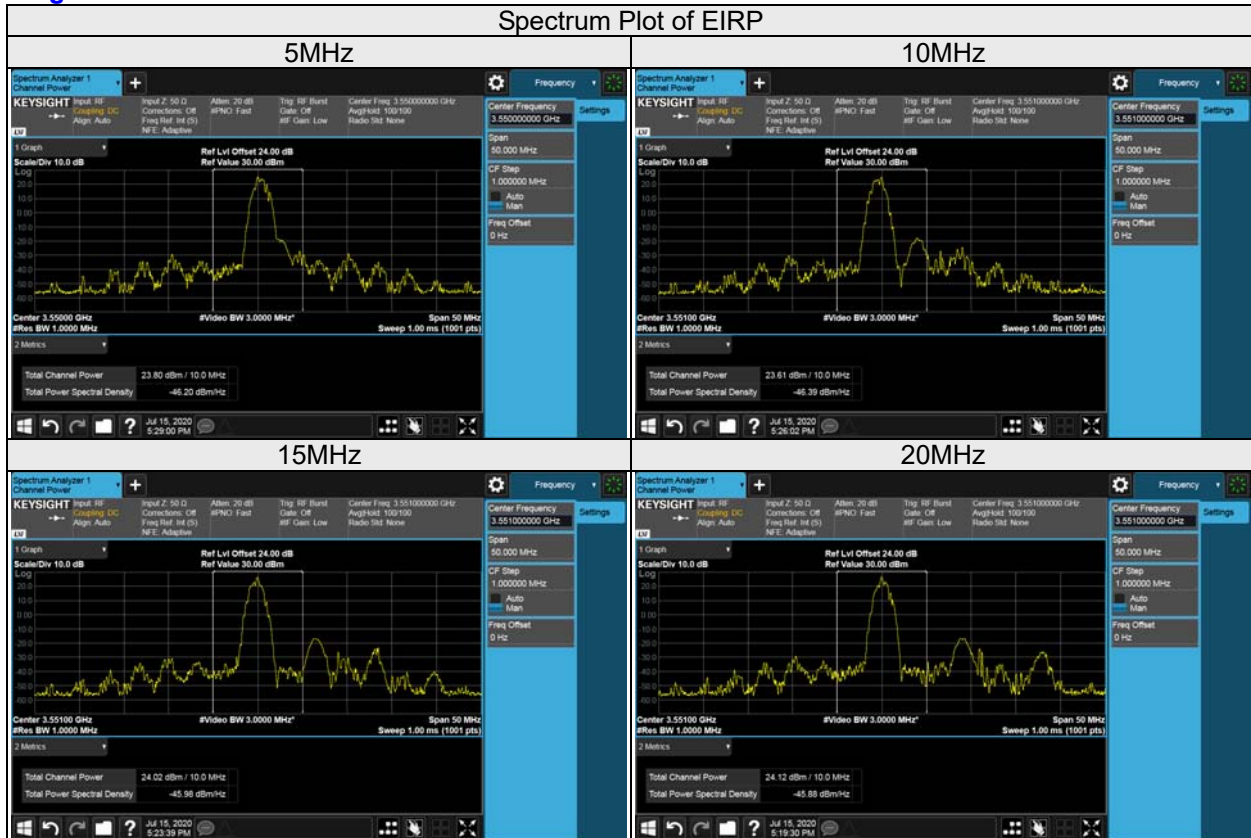

CA Contiguous

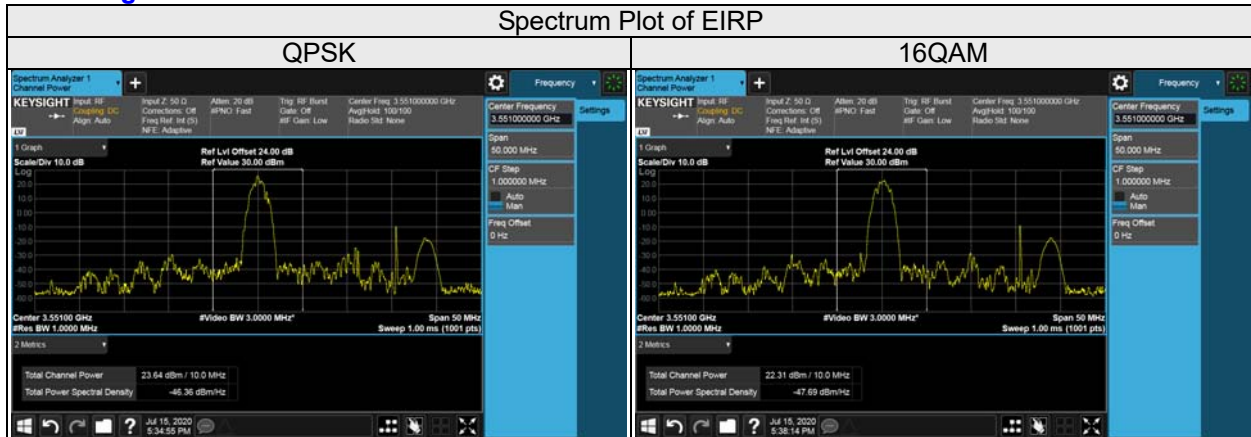

4.2 Modulation Characteristics Measurement

4.2.1 Limits of Modulation Characteristics

N/A

4.2.2 Test Procedure

Connect the EUT to spectrum analyzer via the antenna connector, the frequency band is set as EUT supported Modulation and Channels, the EUT output is matched with 50 ohm load, the waveform quality and constellation of the EUT was tested.

4.2.3 Test Setup

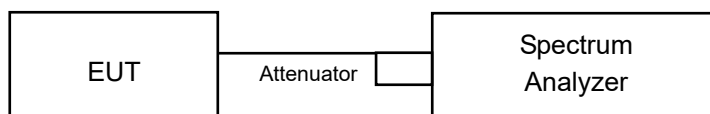

4.2.4 Test Results

**LTE QPSK / Channel Bandwidth: 5MHz /
Frequency: 3625 MHz**

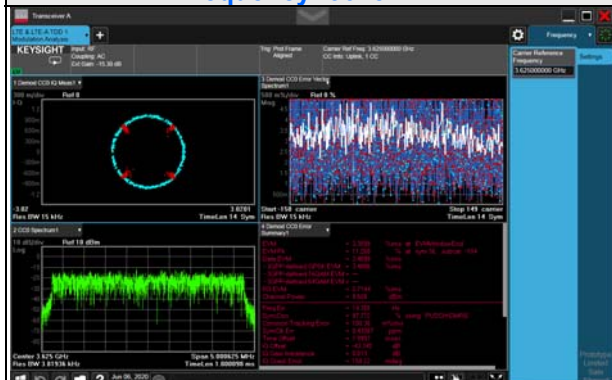

**LTE 16QAM / Channel Bandwidth: 5MHz /
Frequency: 3625 MHz**

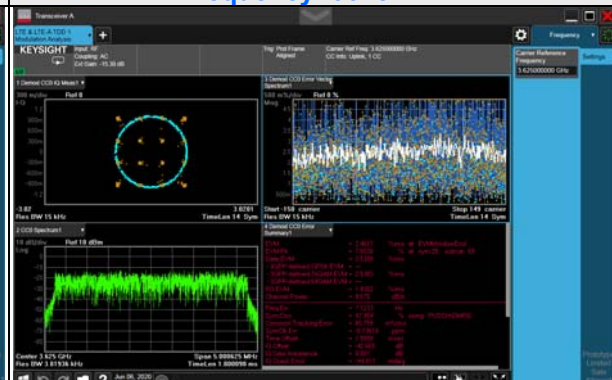

**LTE 64QAM / Channel Bandwidth: 5MHz /
Frequency: 3625 MHz**

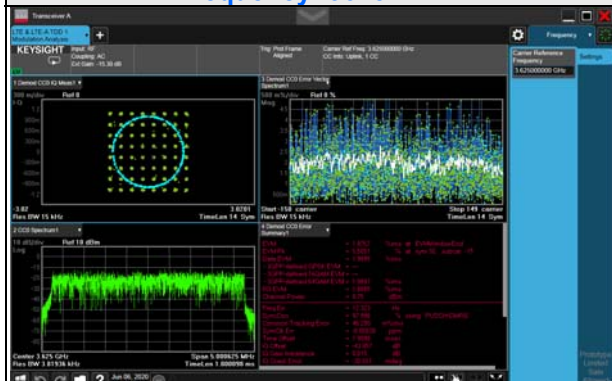

4.3 Maximum Power Spectral Density Measurement

4.3.1 Limits of Maximum Power Spectral Density Measurement

Device	Maximum EIRP PSD (dBm/MHz)
End User Device	n/a
Category A CBSD	20
Category B CBSD	37

4.3.2 Test Setup

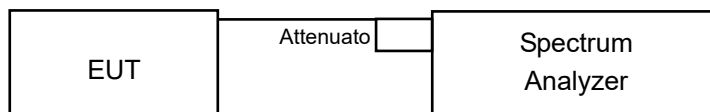

4.3.3 Test Instruments

Refer to section 4.2.3 to get information of above instrument.

4.3.4 Test Procedure

1. Connect the DUT transmitter output to the spectrum analyzer via coaxial cable while ensuring proper impedance matching.
2. Set span to at least 2 times the OBW.
3. Set RBW = 1 MHz.
4. Set VBW $\geq 3 \times$ RBW.
5. Set number of points in sweep $\geq 2 \times$ span / RBW.
6. Sweep time = auto-couple.
7. Detector = RMS (power averaging).
8. If the EUT can be configured to transmit continuously (i.e., burst duty cycle $\geq 98\%$), then set the trigger to free run.
9. If the EUT cannot be configured to transmit continuously (i.e., burst duty cycle $< 98\%$), then use a sweep trigger with the level set to enable triggering only on full power bursts and configure the EUT to transmit at full power for the entire duration of each sweep. Ensure that the sweep time is less than or equal to the transmission burst duration.
10. Trace average at least 100 traces in power averaging (i.e., RMS) mode.

4.3.5 Deviation from Test Standard

No deviation.

4.3.6 EUT Operating Condition

The software provided by client to enable the EUT under transmission condition continuously at lowest, middle and highest channel frequencies individually.

4.3.7 Test Results

Single Carrier

5MHz

Channel	Freq. (MHz)	QPSK			PASS /FAIL	
		Conducted Power density (dBm/MHz)	Gain	13		Limit (dBm)
			Power density			Maximum
Low	3552.5	11.91	24.91	37.0	PASS	
Middle	3625	12.25	25.25	37.0	PASS	
High	3697.5	11.44	24.44	37.0	PASS	

10MHz

Channel	Freq. (MHz)	QPSK			PASS /FAIL	
		Conducted Power density (dBm/MHz)	Gain	13		Limit (dBm)
			Power density			Maximum
Low	3555	8.73	21.73	37.0	PASS	
Middle	3625	9.26	22.26	37.0	PASS	
High	3695	8.22	21.22	37.0	PASS	

15MHz

Channel	Freq. (MHz)	QPSK			PASS /FAIL	
		Conducted Power density (dBm/MHz)	Gain	13		Limit (dBm)
			Power density			Maximum
Low	3557.5	7.07	20.07	37.0	PASS	
Middle	3625	7.47	20.47	37.0	PASS	
High	3692.5	6.52	19.52	37.0	PASS	

20MHz

Channel	Freq. (MHz)	QPSK			PASS /FAIL	
		Conducted Power density (dBm/MHz)	Gain	13		Limit (dBm)
			Power density			Maximum
Low	3560	4.85	17.85	37.0	PASS	
Middle	3625	4.98	17.98	37.0	PASS	
High	3690	5.42	18.42	37.0	PASS	

CA Contiguous

Channel	Freq. (MHz)	QPSK			PASS /FAIL
		Conducted Power density (dBm/MHz)	Gain	Limit (dBm)	
Worse case	3560+3579.8	2.10	13	37.0	PASS

Single Carrier

5MHz:

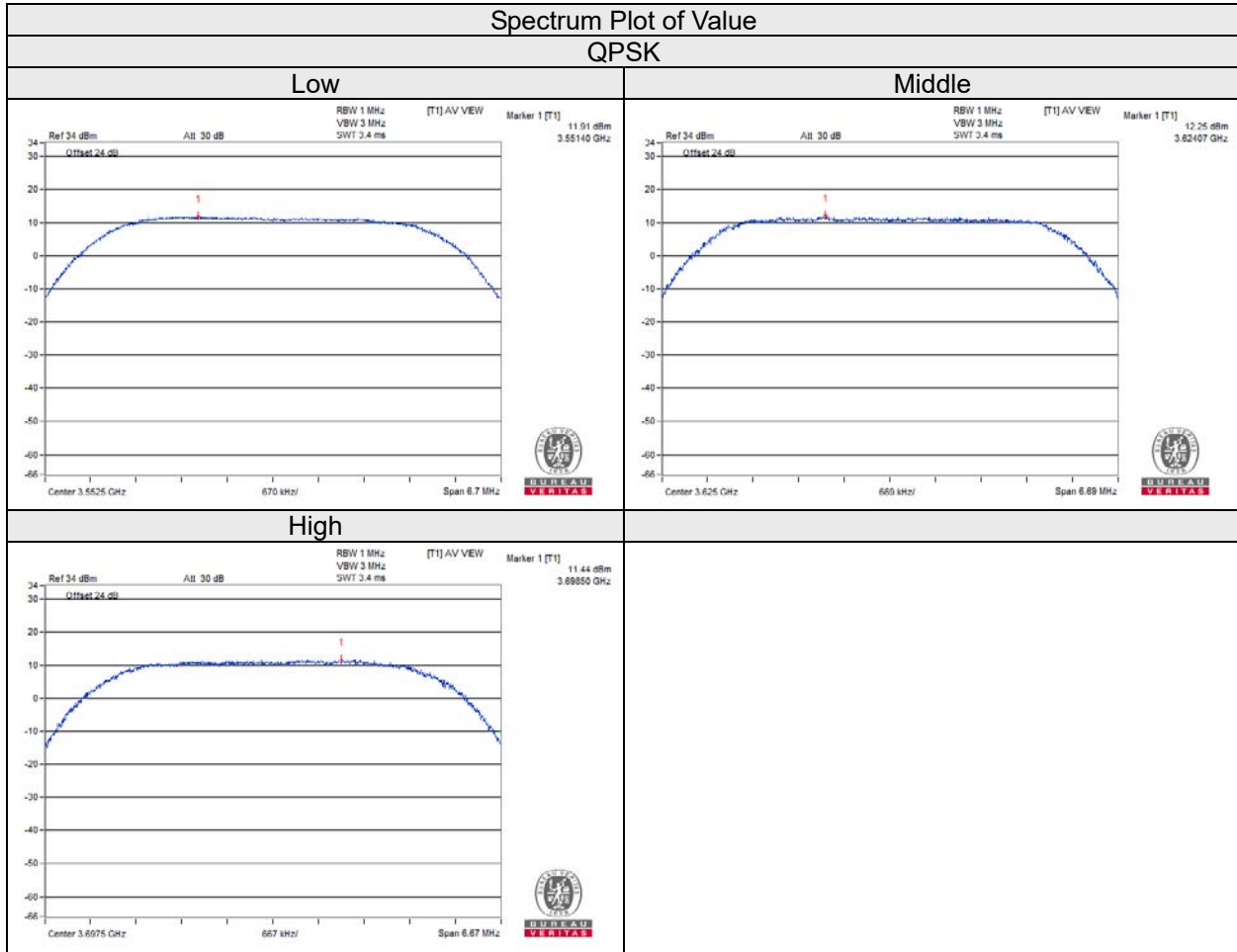

10MHz:

Spectrum Plot of Value

QPSK

Low

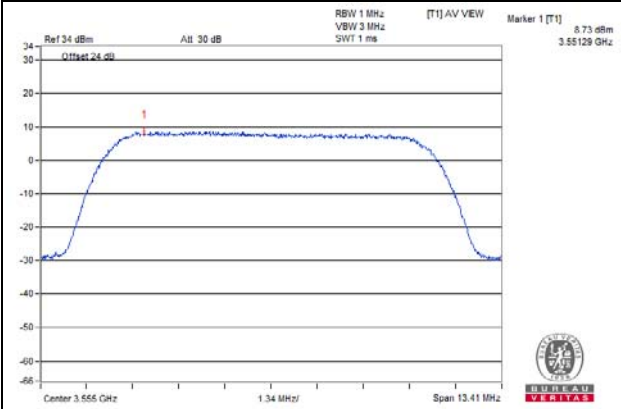

Middle

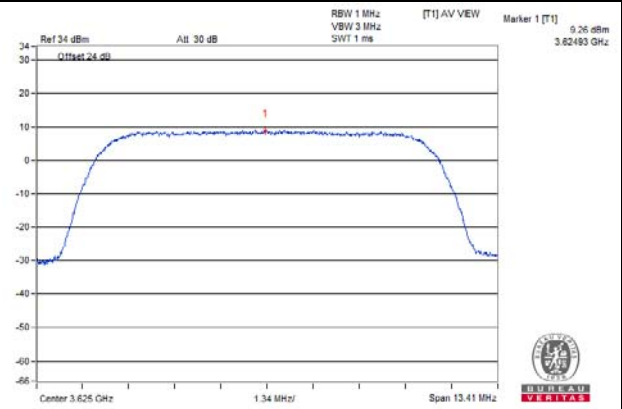

High

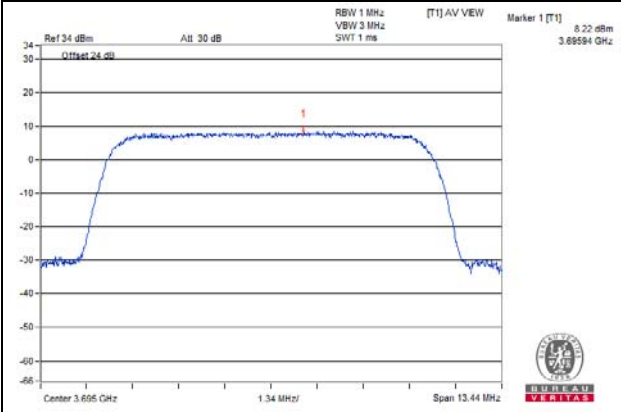

15MHz:

Spectrum Plot of Value

QPSK

Low

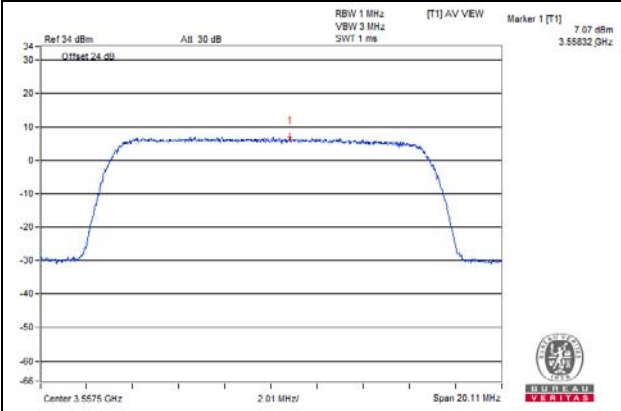

Middle

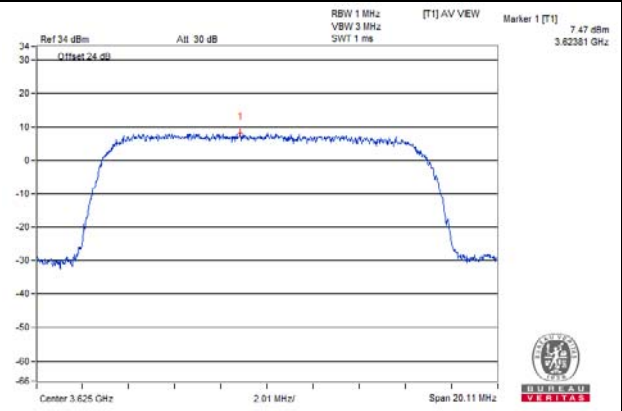

High

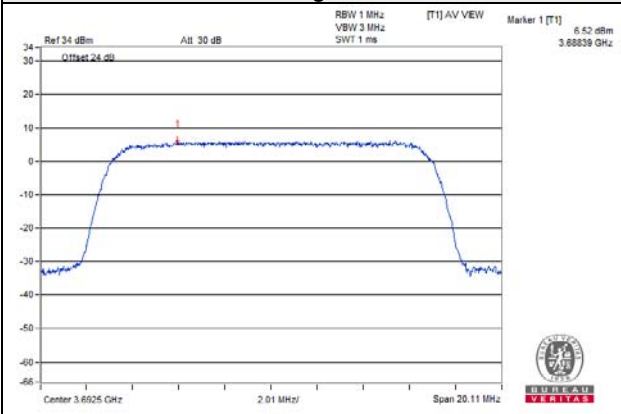

20MHz:

Spectrum Plot of Value

QPSK

Low

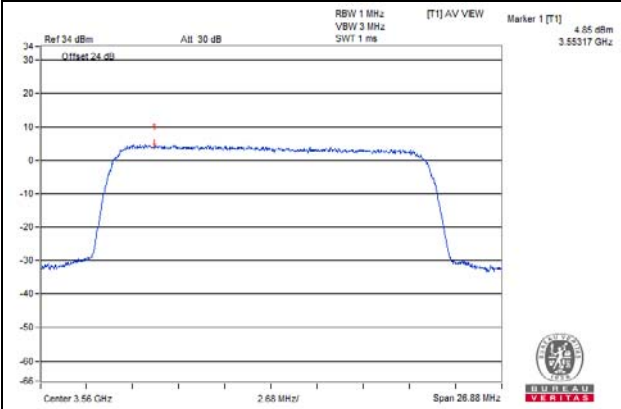

Middle

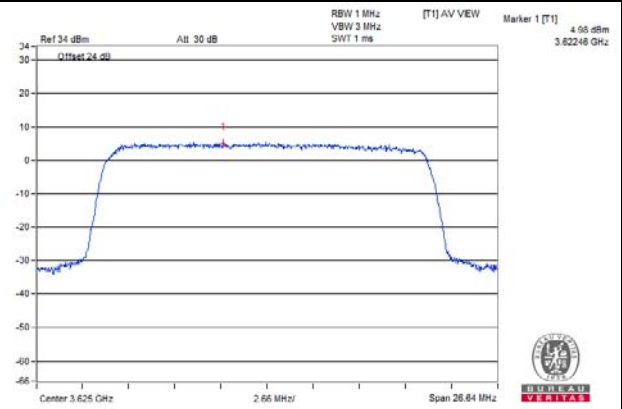

High

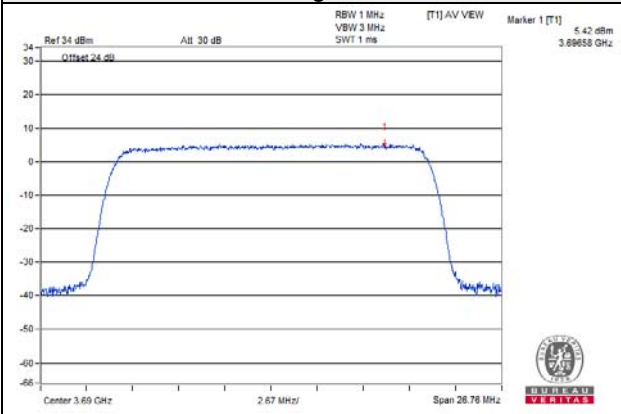

CA Contiguous
20MHz+20MHz:

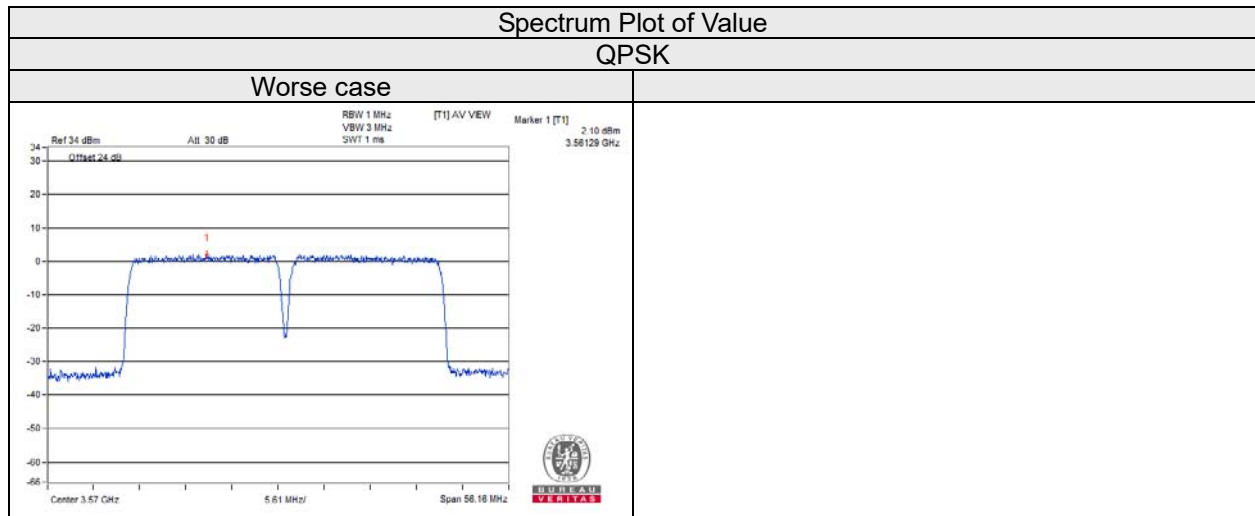

4.4 Frequency Stability Measurement

4.4.1 Limits of Frequency Stability Measurement

The frequency stability shall be sufficient to ensure that the fundamental emission stays within the authorized frequency band.

4.4.2 Test Procedure

- Device is placed at the oven room. The oven room could control the temperatures and humidity. Power warm up is at least 15 min and power applied should perform before recording frequency error.
- EUT is connected the external power supply to control the AC input power. The test voltage range is from minimum to maximum working voltage. Each step shall be record the frequency error rate.
- The temperature range step is 10 degrees in this test items. All temperature levels shall be hold the $\pm 0.5^{\circ}\text{C}$ during the measurement testing. The each temperature step shall be at least 0.5 hours, consider the EUT could be test under the stability condition.

NOTE: The frequency error was recorded frequency error from the communication simulator.

4.4.3 Test Instruments

Refer to section 4.1.3 to get information of above instrument.

4.4.4 Test Setup

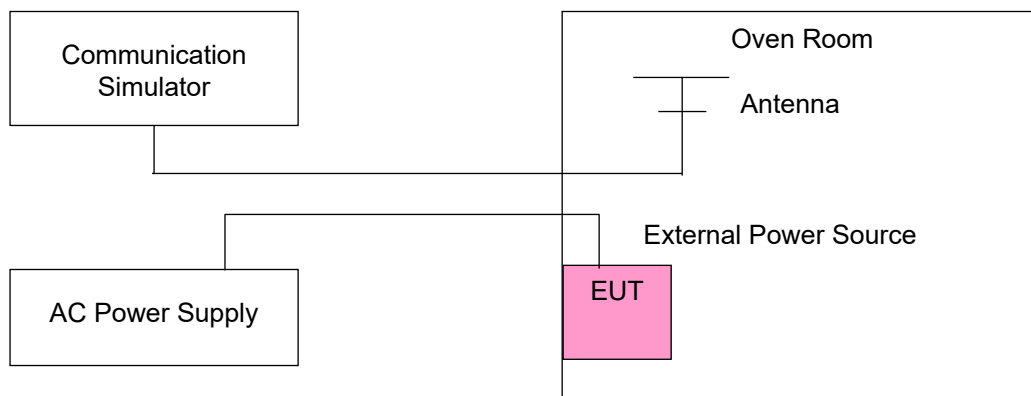

4.4.5 Test Results

Single Carrier

Frequency Error vs. Voltage

Frequency Error vs. Voltage									
Voltage (Volts)	Test result								PASS /FAIL
	5MHz (MHz)	(ppm)	10MHz (MHz)	(ppm)	15MHz (MHz)	(ppm)	20MHz (MHz)	(ppm)	
102	3624.999986	-0.0039	3625.000001	0.0003	3624.999985	-0.0041	3624.999991	-0.0025	PASS
138	3625.000011	0.0030	3625.000019	0.0052	3625.000008	0.0022	3624.999985	-0.0041	PASS

Frequency Error vs. Temperature

Frequency Error vs. Temperature									
TEMP. (°C)	Test result								PASS /FAIL
	5MHz (MHz)	(ppm)	10MHz (MHz)	(ppm)	15MHz (MHz)	(ppm)	20MHz (MHz)	(ppm)	
75	3625.000011	0.0030	3625.000002	0.0006	3624.999997	-0.0008	3624.999994	-0.0017	PASS
70	3624.999996	-0.0011	3624.999993	-0.0019	3625.000007	0.0019	3625.000005	0.0014	PASS
60	3625.000016	0.0044	3624.999997	-0.0008	3625.000000	0.0000	3624.999983	-0.0047	PASS
50	3624.999991	-0.0025	3624.999981	-0.0052	3624.999984	-0.0044	3625.000017	0.0047	PASS
40	3624.999985	-0.0041	3625.000017	0.0047	3624.999996	-0.0011	3624.999990	-0.0028	PASS
30	3624.999999	-0.0003	3625.000007	0.0019	3625.000010	0.0028	3625.000016	0.0044	PASS
20	3624.999999	-0.0003	3625.000017	0.0047	3624.999999	-0.0003	3624.999999	-0.0003	PASS
10	3624.999992	-0.0022	3625.000006	0.0017	3624.999995	-0.0014	3625.000001	0.0003	PASS
0	3625.000007	0.0019	3625.000014	0.0039	3625.000015	0.0041	3624.999980	-0.0055	PASS
-10	3625.000016	0.0044	3625.000000	0.0000	3625.000003	0.0008	3625.000016	0.0044	PASS
-20	3625.000019	0.0052	3625.000014	0.0039	3624.999999	-0.0003	3624.999981	-0.0052	PASS
-30	3625.000006	0.0017	3625.000003	0.0008	3624.999990	-0.0028	3625.000002	0.0006	PASS
-40	3624.999982	-0.0050	3624.999995	-0.0014	3624.999985	-0.0041	3624.999995	-0.0014	PASS

CA Contiguous

Frequency Error vs. Voltage

Frequency Error vs. Voltage					PASS/FAIL
Voltage (Volts)	Test result (MHz)				
	CA_20+20 MHz Low Carrier (MHz)	(ppm)	CA_20+20 MHz High Carrier (MHz)	(ppm)	
102	3560.000000	0.0000	3579.800005	0.0014	PASS
138	3560.000035	0.0098	3579.800015	0.0042	PASS

Frequency Error vs. Temperature

Frequency Error vs. Temperature					PASS/FAIL
Temp. (°C)	Test result (MHz)				
	CA_20+20 MHz Low Carrier (MHz)	(ppm)	CA_20+20 MHz High Carrier (MHz)	(ppm)	
60	3560.000003	0.0008	3579.799988	-0.0034	PASS
50	3560.000019	0.0053	3579.799980	-0.0056	PASS
40	3560.000030	0.0084	3579.799985	-0.0042	PASS
30	3560.000013	0.0037	3579.800002	0.0006	PASS
20	3560.000041	0.0115	3579.799993	-0.0020	PASS
10	3560.000028	0.0079	3579.799991	-0.0025	PASS
0	3560.000015	0.0042	3579.799992	-0.0022	PASS
-10	3560.000024	0.0067	3579.800003	0.0008	PASS
-20	3560.000050	0.0140	3579.799999	-0.0003	PASS
-30	3560.000054	0.0152	3579.800019	0.0053	PASS
-40	3560.000024	0.0067	3579.799989	-0.0031	PASS

4.5 Emission Bandwidth Measurement

4.5.1 Limit of Emission Bandwidth Measurement

Reference only

4.5.2 Test Setup

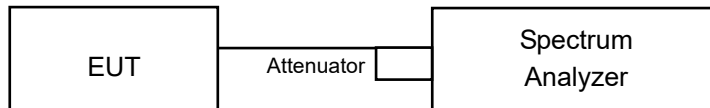

4.5.3 Test Instruments

Refer to section 4.1.3 to get information of above instrument.

4.5.4 Test Procedure

Occupied Bandwidth:

All measurements were done at low, middle and high operational frequency range. The communication simulator station system controlled a EUT to export maximum output power under transmission mode and specific channel frequency. Use OBW measurement function of Spectrum analyzer to measure 99 % occupied bandwidth.

26dBc Bandwidth:

The transmitter output was connected to the spectrum analyzer through an attenuator. The bandwidth of the fundamental frequency was measured by spectrum analyzer with RBW = 1-5% of the OBW. The emission bandwidth is defined as the width of the signal between two points, one below the carrier center frequency and one above the carrier center frequency, outside of which all emissions are attenuated at least 26 dB below the transmitter power.

4.5.5 Deviation from Test Standard

No deviation.

4.5.6 EUT Operating Conditions

The software provided by client to enable the EUT under transmission condition continuously at lowest, middle and highest channel frequencies individually.

4.5.7 Test Result (-26dB Bandwidth)

Single Carrier

Channel	Freq. (MHz)	26dB Down Bandwidth (MHz)		
		5MHz		
		QPSK	16QAM	64QAM
Low	3552.5	4.85	4.88	4.85
Middle	3625	4.77	4.76	4.81
High	3697.5	4.79	4.78	4.84

Channel	Freq. (MHz)	26dB Down Bandwidth (MHz)		
		10MHz		
		QPSK	16QAM	64QAM
Low	3555	9.66	9.69	9.68
Middle	3625	9.50	9.45	9.51
High	3695	9.52	9.48	9.55

Channel	Freq. (MHz)	26dB Down Bandwidth (MHz)		
		15MHz		
		QPSK	16QAM	64QAM
Low	3557.5	14.45	14.48	14.45
Middle	3625	14.19	14.18	14.18
High	3692.5	14.21	14.29	14.20

Channel	Freq. (MHz)	26dB Down Bandwidth (MHz)		
		20MHz		
		QPSK	16QAM	64QAM
Low	3560	19.05	19.16	19.27
Middle	3625	18.82	19.00	18.77
High	3690	18.87	18.74	18.74

CA Contiguous

Channel	Freq. (MHz)	26dB Down Bandwidth (MHz)		
		20MHz+20MHz		
		QPSK	16QAM	64QAM
Worst case	3560+3579.8	38.75	38.87	38.70

5MHz:

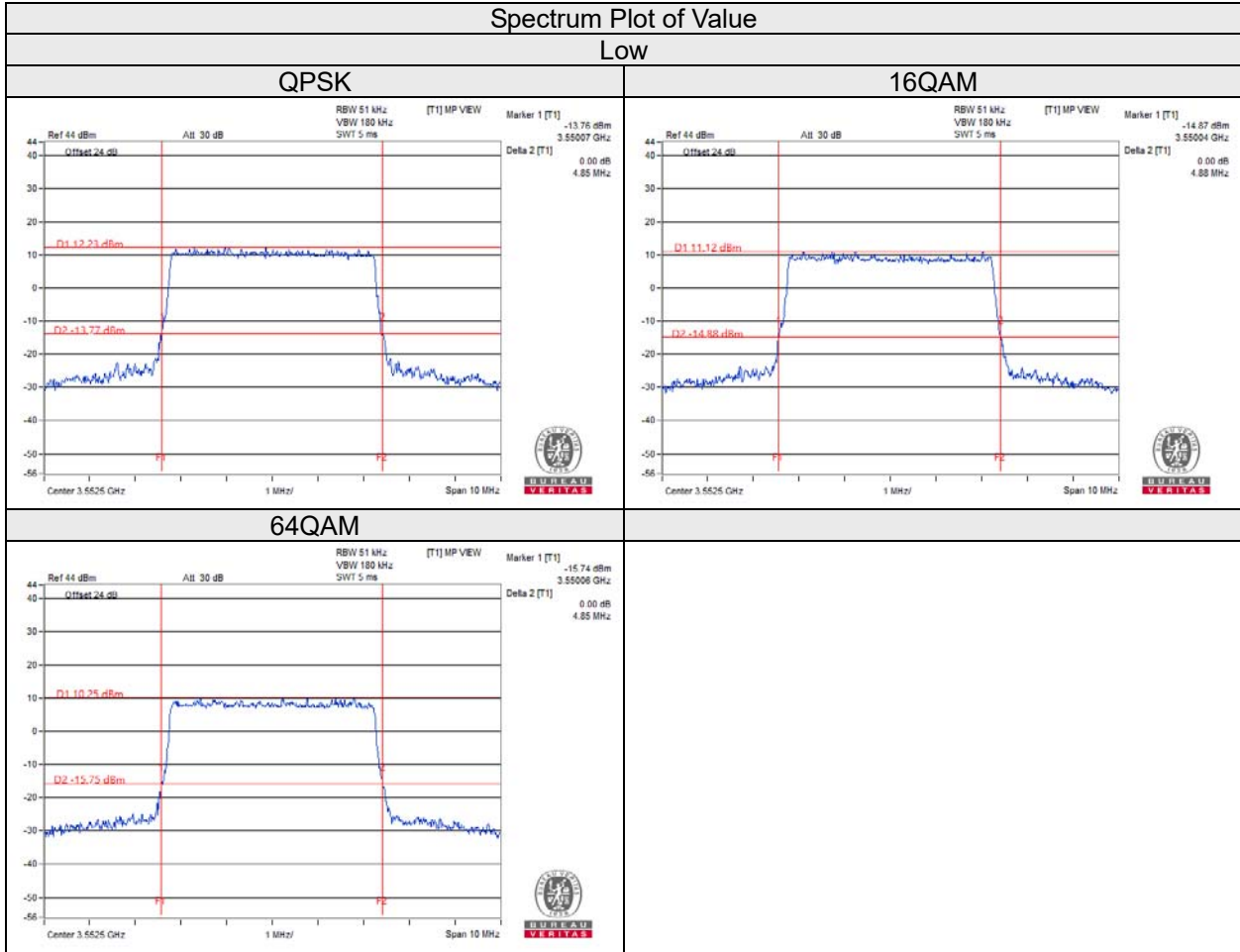

Spectrum Plot of Value

Middle

QPSK

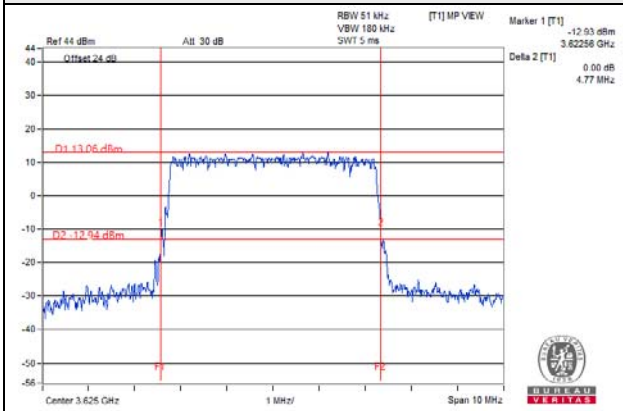

16QAM

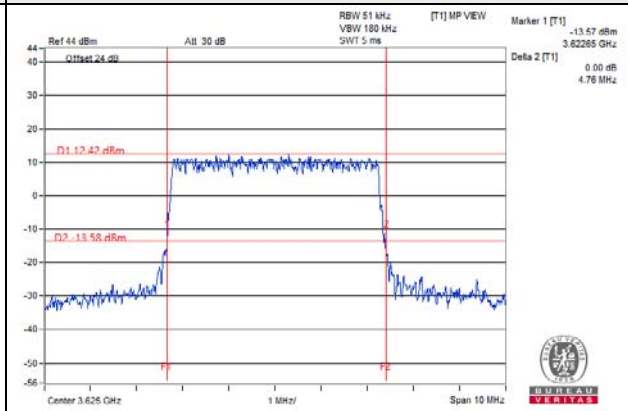

64QAM

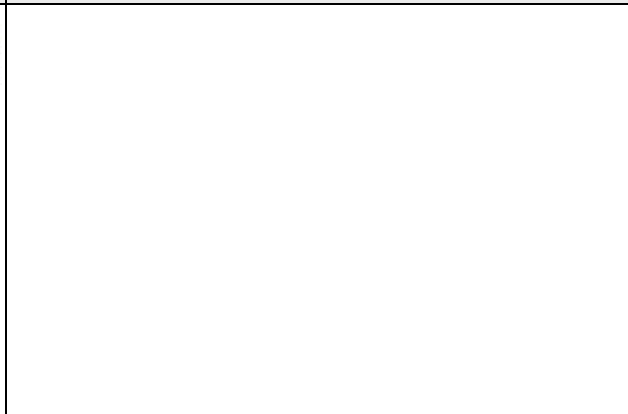
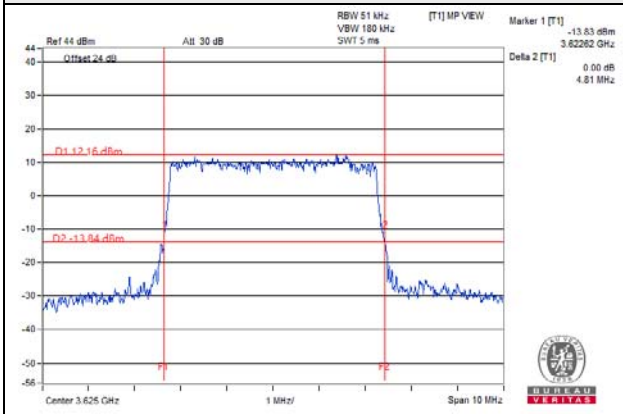

Spectrum Plot of Value

High

QPSK

16QAM

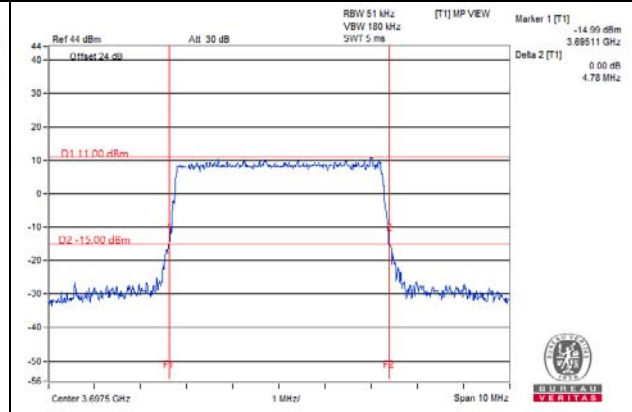
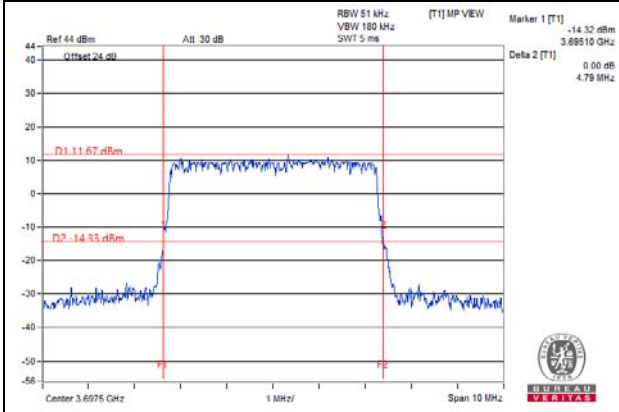

64QAM

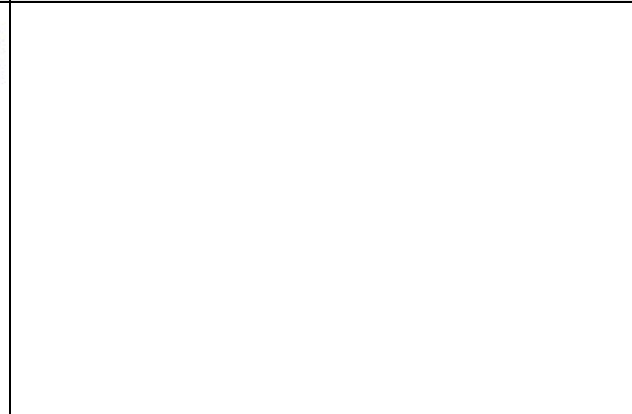
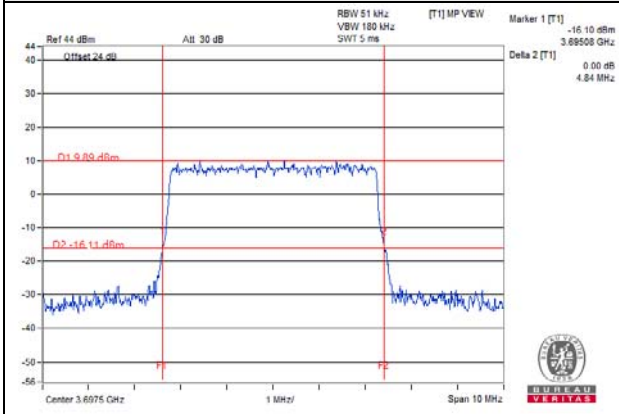

10MHz:

Spectrum Plot of Value

Low

QPSK

16QAM

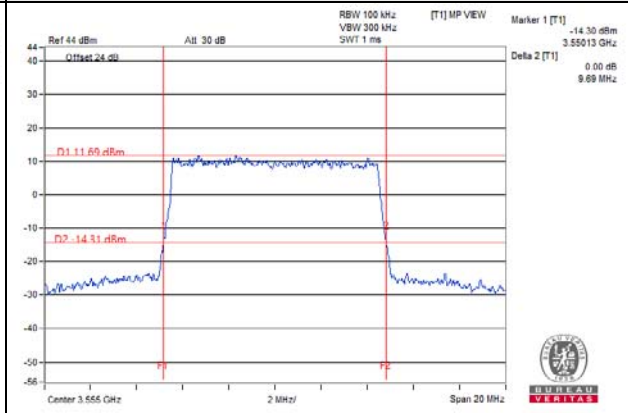
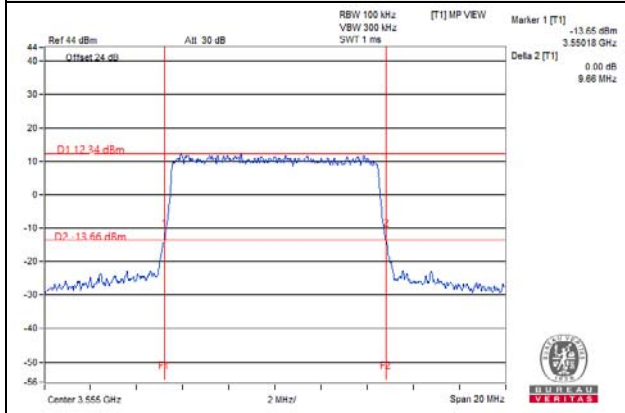

64QAM

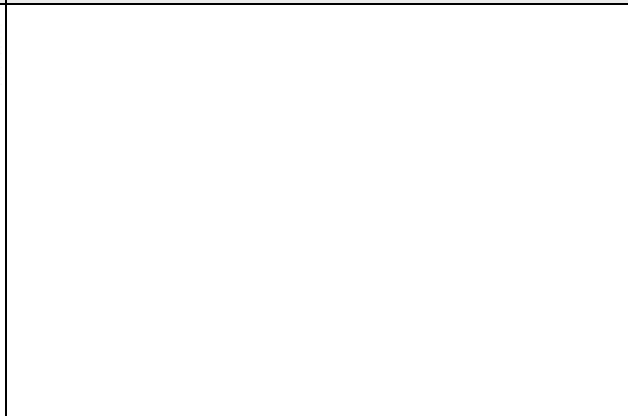
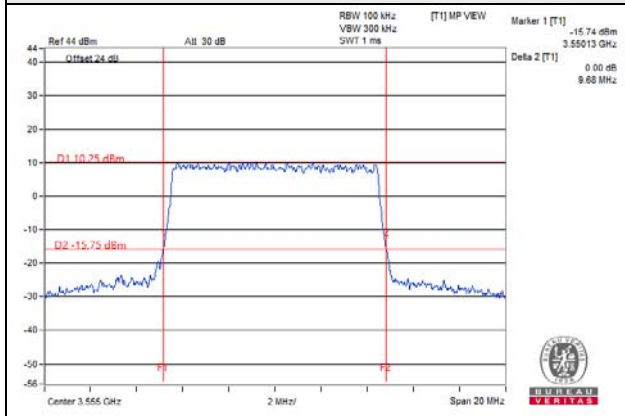

Spectrum Plot of Value
Middle

QPSK

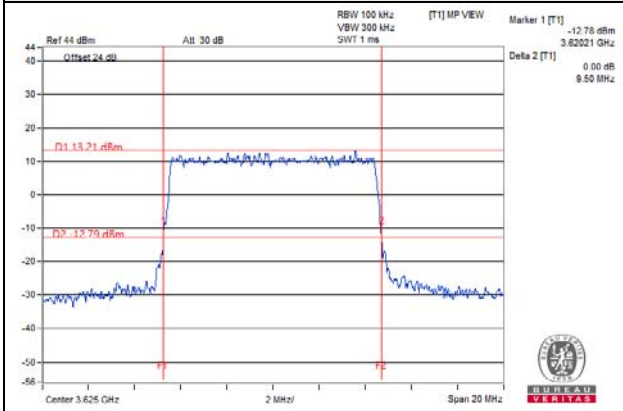

16QAM

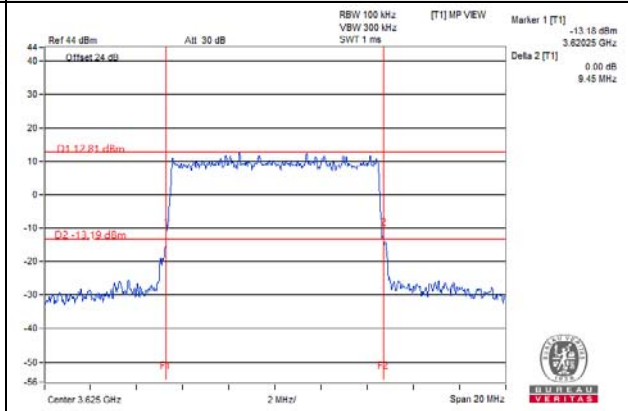

64QAM

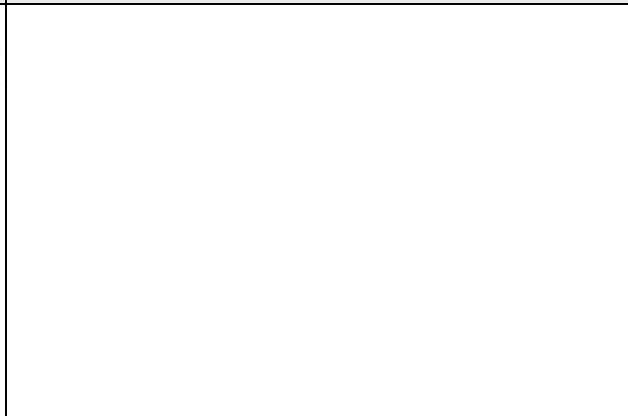
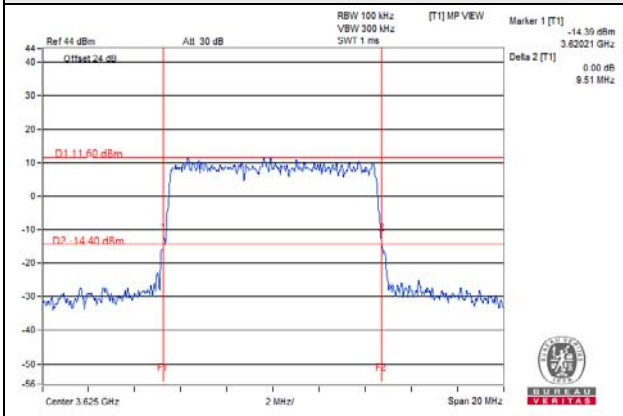

Spectrum Plot of Value

High

QPSK

16QAM

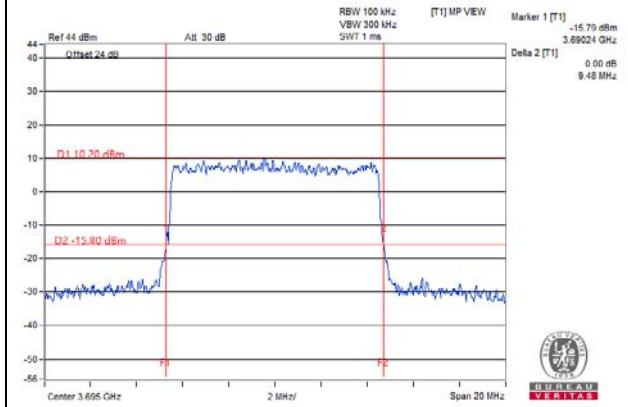
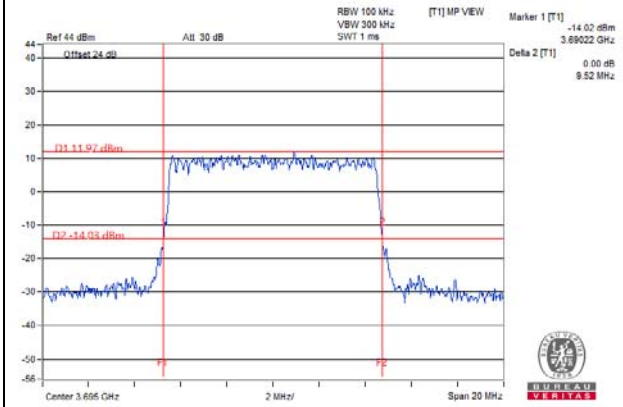

64QAM

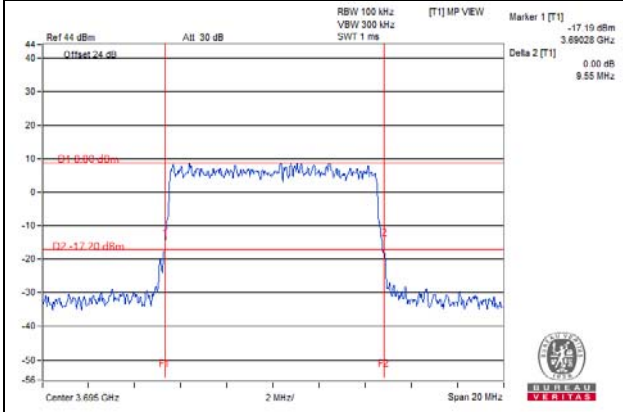

15MHz:

Spectrum Plot of Value

Low

QPSK

16QAM

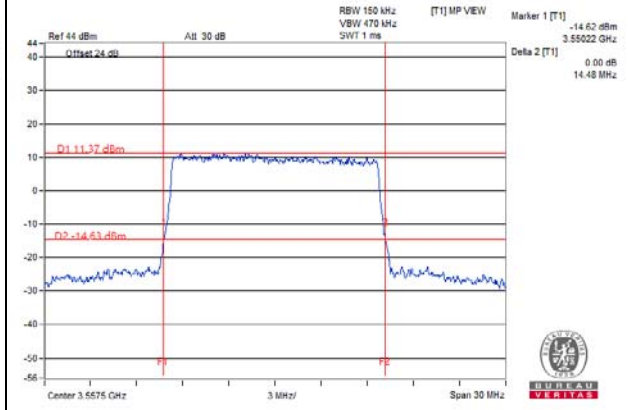
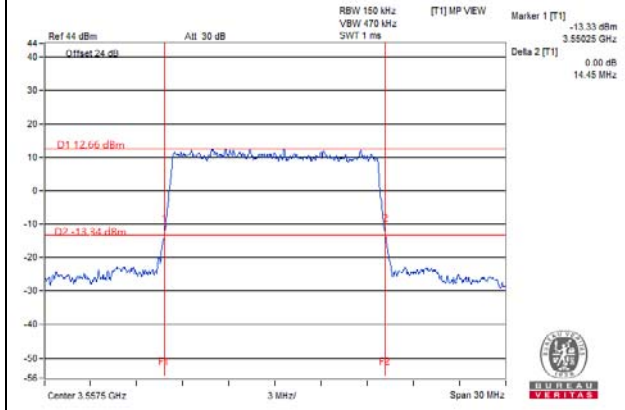

64QAM

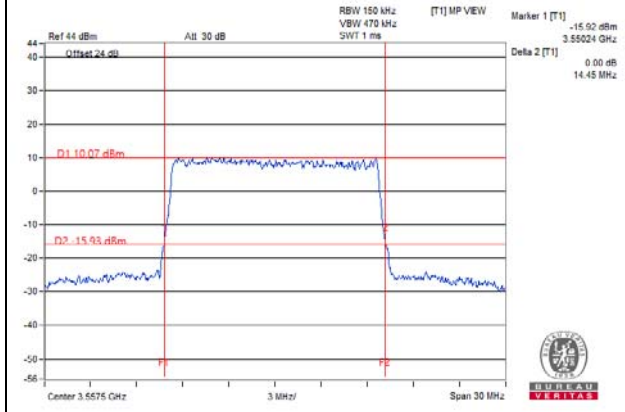

Spectrum Plot of Value
Middle

QPSK

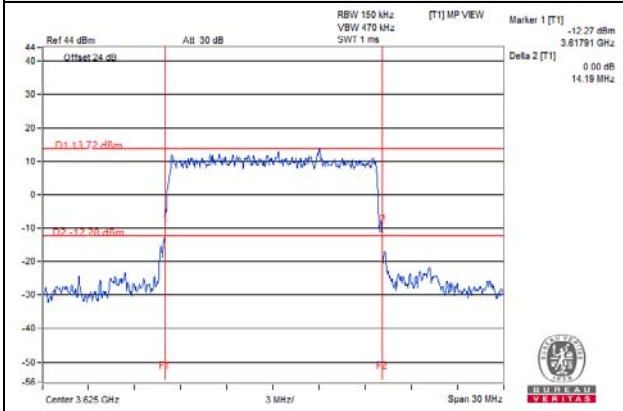

16QAM

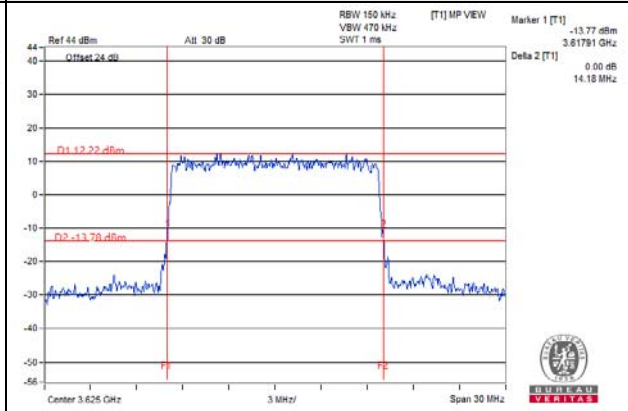

64QAM

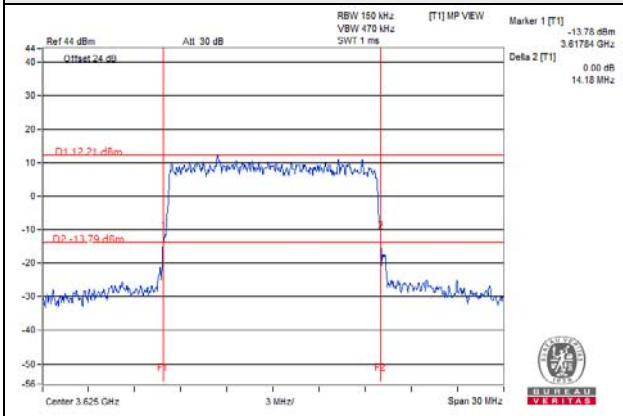

Spectrum Plot of Value

High

QPSK

16QAM

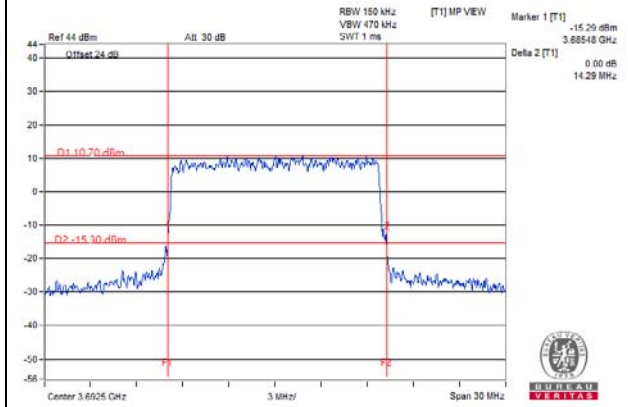
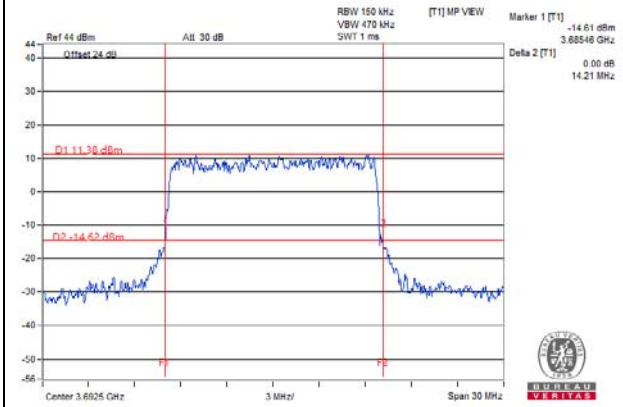

64QAM

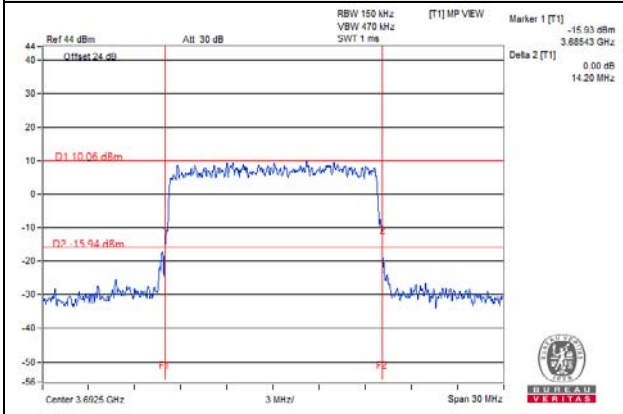

20MHz:

Spectrum Plot of Value

Low

QPSK

16QAM

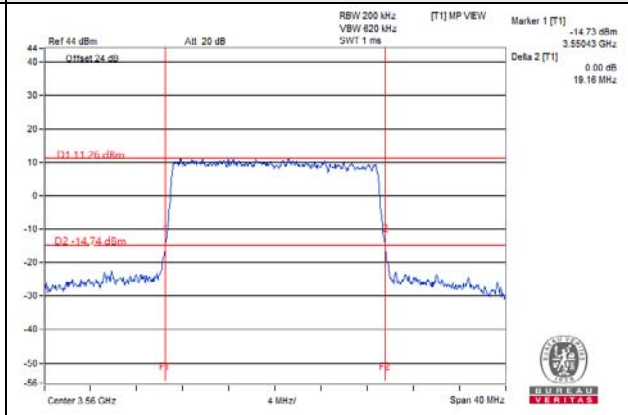
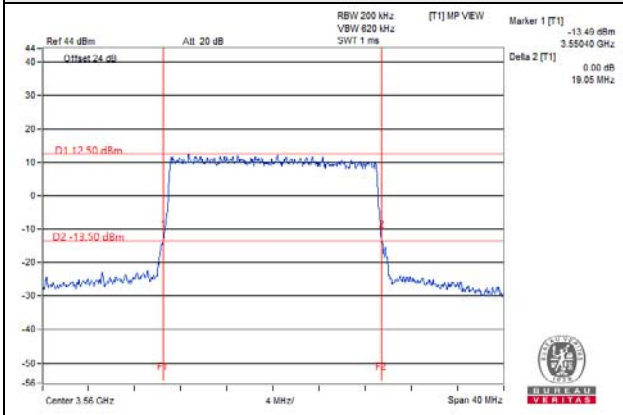

64QAM

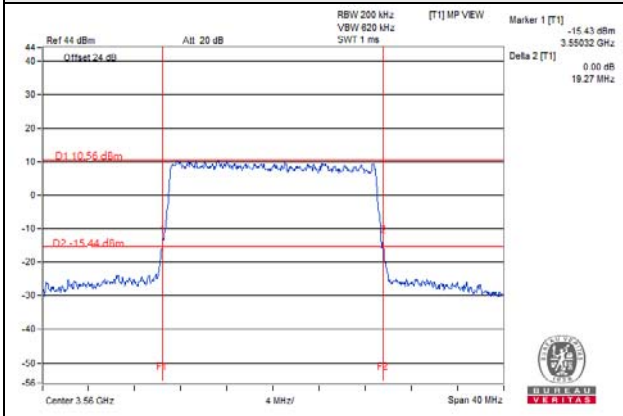

**Spectrum Plot of Value
Middle**

QPSK

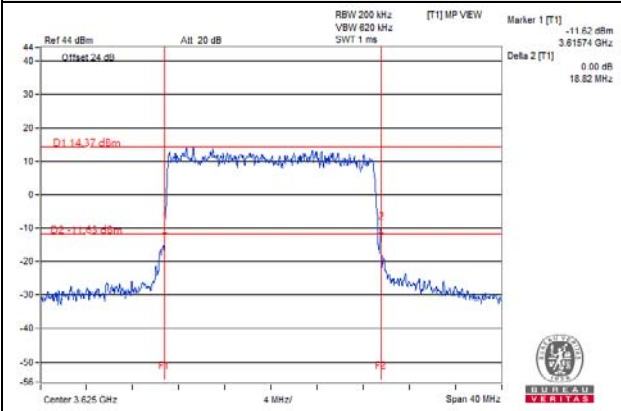

16QAM

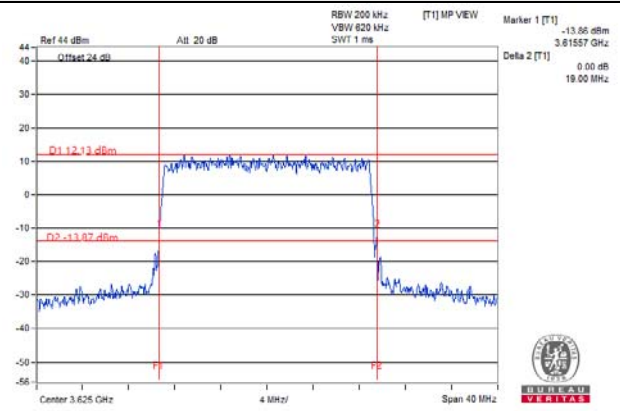

64QAM

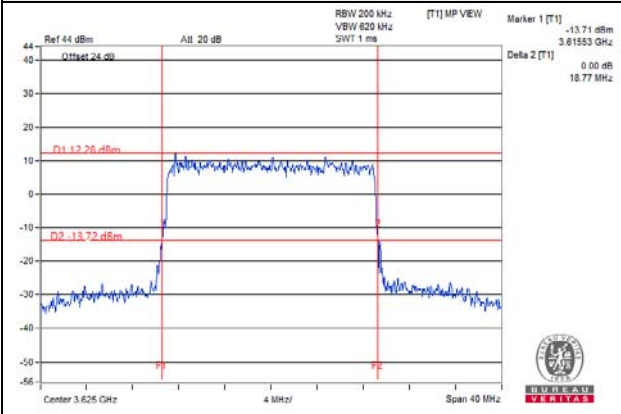

Spectrum Plot of Value

High

QPSK

16QAM

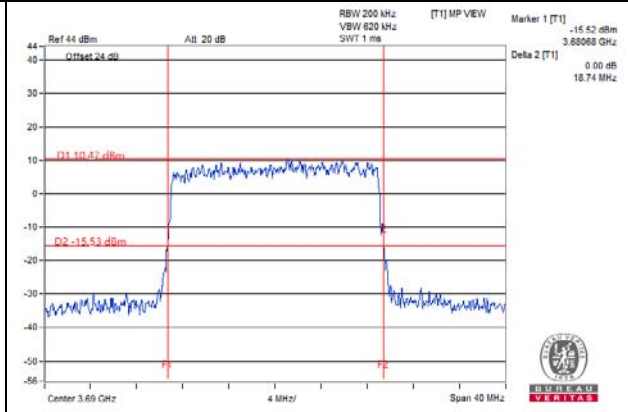
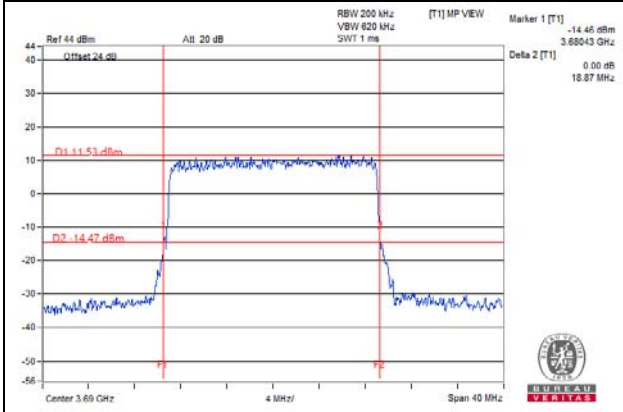

64QAM

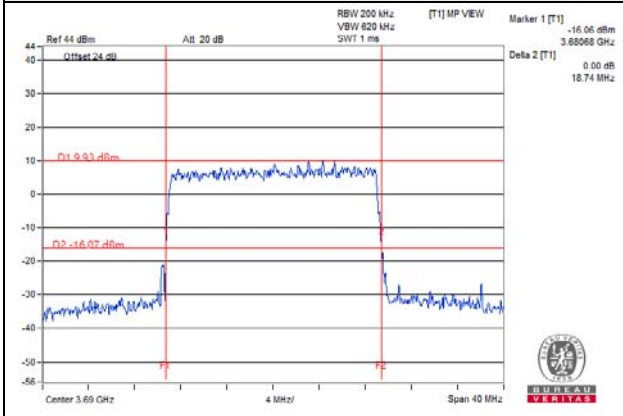

20MHz+20MHz:

Spectrum Plot of Value

Worst case

QPSK

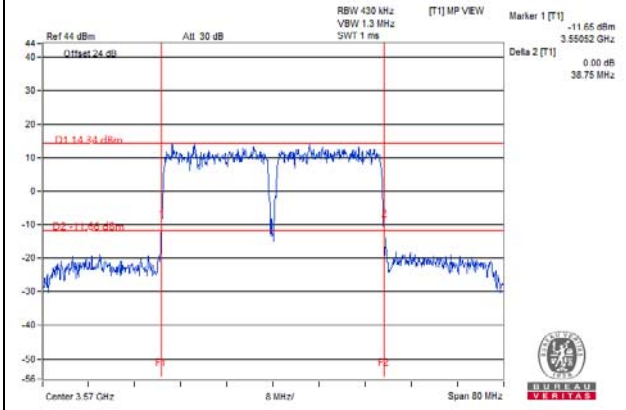

16QAM

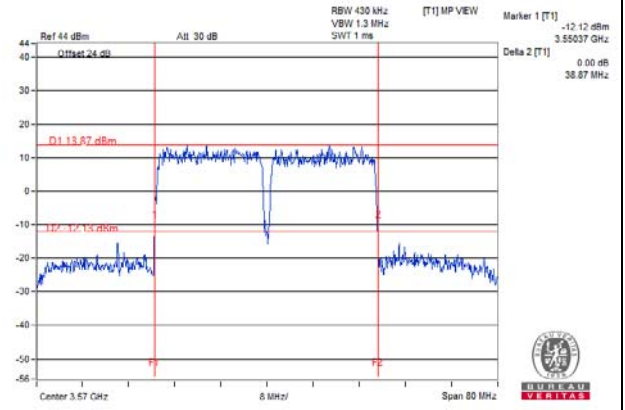

64QAM

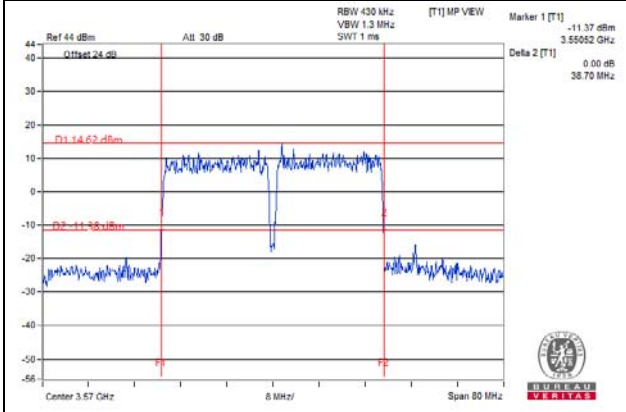

4.5.8 Test Result (Occupied Bandwidth)

Single Carrier

Channel	Freq. (MHz)	OCP 99 Band Width (MHz)		
		5MHz		
		QPSK	16QAM	64QAM
Low	3552.5	4.47	4.46	4.48
Middle	3625	4.46	4.47	4.45
High	3697.5	4.45	4.48	4.47

Channel	Freq. (MHz)	OCP 99 Band Width (MHz)		
		10MHz		
		QPSK	16QAM	64QAM
Low	3555	8.94	8.94	8.94
Middle	3625	8.94	8.96	8.96
High	3695	8.96	8.94	8.94

Channel	Freq. (MHz)	OCP 99 Band Width (MHz)		
		15MHz		
		QPSK	16QAM	64QAM
Low	3557.5	13.41	13.38	13.41
Middle	3625	13.41	13.38	13.44
High	3692.5	13.41	13.41	13.41

Channel	Freq. (MHz)	OCP 99 Band Width (MHz)		
		20MHz		
		QPSK	16QAM	64QAM
Low	3560	17.92	17.84	17.88
Middle	3625	17.76	17.84	17.88
High	3690	17.84	17.80	17.80

CA Contiguous

Channel	Freq. (MHz)	OCP 99 Band Width (MHz)		
		20MHz+20MHz		
		QPSK	16QAM	64QAM
Worst case	3600+3579.8	37.44	37.52	37.20

5MHz:

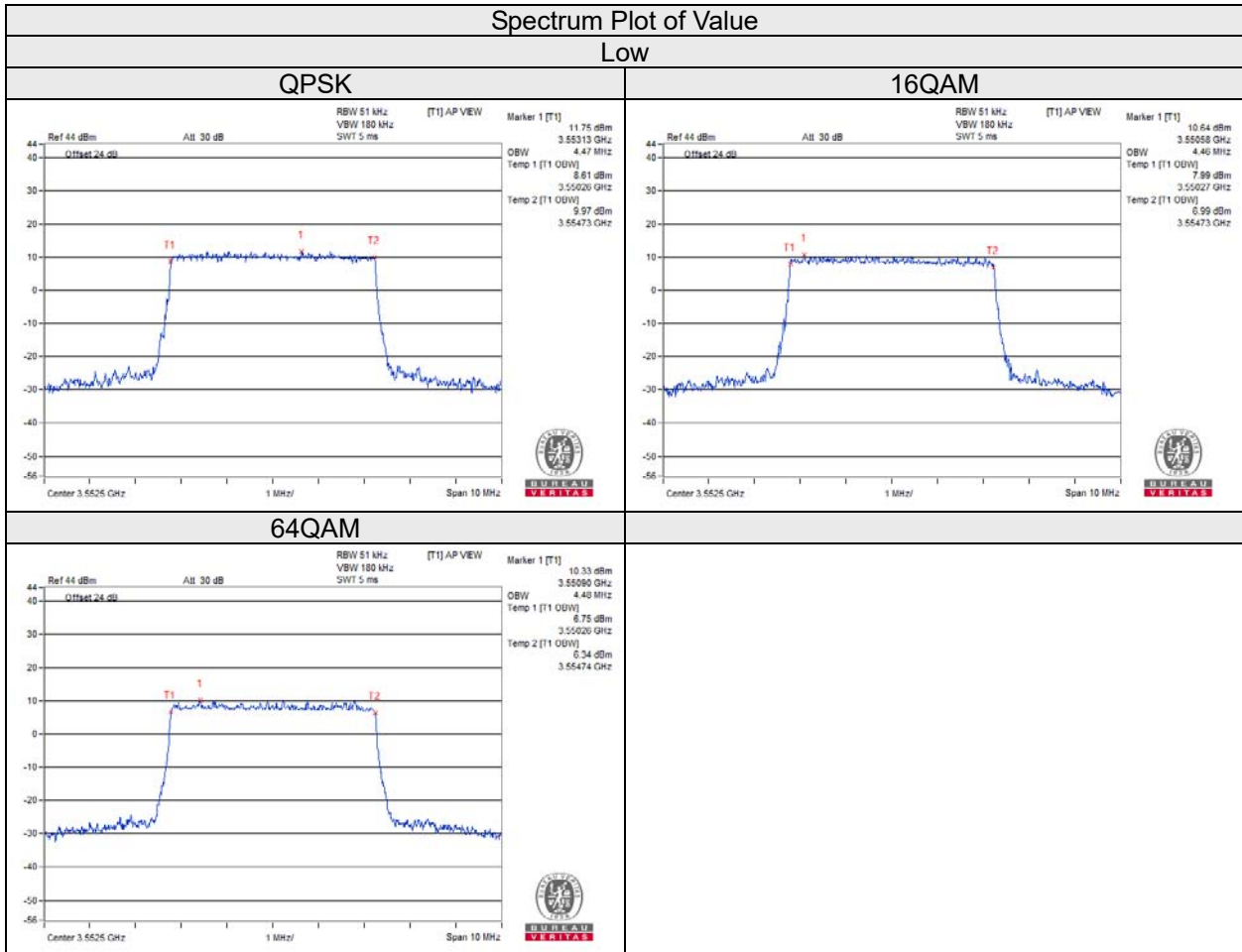

Spectrum Plot of Value
Middle

QPSK

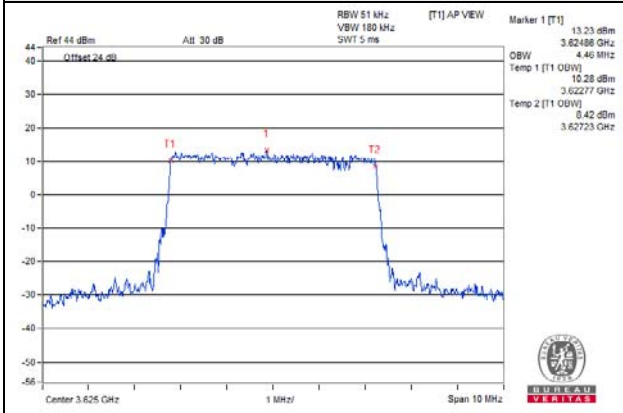

16QAM

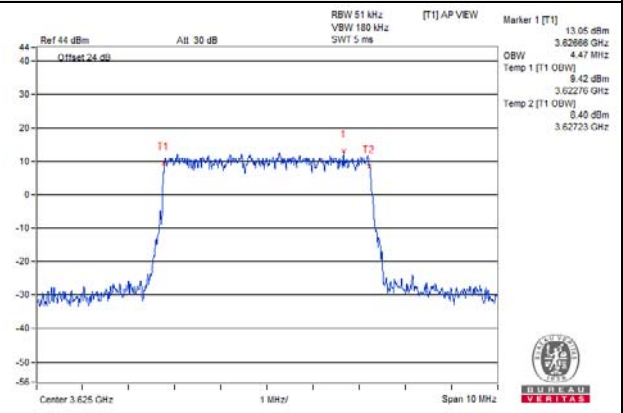

64QAM

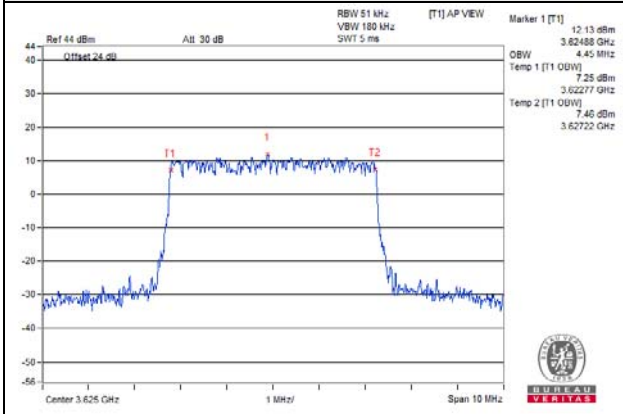

Spectrum Plot of Value

High

QPSK

16QAM

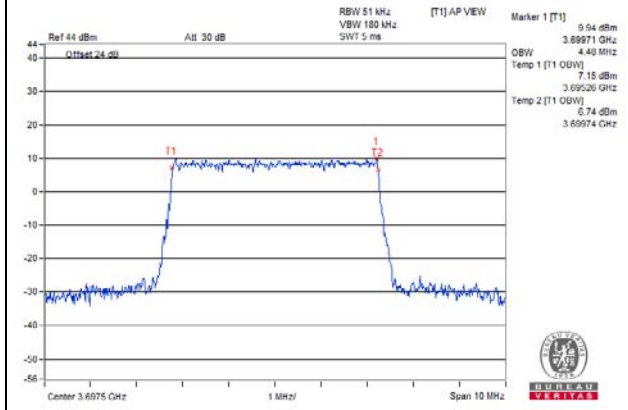
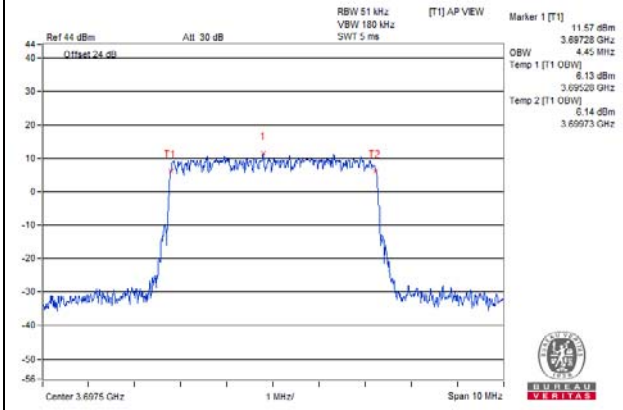

64QAM

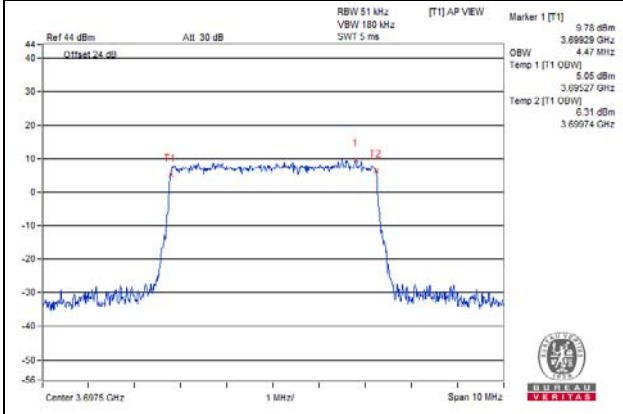

10MHz:

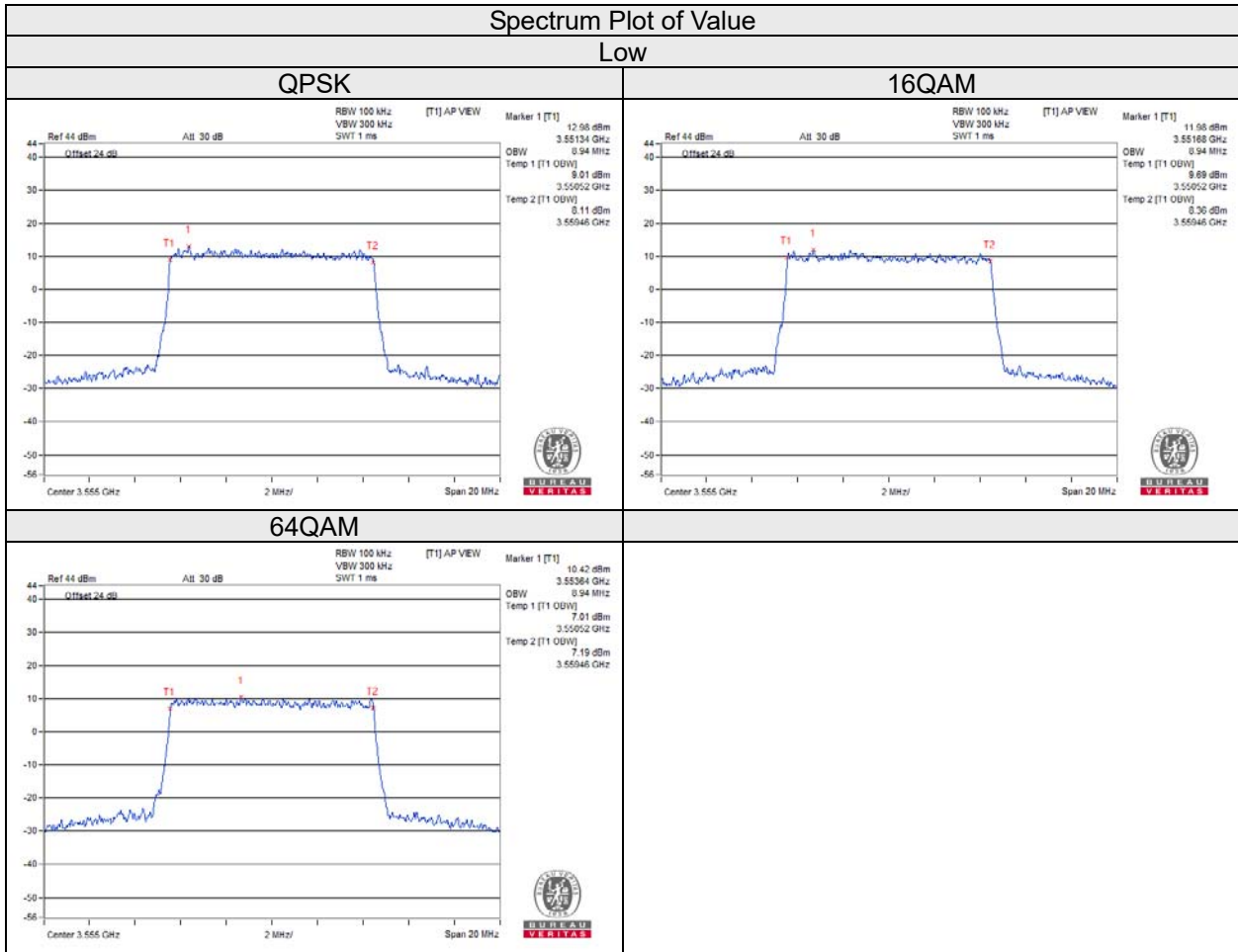

Spectrum Plot of Value
Middle

QPSK

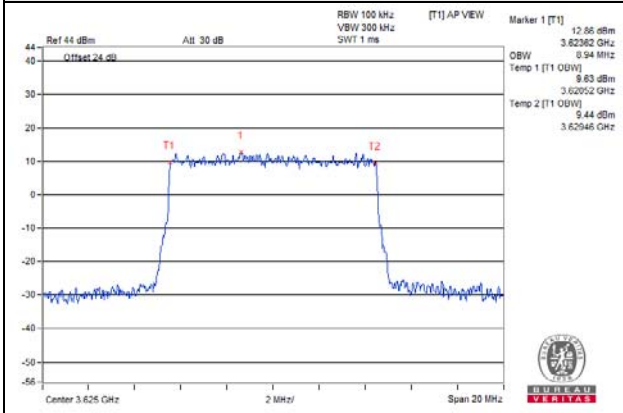

16QAM

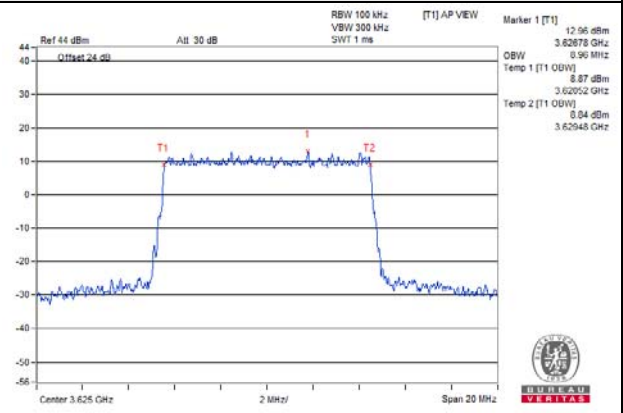

64QAM

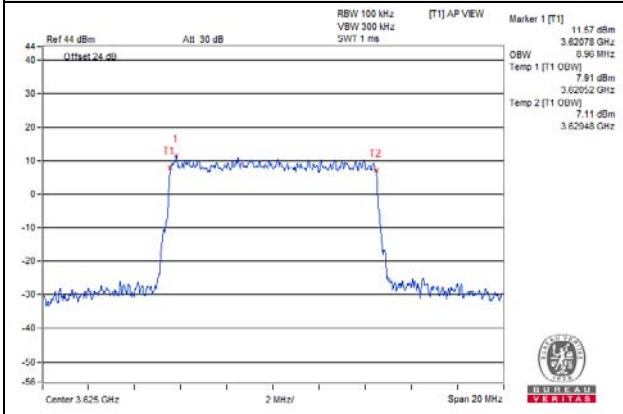

Spectrum Plot of Value

High

QPSK

16QAM

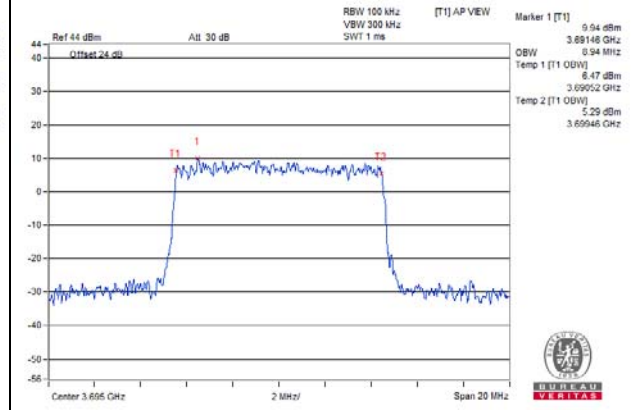
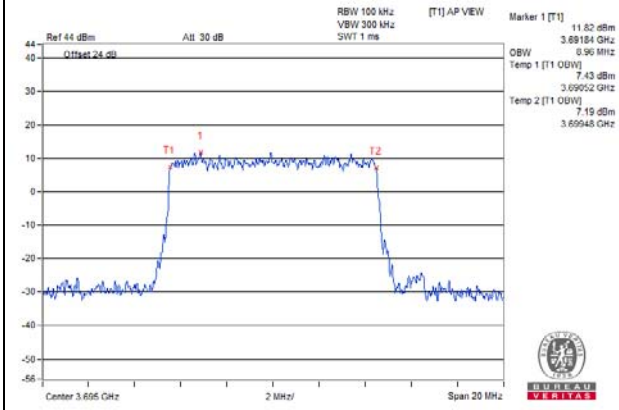

64QAM

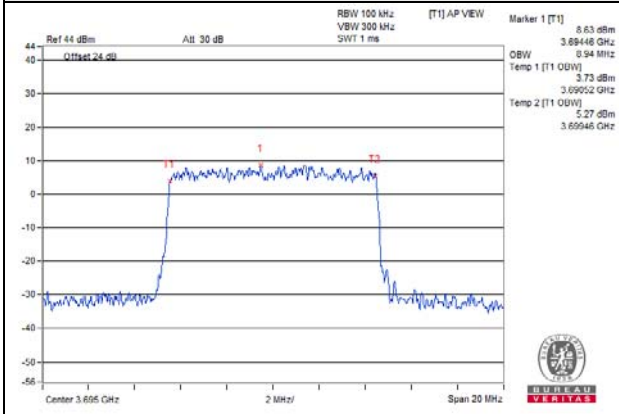

15MHz:

Spectrum Plot of Value

Low

QPSK

16QAM

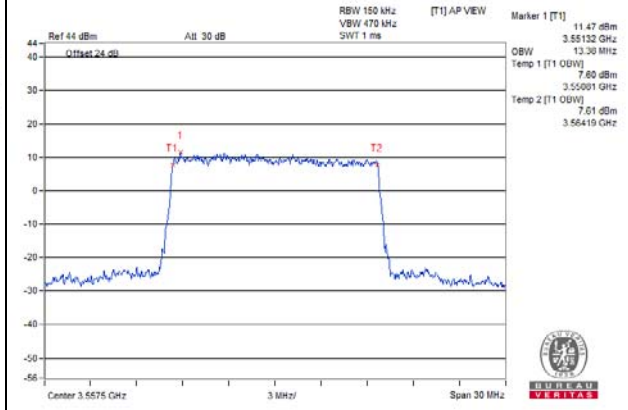
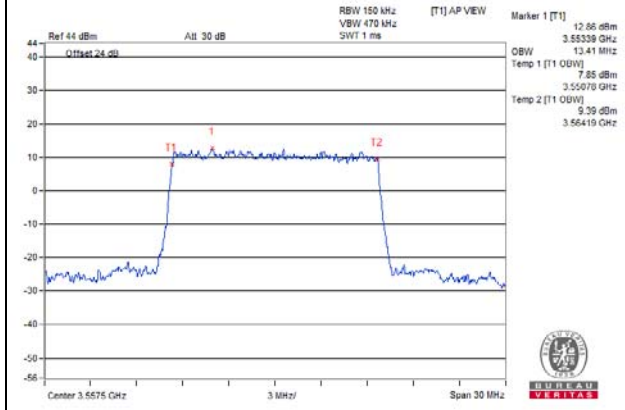

64QAM

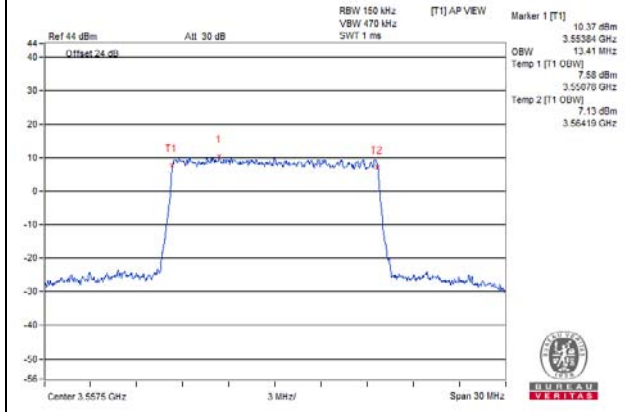

Spectrum Plot of Value Middle

QPSK

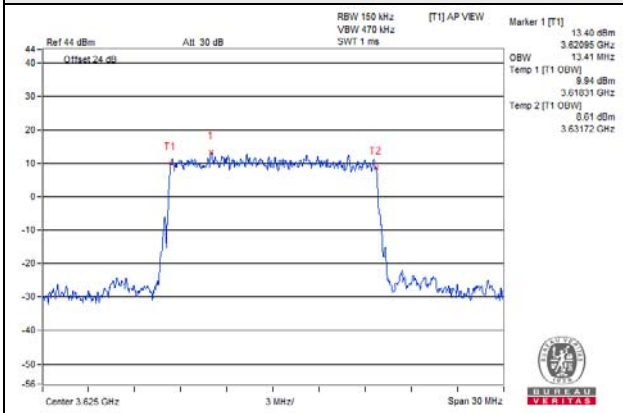

16QAM

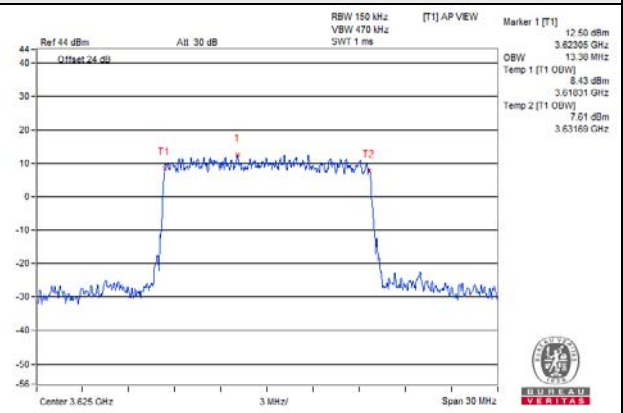

64QAM

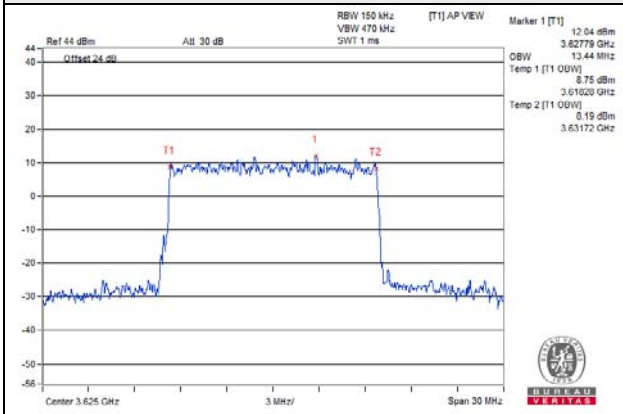

Spectrum Plot of Value High

QPSK

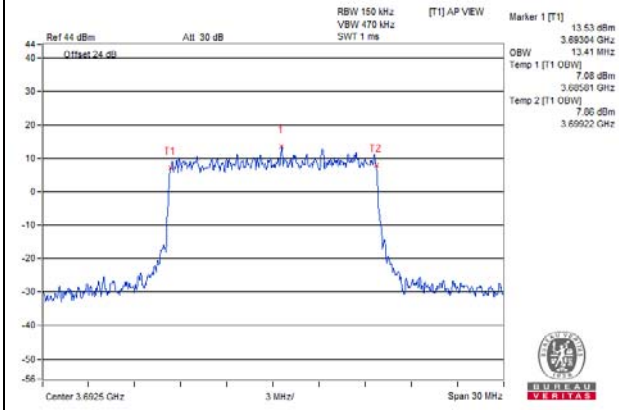

16QAM

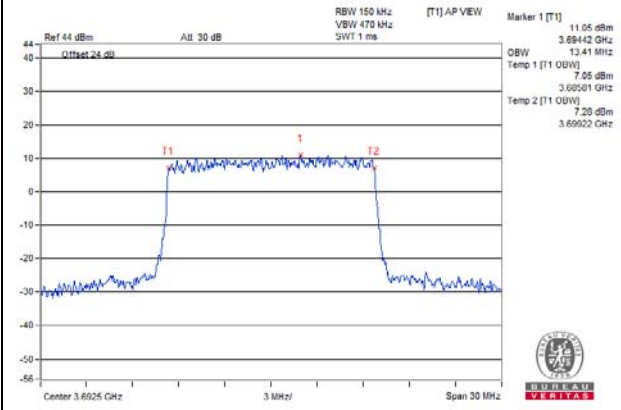

64QAM

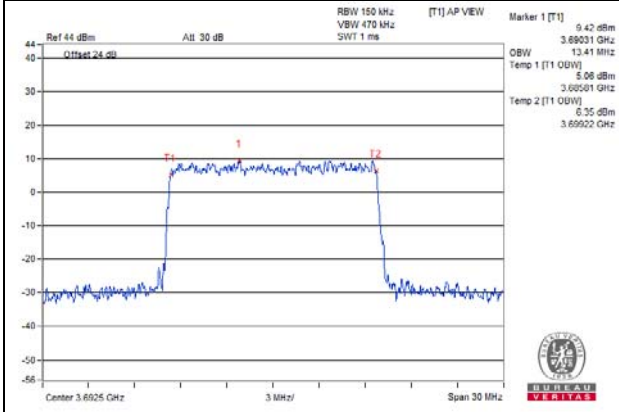

20MHz:

Spectrum Plot of Value

Low

QPSK

16QAM

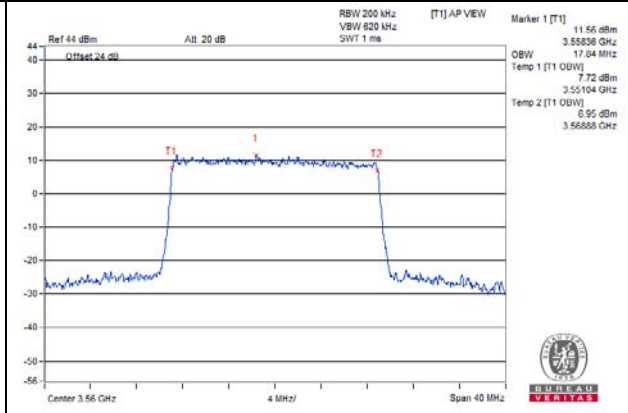
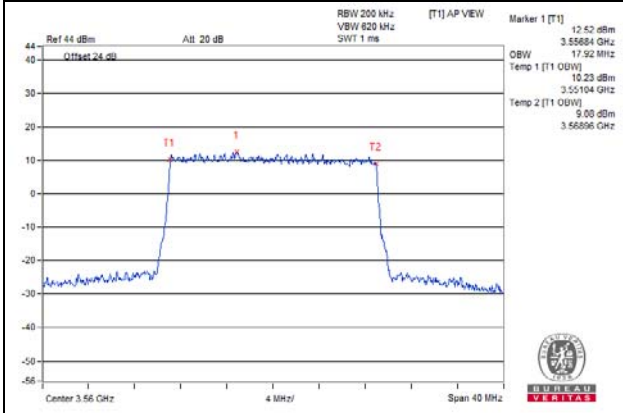

64QAM

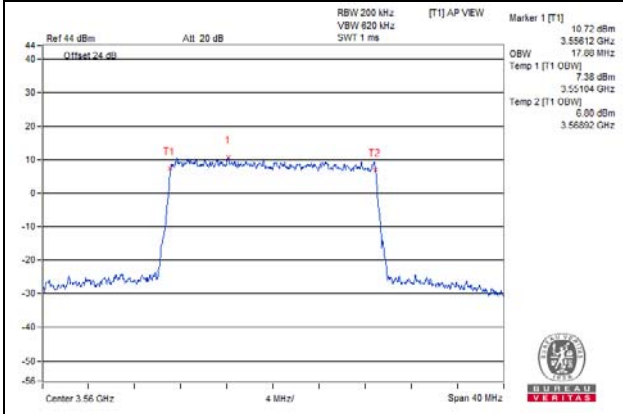

Spectrum Plot of Value
Middle

QPSK

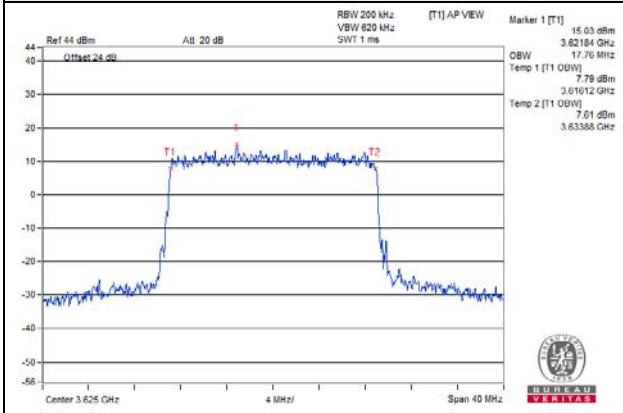

16QAM

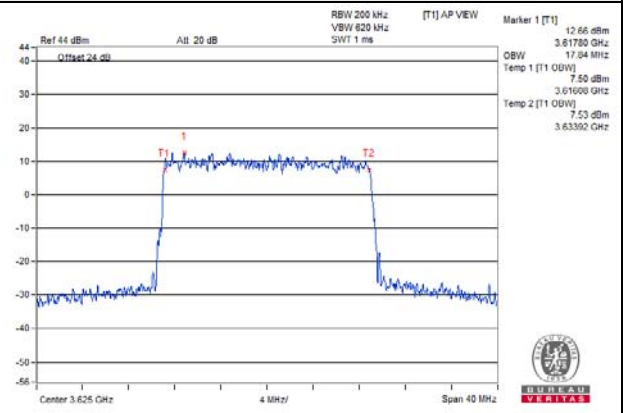

64QAM

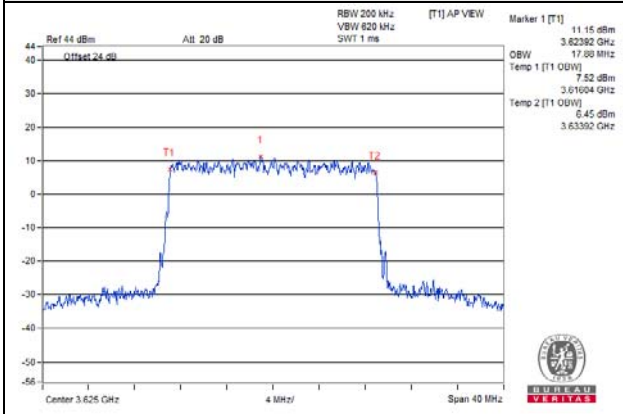

Spectrum Plot of Value

High

QPSK

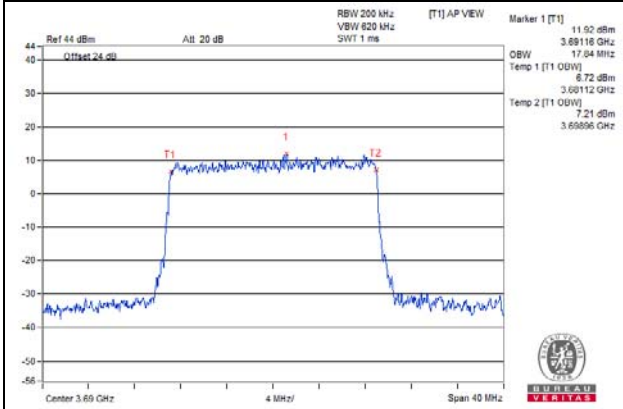

16QAM

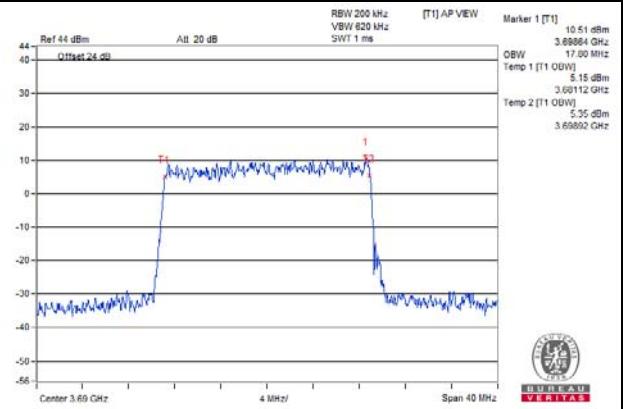

64QAM

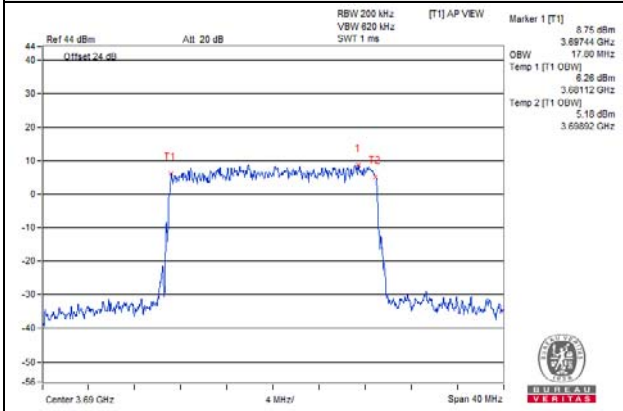

20MHz+20MHz:

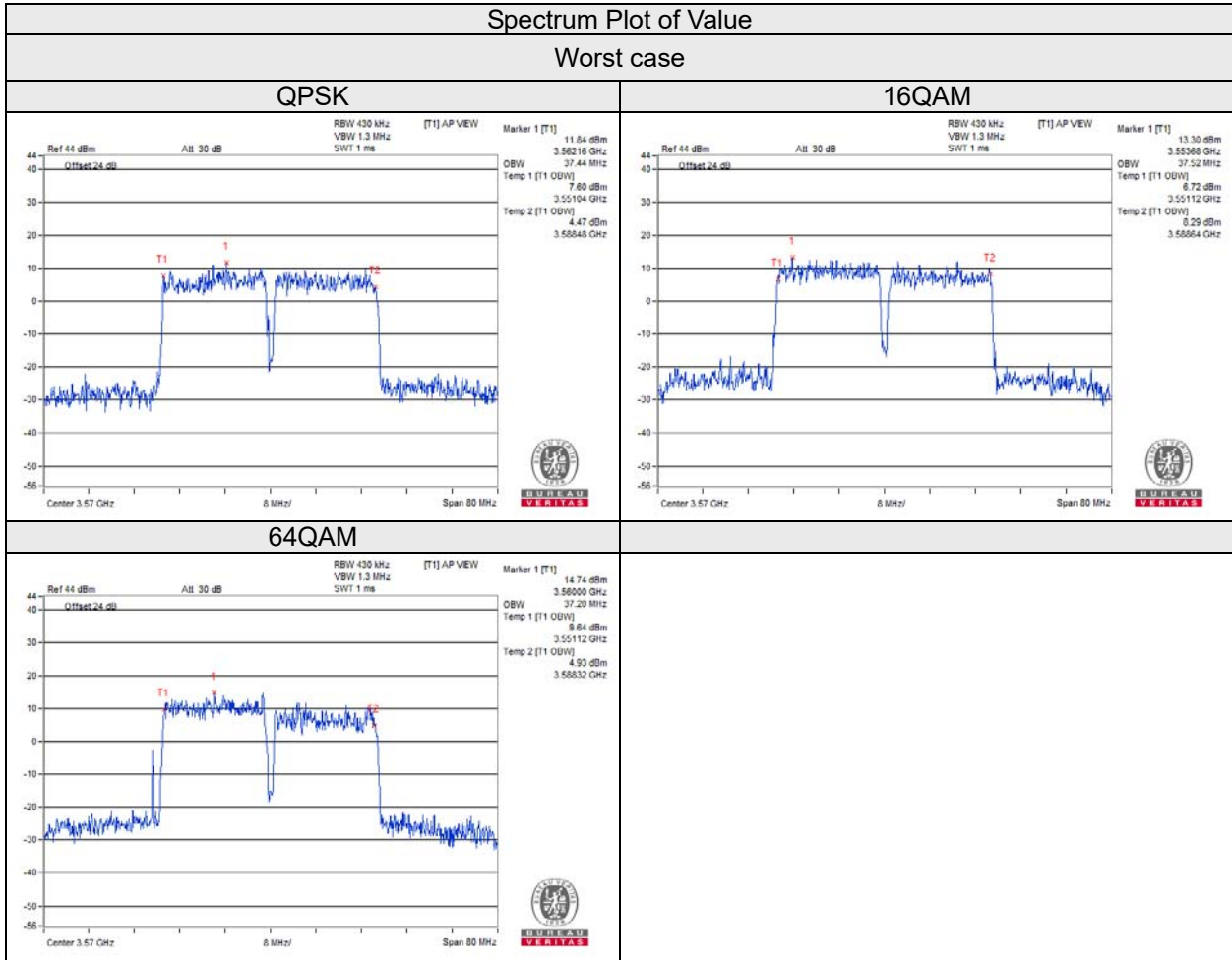

4.6 Peak to Average Ratio

4.6.1 Limits of Peak to Average Ratio Measurement

In measuring transmissions in this band using an average power technique, the peak to-average ratio (PAR) of the transmission may not exceed 13 dB

4.6.2 Test Setup

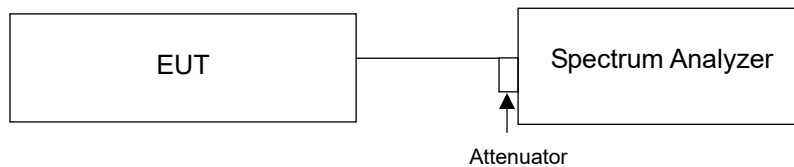

4.6.3 Test Procedures

For SC Configurations:

- a. Set resolution/measurement bandwidth \geq signal's occupied bandwidth;
- b. Set the number of counts to a value that stabilizes the measured CCDF curve;
- c. Record the maximum PAPR level associated with a probability of 0.1%.

For CA Configurations:

$$\text{PAPR (dB)} = P_{Pk} \text{ (dBm)} - P_{Avg} \text{ (dBm)}$$

Where :

- a. PAPR: peak-to-average power ratio, in dB.
- b. P_{Pk} : measured peak power or peak PSD level, in dBm.
- c. P_{Avg} : measured average power or average PSD level, in dBm.

4.6.4 Test Results

Single Carrier

Channel	Freq. (MHz)	Peak to Average Ratio (dB)			Limit(dB)	Pass /Fail
		5MHz				
		QPSK	16QAM	64QAM		
Low	3552.5	5.03	6.24	7.01	13	Pass
Middle	3625	4.92	6.17	7.34	13	Pass
High	3697.5	4.36	5.70	6.63	13	Pass

Channel	Freq. (MHz)	Peak to Average Ratio (dB)			Limit(dB)	Pass /Fail
		10MHz				
		QPSK	16QAM	64QAM		
Low	3555	4.96	6.29	6.91	13	Pass
Middle	3625	4.91	6.22	6.83	13	Pass
High	3695	4.88	5.48	6.12	13	Pass

Channel	Freq. (MHz)	Peak to Average Ratio (dB)			Limit(dB)	Pass /Fail
		15MHz				
		QPSK	16QAM	64QAM		
Low	3557.5	5.08	6.28	6.86	13	Pass
Middle	3625	4.96	6.15	6.86	13	Pass
High	3692.5	4.42	5.45	6.12	13	Pass

Channel	Freq. (MHz)	Peak to Average Ratio (dB)			Limit(dB)	Pass /Fail
		20MHz				
		QPSK	16QAM	64QAM		
Low	3560	4.97	6.18	6.87	13	Pass
Middle	3625	4.87	6.07	6.72	13	Pass
High	3690	4.60	5.73	6.43	13	Pass

CA Contiguous

Channel	Freq. (MHz)	Peak to Average Ratio (dB)			Limit(dB)	Pass /Fail
		20MHz+20MHz				
		QPSK	16QAM	64QAM		
Worst case	3600+3579.8	4.7	4.43	3.94	13	Pass

5MHz:

Spectrum Plot of Value

Low

QPSK

16QAM

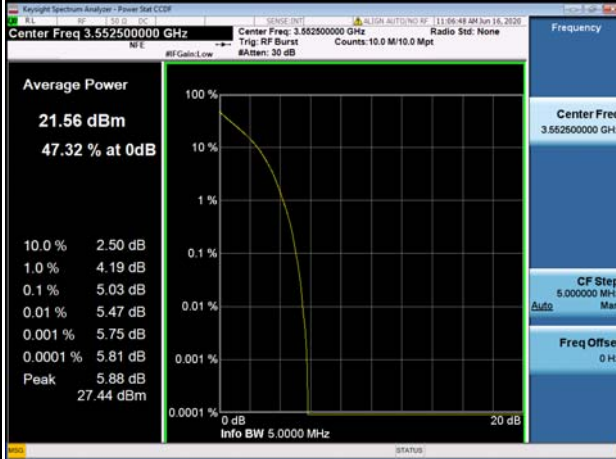

64QAM



Middle

QPSK



16QAM

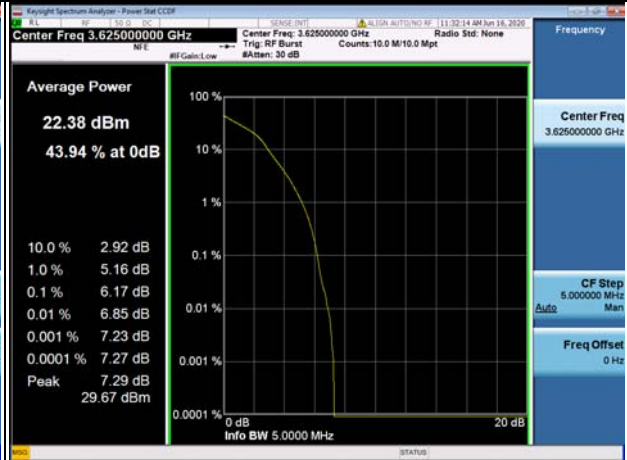

64QAM

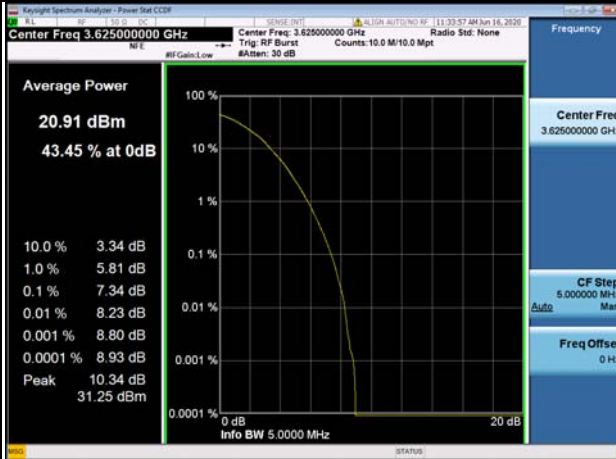

High

QPSK



16QAM

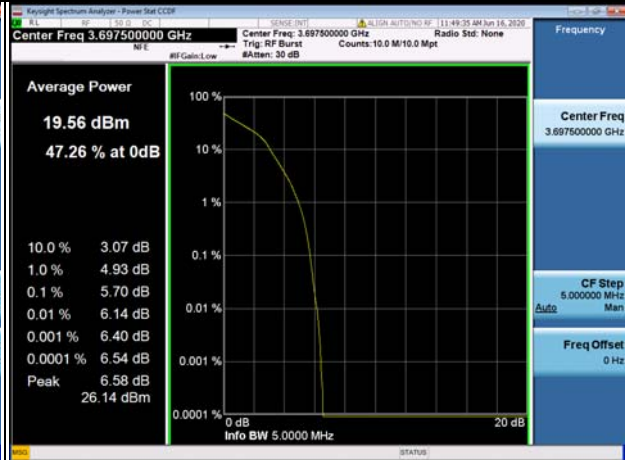

64QAM



10MHz:

Spectrum Plot of Value

Low

QPSK

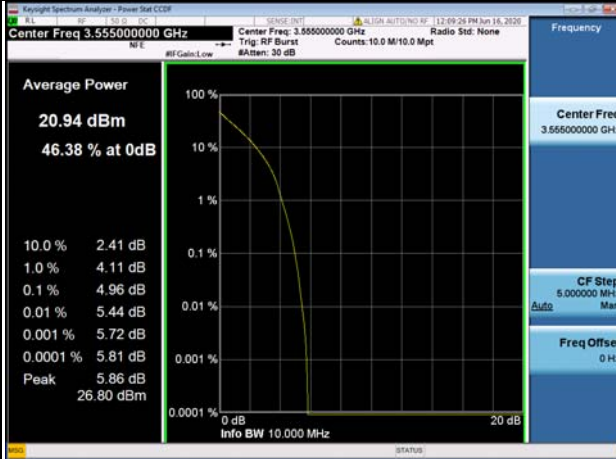

16QAM

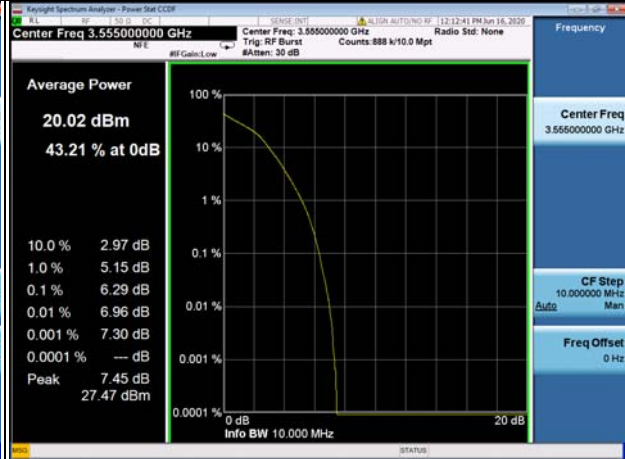

64QAM

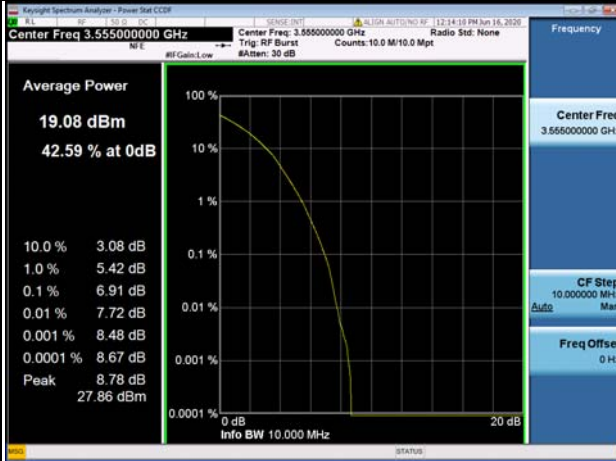

Middle

QPSK

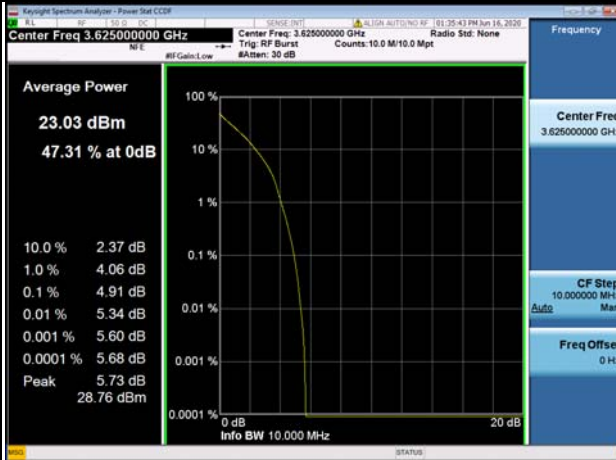

16QAM

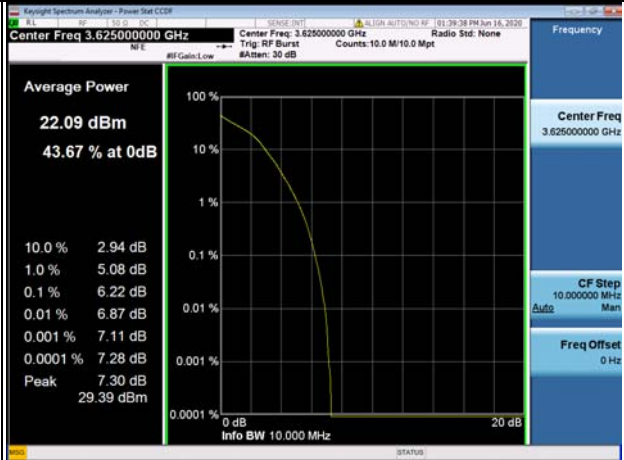

64QAM

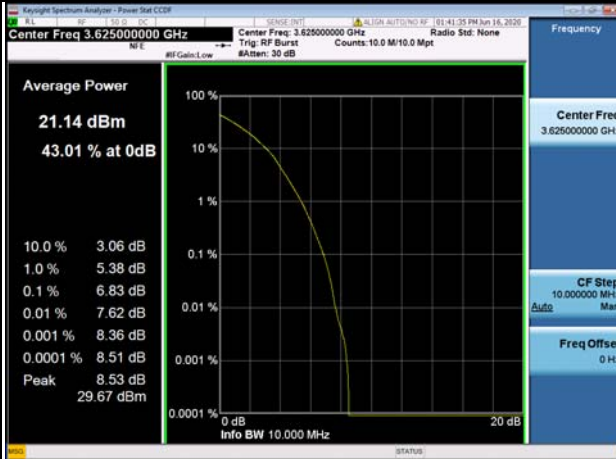



15MHz:

Spectrum Plot of Value
Low

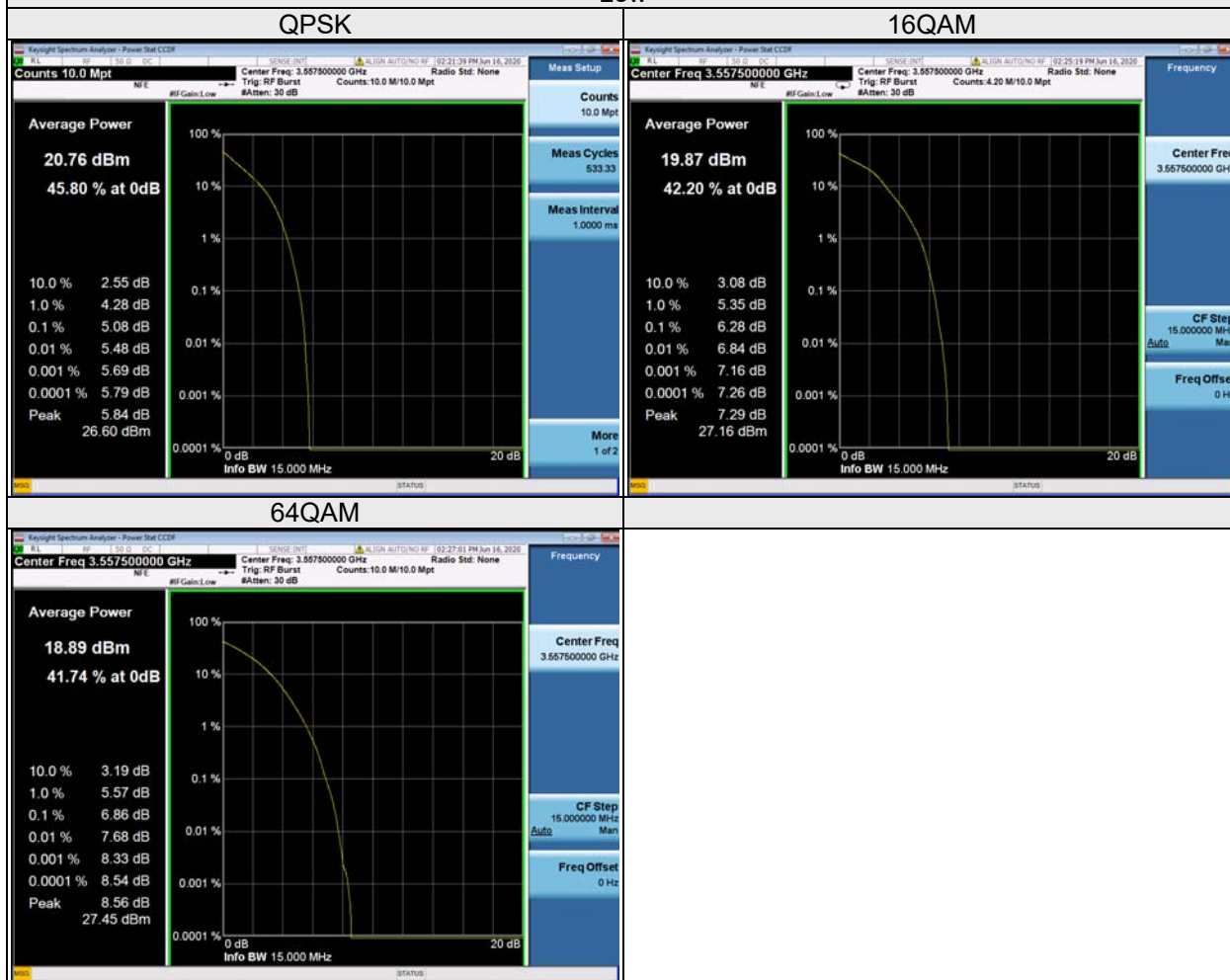

Middle

QPSK



16QAM

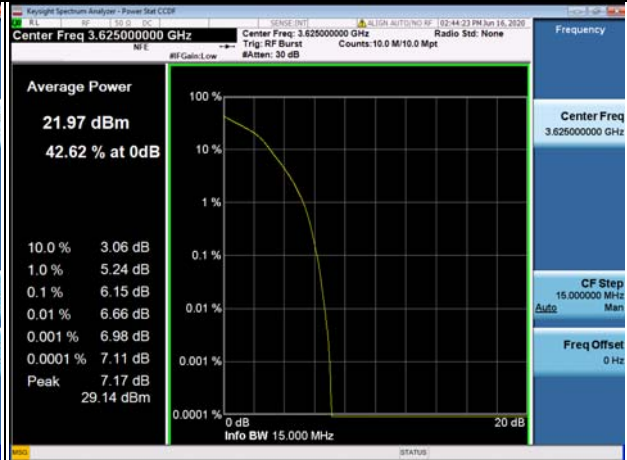

64QAM



High

QPSK



16QAM

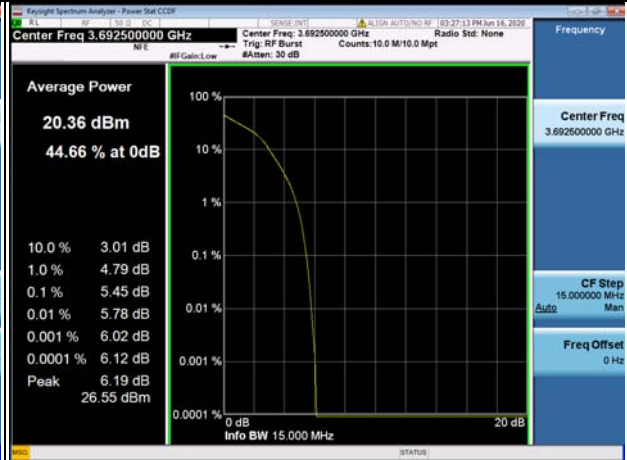

64QAM

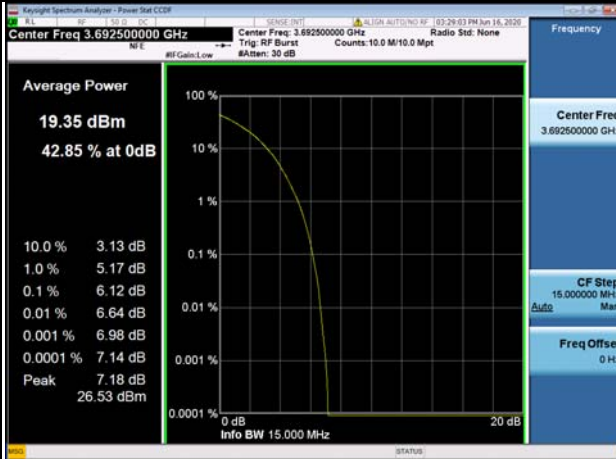

20MHz:

Spectrum Plot of Value

Low

QPSK

16QAM

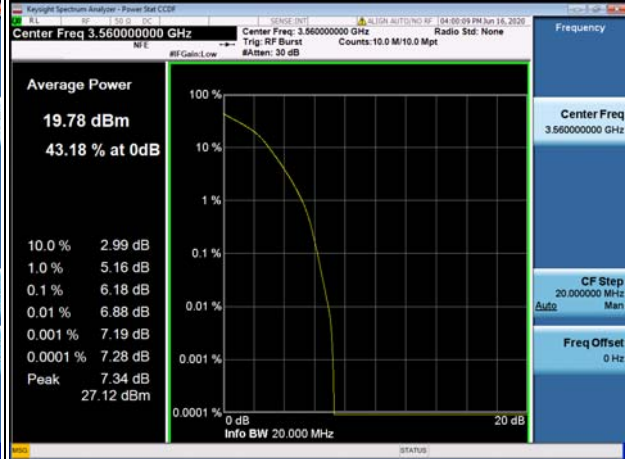
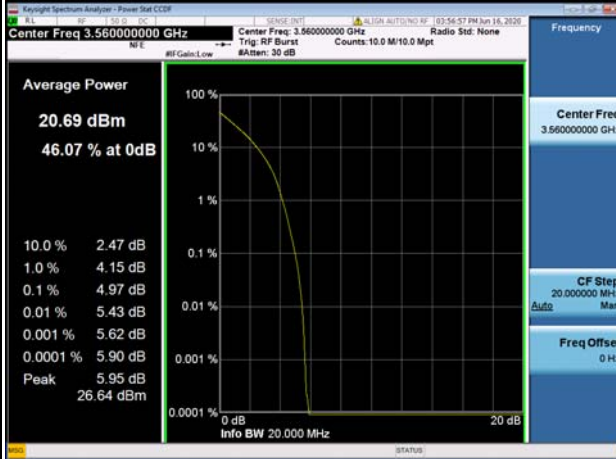

64QAM

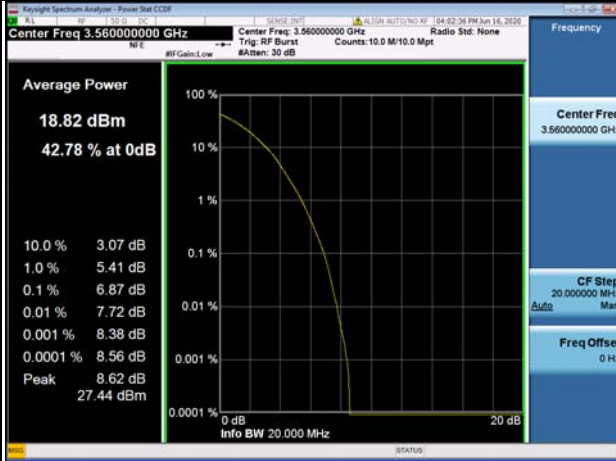

Middle

QPSK

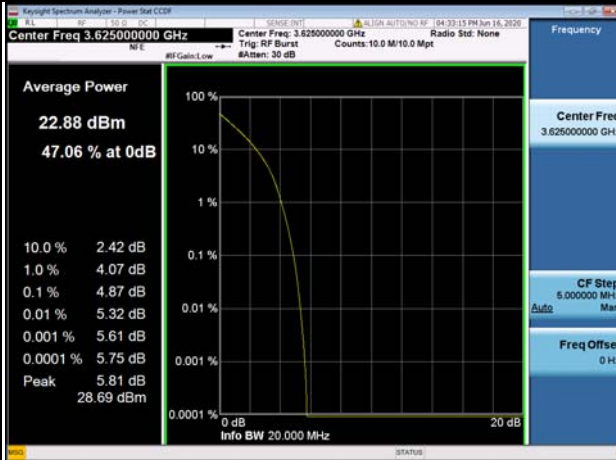

16QAM

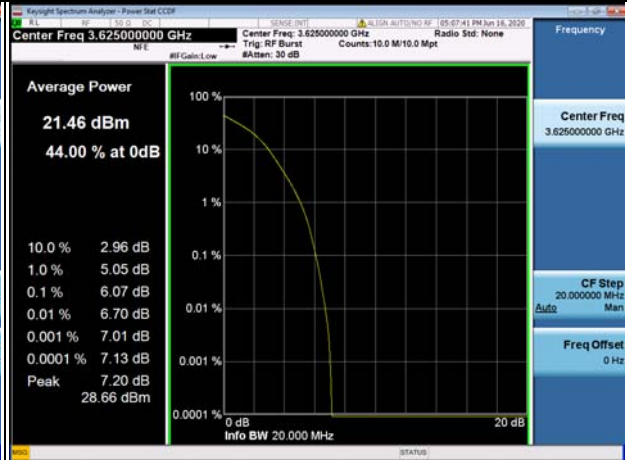

64QAM

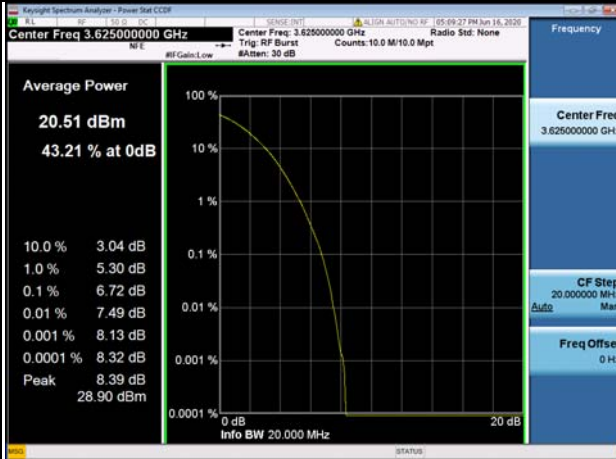

High

QPSK



16QAM

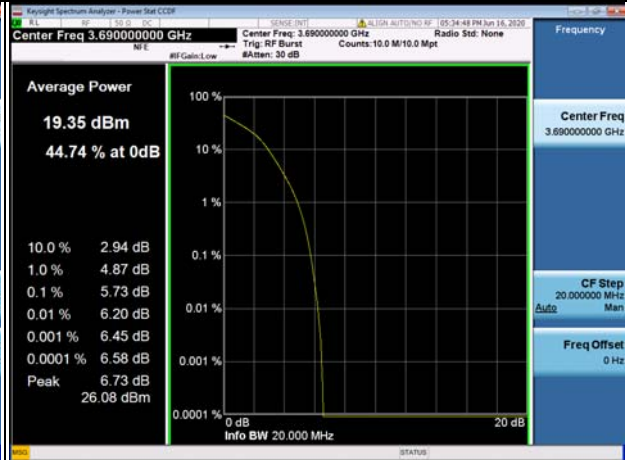

64QAM

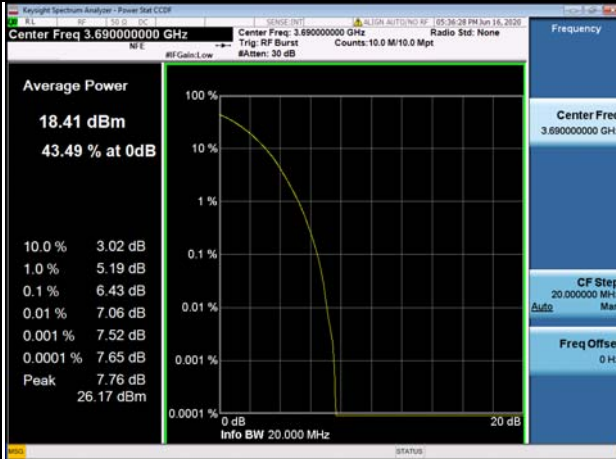

20MHz+20MHz:

Spectrum Plot of Value
Worst case

QPSK / P_{pk}

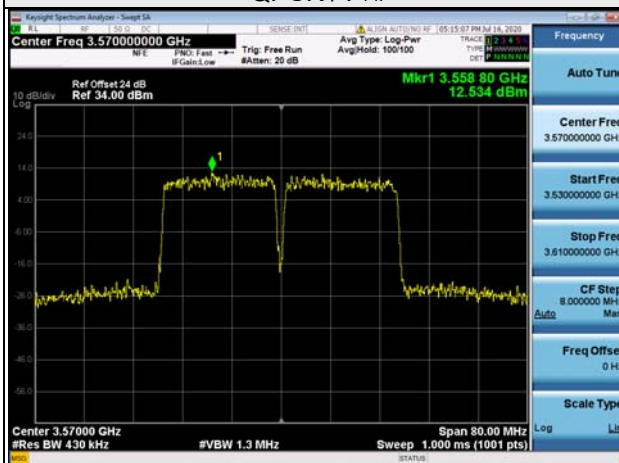

QPSK / P_{Avg}

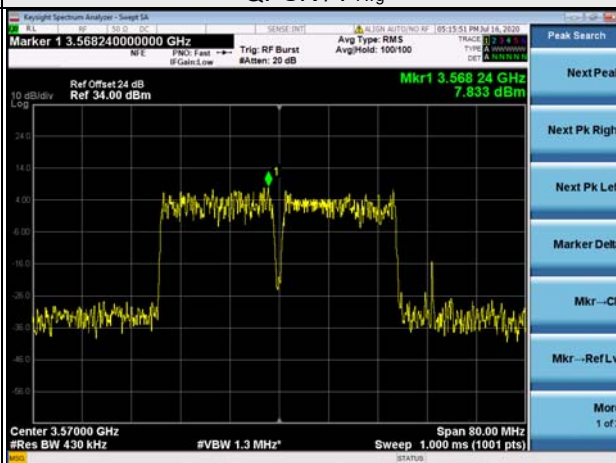

16QAM / P_{pk}

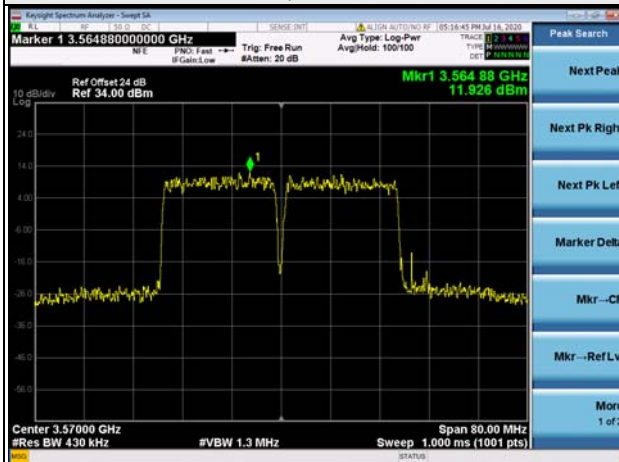

16QAM / P_{Avg}

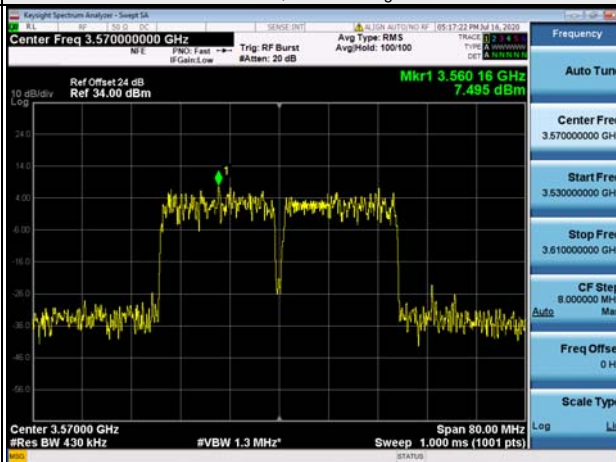

64QAM / P_{pk}

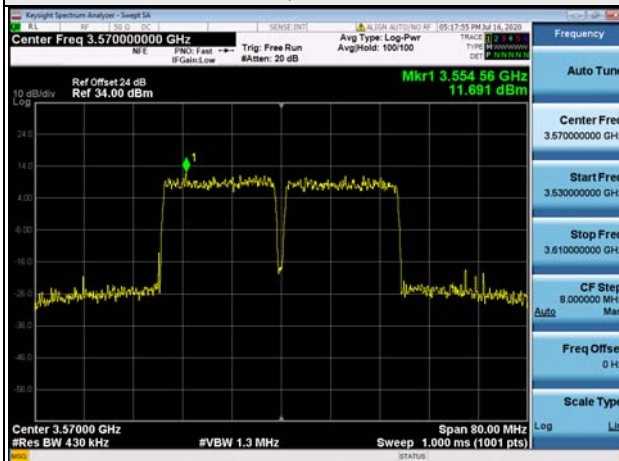

64QAM / P_{Avg}

