

(台灣) 譚裕實業股份有限公司

(大陸) 東莞台霖電子通訊有限公司

品名：RF Antenna Assembly

規格：

料號：C059-510504-A

客戶：訊舟科技股份有限公司

客戶料號：1680-00000774-50Z

日期：2024/09/19

譚裕實業地址：No. 326, Sec. 2, Kung Tao 5 Road, Hsin Chu City, Taiwan, R. O. C.

電話：+886-3-5714225(REP.)

傳真：+ 886-3-5713853 · + 886-3-5723600

東莞台霖地址：Hupan Industrial District, Tai Ling Shan Town, Dong Guan City, Guangdong, China

電話：+86-769-85655858

傳真：+86-769-85655258

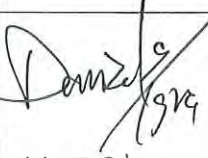
確認				客戶確認
製作	審核	核准	業務	
白瑛		 H.T.Cheng		

Contents

<i>Item</i>	<i>Description</i>	<i>Page</i>
1.	規格表 1
2.	成品圖 2
3.	成品照片 3
4.	BOM List 4
5.	測試報告 5~34
6.	材質證明&UL 35~52
4.	RoHS測試報告 53~179
5.	RoHS排外條款 180
6.	附件 181~182

RF Antenna Assembly

Specification

1. Electrical Properties : With housing/With Cable loss(Ant.2)

1.1 Frequency Range.....	2.4 ~ 2.5 , 5.15~5.905, 5.925~7.125 GHz
1.2 Impedance	50Ω Nominal
1.3 VSWR	1.7 : 1 Max.
1.4 Return Loss.....	11.7 dB Min.
1.5 Radiation	Omni-directional
1.6 Peak Gain.....	2.4 ~ 2.5GHz < 1.67dBi 5.15~5.905GHz < 2.67dBi 5.925~7.125 GHz < 2.76dBi
1.7 Cable Loss.....	1.53 dB Max.
1.8 Polarization.....	Linear
1.9 Cable.....	0.81 Coaxial Cable
1.10 Connector.....	I-PEX MHF Connector (4L)

2. Physical Properties :

2.1 Operating Temp.	-10°C ~ +60°C
2.2 Storage Temp.	-10°C ~ +70°C

CG-

REV	DATE	DESCRIPTION
X1	10/16-2024	New Issue

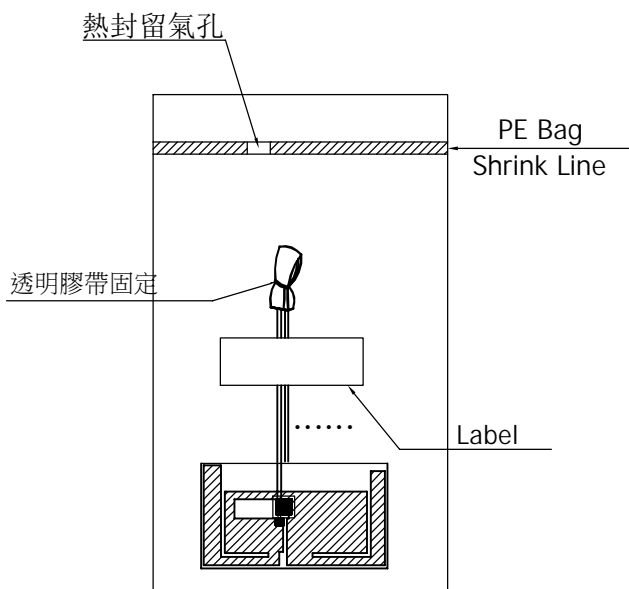

Packing: 25pcs/珍珠棉袋

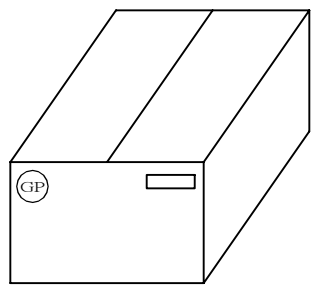

GP標籤貼於紙箱側麥左上角(共2PCS)
外箱標籤貼於紙箱側麥右上角(共1PCS)

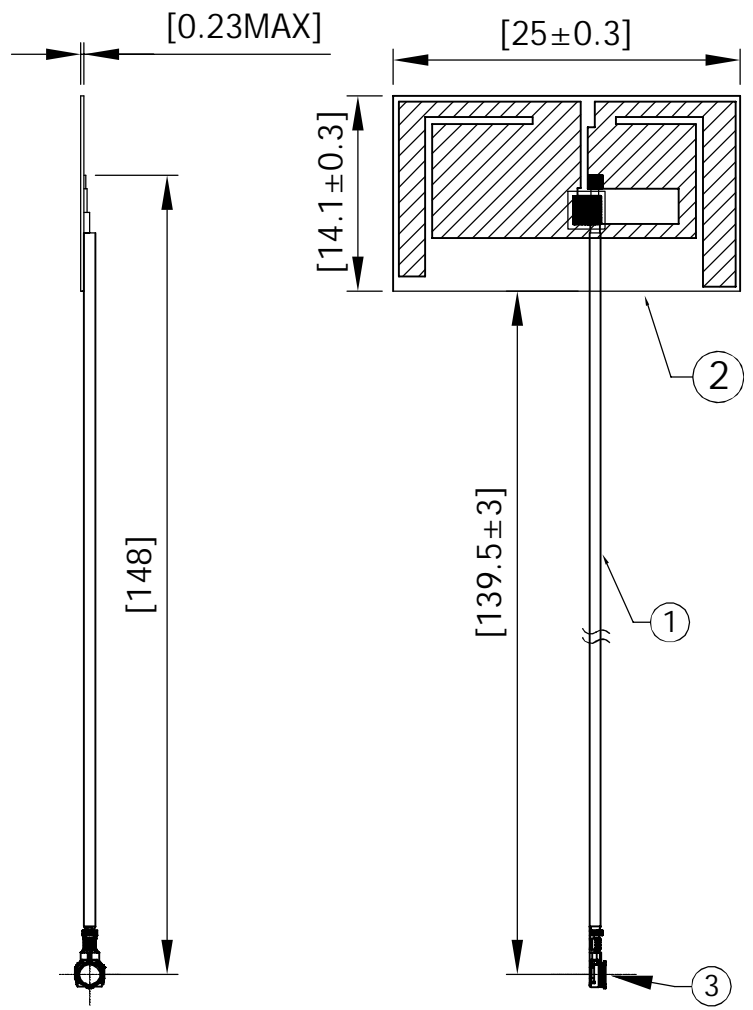

3	Connector	MHF-4L Plug for Ø0.81 Cable (20572-001R-08)	1	
2	FPCB	單面板;(L)25*(W)14.1*(T)0.23MM; 25um PI+18um CU (3M 9448A)	1	Black Plated
1	Cable	Ø0.81mm Coaxial Cable ; Color : Black; 鍍錫線	1	
NO		DESCRIPTION	Q'TY	REMARK

CUSTOMER'S SINGATURE	XXX.	±5.0	APPROVED	CUSTOMER: 訊舟		
	XX.	±3.0		PART NO : 1680-0000774-50Z		
	X.X	±1.0	CHECKED	PART NAME: RF PCB Antenna Assembly		
	.X	±0.5		W.Y P/NO : C059-510504-A		
	.XX	±0.2	DRAWING	REV	UNIT	FILE
⊕	⊖	Freda		X1	mm	SHEET : 1/1

M.gear Wha Yu Group

THIS DRAWING, AND ITS INHERANT DESIGN CONCEPTS, ARE THE PROPERTY OF WHA YU AND AS SUCH MAY NOT BE COPIED, REPRODUCED, OR GIVEN TO THIRD PARTIES WITHOUT THE WRITTEN CONSENT OF WHA YU.

PRODUCTION DRAWING

爆炸圖

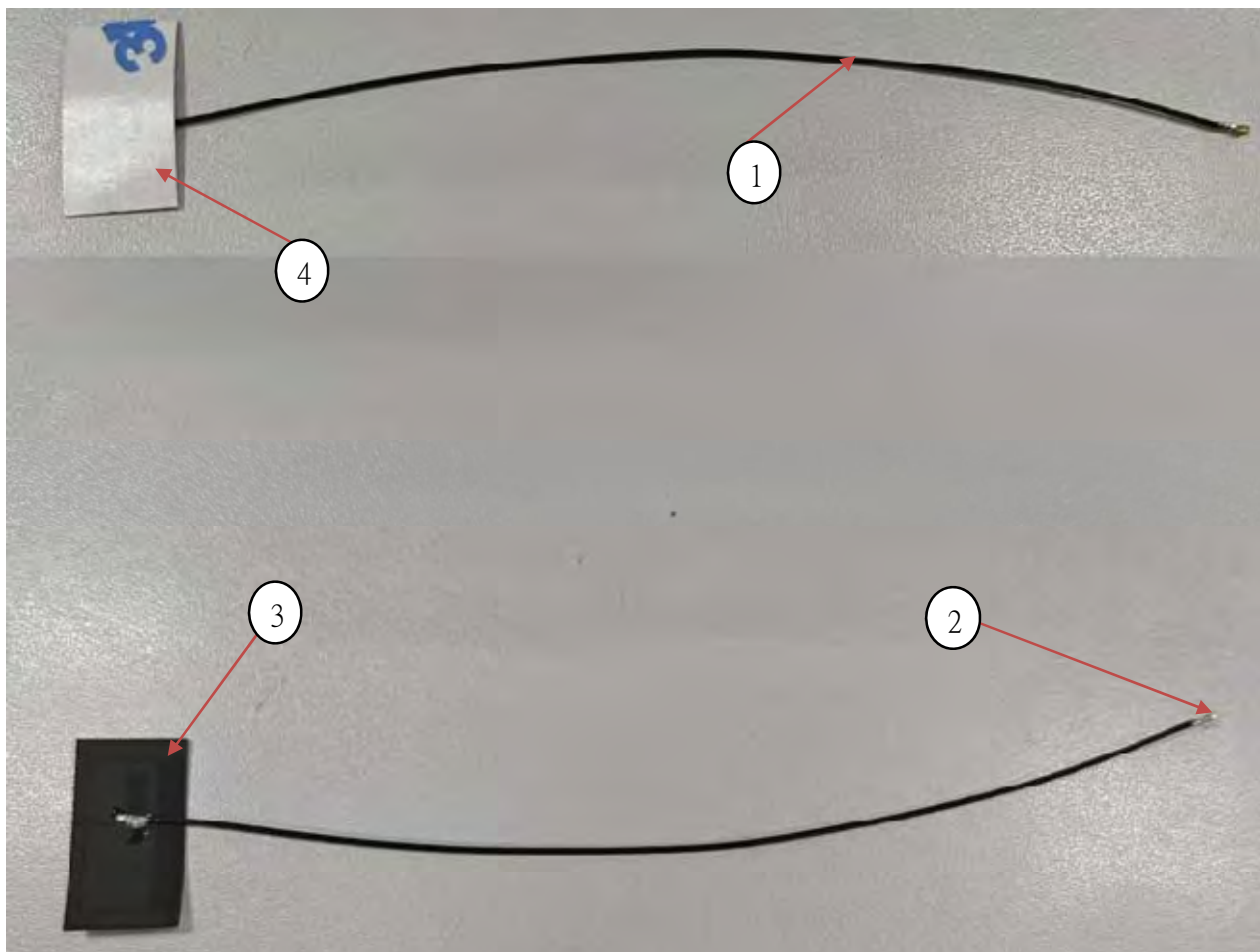



譚裕實業股份有限公司

WHA YU INDUSTRIAL CO., LTD

BILL OF MATERIAL

CUSTOMER P/N: 訊舟科技股份有限公司

DATE:2024.9.19

W.Y.P/N:C059-510504-A

PART NO:SRF20241566

PART NAME:RF Antenna Assembly

序號	零件名稱	供應商	規格描述	用量/PCS
1	Cable	KAIBO	φ0.81mm Coaxial Cable; Color :Black	1
2	Connector	I-PEX	MHF-4L Plug Connector for 0.81 Cable (20572-001R-08)	1
3	FPCB	ZHINENG	單面板;(L)25*(W)14.1*(T)0.23mm;25um PI+18um 雙面防焊黑漆	1
4	背膠	JUNZHAN	3M 9448A	1



We connect the wireless world.

EW-7822MU7 Antenna Test Report

Version: V 1.10

Released Date: 2024/08/27

Prepared By : Tim Cheng

Reviewed By :

Contents



- Revised History
- Specification
- Antenna Dimension and Placement
- Return Loss / Isolation
- Peak Gain / Efficiency

Revised History



Released Date	Version	Record
2024/04/03	V1.00	Initial simulation report
2024/04/23	V1.01	Modify antenna for test (3D file:cradle_A_0417.STEP)
2024/04/30	V1.02	Modify antenna for test (3D file:cradle_A_0417.STEP)
2024/05/14	V1.03	Modify antenna for test (3D file:cradle_A_0417.STEP)
2024/05/21	V1.04	Modify antenna for test (3D file:cradle_A_0417.STEP) Change 0.8mm Cable for 1.13mm Cable
2024/06/05	V1.05	Modify antenna for test (3D Mockup)
2024/06/13	V1.06	Modify antenna for test (3D Mockup)
2024/06/24	V1.07	Modify antenna for test (3D file:ant1_asm.stp)
2024/08/08	V1.08	Change antenna type and cable for test (3D file:ant1_asm.stp) Change 1.13mm Cable for 0.81mm Cable
2024/08/12	V1.09	Change antenna type for test (3D file:ant1_asm.stp)
2024/08/27	V1.10	Modify antenna for test (T2 Housing)

Specification



Requirements of Antenna Design

RF Function	Number of ANT	Frequency Band	Remark
WiFi 2/5/6G	2	2400-2500 MHz /5150-5905 MHz / 5925-7125 MHz	Ant.1, Ant.2

Requirements of Measurement

Test Item	Specification	Remark
Return loss	> 11.7 dB	
Isolation	> 20 dB	
Peak gain	< 2dBi @ 2400-2500 MHz < 3dBi @ 5150-5905 MHz < 3dBi @ 5925-7125 MHz	
Efficiency	> 60% @ 2400-2500 MHz /5150-5905 MHz > 55% @ 5925-7125 MHz	
Radiation pattern	Scale: +10 ~ -40dBi, Angle step size: 5 degree	

Antenna Dimension and Placement



180 Degree

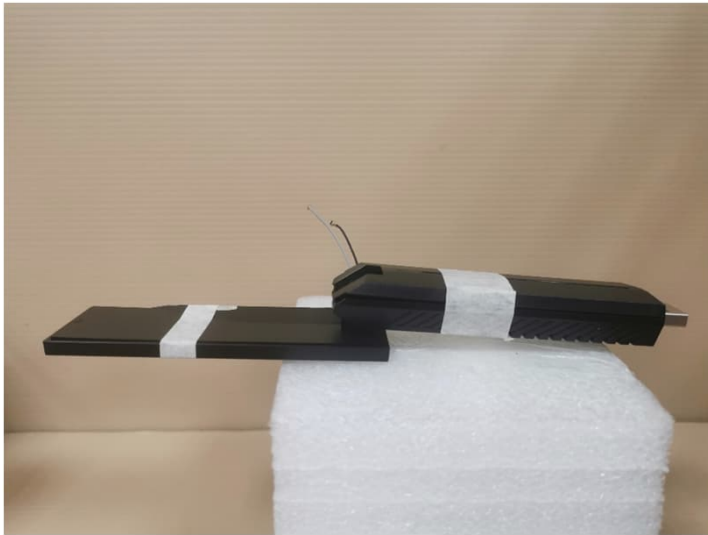

Antenna Dimension and Placement



90 Degree



Antenna Dimension and Placement



Ant.2
2400-2500 MHz
5150-5905 MHz
5925-7125 MHz

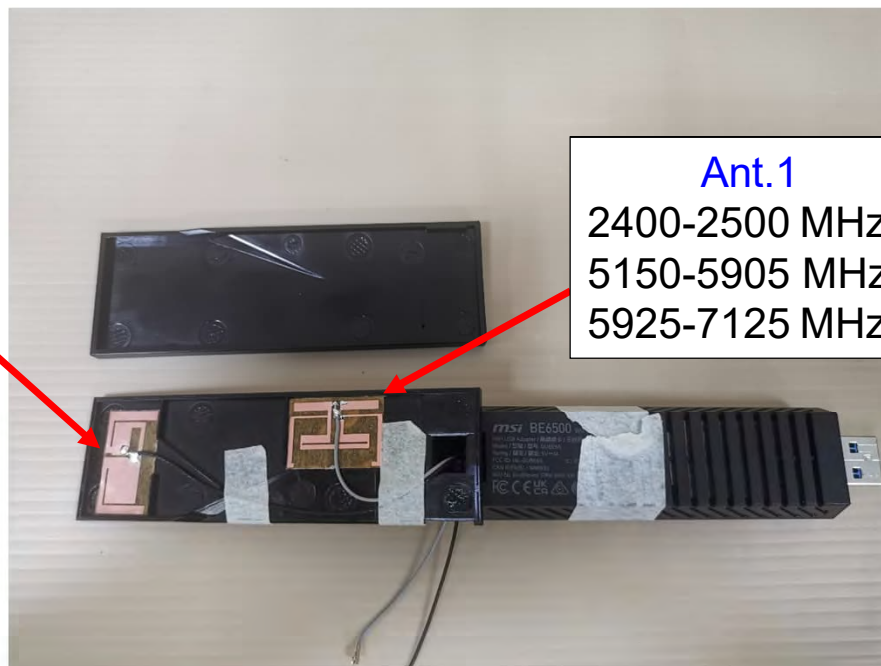

Ant.1
2400-2500 MHz
5150-5905 MHz
5925-7125 MHz

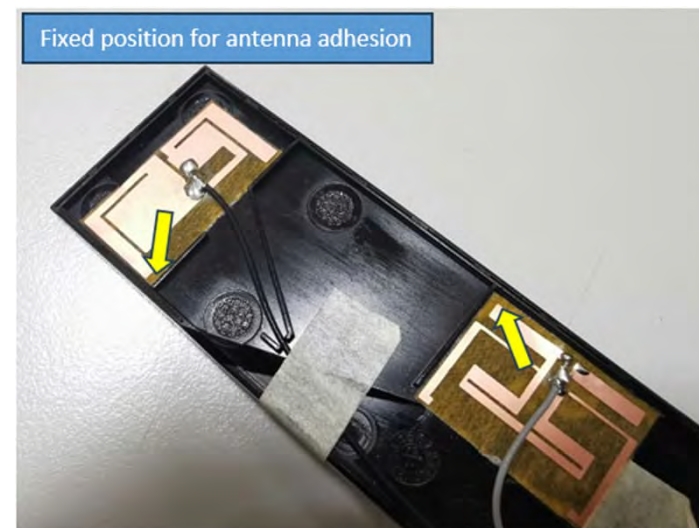

Antenna	ANT Type	Size (L * W * H* T)	Cable Length (mm)	Cable Type
Ant.1(C059-510503-A)	FPCB Dipole	(L)22.4mm*(W)16.28mm*(T)0.23mm	111mm (Total) Gray	0.81mm Normal + IPEX4
Ant.2(C059-510504-A)	FPCB Dipole	(L)25.0mm*(W)14.1mm*(T)0.23mm	148mm (Total) Black	0.81mm Normal + IPEX4

Test Setup for S-parameter Measurement



Equipment	Brand	Model	S/N
Network Analyzer	Keysight	E5063A	MY54706080



Return Loss / Isolation



180 Degree

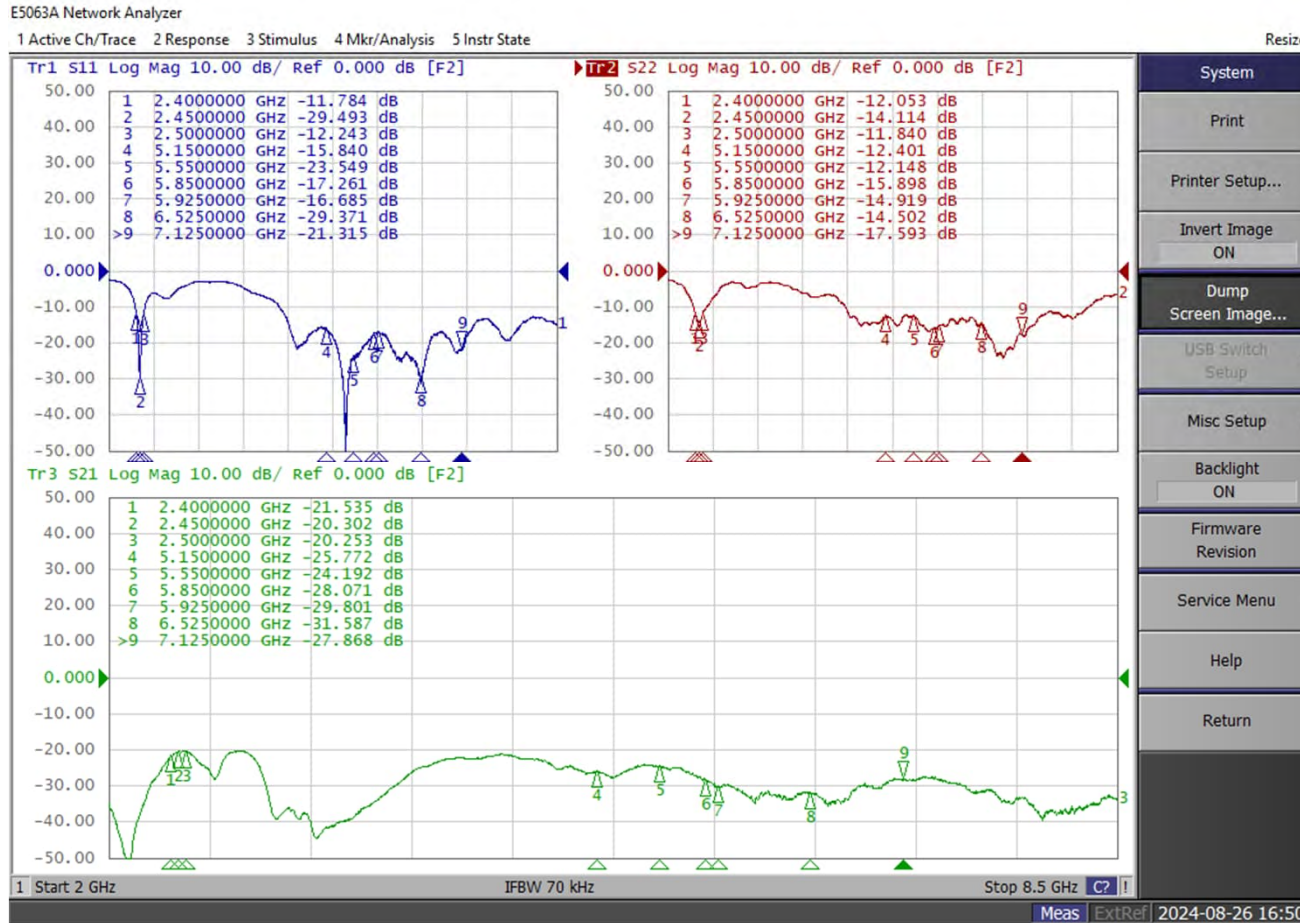

Antenna	Frequency
Ant-1 (S22)	2400-2500MHz
	5150-5850MHz
	5925-7125 MHz
Ant-2 (S11)	2400-2500MHz
	5150-5850MHz
	5925-7125 MHz

- System
- Print
- Printer Setup...
- Invert Image ON
- Dump Screen Image...
- USB Switch Setup
- Misc Setup
- Backlight ON
- Firmware Revision
- Service Menu
- Help
- Return

Return Loss / Isolation



90 Degree

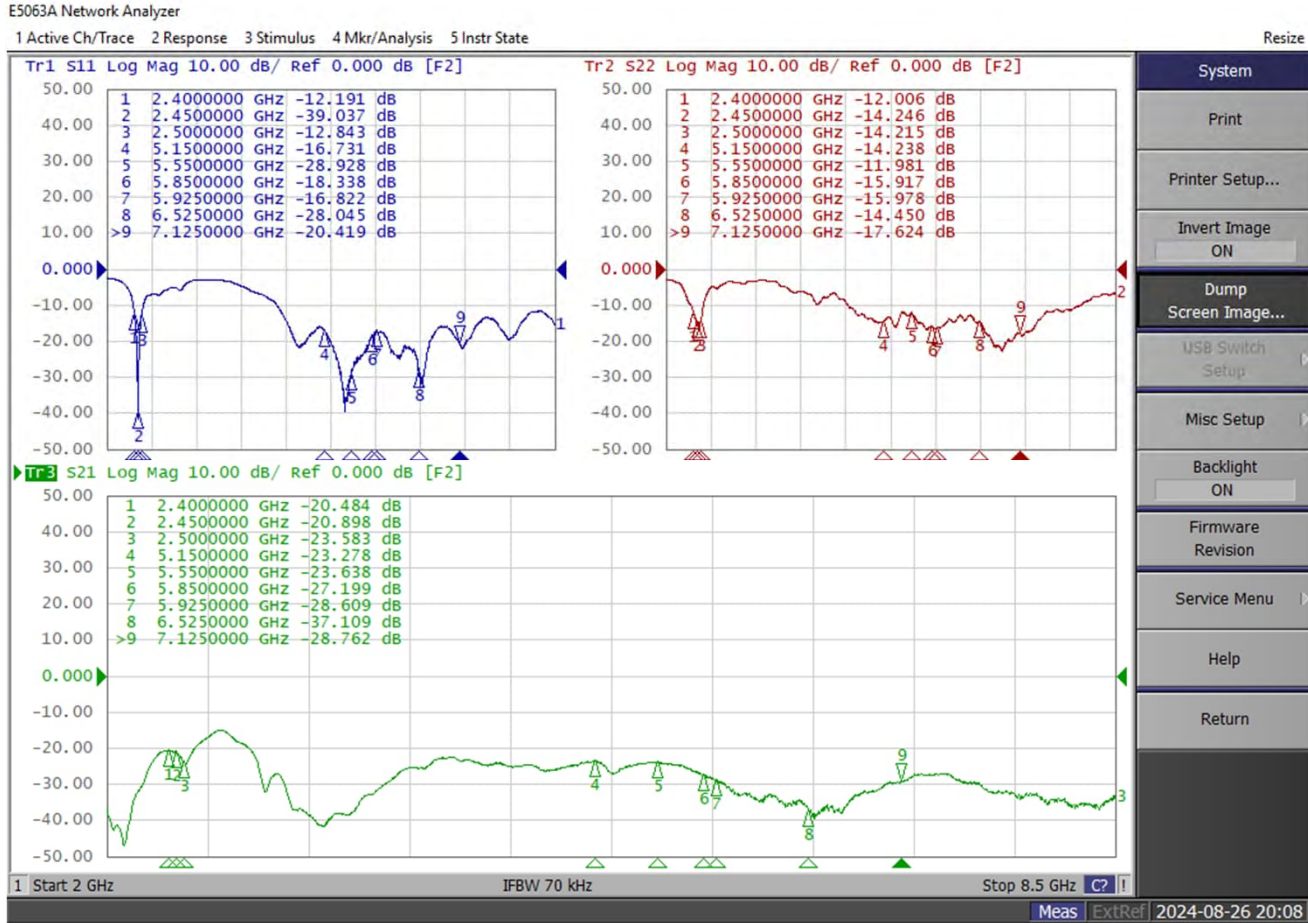

Antenna	Frequency
Ant-1 (S22)	2400-2500MHz
	5150-5850MHz
	5925-7125 MHz
Ant-2 (S11)	2400-2500MHz
	5150-5850MHz
	5925-7125 MHz

- System
- Print
- Printer Setup...
- Invert Image ON
- Dump Screen Image...
- USB Switch Setup
- Misc Setup
- Backlight ON
- Firmware Revision
- Service Menu
- Help
- Return

Test Setup for Radiation Pattern Measurement



- SATIMO Star Lab Multi-Probe Antenna Measurement System

- Angle between probes: 22.5°
- Frequency range: 400 MHz – 8.5 GHz
- Chamber Room Size: 1.82m L x 1.08m W x 2.00m H

Chamber	Brand	Model	Location
SATIMO	SATIMO	Star Lab	Taiwan HsinChu

Test Setup for Radiation Pattern Measurement



Test Setup for DUT

180 Degree

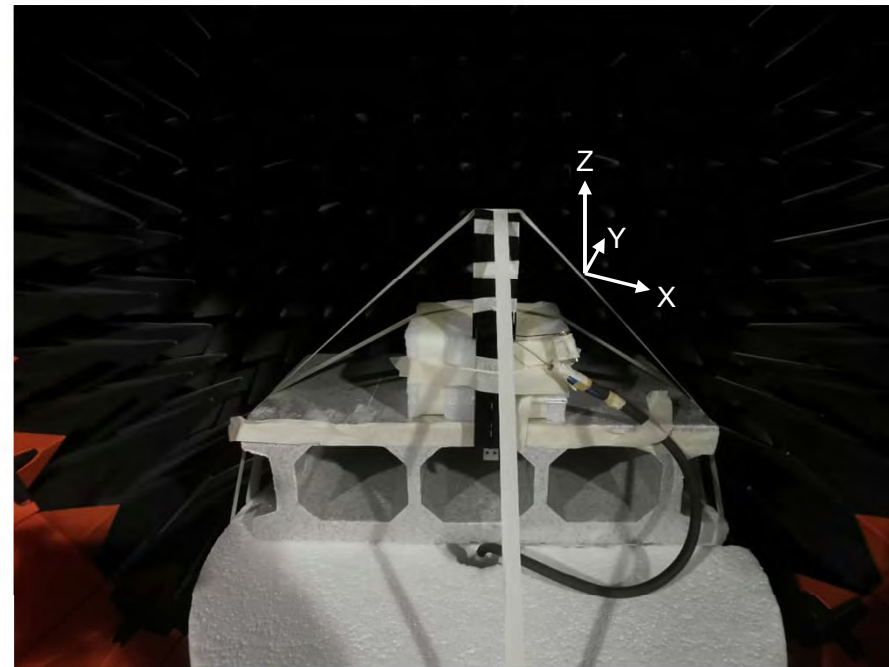

2D Radiation Pattern Results



Ant-1 (2G)

180 Degree

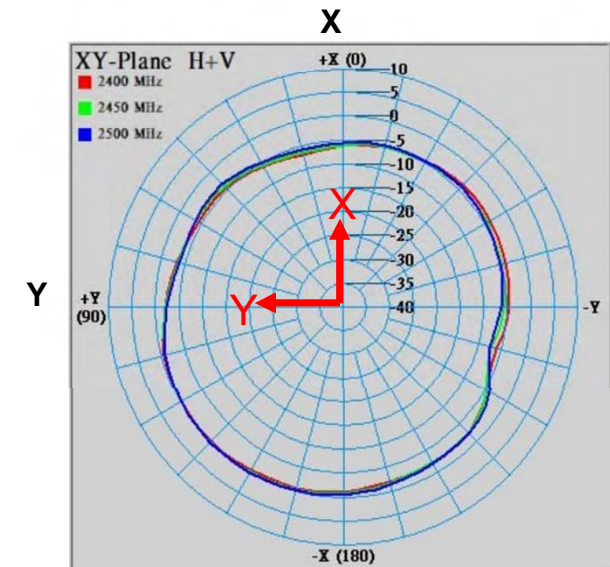
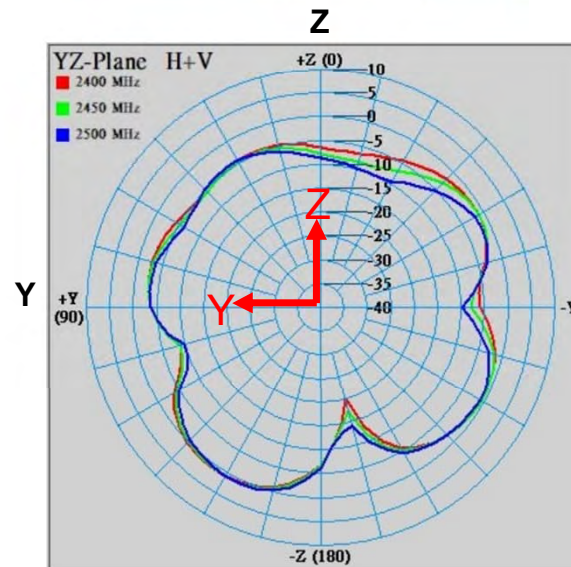
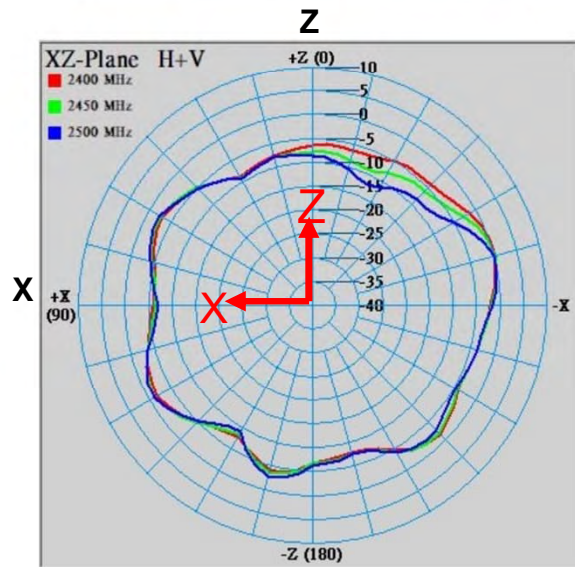
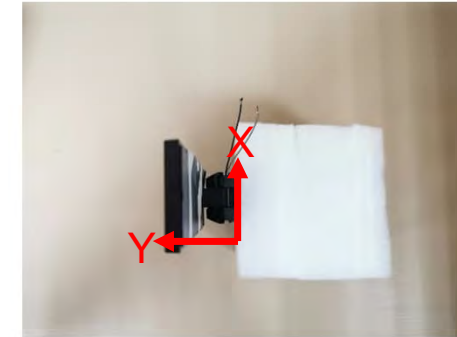
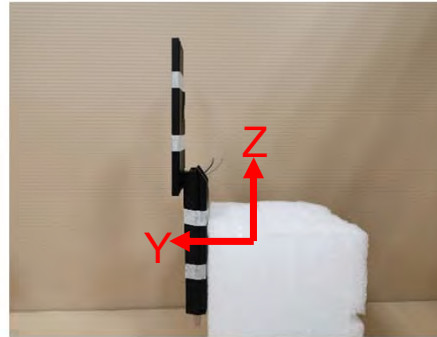
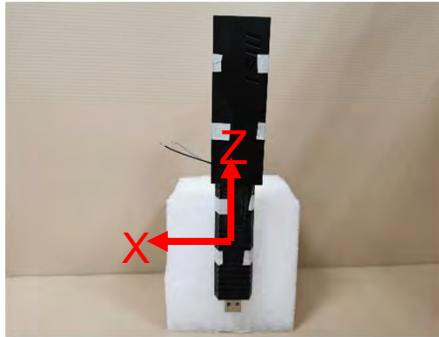

2D Radiation Pattern Results



Ant-1 (5G)

180 Degree

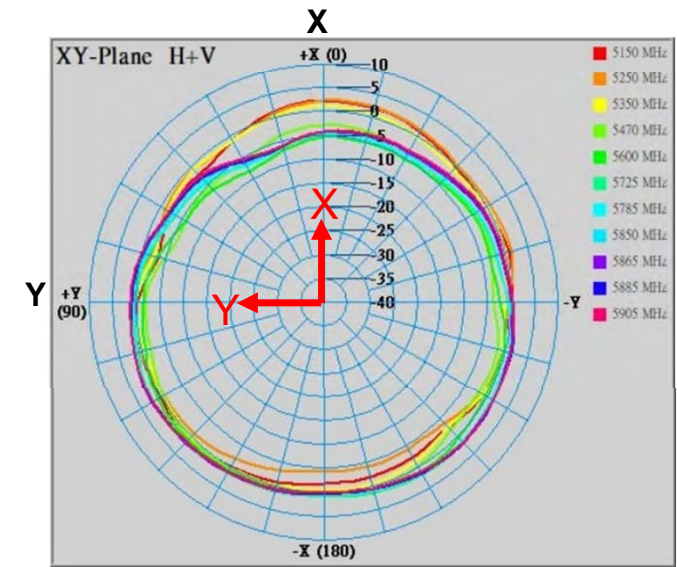
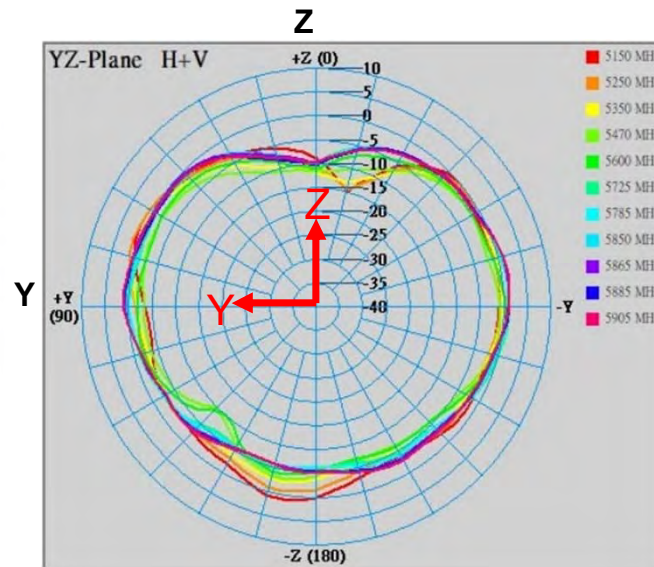
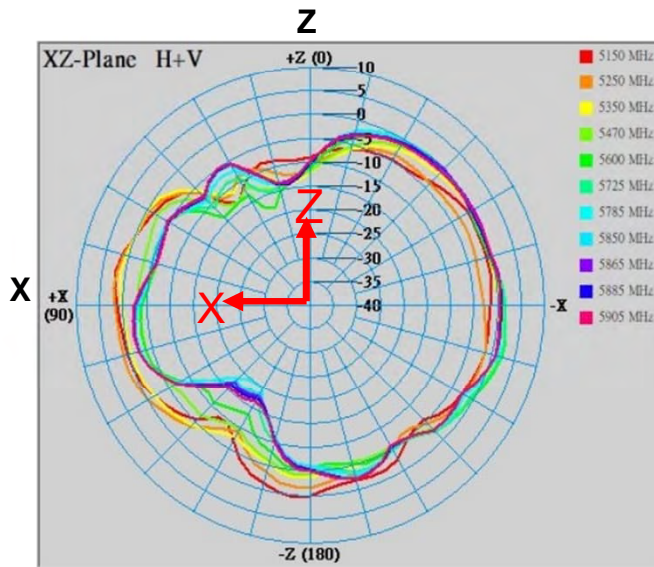
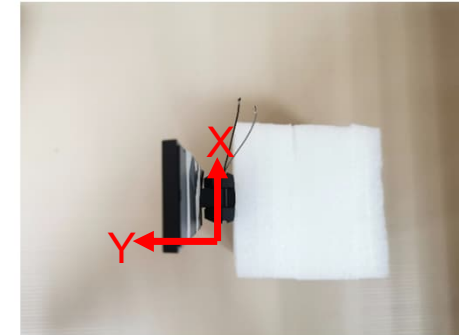
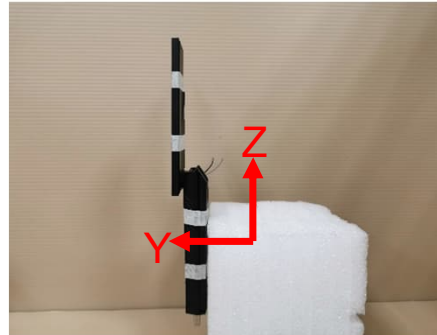
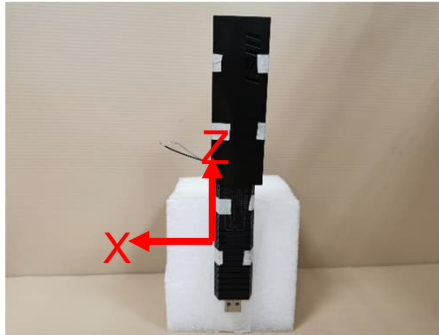

2D Radiation Pattern Results



Ant-1 (6G)

180 Degree

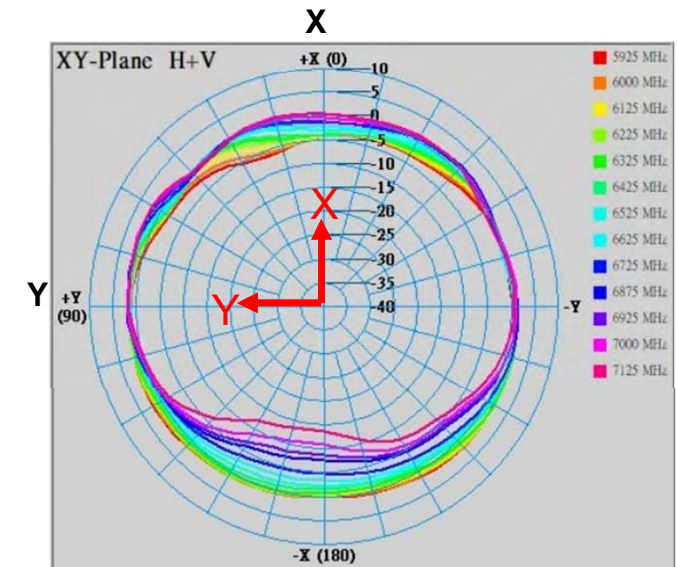
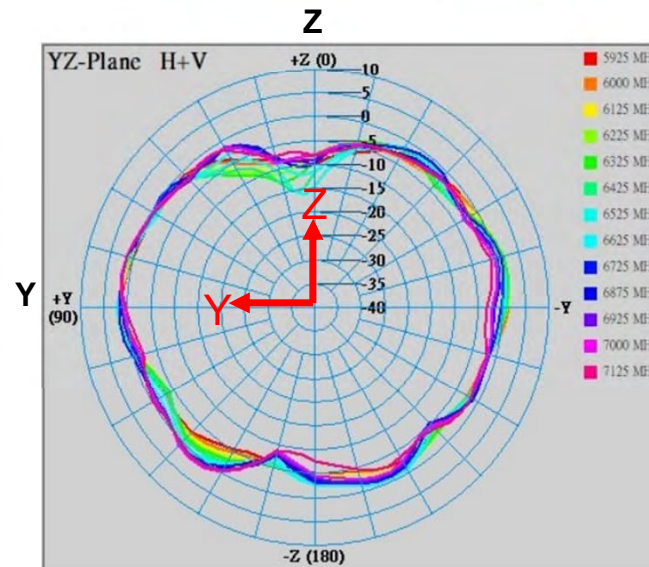
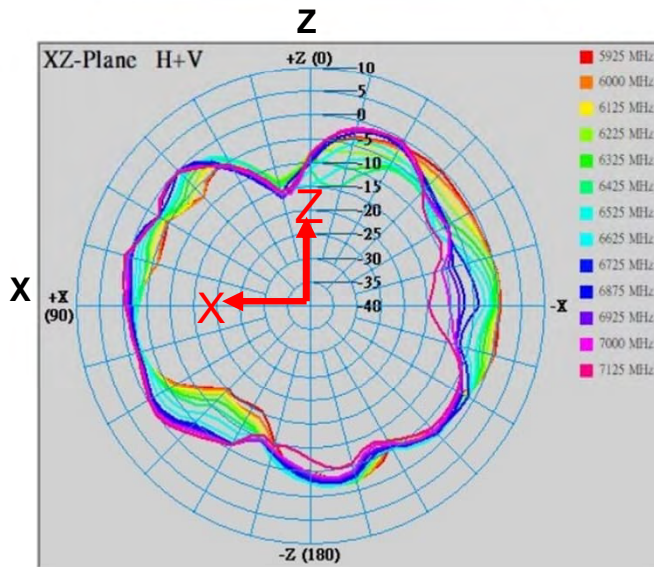
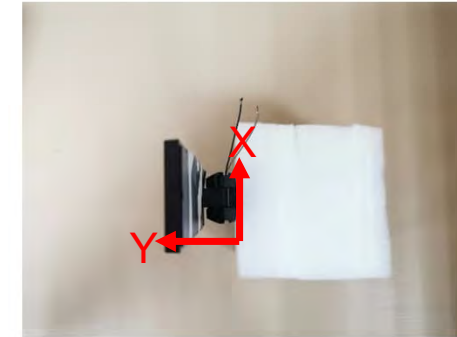
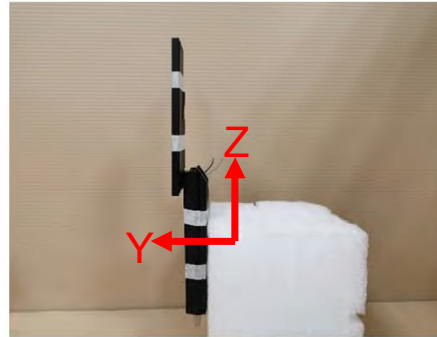
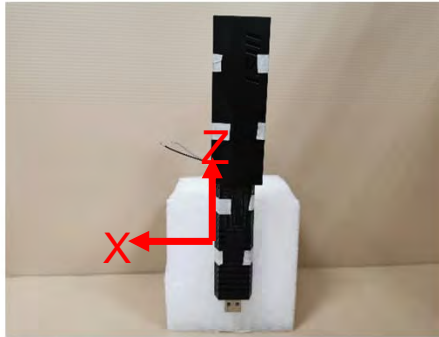

2D Radiation Pattern Results



Ant-2 (2G)

180 Degree

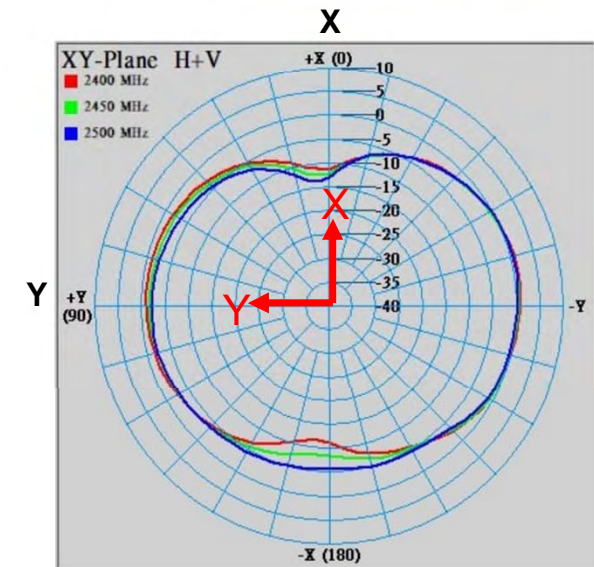
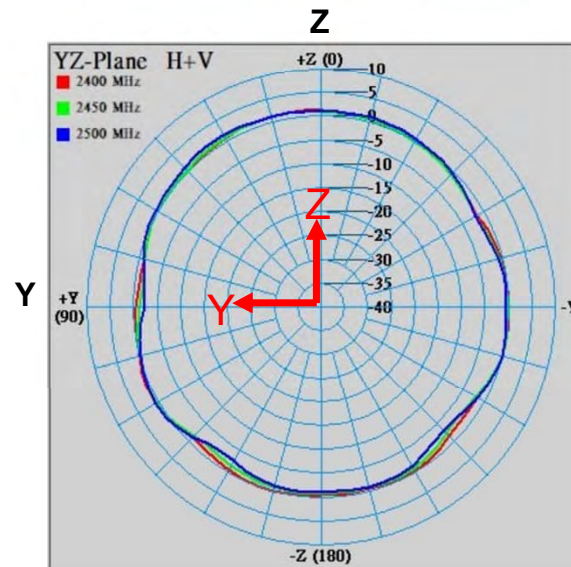
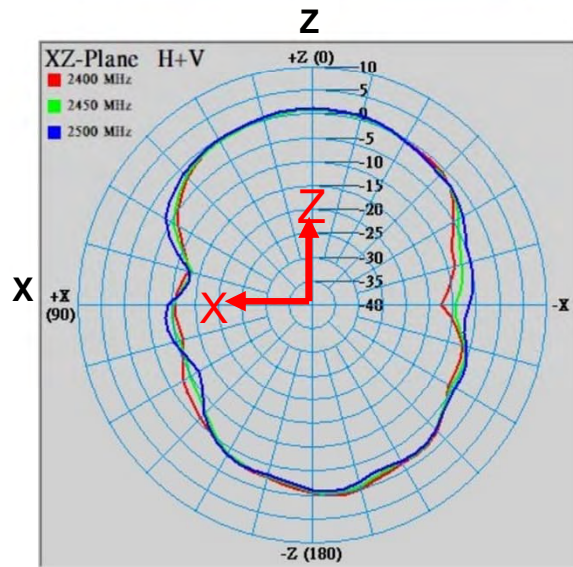
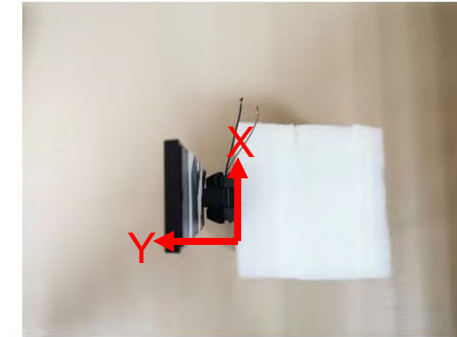
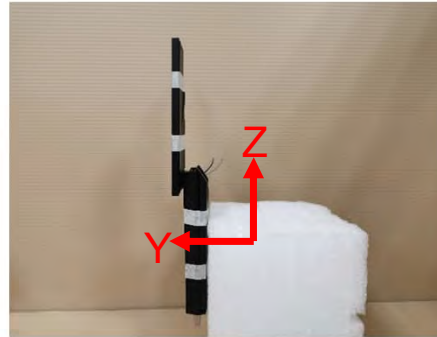
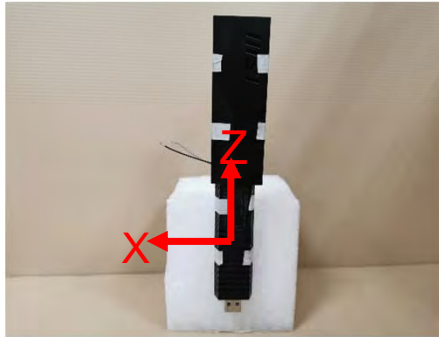

2D Radiation Pattern Results

Ant-2 (5G)

180 Degree

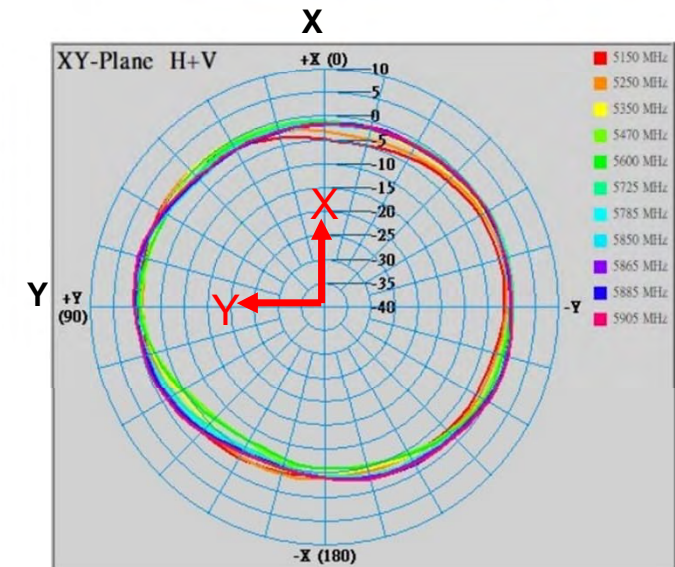
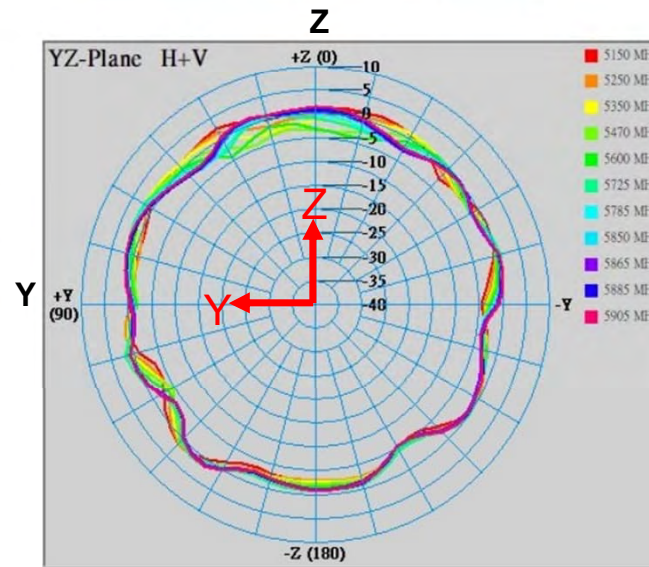
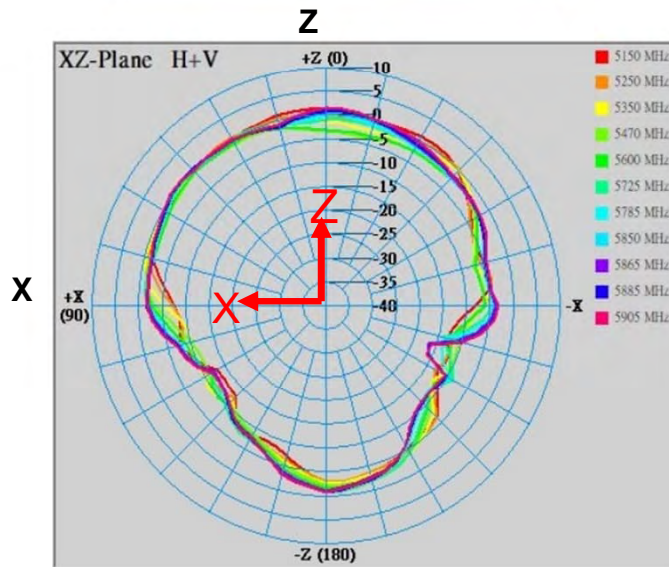
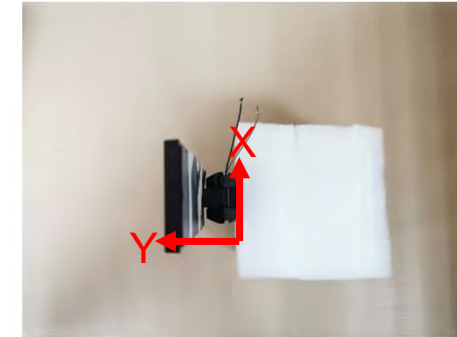
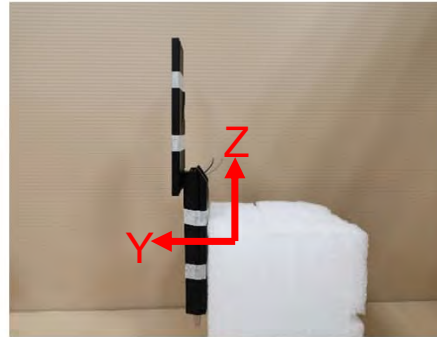
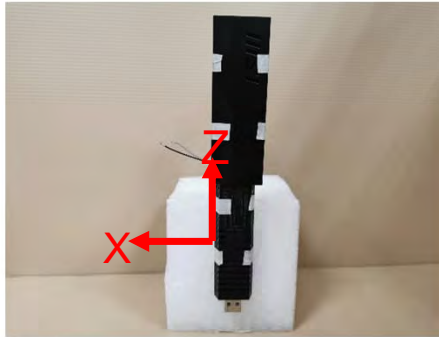

2D Radiation Pattern Results



Ant-2 (6G)

180 Degree

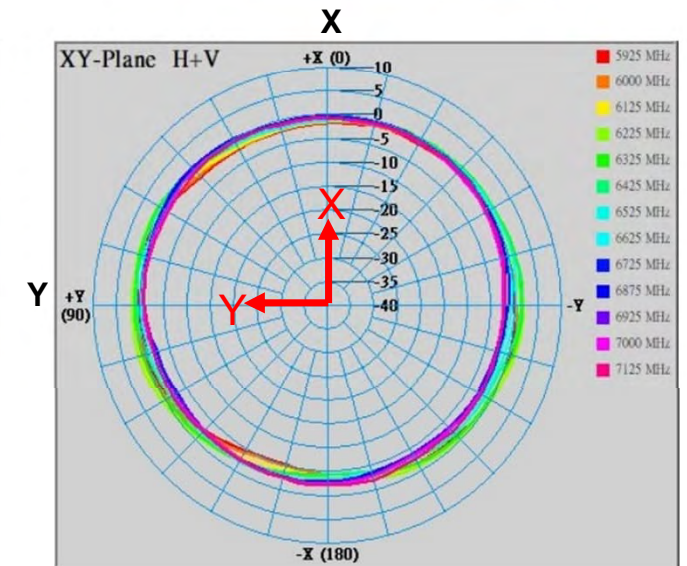
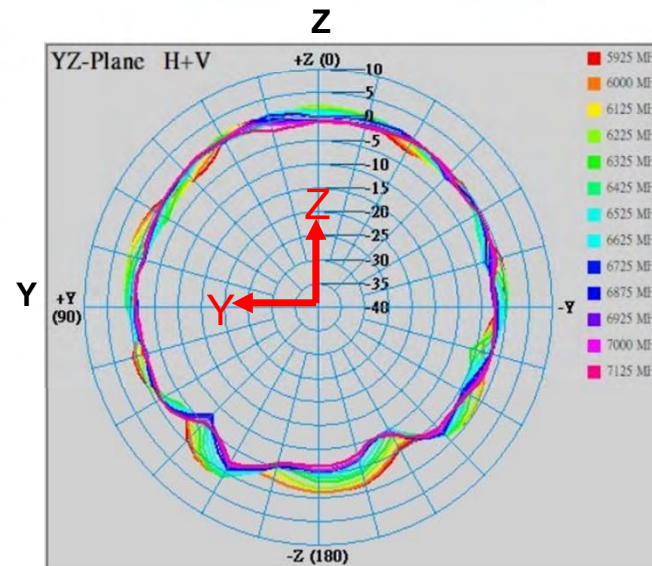
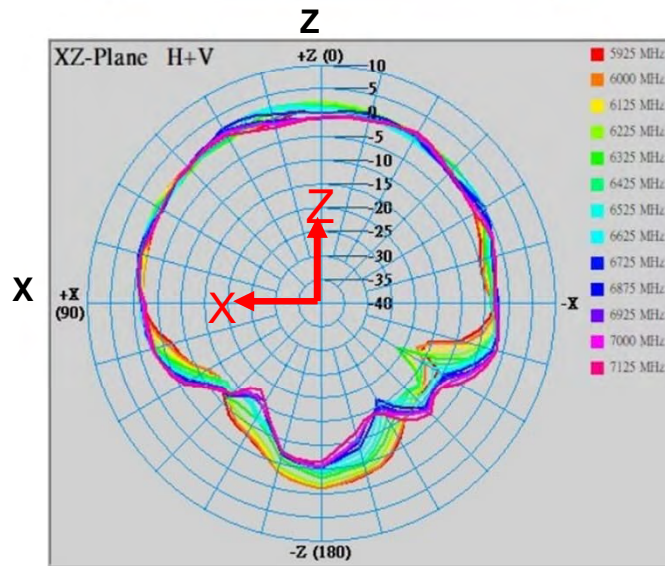
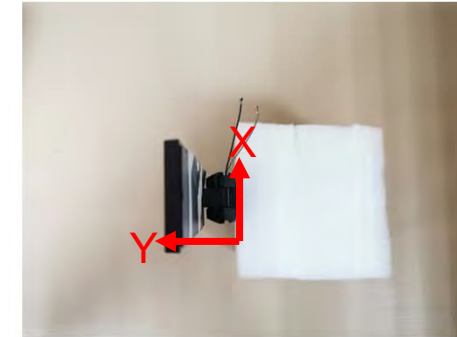
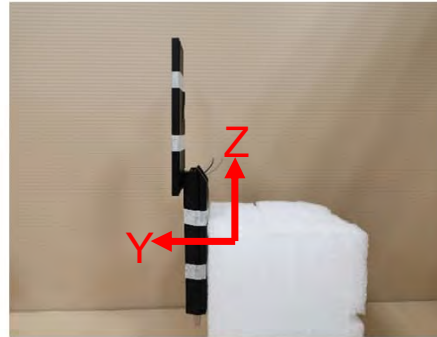
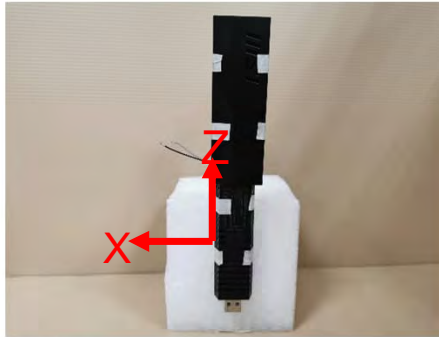

Test Setup for Radiation Pattern Measurement



Test Setup for DUT

90 Degree

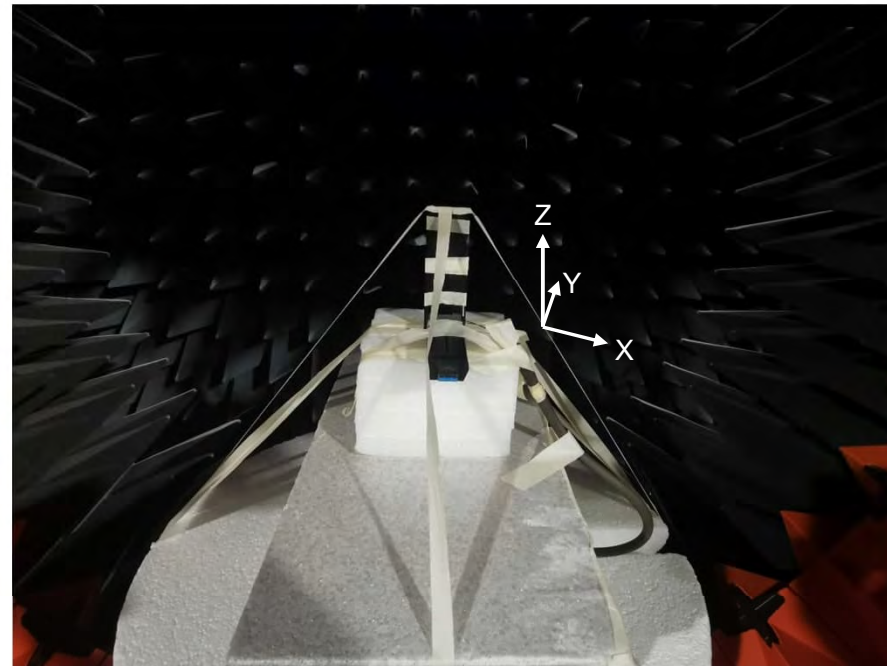

2D Radiation Pattern Results



Ant-1 (2G)

90 Degree

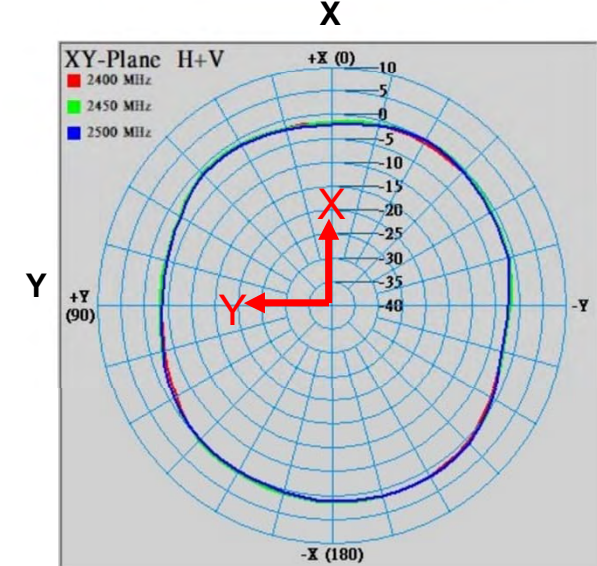
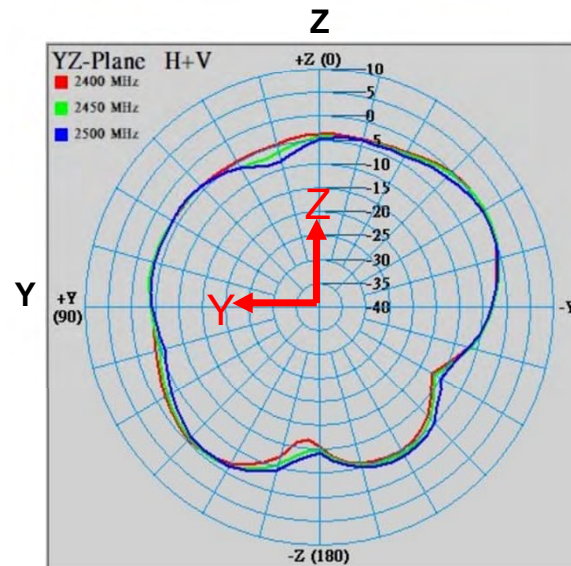
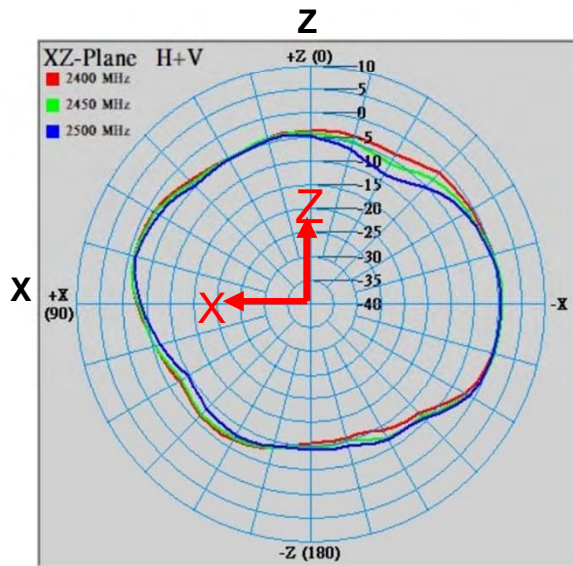
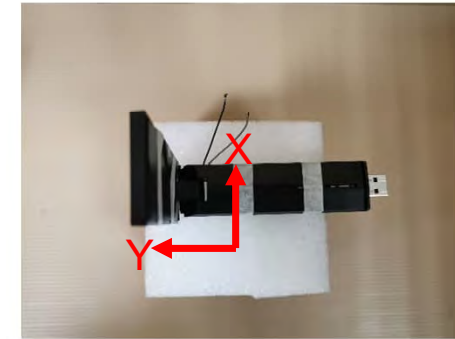
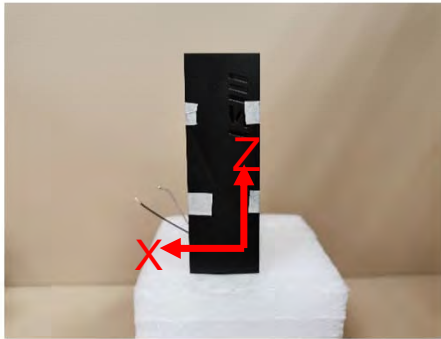

2D Radiation Pattern Results



Ant-1 (5G)

90 Degree

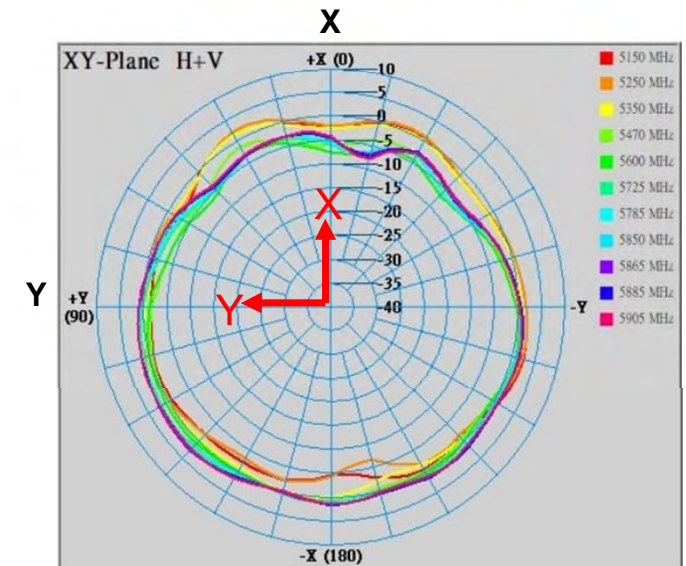
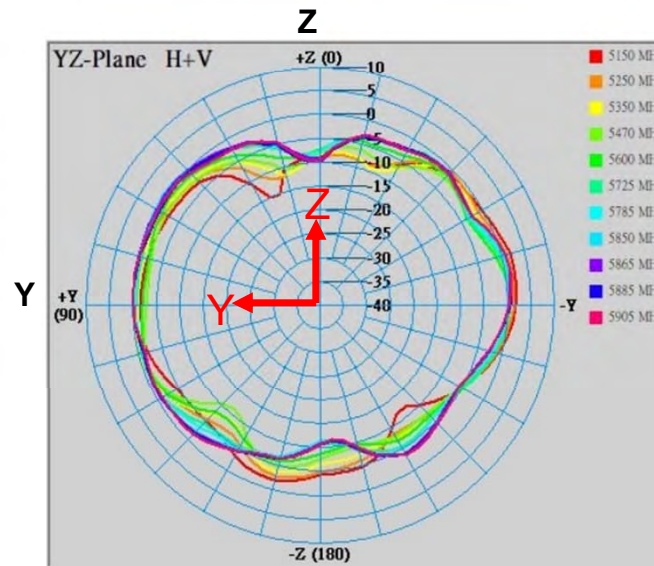
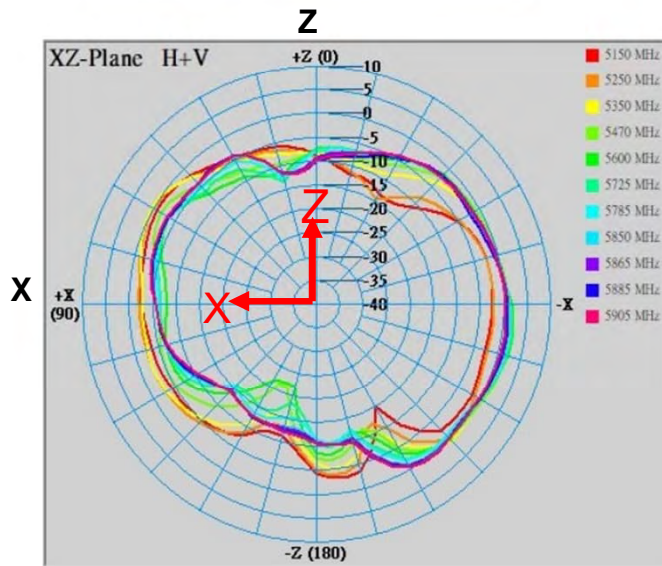
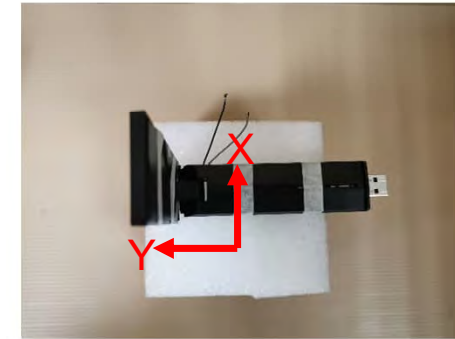
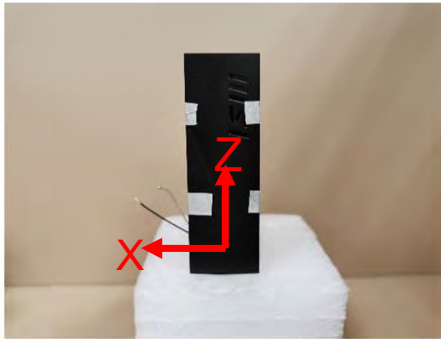

2D Radiation Pattern Results



Ant-1 (6G)

90 Degree

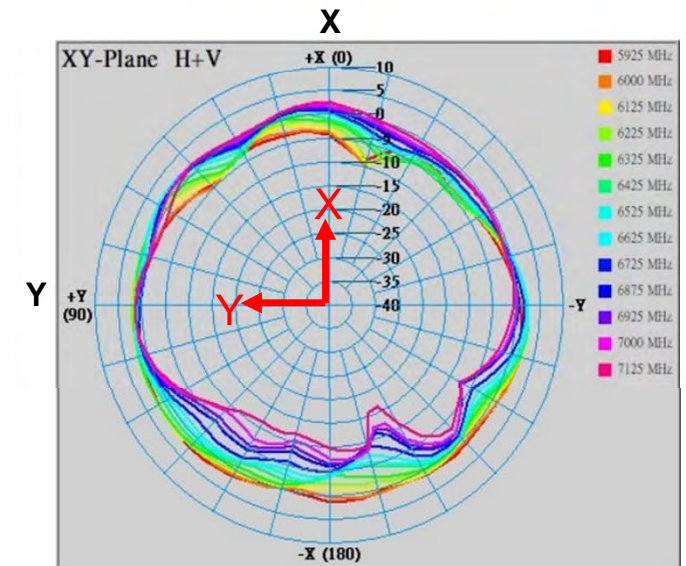
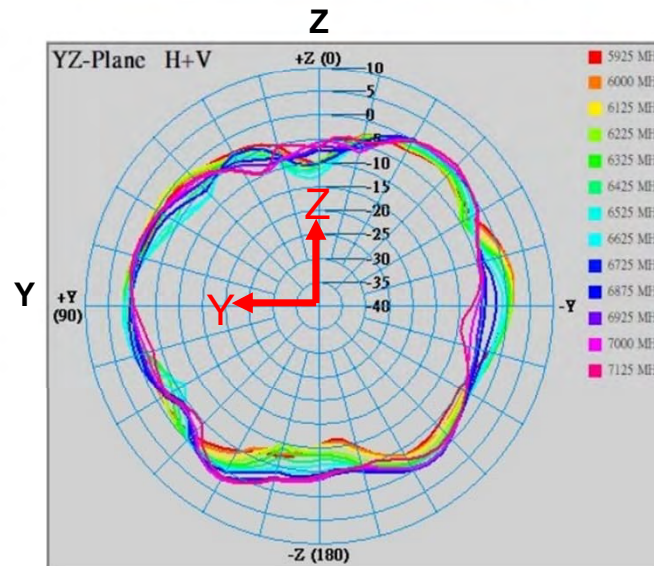
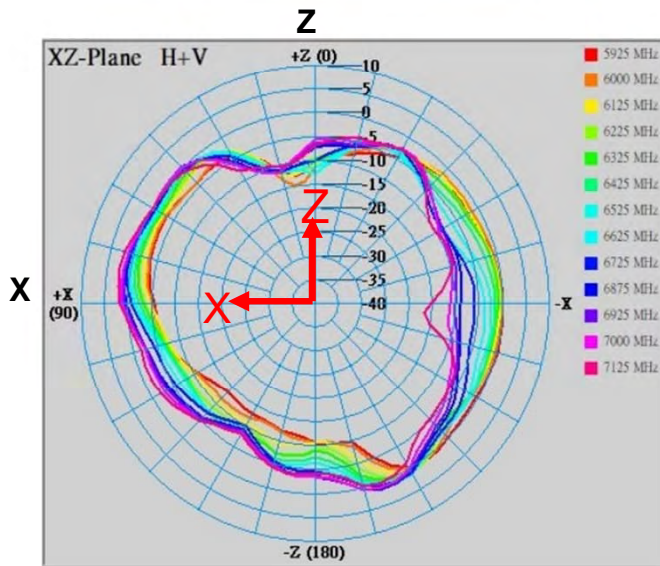
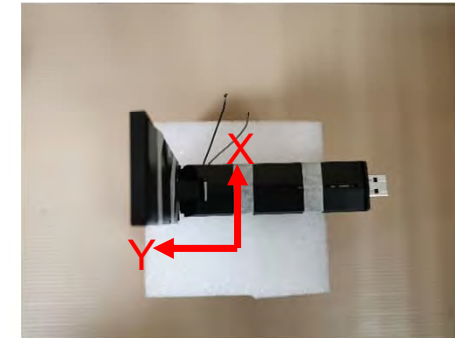
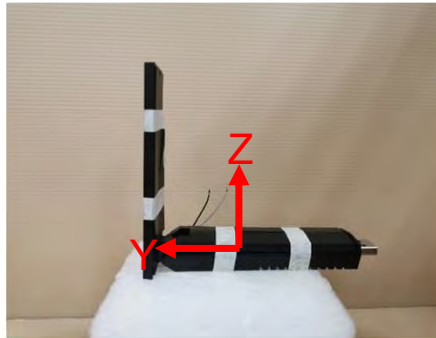
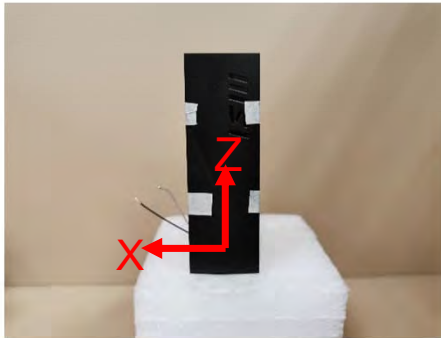

2D Radiation Pattern Results



Ant-2 (2G)

90 Degree

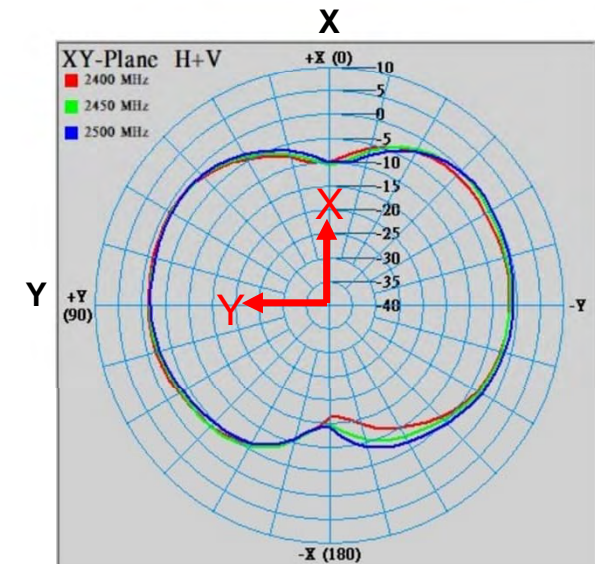
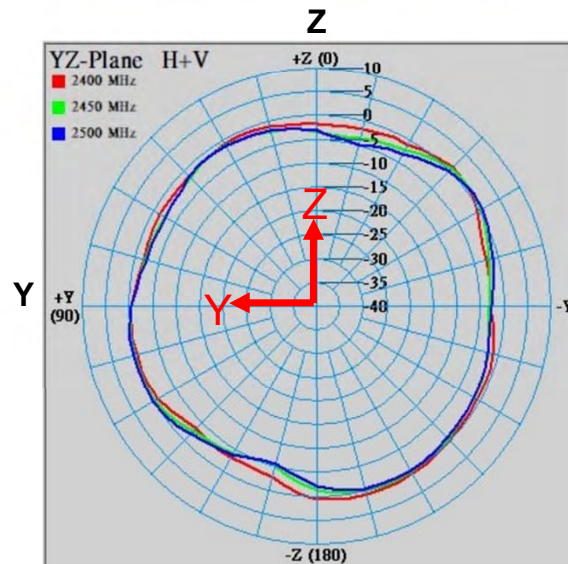
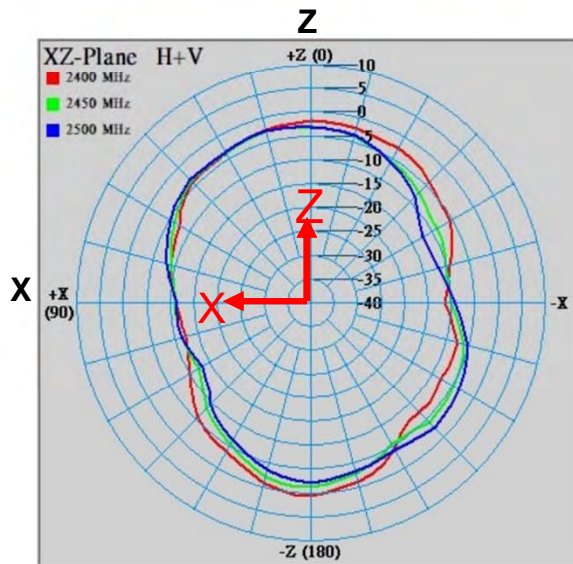
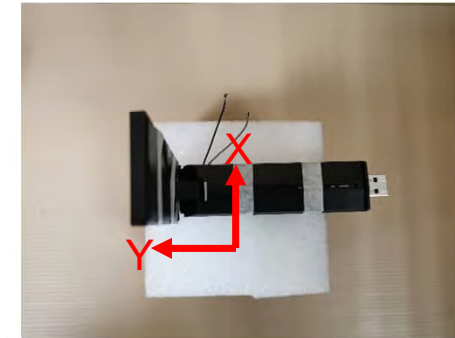
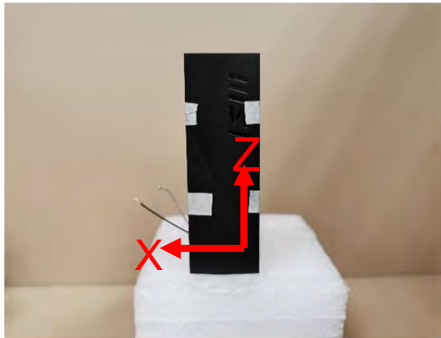

2D Radiation Pattern Results



Ant-2 (5G)

90 Degree

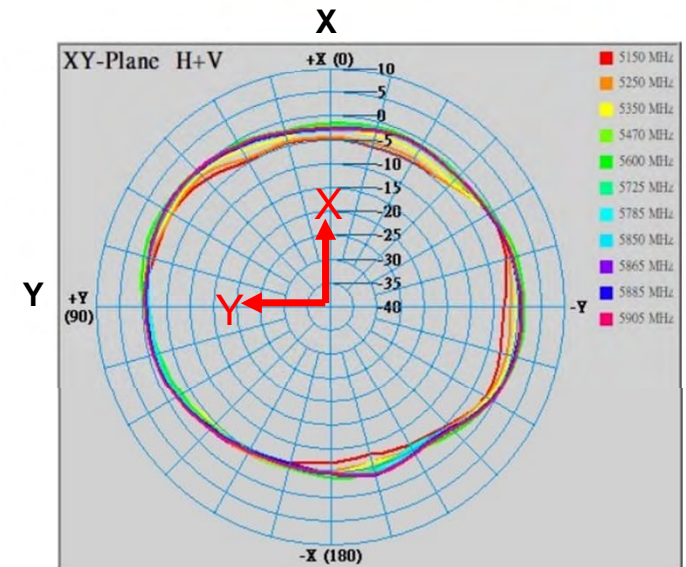
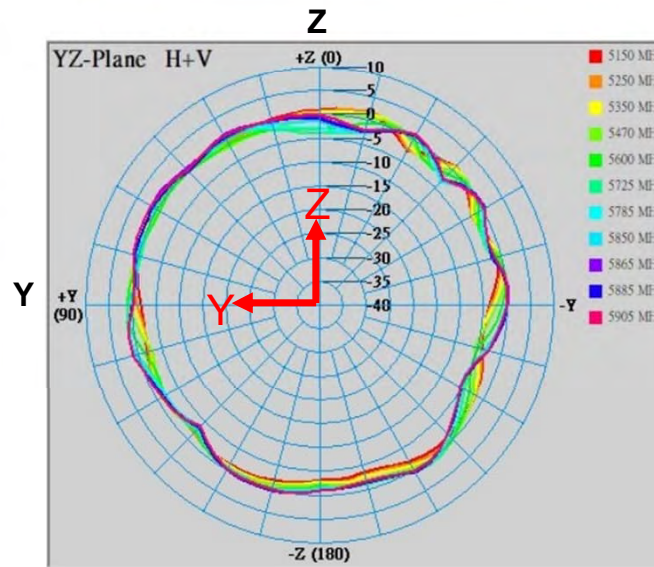
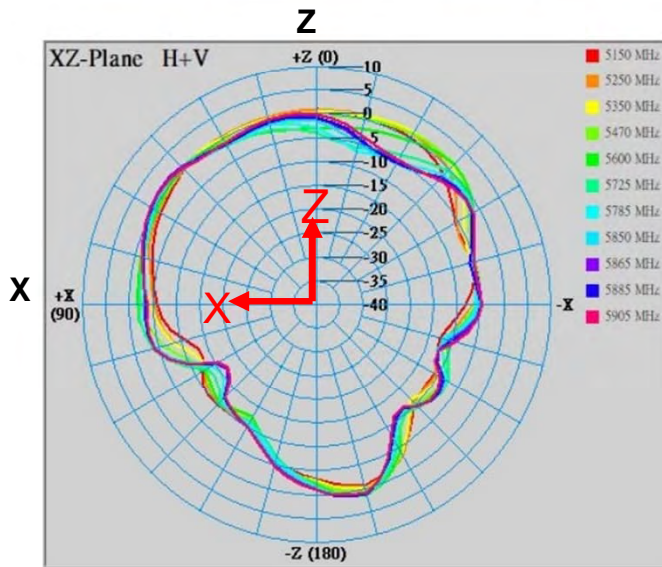
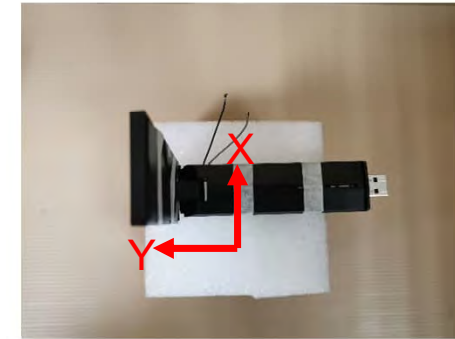
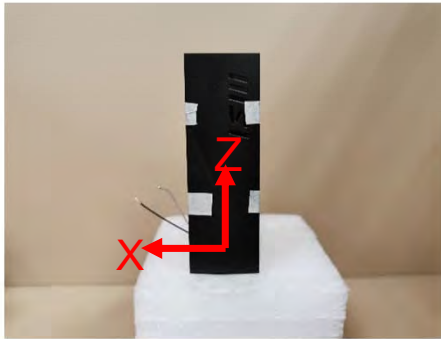

2D Radiation Pattern Results



Ant-2 (6G)

90 Degree

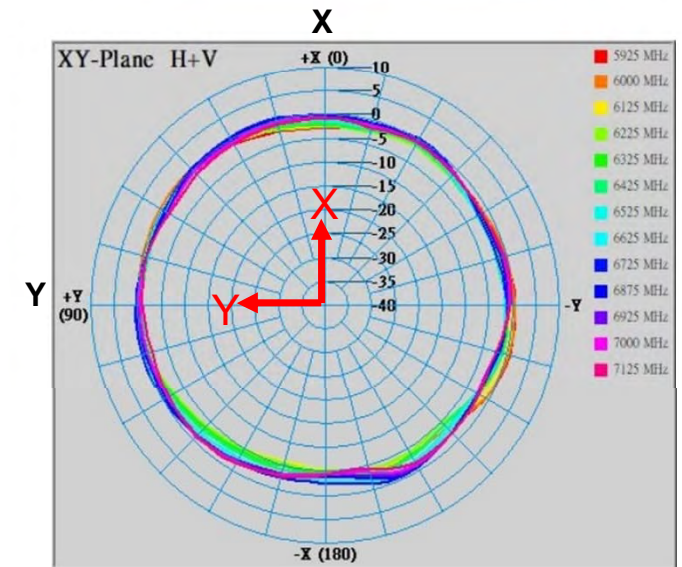
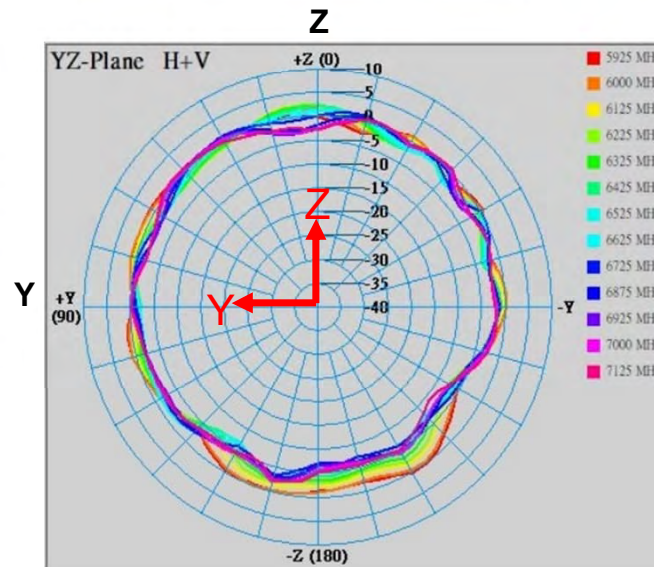
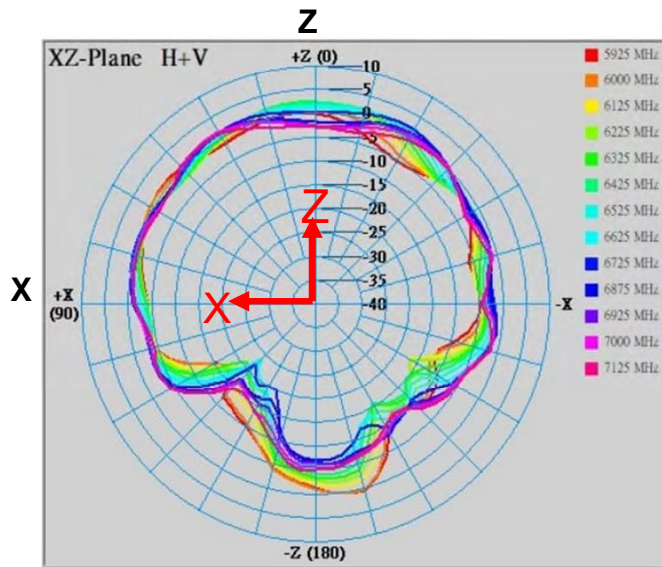
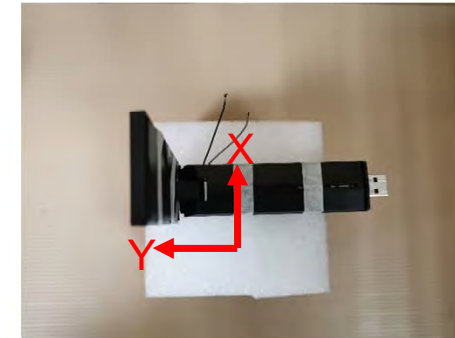
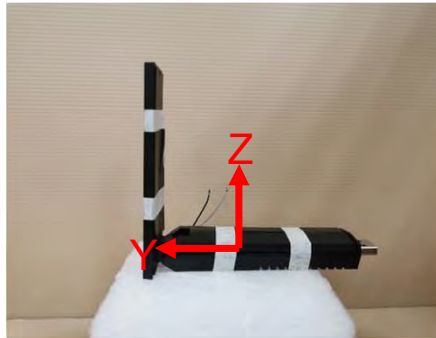
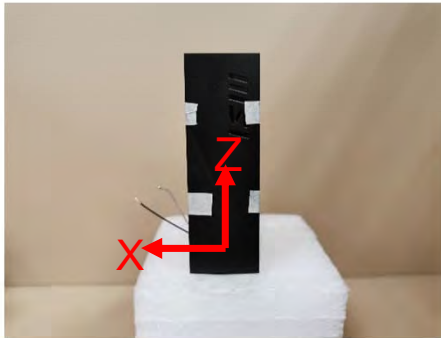

Return Loss

180 Degree

Frequency(MHz)	Ant.1 (dB)	Ant.2 (dB)
2400	11.8	12.1
2450	29.5	14.1
2500	12.2	11.8
5150	15.8	12.4
5550	23.6	12.2
5850	17.3	15.9
5925	16.7	14.9
6525	29.4	14.5
7125	21.3	17.6

90 Degree

Frequency(MHz)	Ant.1 (dB)	Ant.2 (dB)
2400	12.2	12.0
2450	39.0	14.3
2500	12.8	14.2
5150	16.7	14.2
5550	28.9	12.0
5850	18.3	15.9
5925	16.8	16.0
6525	28.1	14.5
7125	20.4	17.6

Isolation



180 Degree

Frequency (MHz)	Ant.1-Ant.2 (dB)
2400	21.5
2450	20.3
2500	20.3
5150	25.8
5550	24.2
5850	28.1
5925	29.8
6525	31.6
7125	27.9

90 Degree

Frequency (MHz)	Ant.1-Ant.2 (dB)
2400	20.5
2450	20.9
2500	23.6
5150	23.3
5550	23.6
5850	27.2
5925	28.6
6525	37.1
7125	28.8

3D Peak Gain & Efficiency



180 Degree

Frequency (MHz)	Ant.1		Ant.2	
	Peak Gain (dBi)	Efficiency (%)	Peak Gain (dBi)	Efficiency (%)
2400	1.57	67	1.54	66
2450	1.76	70	1.37	71
2500	1.82	67	1.56	69
5150	2.26	66	2.67	69
5250	2.38	65	1.96	70
5350	1.57	65	2.67	70
5470	2.42	63	2.28	71
5600	2.54	67	2.09	72
5725	2.58	69	2.66	71
5785	2.18	67	2.57	70
5850	2.41	68	1.97	69
5865	2.49	69	2.26	70
5885	2.55	68	2.10	68
5905	2.51	68	2.30	69

Frequency (MHz)	Ant.1		Ant.2	
	Peak Gain (dBi)	Efficiency (%)	Peak Gain (dBi)	Efficiency (%)
5925	2.54	67	2.08	68
6000	2.61	68	2.10	69
6125	2.60	67	2.16	69
6225	2.78	69	2.26	71
6325	2.40	67	1.96	69
6425	2.04	64	2.39	68
6525	2.20	67	2.45	69
6625	2.14	67	2.43	69
6725	2.09	66	2.12	67
6875	2.37	67	1.57	66
6925	2.25	66	1.45	65
7000	2.46	66	1.39	66
7125	2.30	63	1.37	64

3D Peak Gain & Efficiency



90 Degree

Frequency (MHz)	Ant.1		Ant.2	
	Peak Gain (dBi)	Efficiency (%)	Peak Gain (dBi)	Efficiency (%)
2400	1.69	68	1.58	65
2450	1.78	71	1.62	66
2500	1.55	66	1.67	67
5150	2.70	67	2.33	68
5250	2.52	67	2.31	68
5350	1.84	65	2.36	68
5470	2.40	63	2.15	69
5600	2.67	66	2.27	71
5725	2.62	68	1.94	70
5785	2.13	67	1.81	70
5850	2.48	67	1.98	68
5865	2.61	69	2.36	69
5885	2.44	67	2.27	67
5905	2.47	68	2.17	68

Frequency (MHz)	Ant.1		Ant.2	
	Peak Gain (dBi)	Efficiency (%)	Peak Gain (dBi)	Efficiency (%)
5925	2.28	66	2.22	67
6000	2.45	67	2.04	67
6125	2.54	65	2.76	67
6225	2.70	68	2.76	69
6325	2.80	67	2.58	67
6425	2.62	65	2.28	66
6525	2.69	67	2.17	67
6625	2.61	67	2.24	67
6725	2.31	66	2.28	65
6875	2.63	66	1.80	63
6925	2.64	65	1.84	62
7000	2.53	65	1.78	63
7125	2.56	62	1.57	62



Thank You

WWW.WHAYU.COM

© WHA YU INDUSTRIAL CO., LTD., All Rights Reserved.



江阴凯博通信科技有限公司

JiangYin KaiBo Communication Technology CO.,LTD.

DATE : 2021-11-1

Page: 1 to 3

规格书

Specification

系列 RF0.81 (50 Ω)
Series



江阴凯博通信科技有限公司

JiangYin KaiBo Communication Technology CO.,LID.

DATE : 2021-11-1

Page: 2 to 3

1. 结构图/Configuration



2. 结构/Construction:

项目/Item		详细资料/Details
①内导体 Inner conductor	材料/Material	镀银铜线 Silverplated copper wire
	构成(根/mm)/Composition(No./mm)	7/0.05±0.005
	标称直径/NOM. O. D	0.15±0.01
②绝缘层 Insulation	材料/Material	聚全氟乙丙烯/FEP
	标称外径/NOM. O. D	0.41±0.03
	颜色/Color	Natural
③外导体 Outer conductor	材料/Material	镀锡铜线 Tinned copper
	形式 Type	编织/Weaving
	构成/Composition	16/3/0.05±0.005
	遮蔽率/ Shielding rate	≥90%
④护套层 Jacket	材料/Material	聚全氟乙丙烯/FEP
	标称外径/NOM. O. D	0.81±0.05
	颜色/Color	黑色/Black

3. 性能特性 Performance characteristics

项目/Item	单位/Unit	详细资料/Details	
电容/Capacitance	pF/m	98	
特性阻抗/Conductor Resistance	Ω	50±3.0	
耐压强度/Dielectric Strength	A. C V/1min	1000	
最大工作频率/Max. oper. frequency	MHz	6000	
抗拉强度/Tensile strength	kgf/mm ²	1.76	
衰减/Attenuation	/	频率/Frequency	dB/1m
		1GHz	≤3.6
		2GHz	≤5.1
		3GHz	≤6.2
		4GHz	≤7.5
		5GHz	≤8.5
驻波比/Standing wave (0-6GHz)	/	≤1.3	



江阴凯博通信科技有限公司

JiangYin KaiBo Communication Technology CO.,LID.

DATE : 2021-11-1

Page: 3 to 3

4. 机械性能特性 Mechanical characteristics

项目 Item	单位 Unit	详细资料/Details
最小弯曲半径(一次) Min.bending radius static	mm	4
工作温度范围 Operating temperature	°C	-55to200

5. 使用提示 Use tips

存储环境 Storage environment	温度：30°C以下；湿度：20%~65%
最佳保存周期 The best save cycle	2个月，2个月以上锡效果变差，但电性能不受影响，夏季高温高湿环境开剥后需尽快流转
加工温度 Processing temperature	250°C~260°C的情况下，可短时间承受；300°C以上会出现热分解现象
铁氟龙收缩 Teflon Shrink	绝缘层收缩 $\leq 0.2\text{mm}$ ；护套层收缩 $\leq 0.3\text{mm}$

6. 包装 Packing

标准单位包装长度为1000米/盘，每盘最多允许5个接头，接头最短长度10米，在搬运过程中不能损坏包装。

Standard unit for the 1000m/reel length of packaging, each set up to allow 5 joints, the joint shortest length of 10m, The finished cable shall be packed not be damaged during transportation.

7. 其他 Other

特殊加工工艺，请与供方协商后使用。

Special processing technology, please use after consultation with the supplier.



AVLV2.E349435 - Appliance Wiring Material - Component

Appliance Wiring Material - Component

[See General Information for Appliance Wiring Material - Component](#)

JIANGYIN KAIBO COMMUNICATION TECHNOLOGY CO LTD
No.83 Dong Ding Rd. Mountain View Town
Jiangyin, Jiangsu 214400 CHINA

E349435

Table of Recognized Styles

Single-conductor, thermoplastic insulation.							
<u>1007</u>	<u>1061</u>	<u>1569</u>	<u>10064</u>	<u>10304</u>	<u>10369</u>	<u>11149</u>	
<u>1015</u>	<u>1354</u>	<u>1571</u>	<u>10248</u>	<u>10368</u>	<u>10871</u>	<u>11180</u>	
Single-conductor, thermoset insulation.							
<u>3302</u>	<u>3385</u>	<u>3386</u>	<u>3619</u>				

Marking: Company name, voltage rating, temperature rating, conductor size, conductor material if other than copper, and use.

Last Updated on 2021-01-15

并不是所有出现在本数据库中的公司名称和产品都满足了UL 跟踪检验服务的要求。只有带有 UL 标志的产品，才应该被视为经过UL 认证，并满足UL 跟踪检验服务的要求。注意查看产品上的标志。

UL 允许在线认证目录中所含材料的复制遵循以下条件：1.指南信息、装配、构造、设计、系统和/或认证（文件）必须在不篡改任何数据（或图纸）的情况下完整且无误导性地呈现。2.“经 UL 允许从在线认证目录转载”声明必须出现在所摘取材料的邻近位置。此外，转载材料必须包含以下格式的版权声明：“© 2021 UL LLC”



APPLIANCE WIRING MATERIAL

Subj.758 Section 1 Page 1354

Issued:1964-02-19

Revised:2009-04-30

Style 1354 Coaxial Cable.

Rating	60, 80 deg C, 30 Vac, Horizontal flame.
Conductor	44 AWG min., material not specified.
Insulation	2 mils minimum at any point, 125 mils maximum. The insulation may be: Extruded solid or cellular PE, FRPE, PP, PFA, FEP, ECTFE, PTFE, ETFE, or combination thereof with or without irradiation; or tape wrapped solid or cellular PTFE, PFA, or FEP. Applied as a spiral wrapped thread (5 mils minimum, 40 mils maximum) and enclosed in a tube of insulation.
Assembly	Insulated conductor with optional inner covering, optional inner shield, optional middle covering, required outer shield and required outer covering.
Shield	Optional. Outer Shield required.
Covering	Optional Inner Covering - Extruded PVC, PFA, Polyamide, Polyester, PVDF, FEP, PTFE, ECTFE, ETFE, PE, XLPE, XLFRPE or FRPE; lacquered braids; heat sealed PTFE, PFA or FEP tape; Polyester or Polyester-Polyethylene film. Thicknesses not specified. Optional Middle Covering - Extruded PVC, PFA, PP, Polyamide, Polyester, PVDF, FEP, PTFE, ECTFE, ETFE, PE, XLPE, XLFRPE or FRPE; lacquered braids; heat sealed PTFE, PFA or FEP tape; Polyester or Polyester-Polyethylene film. Thicknesses not specified. Required Outer Covering - Extruded Irradiated PE, Irradiated PVC, Polyurethane, PVC, PFA, PP, Polyamide, Polyester, PVDF, FEP, PTFE, ECTFE, ETFE, PE, XLPE, XLFRPE or FRPE; lacquered braids; heat sealed PTFE, PVC, PFA or FEP tape; Polyester or Polyester-Polyethylene film. Thicknesses not specified.
Standard	Appliance Wiring Material UL 758.

Marking

General.

Use

Internal wiring of Class 2 circuits of electronic equipment or as insulated single in jacketed multiconductor cables.

UL and the UL Logo are trademarks of UL LLC © 2012



謹裕實業股份有限公司

WHA YU INDUSTRIAL CO., LTD

Connector 材質證明書

謹裕料號 Whayu P/N	Z101-02110049-A1	產品名稱 Product Name	MHF Plug for ϕ 0.81 Coaxial Cable
-------------------	------------------	----------------------	--

結構圖面

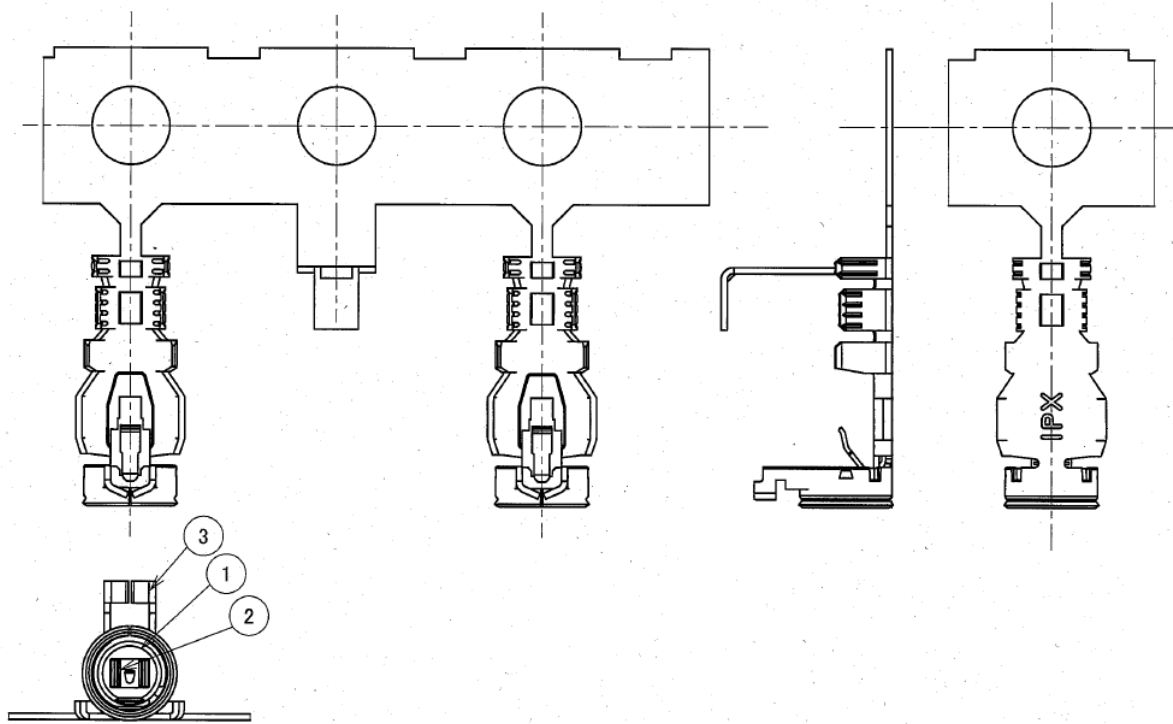

材質成份

表面處理

		材質成份							表面處理	
1	Housing	PBT	Polybutylene Terephthalte(UL 94V-0)							Black
2	Contact	Phosphor Bronze	Cu	Su	P	Zn	Pb		Au over Ni	
3	Ground Contact	Phosphor Bronze	Cu	Su	P	Zn	Pb		Au over Ni	

Remark :

請蓋公司章

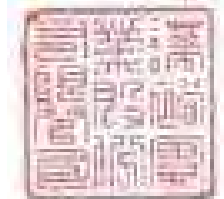

材料証明書 MATERIAL CERTIFICATE

No. MC- 13007

当社製品には下記の材料が使われている事を証明致します。
WE HEREBY CERTIFY THAT THE FOLLOWING MATERIALS ARE USED IN OUR PRODUCT.

PRODUCT NAME :MHF4L PLUG ASS'Y(0.81)

PART No. :20572-001R-08

	部品 COMPONWNT	材料 / MATERIAL			UL 難燃性 UL94 FLAME CLASS	UL ファイル No. UL FILE No.
		材質名 MATERIAL	型名 CAT No.	材料メーカー MANUFACTURER		
1	Housing	PBT	DURANEX 310NF	Wintech Polymer Ltd.	V-0	E213445
2	Main Contact	Phosphor Bronze	C5210R- SH	JX Nippon Mining & Metals Co.,Ltd.	-----	-----
				HARADA METAL INDUSTRY		
3	Ground Contact	Phosphor Bronze	C5210R- H	JX Nippon Mining & Metals Co.,Ltd.	-----	-----

					Prepared by	Reviewed by	Approved by
0	S13063	S.S	Feb./25/'13		S.Suzuki Feb./25/'13	K.Yotsutani Feb./25/'13	T.Takano Feb./25/'13
REV.	ECN	BY	DATE	APP.			
REVISION RECORD							

DOCUMENT CLASSIFICATION 材料証明書 MATERIAL CERTIFICATE	TITLE MHF5 Plug Ass'Y	No. MC- 12034
--	--------------------------	------------------

Plug Housing

Component - Plastics E213445

WINTECH POLYMER LTD
18-1 KONAN 2-CHOME, MINATO-KU, TOKYO 108-8280 JP

XFR 4840 GF10 (w), 310NF (w)

Polybutylene Terephthalate (PBT), "Duranex", furnished as pellets

Color	Min Thk (mm)	Flame Class	RTI		RTI		RTI
			HWI	HAI	Elec	Imp	Str
ALL	0.75	V-0	1	0	130	125	125
	1.5	V-0	1	0	130	125	125
	3.0	V-0,5VA	1	0	130	125	125

Comparative Tracking Index (CTI): 1 Inclined Plane Tracking (IPT): -
 Dielectric Strength (kV/mm): 24 Volume Resistivity (10¹¹ ohm-cm): 14
 High-Voltage Arc Tracking Rate (HVTR): 0 High Volt, Low Current Arc Resis (D495): 5
 Dimensional Stability (%): -

(w) - Virgin and regrind up to 50% by weight inclusive, have the same flame characteristics only.

ANSI/UL 94 small-scale test data does not pertain to building materials, furnishings and related contents. ANSI/UL 94 small-scale test data is intended solely for determining the flammability of plastic materials used in the components and parts of end-product devices and appliances, where the acceptability of the combination is determined by UL.

Report Date: 2006-07-24 
 Last Revised: 2012-11-27 © 2013 UL LLC

IEC and ISO Test Methods

Test Name	Test Method	Units	Thickness Tested (mm)	Value
Flammability	IEC 60695-11-10, IEC 60695-11-20	Class (color)	0.75	V-0 (ALL)
			1.5	V-0 (ALL)
			3.0	V-0,5VA (ALL)
Glow-Wire Flammability (GWFI)	IEC 60695-2-12	C	-	-
Glow-Wire Ignition (GWIT)	IEC 60695-2-13	C	-	-
IEC Comparative Tracking Index	IEC 60112	Volts (Max)	-	-
IEC Ball Pressure	IEC 60695-10-2	C	-	-
ISO Heat Deflection (1.80 MPa)	ISO 75-2	C	-	-
ISO Tensile Strength	ISO 527-2	MPa	-	-
ISO Flexural Strength	ISO 178	MPa	-	-
ISO Tensile Impact	ISO 8256	kJ/m ²	-	-
ISO Izod Impact	ISO 180	kJ/m ²	-	-
ISO Charpy Impact	ISO 179-2	kJ/m ²	-	-

© 2013 UL LLC

物质安全资料表

一、物品与厂商资料

物品名称：无卤聚酰亚胺铜箔基板(Halogen-free PI -CCL)
物品编号：SHIS or SHID
制造商或供货商名称 / 地址 / 电话/传真： 苏州蔡伦格蒂电子材料有限公司/江苏省太仓市太平北路 168 号辛龙工业园 2#楼 /0512-5337 8333/0512-5337 8355
紧急联络电话/传真电话： 0512-5337 8333/0512-5337 8355

二、成分辨识资料

纯物质：

中英文名称： 1. 无卤环氧树脂接着剂 2. 聚酰亚胺膜 3. 铜箔
同义名称： -
化学文摘社登记号码(CAS No.)： 1. (无卤环氧树脂接着剂) 24969-06-0 25% ~ 41.2% 2. (聚亚酰胺膜) 25038-81-7 17.4% ~ 39.6% 3. (铜箔) 7440-50-8 28.7% ~ 48%
有害物质成分(成分百分比)： < 15(无卤环氧树脂接着剂)

三、危害辨识数据

最重 要危 害与 效应	健康危害效应：对人体无危害。
	环境影响： -
	物理性及化学性危害： -
	特殊危害： -
主要症状： -	
物品危害分类： -	

四、急救措施

不同暴露途径之急救方法： 吸入：胶膜无途径吸入。 皮肤接触：无刺激。 眼睛接触：无挥发物可接触。 食入：胶膜无可能途径。
最重要症状及危害效应： -
对急救人员之防护： -
对医师之提示： -

五、灭火措施

适用灭火剂：使用适于隔离火场的灭火剂。
灭火时可能遭遇之特殊危害：高温裂解物质的吸入。
特殊灭火程序： -
消防人员之特殊防护设备：配戴空气呼吸器及防护手套、消防衣。

六、泄漏之紧急应变

个人应注意事项：使用个人防护设备。
环境注意事项： -
清理方法： -

七、安全处置与储存方法

处置：操作时, 与食物、饮料隔离。
储存：储存在阴凉、干燥、通风良好的地方。

八、暴露预防措施

工程控制： -
控制参数：

八小时日时量平均容许浓度/短时间时量平均容许浓度/最高容许浓度： -
 生物指标： -
 个人防护设备：
 呼吸防护： 防尘口罩。
 手部防护： 手套。
 眼睛防护： 安全眼镜。
 皮肤及身体防护： -。

九、物理及化学性质

物质状态：	固体	形状：	膜状
颜色：	浅棕 ~ 深棕 (PI 侧)	气味：	无
pH 值：	N/A	沸点/沸点范围：	N/A
分解温度：	N/A	闪火点：	N/A 测试方法：开杯 闭杯
自燃温度：	N/A	爆炸界限：	N/A
蒸气压：	N/A	蒸气密度：	N/A

十、安定性及反应性：

安定性：	正常状况下安定
特殊状况下可能之危害反应：	-
应避免之状况：	-
应避免之物质：	-
危害分解物：	高热分解产生氮，磷氧化气体。

十一、毒性资料

急毒性：	N/A
局部效应：	N/A
致敏感性：	N/A
慢毒性或长期毒性：	N/A
特殊效应：	N/A

十二、生态资料

可能之环境影响/环境流布： -

十三、废弃处置方法

依当地环保法规处理方式。

十四、运送资料

国际运送规定：	不适用于 IATA、ICAO。(非危险物品)
联合国编号：	--
国内运送规定：	--
特殊运送方法及 注意事项：	--

十五、法规资料

适用法规：适用于 RoHS、GP、WEEE。

十六、其它数据

参考文献：	--	
制表单位：	名称：	苏州蔡伦格蒂电子材料有限公司
	地址/电话：	江苏省太仓市太平北路 168 号幸龙工业园 2#楼/ 0512-5337 8333
制表人：	职称：主管	姓名：黄龙
制表日期：	2019. 2. 16	
备注：	上述数据中符号“-”代表目前查无相关资料。 对上述数据已力求正确，各项数据与数据仅供参考，使用者请依应用需求，自行判断其可用性。	



Double Coated Tissue Tape

9448A/9448AB

Technical Data

Jan 2009

Product description 9448A/9448AB: 3M™ Double Coated Tissue Tape for dimensional stability and improved handling with ease of die cutting and laminating. The high adhesion adhesive provides excellent adhesion to a variety of surfaces.

Construction

9448A/9448AB

Faceside ¹ Adhesive Type/Thickness:	Acrylate /0.003" (0.076mm)
Backside ² Adhesive Type/Thickness:	Acrylate/0.003" (0.076mm)
Liner Color, Type, Print	White, 120gsm PCK , 3M logo
Liner Caliper:	0.0056" (0.14mm)
Carrier Type:	Tissue
Tape color:	Translucent/Black

Note 1: Faceside adhesive is on the interior of the roll, exposed when unwound.

Note 2: Backside adhesive is on the exterior of the roll, exposed when liner is removed.

3M™ Double Coated Tissue Tape 9448A/9448AB

Typical Physical Properties and Performance Characteristics

Note : The following technical information and data should be considered representative or typical only and should not be used for specification purposes.

180 degree peel adhesion ASTM D3330, 2mil PET backing

Adhesion to Stainless steel	N/100mm
- 30 minute RT	135
- 72 hours RT	140

Adhesion to PC

- 30 minute RT	135
- 72 hours RT	140

Adhesion to PP

- 30 minute RT	100
- 72 hours RT	105

Shear Strength – ASTM D3654
(1 inch² sample size)

1000grams at 72° F (22°C)	5000 minutes
---------------------------	--------------

Relative solvent resistance	Medium
-----------------------------	--------

UV Resistance	Medium
---------------	--------

Relative High Temperature

Operating Ranges:

Long Term (days, weeks)	70°C
Short Term (minutes, hours)	150°C

Shelf Life of Tape in Roll Form	24 months from date of manufacture when stored in original cartons at 70° F (21°C) and 50% relative humidity.
---------------------------------	---

3M™ Double Coated Tissue Tape 9448A/9448AB

Application Techniques Bond strength is dependent upon the amount of adhesive-to-surface contact developed. Firm application pressure helps develop better adhesive contact and improves bond strength.

To obtain optimum adhesion, the bonding surfaces must be clean, dry and well unified. Some typical surface cleaning solvents are isopropyl alcohol or heptane.

Note: Carefully read and follow the manufacturer's precautions and directions for use when working with solvents.

Ideal tape application temperature range is 70°F to 100°F (21°C to 38°C). Initial tape application to surfaces at temperatures below 50°F (10°C) is not recommended because the adhesive becomes too firm to adhere readily. However, once properly applied, low temperature holding is generally satisfactory.

General Information All tapes have a tissue carrier, which can add dimensional stability to foams and other substrates. The carrier also provides easier handling during slitting and die-cutting.

Features 3M™ Adhesive is a medium-firm acrylic adhesive system featuring both high initial adhesion and good high temperature holding power.

Application Ideas

- Nameplate bonding
- Plastic film lamination/bonding
- Foam bonding

Application Equipment To apply adhesives in a wide web format, lamination equipment is required to ensure acceptable quality. To learn more about working with pressure-sensitive adhesives please refer to technical bulletin, Lamination Techniques for Converters of Laminating Adhesives.

For additional dispenser information, contact your local 3M sales representative.

3M™ Double Coated Tissue Tape 9448A/9448AB

Certification/ Recognition

MSDS: 3M has not prepared a MSDS for the products which are not subject to the MSDS requirements of the Occupational Safety and Health Administration's Hazard Communication Standard, 29 C.F.R.

TSCA: The product are defined as articles under the Toxic Substances Control Act and therefore, are exempt from inventory listing requirements.

Important Notice

3M MAKES NO WARRANTIES, EXPRESS OR IMPLIED, INCLUDING, BUT NOT LIMITED TO, ANY IMPLIED WARRANTY OF MERCHANTABILITY OR FITNESS FOR A PARTICULAR PURPOSE. User is responsible for determining whether the 3M product is fit for a particular purpose and suitable for user's method of application. Please remember that many factors can affect the use and performance of a 3M product in a particular application. The materials to be bonded with the product, the surface preparation of those materials, the product selected for use, the conditions in which the product is used, and the time and environmental conditions in which the product is expected to perform are among the many factors that can affect the use and performance of a 3M product. Given the variety of factors that can affect the use and performance of a 3M product, some of which are uniquely within the user's knowledge and control, it is essential that the user evaluate the 3M product to determine whether it is fit for a particular purpose and suitable for the user's method of application.

Limitation of Remedies and Liability

If the 3M product is proved to be defective, The exclusive remedy, at 3M'S option, shall be to refund the purchase price of or to repair or rplace the defective 3M product. 3M shall not otherwise be liable for loss or damages, whether direct, indirect, special, incidental, or consequential, regardless of the legal theory asserted, including, but not limited to, contract, negligence, warranty, or strict liability.

ISO 9002

This Engineered Adhesives Division product was manufactured under a 3M quality system registered to ISO 9002 standards.

3M

3M Maxdo, Xingyi Road 8
Shanghai, PRC.

• 3M 2009



OANZ2.E256906 Insulating Tape - Component

[Page Bottom](#)

Insulating Tape - Component

[See General Information for Insulating Tape - Component](#)

3M CHINA CO LTD
222 TIAN LIN RD
200223 SHANGHAI, CHINA

E256906

Cat. No.	Color	Temp (°C)	Optional Ratings		
			Flame Retardant+	Sunlight Resistant+	Cold Resistant+
Aluminum foil pressure sensitive insulating tapes					
1178	Silver	90	Yes	No	No
Cotton fiber insulating tapes					
55230	White	80	No	No	Yes
55235	White	80	No	No	Yes
Flame retardant acetate cloth tapes					
1558B	Black	-	Yes	No	No
Flame retardant AL foil/ PET film/ AL foil laminated tapes with conductive acrylic adhesive					
CEAP-4B	Silver	-	Yes	No	No
Flame retardant conductive coated PET fabrics with acrylic adhesive					
CEF-3	Gray	-	Yes	No	No
Flame retardant Cu/ Ni plated woven polyester fabric tapes with conductive acrylic adhesive					
CEF-1LAC	Gray	-	Yes	No	No
Flame retardant PET film/ AL foil laminated tapes with conductive acrylic adhesive					

CEAP-2T	Silver	-	Yes	No	No
CEAP-6B	Black	-	Yes	No	No
CEAP-6C	Black	-	Yes	No	No
Flame retardant PET film/ AL foil/ PET film laminated tapes with acrylic adhesive					
CEAP-5B	Black	-	Yes	No	No
Glass cloth insulating tapes					
CIG-1	White	150	Yes	No	No
PET film insulating tapes					
55256	White	80	No	No	Yes
55257	Clear	80	No	No	Yes
55258	White	80	No	No	Yes
iTAPE B01T	Black	130	No	No	No
Polyimide film insulating tape with acrylic adhesive					
BI-02	Amber	180	Yes	No	No
Polyimide film insulating tapes					
1206C	Amber	155	Yes	No	No
7411B	Black	155	Yes	No	No
7412P	Amber	155	Yes	No	No
7413D	Amber	220	Yes	No	No
7413DL	Amber	220	Yes	No	No
98C-12	Amber	155	Yes	No	No
Polyimide film insulating tapes with acrylic adhesive					
7412B	Black	135	Yes	No	No
7904	Yellow	130	No	No	No
PT-07	Black	180	Yes	No	No
Polyimide film insulating tapes with silicone adhesive					
7413-D	Amber	220	Yes	No	No

98C-1	Amber	220	Yes	No	No
Polyimide film with top coating insulating tapes with acrylic adhesive					
BI-02B	Black	180	Yes	No	No
Polyimide film, double sided adhesive tape					
MFI-7U (a)	White	150	No	No	No
PVC film insulating tapes					
55280	White	80	No	No	No
Woven cotton tissue, double sided adhesive insulating tapes					
55236	White	80	No	Yes	Yes
9448A	White	80	No	Yes	Yes

+ Complies with "Flame Retardant" and/or "Cold Resistant" and/or "Sunlight Resistant" requirements if authorized in the table above and when so marked.
(a) - May be marked "Film/adhesive side CTI Voltage 600 or greater, per IEC 60112, 4th Edition (2003), Material Group I" or equivalent.

Marking: Company name or tradename "E256906" and catalog designation printed on the central paper core or outer package.

Last Updated on 2017-08-02

[Questions?](#)

[Print this page](#)

[Terms of Use](#)

[Page Top](#)

© 2017 UL LLC

The appearance of a company's name or product in this database does not in itself assure that products so identified have been manufactured under UL's Follow-Up Service. Only those products bearing the UL Mark should be considered to be Certified and covered under UL's Follow-Up Service. Always look for the Mark on the product.

UL permits the reproduction of the material contained in the Online Certification Directory subject to the following conditions: 1. The Guide Information, Assemblies, Constructions, Designs, Systems, and/or Certifications (files) must be presented in their entirety and in a non-misleading manner, without any manipulation of the data (or drawings). 2. The statement "Reprinted from the Online Certifications Directory with permission from UL" must appear adjacent to the extracted material. In addition, the reprinted material must include a copyright notice in the following format: "© 2017 UL LLC".

SGS Test Report

Product : RF Antenna Assembly

Content

No	Description		Report No.	Page
1	Φ0.81mm Cable	Jacket Color Masterbatch Outer Conductor Insulation Inner Conductor	NGBEC24000586005 HKTEC2401654111 A2230496550101001 NGBPC24000131241 SHAEC23019069713	P.29~78
2	Connector	外殼 膠芯 導體 鍍金 鍍鎳	ETR24802273M01 EKR24400496 ETR24802273M01 SGACP240002404 SGACP240002406	P.79~98
3	FPCB	基板 Black ink White ink 鍍錫	SHAEC24000428805 TAOEC2306819101 TAOEC2307419101 (8824)054-0003	P.99~146
4	背膠	3M 9448A	CANEC24002135402	P.147~154

Result for RoHS : PASS

Test Report

No.: NGBEC24000586005

Date: Feb 05, 2024

Page 1 of 8

Client Name: JINHUA YONGHE FLUORO CHEMICAL CO., LTD

Client Address: QINGLIAN ROAD 896#, ECONOMIC AND TECHNOLOGICAL DEVELOPMENT ZONE (THE WEST), JINHUA, ZHEJIANG

Sample Name: FEP

Client Ref. Information: Niflon

The above sample(s) and information were provided by the client.

SGS Job No.: SHP24-003182

Sample Receiving Date: Jan 31, 2024

Testing Period: Jan 31, 2024 ~ Feb 05, 2024

Test Requested: Select test(s) as requested by the client.

Test Method(s): Please refer to next page(s).

Test Result(s): Please refer to next page(s).

Test Requirement	Conclusion
EU RoHS Directive (EU) 2015/863 amending Annex II to Directive 2011/65/EU - Lead, Mercury, Cadmium, Hexavalent chromium, Polybrominated biphenyls (PBB), Polybrominated diphenyl ethers (PBDE), Bis(2-ethylhexyl) phthalate (DEHP), Butyl benzyl phthalate (BBP), Dibutyl phthalate (DBP) and Diisobutyl phthalate (DIBP)	Pass

Signed for and on behalf of
SGS-CSTC Standards Technical Services Co., Ltd. Ningbo Branch

Kell Li

Kell_Li
Approved Signatory



SGS-CSTC Standards Technical Services Co., Ltd.
Ningbo Branch Chemical Laboratory

Unless otherwise agreed in writing, this document is issued by the Company subject to its General Conditions of Service printed overleaf, available on request or accessible at <http://www.sgs.com/en/Terms-and-Conditions.aspx> and, for electronic format documents, subject to Terms and Conditions for Electronic Documents at <http://www.sgs.com/en/Terms-and-Conditions/Terms-e-Documents.aspx>. Attention is drawn to the limitation of liability, indemnification and jurisdiction issues defined therein. Any holder of this document is advised that information contained hereon reflects the Company's findings at the time of its intervention only and within the limits of Client's instructions, if any. The Company's sole responsibility is to its Client and this document does not exonerate parties to a transaction from exercising all their rights and obligations under the transaction documents. This document cannot be reproduced except in full, without prior written approval of the Company. Any unauthorized alteration, forgery or falsification of the content or appearance of this document is unlawful and offenders may be prosecuted to the fullest extent of the law. Unless otherwise stated the results shown in this test report refer only to the sample(s) tested.

Attention: To check the authenticity of testing / inspection report & certificate, please contact us at telephone: (86-755) 8307 1443, or email: CN.Doccheck@sgs.com

No.1177, Lingyun Road, Hi-Tech Zone, Ningbo, Zhejiang, China 315040 T&E (86-574)89070249

www.sgs.com

中国·浙江·宁波高新区凌云路1177号 邮编: 315040 T HL (86-574)89070271 T ML (86-574)89070242 sgs.china@sgs.com

Test Result(s):

Test Part Description:

SN ID	Sample No.	SGS Sample ID	Description
SN1	A1	NGB24-0005860-0001.C001	Colorless transparent particles

Remarks:

- (1) 1 mg/kg = 1 ppm = 0.0001%
- (2) MDL = Method Detection Limit
- (3) ND = Not Detected (< MDL)
- (4) “-” = Not Regulated

EU RoHS Directive (EU) 2015/863 amending Annex II to Directive 2011/65/EU - Lead, Mercury, Cadmium, Hexavalent chromium, Polybrominated biphenyls (PBB), Polybrominated diphenyl ethers (PBDE), Bis(2-ethylhexyl) phthalate (DEHP), Butyl benzyl phthalate (BBP), Dibutyl phthalate (DBP) and Diisobutyl phthalate (DIBP)

Test Method: With reference to IEC 62321-4:2013+AMD1:2017, IEC 62321-5:2013, IEC 62321-7-2:2017, IEC 62321-6:2015 and IEC 62321-8:2017, analysis was performed by ICP-OES/AAS, UV-Vis and GC-MS.

Test Item(s)	Limit	Unit(s)	MDL	A1
Lead (Pb)	1000	mg/kg	2	ND
Mercury (Hg)	1000	mg/kg	2	ND
Cadmium (Cd)	100	mg/kg	2	ND
Hexavalent Chromium (Cr(VI))	1000	mg/kg	8	ND
Polybrominated biphenyls (PBB)	1000	mg/kg	-	ND
Monobrominated biphenyl (MonoBB)	-	mg/kg	5	ND
Dibrominated biphenyl (DiBB)	-	mg/kg	5	ND
Tribrominated biphenyl (TriBB)	-	mg/kg	5	ND
Tetrabrominated biphenyl (TetraBB)	-	mg/kg	5	ND
Pentabrominated biphenyl (PentaBB)	-	mg/kg	5	ND
Hexabrominated biphenyl (HexaBB)	-	mg/kg	5	ND
Heptabrominated biphenyl (HeptaBB)	-	mg/kg	5	ND
Octabrominated biphenyl (OctaBB)	-	mg/kg	5	ND
Nonabrominated biphenyl (NonaBB)	-	mg/kg	5	ND
Decabrominated biphenyl (DecaBB)	-	mg/kg	5	ND
Polybrominated diphenyl ethers (PBDE)	1000	mg/kg	-	ND
Monobrominated diphenyl ether (MonoBDE)	-	mg/kg	5	ND
Dibrominated diphenyl ether (DiBDE)	-	mg/kg	5	ND
Tribrominated diphenyl ether (TriBDE)	-	mg/kg	5	ND
Tetrabrominated diphenyl ether (TetraBDE)	-	mg/kg	5	ND
Pentabrominated diphenyl ether (PentaBDE)	-	mg/kg	5	ND
Hexabrominated diphenyl ether (HexaBDE)	-	mg/kg	5	ND
Heptabrominated diphenyl ether (HeptaBDE)	-	mg/kg	5	ND



Unless otherwise agreed in writing, this document is issued by the Company subject to its General Conditions of Service printed overleaf, available on request or accessible at <http://www.sgs.com/en/Terms-and-Conditions.aspx> and, for electronic format documents, subject to Terms and Conditions for Electronic Documents at <http://www.sgs.com/en/Terms-and-Conditions/Terms-e-Document.aspx>. Attention is drawn to the limitation of liability, indemnification and jurisdiction issues defined therein. Any holder of this document is advised that information contained hereon reflects the Company's findings at the time of its intervention only and within the limits of Client's instructions, if any. The Company's sole responsibility is to its Client and this document does not exonerate parties to a transaction from exercising all their rights and obligations under the transaction documents. This document cannot be reproduced except in full, without prior written approval of the Company. Any unauthorized alteration, forgery or falsification of the content or appearance of this document is unlawful and offenders may be prosecuted to the fullest extent of the law. Unless otherwise stated the results shown in this test report refer only to the sample(s) tested.

Attention: To check the authenticity of testing /inspection report & certificate, please contact us at telephone: (86-755) 8307 1443, or email: CN.Doccheck@sgs.com

Test Report

No.: NGBEC24000586005

Date: Feb 05, 2024

Page 3 of 8

Test Item(s)	Limit	Unit(s)	MDL	A1
Octabrominated diphenyl ether (OctaBDE)	-	mg/kg	5	ND
Nonabrominated diphenyl ether (NonaBDE)	-	mg/kg	5	ND
Decabrominated diphenyl ether (DecaBDE)	-	mg/kg	5	ND
Bis(2-ethylhexyl) phthalate (DEHP)	1000	mg/kg	50	ND
Butyl benzyl phthalate (BBP)	1000	mg/kg	50	ND
Dibutyl phthalate (DBP)	1000	mg/kg	50	ND
Diisobutyl phthalate (DIBP)	1000	mg/kg	50	ND

Notes:

- (1) The maximum permissible limit is quoted from RoHS Directive (EU) 2015/863.
- (2) IEC 62321 series is equivalent to EN 62321 series.
- (3) The restriction of DEHP, BBP, DBP and DIBP shall apply to medical devices, including in vitro medical devices, and monitoring and control instruments, including industrial monitoring and control instruments, from 22 July 2021.

Unless otherwise stated, the decision rule for conformity reporting is based on Binary Statement for Simple Acceptance Rule (w=0) stated in ILAC-G8:09/2019.



Unless otherwise agreed in writing, this document is issued by the Company subject to its General Conditions of Service printed overleaf, available on request or accessible at <http://www.sgs.com/en/Terms-and-Conditions.aspx> and, for electronic format documents, subject to Terms and Conditions for Electronic Documents at <http://www.sgs.com/en/Terms-and-Conditions/Terms-e-Document.aspx>. Attention is drawn to the limitation of liability, indemnification and jurisdiction issues defined therein. Any holder of this document is advised that information contained hereon reflects the Company's findings at the time of its intervention only and within the limits of Client's instructions, if any. The Company's sole responsibility is to its Client and this document does not exonerate parties to a transaction from exercising all their rights and obligations under the transaction documents. This document cannot be reproduced except in full, without prior written approval of the Company. Any unauthorized alteration, forgery or falsification of the content or appearance of this document is unlawful and offenders may be prosecuted to the fullest extent of the law. Unless otherwise stated the results shown in this test report refer only to the sample(s) tested.

Attention: To check the authenticity of testing /inspection report & certificate, please contact us at telephone: (86-755) 8307 1443, or email: CN.Doccheck@sgs.com

SGS-CS18 Standards Technical Services Co., Ltd.
Ningbo Branch Chemical Laboratory

No.1177, Lingyun Road, Hi-Tech Zone, Ningbo, Zhejiang, China 315040 tE&E (86-574)89070249
中国·浙江·宁波高新区凌云路1177号 邮编: 315040 tHL (86-574)89070271 tML (86-574)89070242 sgs.china@sgs.com

www.sgs.com.cn

Elements Testing Flow Chart

These samples were dissolved totally by pre-conditioning method according to below flow chart.

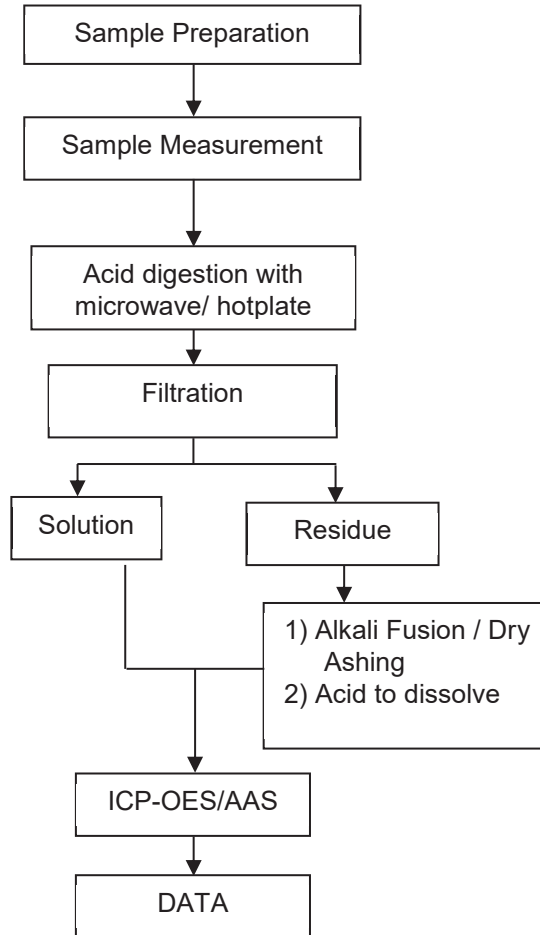

Unless otherwise agreed in writing, this document is issued by the Company subject to its General Conditions of Service printed overleaf, available on request or accessible at <http://www.sgs.com/en/Terms-and-Conditions.aspx> and, for electronic format documents, subject to Terms and Conditions for Electronic Documents at <http://www.sgs.com/en/Terms-and-Conditions/Terms-e-Document.aspx>. Attention is drawn to the limitation of liability, indemnification and jurisdiction issues defined therein. Any holder of this document is advised that information contained hereon reflects the Company's findings at the time of its intervention only and within the limits of Client's instructions, if any. The Company's sole responsibility is to its Client and this document does not exonerate parties to a transaction from exercising all their rights and obligations under the transaction documents. This document cannot be reproduced except in full, without prior written approval of the Company. Any unauthorized alteration, forgery or falsification of the content or appearance of this document is unlawful and offenders may be prosecuted to the fullest extent of the law. Unless otherwise stated the results shown in this test report refer only to the sample(s) tested.

Attention: To check the authenticity of testing /inspection report & certificate, please contact us at telephone: (86-755) 8307 1443, or email: CN.Doccheck@sgs.com

Hexavalent Chromium (Cr(VI)) Testing Flow Chart

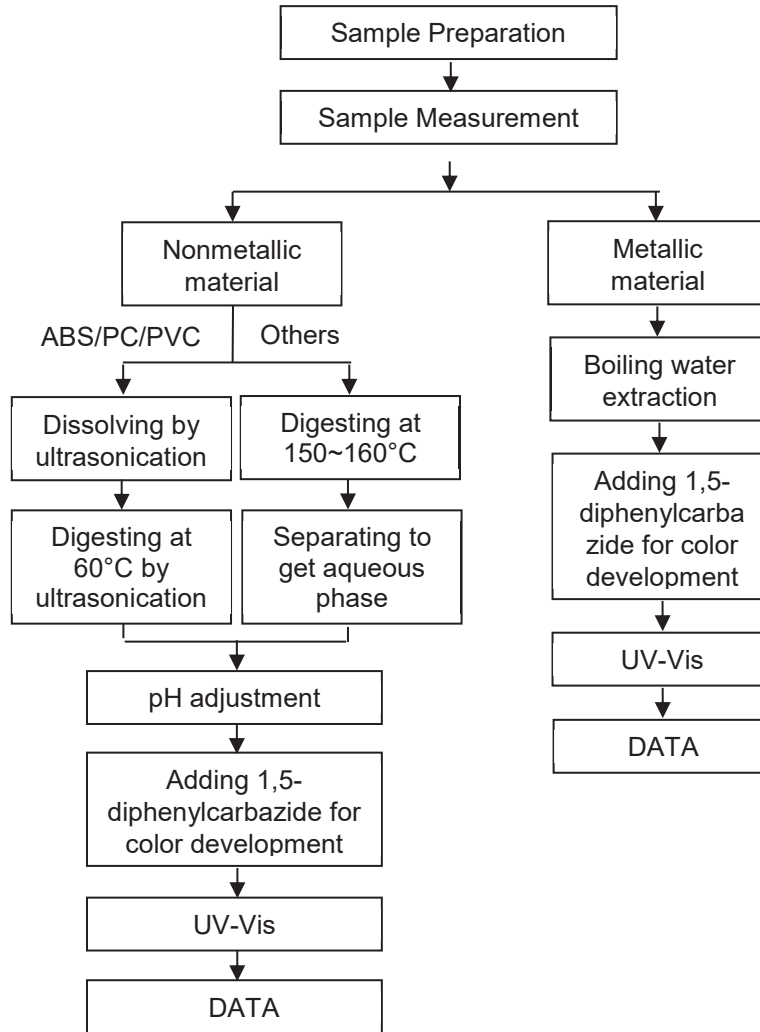

Unless otherwise agreed in writing, this document is issued by the Company subject to its General Conditions of Service printed overleaf, available on request or accessible at <http://www.sgs.com/en/Terms-and-Conditions.aspx> and, for electronic format documents, subject to Terms and Conditions for Electronic Documents at <http://www.sgs.com/en/Terms-and-Conditions/Terms-e-Document.aspx>. Attention is drawn to the limitation of liability, indemnification and jurisdiction issues defined therein. Any holder of this document is advised that information contained hereon reflects the Company's findings at the time of its intervention only and within the limits of Client's instructions, if any. The Company's sole responsibility is to its Client and this document does not exonerate parties to a transaction from exercising all their rights and obligations under the transaction documents. This document cannot be reproduced except in full, without prior written approval of the Company. Any unauthorized alteration, forgery or falsification of the content or appearance of this document is unlawful and offenders may be prosecuted to the fullest extent of the law. Unless otherwise stated the results shown in this test report refer only to the sample(s) tested.

Attention: To check the authenticity of testing /inspection report & certificate, please contact us at telephone: (86-755) 8307 1443, or email: CN.Doccheck@sgs.com

PBB/PBDE Testing Flow Chart

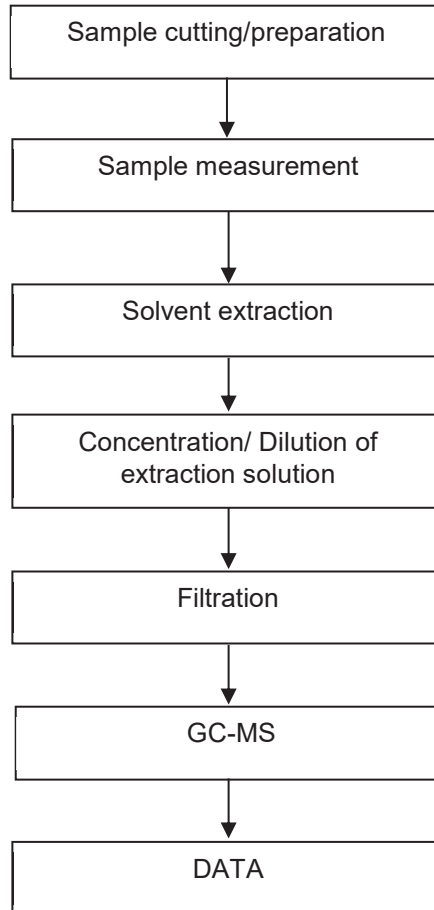

Unless otherwise agreed in writing, this document is issued by the Company subject to its General Conditions of Service printed overleaf, available on request or accessible at <http://www.sgs.com/en/Terms-and-Conditions.aspx> and, for electronic format documents, subject to Terms and Conditions for Electronic Documents at <http://www.sgs.com/en/Terms-and-Conditions/Terms-e-Document.aspx>. Attention is drawn to the limitation of liability, indemnification and jurisdiction issues defined therein. Any holder of this document is advised that information contained hereon reflects the Company's findings at the time of its intervention only and within the limits of Client's instructions, if any. The Company's sole responsibility is to its Client and this document does not exonerate parties to a transaction from exercising all their rights and obligations under the transaction documents. This document cannot be reproduced except in full, without prior written approval of the Company. Any unauthorized alteration, forgery or falsification of the content or appearance of this document is unlawful and offenders may be prosecuted to the fullest extent of the law. Unless otherwise stated the results shown in this test report refer only to the sample(s) tested.

Attention: To check the authenticity of testing /inspection report & certificate, please contact us at telephone: (86-755) 8307 1443, or email: CN.Doccheck@sgs.com

Phthalates Testing Flow Chart

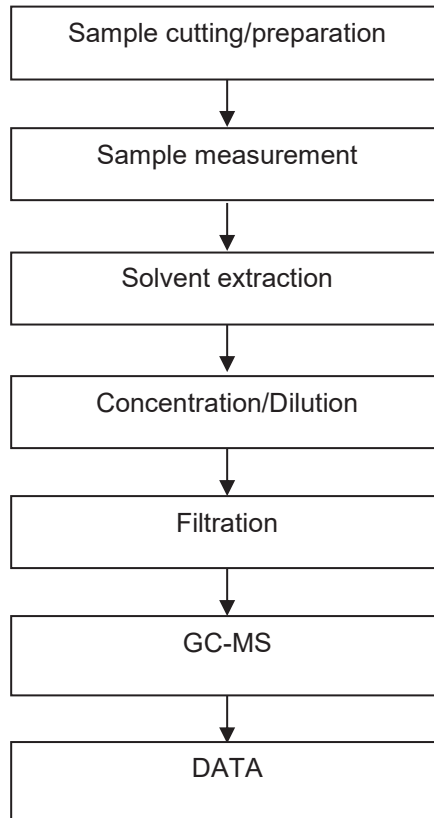

Unless otherwise agreed in writing, this document is issued by the Company subject to its General Conditions of Service printed overleaf, available on request or accessible at <http://www.sgs.com/en/Terms-and-Conditions.aspx> and, for electronic format documents, subject to Terms and Conditions for Electronic Documents at <http://www.sgs.com/en/Terms-and-Conditions/Terms-e-Document.aspx>. Attention is drawn to the limitation of liability, indemnification and jurisdiction issues defined therein. Any holder of this document is advised that information contained hereon reflects the Company's findings at the time of its intervention only and within the limits of Client's instructions, if any. The Company's sole responsibility is to its Client and this document does not exonerate parties to a transaction from exercising all their rights and obligations under the transaction documents. This document cannot be reproduced except in full, without prior written approval of the Company. Any unauthorized alteration, forgery or falsification of the content or appearance of this document is unlawful and offenders may be prosecuted to the fullest extent of the law. Unless otherwise stated the results shown in this test report refer only to the sample(s) tested.

Attention: To check the authenticity of testing /inspection report & certificate, please contact us at telephone: (86-755) 8307 1443, or email: CN.Doccheck@sgs.com

Test Report

No.: NGBEC24000586005

Date: Feb 05, 2024

Page 8 of 8

Sample Photo:

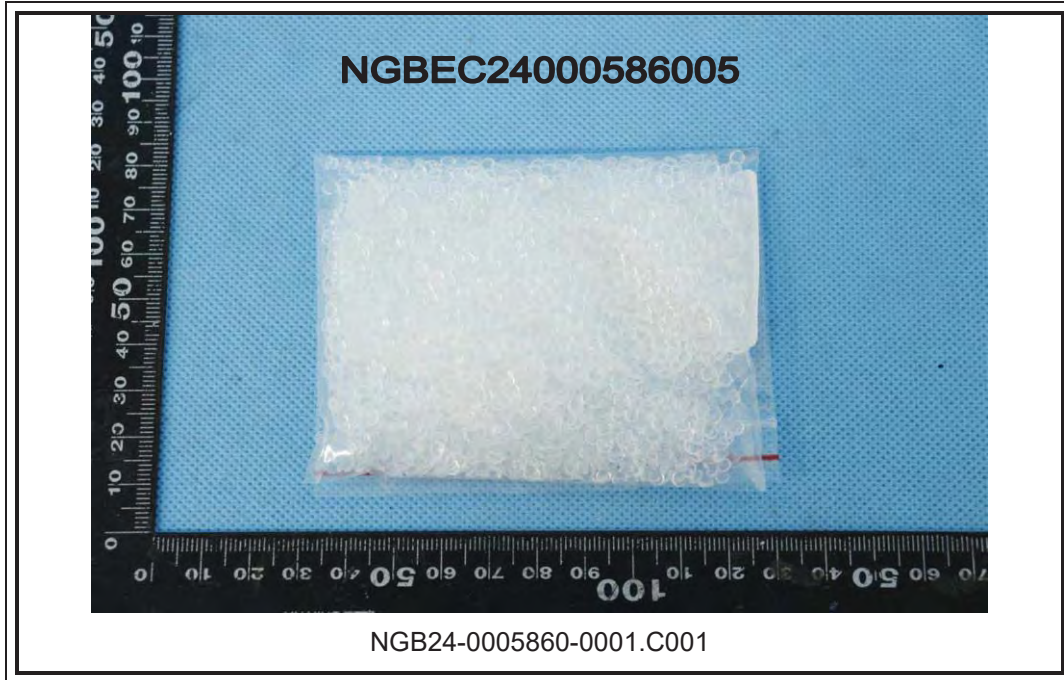

SGS authenticate the photo on original report only

*** End of Report ***



Unless otherwise agreed in writing, this document is issued by the Company subject to its General Conditions of Service printed overleaf, available on request or accessible at <http://www.sgs.com/en/Terms-and-Conditions.aspx> and, for electronic format documents, subject to Terms and Conditions for Electronic Documents at <http://www.sgs.com/en/Terms-and-Conditions/Terms-e-Document.aspx>. Attention is drawn to the limitation of liability, indemnification and jurisdiction issues defined therein. Any holder of this document is advised that information contained hereon reflects the Company's findings at the time of its intervention only and within the limits of Client's instructions, if any. The Company's sole responsibility is to its Client and this document does not exonerate parties to a transaction from exercising all their rights and obligations under the transaction documents. This document cannot be reproduced except in full, without prior written approval of the Company. Any unauthorized alteration, forgery or falsification of the content or appearance of this document is unlawful and offenders may be prosecuted to the fullest extent of the law. Unless otherwise stated the results shown in this test report refer only to the sample(s) tested.

Attention: To check the authenticity of testing / inspection report & certificate, please contact us at telephone: (86-755) 8307 1443, or email: CN.Doccheck@sgs.com

SGS-CS18 Standards Technical Services Co., Ltd.
Ningbo Branch Chemical Laboratory

No.1177, Lingyun Road, Hi-Tech Zone, Ningbo, Zhejiang, China 315040 tE&E (86-574)89070249
中国·浙江·宁波高新区凌云路1177号 邮编: 315040 tHL (86-574)89070271 tML (86-574)89070242 sgs.china@sgs.com

www.sgsgroup.com.cn

Test Report

No. HKTEC2401654111

Date: 09 May 2024

Page 1 of 14

DAINICHISEIKA COLOR & CHEMICALS MFG. CO., LTD.

7-6, BAKUROCHO 1-CHOME,
NIHONBASHI, CHUO-KU,
TOKYO 103-8383

The following sample(s) was/were submitted and identified on behalf of the clients as : COLORANT FOR FLUOROPOLYMER

SGS Job No. : 5391320 - HK
Item No Given by Client : FCM H 1372 BLACK
Lot No. : 16234052
Country of Origin : JAPAN
Date of Sample Received : 17 Apr 2024
Testing Period : 17 Apr 2024 - 07 May 2024
Test Requested : Selected test(s) as requested by client.
Test Method : Please refer to next page(s).
Test Results : Please refer to next page(s).
Conclusion :
Based on the performed tests on submitted sample(s), the results of Cadmium, Lead, Mercury, Hexavalent chromium, Polybrominated biphenyls (PBBs), Polybrominated diphenyl ethers (PBDEs) and Phthalates such as Bis(2-ethylhexyl) phthalate (DEHP), Butyl benzyl phthalate (BBP), Dibutyl phthalate (DBP) and Diisobutyl phthalate (DIBP) comply with the limits as set by RoHS Directive (EU) 2015/863 amending Annex II to Directive 2011/65/EU.
Based on the performed tests on submitted samples, the test results do not exceed the limit as set by the requirement of European Regulation POPs (EU) 2019/1021–Hexabromocyclododecane (HBCDD) and all major diastereoisomers identified (α -HBCDD, β -HBCDD, γ -HBCDD).
Based on the performed tests on submitted sample(s), the test results do not exceed the limit as set by European Regulation POPs (EU) 2020/784 amending to Regulation (EU) 2019/1021 Annex I - Perfluorooctanoic acid (PFOA) and its salts, PFOA-Related Substances, Perfluorooctane sulfonates (PFOS) and its derivatives

This document is issued by the Company subject to its General Conditions of Service printed overleaf, available on request or accessible at <http://www.sgs.com/en/Terms-and-Conditions.aspx> and, for electronic format documents, subject to Terms and Conditions for Electronic Documents at <http://www.sgs.com/en/Terms-and-Conditions/Terms-e-Document.aspx>. Attention is drawn to the limitation of liability, indemnification and jurisdiction issues defined therein. Any holder of this document is advised that information contained hereon reflects the Company's findings at the time of its intervention only and within the limits of Client's instructions, if any. The Company's sole responsibility is to its Client and this document does not exonerate parties to a transaction from exercising all their rights and obligations under the transaction documents. This document cannot be reproduced except in full, without prior written approval of the Company. Any unauthorized alteration, forgery or falsification of the content or appearance of this document is unlawful and offenders may be prosecuted to the fullest extent of the law.

Unless otherwise stated the results shown in this test report refer only to the sample(s) tested and such sample(s) are retained for 30 days only.

Test Report

No. HKTEC2401654111

Date: 09 May 2024

Page 2 of 14

Signed for and on behalf of
SGS Hong Kong Limited.



Han Long Fung, Ivan
Chemist

This document is issued by the Company subject to its General Conditions of Service printed overleaf, available on request or accessible at <http://www.sgs.com/en/Terms-and-Conditions.aspx> and, for electronic format documents, subject to Terms and Conditions for Electronic Documents at <http://www.sgs.com/en/Terms-and-Conditions/Terms-e-Document.aspx>. Attention is drawn to the limitation of liability, indemnification and jurisdiction issues defined therein. Any holder of this document is advised that information contained hereon reflects the Company's findings at the time of its intervention only and within the limits of Client's instructions, if any. The Company's sole responsibility is to its Client and this document does not exonerate parties to a transaction from exercising all their rights and obligations under the transaction documents. This document cannot be reproduced except in full, without prior written approval of the Company. Any unauthorized alteration, forgery or falsification of the content or appearance of this document is unlawful and offenders may be prosecuted to the fullest extent of the law.

Unless otherwise stated the results shown in this test report refer only to the sample(s) tested and such sample(s) are retained for 30 days only.

Test Report

No. HKTEC2401654111

Date: 09 May 2024

Page 3 of 14

Test Results :

Test Part Description :

Specimen No.	SGS Sample ID	Description
1	HKT24-016541.011	Black plastic pellet

Remarks :

- (1) 1 mg/kg = 1 ppm = 0.0001%
- (2) MDL = Method Detection Limit
- (3) ND = Not Detected (< MDL)
- (4) "-" = Not Regulated

RoHS Directive (EU) 2015/863 amending Annex II to Directive 2011/65/EU

Test Method : With reference to IEC 62321-4:2013+A1:2017, IEC62321-5:2013, IEC62321-7-2:2017, IEC62321-6:2015 and IEC62321-8:2017, analyzed by ICP-OES, UV-Vis and GC-MS. (Decision Rule: please refer to appendix 1: Category 1)

Test Item(s)	Limit	Unit	MDL	011
Cadmium (Cd)	100	mg/kg	2	ND
Lead (Pb)	1,000	mg/kg	2	ND
Mercury (Hg)	1,000	mg/kg	2	ND
Hexavalent Chromium (Cr(VI))	1,000	mg/kg	8	ND
Sum of PBBs	1,000	mg/kg	-	ND
Monobromobiphenyl	-	mg/kg	5	ND
Dibromobiphenyl	-	mg/kg	5	ND
Tribromobiphenyl	-	mg/kg	5	ND
Tetrabromobiphenyl	-	mg/kg	5	ND
Pentabromobiphenyl	-	mg/kg	5	ND
Hexabromobiphenyl	-	mg/kg	5	ND
Heptabromobiphenyl	-	mg/kg	5	ND
Octabromobiphenyl	-	mg/kg	5	ND
Nonabromobiphenyl	-	mg/kg	5	ND
Decabromobiphenyl	-	mg/kg	5	ND
Sum of PBDEs	1,000	mg/kg	-	ND
Monobromodiphenyl ether	-	mg/kg	5	ND
Dibromodiphenyl ether	-	mg/kg	5	ND
Tribromodiphenyl ether	-	mg/kg	5	ND

This document is issued by the Company subject to its General Conditions of Service printed overleaf, available on request or accessible at <http://www.sgs.com/en/Terms-and-Conditions.aspx> and, for electronic format documents, subject to Terms and Conditions for Electronic Documents at <http://www.sgs.com/en/Terms-and-Conditions/Terms-e-Document.aspx>. Attention is drawn to the limitation of liability, indemnification and jurisdiction issues defined therein. Any holder of this document is advised that information contained hereon reflects the Company's findings at the time of its intervention only and within the limits of Client's instructions, if any. The Company's sole responsibility is to its Client and this document does not exonerate parties to a transaction from exercising all their rights and obligations under the transaction documents. This document cannot be reproduced except in full, without prior written approval of the Company. Any unauthorized alteration, forgery or falsification of the content or appearance of this document is unlawful and offenders may be prosecuted to the fullest extent of the law.

Unless otherwise stated the results shown in this test report refer only to the sample(s) tested and such sample(s) are retained for 30 days only.

Test Report

No. HKTEC2401654111

Date: 09 May 2024

Page 4 of 14

<u>Test Item(s)</u>	<u>Limit</u>	<u>Unit</u>	<u>MDL</u>	<u>011</u>
Tetrabromodiphenyl ether	-	mg/kg	5	ND
Pentabromodiphenyl ether	-	mg/kg	5	ND
Hexabromodiphenyl ether	-	mg/kg	5	ND
Heptabromodiphenyl ether	-	mg/kg	5	ND
Octabromodiphenyl ether	-	mg/kg	5	ND
Nonabromodiphenyl ether	-	mg/kg	5	ND
Decabromodiphenyl ether	-	mg/kg	5	ND
Dibutyl Phthalate (DBP)	1,000	mg/kg	50	ND
Benzylbutyl Phthalate (BBP)	1,000	mg/kg	50	ND
Bis-(2-ethylhexyl) Phthalate (DEHP)	1,000	mg/kg	50	ND
Diisobutyl Phthalate (DIBP)	1,000	mg/kg	50	ND

Notes :

(1) The maximum permissible limit is quoted from RoHS Directive (EU) 2015/863. IEC 62321 series is equivalent to EN 62321 series

http://www.cenelec.eu/dyn/www/f?p=104:30:1742232870351101:::FSP_ORG_ID,FSP_LANG_ID:1258637,25

Halogen

Test Method : With reference to EN 14582:2016, analysis was performed by IC.

<u>Test Item(s)</u>	<u>Limit</u>	<u>Unit</u>	<u>MDL</u>	<u>011</u>
Fluorine (F)	-	mg/kg	50	740000
Chlorine (Cl)	-	mg/kg	50	ND
Bromine (Br)	-	mg/kg	50	ND
Iodine (I)	-	mg/kg	50	ND

Notes :

(1) The measurement report of the expanded uncertainty with confident level 95% by coverage factor k=2, is 20% for each analyte of halogen.

European Regulation POPs (EU) 2019/1021 – Hexabromocyclododecane (HBCDD) and all major diastereoisomers identified (α -HBCDD, β -HBCDD, γ -HBCDD)

Test Method : With reference to IEC 62321-9:2021, analysis was performed by GC-MS. (Decision Rule: please refer to appendix 1: Category 1)

This document is issued by the Company subject to its General Conditions of Service printed overleaf, available on request or accessible at <http://www.sgs.com/en/Terms-and-Conditions.aspx> and, for electronic format documents, subject to Terms and Conditions for Electronic Documents at <http://www.sgs.com/en/Terms-and-Conditions/Terms-e-Documents.aspx>. Attention is drawn to the limitation of liability, indemnification and jurisdiction issues defined therein. Any holder of this document is advised that information contained hereon reflects the Company's findings at the time of its intervention only and within the limits of Client's instructions, if any. The Company's sole responsibility is to its Client and this document does not exonerate parties to a transaction from exercising all their rights and obligations under the transaction documents. This document cannot be reproduced except in full, without prior written approval of the Company. Any unauthorized alteration, forgery or falsification of the content or appearance of this document is unlawful and offenders may be prosecuted to the fullest extent of the law.

Unless otherwise stated the results shown in this test report refer only to the sample(s) tested and such sample(s) are retained for 30 days only.

Test Report

No. HKTEC2401654111

Date: 09 May 2024

Page 5 of 14

Test Item(s)	Limit	Unit	MDL	011
Hexabromocyclododecane (HBCDD) and all major diastereoisomers identified (α -HBCDD, β -HBCDD, γ -HBCDD)	100	mg/kg	20	ND
Conclusion	PASS			

European Regulation POPs (EU) 2020/784 amending to Regulation (EU) 2019/1021 Annex I - Perfluorooctanoic acid (PFOA) and its salts, PFOA-Related Substances, Perfluorooctane sulfonates (PFOS) and its derivatives

Test Method : Modified CEN/TS 15968:2010, analysis was performed by LC-MS or LC-MS/MS and GC-MS.
(Decision Rule: please refer to appendix 1: Category 1)

Test Item(s)	CAS NO	Limit	Unit	MDL	011
PFOS, its salts and related compounds		-	-	-	--
Perfluorooctane sulfonates (PFOS), its salts^	1763-23-1	-	mg/kg	0.010	ND
N-ethylperfluoro-1-octanesulfonamide (N-EtFOSA)	4151-50-2	-	mg/kg	0.010	ND
N-methylperfluoro-1-octanesulfonamide (N-MeFOSA)	31506-32-8	-	mg/kg	0.010	ND
2-(N-ethylperfluoro-1-octanesulfonamido)-ethanol (N-EtFOSE)	1691-99-2	-	mg/kg	0.010	ND
2-(N-methylperfluoro-1-octanesulfonamido)-ethanol (N-MeFOSE)	24448-09-7	-	mg/kg	0.010	ND
Perfluorooctane sulfonamide (PFOSA), its salts^	754-91-6	-	mg/kg	0.010	ND
Perfluorooctane sulfonates (PFOS) and its derivatives	--	1,000	mg/kg	-	ND
PFOA, its salts		-	-	-	--
Perfluorooctanoic acid (PFOA), its salts^	335-67-1	0.025	mg/kg	0.010	ND
PFOA-related compounds		-	-	-	--
1H,1H,2H,2H-Perfluorodecane sulfonic acid (8:2 FTS), its salts^	39108-34-4	-	mg/kg	0.010	ND

This document is issued by the Company subject to its General Conditions of Service printed overleaf, available on request or accessible at <http://www.sgs.com/en/Terms-and-Conditions.aspx> and, for electronic format documents, subject to Terms and Conditions for Electronic Documents at <http://www.sgs.com/en/Terms-and-Conditions/Terms-e-Document.aspx>. Attention is drawn to the limitation of liability, indemnification and jurisdiction issues defined therein. Any holder of this document is advised that information contained hereon reflects the Company's findings at the time of its intervention only and within the limits of Client's instructions, if any. The Company's sole responsibility is to its Client and this document does not exonerate parties to a transaction from exercising all their rights and obligations under the transaction documents. This document cannot be reproduced except in full, without prior written approval of the Company. Any unauthorized alteration, forgery or falsification of the content or appearance of this document is unlawful and offenders may be prosecuted to the fullest extent of the law.

Unless otherwise stated the results shown in this test report refer only to the sample(s) tested and such sample(s) are retained for 30 days only.

Test Report

No. HKTEC2401654111

Date: 09 May 2024

Page 6 of 14

<u>Test Item(s)</u>	<u>CAS NO</u>	<u>Limit</u>	<u>Unit</u>	<u>MDL</u>	<u>011</u>
Methyl perfluorooctanoate (Me-PFOA)	376-27-2	-	mg/kg	0.100	ND
Ethyl perfluorooctanoate (Et-PFOA)	3108-24-5	-	mg/kg	0.100	ND
1H,1H,2H,2H-Perfluorodecyl acrylate (8:2 FTA)	27905-45-9	-	mg/kg	0.100	ND
1H,1H,2H,2H-Perfluorodecyl methacrylate (8:2 FTMA)	1996-88-9	-	mg/kg	0.100	ND
Perfluoro-1-iodooctane (PFOI)	507-63-1	-	mg/kg	0.100	ND
2H,2H-Perfluorodecane Acid (H2PFDA/8:2 FTCA), its salts [^]	27854-31-5	-	mg/kg	0.010	ND
1H,1H,2H,2H-Perfluoro-1-decanol (8:2 FTOH)	678-39-7	-	mg/kg	0.100	ND
1-Iodo-1H,1H,2H,2H-perfluoro decane (8:2 FTI)	2043-53-0	-	mg/kg	0.100	ND
1H,1H,2H,2H-Perfluorodecyltri ethoxysilane (8:2 FTSi(OC2H5)3)	101947-16-4	-	mg/kg	0.100	ND
bis(3,3,4,4,5,5,6,6,7,7,8,8,9,9,10,10,10-heptadecafluorodecyl) hydrogen phosphate (8:2 diPAP) , its salts [^]	678-41-1	-	mg/kg	0.010	ND
2H,2H,3H,3H-Perfluoroundecanoic Acid (H4PFUnDA / 8:3 FTCA), its salts [^]	34598-33-9	-	mg/kg	0.010	ND
1H,1H,2H-Heptadecafluoro-1-decene (PFDE)	21652-58-4	-	mg/kg	0.100	ND
3-Perfluoroheptyl propanoic acid (7:3 FTCA)	812-70-4	-	mg/kg	0.010	ND
Sum of PFOA-related compounds	--	1	mg/kg	-	ND

Conclusion

PASS

Notes :

1. [^]=Substances refer to its salts/derivative listed in below table.

This document is issued by the Company subject to its General Conditions of Service printed overleaf, available on request or accessible at <http://www.sgs.com/en/Terms-and-Conditions.aspx> and, for electronic format documents, subject to Terms and Conditions for Electronic Documents at <http://www.sgs.com/en/Terms-and-Conditions/Terms-e-Documents.aspx>. Attention is drawn to the limitation of liability, indemnification and jurisdiction issues defined therein. Any holder of this document is advised that information contained hereon reflects the Company's findings at the time of its intervention only and within the limits of Client's instructions, if any. The Company's sole responsibility is to its Client and this document does not exonerate parties to a transaction from exercising all their rights and obligations under the transaction documents. This document cannot be reproduced except in full, without prior written approval of the Company. Any unauthorized alteration, forgery or falsification of the content or appearance of this document is unlawful and offenders may be prosecuted to the fullest extent of the law.

Unless otherwise stated the results shown in this test report refer only to the sample(s) tested and such sample(s) are retained for 30 days only.

Substance Name	CAS No.
PFOS, its salts & derivatives	
Perfluorooctane sulfonates (PFOS)	1763-23-1
Potassium Perfluorooctanesulfonate (PFOS-K)	2795-39-3
Perfluorooctanesulfonic acid, lithium salt (PFOS-Li)	29457-72-5
Sodium perfluorooctanesulfonate (PFOS-Na)	4021-47-0
Ammonium perfluorooctanesulfonate (PFOS-NH ₄)	29081-56-9
Perfluorooctane sulfonate diethanolamine salt (PFOS-NH ₂ (C ₂ H ₄ OH) ₂)	70225-14-8
Perfluorooctanesulfonic acid,tetraethylammonium salt (PFOS-N(C ₂ H ₅) ₄)	56773-42-3
N-decyl-N,N-dimethyldecane-1-aminium 1,1,2,2,3,3,4,4,5,5,6,6,7,7,8,8,8-heptadecafluorooctane-1-sulfonate (PFOS-N(C ₁₀ H ₂₁) ₂ (CH ₃) ₂)	251099-16-8
Perfluorooctane Sulfonyl fluoride (PFOS-F)	307-35-7
Magnesium bis(heptadecafluorooctanesulphonate) (PFOS-Mg)	91036-71-4
Piperidine 1,1,2,2,3,3,4,4,5,5,6,6,7,7,8,8,8-heptadecafluorooctanesulfonate	71463-74-6
PFOSA, its salts	
Perfluorooctane Sulfonylamide (PFOSA)	754-91-6
Perfluorooctanesulfonylamide lithium salt (1:1) (PFOSA-Li)	76752-79-9
PFOA, its salts & derivatives	
Perfluorooctanoic acid (PFOA)	335-67-1
Sodium perfluorooctanoate (PFOA-Na)	335-95-5
Potassium perfluorooctanoate (PFOA-K)	2395-00-8
Silver perfluorooctanoate (PFOA-Ag)	335-93-3
Perfluorooctanoyl fluoride (PFOA-F)	335-66-0
Ammonium pentadecafluorooctanoate (APFO)	3825-26-1
Lithium perfluorooctanoate (PFOA-Li)	17125-58-5
8:2 FTS, its salts	
1H,1H,2H,2H-Perfluorodecanesulfonic acid (8:2 FTS)	39108-34-4
Potassium 1H,1H,2H,2H-Perfluorodecane sulfonate (8:2 FTS-K)	438237-73-1
Ammonium 1H,1H,2H,2H-Perfluorodecane sulfonate (8:2 FTS-NH ₄)	149724-40-3
Sodium 1H,1H,2H,2H-Perfluorodecane sulfonate (8:2 FTS-Na)	27619-96-1
H₂PFDA/8:2 FTCA, its salts	
2H,2H-Perfluorodecane Acid (H ₂ PFDA/8:2 FTCA)	27854-31-5
Tetrabutylphosphonium 2H,2H-Perfluorodecanoate (8:2 FTCA-P(C ₄ H ₉) ₄)	882489-14-7
8:2diPAP, its salts	
Bis(3,3,4,4,5,5,6,6,7,7,8,8,9,9,10,10,10-heptadecafluorodecyl) hydrogen phosphate (8:2diPAP)	678-41-1
Sodium bis(1H,1H,2H,2H-perfluorodecyl)phosphate (8:2diPAP-Na)	114519-85-6
H₄PFUnDA/ 8:3 FTCA, its salts	
2H,2H,3H,3H-Perfluoroundecanoic acid (H ₄ PFUnDA/ 8:3 FTCA)	34598-33-9
Potassium 2H,2H,3H,3H-Perfluoroundecanoate (H ₄ PFUnDA-K)	83310-58-1

This document is issued by the Company subject to its General Conditions of Service printed overleaf, available on request or accessible at <http://www.sgs.com/en/Terms-and-Conditions.aspx> and, for electronic format documents, subject to Terms and Conditions for Electronic Documents at <http://www.sgs.com/en/Terms-and-Conditions/Terms-e-Document.aspx>. Attention is drawn to the limitation of liability, indemnification and jurisdiction issues defined therein. Any holder of this document is advised that information contained hereon reflects the Company's findings at the time of its intervention only and within the limits of Client's instructions, if any. The Company's sole responsibility is to its Client and this document does not exonerate parties to a transaction from exercising all their rights and obligations under the transaction documents. This document cannot be reproduced except in full, without prior written approval of the Company. Any unauthorized alteration, forgery or falsification of the content or appearance of this document is unlawful and offenders may be prosecuted to the fullest extent of the law.

Unless otherwise stated the results shown in this test report refer only to the sample(s) tested and such sample(s) are retained for 30 days only.

Appendix 1

Category	Decision Rule Statement
1	<p>The decision rule for conformity reporting is based on the non-binary statement with guard band (is equal to the expanded measurement uncertainty with a 95% coverage probability, $w = U95$) in ILAC-G8:09/2019 Clause 4.2.3.</p> <p>A. "Pass - the measured value is within (or below / above) the acceptance limit, where the acceptance limit is below / above to the guard band." or "Pass - The measured values were observed in tolerance at the points tested. The specific false accept risk is up to 2.5%."</p> <p>B. "Conditional Pass - The measured values were observed in tolerance at the points tested. However, a portion of the expanded measurement uncertainty intervals about one or more measured values exceeded / out of tolerance. When the measured result is close to the tolerance, the specific false accept risk is up to 50%."</p> <p>C. "Conditional Fail - One or more measured values were observed out of tolerance at the points tested. However, a portion of the expanded measurement uncertainty intervals about one or more measured values were in tolerance. When the measured result is close to the tolerance, the specific false reject risk is up to 50%."</p> <p>D. "Fail - the measured value is out of (or below / above) the tolerance limit added / subtracted to the guard band." or "Fail - One or more measured values were observed out of tolerance at the points tested". The specific false reject risk is up to 2.5%.</p>
2	<p>The decision rule for conformity reporting is based on EN 1811:2023: Reference test method for release of nickel from all post assemblies which are inserted into pierced parts of the human body and articles intended to come into direct and prolonged contact with the skin in Section 9.2 interpretation of results.</p>
3	<p>The decision rule for conformity reporting is based on the general consideration of simple acceptance as stated in ISO/IEC Guide 98-3: "Uncertainty of measurement - Part 3: Guide to the expression of uncertainty in measurement (GUM 1995)", and more specifically for analytical measurements to the EURACHEM/CITAC Guide 2012 "Quantifying Uncertainty in Analytical Measurement".</p>
4	<p>The decision rule for conformity reporting is according to the IEC 62321-7-1 Edition 1.0 2015-09 Section 7: Table 1 - (comparison to standard solutions and interpretation of result)</p>
5	<p>The decision rule for conformity reporting is according to the IEC 62321-3-1 Edition 1.0 2013-06 Annex A.3 interpretation of result.</p>
6	<p>The decision rule for conformity reporting is according to the GB/T 39560.701-2020 Section 7: Table 1 - (comparison to standard solutions and interpretation of result)</p>
7	<p>The decision rule for conformity reporting is according to the requested specification or standard (ASTM F963-23 section 4.3.5)</p>
8	<p>The decision rule for conformity reporting is according to the requested specification or standard (AS/NZS ISO 8124 Part 3 section 4.2)</p>
9	<p>The decision rule for conformity reporting is according to the GB/T 39560.301-2020 Annex A.3 interpretation of result</p>
Remark	<p>If the decision rule is not feasible to be used and the uncertainty of the result is able to be provided, the uncertainty range of the result will be shown in the report. Otherwise, only result will be shown in the report.</p>

This document is issued by the Company subject to its General Conditions of Service printed overleaf, available on request or accessible at <http://www.sgs.com/en/Terms-and-Conditions.aspx> and, for electronic format documents, subject to Terms and Conditions for Electronic Documents at <http://www.sgs.com/en/Terms-and-Conditions/Terms-e-Documents.aspx>. Attention is drawn to the limitation of liability, indemnification and jurisdiction issues defined therein. Any holder of this document is advised that information contained hereon reflects the Company's findings at the time of its intervention only and within the limits of Client's instructions, if any. The Company's sole responsibility is to its Client and this document does not exonerate parties to a transaction from exercising all their rights and obligations under the transaction documents. This document cannot be reproduced except in full, without prior written approval of the Company. Any unauthorized alteration, forgery or falsification of the content or appearance of this document is unlawful and offenders may be prosecuted to the fullest extent of the law.

Unless otherwise stated the results shown in this test report refer only to the sample(s) tested and such sample(s) are retained for 30 days only.

Pb/Cd/Hg/Cr6+/PBBs/PBDEs Testing Flow Chart

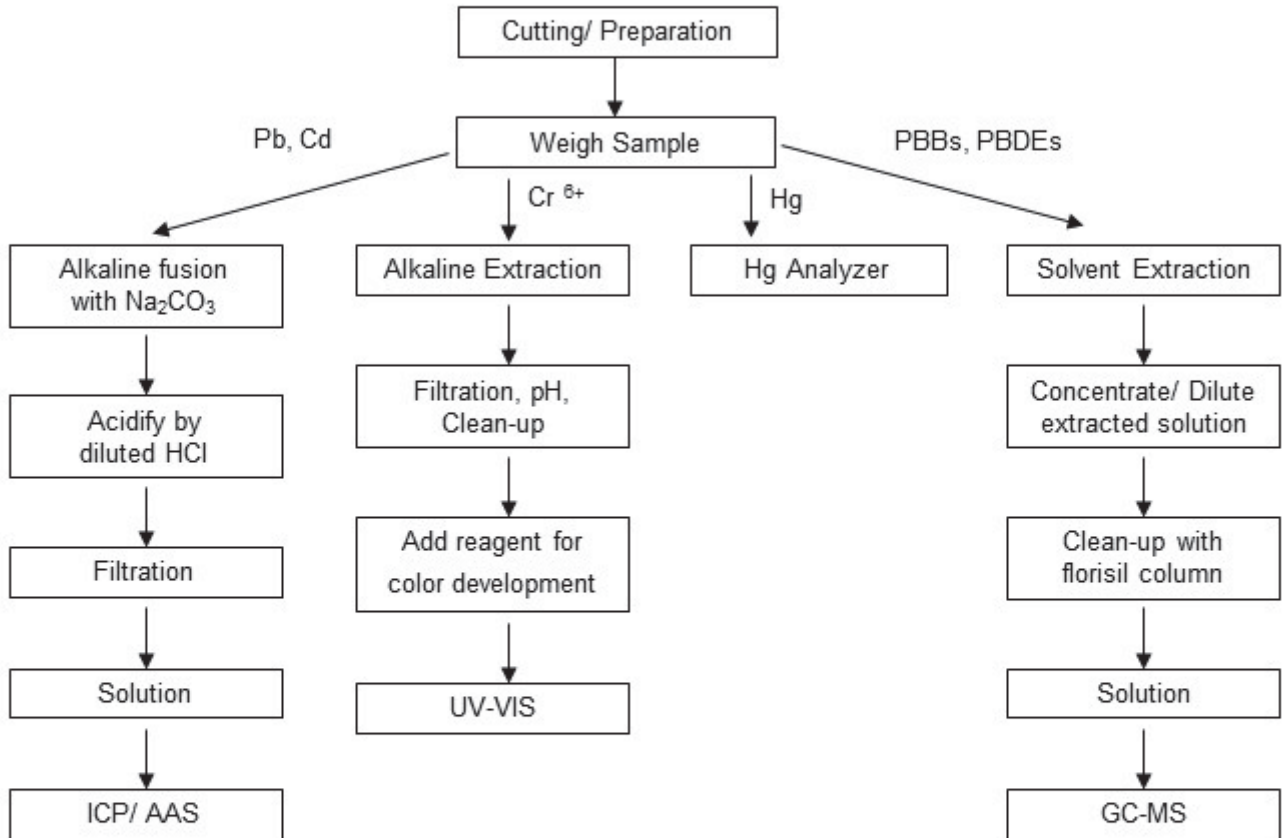

Note : 1) The polymeric samples were dissolved totally by pre-conditioning method according to above flow chat for Cd and Pb contents analysis

This document is issued by the Company subject to its General Conditions of Service printed overleaf, available on request or accessible at <http://www.sgs.com/en/Terms-and-Conditions.aspx> and, for electronic format documents, subject to Terms and Conditions for Electronic Documents at <http://www.sgs.com/en/Terms-and-Conditions/Terms-e-Document.aspx>. Attention is drawn to the limitation of liability, indemnification and jurisdiction issues defined therein. Any holder of this document is advised that information contained hereon reflects the Company's findings at the time of its intervention only and within the limits of Client's instructions, if any. The Company's sole responsibility is to its Client and this document does not exonerate parties to a transaction from exercising all their rights and obligations under the transaction documents. This document cannot be reproduced except in full, without prior written approval of the Company. Any unauthorized alteration, forgery or falsification of the content or appearance of this document is unlawful and offenders may be prosecuted to the fullest extent of the law.

Unless otherwise stated the results shown in this test report refer only to the sample(s) tested and such sample(s) are retained for 30 days only.

Phthalates Testing Flow Chart

Method: IEC 62321-8:2017

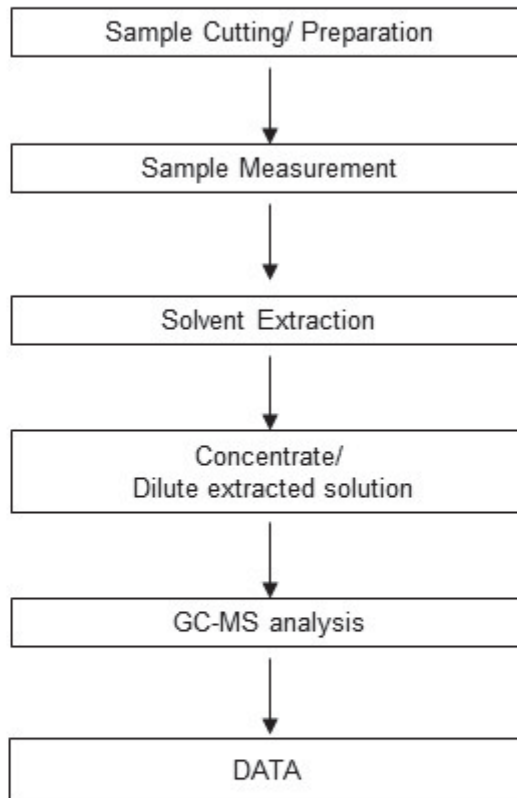

This document is issued by the Company subject to its General Conditions of Service printed overleaf, available on request or accessible at <http://www.sgs.com/en/Terms-and-Conditions.aspx> and, for electronic format documents, subject to Terms and Conditions for Electronic Documents at <http://www.sgs.com/en/Terms-and-Conditions/Terms-e-Document.aspx>. Attention is drawn to the limitation of liability, indemnification and jurisdiction issues defined therein. Any holder of this document is advised that information contained hereon reflects the Company's findings at the time of its intervention only and within the limits of Client's instructions, if any. The Company's sole responsibility is to its Client and this document does not exonerate parties to a transaction from exercising all their rights and obligations under the transaction documents. This document cannot be reproduced except in full, without prior written approval of the Company. Any unauthorized alteration, forgery or falsification of the content or appearance of this document is unlawful and offenders may be prosecuted to the fullest extent of the law.

Unless otherwise stated the results shown in this test report refer only to the sample(s) tested and such sample(s) are retained for 30 days only.

PFAS/PFOS/PFOA Testing Flow Chart

Method: CEN/TS 15968:2010

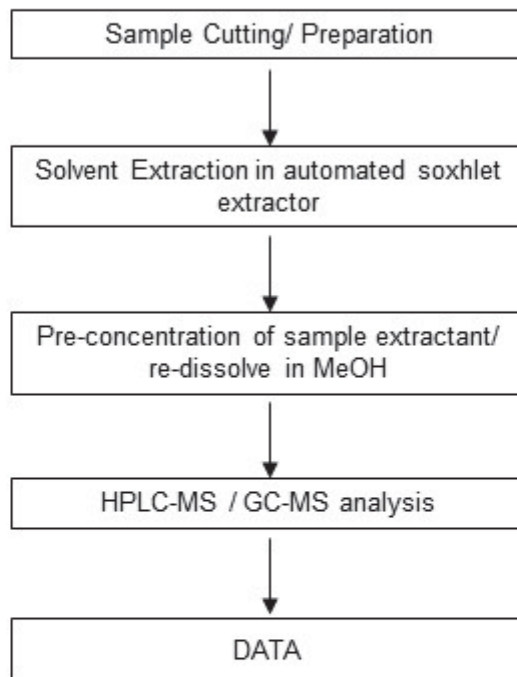

This document is issued by the Company subject to its General Conditions of Service printed overleaf, available on request or accessible at <http://www.sgs.com/en/Terms-and-Conditions.aspx> and, for electronic format documents, subject to Terms and Conditions for Electronic Documents at <http://www.sgs.com/en/Terms-and-Conditions/Terms-e-Document.aspx>. Attention is drawn to the limitation of liability, indemnification and jurisdiction issues defined therein. Any holder of this document is advised that information contained hereon reflects the Company's findings at the time of its intervention only and within the limits of Client's instructions, if any. The Company's sole responsibility is to its Client and this document does not exonerate parties to a transaction from exercising all their rights and obligations under the transaction documents. This document cannot be reproduced except in full, without prior written approval of the Company. Any unauthorized alteration, forgery or falsification of the content or appearance of this document is unlawful and offenders may be prosecuted to the fullest extent of the law.

Unless otherwise stated the results shown in this test report refer only to the sample(s) tested and such sample(s) are retained for 30 days only.

HBCDD Testing Flow Chart

Method: IEC 62321-9:2021

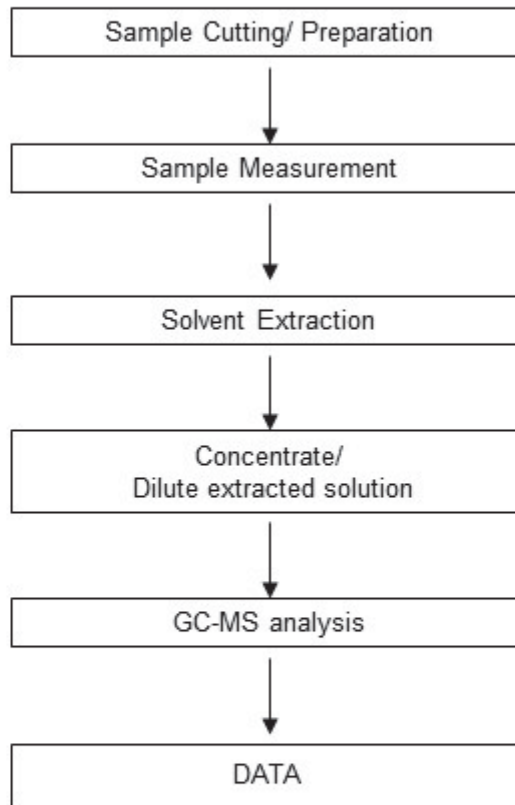

This document is issued by the Company subject to its General Conditions of Service printed overleaf, available on request or accessible at <http://www.sgs.com/en/Terms-and-Conditions.aspx> and, for electronic format documents, subject to Terms and Conditions for Electronic Documents at <http://www.sgs.com/en/Terms-and-Conditions/Terms-e-Document.aspx>. Attention is drawn to the limitation of liability, indemnification and jurisdiction issues defined therein. Any holder of this document is advised that information contained hereon reflects the Company's findings at the time of its intervention only and within the limits of Client's instructions, if any. The Company's sole responsibility is to its Client and this document does not exonerate parties to a transaction from exercising all their rights and obligations under the transaction documents. This document cannot be reproduced except in full, without prior written approval of the Company. Any unauthorized alteration, forgery or falsification of the content or appearance of this document is unlawful and offenders may be prosecuted to the fullest extent of the law.

Unless otherwise stated the results shown in this test report refer only to the sample(s) tested and such sample(s) are retained for 30 days only.

Halogen Testing Flow Chart

Method: BS EN14582:2016

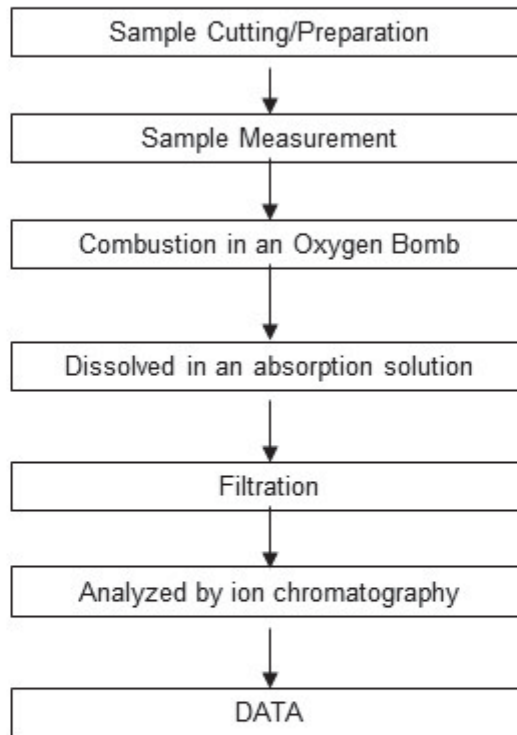

This document is issued by the Company subject to its General Conditions of Service printed overleaf, available on request or accessible at <http://www.sgs.com/en/Terms-and-Conditions.aspx> and, for electronic format documents, subject to Terms and Conditions for Electronic Documents at <http://www.sgs.com/en/Terms-and-Conditions/Terms-e-Document.aspx>. Attention is drawn to the limitation of liability, indemnification and jurisdiction issues defined therein. Any holder of this document is advised that information contained hereon reflects the Company's findings at the time of its intervention only and within the limits of Client's instructions, if any. The Company's sole responsibility is to its Client and this document does not exonerate parties to a transaction from exercising all their rights and obligations under the transaction documents. This document cannot be reproduced except in full, without prior written approval of the Company. Any unauthorized alteration, forgery or falsification of the content or appearance of this document is unlawful and offenders may be prosecuted to the fullest extent of the law.

Unless otherwise stated the results shown in this test report refer only to the sample(s) tested and such sample(s) are retained for 30 days only.

Test Report

No. HKTEC2401654111

Date: 09 May 2024

Page 14 of 14

Sample photo:



SGS authenticate the photo on original report only

*** End of Report ***

This document is issued by the Company subject to its General Conditions of Service printed overleaf, available on request or accessible at <http://www.sgs.com/en/Terms-and-Conditions.aspx> and, for electronic format documents, subject to Terms and Conditions for Electronic Documents at <http://www.sgs.com/en/Terms-and-Conditions/Terms-e-Document.aspx>. Attention is drawn to the limitation of liability, indemnification and jurisdiction issues defined therein. Any holder of this document is advised that information contained herein reflects the Company's findings at the time of its intervention only and within the limits of Client's instructions, if any. The Company's sole responsibility is to its Client and this document does not exonerate parties to a transaction from exercising all their rights and obligations under the transaction documents. This document cannot be reproduced except in full, without prior written approval of the Company. Any unauthorized alteration, forgery or falsification of the content or appearance of this document is unlawful and offenders may be prosecuted to the fullest extent of the law.

Unless otherwise stated the results shown in this test report refer only to the sample(s) tested and such sample(s) are retained for 30 days only.



Test Report

Report No. A2230496550101001

Company Name BAOTOUZHENXIONGCOPPER CO.,LTD
shown on Report

Address NNER MONGOLIA BAOTOU RARE EARTH HIGH-TECH INDUSTROAL PARK OF HOPE

The following sample(s) and sample information was/were submitted and identified by/on the behalf of the applicant

Sample Name TIN PLATING ROUND COPPER WIRE
Sample Received Date Sep. 22, 2023
Testing Period Sep. 22, 2023 to Sep. 26, 2023

Test Requested As specified by client, to test Lead (Pb), Cadmium (Cd), Mercury (Hg), Hexavalent Chromium (Cr(VI)), Polybrominated Biphenyls (PBBs), Polybrominated Diphenyl Ethers (PBDEs), Phthalates (DBP, BBP, DEHP, DIBP), Fluorine (F), Chlorine (Cl), Bromine (Br), Iodine (I) in the submitted sample(s).

Test Method Please refer to the following page(s).

Test Result(s) Please refer to the following page(s).

Conclusion

Tested Sample	According to standard/directive	Result
Submitted Sample	RoHS Directive 2011/65/EU with amendment (EU) 2015/863	PASS

PASS means that the results shown on the report comply with the limits set by RoHS Directive 2011/65/EU with amendment (EU) 2015/863.



Approved by

Chen Kaimin

Date

Sep. 26, 2023

Chen kaimin
Lab Manager

No. T172795336

Centre Testing International Pinbiao(Shanghai) Co., Ltd.

No.1351, Wanfang Road, Minhang District, Shanghai, China

Test Report

Report No. A2230496550101001

Page 2 of 7

Test Method

Test Item(s)	Test Method	Measured Equipment(s)
Lead (Pb)	IEC 62321-5:2013	ICP-OES
Cadmium (Cd)	IEC 62321-5:2013	ICP-OES
Mercury (Hg)	IEC 62321-4:2013+AMD1:2017 CSV	ICP-OES
Hexavalent Chromium (Cr(VI))	IEC 62321-7-1:2015	UV-Vis
Polybrominated Biphenyls (PBBs)	IEC 62321-6:2015	GC-MS
Polybrominated Diphenyl Ethers (PBDEs)	IEC 62321-6:2015	GC-MS
Phthalates (DBP, BBP, DEHP, DIBP)	IEC 62321-8:2017	GC-MS
Fluorine (F)	Refer to EN 14582:2016	IC
Chlorine (Cl)	Refer to EN 14582:2016	IC
Bromine (Br)	Refer to EN 14582:2016	IC
Iodine (I)	Refer to EN 14582:2016	IC

Test Report

Report No. A2230496550101001

Page 3 of 7

Test Result(s)

Tested Item(s)	Result	MDL	Limit
	001		
Lead (Pb)	N.D.	2 mg/kg	1000 mg/kg
Cadmium (Cd)	N.D.	2 mg/kg	100 mg/kg
Mercury (Hg)	N.D.	2 mg/kg	1000 mg/kg
Hexavalent Chromium (Cr(VI))	N.D. ▼	0.10 µg/cm ² (LOQ)	1000 mg/kg
Tested Item(s)	Result	MDL	Limit
	001		
Polybrominated Biphenyls (PBBs)			
Monobromobiphenyl	N.D.	5 mg/kg	1000 mg/kg
Dibromobiphenyl	N.D.	5 mg/kg	
Tribromobiphenyl	N.D.	5 mg/kg	
Tetrabromobiphenyl	N.D.	5 mg/kg	
Pentabromobiphenyl	N.D.	5 mg/kg	
Hexabromobiphenyl	N.D.	5 mg/kg	
Heptabromobiphenyl	N.D.	5 mg/kg	
Octabromobiphenyl	N.D.	5 mg/kg	
Nonabromobiphenyl	N.D.	5 mg/kg	
Decabromobiphenyl	N.D.	5 mg/kg	
Tested Item(s)	Result	MDL	Limit
	001		
Polybrominated Diphenyl Ethers (PBDEs)			
Monobromodiphenyl ether	N.D.	5 mg/kg	1000 mg/kg
Dibromodiphenyl ether	N.D.	5 mg/kg	
Tribromodiphenyl ether	N.D.	5 mg/kg	
Tetrabromodiphenyl ether	N.D.	5 mg/kg	
Pentabromodiphenyl ether	N.D.	5 mg/kg	
Hexabromodiphenyl ether	N.D.	5 mg/kg	
Heptabromodiphenyl ether	N.D.	5 mg/kg	
Octabromodiphenyl ether	N.D.	5 mg/kg	
Nonabromodiphenyl ether	N.D.	5 mg/kg	
Decabromodiphenyl ether	N.D.	5 mg/kg	

Test Report

Report No. A2230496550101001

Page 4 of 7

Test Result(s)

Tested Item(s)	Result	MDL	Limit
	001		
Phthalates (DBP, BBP, DEHP, DIBP)			
Dibutyl phthalate (DBP) CAS#:84-74-2	N.D.	50 mg/kg	1000 mg/kg
Butyl benzyl phthalate (BBP) CAS#:85-68-7	N.D.	50 mg/kg	1000 mg/kg
Di-(2-ethylhexyl) phthalate (DEHP) CAS#:117-81-7	N.D.	50 mg/kg	1000 mg/kg
Diisobutyl phthalate (DIBP) CAS#:84-69-5	N.D.	50 mg/kg	1000 mg/kg
Tested Item(s)	Result	MDL	
	001		
Fluorine (F)	N.D.	10 mg/kg	
Chlorine (Cl)	N.D.	10 mg/kg	
Bromine (Br)	N.D.	10 mg/kg	
Iodine (I)	N.D.	10 mg/kg	

Sample/Part Description

No.	CTI Sample ID	Description
1	001	Metal with silvery plating

Remark: The sample(s) had been dissolved totally tested for Lead, Cadmium, Mercury.

- MDL = Method Detection Limit
- N.D. = Not Detected (<MDL or LOQ)
- mg/kg = ppm = parts per million
- 1000 mg/kg = 0.1%
- LOQ = Limit of Quantification, The LOQ of Hexavalent chromium is 0.10 µg/cm²
- ▼The sample is negative for Cr(VI) – The Cr(VI) concentration is below 0.10 µg/cm². The coating is considered a non-Cr(VI) based coating. Information on storage conditions and production date of the tested sample is unavailable and thus Cr(VI) results represent status of the sample at the time of testing.

Test Report

Report No. A2230496550101001

Page 5 of 7

Test Process

1. Lead (Pb), Cadmium (Cd)

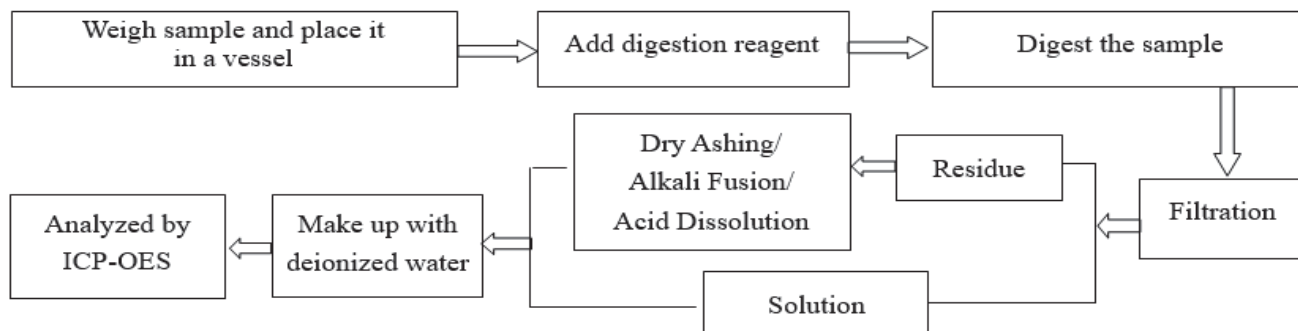

2. Mercury (Hg)

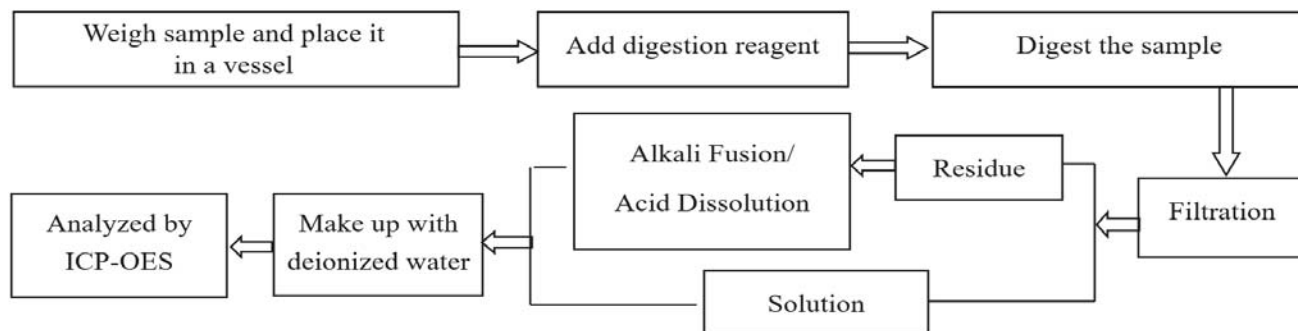

3. Hexavalent Chromium (Cr(VI))

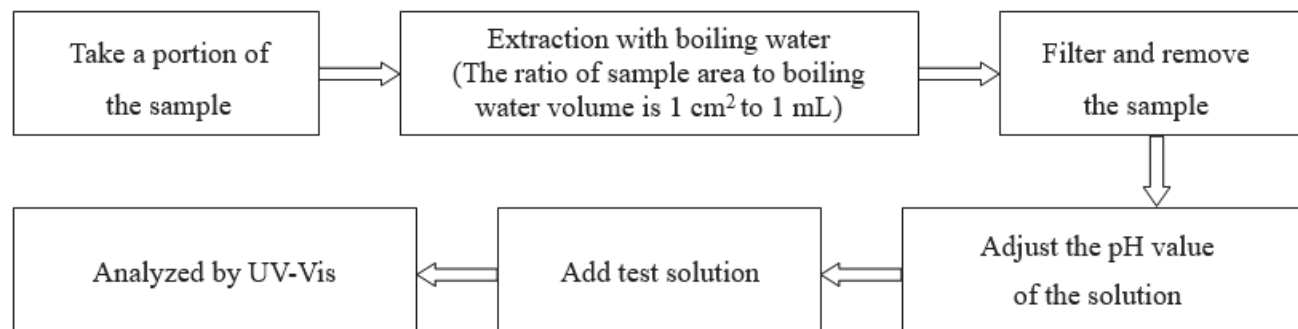

4. Polybrominated Biphenyls (PBBs), Polybrominated Diphenyl Ethers (PBDEs)

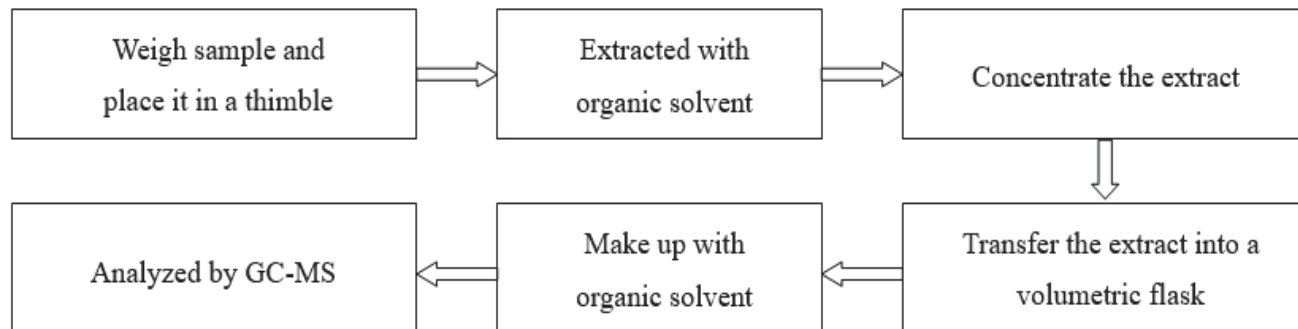

Test Report

Report No. A2230496550101001

Page 6 of 7

5. Phthalates (DBP, BBP, DEHP, DIBP)

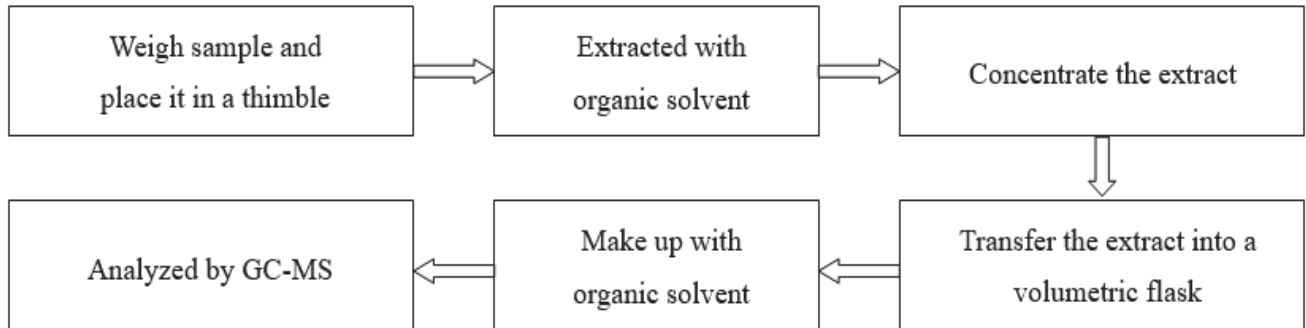

6. Fluorine (F), Chlorine (Cl), Bromine (Br), Iodine (I)

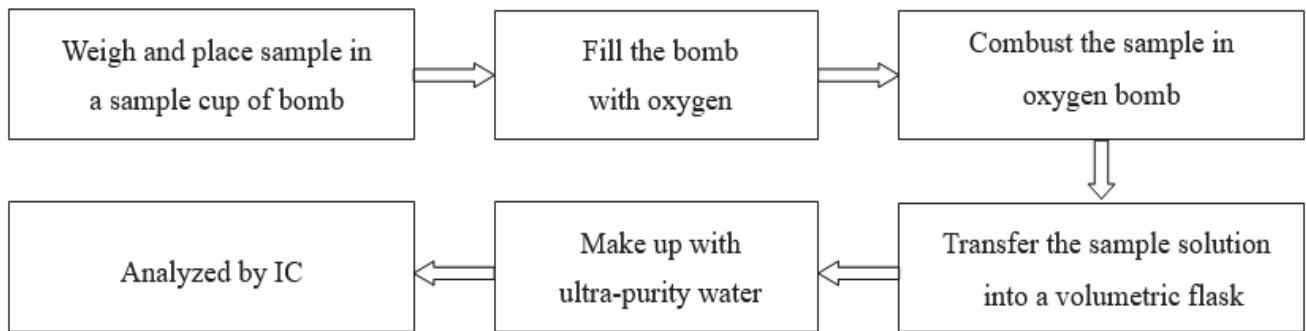

Test Report

Report No. A2230496550101001

Page 7 of 7

Photo(s) of the sample(s)



Statement:

1. This report is considered invalid without approved signature, special seal and the seal on the perforation;
2. The Company Name shown on Report and Address, the sample(s) and sample information was/were provided by the applicant who should be responsible for the authenticity which CTI hasn't verified;
3. The result(s) shown in this report refer(s) only to the sample(s) tested;
4. Without written approval of CTI, this report can't be reproduced except in full;
5. In case of any discrepancy between the English version and Chinese version of the testing reports (if generated), the Chinese version shall prevail.

*** End of report ***

Test Report

No.: NGBPC24000131241

Date: Jan 16, 2024

Page 1 of 8

Client Name: ZHEJIANG JUSHENG FLUORO-CHEMICAL CO.,LTD

Client Address: KECHENG DISTRICT, QUZHOU CITY, ZHEJIANG PROVINCE, P. R. CHINA

Sample Name: FLUORINATED ETHYLENE-PROPYLENE COPOLYMER

Other: FJP-T1、FJP-T2、FJP-T3、FJP-810、FJP-820、FJP-830、FJP-610、FJP-620、FJP-630、FJP-640、FJP-610S、FJP-620S、FJP630S、FJP-640S、FJP-1、FJP-2、FJP-3、FJP-4、FJF-1、FJF-2、FJPF-1、FJPF-2、FJPF-3、FJPF-4、FJPF-5、FJF-1P

The above sample(s) and information were provided by the client.

SGS Job No.: NBPC2401000061

Sample Receiving Date: Jan 09, 2024

Testing Period: Jan 09, 2024 ~ Jan 16, 2024

Test Requested: Select test(s) as requested by the client.

Test Method(s): Please refer to next page(s).

Test Result(s): Please refer to next page(s).

Test Requirement	Conclusion
EU RoHS Directive (EU) 2015/863 amending Annex II to Directive 2011/65/EU - Lead, Mercury, Cadmium, Hexavalent chromium, Polybrominated biphenyls (PBB), Polybrominated diphenyl ethers (PBDE), Bis(2-ethylhexyl) phthalate (DEHP), Butyl benzyl phthalate (BBP), Dibutyl phthalate (DBP) and Diisobutyl phthalate (DIBP)	Pass

Signed for and on behalf of
SGS-CSTC Standards Technical Services Co., Ltd. Ningbo Branch

李覃刚

李覃刚
Approved Signatory

Scan to see the report



NGBPC24000131241
Verification:
check.sgsonline.com.cn



Unless otherwise agreed in writing, this document is issued by the Company subject to its General Conditions of Service printed overleaf, available on request or accessible at <http://www.sgs.com/en/Terms-and-Conditions.aspx> and, for electronic format documents, subject to Terms and Conditions for Electronic Documents at <http://www.sgs.com/en/Terms-and-Conditions/Terms-e-Document.aspx>. Attention is drawn to the limitation of liability, indemnification and jurisdiction issues defined therein. Any holder of this document is advised that information contained hereon reflects the Company's findings at the time of its intervention only and within the limits of Client's instructions, if any. The Company's sole responsibility is to its Client and this document does not exonerate parties to a transaction from exercising all their rights and obligations under the transaction documents. This document cannot be reproduced except in full, without prior written approval of the Company. Any unauthorized alteration, forgery or falsification of the content or appearance of this document is unlawful and offenders may be prosecuted to the fullest extent of the law. Unless otherwise stated the results shown in this test report refer only to the sample(s) tested.

Attention: To check the authenticity of testing /inspection report & certificate, please contact us at telephone: (86-755) 8307 1443, or email: CN.Doccheck@sgs.com

Test Result(s):

Test Part Description:

SN ID	Sample No.	SGS Sample ID	Description
SN1	007	NGB24-0001312-0001.C007	TRANSLUCENT SOLID GRAINS

Remarks:

- (1) 1 mg/kg = 1 ppm = 0.0001%
- (2) MDL = Method Detection Limit
- (3) ND = Not Detected (< MDL)
- (4) “-” = Not Regulated

EU RoHS Directive (EU) 2015/863 amending Annex II to Directive 2011/65/EU - Lead, Mercury, Cadmium, Hexavalent chromium, Polybrominated biphenyls (PBB), Polybrominated diphenyl ethers (PBDE), Bis(2-ethylhexyl) phthalate (DEHP), Butyl benzyl phthalate (BBP), Dibutyl phthalate (DBP) and Diisobutyl phthalate (DIBP)

Test Method: With reference to IEC 62321-4:2013+AMD1:2017, IEC 62321-5:2013, IEC 62321-7-2:2017, IEC 62321-6:2015 and IEC 62321-8:2017, analysis was performed by ICP-OES/AAS, UV-Vis and GC-MS.

Test Item(s)	Limit	Unit(s)	MDL	007
Lead (Pb)	1000	mg/kg	2	ND
Mercury (Hg)	1000	mg/kg	2	ND
Cadmium (Cd)	100	mg/kg	2	ND
Hexavalent Chromium (Cr(VI))	1000	mg/kg	8	ND
Polybrominated biphenyls (PBB)	1000	mg/kg	-	ND
Monobrominated biphenyl (MonoBB)	-	mg/kg	5	ND
Dibrominated biphenyl (DiBB)	-	mg/kg	5	ND
Tribrominated biphenyl (TriBB)	-	mg/kg	5	ND
Tetrabrominated biphenyl (TetraBB)	-	mg/kg	5	ND
Pentabrominated biphenyl (PentaBB)	-	mg/kg	5	ND
Hexabrominated biphenyl (HexaBB)	-	mg/kg	5	ND
Heptabrominated biphenyl (HeptaBB)	-	mg/kg	5	ND
Octabrominated biphenyl (OctaBB)	-	mg/kg	5	ND
Nonabrominated biphenyl (NonaBB)	-	mg/kg	5	ND
Decabrominated biphenyl (DecaBB)	-	mg/kg	5	ND
Polybrominated diphenyl ethers (PBDE)	1000	mg/kg	-	ND
Monobrominated diphenyl ether (MonoBDE)	-	mg/kg	5	ND
Dibrominated diphenyl ether (DiBDE)	-	mg/kg	5	ND
Tribrominated diphenyl ether (TriBDE)	-	mg/kg	5	ND
Tetrabrominated diphenyl ether (TetraBDE)	-	mg/kg	5	ND
Pentabrominated diphenyl ether (PentaBDE)	-	mg/kg	5	ND
Hexabrominated diphenyl ether (HexaBDE)	-	mg/kg	5	ND
Heptabrominated diphenyl ether (HeptaBDE)	-	mg/kg	5	ND



Unless otherwise agreed in writing, this document is issued by the Company subject to its General Conditions of Service printed overleaf, available on request or accessible at <http://www.sgs.com/en/Terms-and-Conditions.aspx> and, for electronic format documents, subject to Terms and Conditions for Electronic Documents at <http://www.sgs.com/en/Terms-and-Conditions/Terms-e-Document.aspx>. Attention is drawn to the limitation of liability, indemnification and jurisdiction issues defined therein. Any holder of this document is advised that information contained hereon reflects the Company's findings at the time of its intervention only and within the limits of Client's instructions, if any. The Company's sole responsibility is to its Client and this document does not exonerate parties to a transaction from exercising all their rights and obligations under the transaction documents. This document cannot be reproduced except in full, without prior written approval of the Company. Any unauthorized alteration, forgery or falsification of the content or appearance of this document is unlawful and offenders may be prosecuted to the fullest extent of the law. Unless otherwise stated the results shown in this test report refer only to the sample(s) tested.

Attention: To check the authenticity of testing /inspection report & certificate, please contact us at telephone: (86-755) 8307 1443, or email: CN.Doccheck@sgs.com

Test Report

No.: NGBPC24000131241

Date: Jan 16, 2024

Page 3 of 8

Test Item(s)	Limit	Unit(s)	MDL	007
Octabrominated diphenyl ether (OctaBDE)	-	mg/kg	5	ND
Nonabrominated diphenyl ether (NonaBDE)	-	mg/kg	5	ND
Decabrominated diphenyl ether (DecaBDE)	-	mg/kg	5	ND
Bis(2-ethylhexyl) phthalate (DEHP)	1000	mg/kg	50	ND
Butyl benzyl phthalate (BBP)	1000	mg/kg	50	ND
Dibutyl phthalate (DBP)	1000	mg/kg	50	ND
Diisobutyl phthalate (DIBP)	1000	mg/kg	50	ND

Notes:

- (1) The maximum permissible limit is quoted from RoHS Directive (EU) 2015/863.
- (2) IEC 62321 series is equivalent to EN 62321 series.
- (3) The restriction of DEHP, BBP, DBP and DIBP shall apply to medical devices, including in vitro medical devices, and monitoring and control instruments, including industrial monitoring and control instruments, from 22 July 2021.

Unless otherwise stated, the decision rule for conformity reporting is based on Binary Statement for Simple Acceptance Rule (w=0) stated in ILAC-G8:09/2019.



Unless otherwise agreed in writing, this document is issued by the Company subject to its General Conditions of Service printed overleaf, available on request or accessible at <http://www.sgs.com/en/Terms-and-Conditions.aspx> and, for electronic format documents, subject to Terms and Conditions for Electronic Documents at <http://www.sgs.com/en/Terms-and-Conditions/Terms-e-Document.aspx>. Attention is drawn to the limitation of liability, indemnification and jurisdiction issues defined therein. Any holder of this document is advised that information contained hereon reflects the Company's findings at the time of its intervention only and within the limits of Client's instructions, if any. The Company's sole responsibility is to its Client and this document does not exonerate parties to a transaction from exercising all their rights and obligations under the transaction documents. This document cannot be reproduced except in full, without prior written approval of the Company. Any unauthorized alteration, forgery or falsification of the content or appearance of this document is unlawful and offenders may be prosecuted to the fullest extent of the law. Unless otherwise stated the results shown in this test report refer only to the sample(s) tested.

Attention: To check the authenticity of testing /inspection report & certificate, please contact us at telephone: (86-755) 8307 1443, or email: CN.Doccheck@sgs.com

SGS-CSTC Standards Technical Services Co., Ltd.
Ningbo Branch Chemical Laboratory

No.1177, Lingyun Road, Hi-Tech Zone, Ningbo, Zhejiang, China 315040 tE&E (86-574)89070249
中国·浙江·宁波高新区凌云路1177号 邮编: 315040 tHL (86-574)89070271 tML (86-574)89070242 sgs.china@sgs.com

www.sgs.com.cn

Elements Testing Flow Chart

These samples were dissolved totally by pre-conditioning method according to below flow chart.

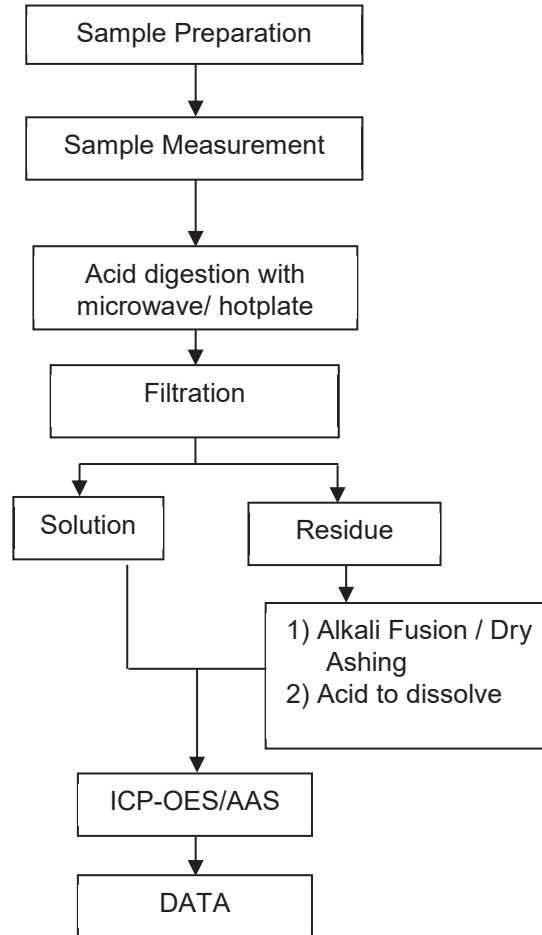

Unless otherwise agreed in writing, this document is issued by the Company subject to its General Conditions of Service printed overleaf, available on request or accessible at <http://www.sgs.com/en/Terms-and-Conditions.aspx> and, for electronic format documents, subject to Terms and Conditions for Electronic Documents at <http://www.sgs.com/en/Terms-and-Conditions/Terms-e-Document.aspx>. Attention is drawn to the limitation of liability, indemnification and jurisdiction issues defined therein. Any holder of this document is advised that information contained hereon reflects the Company's findings at the time of its intervention only and within the limits of Client's instructions, if any. The Company's sole responsibility is to its Client and this document does not exonerate parties to a transaction from exercising all their rights and obligations under the transaction documents. This document cannot be reproduced except in full, without prior written approval of the Company. Any unauthorized alteration, forgery or falsification of the content or appearance of this document is unlawful and offenders may be prosecuted to the fullest extent of the law. Unless otherwise stated the results shown in this test report refer only to the sample(s) tested.

Attention: To check the authenticity of testing /inspection report & certificate, please contact us at telephone: (86-755) 8307 1443, or email: CN.Doccheck@sgs.com

Hexavalent Chromium (Cr(VI)) Testing Flow Chart

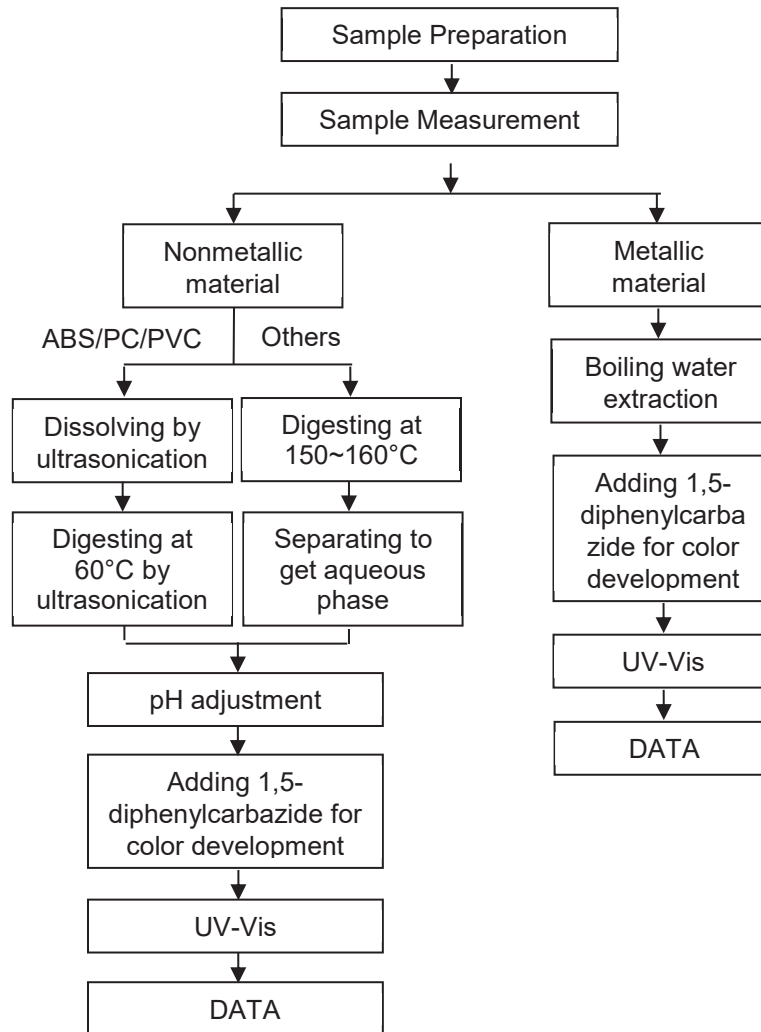

Unless otherwise agreed in writing, this document is issued by the Company subject to its General Conditions of Service printed overleaf, available on request or accessible at <http://www.sgs.com/en/Terms-and-Conditions.aspx> and, for electronic format documents, subject to Terms and Conditions for Electronic Documents at <http://www.sgs.com/en/Terms-and-Conditions/Terms-e-Document.aspx>. Attention is drawn to the limitation of liability, indemnification and jurisdiction issues defined therein. Any holder of this document is advised that information contained hereon reflects the Company's findings at the time of its intervention only and within the limits of Client's instructions, if any. The Company's sole responsibility is to its Client and this document does not exonerate parties to a transaction from exercising all their rights and obligations under the transaction documents. This document cannot be reproduced except in full, without prior written approval of the Company. Any unauthorized alteration, forgery or falsification of the content or appearance of this document is unlawful and offenders may be prosecuted to the fullest extent of the law. Unless otherwise stated the results shown in this test report refer only to the sample(s) tested.

Attention: To check the authenticity of testing / inspection report & certificate, please contact us at telephone: (86-755) 8307 1443, or email: CN.Doccheck@sgs.com

PBBs/PBDEs Testing Flow Chart

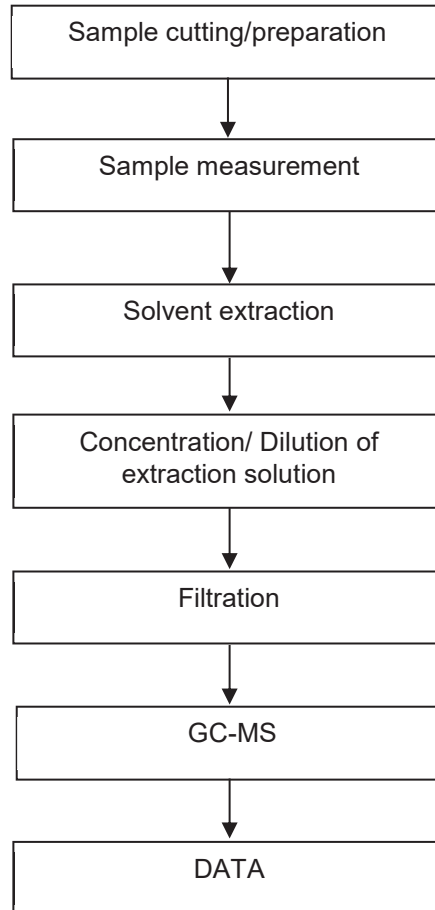

Unless otherwise agreed in writing, this document is issued by the Company subject to its General Conditions of Service printed overleaf, available on request or accessible at <http://www.sgs.com/en/Terms-and-Conditions.aspx> and, for electronic format documents, subject to Terms and Conditions for Electronic Documents at <http://www.sgs.com/en/Terms-and-Conditions/Terms-e-Document.aspx>. Attention is drawn to the limitation of liability, indemnification and jurisdiction issues defined therein. Any holder of this document is advised that information contained hereon reflects the Company's findings at the time of its intervention only and within the limits of Client's instructions, if any. The Company's sole responsibility is to its Client and this document does not exonerate parties to a transaction from exercising all their rights and obligations under the transaction documents. This document cannot be reproduced except in full, without prior written approval of the Company. Any unauthorized alteration, forgery or falsification of the content or appearance of this document is unlawful and offenders may be prosecuted to the fullest extent of the law. Unless otherwise stated the results shown in this test report refer only to the sample(s) tested.

Attention: To check the authenticity of testing /inspection report & certificate, please contact us at telephone: (86-755) 8307 1443, or email: CN.Doccheck@sgs.com

Phthalates Testing Flow Chart

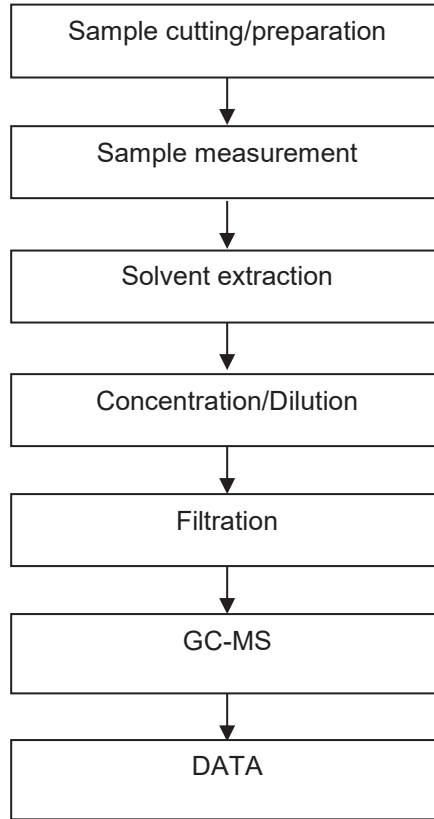

SGS-CSTC Standards Technical Services Co., Ltd.
Ningbo Branch Chemical Laboratory

Unless otherwise agreed in writing, this document is issued by the Company subject to its General Conditions of Service printed overleaf, available on request or accessible at <http://www.sgs.com/en/Terms-and-Conditions.aspx> and, for electronic format documents, subject to Terms and Conditions for Electronic Documents at <http://www.sgs.com/en/Terms-and-Conditions/Terms-e-Document.aspx>. Attention is drawn to the limitation of liability, indemnification and jurisdiction issues defined therein. Any holder of this document is advised that information contained hereon reflects the Company's findings at the time of its intervention only and within the limits of Client's instructions, if any. The Company's sole responsibility is to its Client and this document does not exonerate parties to a transaction from exercising all their rights and obligations under the transaction documents. This document cannot be reproduced except in full, without prior written approval of the Company. Any unauthorized alteration, forgery or falsification of the content or appearance of this document is unlawful and offenders may be prosecuted to the fullest extent of the law. Unless otherwise stated the results shown in this test report refer only to the sample(s) tested.

Attention: To check the authenticity of testing /inspection report & certificate, please contact us at telephone: (86-755) 8307 1443, or email: CN.Doccheck@sgs.com

No.1177, Lingyun Road, Hi-Tech Zone, Ningbo, Zhejiang, China 315040 tE&E (86-574)89070249

www.sgsgroup.com.cn

中国·浙江·宁波高新区凌云路1177号 邮编: 315040 tHL (86-574)89070271 tML (86-574)89070242 sgs.china@sgs.com

Test Report

No.: NGBPC24000131241

Date: Jan 16, 2024

Page 8 of 8

Sample Photo:



SGS authenticate the photo on original report only
*** End of Report ***



Unless otherwise agreed in writing, this document is issued by the Company subject to its General Conditions of Service printed overleaf, available on request or accessible at <http://www.sgs.com/en/Terms-and-Conditions.aspx> and, for electronic format documents, subject to Terms and Conditions for Electronic Documents at <http://www.sgs.com/en/Terms-and-Conditions/Terms-e-Document.aspx>. Attention is drawn to the limitation of liability, indemnification and jurisdiction issues defined therein. Any holder of this document is advised that information contained hereon reflects the Company's findings at the time of its intervention only and within the limits of Client's instructions, if any. The Company's sole responsibility is to its Client and this document does not exonerate parties to a transaction from exercising all their rights and obligations under the transaction documents. This document cannot be reproduced except in full, without prior written approval of the Company. Any unauthorized alteration, forgery or falsification of the content or appearance of this document is unlawful and offenders may be prosecuted to the fullest extent of the law. Unless otherwise stated the results shown in this test report refer only to the sample(s) tested.

Attention: To check the authenticity of testing /inspection report & certificate, please contact us at telephone: (86-755) 8307 1443, or email: CN.Doccheck@sgs.com

SGS-CSTC Standards Technical Services Co., Ltd.
Ningbo Branch Chemical Laboratory

No.1177, Lingyun Road, Hi-Tech Zone, Ningbo, Zhejiang, China 315040 tE&E (86-574)89070249
中国·浙江·宁波高新区凌云路1177号 邮编: 315040 tHL (86-574)89070271 tML (86-574)89070242 sgs.china@sgs.com

www.sgsgroup.com.cn

Test Report

No.: SHAEC23019069713

Date: Dec 04, 2023

Page 1 of 13

Client Name: Changzhou Hengfeng Special Conductor Co., Ltd.

Client Address: No. 290, Changting Road, West Taihu Science and Technology Industrial Park

Sample Name: SILVER-COATED COPPER WIRE

The above sample(s) and information were provided by the client.

SGS Job No.: SHP23-019178

Sample Receiving Date: Nov 20, 2023

Testing Period: Nov 20, 2023 ~ Nov 27, 2023

Test Requested: Select test(s) as requested by the client.

Test Method(s): Please refer to next page(s).

Test Result(s): Please refer to next page(s).

Test Requirement	Conclusion
EU RoHS Directive (EU) 2015/863 amending Annex II to Directive 2011/65/EU- Lead, Mercury, Cadmium, Hexavalent chromium, Polybrominated biphenyls (PBBs), Polybrominated diphenyl ethers (PBDEs), Bis(2-ethylhexyl) phthalate (DEHP), Butyl benzyl phthalate (BBP), Dibutyl phthalate (DBP) and Diisobutyl phthalate (DIBP)	Pass
EU RoHS Directive (EU) 2015/863 amending Annex II to Directive 2011/65/EU- Lead, Mercury, Cadmium and Hexavalent chromium	Pass
Benzenamine,N-phenyl-,Reaction Products with Styrene and 2,4,4-Trimethylpentene (BNST)	See Results
Element(s)	See Results
Perfluorooctanesulfonate (PFOS) and its derivatives and Perfluorooctanoic Acid (PFOA).	See Results

Signed for and on behalf of
SGS-CSTC Standards Technical Services (Shanghai) Co., Ltd.



Jenny Lan
Approved Signatory



Unless otherwise agreed in writing, this document is issued by the Company subject to its General Conditions of Service printed overleaf, available on request or accessible at <http://www.sgs.com/en/Terms-and-Conditions.aspx> and, for electronic format documents, subject to Terms and Conditions for Electronic Documents at <http://www.sgs.com/en/Terms-and-Conditions/Terms-e-Documents.aspx>. Attention is drawn to the limitation of liability, indemnification and jurisdiction issues defined therein. Any holder of this document is advised that information contained hereon reflects the Company's findings at the time of its intervention only and within the limits of Client's instructions, if any. The Company's sole responsibility is to its Client and this document does not exonerate parties to a transaction from exercising all their rights and obligations under the transaction documents. This document cannot be reproduced except in full, without prior written approval of the Company. Any unauthorized alteration, forgery or falsification of the content or appearance of this document is unlawful and offenders may be prosecuted to the fullest extent of the law. Unless otherwise stated the results shown in this test report refer only to the sample(s) tested.

Attention: To check the authenticity of testing/inspection report & certificate, please contact us at telephone: (86-755) 8307 1443, or email: CN.Doccheck@sgs.com

SGS-CSTC Standards Technical Services (Shanghai) Co., Ltd.
Testing Center-China

3rd Building, No. 889 Yishan Road Xuhui District, Shanghai China 200233 t E&E (86-21) 61402553 f E&E (86-21) 64953679 www.sgs.com.cn
中国·上海·徐汇区宜山路889号3号楼 邮编: 200233 t HL (86-21) 61402594 f HL (86-21) 61156899 e sgs.china@sgs.com

Test Result(s):

Test Part Description:

SN ID	Sample No.	SGS Sample ID	Description
SN1	A19	SHA23-0190697-0001.C019	Silvery metal(plating)
SN2	A20	SHA23-0190697-0001.C020	Copper metal(base)
SN3	A21	SHA23-0190697-0001.C021	Silvery metal

Remarks:

- (1) 1 mg/kg = 1 ppm = 0.0001%
- (2) MDL = Method Detection Limit
- (3) ND = Not Detected (< MDL)
- (4) “-” = Not Regulated

EU RoHS Directive (EU) 2015/863 amending Annex II to Directive 2011/65/EU- Lead, Mercury, Cadmium, Hexavalent chromium, Polybrominated biphenyls (PBBs), Polybrominated diphenyl ethers (PBDEs), Bis(2-ethylhexyl) phthalate (DEHP), Butyl benzyl phthalate (BBP), Dibutyl phthalate (DBP) and Diisobutyl phthalate (DIBP)

Test Method: With reference to IEC 62321-4:2013+AMD1:2017, IEC 62321-5:2013, IEC 62321-7-1:2015, IEC 62321-6:2015 and IEC62321-8:2017, analysis was performed by ICP-OES, AAS, UV-Vis and GC-MS.

Test Item(s)	Limit	Unit(s)	MDL	A20
Cadmium(Cd)	100	mg/kg	2	ND
Lead(Pb)	1000	mg/kg	2	ND
Mercury(Hg)	1000	mg/kg	2	ND
Hexavalent Chromium (Cr(VI)) ▼	-	µg/cm ²	0.10	ND
Polybromobiphenyl (PBBs)	1000	mg/kg	-	ND
Monobromobiphenyl (MonoBB)	-	mg/kg	5	ND
Dibromobiphenyl (DiBB)	-	mg/kg	5	ND
Tribromobiphenyl (TriBB)	-	mg/kg	5	ND
Tetrabromobiphenyl (TetraBB)	-	mg/kg	5	ND
Pentabromobiphenyl (PentaBB)	-	mg/kg	5	ND
Hexabromobiphenyl (HexaBB)	-	mg/kg	5	ND
Heptabromobiphenyl (HeptaBB)	-	mg/kg	5	ND
Octabromobiphenyl (OctaBB)	-	mg/kg	5	ND
Nonabromobiphenyl (NonaBB)	-	mg/kg	5	ND
Decabromobiphenyl (DecaBB)	-	mg/kg	5	ND
Polybromodiphenyl ether(PBDEs)	1000	mg/kg	-	ND
Monobromodiphenylether (MonoBDE)	-	mg/kg	5	ND
Dibromodiphenylether (DiBDE)	-	mg/kg	5	ND
Tribromodiphenylether (TriBDE)	-	mg/kg	5	ND
Tetrabromodiphenylether (TetraBDE)	-	mg/kg	5	ND
Pentabromodiphenylether (PentaBDE)	-	mg/kg	5	ND
Hexabromodiphenylether (HexaBDE)	-	mg/kg	5	ND
Heptabromodiphenylether (HeptaBDE)	-	mg/kg	5	ND
Octabromodiphenylether (OctaBDE)	-	mg/kg	5	ND
Nonabromodiphenylether (NonaBDE)	-	mg/kg	5	ND
Decabromodiphenylether (DecaBDE)	-	mg/kg	5	ND



Unless otherwise agreed in writing, this document is issued by the Company subject to its General Conditions of Service printed overleaf, available on request or accessible at <http://www.sgs.com/en/Terms-and-Conditions.aspx> and, for electronic format documents, subject to Terms and Conditions for Electronic Documents at <http://www.sgs.com/en/Terms-and-Conditions/Terms-e-Documents.aspx>. Attention is drawn to the limitation of liability, indemnification and jurisdiction issues defined therein. Any holder of this document is advised that information contained hereon reflects the Company's findings at the time of its intervention only and within the limits of Client's instructions, if any. The Company's sole responsibility is to its Client and this document does not exonerate parties to a transaction from exercising all their rights and obligations under the transaction documents. This document cannot be reproduced except in full, without prior written approval of the Company. Any unauthorized alteration, forgery or falsification of the content or appearance of this document is unlawful and offenders may be prosecuted to the fullest extent of the law. Unless otherwise stated the results shown in this test report refer only to the sample(s) tested.

Attention: To check the authenticity of testing /inspection report & certificate, please contact us at telephone: (86-755) 8307 1443, or email: CN.Doccheck@sgs.com

3rd Building, No.889 Yishan Road Xuhui District, Shanghai China 200233 t E&E (86-21) 61402553 f E&E (86-21) 64953679 www.sgsgroup.com.cn
 中国·上海·徐汇区宜山路889号3号楼 邮编: 200233 t HL (86-21) 61402594 f HL (86-21) 61156899 e sgs.china@sgs.com

Test Report

No.: SHAEC23019069713

Date: Dec 04, 2023

Page 3 of 13

Test Item(s)	Limit	Unit(s)	MDL	A20
Dibutyl Phthalate(DBP)	1000	mg/kg	50	ND
Benzyl Butyl Phthalate(BBP)	1000	mg/kg	50	ND
Bis-(2-ethylhexyl) Phthalate(DEHP)	1000	mg/kg	50	ND
Diisobutyl Phthalate(DIBP)	1000	mg/kg	50	ND

Notes:

- (1) The maximum permissible limit is quoted from RoHS Directive (EU) 2015/863.
 - (2) IEC 62321 series is equivalent to EN 62321 series.
 - (3) ▼ = a. The sample is positive for Cr(VI) if the Cr(VI) concentration is greater than 0.13 µg/cm². The sample coating is considered to contain Cr(VI)
 - b. The sample is negative for Cr(VI) if Cr(VI) is ND (concentration less than 0.10 µg/cm²). The coating is considered a non-Cr(VI) based coating
 - c. The result between 0.10 µg/cm² and 0.13 µg/cm² is considered to be inconclusive-unavoidable coating variations may influence the determination.
- Information on storage conditions and production date of the tested sample is unavailable and thus Cr(VI) results represent status of the sample at the time of testing.

EU RoHS Directive (EU) 2015/863 amending Annex II to Directive 2011/65/EU- Lead, Mercury, Cadmium and Hexavalent chromium

Test Method: With reference to IEC 62321-4:2013+AMD1:2017, IEC 62321-5:2013 and IEC 62321-7-1:2015, analysis was performed by ICP-OES and UV-Vis.

Test Item(s)	Limit	Unit(s)	MDL	A19
Cadmium(Cd)	100	mg/kg	10	ND
Lead (Pb)	1000	mg/kg	10	ND
Mercury (Hg)	1000	mg/kg	10	ND
Hexavalent Chromium (Cr(VI)) ▼	-	µg/cm ²	0.10	ND

Notes:

- (1) The maximum permissible limit is quoted from RoHS Directive (EU) 2015/863.
- (2) IEC 62321 series is equivalent to EN 62321 series.
- (3) ▼ = a. The sample is positive for Cr(VI) if the Cr(VI) concentration is greater than 0.13 µg/cm². The sample coating is considered to contain Cr(VI)
- b. The sample is negative for Cr(VI) if Cr(VI) is ND (concentration less than 0.10 µg/cm²). The coating is considered a non-Cr(VI) based coating
- c. The result between 0.10 µg/cm² and 0.13 µg/cm² is considered to be inconclusive - unavoidable coating variations may influence the determination

Information on storage conditions and production date of the tested sample is unavailable and thus Cr(VI) results represent status of the sample at the time of testing.

Benzenamine,N-phenyl-,Reaction Products with Styrene and 2,4,4-Trimethylpentene (BNST)

Test Method: With reference to EPA method 3550C:2007 & EPA method 8270E: 2018, analysis was performed by GC-MS.



Unless otherwise agreed in writing, this document is issued by the Company subject to its General Conditions of Service printed overleaf, available on request or accessible at <http://www.sgs.com/en/Terms-and-Conditions.aspx> and, for electronic format documents, subject to Terms and Conditions for Electronic Documents at <http://www.sgs.com/en/Terms-and-Conditions/Terms-e-Documents.aspx>. Attention is drawn to the limitation of liability, indemnification and jurisdiction issues defined therein. Any holder of this document is advised that information contained hereon reflects the Company's findings at the time of its intervention only and within the limits of Client's instructions, if any. The Company's sole responsibility is to its Client and this document does not exonerate parties to a transaction from exercising all their rights and obligations under the transaction documents. This document cannot be reproduced except in full, without prior written approval of the Company. Any unauthorized alteration, forgery or falsification of the content or appearance of this document is unlawful and offenders may be prosecuted to the fullest extent of the law. Unless otherwise stated the results shown in this test report refer only to the sample(s) tested.

SGS-CSTC (Shanghai) Technical Services (Shanghai) Co., Ltd.
Testing Center-Chemistry

Attention: To check the authenticity of testing / inspection report & certificate, please contact us at telephone: (86-755) 8307 1443, or email: CN.Doccheck@sgs.com
 3rd Building, No.889 Yishan Road Xuhui District, Shanghai China 200233 t E&E (86-21) 61402553 f E&E (86-21) 64953679 www.sgsgroup.com.cn
 中国·上海·徐汇区宜山路889号3号楼 邮编: 200233 t HL (86-21) 61402594 f HL (86-21) 61156899 e sgs.china@sgs.com

Test Report

No.: SHAEC23019069713

Date: Dec 04, 2023

Page 4 of 13

Test Item(s)	CAS No.	Unit(s)	MDL	A21
Benzenamine,N-phenyl-,Reaction Products with Styrene and 2,4,4-Trimethylpentene (BNST)	68921-45-9	mg/kg	10	ND

Element(s)

Test Method: With reference to US EPA 3050B:1996, analysis was performed by ICP-OES/AAS.

Test Item(s)	Unit(s)	MDL	A21
Antimony(Sb)	mg/kg	10	ND
Beryllium(Be)	mg/kg	5	ND

Perfluorooctanesulfonate (PFOS) and its derivatives and Perfluorooctanoic Acid (PFOA).

Test Method: With reference to CEN/TS 15968:2010, analysis was performed by HPLC-MS or LC-MS/MS.

Test Item(s)	CAS No.	Unit(s)	MDL	A21
Perfluorooctane sulfonates (PFOS) and its derivatives	-	mg/kg	-	ND
Perfluorooctanesulfonic acid (PFOS)^	1763-23-1	mg/kg	10	ND
N-ethylperfluoro-1-octanesulfonamide (EtFOSA)	4151-50-2	mg/kg	10	ND
N-methylperfluoro-1-octanesulfonamide (MeFOSA)	31506-32-8	mg/kg	10	ND
2-(N-ethylperfluoro-1-octanesulfonamido)-ethanol (EtFOSE)	1691-99-2	mg/kg	10	ND
2-(N-methylperfluoro-1-octanesulfonamido)- ethanol (MeFOSE)	24448-09-7	mg/kg	10	ND
Perfluorooctane Sulfonamide (PFOSA)	754-91-6	mg/kg	10	ND
Perfluorooctanoic Acid (PFOA) and its salts+	-	mg/kg	10	ND

Notes:

- (1) + PFOA refer to its salts including PFOA-Na (CAS No.: 335-95-5), PFOA-K (CAS No.: 2395-00-8), PFOA-Ag (CAS No.: 335-93-3), PFOA-F (CAS No.: 335-66-0) and APFO (CAS No.: 3825-26-1);
- (2) ^ PFOS including PFOS-K (CAS No.: 2795-39-3), PFOS-Li (CAS No.: 29457-72-5), PFOS-NH₄ (CAS No.: 29081-56-9), PFOS-NH(OH)₂ (CAS No.: 70225-14-8), PFOS-N(C₂H₅)₄ (CAS No.: 56773-42-3), PFOS-DDA (CAS No.: 251099-16-8) and POSF (CAS No.: 307-35-7).

Unless otherwise stated, the decision rule for conformity reporting is based on Binary Statement for Simple Acceptance Rule (w=0) stated in ILAC-G8:09/2019.



Unless otherwise agreed in writing, this document is issued by the Company subject to its General Conditions of Service printed overleaf, available on request or accessible at <http://www.sgs.com/en/Terms-and-Conditions.aspx> and, for electronic format documents, subject to Terms and Conditions for Electronic Documents at <http://www.sgs.com/en/Terms-and-Conditions/Terms-e-Documents.aspx>. Attention is drawn to the limitation of liability, indemnification and jurisdiction issues defined therein. Any holder of this document is advised that information contained hereon reflects the Company's findings at the time of its intervention only and within the limits of Client's instructions, if any. The Company's sole responsibility is to its Client and this document does not exonerate parties to a transaction from exercising all their rights and obligations under the transaction documents. This document cannot be reproduced except in full, without prior written approval of the Company. Any unauthorized alteration, forgery or falsification of the content or appearance of this document is unlawful and offenders may be prosecuted to the fullest extent of the law. Unless otherwise stated the results shown in this test report refer only to the sample(s) tested.

Attention: To check the authenticity of testing /inspection report & certificate, please contact us at telephone: (86-755) 8307 1443, or email: CN.Doccheck@sgs.com

SGS-CSTC (Shanghai) Technical Services Co., Ltd.
Testing Center-Chemistry

3rd Building, No.889 Yishan Road Xuhui District, Shanghai China 200233 t E&E (86-21) 61402553 f E&E (86-21) 64953679 www.sgsgroup.com.cn
中国·上海·徐汇区宜山路889号3号楼 邮编: 200233 t HL (86-21) 61402594 f HL (86-21) 61156899 e sgs.china@sgs.com

Elements Testing Flow Chart

These samples were dissolved totally by pre-conditioning method according to below flow chart.

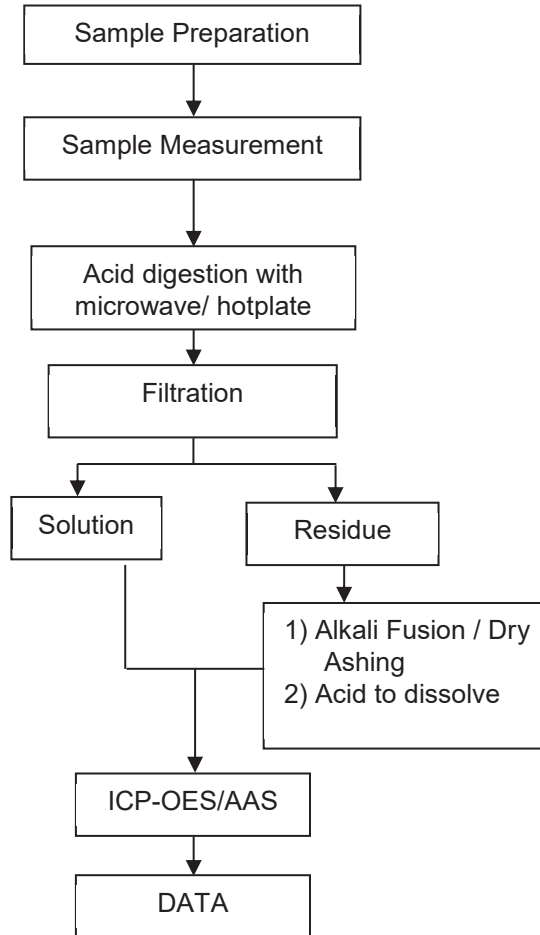

Unless otherwise agreed in writing, this document is issued by the Company subject to its General Conditions of Service printed overleaf, available on request or accessible at <http://www.sgs.com/en/Terms-and-Conditions.aspx> and, for electronic format documents, subject to Terms and Conditions for Electronic Documents at <http://www.sgs.com/en/Terms-and-Conditions/Terms-e-Documents.aspx>. Attention is drawn to the limitation of liability, indemnification and jurisdiction issues defined therein. Any holder of this document is advised that information contained hereon reflects the Company's findings at the time of its intervention only and within the limits of Client's instructions, if any. The Company's sole responsibility is to its Client and this document does not exonerate parties to a transaction from exercising all their rights and obligations under the transaction documents. This document cannot be reproduced except in full, without prior written approval of the Company. Any unauthorized alteration, forgery or falsification of the content or appearance of this document is unlawful and offenders may be prosecuted to the fullest extent of the law. Unless otherwise stated the results shown in this test report refer only to the sample(s) tested.

Attention: To check the authenticity of testing / inspection report & certificate, please contact us at telephone: (86-755) 8307 1443, or email: CN.Doccheck@sgs.com

3rd Building, No.889 Yishan Road Xuhui District, Shanghai China 200233 t E&E (86-21) 61402553 f E&E (86-21) 64953679 www.sgsgroup.com.cn
 中国·上海·徐汇区宜山路889号3号楼 邮编: 200233 t HL (86-21) 61402594 f HL (86-21) 61156899 e sgs.china@sgs.com

Hexavalent Chromium (Cr(VI)) Testing Flow Chart

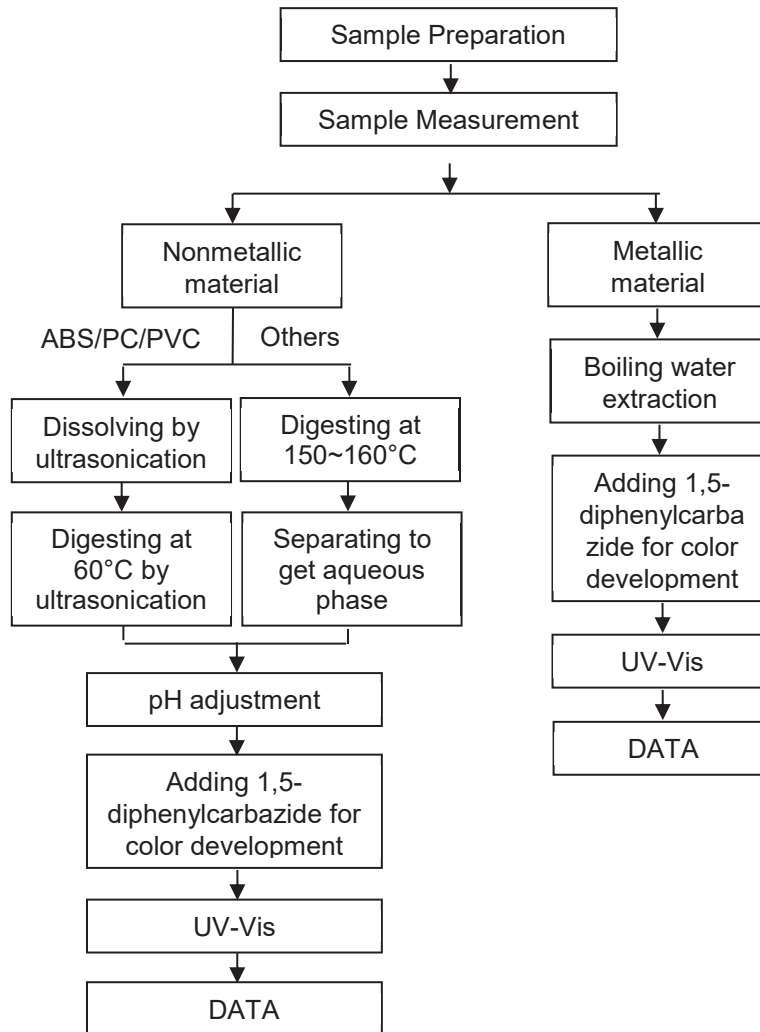

Unless otherwise agreed in writing, this document is issued by the Company subject to its General Conditions of Service printed overleaf, available on request or accessible at <http://www.sgs.com/en/Terms-and-Conditions.aspx> and, for electronic format documents, subject to Terms and Conditions for Electronic Documents at <http://www.sgs.com/en/Terms-and-Conditions/Terms-e-Documents.aspx>. Attention is drawn to the limitation of liability, indemnification and jurisdiction issues defined therein. Any holder of this document is advised that information contained hereon reflects the Company's findings at the time of its intervention only and within the limits of Client's instructions, if any. The Company's sole responsibility is to its Client and this document does not exonerate parties to a transaction from exercising all their rights and obligations under the transaction documents. This document cannot be reproduced except in full, without prior written approval of the Company. Any unauthorized alteration, forgery or falsification of the content or appearance of this document is unlawful and offenders may be prosecuted to the fullest extent of the law. Unless otherwise stated the results shown in this test report refer only to the sample(s) tested.

Attention: To check the authenticity of testing / inspection report & certificate, please contact us at telephone: (86-755) 8307 1443, or email: CN.Doccheck@sgs.com

PBBs/PBDEs Testing Flow Chart

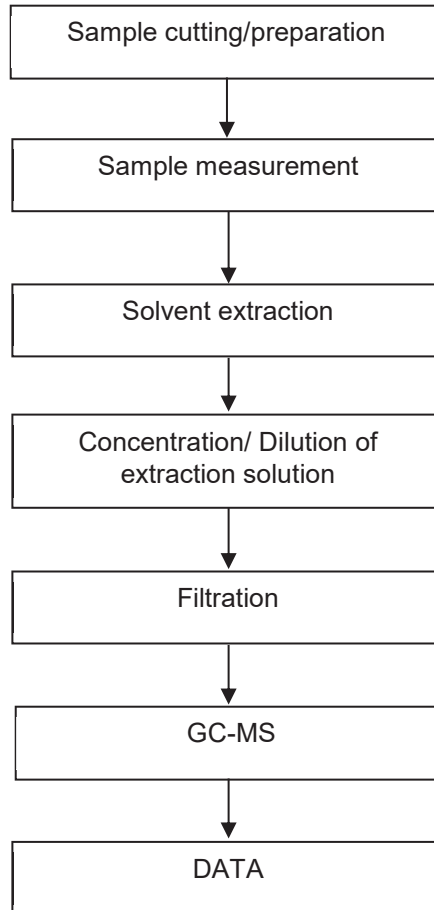

SGS-CSST (Shanghai) Inspection & Testing Services Co., Ltd.
Testing Center - Chemicals

Unless otherwise agreed in writing, this document is issued by the Company subject to its General Conditions of Service printed overleaf, available on request or accessible at <http://www.sgs.com/en/Terms-and-Conditions.aspx> and, for electronic format documents, subject to Terms and Conditions for Electronic Documents at <http://www.sgs.com/en/Terms-and-Conditions/Terms-e-Documents.aspx>. Attention is drawn to the limitation of liability, indemnification and jurisdiction issues defined therein. Any holder of this document is advised that information contained hereon reflects the Company's findings at the time of its intervention only and within the limits of Client's instructions, if any. The Company's sole responsibility is to its Client and this document does not exonerate parties to a transaction from exercising all their rights and obligations under the transaction documents. This document cannot be reproduced except in full, without prior written approval of the Company. Any unauthorized alteration, forgery or falsification of the content or appearance of this document is unlawful and offenders may be prosecuted to the fullest extent of the law. Unless otherwise stated the results shown in this test report refer only to the sample(s) tested.

Attention: To check the authenticity of testing / inspection report & certificate, please contact us at telephone: (86-755) 8307 1443, or email: CN.Doccheck@sgs.com

3rd Building, No.889 Yishan Road Xuhui District, Shanghai China 200233 t E&E (86-21) 61402553 f E&E (86-21) 64953679 www.sgs.com.cn
中国·上海·徐汇区宜山路889号3号楼 邮编: 200233 t HL (86-21) 61402594 f HL (86-21) 61156899 e sgs.china@sgs.com

Phthalates Testing Flow Chart

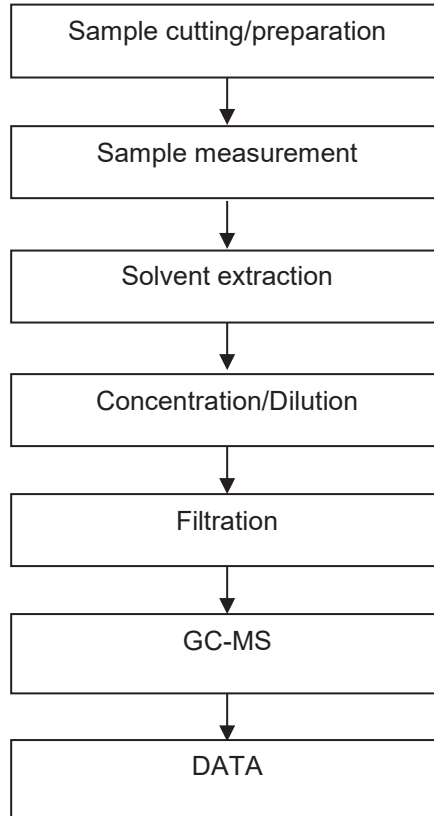

Unless otherwise agreed in writing, this document is issued by the Company subject to its General Conditions of Service printed overleaf, available on request or accessible at <http://www.sgs.com/en/Terms-and-Conditions.aspx> and, for electronic format documents, subject to Terms and Conditions for Electronic Documents at <http://www.sgs.com/en/Terms-and-Conditions/Terms-e-Documents.aspx>. Attention is drawn to the limitation of liability, indemnification and jurisdiction issues defined therein. Any holder of this document is advised that information contained hereon reflects the Company's findings at the time of its intervention only and within the limits of Client's instructions, if any. The Company's sole responsibility is to its Client and this document does not exonerate parties to a transaction from exercising all their rights and obligations under the transaction documents. This document cannot be reproduced except in full, without prior written approval of the Company. Any unauthorized alteration, forgery or falsification of the content or appearance of this document is unlawful and offenders may be prosecuted to the fullest extent of the law. Unless otherwise stated the results shown in this test report refer only to the sample(s) tested.

Attention: To check the authenticity of testing / inspection report & certificate, please contact us at telephone: (86-755) 8307 1443, or email: CN.Doccheck@sgs.com

Plating Element Testing Flow Chart

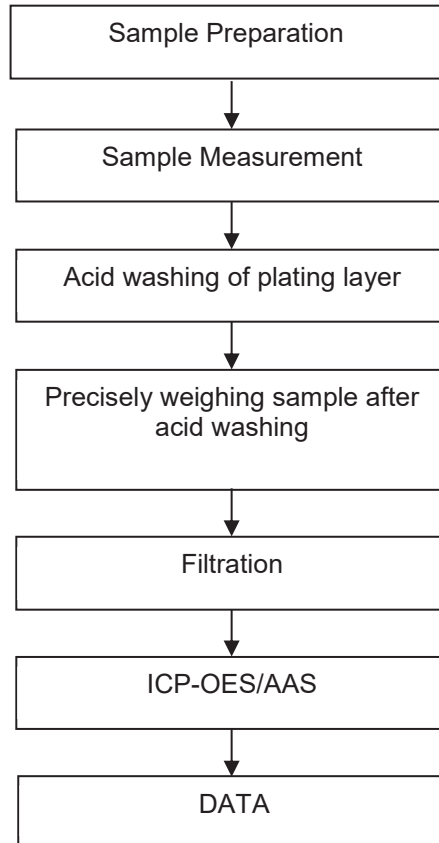

SGS-CSST (Shanghai) Technical Services Co., Ltd.
Testing Center - Chemical Laboratory

Unless otherwise agreed in writing, this document is issued by the Company subject to its General Conditions of Service printed overleaf, available on request or accessible at <http://www.sgs.com/en/Terms-and-Conditions.aspx> and, for electronic format documents, subject to Terms and Conditions for Electronic Documents at <http://www.sgs.com/en/Terms-and-Conditions/Terms-e-Documents.aspx>. Attention is drawn to the limitation of liability, indemnification and jurisdiction issues defined therein. Any holder of this document is advised that information contained hereon reflects the Company's findings at the time of its intervention only and within the limits of Client's instructions, if any. The Company's sole responsibility is to its Client and this document does not exonerate parties to a transaction from exercising all their rights and obligations under the transaction documents. This document cannot be reproduced except in full, without prior written approval of the Company. Any unauthorized alteration, forgery or falsification of the content or appearance of this document is unlawful and offenders may be prosecuted to the fullest extent of the law. Unless otherwise stated the results shown in this test report refer only to the sample(s) tested.

Attention: To check the authenticity of testing / inspection report & certificate, please contact us at telephone: (86-755) 8307 1443, or email: CN.Doccheck@sgs.com

3rd Building, No. 889 Yishan Road Xuhui District, Shanghai China 200233 t E&E (86-21) 61402553 f E&E (86-21) 64953679 www.sgs.com.cn
中国·上海·徐汇区宜山路889号3号楼 邮编: 200233 t HL (86-21) 61402594 f HL (86-21) 61156899 e sgs.china@sgs.com

Elements Testing Flow Chart

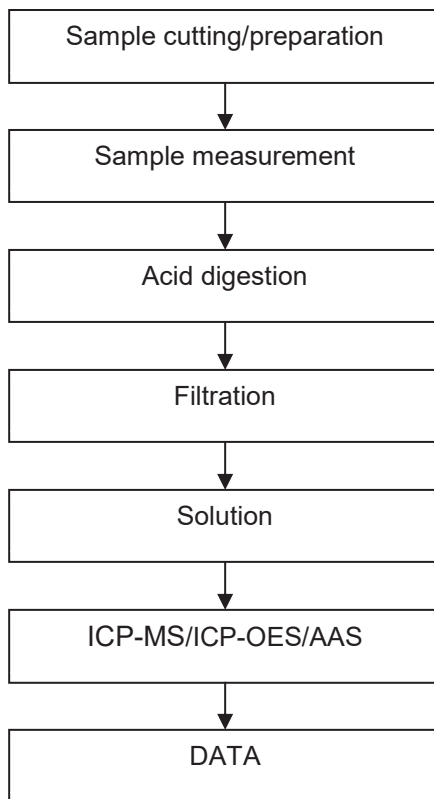

Unless otherwise agreed in writing, this document is issued by the Company subject to its General Conditions of Service printed overleaf, available on request or accessible at <http://www.sgs.com/en/Terms-and-Conditions.aspx> and, for electronic format documents, subject to Terms and Conditions for Electronic Documents at <http://www.sgs.com/en/Terms-and-Conditions/Terms-e-Documents.aspx>. Attention is drawn to the limitation of liability, indemnification and jurisdiction issues defined therein. Any holder of this document is advised that information contained hereon reflects the Company's findings at the time of its intervention only and within the limits of Client's instructions, if any. The Company's sole responsibility is to its Client and this document does not exonerate parties to a transaction from exercising all their rights and obligations under the transaction documents. This document cannot be reproduced except in full, without prior written approval of the Company. Any unauthorized alteration, forgery or falsification of the content or appearance of this document is unlawful and offenders may be prosecuted to the fullest extent of the law. Unless otherwise stated the results shown in this test report refer only to the sample(s) tested.

Attention: To check the authenticity of testing / inspection report & certificate, please contact us at telephone: (86-755) 8307 1443, or email: CN.Doccheck@sgs.com

SGS-CSTC Shanghai Technical Services (Shanghai) Co., Ltd.
Testing Center-Chemical Laboratory

3rd Building, No.889 Yishan Road Xuhui District, Shanghai China 200233 t E&E (86-21) 61402553 f E&E (86-21) 64953679 www.sgs.com.cn
中国·上海·徐汇区宜山路889号3号楼 邮编: 200233 t HL (86-21) 61402594 f HL (86-21) 61156899 e sgs.china@sgs.com

PFASs/ PFOS/PFOA Testing Flow Chart

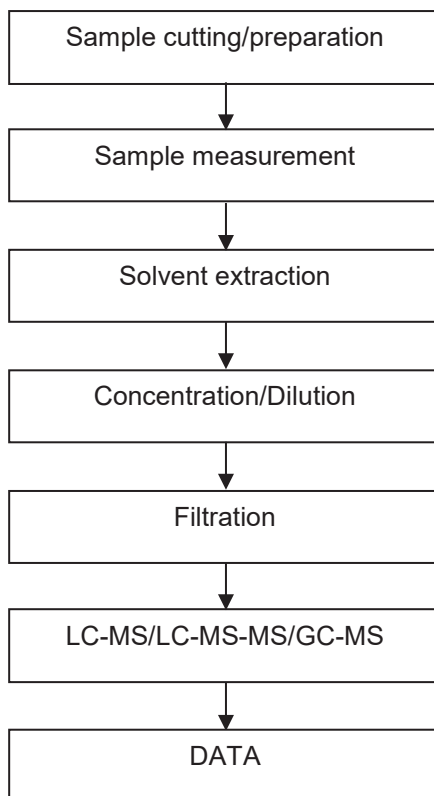

Unless otherwise agreed in writing, this document is issued by the Company subject to its General Conditions of Service printed overleaf, available on request or accessible at <http://www.sgs.com/en/Terms-and-Conditions.aspx> and, for electronic format documents, subject to Terms and Conditions for Electronic Documents at <http://www.sgs.com/en/Terms-and-Conditions/Terms-e-Documents.aspx>. Attention is drawn to the limitation of liability, indemnification and jurisdiction issues defined therein. Any holder of this document is advised that information contained hereon reflects the Company's findings at the time of its intervention only and within the limits of Client's instructions, if any. The Company's sole responsibility is to its Client and this document does not exonerate parties to a transaction from exercising all their rights and obligations under the transaction documents. This document cannot be reproduced except in full, without prior written approval of the Company. Any unauthorized alteration, forgery or falsification of the content or appearance of this document is unlawful and offenders may be prosecuted to the fullest extent of the law. Unless otherwise stated the results shown in this test report refer only to the sample(s) tested.

Attention: To check the authenticity of testing / inspection report & certificate, please contact us at telephone: (86-755) 8307 1443, or email: CN.Doccheck@sgs.com

SGS-CSTC (Shanghai) Inspection & Testing Services Co., Ltd.
Testing Center-Chemical Laboratory

3rd Building, No. 889 Yishan Road Xuhui District, Shanghai China 200233 t E&E (86-21) 61402553 f E&E (86-21) 64953679 www.sgs.com.cn
中国·上海·徐汇区宜山路889号3号楼 邮编: 200233 t HL (86-21) 61402594 f HL (86-21) 61156899 e sgs.china@sgs.com

Test Report

No.: SHAEC23019069713

Date: Dec 04, 2023

Page 12 of 13

Sample Photo:



Unless otherwise agreed in writing, this document is issued by the Company subject to its General Conditions of Service printed overleaf, available on request or accessible at <http://www.sgs.com/en/Terms-and-Conditions.aspx> and, for electronic format documents, subject to Terms and Conditions for Electronic Documents at <http://www.sgs.com/en/Terms-and-Conditions/Terms-e-Documents.aspx>. Attention is drawn to the limitation of liability, indemnification and jurisdiction issues defined therein. Any holder of this document is advised that information contained hereon reflects the Company's findings at the time of its intervention only and within the limits of Client's instructions, if any. The Company's sole responsibility is to its Client and this document does not exonerate parties to a transaction from exercising all their rights and obligations under the transaction documents. This document cannot be reproduced except in full, without prior written approval of the Company. Any unauthorized alteration, forgery or falsification of the content or appearance of this document is unlawful and offenders may be prosecuted to the fullest extent of the law. Unless otherwise stated the results shown in this test report refer only to the sample(s) tested.

Attention: To check the authenticity of testing / inspection report & certificate, please contact us at telephone: (86-755) 8307 1443, or email: CN.Doccheck@sgs.com

SGS-CSTC (Shanghai) Technical Services (Shanghai) Co., Ltd.
 Testing Center - Chemicals

3rd Building, No.889 Yishan Road Xuhui District, Shanghai China 200233 t E&E (86-21) 61402553 f E&E (86-21) 64953679 www.sgsgroup.com.cn
 中国·上海·徐汇区宜山路889号3号楼 邮编: 200233 t HL (86-21) 61402594 f HL (86-21) 61156899 e sgs.china@sgs.com



SGS authenticate the photo on original report only
 *** End of Report ***



Unless otherwise agreed in writing, this document is issued by the Company subject to its General Conditions of Service printed overleaf, available on request or accessible at <http://www.sgs.com/en/Terms-and-Conditions.aspx> and, for electronic format documents, subject to Terms and Conditions for Electronic Documents at <http://www.sgs.com/en/Terms-and-Conditions/Terms-e-Documents.aspx>. Attention is drawn to the limitation of liability, indemnification and jurisdiction issues defined therein. Any holder of this document is advised that information contained hereon reflects the Company's findings at the time of its intervention only and within the limits of Client's instructions, if any. The Company's sole responsibility is to its Client and this document does not exonerate parties to a transaction from exercising all their rights and obligations under the transaction documents. This document cannot be reproduced except in full, without prior written approval of the Company. Any unauthorized alteration, forgery or falsification of the content or appearance of this document is unlawful and offenders may be prosecuted to the fullest extent of the law. Unless otherwise stated the results shown in this test report refer only to the sample(s) tested.

Attention: To check the authenticity of testing / inspection report & certificate, please contact us at telephone: (86-755) 8307 1443, or email: CN.Doccheck@sgs.com

SGS-CSTC (Shanghai) Technical Services (Shanghai) Co., Ltd. 3rd Building, No.889 Yishan Road Xuhui District, Shanghai China 200233 t E&E (86-21) 61402553 f E&E (86-21) 64953679 www.sgsgroup.com.cn
 中国·上海·徐汇区宜山路889号3号楼 邮编: 200233 t HL (86-21) 61402594 f HL (86-21) 61156899 e sgs.china@sgs.com