

# FCC Radio Test Report

## FCC ID: I4L-8ZA4

This report concerns: Original Grant

**Project No.** : 2206E025  
**Equipment** : Wireless Keyboard  
**Brand Name** : msi  
**Test Model** : 8ZA4  
**Series Model** : N/A  
**Applicant** : Micro-Star Int'l Co.,Ltd.  
**Address** : No.69, Lide St., Zhonghe Dist.,New Taipei City 235, Taiwan  
**Manufacturer** : Dong Guan You Hong Plastic & Electric Co.,Ltd  
**Address** : Zhen Hua Road, Tie Lu Keng Village,Qi Shi Town,DongGuan city  
**Factory** : Dong Guan You Hong Plastic & Electric Co.,Ltd  
**Address** : Zhen Hua Road, Tie Lu Keng Village,Qi Shi Town,DongGuan city  
**Date of Receipt** : Jun. 27, 2022  
**Date of Test** : Jun. 28, 2022 ~ Jul. 07, 2022  
**Issued Date** : Aug. 09, 2022  
**Report Version** : R01  
**Test Sample** : Engineering Sample No.: DG2022062788 for radiated & AC Power Line  
Conducted Emissions, DG2022062789 for conducted.  
**Standard(s)** : FCC CFR Title 47, Part 15, Subpart C  
ANSI C63.10-2013

The above equipment has been tested and found compliance with the requirement of the relative standards by BTL Inc.

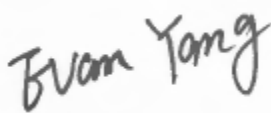

Prepared by : Evan Yang

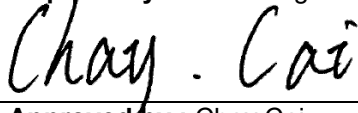

Approved by : Chay Cai



TESTING CERT #5123.02

### BTL Inc.

No. 3 Jinshagang 1st Rd. Shixia, Dalang Town Dongguan City, Guangdong 523792 People's Republic of China.

Tel: +86-769-8318-3000

Web: [www.newbtl.com](http://www.newbtl.com)

Service mail: [btl\\_qa@newbtl.com](mailto:btl_qa@newbtl.com)

**Declaration**

**BTL** represents to the client that testing is done in accordance with standard procedures as applicable and that test instruments used has been calibrated with standards traceable to international standard(s) and/or national standard(s).

**BTL's** reports apply only to the specific samples tested under conditions. It is manufacture's responsibility to ensure that additional production units of this model are manufactured with the identical electrical and mechanical components. **BTL** shall have no liability for any declarations, inferences or generalizations drawn by the client or others from **BTL** issued reports.

The report must not be used by the client to claim product certification, approval, or endorsement by NVLAP, NIST, A2LA, or any agency of the U.S. Government.

This report is the confidential property of the client. As a mutual protection to the clients, the public and ourselves, the test report shall not be reproduced, except in full, without our written approval.

**BTL's** laboratory quality assurance procedures are in compliance with the **ISO/IEC 17025** requirements, and accredited by the conformity assessment authorities listed in this test report.

**BTL** is not responsible for the sampling stage, so the results only apply to the sample as received.

The information, data and test plan are provided by manufacturer which may affect the validity of results, so it is manufacturer's responsibility to ensure that the apparatus meets the essential requirements of applied standards and in all the possible configurations as representative of its intended use.

**Limitation**

For the use of the authority's logo is limited unless the Test Standard(s)/Scope(s)/Item(s) mentioned in this test report is (are) included in the conformity assessment authorities acceptance respective.

Please note that the measurement uncertainty is provided for informational purpose only and are not use in determining the Pass/Fail results.

<b>Table of Contents</b>	<b>Page</b>
<b>REPORT ISSUED HISTORY</b>	<b>5</b>
<b>1 . SUMMARY OF TEST RESULTS</b>	<b>6</b>
1.1 TEST FACILITY	7
1.2 MEASUREMENT UNCERTAINTY	7
1.3 TEST ENVIRONMENT CONDITIONS	8
<b>2 . GENERAL INFORMATION</b>	<b>9</b>
2.1 GENERAL DESCRIPTION OF EUT	9
2.2 DESCRIPTION OF TEST MODES	10
2.3 PARAMETERS OF TEST SOFTWARE	10
2.4 BLOCK DIAGRAM SHOWING THE CONFIGURATION OF SYSTEM TESTED	11
2.5 SUPPORT UNITS	12
<b>3 . AC POWER LINE CONDUCTED EMISSIONS</b>	<b>13</b>
3.1 LIMIT	13
3.2 TEST PROCEDURE	13
3.3 DEVIATION FROM TEST STANDARD	13
3.4 TEST SETUP	14
3.5 EUT OPERATING CONDITIONS	14
3.6 TEST RESULTS	14
<b>4 . RADIATED EMISSION TEST</b>	<b>15</b>
4.1 LIMIT	15
4.2 TEST PROCEDURE	16
4.3 DEVIATION FROM TEST STANDARD	17
4.4 TEST SETUP	17
4.5 EUT OPERATING CONDITIONS	18
4.6 TEST RESULT - 9 KHZ TO 30 MHZ	18
4.7 TEST RESULT - 30 MHZ TO 1000 MHZ	18
4.8 TEST RESULT - ABOVE 1000 MHZ	18
<b>5 . BANDWIDTH TEST</b>	<b>19</b>
5.1 LIMIT	19
5.2 TEST PROCEDURE	19
5.3 DEVIATION FROM STANDARD	19
5.4 TEST SETUP	19
5.5 EUT OPERATION CONDITIONS	19

**Table of Contents****Page**

<b>5.6 TEST RESULTS</b>	<b>19</b>
<b>6 . MEASUREMENT INSTRUMENTS LIST</b>	<b>20</b>
<b>7 . EUT TEST PHOTO</b>	<b>22</b>
<b>APPENDIX A - AC POWER LINE CONDUCTED EMISSIONS</b>	<b>26</b>
<b>APPENDIX B - RADIATED EMISSION - 9 KHZ TO 30 MHZ</b>	<b>29</b>
<b>APPENDIX C - RADIATED EMISSION - 30 MHZ TO 1000 MHZ</b>	<b>34</b>
<b>APPENDIX D - RADIATED EMISSION - ABOVE 1000 MHZ</b>	<b>37</b>
<b>APPENDIX E - BANDWIDTH</b>	<b>50</b>

**REPORT ISSUED HISTORY**

Report No.	Version	Description	Issued Date	Note
BTL-FCCP-1-2206E025	R00	Original Report.	Aug. 04, 2022	Invalid
BTL-FCCP-1-2206E025	R01	Revised report to address comments.	Aug. 09, 2022	Valid

**1. SUMMARY OF TEST RESULTS**

Test procedures according to the technical standard(s):

<b>FCC CFR Title 47, Part 15, Subpart C</b>				
<b>Standard(s) Section</b>	<b>Test Item</b>	<b>Test Result</b>	<b>Judgment</b>	<b>Remark</b>
15.207(a)	AC Power Line Conducted Emissions	APPENDIX A	PASS	-----
15.209 15.249(a)	Radiated Emissions	APPENDIX B APPENDIX C APPENDIX D	PASS	-----
15.215(c)	Bandwidth	APPENDIX E	PASS	-----
15.203	Antenna Requirement	-----	PASS	Note(2)

Note:

- (1) "N/A" denotes test is not applicable to this device.
- (2) The device what use a permanently attached antenna were considered sufficient to comply with the provisions of 15.203.

## 1.1 TEST FACILITY

The test facilities used to collect the test data in this report is at the location of No. 3 Jinshagang 1st Rd. Shixia, Dalang Town Dongguan City, Guangdong 523792 People's Republic of China.

BTL's Registration Number for FCC: 357015

BTL's Designation Number for FCC: CN1240

## 1.2 MEASUREMENT UNCERTAINTY

ISO/IEC 17025 requires that an estimate of the measurement uncertainties associated with the emissions test results be included in the report. The measurement uncertainties given below are based on a 95% confidence level (based on a coverage factor (k=2))

The BTL measurement uncertainty as below table:

### A. AC power line conducted emissions test:

Test Site	Method	Measurement Frequency Range	U,(dB)
DG-C02	CISPR	150kHz ~ 30MHz	2.60

### B. Radiated emissions test:

Test Site	Method	Measurement Frequency Range	U,(dB)
DG-CB01	CISPR	9kHz ~ 30MHz	2.36

Test Site	Method	Measurement Frequency Range	Ant. H / V	U,(dB)
DG-CB03 (3m)	CISPR	30MHz ~ 200MHz	V	4.36
		30MHz ~ 200MHz	H	3.32
		200MHz ~ 1,000MHz	V	4.08
		200MHz ~ 1,000MHz	H	3.96

Test Site	Method	Measurement Frequency Range	U,(dB)
DG-CB03 (3m)	CISPR	1GHz ~ 6GHz	3.80
		6GHz ~ 18GHz	4.82

Test Site	Method	Measurement Frequency Range	U,(dB)
DG-CB03 (1m)	CISPR	18 ~ 26.5 GHz	3.62
		26.5 ~ 40 GHz	4.00

### C. Other Measurement:

Test Item	Uncertainty
Bandwidth	±3.8 %
Temperature	±0.08 °C
Humidity	±1.5%

Note: Unless specifically mentioned, the uncertainty of measurement has not been taken into account to declare the compliance or non-compliance to the specification.

**1.3 TEST ENVIRONMENT CONDITIONS**

Test Item	Temperature	Humidity	Test Voltage	Tested By
AC Power Line Conducted Emissions	25°C	55%	AC 120V/60Hz	Jeter Wang
Radiated Emissions-9 kHz to 30 MHz	24°C	59%	DC 5V	Albe Zhou
Radiated Emissions-30 MHz to 1000 MHz	25°C	50%	DC 5V	Chen Mo
Radiated Emissions-Above 1000 MHz	26°C	62%	DC 3.7V	Chen Mo
Bandwidth	24°C	58%	DC 3.7V	Nicole Chen



## 2. GENERAL INFORMATION

### 2.1 GENERAL DESCRIPTION OF EUT

Equipment	Wireless Keyboard
Brand Name	msi
Test Model	8ZA4
Series Model	N/A
Model Difference(s)	N/A
Power Source	1# Supplied from USB port. 2# Battery supplied. Model: DTP502035
Power Rating	1# DC 5V $\overline{=}$ 0.5A 2# 3.7V 300mAh 1.11Wh
Operation Frequency	2403.85 ~ 2479.85MHz
Modulation Technology	GFSK
Bit Rate of Transmitter	2Mbps
Max. Field Strength	47.81 dBuV/m(AVG) 86.81 dBuV/m(Peak)
Max. Output Power	-47.49 dBm (0.00000002W) (AVG) -8.49 dBm (0.00014W) (Peak)

Note:

- For a more detailed features description, please refer to the manufacturer's specifications or the user's manual.
- The Max. Field Strength of 95.30(dBuV/m) corresponds to a power of 0(dBm), so the Max. Output Power is Max.Field Strength-95.30.

#### 3. Channel List:

Channel	Frequency (MHz)	Channel	Frequency (MHz)	Channel	Frequency (MHz)
01	2403.85	07	2436.85	13	2463.85
02	2407.85	08	2439.85	14	2466.85
03	2414.85	09	2441.85	15	2473.85
04	2419.85	10	2445.85	16	2479.85
05	2422.85	11	2453.85		
06	2426.85	12	2459.85		

#### 4. Table for Filed Antenna:

Ant.	Brand	Model Name	Antenna Type	Connector	Gain (dBi)
1	msi	IBM2.4GHz	PCB	N/A	2.75

Note: The antenna gain is provided by the manufacturer.

## 2.2 DESCRIPTION OF TEST MODES

The test system was pre-tested based on the consideration of all possible combinations of EUT operation mode.

Pretest Mode	Description
Mode 1	TX Mode Channel 01/09/16
Mode 2	TX Mode Channel 16

Following mode(s) was (were) found to be the worst case(s) and selected for the final test.

AC Power Line Conducted Emissions	
Final Test Mode	Description
Mode 2	TX Mode Channel 16

Radiated emissions test - Below 1GHz	
Final Test Mode	Description
Mode 2	TX Mode Channel 16

Radiated emissions test - Above 1GHz	
Final Test Mode	Description
Mode 1	TX Mode Channel 01/09/16

Bandwidth test	
Final Test Mode	Description
Mode 1	TX Mode Channel 01/09/16

Note:

- (1) For AC Power Line Conducted Emissions and Radiated Emission Below 1GHz test, the TX Mode Channel 16 was found to be the worst case and recorded.

## 2.3 PARAMETERS OF TEST SOFTWARE

During testing, channel & power controlling software provided by the customer was used to control the operating channel as well as the output power level.

Test Software Version	N/A		
Frequency (MHz)	2403.85	2441.85	2479.85
2Mbps	N/A	N/A	N/A

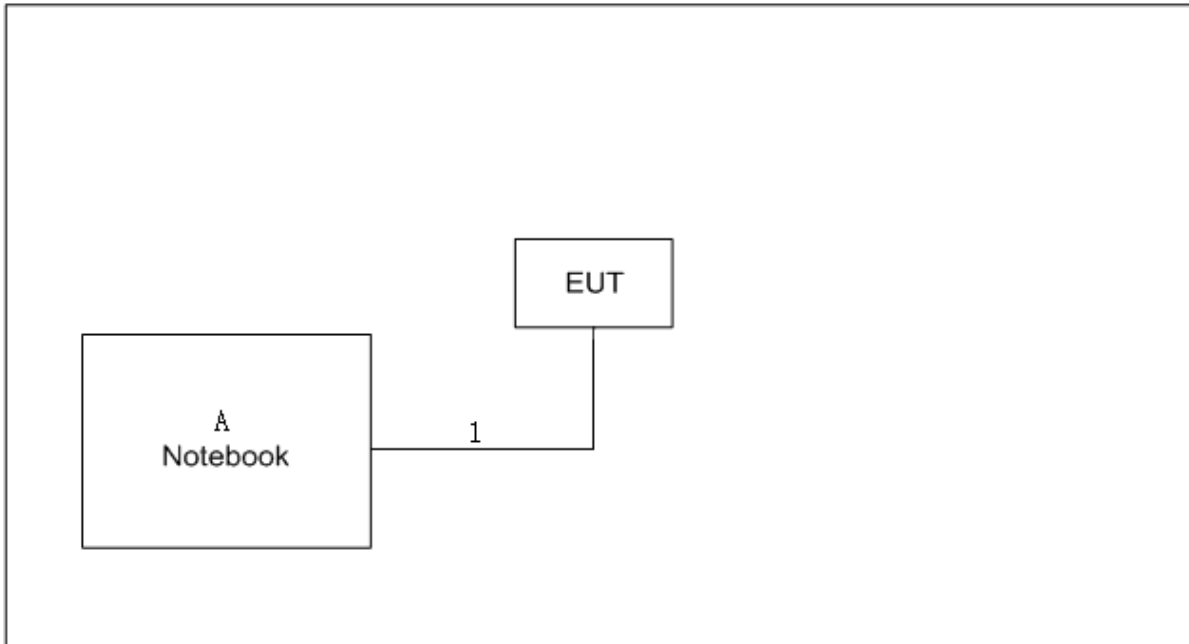
**2.4 BLOCK DIAGRAM SHOWING THE CONFIGURATION OF SYSTEM TESTED****AC Power Line Conducted Emissions and Radiated emissions test - Below 1GHz****Radiated emissions test - Above 1GHz**

## 2.5 SUPPORT UNITS

The EUT has been tested as an independent unit together with other necessary accessories or support units. The following support units or accessories were used to form a representative test configuration during the tests.

### AC Power Line Conducted Emissions and Radiated emissions test - Below 1GHz

Item	Equipment	Brand	Model No.	Series No.	Note
A	Notebook	Lenovo	V310-14ISK	LR07GZNB	AC Power Line Conducted Emissions
	Notebook	Lenovo	G50-30	PF0BRC8R	Radiated emissions test - 9kHz to 30MHz
	Notebook	Honor	14SER5 3500	N/A	Radiated emissions test - 30MHz to 1000MHz

Item	Cable Type	Shielded Type	Ferrite Core	Length
1	USB Cable	NO	NO	1.0m

### Radiated emissions test - Above 1GHz

Item	Equipment	Brand	Model No.	Series No.
-	-	-	-	-

Item	Cable Type	Shielded Type	Ferrite Core	Length
-	-	-	-	-

### 3. AC POWER LINE CONDUCTED EMISSIONS

#### 3.1 LIMIT

Frequency of Emission (MHz)	Limit (dB $\mu$ V)	
	Quasi-peak	Average
0.15 - 0.5	66 to 56*	56 to 46*
0.5 - 5.0	56	46
5.0 - 30.0	60	50

Note:

- (1) The tighter limit applies at the band edges.
- (2) The limit of " \* " marked band means the limitation decreases linearly with the logarithm of the frequency in the range.

#### 3.2 TEST PROCEDURE

- a. The EUT was placed 0.8 meters from the horizontal ground plane with EUT being connected to the power mains through a line impedance stabilization network (LISN). All other support equipment powered from additional LISN(s). The LISN provide 50 Ohm/ 50uH of coupling impedance for the measuring instrument.
- b. Interconnecting cables that hang closer than 40 cm to the ground plane shall be folded back and forth in the center forming a bundle 30 to 40 cm long.
- c. I/O cables that are not connected to a peripheral shall be bundled in the center. The end of the cable may be terminated, if required, using the correct terminating impedance. The overall length shall not exceed 1 m.
- d. LISN at least 80 cm from nearest part of EUT chassis.
- e. For the actual test configuration, please refer to the related Item –EUT Test Photos.

The following table is the setting of the receiver:

Receiver Parameters	Setting
Start Frequency	0.15 MHz
Stop Frequency	30 MHz
IF Bandwidth	9 kHz

#### 3.3 DEVIATION FROM TEST STANDARD

No deviation.

### 3.4 TEST SETUP

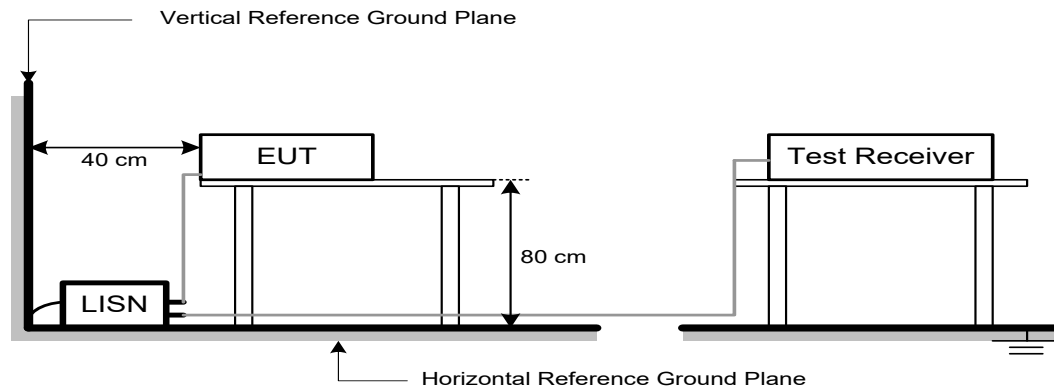

### 3.5 EUT OPERATING CONDITIONS

The EUT was configured for testing in a typical function (as a customer would normally use it), EUT was programmed to be in continuously transmitting data or hopping on mode.

### 3.6 TEST RESULTS

Please refer to the APPENDIX A.

Remark:

- (1) All readings are QP Mode value unless otherwise stated AVG in column of [Note] . If the QP Mode Measured value compliance with the QP Limits and lower than AVG Limits, the EUT shall be deemed to meet both QP & AVG Limits and then only QP Mode was measured, but AVG Mode didn't perform in this case, a "\*" marked in AVG Mode column of Interference Voltage Measured.
- (2) Measuring frequency range from 150 kHz to 30 MHz.

#### 4. RADIATED EMISSION TEST

##### 4.1 LIMIT

###### LIMITS OF RADIATED EMISSION MEASUREMENT (9 kHz-1000 MHz)

Frequency (MHz)	Field Strength (microvolts/meter)	Measurement Distance (meters)
0.009-0.490	2400/F(kHz)	300
0.490-1.705	24000/F(kHz)	30
1.705-30.0	30	30
30-88	100	3
88-216	150	3
216-960	200	3
Above 960	500	3

###### LIMITS OF RADIATED EMISSION MEASUREMENT (Above 1000 MHz)

Frequency (MHz)	(dBuV/m at 3 m)	
	Peak	Average
Above 1000	74	54

###### LIMITS OF FIELD STRENGTH OF FUNDAMENTAL

Frequency (MHz)	(dBuV/m at 3 m)	
	Peak	Average
2403.85 to 2479.85	114	94

Note:

- (1) The limit for radiated test was performed according to FCC CFR Title 47, Part 15, Subpart C.
- (2) Emissions radiated outside of the specified frequency bands, except for harmonics, shall be attenuated by at least 50 dB below the level of the fundamental or to the general radiated emission limits in 15.209, whichever is the lesser attenuation.
- (3) Emission level (dBuV/m)=20log Emission level (uV/m).

#### 4.2 TEST PROCEDURE

- a. The measuring distance of 3 m shall be used for measurements. The EUT was placed on the top of a rotating table 0.8 meter above the ground at a 3 meter semi-anechoic chamber. The table was rotated 360 degrees to determine the position of the highest radiation.(below 1 GHz)
- b. The measuring distance of 3 m shall be used for measurements. The EUT was placed on the top of a rotating table 1.5 meter above the ground at a 3 meter semi-anechoic chamber. The table was rotated 360 degrees to determine the position of the highest radiation.(above 1 GHz)
- c. The height of the equipment or of the substitution antenna shall be 0.8m or 1.5m; the height of the test antenna shall vary between 1 m to 4 m. Both horizontal and vertical polarizations of the antenna are set to make the measurement.
- d. For each suspected emission, the EUT was arranged to its worst case and then the antenna was tuned to heights find the maximum reading (used Bore sight function).
- e. The receiver system was set to peak and average detect function and specified bandwidth with maximum hold mode when the test frequency is above 1 GHz.
- f. The initial step in collecting radiated emission data is a receiver peak detector mode pre-scanning the measurement frequency range. Significant peaks are then marked and then Quasi Peak detector mode re-measured.
- g. All readings are Peak unless otherwise stated QP in column of Note. Peak denotes that the Peak reading compliance with the QP Limits and then QP Mode measurement didn't perform. (below 1 GHz)
- h. All readings are Peak Mode value unless otherwise stated AVG in column of Note. If the Peak Mode Measured value compliance with the Peak Limits and lower than AVG Limits, the EUT shall be deemed to meet both Peak & AVG Limits and then only Peak Mode was measured, but AVG Mode didn't perform. (above 1 GHz)
- i. For the actual test configuration, please refer to the related Item –EUT Test Photos.

The following table is the setting of the receiver:

Spectrum Parameters	Setting
Start ~ Stop Frequency	9 kHz~150 kHz for RBW 200 Hz
Start ~ Stop Frequency	0.15 MHz~30 MHz for RBW 9 kHz
Start ~ Stop Frequency	30 MHz~1000 MHz for RBW 100 kHz

Spectrum Parameters	Setting
Start Frequency	1000 MHz
Stop Frequency	10th carrier harmonic
RBW / VBW (Emission in restricted band)	1 MHz / 3 MHz for PK value 1 MHz / 1/T Hz for AVG value

Spectrum Parameters	Setting
Start ~ Stop Frequency	9 kHz~90 kHz for PK/AVG detector
Start ~ Stop Frequency	90 kHz~110 kHz for QP detector
Start ~ Stop Frequency	110 kHz~490 kHz for PK/AVG detector
Start ~ Stop Frequency	490 kHz~30 MHz for QP detector
Start ~ Stop Frequency	30 MHz~1000 MHz for QP detector
Start ~ Stop Frequency	Above 1GHz for PK/AVG detector



### 4.3 DEVIATION FROM TEST STANDARD

No deviation

### 4.4 TEST SETUP

9 kHz-30 MHz

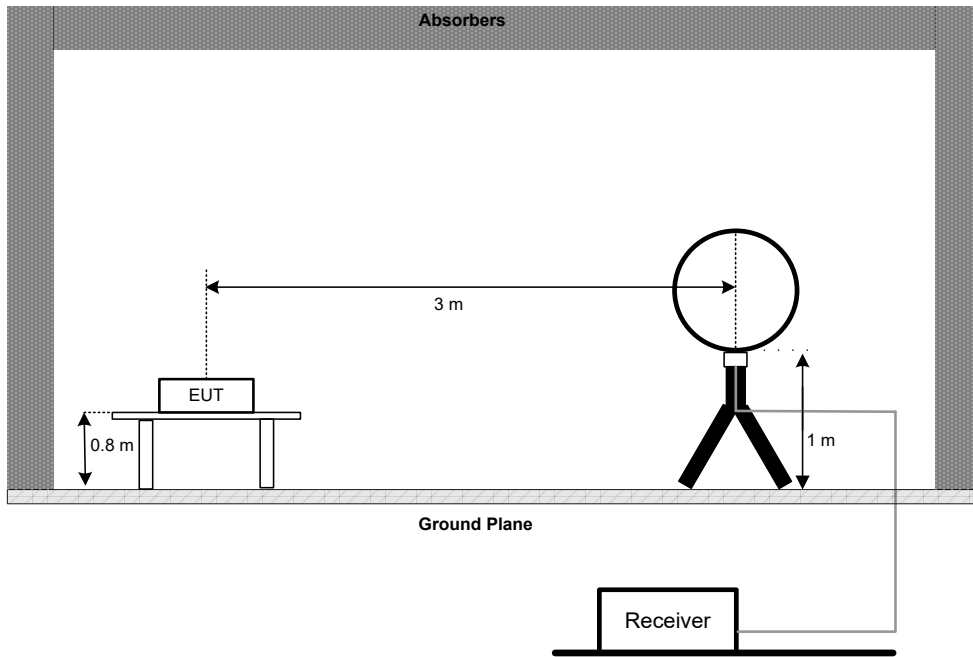

30 MHz to 1 GHz

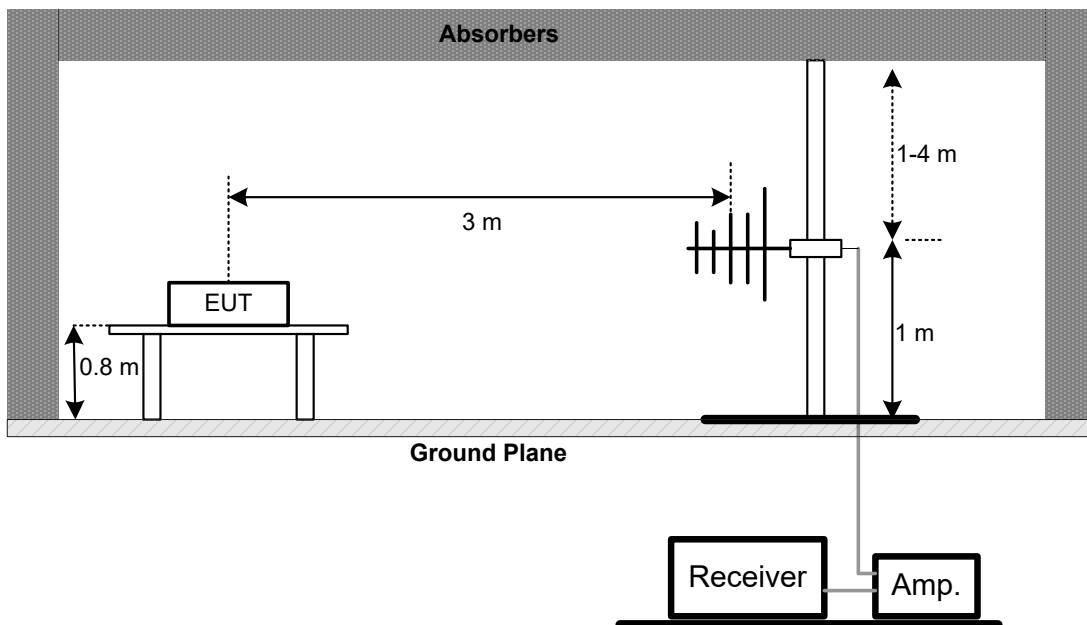

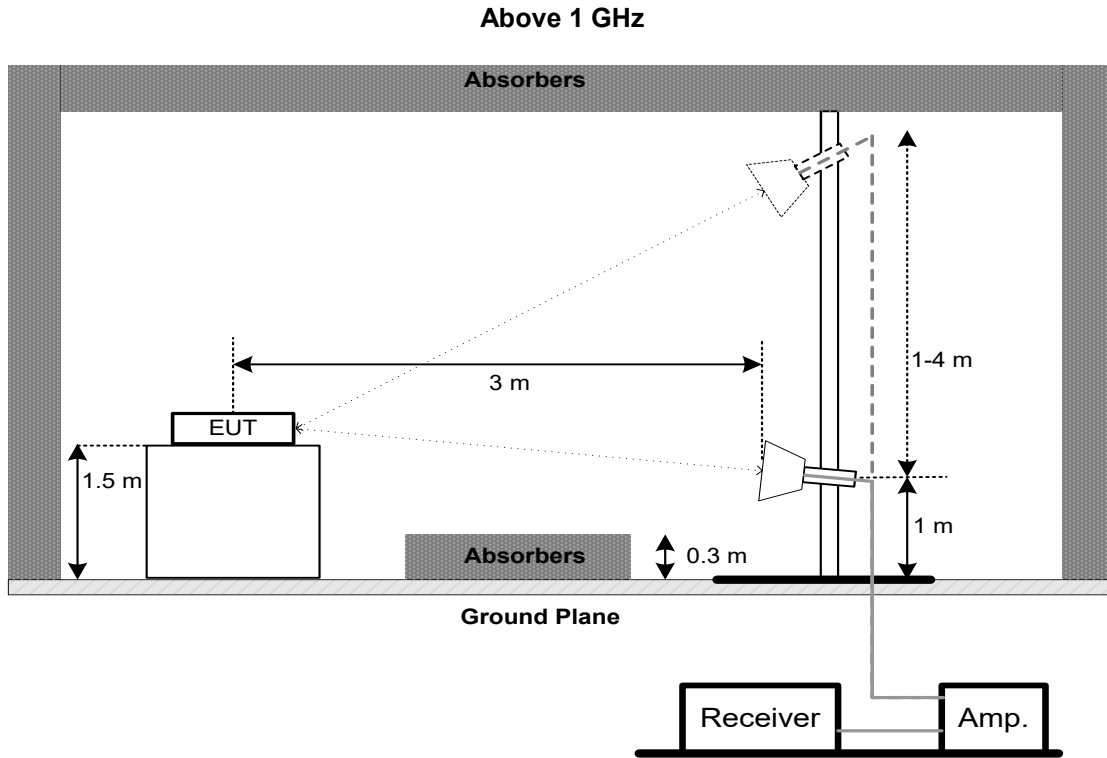

**4.5 EUT OPERATING CONDITIONS**

The EUT was programmed to be in continuously transmitting mode.

**4.6 TEST RESULT - 9 kHz TO 30 MHz**

Please refer to the APPENDIX B.

Remark:

- (1) Distance extrapolation factor =  $40 \log(\text{specific distance} / \text{test distance})$  (dB).
- (2) Limit line = specific limits (dBuV) + distance extrapolation factor.

**4.7 TEST RESULT - 30 MHz TO 1000 MHz**

Please refer to the APPENDIX C.

**4.8 TEST RESULT - ABOVE 1000 MHz**

Please refer to the APPENDIX D.

Remark:

- (1) No limit: This is fundamental signal, the judgment is not applicable. For fundamental signal judgment was referred to Peak output test.

**5. BANDWIDTH TEST**

**5.1 LIMIT**

Section	Test Item	Limit
15.215(c)	20 dB Bandwidth	-

**5.2 TEST PROCEDURE**

- a. The EUT was directly connected to the spectrum analyzer and antenna output port as show in the block diagram below.
- b. The following table is the setting of the spectrum analyzer.

Spectrum Parameters	Setting
Span Frequency	Between 2 times and 5 times the BW
RBW	Range of 1% to 5% of the BW
VBW	Approximately 3 times RBW
Detector	Peak
Trace	Max Hold
Sweep Time	Auto

**5.3 DEVIATION FROM STANDARD**

No deviation.

**5.4 TEST SETUP**

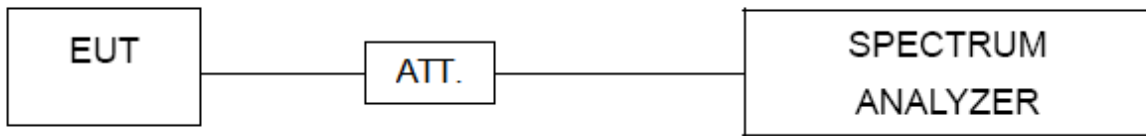

**5.5 EUT OPERATION CONDITIONS**

The EUT was programmed to be in continuously transmitting mode.

**5.6 TEST RESULTS**

Please refer to the APPENDIX E.

**6. MEASUREMENT INSTRUMENTS LIST**

AC Power Line Conducted Emissions					
Item	Kind of Equipment	Manufacturer	Type No.	Serial No.	Calibrated until
1	EMI Test Receiver	R&S	ESCI	100382	Jan. 22, 2023
2	LISN	EMCO	3816/2	52765	Jan. 23, 2023
3	TWO-LINE V-NETWORK	R&S	ENV216	101447	Jan. 23, 2023
4	50Ω Terminator	SHX	TF5-3	15041305	N/A
5	Measurement Software	Farad	EZ-EMC Ver.NB-03A1-01	N/A	N/A
6	Cable	N/A	RG223	12m	Mar. 08, 2023
7	643 Shield Room	ETS	6*4*3	N/A	N/A

Radiated Emissions - 9 kHz to 30 MHz					
Item	Kind of Equipment	Manufacturer	Type No.	Serial No.	Calibrated until
1	MXE EMI Receiver	Keysight	N9038A	MY56400091	Jan. 22, 2023
2*	Active Loop Antenna	R&S	HFH2-Z2	830749/020	Aug. 23, 2024
3	Cable	N/A	RG 213/U(9kHz~1GHz)	N/A	Jul. 09, 2022
4	Measurement Software	Farad	EZ-EMC Ver.NB-03A1-01	N/A	N/A
5	966 Chamber Room	ETS	9*6*6	N/A	Jul. 17, 2022

Radiated Emissions - 30 MHz to 1 GHz					
Item	Kind of Equipment	Manufacturer	Type No.	Serial No.	Calibrated until
1	Antenna	Schwarzbeck	VULB9160	9160-3232	Mar. 03, 2023
2	Amplifier	HP	8447D	2944A08742	Jan. 22, 2023
3	Cable	emci	LMR-400	N/A	Nov. 30, 2022
4	Controller	CT	SC100	N/A	N/A
5	Controller	MF	MF-7802	MF780208416	N/A
6	Receiver	Agilent	N9038A	MY52130039	Jan. 22, 2023
7	Measurement Software	Farad	EZ-EMC Ver.NB-03A1-01	N/A	N/A
8	966 Chamber Room	RM	9*6*6	N/A	Jul. 24, 2022

Radiated Emissions - Above 1 GHz					
Item	Kind of Equipment	Manufacturer	Type No.	Serial No.	Calibrated until
1	Double Ridged Horn Antenna	ARA	DRG-118A	16554	Apr. 18, 2023
2	Broad-Band Horn Antenna	Schwarzbeck	BBHA 9170	9170319	May 27, 2023
3	Amplifier	Agilent	8449B	3008A02584	Jul. 10, 2022
4	Controller	CT	SC100	N/A	N/A
5	Controller	MF	MF-7802	MF780208416	N/A
6	Receiver	Agilent	N9038A	MY52130039	Jan. 22, 2023
7	EXA Spectrum Analyzer	Keysight	N9010A	MY56480488	Jan. 22, 2023
8	Low Noise Amplifier	CONNPHY	CLN-18G40G-4330-K	619413	Jul. 16, 2022
9	Cable	Talent microwave	A81-SMAMSMAM-12.5M	N/A	Oct. 15, 2022
10	Cable	Talent microwave	A40-2.92M2.92M-2.5M	N/A	Nov. 30, 2022
11	Filter	STI	STI15-9912	N/A	Jul. 10, 2022
12	Measurement Software	Farad	EZ-EMC Ver.NB-03A1-01	N/A	N/A
13	966 Chamber Room	RM	9*6*6	N/A	Jul. 24, 2022

Bandwidth					
Item	Kind of Equipment	Manufacturer	Type No.	Serial No.	Calibrated until
1	Spectrum Analyzer	R&S	FSP40	100185	Jul. 10, 2022
2	Attenuator	WOKEN	6SM3502	VAS1214NL	N/A
3	RF Cable	Tongkaichuan	N/A	N/A	N/A
4	DC Block	Mini	N/A	N/A	N/A

Remark "N/A" denotes no model name, serial no. or calibration specified.

"\*\*" calibration period of equipment list is three year.

Except \* item, all calibration period of equipment list is one year.

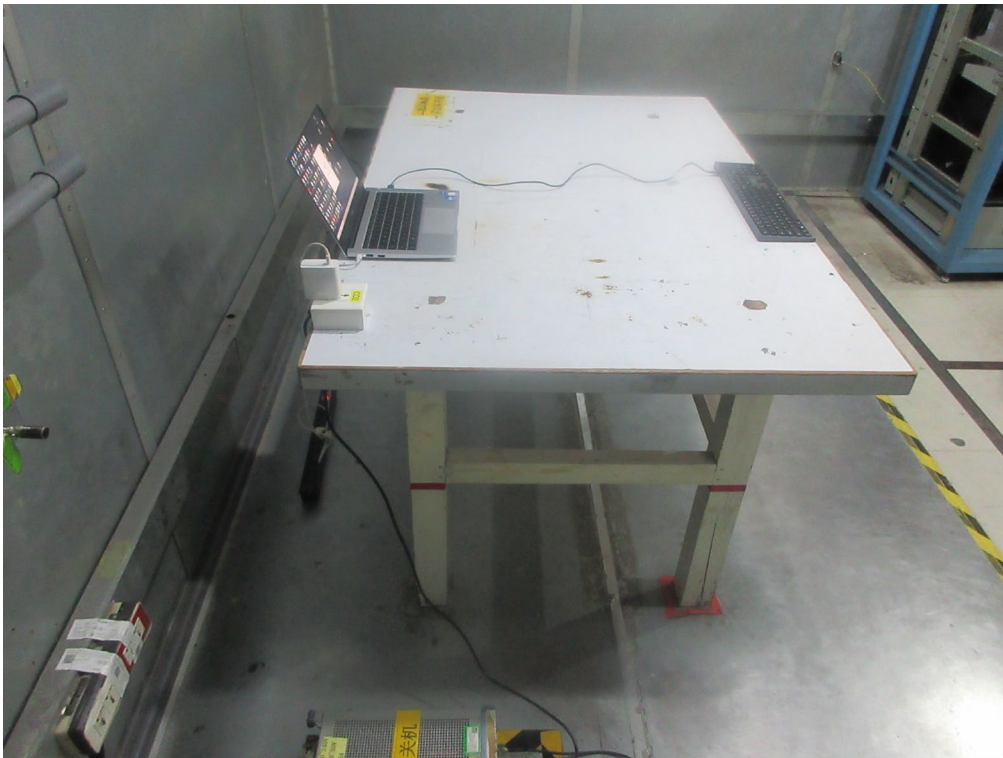
**7. EUT TEST PHOTO****AC Power Line Conducted Emissions Test Photos**

**Radiated Emissions Test Photos**

**9 kHz to 30 MHz**

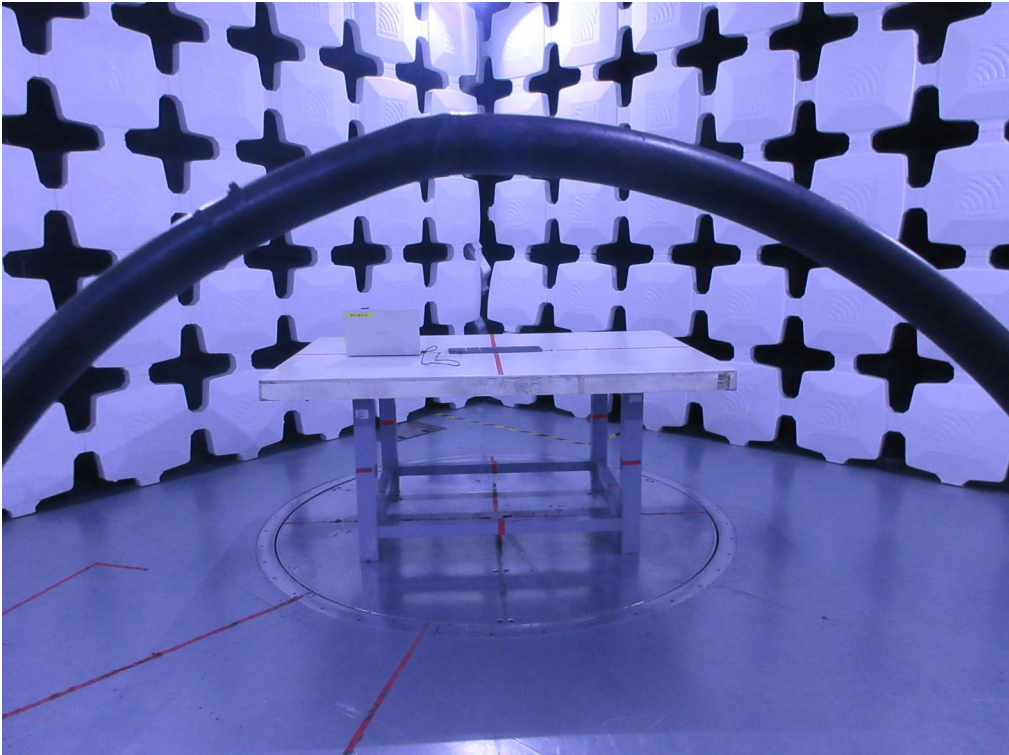
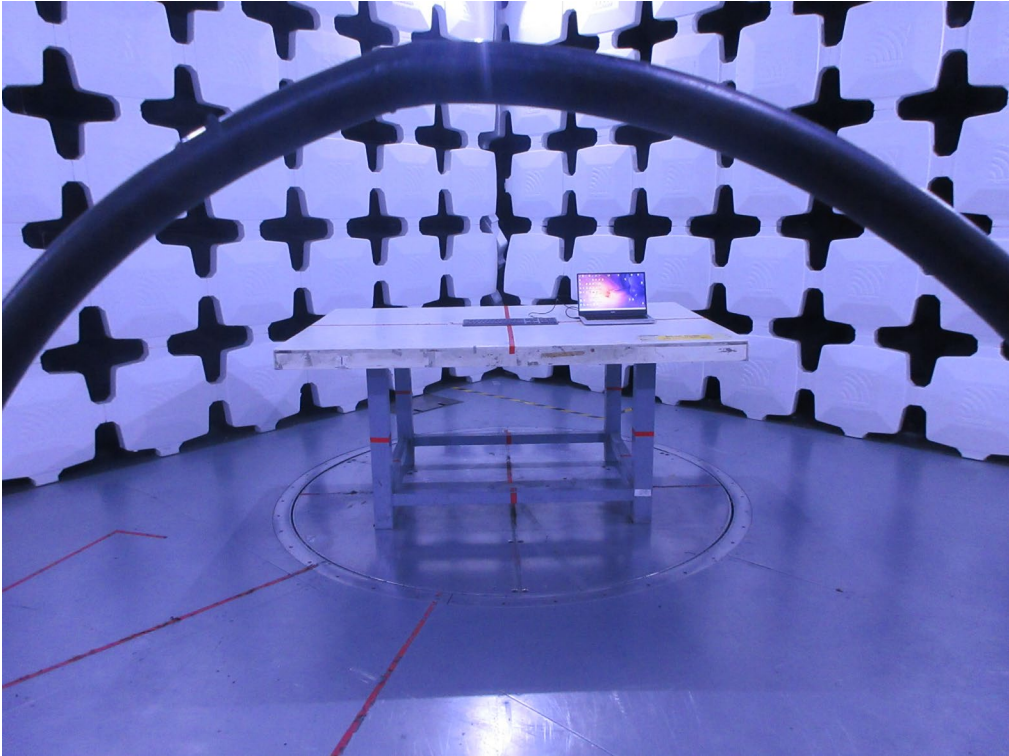

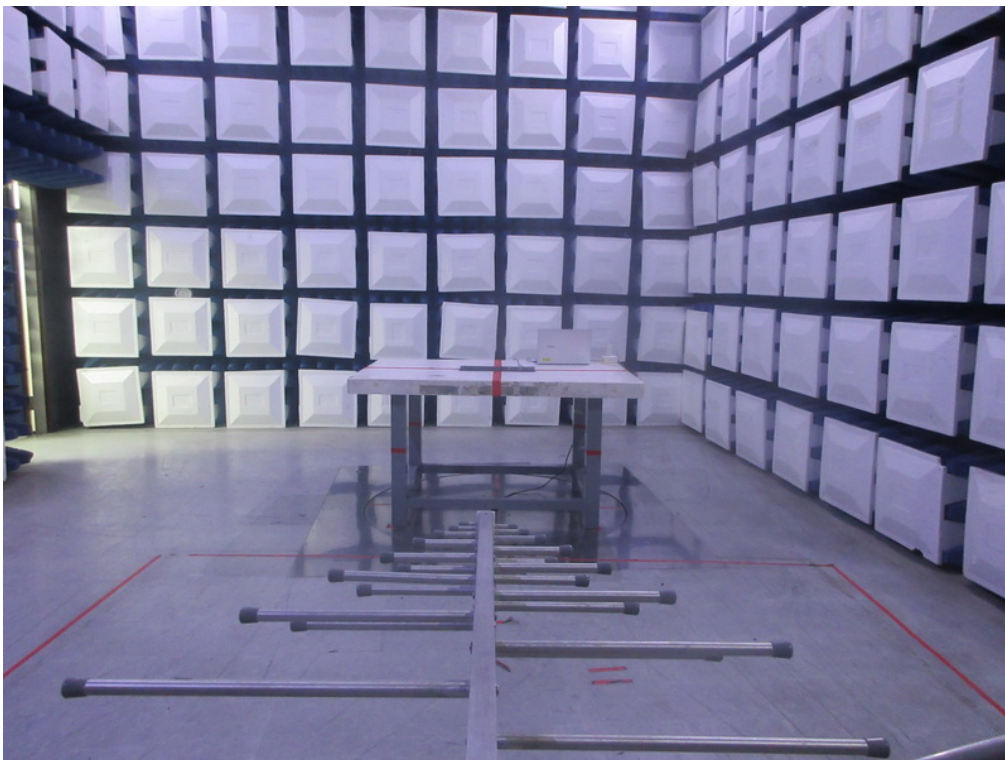
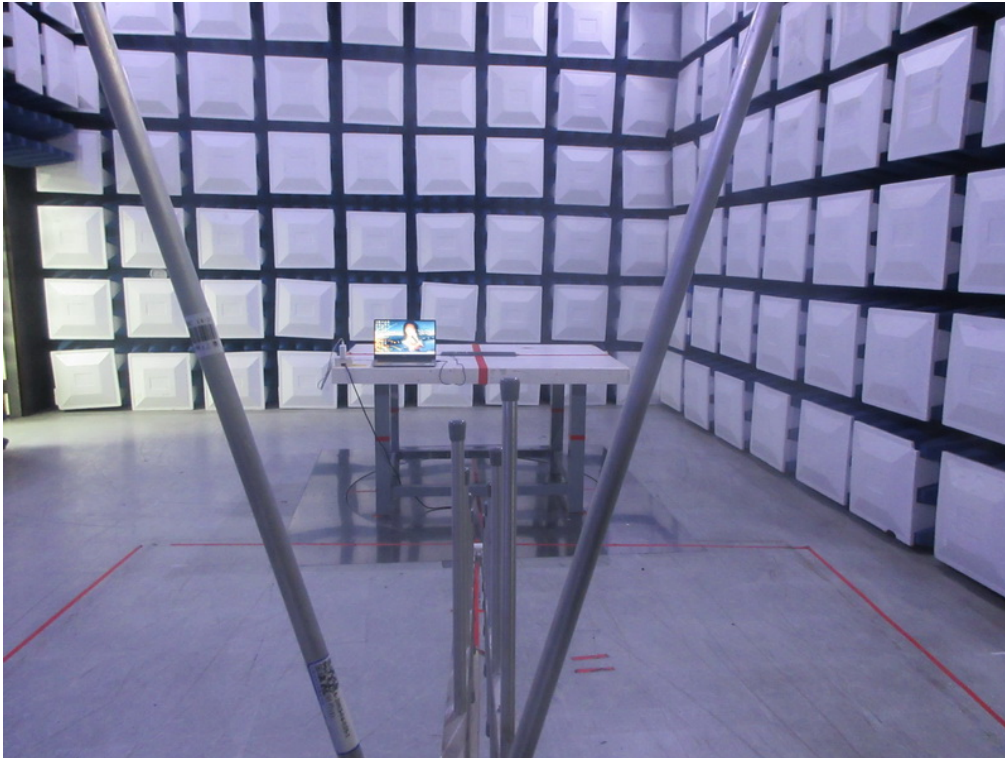
**Radiated Emissions Test Photos****30 MHz to 1000 MHz**



**Radiated Emissions Test Photos****Above 1 GHz**

## **APPENDIX A - AC POWER LINE CONDUCTED EMISSIONS**

Test Mode	TX Mode_Channel 16	Phase	Line
-----------	--------------------	-------	------

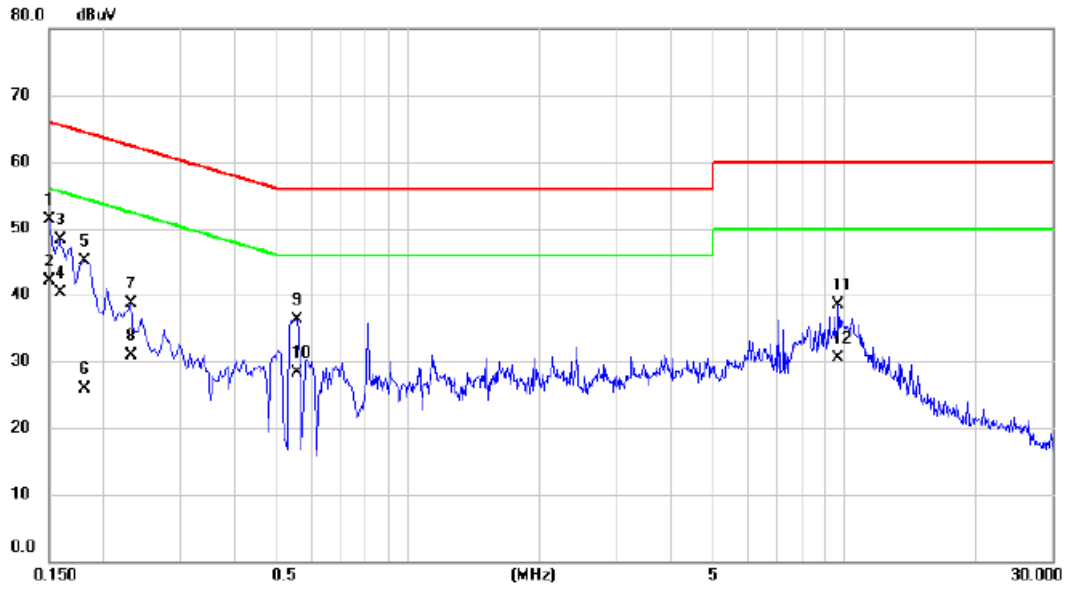

No.	Mk.	Freq.	Reading Level	Correct Factor	Measurement	Limit	Margin	Detector	Comment
		MHz	dBuV	dB	dBuV	dBuV	dB		
1		0.1500	41.59	9.66	51.25	66.00	-14.75	QP	
2	*	0.1500	32.50	9.66	42.16	56.00	-13.84	AVG	
3		0.1590	38.70	9.66	48.36	65.52	-17.16	QP	
4		0.1590	30.60	9.66	40.26	55.52	-15.26	AVG	
5		0.1815	35.52	9.67	45.19	64.42	-19.23	QP	
6		0.1815	16.30	9.67	25.97	54.42	-28.45	AVG	
7		0.2310	28.96	9.70	38.66	62.41	-23.75	QP	
8		0.2310	21.20	9.70	30.90	52.41	-21.51	AVG	
9		0.5550	26.44	9.78	36.22	56.00	-19.78	QP	
10		0.5550	18.50	9.78	28.28	46.00	-17.72	AVG	
11		9.6810	28.07	10.46	38.53	60.00	-21.47	QP	
12		9.6810	20.10	10.46	30.56	50.00	-19.44	AVG	

REMARKS:  
 (1) Measurement Value = Reading Level + Correct Factor.  
 (2) Margin Level = Measurement Value - Limit Value.

Test Mode	TX Mode_Channel 16	Phase	Neutral
-----------	--------------------	-------	---------

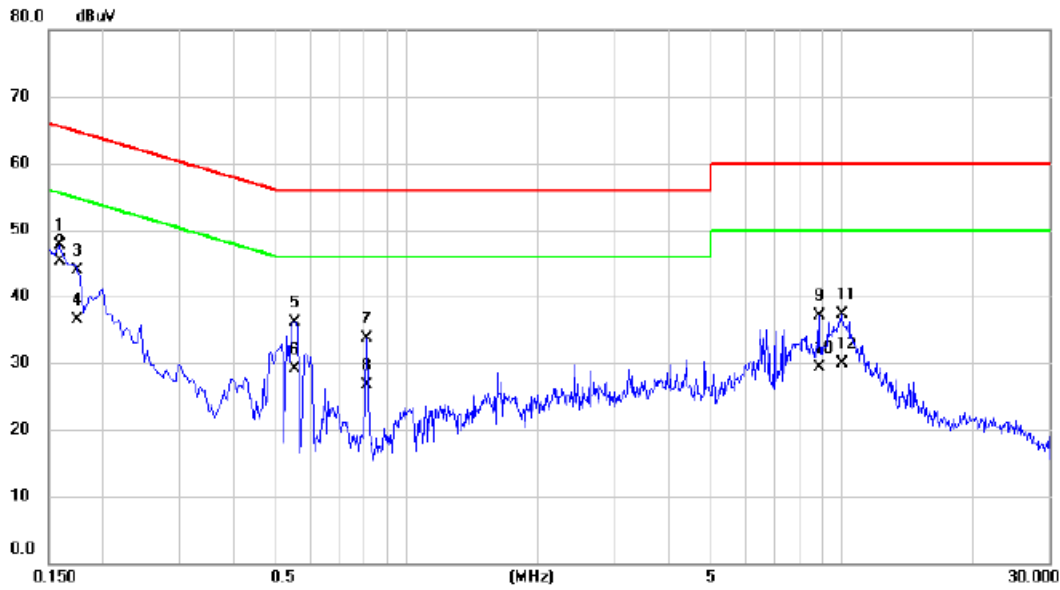

No.	Mk.	Freq. MHz	Reading Level dBuV	Correct Factor dB	Measure- ment dBuV	Limit dBuV	Margin dB	Detector	Comment
1		0.1590	37.96	9.71	47.67	65.52	-17.85	QP	
2	*	0.1590	35.60	9.71	45.31	55.52	-10.21	AVG	
3		0.1750	34.16	9.71	43.87	64.72	-20.85	QP	
4		0.1750	26.80	9.71	36.51	54.72	-18.21	AVG	
5		0.5505	26.26	9.81	36.07	56.00	-19.93	QP	
6		0.5505	19.20	9.81	29.01	46.00	-16.99	AVG	
7		0.8115	23.86	9.83	33.69	56.00	-22.31	QP	
8		0.8115	16.80	9.83	26.63	46.00	-19.37	AVG	
9		8.8395	26.78	10.41	37.19	60.00	-22.81	QP	
10		8.8395	18.90	10.41	29.31	50.00	-20.69	AVG	
11		9.9780	26.82	10.47	37.29	60.00	-22.71	QP	
12		9.9780	19.50	10.47	29.97	50.00	-20.03	AVG	

**REMARKS:**

- (1) Measurement Value = Reading Level + Correct Factor.
- (2) Margin Level = Measurement Value - Limit Value.

**APPENDIX B - RADIATED EMISSION - 9 KHZ TO 30 MHZ**

Test Mode	TX Mode_Channel 16	Polarization	Ant 0°
-----------	--------------------	--------------	--------

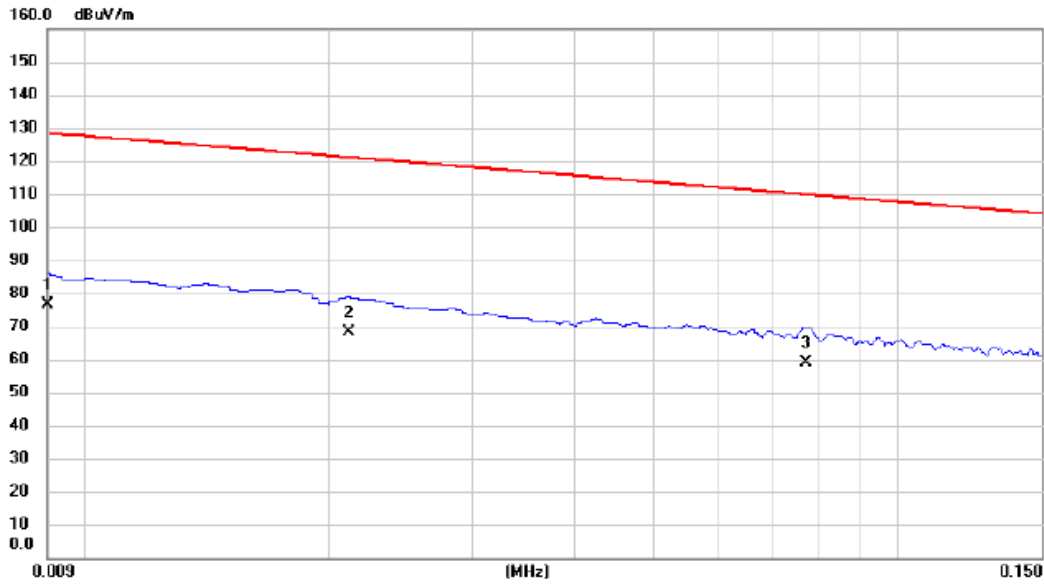

No. Mk.	Freq. MHz	Reading Level dBuV	Correct Factor dB	Measurement dBuV/m	Limit dBuV/m	Margin dB	Detector	Comment
1	0.009	54.85	21.80	76.65	128.52	-51.87	AVG	
2	0.021	46.96	21.09	68.05	121.12	-53.07	AVG	
3 *	0.077	37.98	20.97	58.95	109.85	-50.90	AVG	

REMARKS:

- (1) Measurement Value = Reading Level + Correct Factor.
- (2) Margin Level = Measurement Value - Limit Value.

Test Mode	TX Mode_Channel 16	Polarization	Ant 0°
-----------	--------------------	--------------	--------

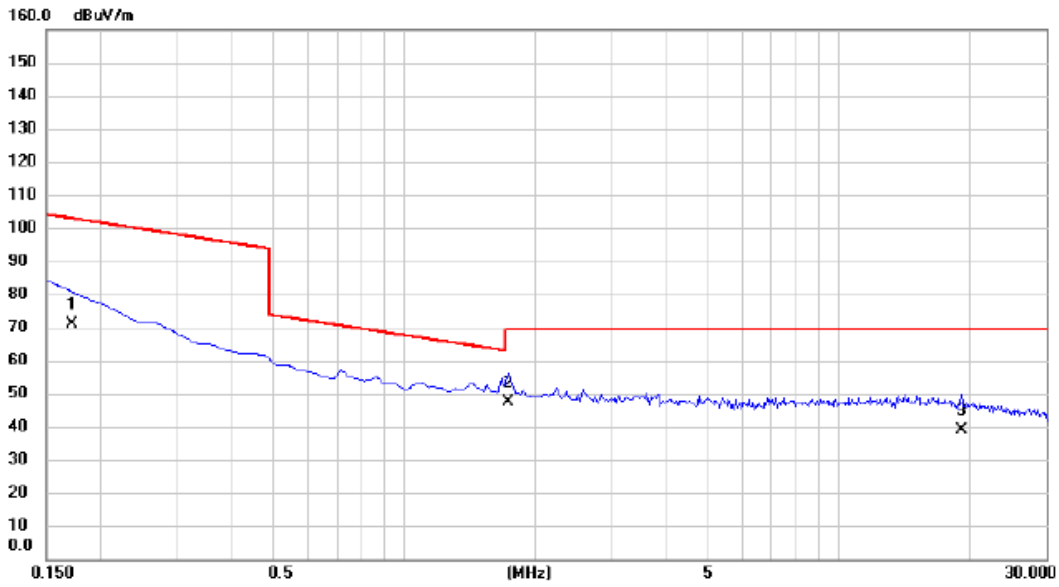

No. Mk.	Freq. MHz	Reading Level dBuV	Correct Factor dB	Measurement dBuV/m	Limit dBuV/m	Margin dB	Detector	Comment
1	0.172	50.12	20.85	70.97	102.89	-31.92	AVG	
2 *	1.732	25.34	21.87	47.21	69.54	-22.33	QP	
3	19.134	15.69	23.22	38.91	69.54	-30.63	QP	

**REMARKS:**

- (1) Measurement Value = Reading Level + Correct Factor.
- (2) Margin Level = Measurement Value - Limit Value.

Test Mode	TX Mode_Channel 16	Polarization	Ant 90°
-----------	--------------------	--------------	---------

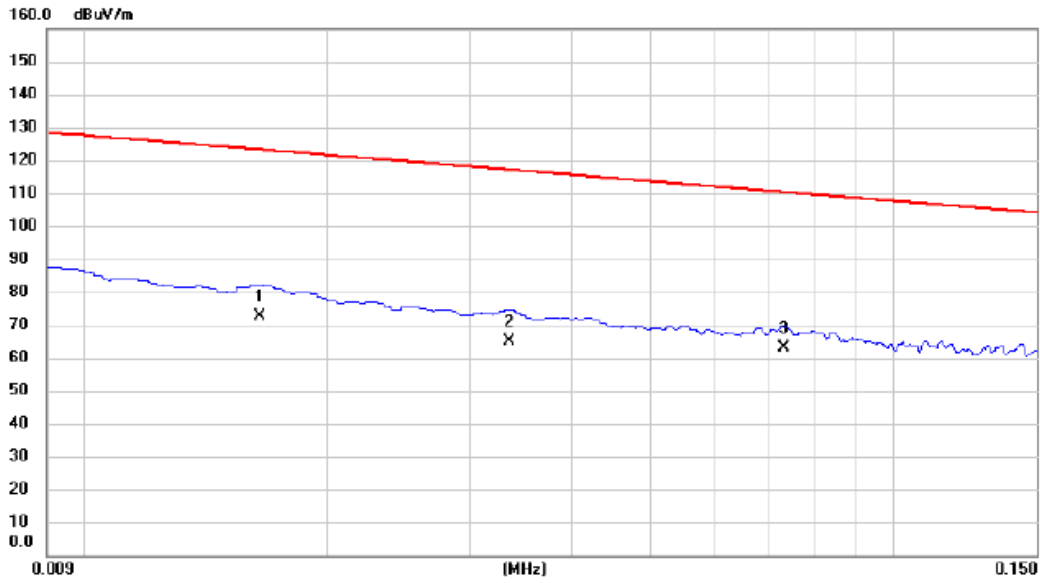

No. Mk.	Freq. MHz	Reading Level dBuV	Correct Factor dB	Measure- ment dBuV/m	Limit dBuV/m	Margin dB	Detector	Comment
1	0.017	51.34	21.28	72.62	123.26	-50.64	AVG	
2	0.034	44.16	21.01	65.17	117.10	-51.93	AVG	
3 *	0.073	41.87	20.99	62.86	110.31	-47.45	AVG	

**REMARKS:**

- (1) Measurement Value = Reading Level + Correct Factor.
- (2) Margin Level = Measurement Value - Limit Value.



Test Mode	TX Mode_Channel 16	Polarization	Ant 90°
-----------	--------------------	--------------	---------

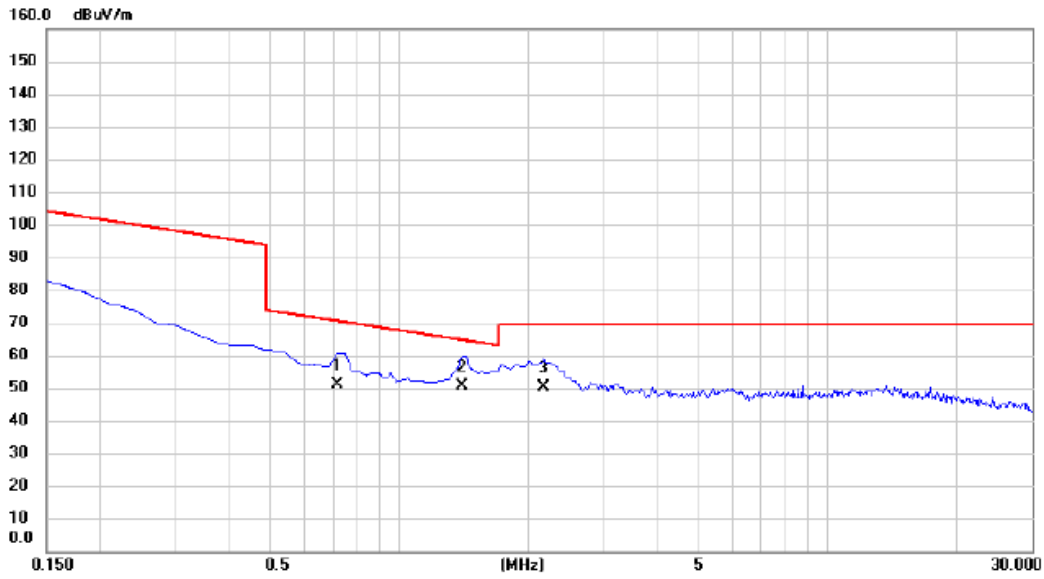

No. Mk.	Freq. MHz	Reading Level dBuV	Correct Factor dB	Measurement dBuV/m	Limit dBuV/m	Margin dB	Detector	Comment
1	0.717	29.66	21.33	50.99	70.49	-19.50	QP	
2 *	1.404	28.74	21.77	50.51	64.66	-14.15	QP	
3	2.180	28.36	21.97	50.33	69.54	-19.21	QP	

**REMARKS:**

- (1) Measurement Value = Reading Level + Correct Factor.
- (2) Margin Level = Measurement Value - Limit Value.

## **APPENDIX C - RADIATED EMISSION - 30 MHZ TO 1000 MHZ**

Test Mode	TX Mode_Channel 16	Polarization	Vertical
-----------	--------------------	--------------	----------

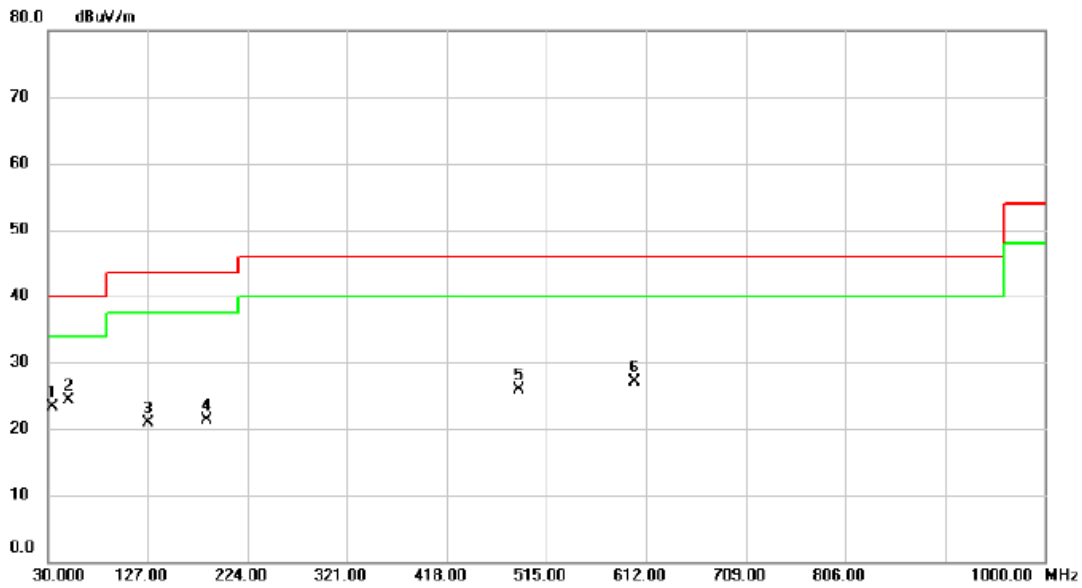

No.	Mk.	Freq. MHz	Reading Level dBuV	Correct Factor dB	Measure- ment dBuV/m	Limit dBuV/m	Margin dB	Detector	Comment
1		33.8800	38.39	-15.00	23.39	40.00	-16.61	peak	
2	*	49.4000	38.02	-13.64	24.38	40.00	-15.62	peak	
3		127.9700	34.21	-13.40	20.81	43.50	-22.69	peak	
4		184.2300	35.31	-13.98	21.33	43.50	-22.17	peak	
5		488.8100	32.25	-6.44	25.81	46.00	-20.19	peak	
6		600.3600	31.33	-4.20	27.13	46.00	-18.87	peak	

**REMARKS:**

- (1) Measurement Value = Reading Level + Correct Factor.
- (2) Margin Level = Measurement Value - Limit Value.

Test Mode	TX Mode_Channel 16	Polarization	Horizontal
-----------	--------------------	--------------	------------

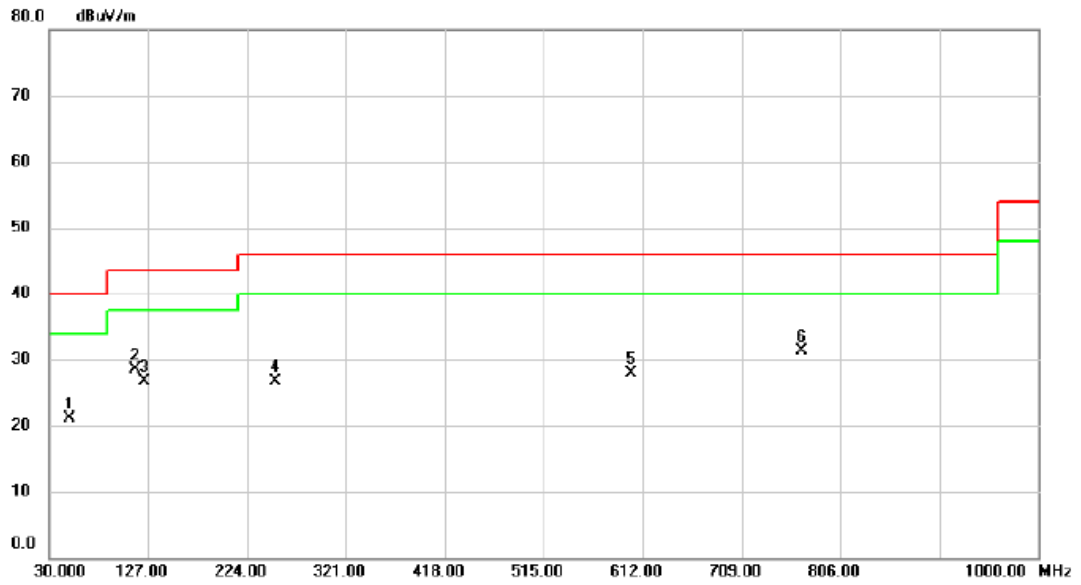

No. Mk.	Freq. MHz	Reading Level dBuV	Correct Factor dB	Measurement dBuV/m	Limit dBuV/m	Margin dB	Detector	Comment
1	49.4000	34.79	-13.64	21.15	40.00	-18.85	peak	
2	114.3900	42.94	-14.52	28.42	43.50	-15.08	peak	
3	124.0900	40.33	-13.71	26.62	43.50	-16.88	peak	
4	251.1600	39.32	-12.68	26.64	46.00	-19.36	peak	
5	600.3600	32.09	-4.20	27.89	46.00	-18.11	peak	
6 *	768.1700	32.47	-1.12	31.35	46.00	-14.65	peak	

REMARKS:  
 (1) Measurement Value = Reading Level + Correct Factor.  
 (2) Margin Level = Measurement Value - Limit Value.

**APPENDIX D - RADIATED EMISSION - ABOVE 1000 MHZ**

Test Mode	TX 2403.85 MHz _CH01	Polarization	Vertical
-----------	----------------------	--------------	----------

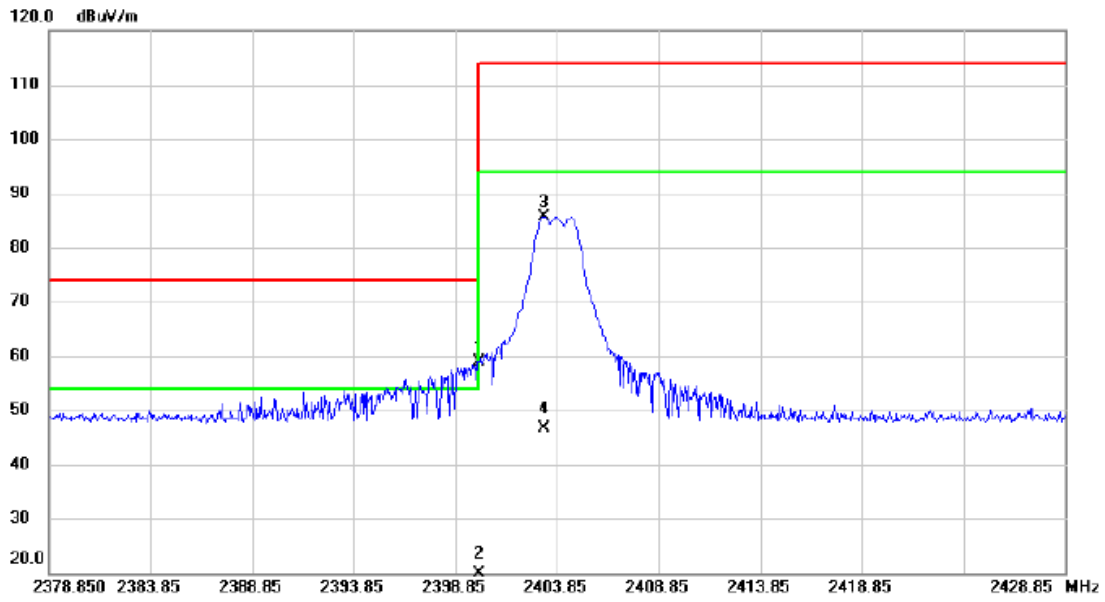

No.	Mk.	Freq. MHz	Reading Level dBuV	Correct Factor dB	Measure- ment dBuV/m	Limit dBuV/m	Margin dB	Detector	Comment
1	*	2400.000	51.59	7.28	58.87	74.00	-15.13	peak	
2		2400.000	12.59	7.28	19.87	54.00	-34.13	AVG	
3		2403.200	78.42	7.28	85.70	114.00	-28.30	peak	
4		2403.200	39.42	7.28	46.70	94.00	-47.30	AVG	

**REMARKS:**

- (1) Measurement Value = Reading Level + Correct Factor.
- (2) Margin Level = Measurement Value - Limit Value.

Test Mode	TX 2403.85 MHz _CH01	Polarization	Vertical
-----------	----------------------	--------------	----------

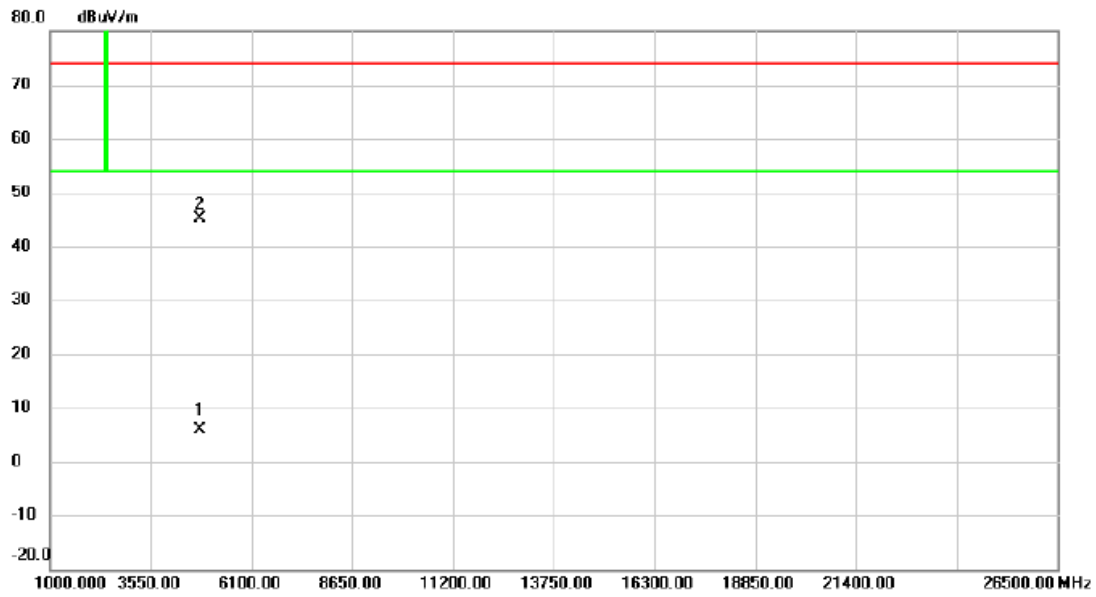

No.	Mk.	Freq. MHz	Reading Level dBuV	Correct Factor dB	Measure- ment dBuV/m	Limit dBuV/m	Margin dB	Detector	Comment
1		4807.465	1.41	4.50	5.91	54.00	-48.09	AVG	
2	*	4807.565	40.73	4.50	45.23	74.00	-28.77	peak	

**REMARKS:**

- (1) Measurement Value = Reading Level + Correct Factor.
- (2) Margin Level = Measurement Value - Limit Value.

Test Mode	TX 2403.85 MHz _CH01	Polarization	Horizontal
-----------	----------------------	--------------	------------

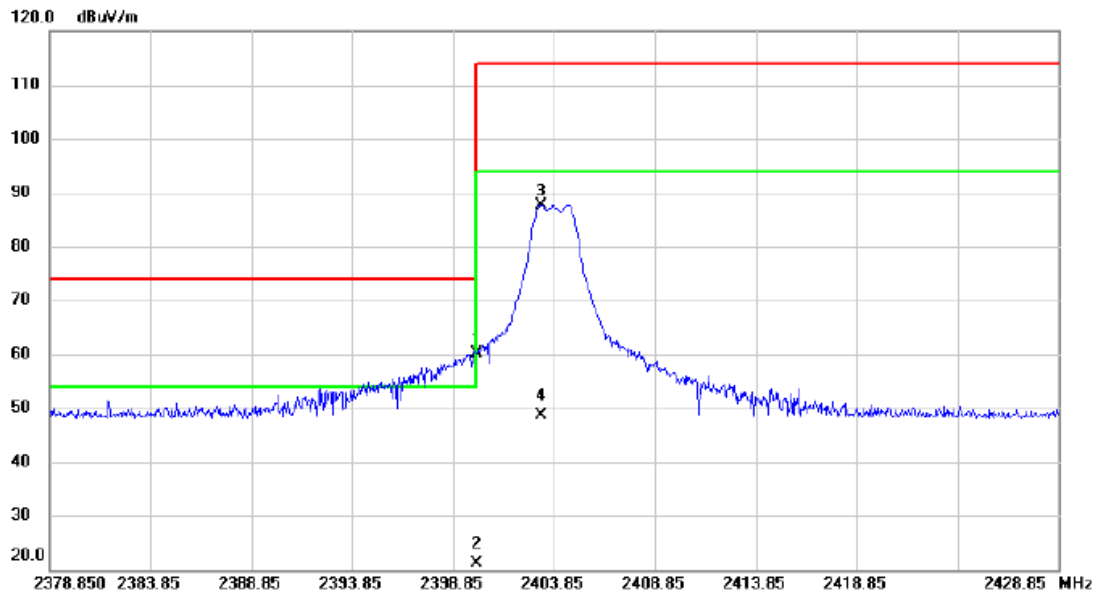

No.	Mk.	Freq. MHz	Reading Level dBuV	Correct Factor dB	Measure- ment dBuV/m	Limit dBuV/m	Margin dB	Detector	Comment
1	*	2400.000	52.92	7.28	60.20	74.00	-13.80	peak	
2		2400.000	13.92	7.28	21.20	54.00	-32.80	AVG	
3		2403.200	80.36	7.28	87.64	114.00	-26.36	peak	
4		2403.200	41.36	7.28	48.64	94.00	-45.36	AVG	

**REMARKS:**

- (1) Measurement Value = Reading Level + Correct Factor.
- (2) Margin Level = Measurement Value - Limit Value.



Test Mode	TX 2403.85 MHz _CH01	Polarization	Horizontal
-----------	----------------------	--------------	------------

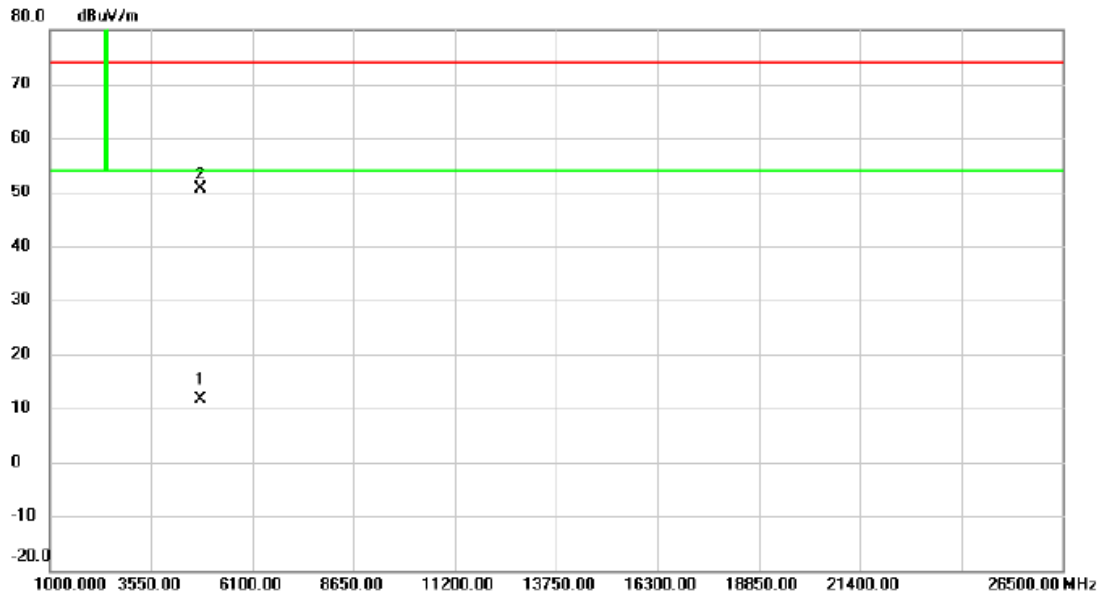

No.	Mk.	Freq. MHz	Reading Level dBuV	Correct Factor dB	Measure- ment dBuV/m	Limit dBuV/m	Margin dB	Detector	Comment
1		4807.630	7.13	4.50	11.63	54.00	-42.37	AVG	
2	*	4807.650	46.13	4.50	50.63	74.00	-23.37	peak	

**REMARKS:**

- (1) Measurement Value = Reading Level + Correct Factor.
- (2) Margin Level = Measurement Value - Limit Value.

Test Mode	TX 2441.85 MHz _CH09	Polarization	Vertical
-----------	----------------------	--------------	----------

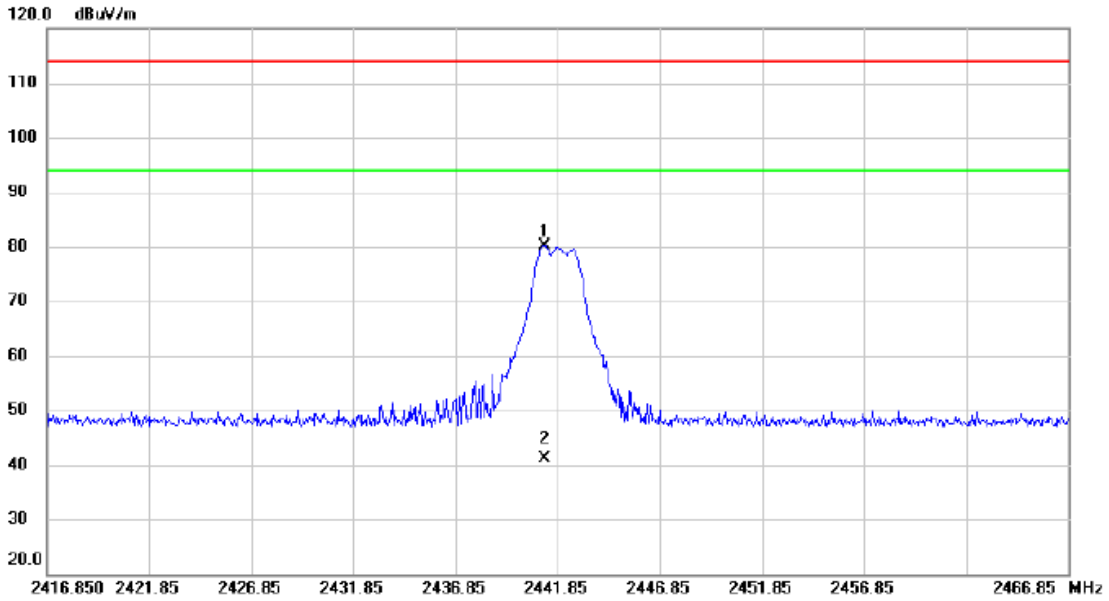

No.	Mk.	Freq. MHz	Reading Level dBuV	Correct Factor dB	Measure- ment dBuV/m	Limit dBuV/m	Margin dB	Detector	Comment
1	*	2441.200	72.93	7.30	80.23	114.00	-33.77	peak	
2		2441.200	33.93	7.30	41.23	94.00	-52.77	AVG	

**REMARKS:**

- (1) Measurement Value = Reading Level + Correct Factor.
- (2) Margin Level = Measurement Value - Limit Value.

Test Mode	TX 2441.85 MHz _CH09	Polarization	Vertical
-----------	----------------------	--------------	----------

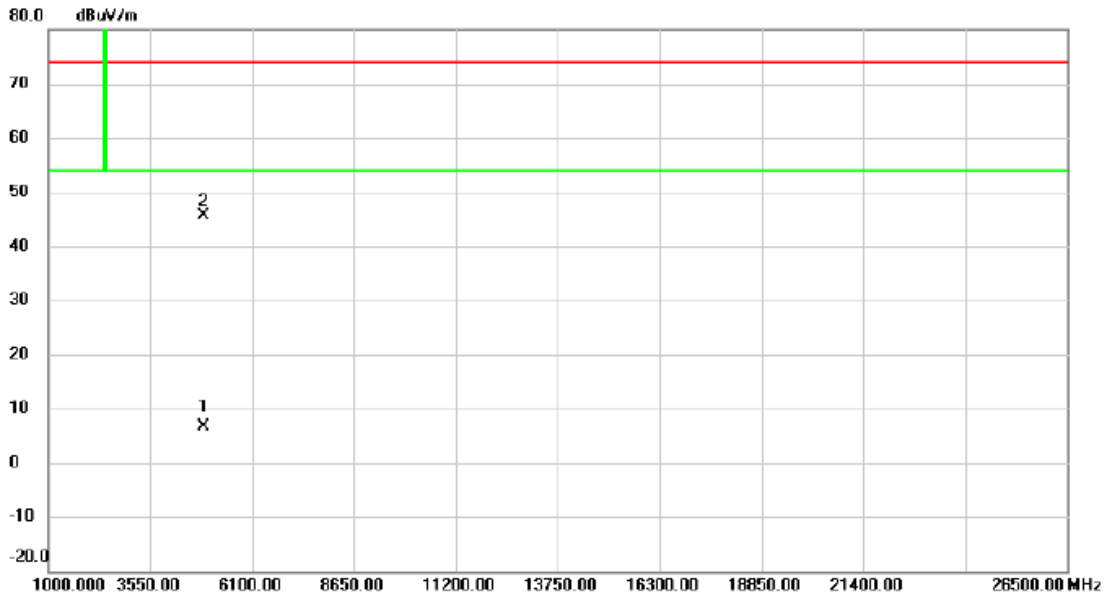

No.	Mk.	Freq. MHz	Reading Level dBuV	Correct Factor dB	Measure- ment dBuV/m	Limit dBuV/m	Margin dB	Detector	Comment
1		4883.640	1.90	4.81	6.71	54.00	-47.29	AVG	
2	*	4883.645	40.90	4.81	45.71	74.00	-28.29	peak	

**REMARKS:**

- (1) Measurement Value = Reading Level + Correct Factor.
- (2) Margin Level = Measurement Value - Limit Value.

Test Mode	TX 2441.85 MHz _CH09	Polarization	Horizontal
-----------	----------------------	--------------	------------

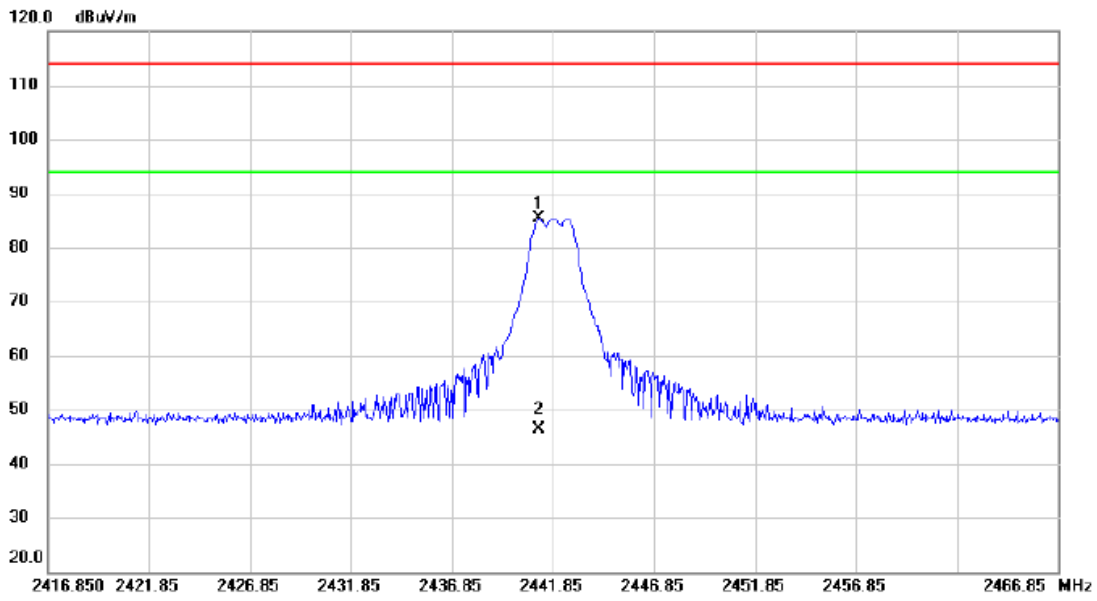

No.	Mk.	Freq.	Reading Level	Correct Factor	Measurement	Limit	Margin	Detector	Comment
		MHz	dBuV	dB	dBuV/m	dBuV/m	dB		
1	*	2441.175	77.99	7.30	85.29	114.00	-28.71	peak	
2		2441.175	38.99	7.30	46.29	94.00	-47.71	AVG	

**REMARKS:**

- (1) Measurement Value = Reading Level + Correct Factor.
- (2) Margin Level = Measurement Value - Limit Value.

Test Mode	TX 2441.85 MHz _CH09	Polarization	Horizontal
-----------	----------------------	--------------	------------

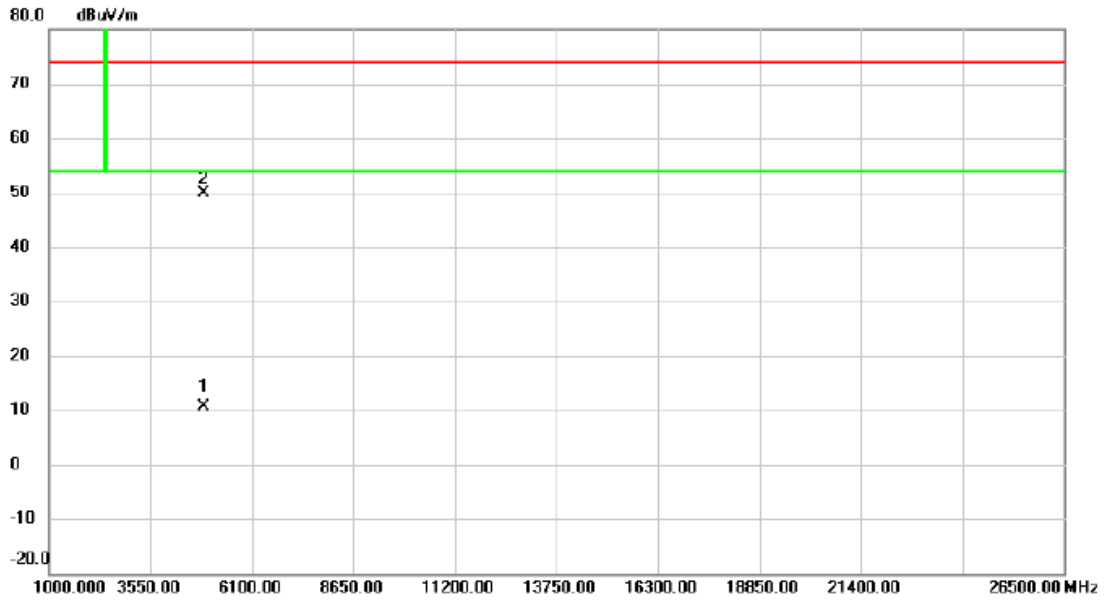

No.	Mk.	Freq. MHz	Reading Level dBuV	Correct Factor dB	Measure- ment dBuV/m	Limit dBuV/m	Margin dB	Detector	Comment
1		4883.420	5.92	4.81	10.73	54.00	-43.27	AVG	
2	*	4883.475	44.99	4.81	49.80	74.00	-24.20	peak	

**REMARKS:**

- (1) Measurement Value = Reading Level + Correct Factor.
- (2) Margin Level = Measurement Value - Limit Value.

Test Mode	TX 2479.85 MHz _CH16	Polarization	Vertical
-----------	----------------------	--------------	----------

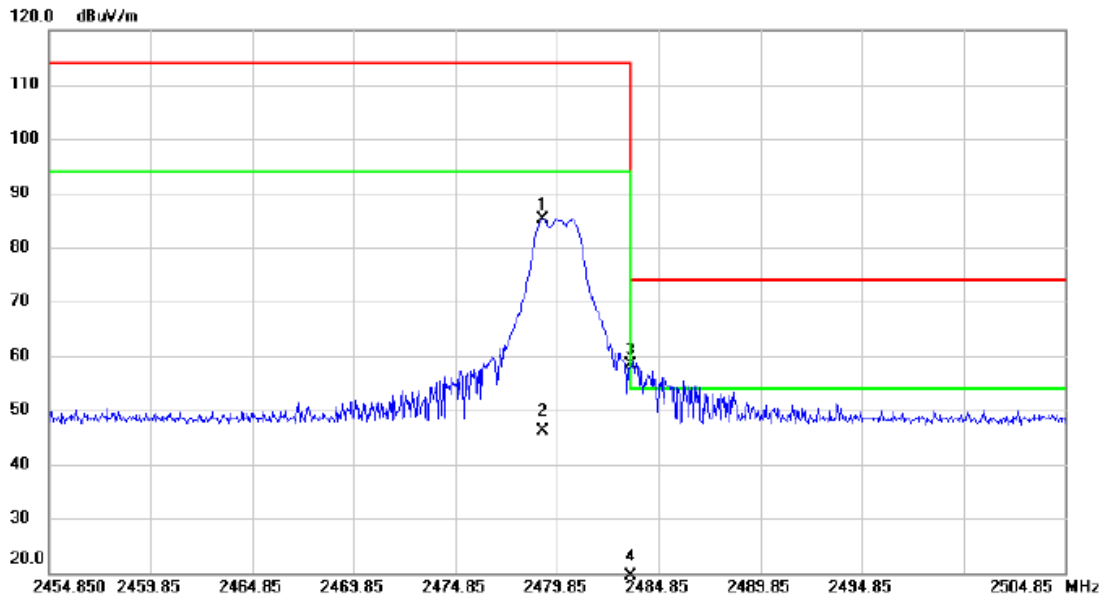

No.	Mk.	Freq. MHz	Reading Level dBuV	Correct Factor dB	Measure- ment dBuV/m	Limit dBuV/m	Margin dB	Detector	Comment
1		2479.150	77.78	7.34	85.12	114.00	-28.88	peak	
2		2479.150	38.78	7.34	46.12	94.00	-47.88	AVG	
3	*	2483.500	50.92	7.34	58.26	74.00	-15.74	peak	
4		2483.500	11.92	7.34	19.26	54.00	-34.74	AVG	

**REMARKS:**

- (1) Measurement Value = Reading Level + Correct Factor.
- (2) Margin Level = Measurement Value - Limit Value.

Test Mode	TX 2479.85 MHz _CH16	Polarization	Vertical
-----------	----------------------	--------------	----------

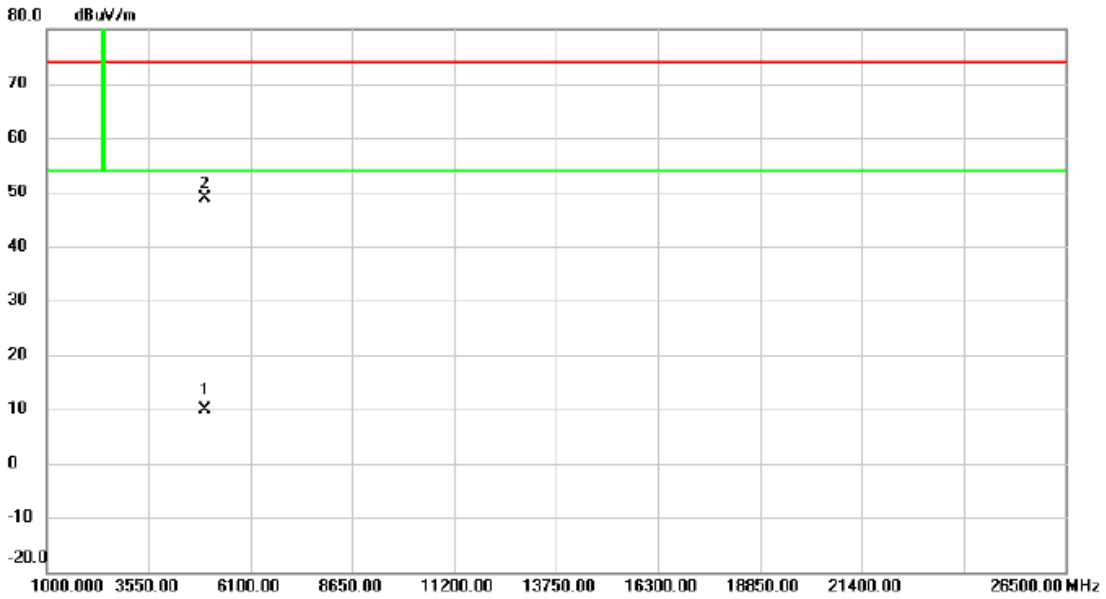

No.	Mk.	Freq. MHz	Reading Level dBuV	Correct Factor dB	Measure- ment dBuV/m	Limit dBuV/m	Margin dB	Detector	Comment
1		4959.595	4.86	5.12	9.98	54.00	-44.02	AVG	
2	*	4959.645	43.84	5.12	48.96	74.00	-25.04	peak	

**REMARKS:**

- (1) Measurement Value = Reading Level + Correct Factor.
- (2) Margin Level = Measurement Value - Limit Value.

Test Mode	TX 2479.85 MHz _CH16	Polarization	Horizontal
-----------	----------------------	--------------	------------

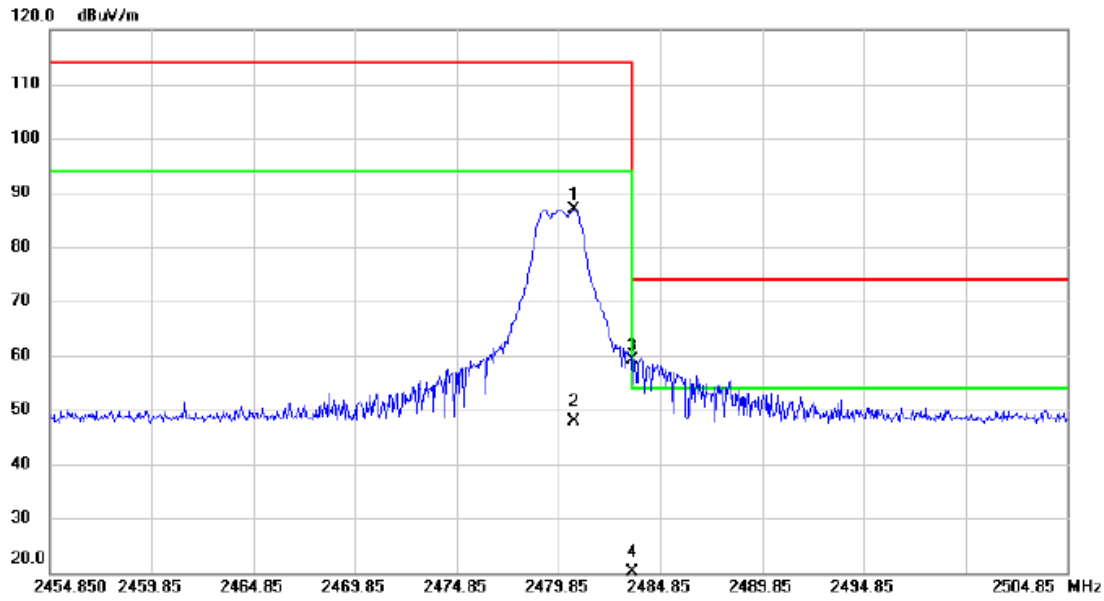

No.	Mk.	Freq. MHz	Reading Level dBuV	Correct Factor dB	Measure- ment dBuV/m	Limit dBuV/m	Margin dB	Detector	Comment
1		2480.600	79.47	7.34	86.81	114.00	-27.19	peak	
2		2480.600	40.47	7.34	47.81	94.00	-46.19	AVG	
3	*	2483.500	51.72	7.34	59.06	74.00	-14.94	peak	
4		2483.500	12.72	7.34	20.06	54.00	-33.94	AVG	

REMARKS:  
 (1) Measurement Value = Reading Level + Correct Factor.  
 (2) Margin Level = Measurement Value - Limit Value.



Test Mode	TX 2479.85 MHz _CH16	Polarization	Horizontal
-----------	----------------------	--------------	------------

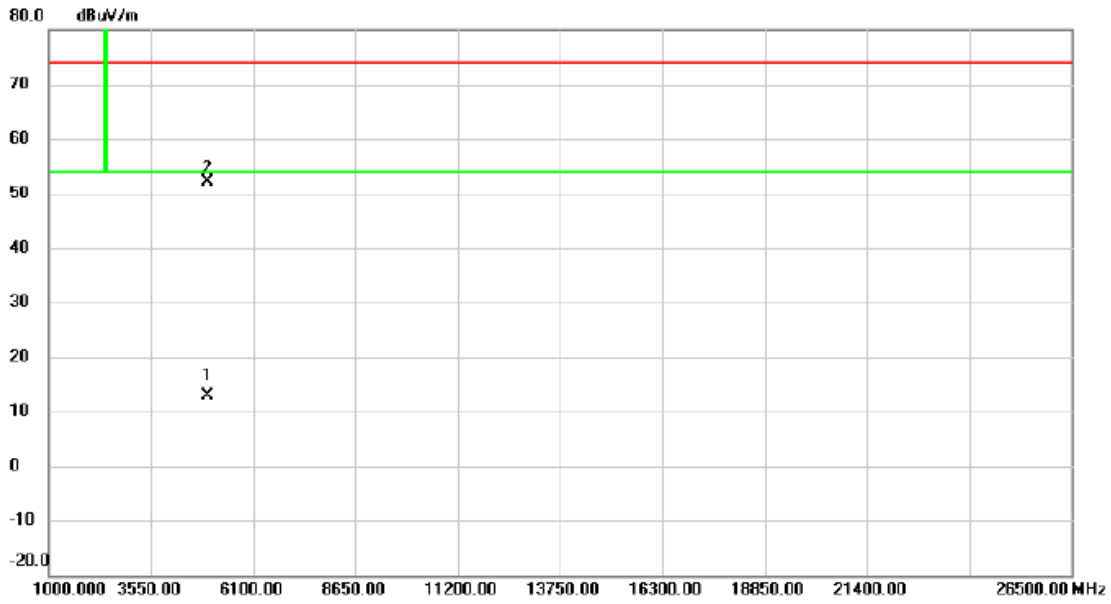

No.	Mk.	Freq.	Reading Level	Correct Factor	Measurement	Limit	Margin	Detector	Comment
		MHz	dBuV	dB	dBuV/m	dBuV/m	dB		
1		4959.505	7.85	5.12	12.97	54.00	-41.03	AVG	
2	*	4959.510	46.89	5.12	52.01	74.00	-21.99	peak	

**REMARKS:**

- (1) Measurement Value = Reading Level + Correct Factor.
- (2) Margin Level = Measurement Value - Limit Value.

## APPENDIX E - BANDWIDTH

Test Mode	TX Mode
-----------	---------

Channel	Frequency (MHz)	20 dB Bandwidth (MHz)	Result
01	2403.85	2.410	Complies
09	2441.85	2.390	Complies
16	2479.85	2.350	Complies

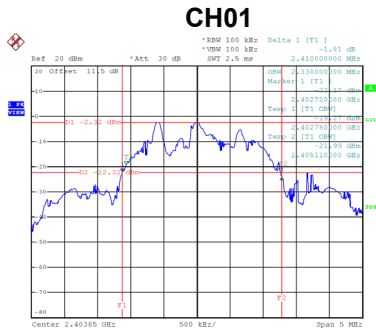

Date: 29\_JUN.2022 17:08:58

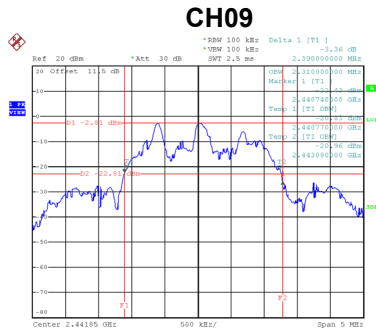

Date: 29\_JUN.2022 17:19:53

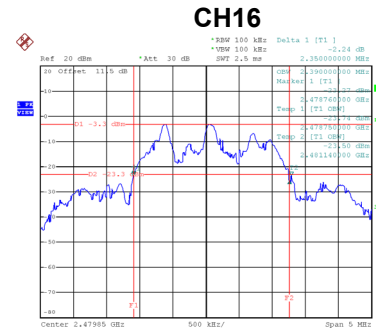

Date: 29\_JUN.2022 17:23:12

**End of Test Report**