



SAR TEST REPORT



Report No.: FCC-IC_SAR_SL18032902-ZBR-011
Supersede Report No.:

Applicant	Zebra Technologies Corp.
Model No.	ZQ610 and ZQ620
Product Name	Thermal Label Printer
Test Standard	47CFR 2.1093, IEEE C95.1-2005 RSS 102 Issue 5.0, IEEE 1528: 2013, IEC 62209-2: 2010
Test Method	IEEE 1528: 2013, IEC 62209-2: 2010 KDB 447498 D01 General RF Exposure Guidance v06 KDB 248227 D01 802.11 Wi-Fi SAR v02r02 KDB 865664 D01 SAR Measurement 100MHz to 6 GHz v01r04 KDB 941225 D06 Hot Spot SAR v02r01
FCC ID	I28MD-FXLAN11AC
IC ID	3798B-FXLAN11AC
Date of test	04/23/2018 – 04/27/2018
Issue Date	04/30/2018
Test Result	Pass Fail
Equipment complied with the specification	[x]
Equipment did not comply with the specification	[]
 	
CIPHER	CHEN GE
Test Engineer	Engineer Reviewer
<p>This test report may be reproduced in full only Test result presented in this test report is applicable to the tested sample only</p>	

Issued By:
SIEMIC Laboratories
775 Montague Expressway, Milpitas, 95035 CA



775 Montague Expressway, Milpitas, CA 95035, USA • Phone: (+1) 408 526 1188 • Facsimile (+1) 408 526 1088

Visit us at: www.siemic.com; Follow us at:



Laboratory Introduction

SIEMIC, headquartered in the heart of Silicon Valley, with superior facilities in US and Asia, is one of the leading independent testing and certification facilities providing customers with one-stop shop services for Compliance Testing and Global Certifications.



In addition to testing and certification, SIEMIC provides initial design reviews and compliance management throughout a project. Our extensive experience with China, Asia Pacific, North America, European, and International compliance requirements, assures the fastest, most cost effective way to attain regulatory compliance for the global markets.

Accreditations for Conformity Assessment

Country/Region	Accreditation Body	Scope
USA	FCC, A2LA	EMC, RF/Wireless, Telecom
Canada	IC, A2LA, NIST	EMC, RF/Wireless, Telecom
Taiwan	BSMI, NCC, NIST	EMC, RF, Telecom, Safety
Hong Kong	OFTA, NIST	RF/Wireless, Telecom
Australia	NATA, NIST	EMC, RF, Telecom, Safety
Korea	KCC/RRA, NIST	EMI, EMS, RF, Telecom, Safety
Japan	VCCI, JATE, TELEC, RFT	EMI, RF/Wireless, Telecom
Mexico	NOM, COFETEL, Caniety	Safety, EMC, RF/Wireless, Telecom
Europe	A2LA, NIST	EMC, RF, Telecom, Safety
Israel	MOC, NIST	EMC, RF, Telecom, Safety

Accreditations for Product Certifications

Country	Accreditation Body	Scope
USA	FCC TCB, NIST	EMC, RF, Telecom
Canada	IC FCB, NIST	EMC, RF, Telecom
Singapore	iDA, NIST	EMC, RF, Telecom
EU	NB	EMC & Radio Equipment Directive (RED)
Japan	MIC (RCB 208)	RF, Telecom
Hong Kong	OFTA (US002)	RF, Telecom

CONTENTS

1	REPORT REVISION HISTORY	5
2	EXECUTIVE SUMMARY	6
3	CUSTOMER INFORMATION	6
4	TEST SITE INFORMATION	6
5	MODIFICATION	7
6	EUT INFORMATION	8
6.1	EUT Description	8
6.2	Radio Description	8
7	SUPPORTING EQUIPMENT/SOFTWARE AND CABLING DESCRIPTION.....	9
7.1	Supporting Equipment	9
7.2	Cabling Description	9
7.3	Test Software Description	9
8	TEST SUMMARY	10
9	SAR INTRODUCTION	11
	Introduction.....	11
	SAR Definition.....	11
10	SAR MEASUREMENT SETUP.....	12
	cDASY V6.0 Compliance Dosimetric Assessment System	12
	Components of the cDASY6 System	12
	Light-Beam Unit	14
	Phantoms	15
	Device Holder for SAM-Twin Phantom.....	15
	ASY6 Measurement Chain	16
	Data Evaluation.....	17
	Dosimetric (SAR) Measurements	20
	SAR Measurements Scan Description	21
	Definition of Reference Points.....	25
	Test Configuration – Positioning for Cheek / Touch.....	26
	Test Configuration – Positioning for Ear / 15° Tilt.....	26
	Test Position – Body Worn Configurations	27
11	MEASUREMENT UNCERTAINTY	28
12	LIQUID VALIDATION	31
	Setup for Liquid Measurement	31
	Liquid Dielectric Parameters	31
13	SAR SYSTEM VERIFICATION.....	33
	System Verification	33
	System Check.....	34
	System Validation.....	35

14	OUTPUT POWER MEASUREMENT RESULTS.....	36
15	SAR TEST RESULTS	40
16	SYSTEM PERFORMANCE PLOTS	44
17	SAR TEST PLOTS.....	48
	ANNEX A. TEST INSTRUMENT	99
	ANNEX B. SIEMIC ACCREDITATION	100
	ANNEX C. PROBE CALIBRATION REPORT	102
	ANNEX D. DIPOLES CALIBRATION REPORT	114
	ANNEX E. DAE CALIBRATION REPORT.....	134

1 Report Revision History

Report No.	Report Version	Description	Issue Date
FCC-IC_SAR_SL18032902-ZBR-011	None	Original	04/30/2018

2 Executive Summary

The purpose of this test program was to demonstrate compliance of following product

Company: Zebra Technologies Corp
Product: Thermal Label Printer
Model: ZQ610 and ZQ620

against the current Stipulated Standards. The specified model product stated above has demonstrated compliance as a spot check with the Stipulated Standard listed on 1st page. The derived result is summarized in following table,

For BT:

Type	CH Freq (MHz)	Conducted Power (dBm)	Measurement Distance (mm)	Calculated 10g SAR ((P/d)*√f)	SAR Exempt Limit for 10g SAR
BT BDR	2402	10.27	5	3.30	7.5
BT EDR	2402	9.96	5	3.07	7.5
Bluetooth LE	2402	8.43	5	2.16	7.5

EUT is exempt from BT SAR evaluation.

Rated, Measured conducted RF output Power and SAR	Mode	Conducted Power (dBm)	Highest 10g SAR
	802.11b (2.4GHz)	15.87	0.0609 W/kg(body)
	802.11a (5 GHz)	15.82	0.0659 W/kg(body)

Note: The EUT is a hand-held device and the 10g SAR limit is 4W/kg. In normal operation, only bottom 2nd sides are touching to human body, right side is exempt because it is far from the antenna, please refer to Test configuration for detailed information.

3 Customer information

Applicant Name	Zebra Technologies Corp.
Applicant Address	3 Overlook Point Lincolnshire, IL 60069, USA
Manufacturer Name	Zebra Technologies Corp.
Manufacturer Address	3 Overlook Point Lincolnshire, IL 60069, USA

4 Test site information

Lab performing tests	SIEMIC Laboratories
Lab Address	775 Montague Expressway, Milpitas, CA 95035
FCC Test Site No.	881796
IC Test Site No.	4842D-2
VCCI Test Site No.	A0133

5 Modification

Index	Item	Description	Note
-	-	-	-

6 EUT Information

6.1 EUT Description

Model No.	ZO610 and ZO620
Product Name	Thermal Label Printer
Trade Name	Zebra
Serial No.	N/A
Input Power	100-240V, 0.8A, 50-60Hz 7.4V, 15A Max
Power Adapter Manu/Model	P1076006
Power Adapter SN	N/A
Hardware version	N/A
Software version	N/A
Date of EUT received	04/06/2018
Equipment Class/ Category	DTS, UNII
Port/Connectors	N/A

Additional EUT Information
Any variants of the primary device? <input type="checkbox"/> Yes <input checked="" type="checkbox"/> No
If yes, please list the different models & differences:
Accessories (Sold with device): Power adapter
The device uses configuration: <input type="checkbox"/> Handheld Device <input checked="" type="checkbox"/> Body worn Device <input type="checkbox"/> Held to ear <input type="checkbox"/> Data Grip
Is the device being sold with multiple antenna options? <input type="checkbox"/> Yes <input checked="" type="checkbox"/> No
Power Adaptor: <input type="checkbox"/> With DC Adaptor <input checked="" type="checkbox"/> With AC Adaptor
Battery Configuration: <input type="checkbox"/> Fixed Battery <input checked="" type="checkbox"/> Removable/Swappable

6.2 Radio Description

Radio Type	802.11b	802.11g	802.11a	802.11n-20M	802.11n-40M	802.11ac-80M
Operating Frequency	2412-2462MHz	2412-2462MHz	5180-5240MHz 5260-5320MHz 5500-5700MHz 5725-5825MHz	2412-2462MHz 5180-5240MHz 5240-5320MHz 5500-5700MHz 5725-5825MHz	2422-2452MHz 5190-5230MHz 5270-5310MHz 5510-5670MHz 5755-5795MHz	5210MHz, 5290MHz, 5530MHz, 5690MHz, 5775MHz
Modulation	DSSS (CCK, DQPSK, DBPSK)	OFDM-CCK (BPSK, QPSK, 16QAM, 64QAM)	OFDM (BPSK, QPSK, 16QAM, 64QAM)	OFDM (BPSK, QPSK, 16QAM, 64QAM)	OFDM (BPSK, QPSK, 16QAM, 64QAM)	OFDM (BPSK, QPSK, 16QAM, 64QAM, 256QAM)
Channel Spacing	5MHz	5MHz	20MHz	5MHz(2.4GHz) 20MHz(5GHz)	40MHz	80MHz
Number of Channels	11	11	24	11(2.4GH) 24(5GHz)	11(5GHz)	5
Antenna Type	Patch Antenna					
Antenna Gain	2.4GHz: 3.66 dBi, 3.19dBi (5GHz)					
Antenna Connector	U. FL.					
Note	N/A					

7 Supporting Equipment/Software and cabling Description

7.1 Supporting Equipment

Item	Supporting Equipment Description	Model	Serial Number	Manufacturer	Note
1	Laptop	Latitude E6510	N/A	Dell	-

7.2 Cabling Description

Name	Connection Start		Connection Stop		Length / shielding Info		Note
	From	I/O Port	To	I/O Port	Length (m)	Shielding	
USB	EUT	Laptop	EUT	Laptop	2	Unshielded	-

7.3 Test Software Description

Test Item	Software	Description
SAR Testing	Toolbox	Set the WLAN radio to transmit continuously in different test mode

8 Test Summary

Test Item	Test standard		Test Method/Procedure		Pass / Fail
SAR	FCC	OET Bulletin 65 Supplement C	IEEE	Std 1528-2013, FCC KDBs	<input checked="" type="checkbox"/> Pass <input type="checkbox"/> N/A
Remark	ZQ610 host printer was used for testing. The only difference between ZQ610 and ZQ620 is the print head size. The size of enclosures is slightly different in the neighbourhood of 2" vs. 3".				

9 SAR Introduction

Introduction

SAR is related to the rate at which energy is absorbed per unit mass in an object exposed to a radio field.

The SAR distribution in a biological body is complicated and is usually carried out by experimental techniques or numerical modeling. The standard recommends limits for two tiers of groups, occupational/controlled and general population/uncontrolled, based on a **person's awareness and ability to exercise control over his or her exposure**. In general, occupational/controlled exposure limits are higher than the limits for general population/uncontrolled.

SAR Definition

Specific Absorption Rate is defined as the time derivative (rate) of the incremental energy (dW) absorbed by (dissipated in) an **incremental mass (dm) contained in a volume element (dV) of a given density (ρ)**.

$$SAR = \frac{d}{dt} \left(\frac{dW}{dm} \right) = \frac{d}{dt} \left(\frac{dW}{\rho dV} \right)$$

SAR is expressed in units of watts per kilogram (W/kg). SAR can be related to the electric field at a point by

$$SAR = \frac{\sigma |E|^2}{\rho}$$

Where:

σ = conductivity of the tissue (S/m)

ρ = mass density of the tissue (kg/m³)

E = RMS electric field strength (V/m)

10 SAR Measurement Setup

cDASY V6.0 Compliance Dosimetric Assessment System

The DASY6 system combines a sophisticated measurement system with a variety of probes (E-field, H-field, temperature, etc.) and a high-precision 6-axis robot positioner. The combination allows for completely automated measurement scans and evaluations with both field and position information, e.g., volume averages, peak search, and extrapolations. The main purpose is the measurement in the nearfield of radiators of highly non-isotropic fields for which the exact measurement location is critical.

Each of the numerous parameters of the many components of the dosimetric measurement system (phantom, medium, positioner, probe, electronics, measurement server, evaluation procedures) influences the measurement result.

Components of the cDASY6 System

The DASY6 system in cDASY6/DASY5 V5.2 SAR Configuration is shown below:

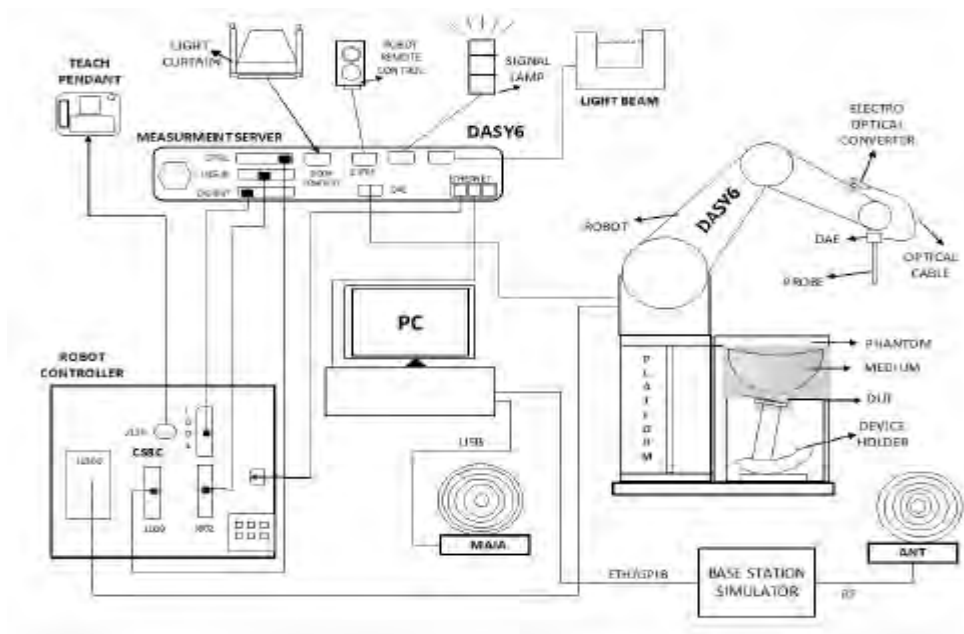

The cDASY6 system for performing compliance tests consist of the following items:

- Robot (6 Axis) & Parts
 - Controller
 - Teach Pendant
 - Signal Lamps
 - Remote Control
- Phantoms
- Platforms
- Tissue/Head Sim. Liquids
- Dielectric Measurement Kit
- DUT Holder
- Probes & Dipole Kit
- Data Acquisition Electronics (DAE)
- Measurement Server
- Light Beam Unit
- Computer & Software
- MAIA / ANT

Data Acquisition Electronics (DAE)

The data acquisition electronics (DAE) consist of a highly sensitive electrometer-grade preamplifier with auto-zeroing, a channel and gain-switching multiplexer, a fast 16-bit AD-converter, and a command decoder with a control logic unit. Transmission to the measurement server is accomplished through an optical downlink for data and status information, as well as an optical uplink for commands and the clock.

The mechanical probe mounting device includes two different sensor systems for frontal and sideways probe contacts used for mechanical surface detection and probe collision detection.

The input impedance of the DAE box is 200M Ω ; the inputs are symmetric and floating. Common mode rejection is above 80dB.



The DAE works with either two standard 9V batteries or two 9V (more precisely, 8.4V or 9.6V) rechargeable batteries. Because the electronics automatically power-down unused components during braking or between measurements, the battery lifetime depends on system usage. Typical lifetimes are >20 hours for standard and >10 hours for rechargeable batteries. Remove the batteries if you do not plan to use the DAE for a long period of time.

Probes

The DASY system can support many different probe types.

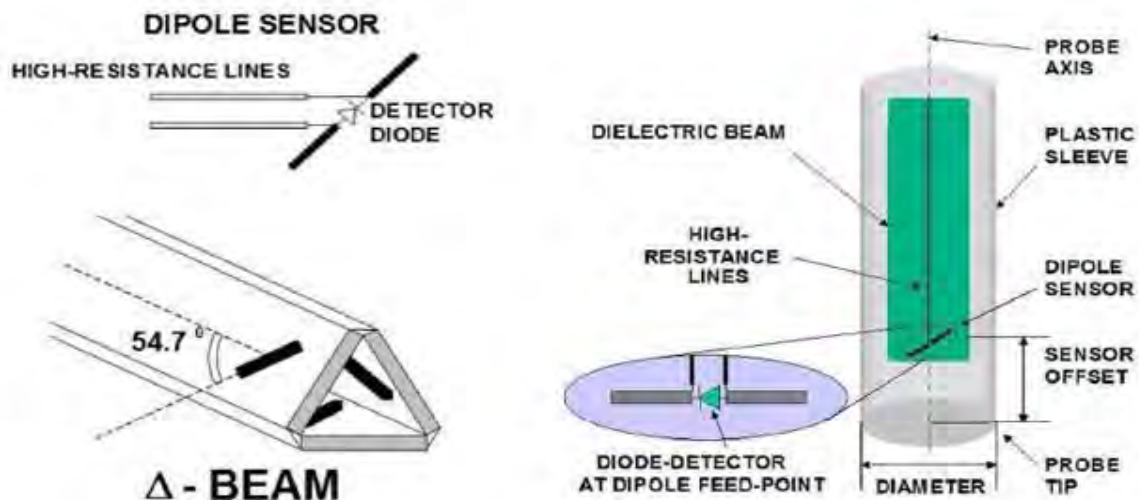

Dosimetric Probes: These probes are specially designed and calibrated for use in liquids with high permittivities. They should not be used in air, since the spherical isotropy in air is poor ($\pm 2\text{dB}$). The dosimetric probes are specially calibrated in various liquids at different frequencies.

Free-Space Probes: These are electric and magnetic field probes specially designed for measurements in free space. The z-sensor is aligned to the probe axis, and the rotation angle of the x-sensor is specified. This allows the DASY system to automatically align the probe in the measurement grid for field component measurement. The free-space probes are generally not calibrated in liquid. (The H-field probes can be used in liquids without any change to the parameters.)

Temperature Probes: These small and sensitive temperature probes for general use are based on a completely different parameter set and evaluation procedures. Temperature rise features allow direct SAR evaluations with these probes.

Audio Magnetic Probes: The AM1D probes are active probes with a single sensor each for axial and radial measurement scans as defined for audio band magnetic (ABM) signals testing in the ANSI C63.19 standard. The AM1D probe is fully RF shielded.

Teaching Probe: Teaching Probes are special probes, which are used for performing mother scans to detect and record the phantom inner surface location. These probes are mounted on special purpose DAEs, shipped along with the probes.

Probe	Freq. Range	Tip Diameter	Sensor Offset	Rec. Sensor- Phantom Dist.
ES3DV3	10 MHz-4 GHz	4.0mm	2mm	3.0mm
EX3DV3	10 MHz-6 GHz	2.5mm	1mm	1.4mm

Light-Beam Unit

The light beam switch allows automatic “tooling” of the probe. During the process, the actual position of the probe tip with respect to the robot arm, as well as the probe length and the horizontal probe offset, are measured. The software then corrects all movements within the measurement jobs, such that the robot coordinates are valid for the probe tip.



The repeatability of this process is better than 0.1mm. If a position has been taught with an aligned probe, the same position will be reached with another aligned probe within 0.1mm, even if the other probe has different dimensions. During probe rotations, the probe tip will keep its actual position.

Phantoms

SPEAG phantoms are high-quality products constructed of materials compatible with all tissue simulating liquids, including aggressive, e.g., DGBE type, solvents. The shells are constructed with a very tight tolerance of less than 0.2mm, and all parameters correspond to those requested by SAR standards. Full computer-aided design (CAD) information have been predefined in the DASY6 software, enabling fast and easy usage.



The SAM-Twin phantom (shown in front of DASY6) is a fiberglass shell phantom with shell thickness 2mm, except in the ear region where the thickness is increased to 6mm. The phantom has three measurement areas: 1) Left Head, 2) Right Head, and 3) Flat Section. For larger devices, the use of the ELI Phantom (shown behind DASY6) is required.

The ELI phantom is intended for compliance testing of handheld and body-mounted wireless devices in the frequency range of 30MHz to 6GHz. ELI has been optimized for performance and can be integrated into a SPEAG standard phantom table. A cover is provided to prevent evaporation of water and changes in liquid parameters. Reference markings on the phantom allow installation of the complete setup, including all predefined phantom positions and measurement grids, by teaching three points.

Device Holder for SAM-Twin Phantom

The SAR in the phantom is approximately inversely proportional to the square of the distance between the source and the liquid surface. For a source at 5mm distance, a positioning uncertainty of $\pm 0.5\text{mm}$ would produce uncertainty in the SAR of $\pm 20\%$. Accurate device positioning is therefore crucial for accurate and repeatable measurements. The positions at which the devices must be measured are defined by the standards.



The DASY device holder is designed to cope with the different positions described in the standard. It has two scales for device rotation (with respect to the body axis) and device inclination (with respect to the line between the ear reference points). The rotation centers for both scales is the ear reference point (ERP). Thus, the device needs no repositioning when the angles are changed. The DASY device holder is constructed of low-loss polyoxymethylene (POM) material, which has the following dielectric parameters: **relative permittivity $\epsilon=3$ and loss tangent $\delta=0.02$** . The amount of dielectric material has been reduced in the closest vicinity of the device, since measurements have suggested that the influence of the clamp on the test results could thus be lowered.

ASY6 Measurement Chain

The DASY6 dosimetric measurement system signal chain is shown in the figure below:

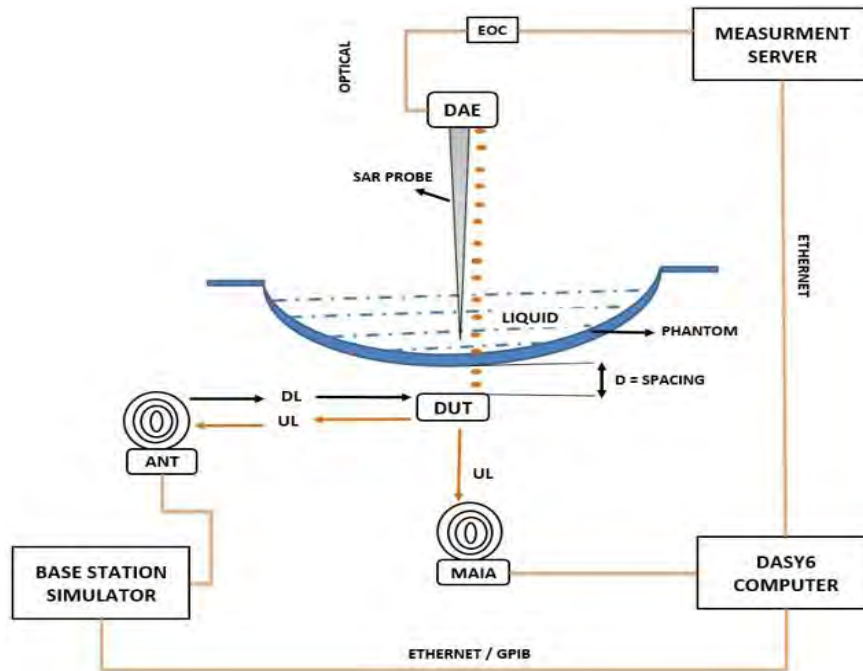

Figure 1: cDASY6 V6.4 Dosimetric Measurement System Signal Chain

The base-station simulator is controlled by the computer, to setup a specific test mode call with the device under test (DUT).

The DUT is placed in the Device Holder and held at a fixed spacing / orientation with respect to the phantom. The phantom has a fixed geometry and thickness defined by the compliance standards. The phantom is filled with liquid medium of known permittivity and conductivity.

The uplink signal transmitted by the DUT is measured inside the medium by the probe, which is accurately positioned at a precisely known distance and defined orientation with respect to the phantom surface, normal at the point by the 6-axis robot positioner.

The dipole / loop sensors at the probe tips pick up the signal and generate a voltage, which is measured by the voltmeter inside the data acquisition electronics (DAE). The DAE returns digital values, which are converted to an optical signal and transmitted via the electro-optic converter (EOC) to the measurement server (MS). The data is finally recorded in the DASY6 software.

The Modulation and Interference Analyzer (MAIA) measures the uplink signal and the cDASY6 V6.4 software calculated signal characteristics such as bandwidth, modulation frequency, etc. and matches these with the known characteristics of the test mode call parameters set up via the base-station simulator. This is important, as the probe has different calibration factors for different types of uplink signals – to obtain an accurate reading, the uplink signal must match the probe calibration factors applied.

In case of a new or unknown signal, the MAIA is used to ascertain the best match of probe calibration factors depending on the characteristics of measured signal.

The free-space E-field / H-field measurement setup is also similar. The SAR probe is replaced by the E- an/or H-field probe, while the DUT is typically placed on a plane surface. The data acquisition and signaling processing via the DAE, EOC, and MS by the DASY6 software remains the same.

Data Evaluation

The fields and SAR are calculated from the measured voltage (probe voltage acquired by the DAE) and the following parameters:

Probe Parameters	- Sensitivity	normi, ai0, ai1, ai2
	- Conversion factor	ConvFi
	- Diode compression point	dcpi
	- Probe Modulation Response Factors	ai, bi, ci, d
Device Parameter	- Frequency	f
	- Crest factor	cf
Media Parameters	- Conductivity	σ
	- Relative Permittivity	ρ

Parameters are stored in the measurement file.

Approximated Probe Response Linearization using Crest Factor

This linearization method is enabled when a custom defined communication system is measured. The compensation applied is a function of the measured voltage, the detector diode compression points and the crest factor of the measured signal.

$$V_i = U_i + U_i^2 \cdot \frac{cf}{dcp_i}$$

with	V_i	= linearized voltage of channel i (uV)	(i = x,y,z)
	U_i	= measured voltage of channel i (uV)	(i = x,y,z)
	cf	= crest factor of exciting field	(DASY parameter)
	dcp _i	= diode compression points of channel i (uV)	(Probe parameter, i = x,y,z)

The resulting linearized voltage is only approximated because the probe is not calibrated to this specific signal.

Probe Response Linearization for Specific Calibrated Communication Signals

Modern communication protocols employ complex modulation schemes and channel access techniques. probe linearization using crest factor method may lead to large measurement errors over the full dynamic range when measuring complex modulations. DASY features an advanced probe response linearization that reduces the maximal measurement error while considerably increasing the probe dynamic range.

The measured voltage is first compensated:

$$V_{comp_i} = U_i + U_i^2 \cdot \frac{10^{\frac{d}{20}}}{dcp_i}$$

With	V_{comp_i}	= compensated voltage of channel i (μV)	(i = x,y,z)
	U_i	= input voltage of channel i (μV)	(i = x,y,z)
	d	= PMR factor d (dB)	(Probe parameter)
	dcp _i	= diode compression point of channel i (μV) $\sqrt{}$	(Probe parameter, i = x,y,z)

The compensated voltage is converted in $\text{dB}\sqrt{\mu V}$:

$$V_{comp_i, \text{dB}\sqrt{\mu V}} = 10 \cdot \log_{10}(V_{comp_i})$$

A correction factor specific to the communication signal is calculated using the PMR factors:

$$CORR_i = a_i \cdot e^{-\left(\frac{V_{comp_i,dB\sqrt{\mu V}} - b_i}{c_i}\right)^2}$$

- with $CORR_i$ = correction factor of channel i (dB) (i = x,y,z)
 $V_{comp_i,dB\sqrt{\mu V}}$ = compensated voltage of channel i (dB $\sqrt{\mu V}$) (i = x,y,z)
 a_i = PMR factor a of channel i (dB) (Probe parameter, i = x,y,z)
 b_i = PMR factor b of channel i (dB $\sqrt{\mu V}$) (Probe parameter, i = x,y,z)
 c_i = PMR factor c of channel i (Probe parameter, i = x,y,z)

The voltage $V_{i,dB\sqrt{\mu V}}$ is the linearized voltage in dB $\sqrt{\mu V}$:

$$V_{i,dB\sqrt{\mu V}} = V_{comp_i,dB\sqrt{\mu V}} - CORR_i$$

- with $V_{i,dB\sqrt{\mu V}}$ = linearized voltage of channel i (dB $\sqrt{\mu V}$) (i = x,y,z)
 $V_{comp_i,dB\sqrt{\mu V}}$ = compensated voltage of channel i (dB $\sqrt{\mu V}$) (i = x,y,z)
 $CORR_i$ = correction factor of channel i (dB) (i = x,y,z)

Finally, the linearized voltage is converted in μV :

$$V_i = 10^{\frac{V_{i,dB\sqrt{\mu V}}}{10}}$$

- with V_i = linearized voltage of channel i (μV) (i = x,y,z)
 $V_{i,dB\sqrt{\mu V}}$ = linearized voltage of channel i (dB $\sqrt{\mu V}$) (i = x,y,z)

Field and SAR Calculation

The primary field data for each channel are calculated using the linearized voltage:

$$\text{E - fieldprobes : } E_i = \sqrt{\frac{V_i}{Norm_i \cdot ConvF}}$$

$$\text{H - fieldprobes : } H_i = \sqrt{V_i} \cdot \frac{a_{i0} + a_{i1}f + a_{i2}f^2}{f}$$

- with V_i = linearized voltage of channel i (i = x,y,z)
 $Norm_i$ = sensor sensitivity of channel i (i = x,y,z)
 $\mu V / (V/m)^2$ for E-field Probes
 $ConvF$ = sensitivity enhancement in solution
 a_{ij} = sensor sensitivity factors for H-field probes
 f = carrier frequency [GHz]
 E_i = electric field strength of channel i in V/m
 H_i = magnetic field strength of channel i in A/m

The RMS value of the field components gives the total field strength (Hermitian magnitude):

$$E_{tot} = \sqrt{E_x^2 + E_y^2 + E_z^2}$$

The primary field data are used to calculate the derived field units.

$$SAR = E_{tot}^2 \cdot \frac{\sigma}{\rho \cdot 1'000}$$

with SAR = local specific absorption rate in mW/g
 E_{tot} = total field strength in V/m
 σ = conductivity in [mho/m] or [Siemens/m]
 ρ = equivalent tissue density in g/cm³

Note that the density is set to 1, to account for actual head tissue density rather than the density of the tissue simulating liquid.

Dosimetric (SAR) Measurements

The procedure for assessing the peak spatial-average SAR value consists of the following steps:

- Power Reference Measurement

The reference and drift jobs are useful jobs for monitoring the power drift of the device under test in the batch process. Both jobs measure the field at a specified reference position, at a selectable distance from the phantom surface. The reference position can be either the selected section's grid reference point or a user point in this section. The reference job projects the selected point onto the phantom surface, orients the probe perpendicularly to the surface, and approaches the surface using the selected detection method.

- Area Scan

An Area Scan job is part of the compliance testing protocol of the DUT. The main goal of this job is to locate the approximate location(s) of the local peak SAR value(s). The measurement grid within an Area Scan is defined by the grid extent, grid step size and grid offset. The selection of these properties is highly dependent on the size (and position) of the DUT, frequency of operation, DUT-phantom offset and available time for the assessment. If the SAR distribution is a-priori not known, the grid extent should be such that it covers the whole area of the DUT.

- Zoom Scan

For dosimetric application, it is necessary to assess the peak spatial SAR value averaged over a volume. For this purpose, fine resolution volume scans need to be performed at the peak SAR location(s) determined during the Area Scan. A measurement grid within a zoom scan is defined by the grid extents (X,Y,Z), Offsets and Step Sizes (X,Y,Z). While step sizes in X and Y are usually a fixed value, DASY6 software permits to have a graded step size for the Z direction, for which a grading ratio can be defined. Graded grids are useful for SAR evaluations at higher frequencies (> 2GHz) as the decay rate is high and a higher number of measurements closer to the phantom surface is required to accurately extrapolate the measured values to the phantom surface.

- Power Drift measurement

The drift job measures the field at the same location as the most recent reference job within the same procedure, and with the same settings. The drift measurement gives the field difference in dB from the reading conducted within the last reference measurement. Several drift measurements are possible for one reference measurement. This allows a user to monitor the power drift of the device under test within a batch process. In the properties of the Drift job, the user can specify a limit for the drift and have OPENSAR software stop the measurements if this limit is exceeded.

SAR Measurements Scan Description

Fast Scan Description

Fast Scan is used to assess the peak spatial SAR values within a cubic averaging volume containing 1g and 10g of simulated tissue in only 10s provided the absorption pattern (antenna and frequency band). Fast Scans compare the measured pattern of a given test configuration to the ones measured previously. If a similar pattern shape (matching configuration) is found, a scaling factor defined as difference in amplitude of the two configurations is computed. The Area and Zoom Scans results available for the matching configuration are then scaled to assess the 1g and 10g SAR of the measured configuration.

Grid Settings

The grid extents used for Fast Scans are the same as for Area Scans.

Area Scan Description

Area Scans are used to determine the peak location of the measured field before doing a finer measurement around the hotspot. Area Scans measure a two-dimensional volume covering the full device under test area. cDASY6 V6.4 uses Fast Averaged SAR algorithm to compute the 1g and 10g of simulated tissue from the Area Scan.

Grid Settings

Automated Grid Settings

cDASY6 V6.4 automatically generates Area Scan grid settings based on device dimensions. The scan extent is defined by the device dimensions plus additional 15mm on each side.

For Flat phantom sections both the device under test and the area scan are centered around the phantom device reference point. For Left Head and Right Head phantom sections, Area Scans are anchored to the ERP (Ear Reference Point) and oriented along the Ear Mouth line. The device under test position on this line is given by the speaker position which is always placed at the ERP. The scans extents are defined by the device height and width increased by 15mm on each side.

Figure 1 shows a typical area scan grid for Flat and Left Head phantom sections.

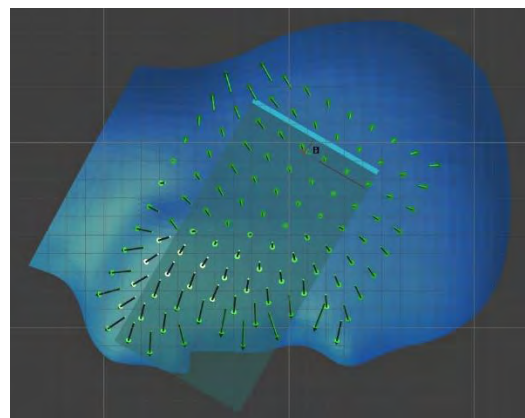
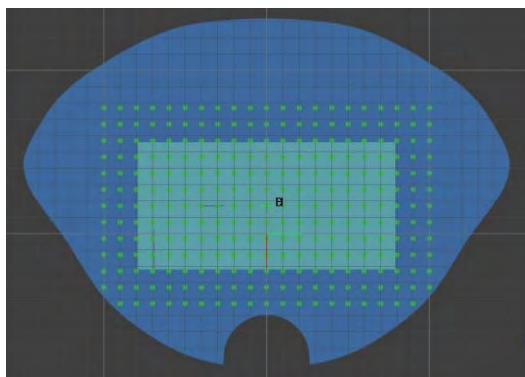

- (a) Flat Phantom Section
- (b) Left Head Phantom Section

Figure 1: Measurement Grid for Area Scans

Table 1 describes the Area Scan grid extents used in Flat, Left Head and Right Head phantom sections.

Section	Position	Extent X [mm]	Extent Y [mm]
Flat	TOP (SCREEN)	Width + 30	Height + 30
Flat	BOTTOM (COVER)	Width + 30	Height + 30
Flat	EDGE TOP	Thickness + 30	Width + 30
Flat	EDGE BOTTOM	Thickness + 30	Width + 30
Flat	EDGE LEFT	Thickness + 30	Height + 30
Flat	EDGE RIGHT	Thickness + 30	Height + 30
LEFT / RIGHT HEAD	CHEEK	Width + 30	Height + 30
LEFT / RIGHT HEAD	TILT	Width + 30	Height + 30

Table 1: Area Scan Grid Extents in Flat, Left Head and Right Head Phantom Sections

Area Scan grid steps and sensor distance to surface are defined in Table 2.

f [GHz]	d sensor-surface [mm]	Step X, Y [mm]
0 - 2	3	14
2 - 3	3	14
3 - 4	3	10
4 - 6	3	10

Table 2: Area Scan Grid Settings in Flat Phantom Sections

User defined Grid Settings

In cDASY6 V6.4 user defined grid settings can be applied as well. In the scan properties of the measurement the grid extent, grid step and grid offset can be changed after changing the default selection 'DUT dimensions + 15 mm' to 'User defined' see figure 2. and figure 3.

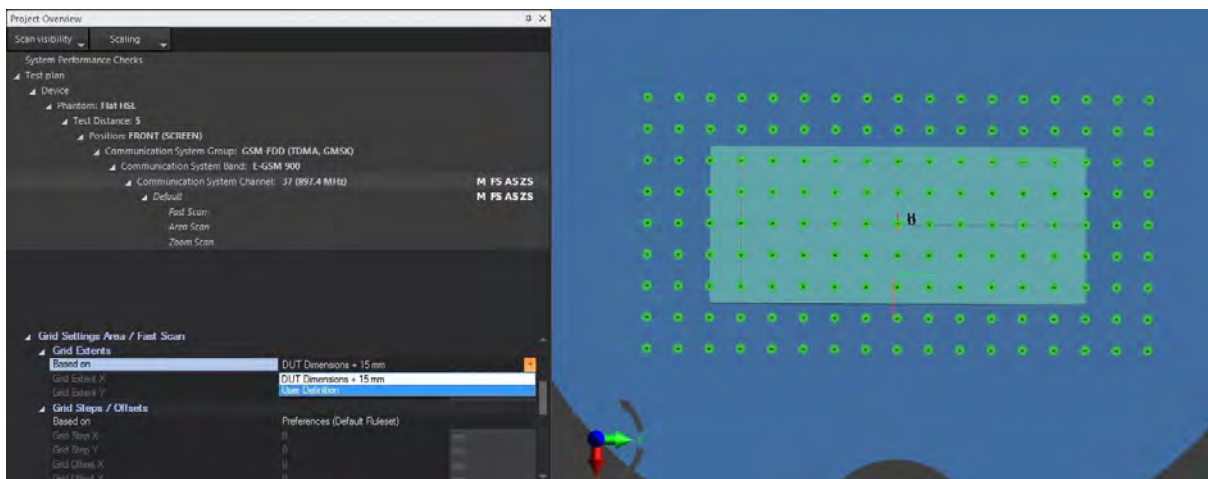

Figure 2: Default grid settings based on DUT dimensions.

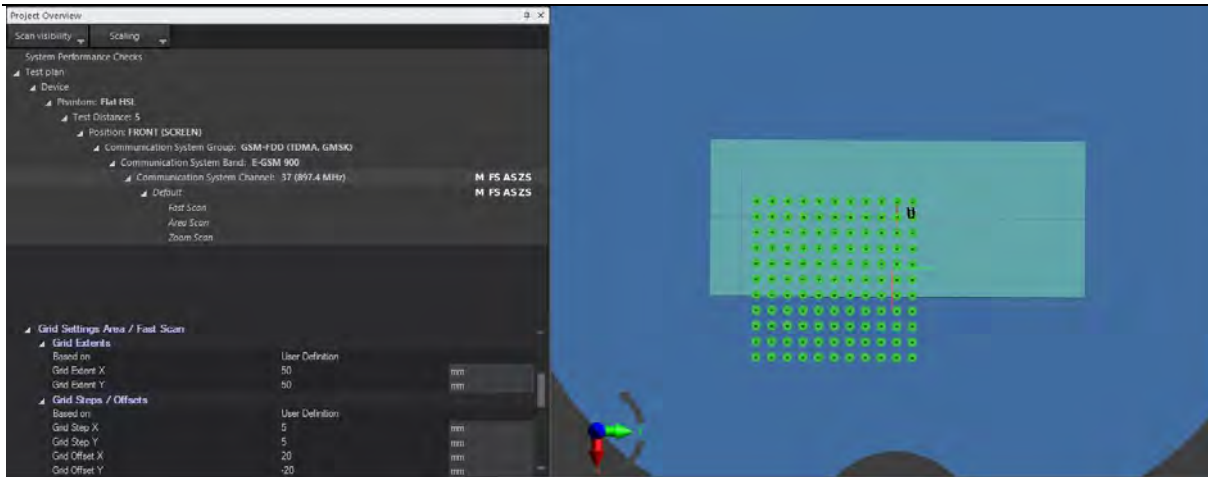

Figure 3: Grid settings as specified by the user.

Special Case of Specialized Phantoms

For Headstand and Facedown phantoms, the DUT can't be defined using a simple brick shape. Also, the transmitting might operate in any area of the head. For these phantoms, cDASY6 V6.4 features a tool to easily define the measurable area: the user can directly draw the grid on the 3D view by defining a tetragonal with 4 points. Due to the geometry of the phantom, no area scan is performed in the Forearm phantom.

Zoom Scan Description

Zoom scans are used to assess the peak spatial SAR values within a cubic averaging volume containing 1g and 10g of simulated tissue. Zoom scans measure a three-dimensional volume (cube). The bottom face of the cube is centered on the maximum of the preceding Area Scan in the same measurement group. For maxima at border of the phantom, auto extend zoom scan when maxima on boundary feature can be enabled in Application Preferences Scan Settings with Administrator access level.

Grid Settings

Automated Grid Settings

Zoom Scans are always anchored to the peak location of the preceding Area Scan. The sensor distance to the surface depends on the probe type used during measurement: 1.4mm for EX probes and 3mm for ES probes. Table 3 describes the grid settings used for Zoom Scans in Flat phantom sections.

f [GHz]	Extend XYZ [mm]	Step XY [mm]	Step Z [mm]	Graded	Grading Ratio [mm]
0 - 2	30 x 30 x 30	6	6	No	-
2 - 3	30 x 30 x 30	6	6	No	-
3 - 4	22 x 22 x 22	4	1.8	Yes	1.4
4 - 6	22 x 22 x 22	4	1.4	Yes	1.4

Table 3: Zoom Scan Grid Settings in Flat, Left Head and Right Head Phantom Sections

User defined Grid Settings

Similar like for Area Scans the grid settings for Zoom Scans can be customized. After selecting the 'User Defined' option, Grid extent x,y,z, grid step x,y,z as well as Graded grid and Grading ratio can be set by the user.

Power Monitoring Scan

Power monitoring scans are used to monitor the power drift of the device under test. The local SAR strength is measured at a reference position at the beginning and at the end of the scan. The power drift is computed using the formula:

$$P_{drift}[dB] = 10 \cdot \log_{10} \frac{SAR_{beginning}}{SAR_{end}}$$

Power monitoring scans are available for fully integrated in Area and Zoom Scans. They can be enabled in Application Preferences Scan Settings. For Area Scans, the reference point is defined as the maximum location of the preceding Fast Scan. A Fast Scan will be automatically performed if none has been performed and power monitoring is enabled. For Zoom Scans, it is defined at the first point of the measured grid.

Check Scan

The Check Scan is used for system check purpose only and consists of a standard Zoom Scan (30x30x30mm) and a 1D Rotation Scan. The 1D Rotation Scan is anchored to the interpolated maximum of the preceding Zoom Scan. The extrapolated peak SAR value is extracted above the dipole center.

Validation Scan

The Validation Scan is used for system validation purpose only and consists of an extended Zoom Scan (50x30x30mm) and a 1D Rotation Scan. The 1D Rotation Scan is anchored to the interpolated maximum of the preceding Zoom Scan. The extrapolated peak SAR values are extracted above the dipole center and at 20mm transverse offset from the Zoom Scan.

Time Averaged SAR Scan

Time Averaged SAR applies to devices which can monitor and control the time averaged transmitted power in real-time over the period define in the applicable standards.

DUT Stability Scan

The DUT Stability Scan is used to measure the stability of the transmitting device power. This scan can be enabled in the scan properties at the bottom of the project overview window. The user specifies also the scan duration and the measurement interval (time between 2 measurement points). In case the measurement interval is set to 0, measurement points will be acquired continuously.

One measurement point corresponds to measurement samples averaged over the integration time specified in Application Preferences Scan Settings. For instance, if the measurement interval is 5s and the integration time 0.5s, a measurement point will be acquired every 5s. This measurement point corresponds to instantaneous SAR readings averaged over 0.5s. The result shows the DUT power drift in %.

$$SAR_{drift(\%)} = 100 \cdot \left(\frac{SAR_{max} - SAR_{min}}{SAR_{avg}} - \right)$$

$SAR_{drift(\%)}$ is the SAR drift over the measured period in %

SAR_{min} is the minimum measured SAR value

SAR_{max} is the maximum measured SAR value

SAR_{avg} is the SAR value averaged over all measurement points

Device Reference Points

Definition of Reference Points

Ear Reference Point

Figure 6.2 shows the front, back and side views of the SAM Phantom. The point "M" is the reference point for the center of the mouth, "LE" is the left ear reference point (ERP), and "RE" is the right ERP. The ERPs are 15mm posterior to the entrance to the ear canal (EEC) along the B-M line (Back-Mouth), as shown in Figure 6.1. The plane passing through the two ear canals and M is defined as the Reference Plane. The line N-F (Neck-Front) is perpendicular to the reference plane and passing through the RE (or LE) is called the Reference Pivoting Line (see Figure 6.1). Line B-M is perpendicular to the N-F line. Both N-F and B-M lines are marked on the external phantom shell to facilitate handset positioning [5].

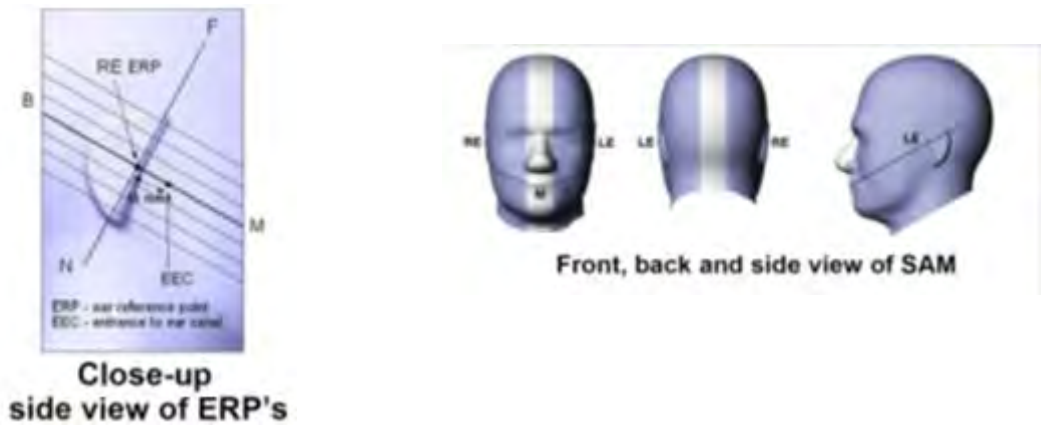

Two imaginary lines on the device need to be established: the vertical centerline and the horizontal line. The test device is placed in a normal operating position with the "test device reference point" located along the "vertical centerline" on the front of the device aligned to the "ear reference point" (See Fig. 6.3). The "test device reference point" is then located at the same level as the center of the ear reference point. The test device is positioned so that the "vertical centerline" is bisecting the front surface of the device at its top and bottom edges, positioning the "ear reference point" on the outer surface of both the left and right head phantoms on the ear reference point.

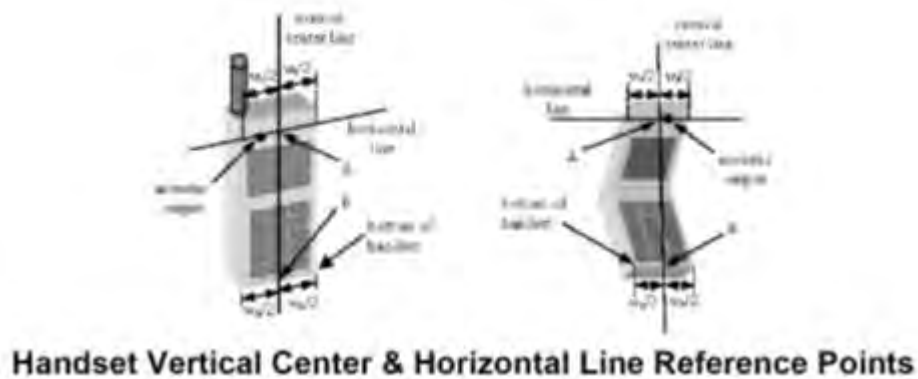

Test Configuration – Positioning for Cheek / Touch

1. Position the device close to the surface of the phantom such that point A is on the (virtual) extension of the line passing through points RE and LE on the phantom (see Figure below), such that the plane defined by the vertical center line and the horizontal line of the device is approximately parallel to the sagittal plane of the phantom



Front, Side and Top View of Cheek/Touch Position

2. Translate the device towards the phantom along the line passing through RE and LE until the device touches the ear.
3. While maintaining the device in this plane, rotate it around the LE-RE line until the vertical centerline is in the plane normal to MB-NF including the line MB (called the reference plane).
4. Rotate the device around the vertical centerline until the device (horizontal line) is symmetrical with respect to the line NF.
5. While maintaining the vertical centerline in the reference plane, keeping point A on the line passing through RE and LE and maintaining the device contact with the ear, rotate the device about the line NF until any point on the device is in contact with a phantom point below the ear (cheek). See Figure below.

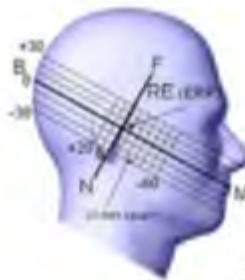

Side view w/ relevant markings

Test Configuration – Positioning for Ear / 15° Tilt

With the test device aligned in the Cheek/Touch Position”:

1. While maintaining the orientation of the device, retract the device parallel to the reference plane far enough to enable a rotation of the device by 15 degrees.
2. Rotate the device around the horizontal line by 15 degrees.

3. While maintaining the orientation of the device, move the device parallel to the reference plane until any part of the device touches the head. (In this position, point A is located on the line RE-LE). The tilted position is obtained when the contact is on the pinna. If the contact is at any location other than the pinna, the angle of the device shall be reduced. The tilted position is obtained when any part of the device is in contact with the ear as well as a second part of the device is in contact with the head (see Figure below).

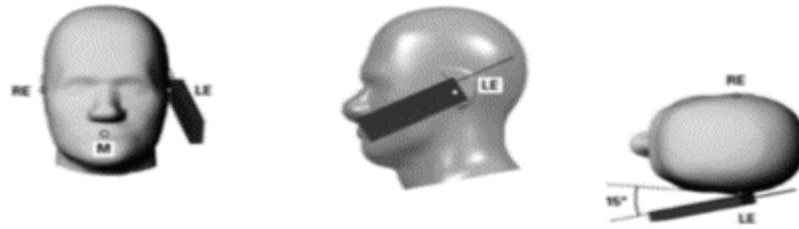

Front, Side and Top View of Ear/15° Tilt Position

Test

Position

– Body Worn Configurations

Body-worn operating configurations are tested with the accessories attached to the device and positioned against a flat phantom in a normal use configuration. A device with a headset output is tested with a headset connected to the device. Body dielectric parameters are used.

Accessories for Body-worn operation configurations are divided into two categories: those that do not contain metallic components and those that do contain metallic components. When multiple accessories that do not contain metallic components are supplied with the device, the device is tested with only the accessory that dictates the closest spacing to the body. Then, when multiple accessories that contain metallic components are supplied with the device, the device is tested with each accessory that contains a unique metallic component. If multiple accessories share an identical metallic component (i.e. the same metallic belt-clip used with different holsters with no other metallic components) only the accessory that dictates the closest spacing to the body is tested.

Body-worn accessories may not always be supplied or available as options for some devices intended to be authorized for body-worn use. In this case, a test configuration where a separation distance between the back of the device and the flat phantom is used. All test position spacing are documented.

Transmitters that are designed to operate in front of a person's face, as in push-to-talk configurations, are tested for SAR compliance with the front of the device positioned to face the flat phantom. For devices that are carried next to the body such as a shoulder, waist or chest-worn transmitters, SAR compliance is tested with the accessory(ies), including headsets and microphones, attached to the device and positioned against a flat phantom in a normal use configuration.

In all cases SAR measurements are performed to investigate the worst-case positioning. Worst-case positioning is then documented and used to perform Body SAR testing.



11 Measurement Uncertainty

The component of uncertainty may generally be categorized according to the methods used to evaluate them. The evaluation of uncertainty by the statistical analysis of a series of observations is termed a Type A evaluation of uncertainty. The evaluation of uncertainty by means other than the statistical analysis of a series of observation is termed a Type B evaluation of uncertainty. Each component of uncertainty, however evaluated, is represented by an estimated standard deviation, termed standard uncertainty, which is determined by the positive square root of the estimated variance

A Type A evaluation of standard uncertainty may be based on any valid statistical method for treating data. This includes calculating the standard deviation of the mean of a series of independent observations; using the method of least squares to fit a curve to the data to estimate the parameter of the curve and their standard deviations; or carrying out an analysis of variance in order to identify and quantify random effects in certain kinds of measurement.

A type B evaluation of standard uncertainty is typically based on scientific judgment using all the relevant information available. These may include previous measurement data, experience and specification, data provided in calibration reports and uncertainties assigned to reference data taken from handbooks. Broadly speaking, the uncertainty is either obtained from an outdoor source or obtained from an assumed distribution, such as the normal distribution, rectangular or triangular distributions indicated in Table below:

Uncertainty Distribution	Normal	Rectangle	Triangular	U Shape
Multi-plying Factor ^(a)	1/k ^(b)	$1 / \sqrt{3}$	$1 / \sqrt{6}$	$1 / \sqrt{2}$

(a) Standard uncertainty is determined as the product of the multiplying factor and the estimated range of variations in the measured quantity

(b) K is the coverage factor

Standard Uncertainty for Assumed Distribution

The combined standard uncertainty of the measurement result represents the estimated standard deviation of the result. It is obtained by combining the individual standard uncertainties of both Type A and Type B -sum-by taking the positive square root of the estimated variances.

Expanded uncertainty is a measure of uncertainty that defines an interval about the measurement result within which the measured value is confidently believed to lie. It is obtained by multiplying the combined standard uncertainty by a coverage factor. Typically, the coverage factor ranges from 2 to 3. Using a coverage factor allows the true value of a measured quantity to be specified with a defined probability within the specified uncertainty range. For purpose of this document, a coverage factor two is used, which corresponds to confidence interval of about 95 %.

DASY6 Uncertainty Budget is show in below table:

DASY6 Uncertainty Budget (Hand-Held: 0.3 - 3GHz range)								
Error Description	Uncert. value	Prob. Dist.	Div.	(c) 1g	(c) 10g	Std. Unc. (1g)	Std. Unc. (10g)	(v) veff
Measurement System								
Probe Calibration	±6.0%	N	1	1	1	±6.0%	±6.0%	∞
Axial Isotropy	±4.7%	R	√3	0	0	±0.0%	±0.0%	∞
Hemispherical Isotropy	±9.6%	R	√3	1	1	±5.5%	±5.5%	∞
Boundary Effects	±0.0%	R	√3	1	1	±0.0%	±0.0%	∞
Linearity	±4.7%	R	√3	1	1	±2.7%	±2.7%	∞
System Detection Limits	±1.0%	R	√3	1	1	±0.6%	±0.6%	∞
Modulation Response ^m	±2.4%	R	√3	1	1	±1.4%	±1.4%	∞
Readout Electronics	±0.3%	N	1	1	1	±0.3%	±0.3%	∞
Response Time	±0.8%	R	√3	1	1	±0.5%	±0.5%	∞
Integration Time	±2.6%	R	√3	1	1	±1.5%	±1.5%	∞
RF Ambient Noise	±3.0%	R	√3	1	1	±1.7%	±1.7%	∞
RF Ambient Reflections	±3.0%	R	√3	1	1	±1.7%	±1.7%	∞
Probe Positioner	±0.02%	R	√3	1	1	±0.0%	±0.0%	∞
Probe Positioning	±2.9%	R	√3	1	1	±1.6%	±1.6%	∞
Max. SAR Eval.	±15.0%	R	√3	1	1	±8.7%	±8.7%	∞
Test Sample Related								
Device Positioning	±2.9%	N	1	1	1	±2.9%	±2.9%	145
Device Holder	±3.6%	N	1	1	1	±3.6%	±3.6%	5
Power Drift	±5.0%	R	√3	1	1	±2.9%	±2.9%	∞
Power Scaling ^p	±0%	R	√3	1	1	±0.0%	±0.0%	∞
Phantom and Setup								
Phantom Uncertainty	±6.1%	R	√3	1	1	±3.5%	±3.5%	∞
SAR Correction	±1.9%	N	1	1	0.84	±1.9%	±1.6%	∞
Liquid Conductivity (mea.) ^{DAK}	±2.5%	N	1	0.78	0.71	±2.0%	±1.8%	∞
Liquid Permittivity (mea.) ^{DAK}	±2.5%	N	1	0.23	0.26	±0.6%	±0.7%	∞
Temp. unc. - Conductivity ^{BB}	±3.4%	R	√3	0.78	0.71	±1.5%	±1.4%	∞
Temp. unc. - Permittivity ^{BB}	±0.4%	R	√3	0.23	0.26	±0.1%	±0.1%	∞
Combined Std. Uncertainty						±14.7%	±14.6%	1329
Expanded STD Uncertainty						±29.3%	±29.2%	

DASY6 Uncertainty Budget (Hand-Held: 3 - 6GHz range)								
Error Description	Uncert. value	Prob. Dist.	Div.	(c) 1g	(c) 10g	Std. Unc. (1g)	Std. Unc. (10g)	(v) veff
Measurement System								
Probe Calibration	±6.55%	N	1	1	1	±6.55%	±6.55%	∞
Axial Isotropy	±4.7%	R	√3	0	0	±0.0%	±0.0%	∞
Hemispherical Isotropy	±9.6%	R	√3	1	1	±5.5%	±5.5%	∞
Boundary Effects	±0.0%	R	√3	1	1	±0.0%	±0.0%	∞
Linearity	±4.7%	R	√3	1	1	±2.7%	±2.7%	∞
System Detection Limits	±1.0%	R	√3	1	1	±0.6%	±0.6%	∞
Modulation Response ^m	±2.4%	R	√3	1	1	±1.4%	±1.4%	∞
Readout Electronics	±0.3%	N	1	1	1	±0.3%	±0.3%	∞
Response Time	±0.8%	R	√3	1	1	±0.5%	±0.5%	∞
Integration Time	±2.6%	R	√3	1	1	±1.5%	±1.5%	∞
RF Ambient Noise	±3.0%	R	√3	1	1	±1.7%	±1.7%	∞
RF Ambient Reflections	±3.0%	R	√3	1	1	±1.7%	±1.7%	∞
Probe Positioner	±0.04%	R	√3	1	1	±0.0%	±0.0%	∞
Probe Positioning	±6.7%	R	√3	1	1	±3.8%	±3.8%	∞
Max. SAR Eval.	±12.0%	R	√3	1	1	±6.9%	±6.9%	∞
Test Sample Related								
Device Positioning	±2.9%	N	1	1	1	±2.9%	±2.9%	145
Device Holder	±3.6%	N	1	1	1	±3.6%	±3.6%	5
Power Drift	±5.0%	R	√3	1	1	±2.9%	±2.9%	∞
Power Scaling ^p	±0%	R	√3	1	1	±0.0%	±0.0%	∞
Phantom and Setup								
Phantom Uncertainty	±6.6%	R	√3	1	1	±3.8%	±3.8%	∞
SAR Correction	±1.9%	N	1	1	0.84	±1.9%	±1.6%	∞
Liquid Conductivity (mea.) ^{DAK}	±2.5%	N	1	0.78	0.71	±2.0%	±1.8%	∞
Liquid Permittivity (mea.) ^{DAK}	±2.5%	N	1	0.23	0.26	±0.6%	±0.7%	∞
Temp. unc. - Conductivity ^{BB}	±3.4%	R	√3	0.78	0.71	±1.5%	±1.4%	∞
Temp. unc. - Permittivity ^{BB}	±0.4%	R	√3	0.23	0.26	±0.1%	±0.1%	∞
Combined Std. Uncertainty						±14.5%	±14.4%	1256
Expanded STD Uncertainty						±28.9%	±28.8%	

12 Liquid Validation

Setup for Liquid Measurement

The dielectric parameters were checked prior to assessment using the dielectric probe kit. The dielectric parameters measured are reported in each correspondent section.

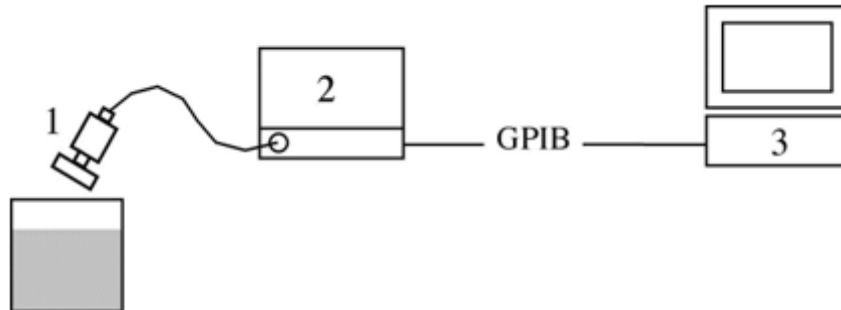

1. Dielectric Probe Kit
2. Network Analyzer (e.g. Rohde & Schwartz ZVx series, Anritsu MSx, Agilent 8753)
 - Frequency range in accordance with planned test frequencies (≥ 300 to 6000MHz) - **frequency resolution $\geq 1\text{kHz}$**
 - Source Amplitude 0 10dBm
 - Amplitude Resolution $\leq 0.02\text{dB}$**
 - Port Isolation $\leq 40\text{dB}$**
 - Phase Stability $< 1^\circ$
 - Phase Resolution $\leq 0.1^\circ$**
3. PC with GPIB Controller

Liquid Dielectric Parameters

The tissue dielectric parameters used in SAR tests should not exceed $\pm 5.0\%$ of those specified in the standard. Deviations of the tissue dielectric parameters from the target values, and dielectric measurement uncertainties, can lead to different SAR distributions in the phantom. The peak SAR location and the corresponding SAR distribution may also shift due to phantom shell surface variations. The measurement procedures use vector network analyzers and dielectric probe kits, like the open-end coaxial probe DAK 3.5mm, for dielectric property measurements. The tolerance ($k=1$), deriving from inaccuracies in the calibration data, analyzer drift, and random errors, are usually $\pm 2.5\%$ and $\pm 5\%$ (normal distribution) for measured permittivity and conductivity, respectively. With the DAK (dielectric assessment kit) of SPEAG, the tolerance for both permittivity, as well as, conductivity can be reduced to $\pm 2.5\%$ ($k=1$, normal distribution).

The standard requires that SAR measurements are conducted within 18°C and 25°C as well as within $\pm 2^\circ\text{C}$ of the temperature at which the dielectric parameters were measured.

IEEE SCC-34/SC-2 P1528 recommended Tissue Dielectric Parameters

The head tissue dielectric parameters recommended by the IEEE SCC-34/SC-2 in P1528 have been incorporated in the following table. These head parameters are derived from planar layer models simulating the highest expected SAR for the dielectric properties and tissue thickness variations in a human head. Other head and body tissue parameters that have not been specified in P1528 are derived from the tissue dielectric parameters computed from the 4-Cole-Cole equations and extrapolated according to the head parameters specified in P1528

Target Frequency MHz	Head		Body	
	ϵ_r	σ (S/m)	ϵ_r	σ (S/m)
150	52.3	0.76	61.9	0.80
300	45.3	0.87	58.2	0.92
450	43.5	0.87	56.7	0.94
835	41.5	0.90	53.19	0.97
900	41.5	0.97	55.0	1.05
915	41.5	0.98	55.0	1.06
1450	40.5	1.20	54.0	1.30
1610	40.3	1.29	53.8	1.40
1800-2000	40.0	1.40	53.3	1.52
2450	39.2	1.80	52.7	1.95
3000	38.5	2.40	52.0	2.73
5800	35.3	5.27	48.2	6.00

Note: ϵ_r = relative permittivity, σ = conductivity and $\rho = 1000 \text{ kg/m}^3$

Liquid Validation Result:

Liquid type/Band(MHz)	Measured Date	Parameters	Measured	Target	Deviation (%)	Limit (%)
2450 Body	04/23/2018	Permittivity	53.20	52.7	0.9	±5.00
		Conductivity	2.02	1.95	3.6	±5.00
5200 Body	04/23/2018	Permittivity	48.20	49.0	-1.7	±5.00
		Conductivity	5.40	5.30	1.9	±5.00
5600 Body	04/23/2018	Permittivity	47.40	48.50	-2.3	±5.00
		Conductivity	5.99	5.77	3.7	±5.00
5800 Body	04/23/2018	Permittivity	47.00	48.20	-2.6	±5.00
		Conductivity	6.29	6.00	4.8	±5.00

13 SAR System Verification

System Verification

The relative permittivity and conductivity of the test liquid should be measured before the system verification and the measured liquid parameters must be entered in the DASY6 software. If the measured values differ from the target liquid parameters in the corresponding standards for testing compliance, the liquid composition should be adjusted. If the system verification is performed with slightly different (measured) liquid parameters, the expected SAR will also be different.

The reference dipole source must be placed beneath the flat phantom or the flat section of the SAM Twin Phantom with the correct distance spacer in place. The distance spacer should touch the phantom surface with a light pressure at the reference marking (little cross) and be oriented parallel to the long side of the phantom. Accurate positioning is not necessary, since the system will search for the peak SAR location, except that the dipole arms should be parallel to the surface. The device holder for mobile phones can be left in place but should be rotated away from the dipole.

The forward power into the reference dipole source at the SMA connector should be determined as accurately as possible. The following section describe the recommended setup to measure the dipole input power. The actual dipole input power level can be between 20mW and several watts. The result can later be normalized to any power level. It is strongly recommended to note the actual power level used; otherwise this crucial information for later reference is lost.

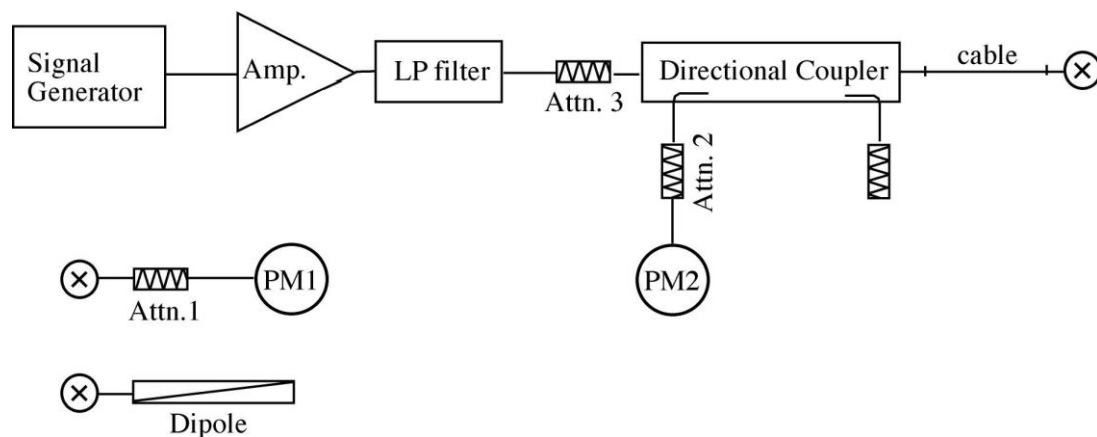

The figure shows the recommended setup. The PM1 (incl. Att1) measures the forward power at the end of the cable where the dipole would be connected. The signal generator is adjusted for the desired forward power at the dipole connector and the power meter PM2 is read at that level. After connecting the cable to the dipole, the signal generator is readjusted for the same reading at power meter PM2. If the signal generator does not allow a setting in 0.01dB steps, the remaining difference at PM2 must be noted and considered in the normalization of the system check results.

System Verification Results (Body)

Test Date	Test Condition		Freq. (MHz)	Target (W/kg)	Input Power (dBm)	Measured (W/kg)	1W Normalized SAR10g (W/kg)	Delta (%)	Limit (%)
04/23/2018	Temp (°C)	23	2450	52.40	20	5.430	54.30	3.60	±10.00
	Humidity (%)	58							
	ATM (mbar)	1011							
04/23/2018	Temp (°C)	23	5200	159.00	20	15.886	158.86	-0.09	±10.00
	Humidity (%)	58							
	ATM (mbar)	1011							
04/23/2018	Temp (°C)	23	5400	166.40	20	16.776	167.76	0.82	±10.00
	Humidity (%)	58							
	ATM (mbar)	1011							
04/23/2018	Temp (°C)	23	5600	173.80	20	17.671	176.71	1.68	±10.00
	Humidity (%)	58							
	ATM (mbar)	1011							
04/23/2018	Temp (°C)	23	5800	181.20	20	18.536	185.36	2.30	±10.00
	Humidity (%)	58							
	ATM (mbar)	1011							

System Check

The system check procedure is a complete 1g and 10g peak spatial-average SAR measurement using a source having a previously determined system check target value. The measured 1g and 10g SAR are normalized to the target input power of the specific source and compared to their respective target values.

A description of the different measurement tasks to be performed is given below, together with the information that can be deduced from their results:

- The Power Reference Measurement and Power Drift Measurement are located at the beginning and end of the batch process. They measure the field drift at one single point in the liquid over the complete procedure. The indicated drift is mainly the variation of the amplifier output power. If it is too high (above ±0.1dB), the system check should be repeated; some amplifiers have very high drift during warm-up. A stable amplifier gives drift results in the DASY6 system below ±0.02dB.
- The second step is optional. For probes with integrated optical surface detection sensor this step must be conducted, otherwise the step can be skipped. The Surface Check tests the optical surface detection system of the DASY6 system by repeatedly detecting the surface with the optical and mechanical surface detector and comparing the results. The output gives the detecting heights of both systems, the difference between the two systems and the standard deviation of the detection repeatability. Air bubbles or refraction in the liquid due to separation of the sugar-water mixture gives poor repeatability (above ±0.1mm). In that case it is better to abort the system check and stir the liquid.
- The Area Scan measures the SAR above the dipole on a plane parallel to the surface. It is used to locate the approximate location of the peak SAR. The proposed scan uses large grid spacing for faster measurement; due to the symmetric field, the peak detection is reliable. If a finer graphic is desired, the grid spacing can be reduced. Grid spacing, and orientation have no influence on the SAR result.
- The Zoom Scan measures the field in a volume around the peak SAR value assessed in the previous Area Scan

If the system check gives reasonable results, the SAR peak, 1g and 10g spatial average SAR values normalized to 1W dipole input power give reference data for comparisons. The next sections analyze the expected uncertainties of these values, as well as additional checks for further information or troubleshooting.

System Validation

System validation is used for verifying the accuracy of a complete measurement system, and accuracy of the software and control algorithms used for a single or group of SAR measurements. The procedure consists of up to 6 steps:

- SAR Evaluation: A complete 1g and 10g peak spatial-average SAR measurement is performed using the System Check procedure.
- Extrapolation Routine: Local SAR values are measured along a vertical axis directly above the center line of the dipole. Additionally, this measurement is repeated along another vertical axis with a 2cm transverse offset from the dipole feed point. The measured values are extrapolated to the phantom surface and compared to the numerical target values.
- Probe Linearity for CW-equivalent Signals: SAR evaluation is repeated at different input power levels. The power levels are selected to produce a 1g spatial-average SAR values of approximately 10W/kg, 2W/kg, 0.4W/kg, and 0.12W/kg. The linearity is evaluated by comparing the SAR values normalized to the target input power.
- Probe Linearity for Periodic Pulse-Modulated Signals: Step A is repeated with periodic pulse-modulated signals having a duty factor of 0.1 and pulse repetition rate of 10 Hz. The power is adjusted to produce a 1 g peak spatial-average SAR of approximately 8 W/kg. The measured SAR values are normalized to the target input power and compared to the results of SAR Evaluation.
- Probe Linearity for Digital Modulations with Random Amplitude and Phase Characteristics: Probe Linearity for Periodic Pulse-Modulated Signals is repeated with the specific modulations that will be tested by the laboratory.
- Probe Axial Isotropy: The probe is rotated around its Z axis in steps of 15. The maximum and minimum recorded SAR values are used to compute the probe isotropy error. The novel calibration procedures PMR/SMC of SPEAG warranty the linear response for any calibrated communication system. We believe that validation is required only for non-calibrated signals or if probes are used outside the calibrated voltage range.

Target and measurement SAR after Normalized

System Validation Status

Frequency (MHz)	Temp (°C)	Humidity (%)	Validation Date	Probe SN	Validation Cycle	Validation Due
835	23	58	02/01/2018	EX3DV4 - SN7469	1 year	02/01/2019
900	23	58	02/01/2018	EX3DV4 - SN7469	1 year	02/01/2019
1800	23	58	02/01/2018	EX3DV4 - SN7469	1 year	02/01/2019
1900	23	58	02/01/2018	EX3DV4 - SN7469	1 year	02/01/2019
2000	23	58	02/01/2018	EX3DV4 - SN7469	1 year	02/01/2019
2450	23	58	02/01/2018	EX3DV4 - SN7469	1 year	02/01/2019
5200	23	58	02/01/2018	EX3DV4 - SN7469	1 year	02/01/2019
5400	23	58	02/01/2018	EX3DV4 - SN7469	1 year	02/01/2019
5600	23	58	02/01/2018	EX3DV4 - SN7469	1 year	02/01/2019
5800	23	58	02/01/2018	EX3DV4 - SN7469	1 year	02/01/2019

14 Output Power Measurement Results

Requirement(s):

Spec	Item	Requirement	Applicable
-	-	Time averaged conducted output power to be measured	<input checked="" type="checkbox"/>
Test Setup			
Test Procedure	<p><u>Measurement using an Average Power Meter (PM)</u></p> <p>Measurements may be performed using a wideband gated RF power meter provided that the gate parameters are adjusted such that the power is measured only when the EUT is transmitting at its maximum power control level. Since the measurement is made only during the ON time of the transmitter, no duty cycle correction factor is required.</p> <ul style="list-style-type: none"> - Connect EUT's RF output power to power meter - Set EUT to be continuous transmission mode - Measurement the average output power using power meter and record the result <p>Repeat above steps for different test channel and other modulation type.</p>		
Test Date	04/23/2018	Environmental condition	Temperature 22°C Relative Humidity 55% Atmospheric Pressure 1008mbar
Remark	-		
Result	<input checked="" type="checkbox"/> Pass <input type="checkbox"/> Fail		

Test Data Yes N/A

Test Plot Yes N/A

Output Power measurement result

802.11b - 2.4GHz

Mode	Frequency (MHz)	Measured Power (dBm)	Declared (dBm)	Tune-up Low (dBm)	Tune-up High (dBm)
802.11b	2412	15.87	16	15	17
802.11b	2437	15.79	16	15	17
802.11b	2462	15.78	16	15	17

802.11g - 2.4GHz

Mode	Frequency (MHz)	Measured Power (dBm)	Declared (dBm)	Tune-up Low (dBm)	Tune-up High (dBm)
802.11g	2412	12.75	13	12	14
802.11g	2437	12.79	13	12	14
802.11g	2462	12.66	13	12	14

802.11HT20 – 2.4GHz

Mode	Frequency (MHz)	Measured Power (dBm)	Declared (dBm)	Tune-up Low (dBm)	Tune-up High (dBm)
802.11n-20M	2412	12.48	13	12	14
802.11n-20M	2437	12.67	13	12	14
802.11n-20M	2462	12.74	13	12	14

802.11HT40 – 2.4GHz

Mode	Frequency (MHz)	Measured Power (dBm)	Declared (dBm)	Tune-up Low (dBm)	Tune-up High (dBm)
802.11n-40M	2422	12.61	13	12	14
802.11n-40M	2437	12.57	13	12	14
802.11n-40M	2452	12.68	13	12	14

802.11a - 5GHz

Mode	Frequency (MHz)	Measured Power (dBm)	Declared (dBm)	Tune-up Low (dBm)	Tune-up High (dBm)
802.11a	5180 MHz	15.76	16	15	17
802.11a	5200 MHz	15.75	16	15	17
802.11a	5240 MHz	15.47	16	15	17
802.11a	5260 MHz	15.62	16	15	17
802.11a	5280 MHz	15.88	16	15	17
802.11a	5320 MHz	15.52	16	15	17
802.11a	5500 MHz	15.65	16	15	17
802.11a	5580 MHz	15.77	16	15	17
802.11a	5700 MHz	15.79	16	15	17
802.11a	5745 MHz	15.66	16	15	17
802.11a	5785 MHz	15.82	16	15	17
802.11a	5825 MHz	15.75	16	15	17

802.11HT20 - 5GHz

Mode	Frequency (MHz)	Measured Power (dBm)	Declared (dBm)	Tune-up Low (dBm)	Tune-up High (dBm)
802.11n-20M	5180 MHz	15.44	16	15	17
802.11n-20M	5200 MHz	15.44	16	15	17
802.11n-20M	5240 MHz	15.16	16	15	17
802.11n-20M	5260 MHz	15.31	16	15	17
802.11n-20M	5280 MHz	15.56	16	15	17
802.11n-20M	5320 MHz	15.21	16	15	17
802.11n-20M	5500 MHz	15.34	16	15	17
802.11n-20M	5580 MHz	15.45	16	15	17
802.11n-20M	5700 MHz	15.47	16	15	17
802.11n-20M	5745 MHz	15.35	16	15	17
802.11n-20M	5785 MHz	15.50	16	15	17
802.11n-20M	5825 MHz	15.44	16	15	17

802.11HT40 - 5GHz

Mode	Frequency (MHz)	Measured Power (dBm)	Declared (dBm)	Tune-up Low (dBm)	Tune-up High (dBm)
802.11n-40M	5190 MHz	15.49	16	15	17
802.11n-40M	5230 MHz	15.72	16	15	17
802.11n-40M	5270 MHz	15.58	16	15	17
802.11n-40M	5310 MHz	15.69	16	15	17
802.11n-40M	5510 MHz	15.74	16	15	17
802.11n-40M	5550 MHz	15.88	16	15	17
802.11n-40M	5670 MHz	15.22	16	15	17
802.11n-40M	5755 MHz	15.23	16	15	17
802.11n-40M	5795 MHz	15.71	16	15	17

802.11VHT80 - 5GHz

Mode	Frequency (MHz)	Measured Power (dBm)	Declared (dBm)	Tune-up Low (dBm)	Tune-up High (dBm)
802.11ac-80M	5210 MHz	7.57	8	7	9
802.11ac-80M	5290 MHz	7.62	8	7	9
802.11ac-80M	5530 MHz	7.59	8	7	9
802.11ac-80M	5610 MHz	7.61	8	7	9
802.11ac-80M	5775 MHz	7.72	8	7	9

15 SAR Test Results

Requirement(s):

Spec	Item	Requirement	Applicable
FCC §2.1093 & RSS 102	1	SAR limit for Handheld device used by the General public (Uncontrolled Environment) in localized Body is 4 W/kg	<input checked="" type="checkbox"/>
	2	SAR limit for Controlled Use Devices (Controlled Environment) in localized Head and Trunk is 8 W/kg	<input type="checkbox"/>
Test Method	IEEE 1528: 2013 IEC 62209-2: 2010 447498 D01 General RF Exposure Guidance v05r02 248227 SAR measurement procedures for 802.11 a/b/g v01r02 KDB 865664 SAR Measurement Requirements for 3 to 6 GHz v01r03		
Test Setup	Refer to Section 6: SAR Measurement Setup		
Test Procedure	<p><u>Steps:</u></p> <ol style="list-style-type: none"> 1. Use client test software to set EUT transmit RF power in cont-TX mode in the highest power channel 2. Measure output power through spectrum analyzer 3. Place the DUT in the positions selected 4. Set scan area, grid size and other setting on the DASY6 software 5. Make SAR measurement for the selected highest output power channel at each testing position 6. Find out the position with highest SAR result 7. Measure additional SAR for other modes at the highest SAR position <p>SAR measurement system will proceed the following basic steps:</p> <ol style="list-style-type: none"> 1. Initial power reference measurement 2. Area Scan 3. Zoom Scan 4. Power drift measurement 		
Test Date	04/23/018 - 04/27/2018	Environmental condition	Temperature 22oC Relative Humidity 55% Atmospheric Pressure 1008mbar
Remark	SAR is not required because the distance from the antenna to the edge is > 25 mm as per KDB 941225 D06 Hotspot Mode SAR. So, SAR is not required for Left and Right edge sides.		
Result	<input checked="" type="checkbox"/> Pass <input type="checkbox"/> Fail		

Test Data Yes N/A

Test Plot Yes N/A

SAR Measurement for 2.4GHz result to determine the worst-case position configuration

Freq Band	Freq (MHz)	Position	Distance	Rated Max Power (dBm)	Measured Output Power (dBm)	Raw SAR 10g(W/kg)	Crest factor	Power Drift (dB)	Scaled SAR (Tune-up & Duty Cycle) (W/kg)	10g SAR Limit (W/kg)
802.11-b	2412	Bottom	0mm	16	15.87	0.031	1	0.88	0.0321	4
	2437	Bottom	0mm	16	15.79	0.025	1	1.05	0.0265	4
	2462	Bottom	0mm	16	15.78	0.027	1	0.88	0.0287	4
	2412	Left side	0mm	16	15.87	0.059	1	0.01	0.0609	4
	2437	Left side	0mm	16	15.79	0.053	1	0.01	0.0559	4
	2462	Left side	0mm	16	15.78	0.046	1	0.01	0.0487	4
802.11-HT40-2.4G	2422	Bottom	0mm	13	12.36	0.005	1	1.23	0.0066	4
	2437	Bottom	0mm	13	12.65	0.007	1	1.08	0.008	4
	2452	Bottom	0mm	13	12.67	0.005	1	1.15	0.0058	4
	2437	Left side	0mm	13	12.65	0.023	1	0.08	0.0253	4

SAR Measurement for 5GHz result based on worst-case position

Freq Band	Freq (MHz)	Position	Distance	Rated Max Power (dBm)	Measured Output Power (dBm)	Raw SAR 10g(W/kg g)	Crest factor	Power Drift (dB)	Scaled SAR (Tune-up & Duty Cycle) (W/kg)	10g SAR Limit (W/kg)
802.11a	5180	Left side	0mm	16	15.76	0.047	1	0.12	0.05	4
	5200	Left side	0mm	16	15.75	0.053	1	0.11	0.0564	4
	5200	Bottom	0mm	16	15.75	0.002	1	1.75	0.0024	4
	5240	Left side	0mm	16	15.47	0.056	1	0.10	0.0639	4
	5260	Left side	0mm	16	15.62	0.051	1	0.10	0.0561	4
	5280	Left side	0mm	16	15.88	0.042	1	0.12	0.0433	4
	5280	Bottom	0mm	16	15.88	0.01	1	1.28	0.0104	4
	5320	Left side	0mm	16	15.52	0.047	1	0.12	0.0531	4
	5500	Left side	0mm	16	15.65	0.058	1	0.11	0.0633	4
	5580	Left side	0mm	16	15.77	0.059	1	0.04	0.0625	4
	5580	Bottom	0mm	16	15.77	0.016	1	0.24	0.0171	4
	5700	Left side	0mm	16	15.79	0.043	1	0.05	0.0454	4
	5745	Left side	0mm	16	15.66	0.047	1	0.05	0.0512	4
	5785	Left side	0mm	16	15.82	0.063	1	0.05	0.0659	4
	5785	Bottom	0mm	16	15.82	0.022	1	0.21	0.0231	4
	5825	Left side	0mm	16	15.75	0.049	1	0.07	0.0522	4
802.11-HT40-5G	5190	Left side	0mm	16	15.49	0.045	1	0.05	0.0512	4
	5230	Left side	0mm	16	15.72	0.048	1	0.07	0.0515	4
	5230	Bottom	0mm	16	15.72	0.008	1	0.72	0.0089	4
	5270	Left side	0mm	16	15.58	0.045	1	0.07	0.0501	4
	5270	Bottom	0mm	16	15.58	0.008	1	0.04	0.0093	4

Freq Band	Freq (MHz)	Position	Distance	Rated Max Power (dBm)	Measured Output Power (dBm)	Raw SAR 10g(W/kg g)	Crest factor	Power Drift (dB)	Scaled SAR (Tune-up & Duty Cycle) (W/kg)	10g SAR Limit (W/kg)
802.11- HT40-5G	5310	Left side	0mm	16	15.69	0.042	1	0.01	0.0455	4
	5310	Bottom	0mm	16	15.69	0.027	1	0.57	0.0294	4
	5510	Left side	0mm	16	15.74	0.047	1	0.01	0.0502	4
	5550	Left side	0mm	16	15.88	0.042	1	0.01	0.0433	4
	5550	Bottom	0mm	16	15.88	0.03	1	0.27	0.031	4
	5670	Left side	0mm	16	15.62	0.036	1	0.01	0.0397	4
	5755	Left side	0mm	16	15.23	0.044	1	0.01	0.0535	4
	5755	Bottom	0mm	16	15.23	0.026	1	0.51	0.032	4
	5795	Left side	0mm	16	15.71	0.043	1	0.01	0.0463	4
	5795	Bottom	0mm	16	15.71	0.024	1	0.31	0.026	4
802.11- VHT80- 5G	5210	Left side	0mm	8	7.57	0.013	1	0.01	0.0149	4
	5210	Bottom	0mm	8	7.57	0.018	1	0.01	0.0204	4
	5290	Left side	0mm	8	7.62	0.009	1	0.01	0.0103	4
	5290	Bottom	0mm	8	7.62	0.031	1	0.01	0.0343	4
	5530	Left side	0mm	8	7.59	0.009	1	0.05	0.0104	4
	5530	Bottom	0mm	8	7.59	0.038	1	0.29	0.0423	4
	5610	Left side	0mm	8	7.61	0.005	1	0.01	0.0059	4
	5610	Bottom	0mm	8	7.61	0.037	1	0.47	0.0409	4
	5775	Left side	0mm	8	7.72	0.005	1	0.01	0.0057	4
	5775	Bottom	0mm	8	7.72	0.035	1	0.01	0.0377	4

Note: EUT will be close to human body as normal usage.

16 System Performance Plots

Test specification:	System Verification			
Environ Conditions:	Temp(oC):	23	Result:	Pass
	Humidity (%):	58		
	Atmospheric(mPa):	1011		
Mains Power:	N/A			
Test Date:	04/23/2018			
Tested by:	Cipher			
Remarks:	System Validation, dipole, CW signal, duty cycle =1			

Frequency (MHz)	2450
Relative Permittivity (real part)	50.8
Conductivity (S/m)	1.98
Probe SN	EX3DV4 - SN7469
DAE SN	DAE4 Sn1522
Conversion Factor (dB)	8.5
Area Scan Resolution (mm)	14.0 x 14.0
Zoom Scan Resolution (mm)	6.0 x 6.0 x 6.0
Zoom Scan Size (mm)	30.0 x 30.0 x 30.0
Power Drift (dB)	1.88
SAR 10g (W/Kg)	24.2

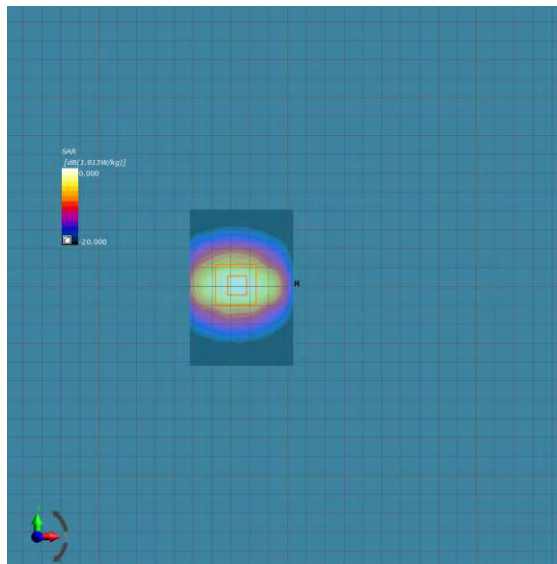

Area and Zoom Scan Plot

Test specification:	System Validation		
Environ Conditions:	Temp(oC):	23	Result: Pass
	Humidity (%):	58	
	Atmospheric(mPa):	1011	
Mains Power:	N/A		Result: Pass
Test Date:	04/23/2018		
Tested by:	Cipher		
Remarks:	System Validation, dipole, CW signal, duty cycle =1		

Frequency (MHz)	5250
Relative permittivity (real part)	48.90
Conductivity (S/m)	5.36
Probe SN	EX3DV4 - SN7469
DAE SN	DAE4 Sn1522
Conversion Factor (dB)	5.41
Area Scan Resolution	10.0 x 10.0
Zoom Scan Resolution	4.0 x 4.0 x 1.4
Zoom Scan Size	22.0 x 22.0 x 22.0
Power Drift (dB)	1.21
SAR 10g (W/Kg)	23.8

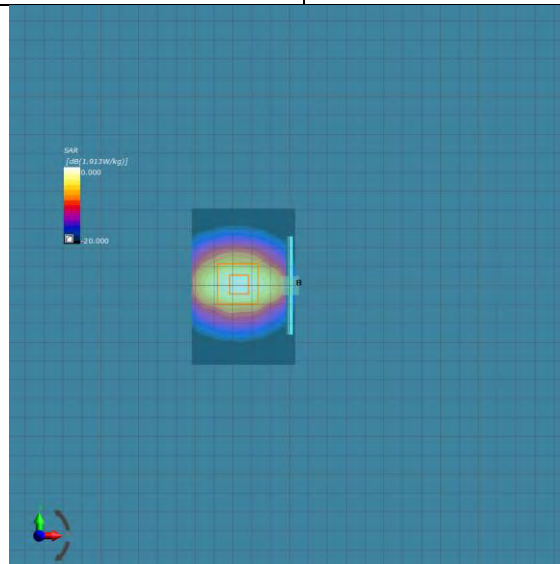

Area and Zoom Scan Plot

Test specification:	System Validation			
Environ Conditions:	Temp(oC):	23	Result:	Pass
	Humidity (%):	58		
	Atmospheric(mPa):	1011		
Mains Power:	N/A			
Test Date:	04/23/2018			
Tested by:	Cipher			
Remarks:	System Validation, dipole, CW signal, duty cycle =1			

Frequency (MHz)	5600
Relative permittivity (real part)	48.5
Conductivity (S/m)	5.77
Probe SN	EX3DV4 - SN7469
DAE SN	DAE4 Sn1522
Conversion Factor (dB)	5.41
Area Scan Resolution	10.0 x 10.0
Zoom Scan Resolution	4.0 x 4.0 x 1.4
Zoom Scan Size	22.0 x 22.0 x 22.0
Power Drift (dB)	1.00
SAR 10g (W/Kg)	23.9

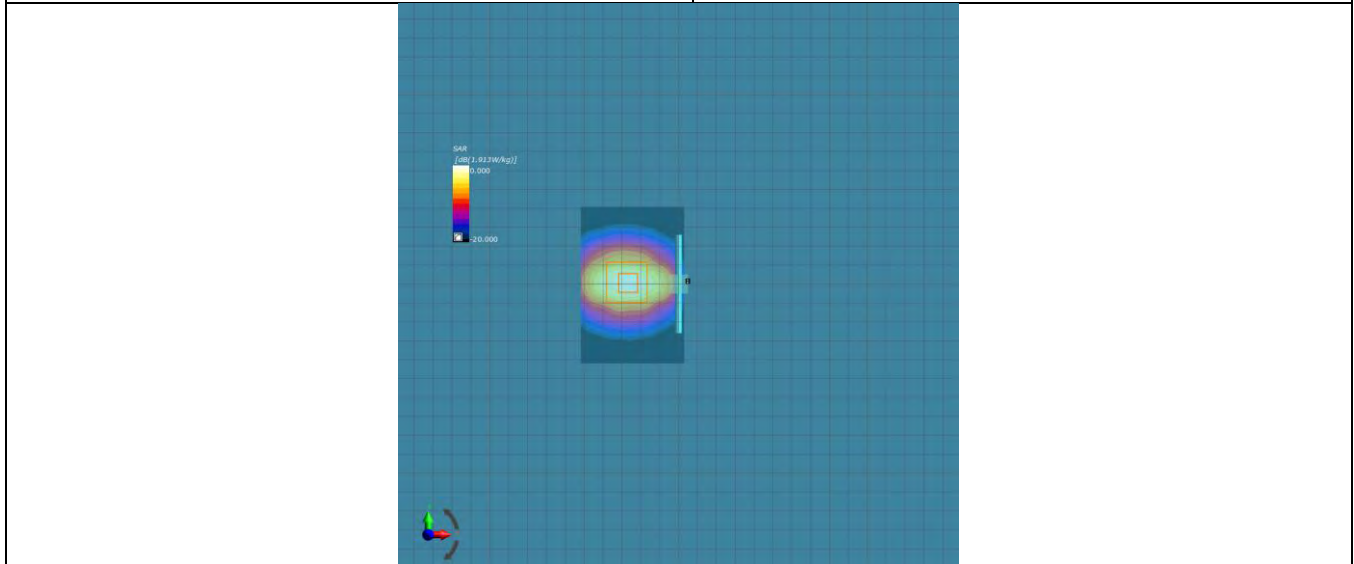

Area and Zoom Scan Plot

Test specification:	System Validation		
Environ Conditions:	Temp(oC):	23	Result: Pass
	Humidity (%):	58	
	Atmospheric(mPa):	1011	
Mains Power:	N/A		Result: Pass
Test Date:	04/23/2018		
Tested by:	Cipher		
Remarks:	System Validation, dipole, CW signal, duty cycle =1		

Frequency (MHz)	5800
Relative permittivity (real part)	48.3
Conductivity (S/m)	5.94
Probe SN	EX3DV4 - SN7469
DAE SN	DAE4 Sn1522
Conversion Factor (dB)	5.41
Area Scan Resolution	10.0 x 10.0
Zoom Scan Resolution	4.0 x 4.0 x 1.4
Zoom Scan Size	22.0 x 22.0 x 22.0
Power Drift (dB)	1.02
SAR 10g (W/Kg)	24.1

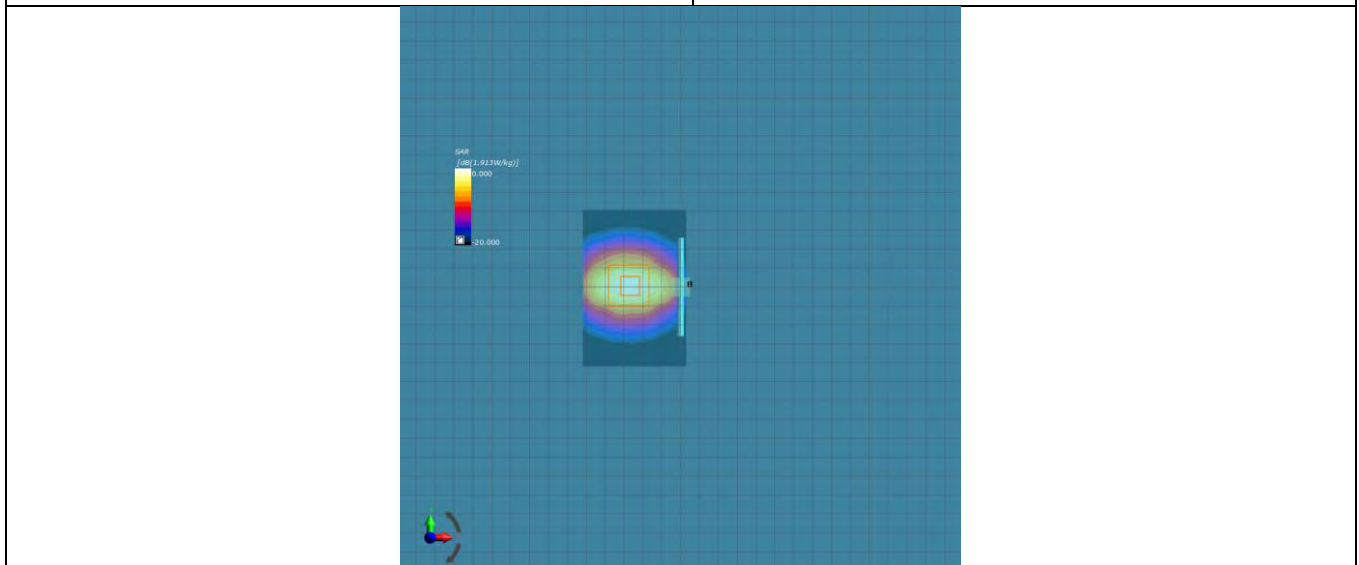

Area and Zoom Scan Plot

17 SAR Test Plots

Test specification:	Body_Low_802.11b_2412_Bottom_0mm		
Environ Conditions:	Temp(oC): 22	Result:	Pass
	Humidity (%): 45		
	Atmospheric(mPa): 1010		
Mains Power:	N/A		
Test Date:	04/23/2018 - 04/27/2018		
Tested by:	Cipher		
Remarks:	-		
Frequency (MHz)	2412 (Channel 1)		
Relative Permittivity (real part)	53.2		
Conductivity (S/m)	1.98		
Probe SN	EX3DV4 - SN7469		
DAE SN	DAE4 Sn1522		
Conversion Factor (dB)	8.5		
Area Scan Resolution (mm)	14x14		
Zoom Scan Resolution (mm)	6x6x6		
Zoom Scan Size (mm)	30x30x30		
Power Drift (dB)	0.88		
SAR 10g (W/Kg)	0.0321		

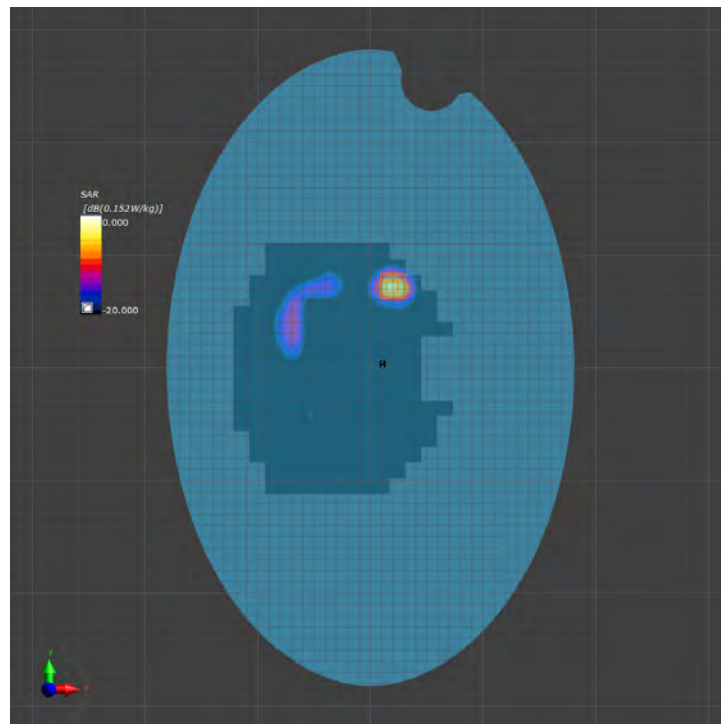

Area and Zoom Scan Plot

Test specification:	Body_Low_802.11b_2412_Leftside_0mm		
Environ Conditions:	Temp(oC): 22	Result:	Pass
	Humidity (%): 45		
	Atmospheric(mPa): 1010		
Mains Power:	N/A		
Test Date:	04/23/2018 - 04/27/2018		
Tested by:	Cipher		
Remarks:	-		
Frequency (MHz)	2412 (Channel 1)		
Relative Permittivity (real part)	53.2		
Conductivity (S/m)	1.98		
Probe SN	EX3DV4 - SN7469		
DAE SN	DAE4 Sn1522		
Conversion Factor (dB)	8.5		
Area Scan Resolution (mm)	14x14		
Zoom Scan Resolution (mm)	6x6x6		
Zoom Scan Size (mm)	30x30x30		
Power Drift (dB)	0.01		
SAR 10g (W/Kg)	0.0609		

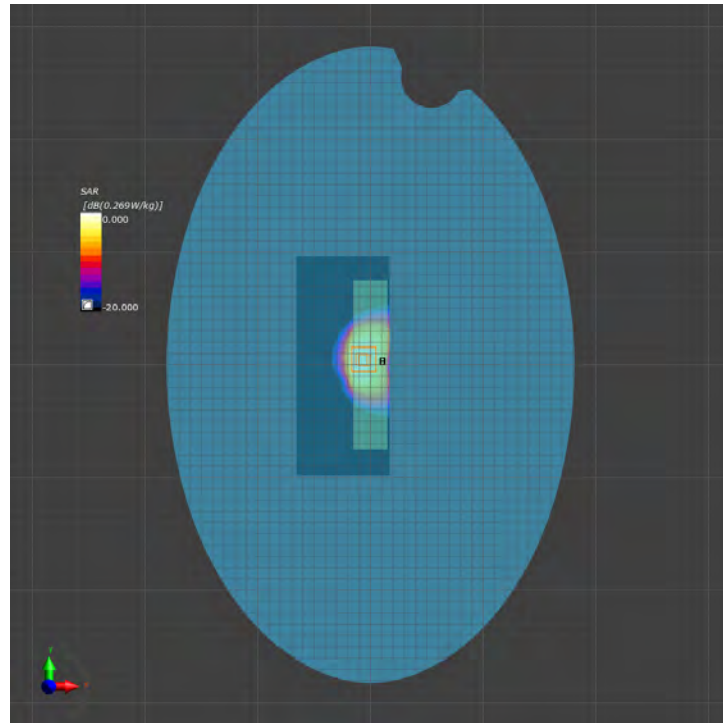

Area and Zoom Scan Plot

Test specification:	Body_Low_802.11b_2437_Bottom_0mm		
Environ Conditions:	Temp(oC): 22	Result:	Pass
	Humidity (%): 45		
	Atmospheric(mPa): 1010		
Mains Power:	N/A		
Test Date:	04/23/2018 - 04/27/2018		
Tested by:	Cipher		
Remarks:	-		
Frequency (MHz)	2437 (Channel 6)		
Relative permittivity (real part)	53.2		
Conductivity (S/m)	2.00		
Probe SN	EX3DV4 - SN7469		
DAE SN	DAE4 Sn1522		
Conversion Factor (dB)	8.5		
Area Scan Resolution (mm)	14x14		
Zoom Scan Resolution (mm)	6x6x6		
Zoom Scan Size (mm)	30x30x30		
Power Drift (dB)	1.05		
SAR 10g (W/Kg)	0.0265		

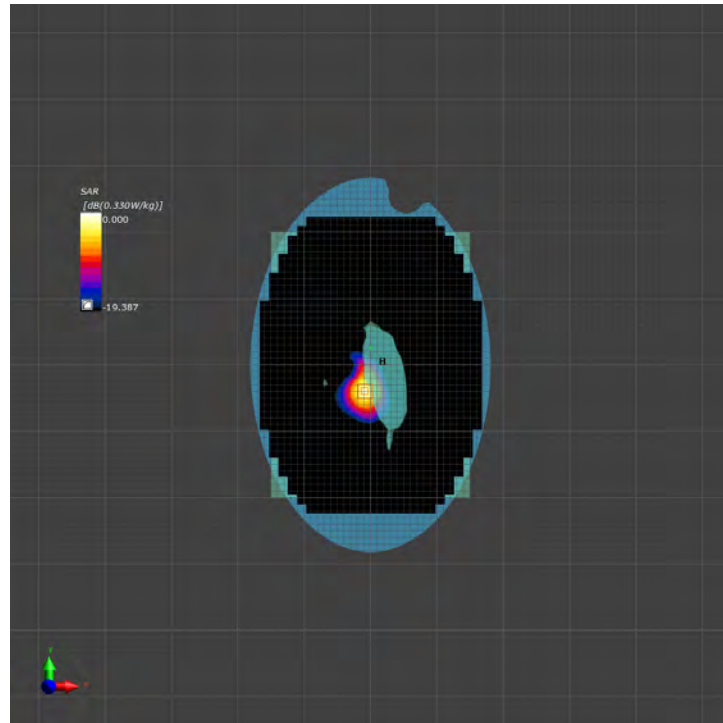

Area and Zoom Scan Plot

Test specification:	Body_Low_802.11b_2437_Leftside_0mm		
Environ Conditions:	Temp(oC): 22	Result:	Pass
	Humidity (%): 45		
	Atmospheric(mPa): 1010		
Mains Power:	N/A		
Test Date:	04/23/2018 - 04/27/2018		
Tested by:	Cipher		
Remarks:	-		
Frequency (MHz)	2437 (Channel 6)		
Relative permittivity (real part)	53.2		
Conductivity (S/m)	2.00		
Probe SN	EX3DV4 - SN7469		
DAE SN	DAE4 Sn1522		
Conversion Factor (dB)	8.5		
Area Scan Resolution (mm)	14x14		
Zoom Scan Resolution (mm)	6x6x6		
Zoom Scan Size (mm)	30x30x30		
Power Drift (dB)	0.01		
SAR 10g (W/Kg)	0.0559		

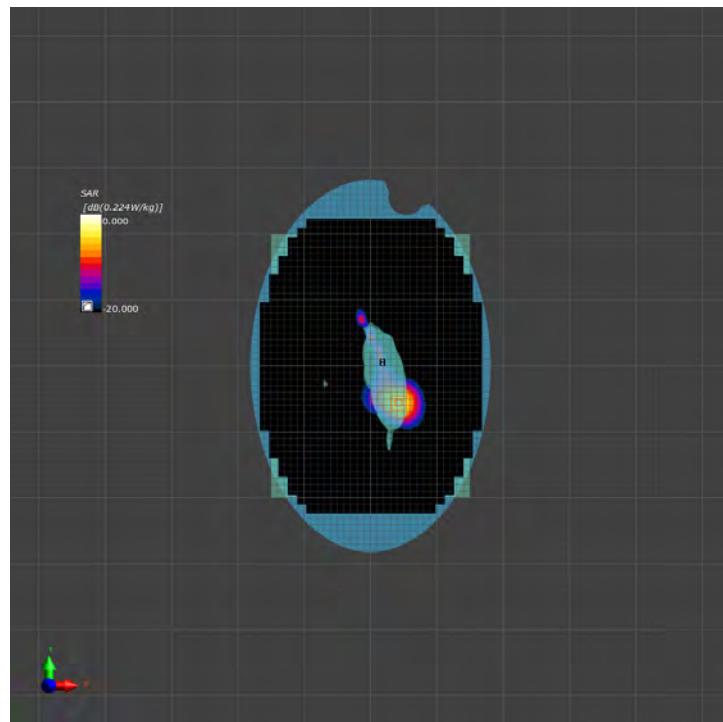

Area and Zoom Scan Plot

Test specification:	Body_Low_802.11b_2462_Bottom_0mm		
Environ Conditions:	Temp(oC): 22	Result:	Pass
	Humidity (%): 45		
	Atmospheric(mPa): 1010		
Mains Power:	N/A		
Test Date:	04/23/2018 - 04/27/2018		
Tested by:	Cipher		
Remarks:	-		
Frequency (MHz)	2462 (Channel 11)		
Relative permittivity (real part)	53.1		
Conductivity (S/m)	2.02		
Probe SN	EX3DV4 - SN7469		
DAE SN	DAE4 Sn1522		
Conversion Factor (dB)	8.5		
Area Scan Resolution (mm)	14x14		
Zoom Scan Resolution (mm)	6x6x6		
Zoom Scan Size (mm)	30x30x30		
Power Drift (dB)	0.88		
SAR 10g (W/Kg)	0.0287		

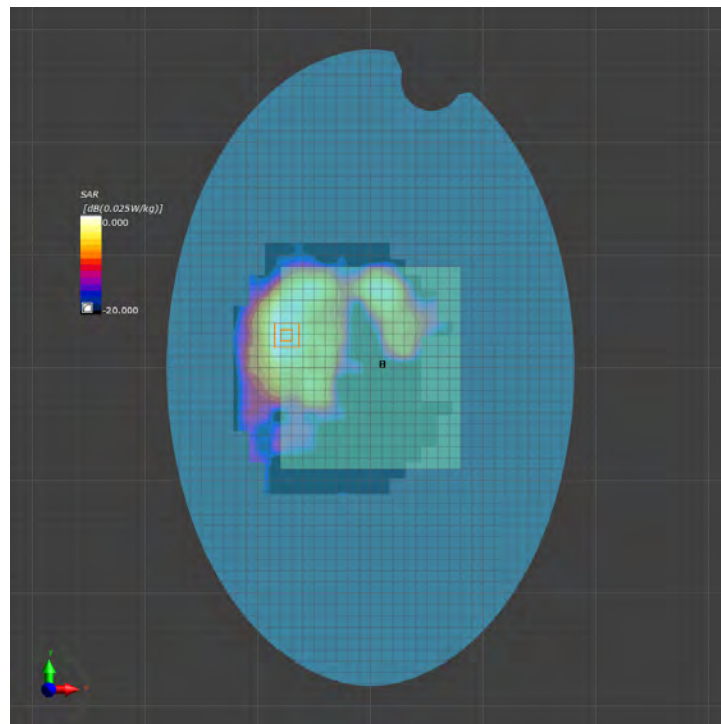

Area and Zoom Scan Plot

Test specification:	Body_Low_802.11b_2462_Leftside_0mm		
Environ Conditions:	Temp(oC): 22	Result:	Pass
	Humidity (%): 45		
	Atmospheric(mPa): 1010		
Mains Power:	N/A		
Test Date:	04/23/2018 - 04/27/2018		
Tested by:	Cipher		
Remarks:	-		
Frequency (MHz)	2462 (Channel 11)		
Relative permittivity (real part)	53.1		
Conductivity (S/m)	2.02		
Probe SN	EX3DV4 - SN7469		
DAE SN	DAE4 Sn1522		
Conversion Factor (dB)	8.5		
Area Scan Resolution (mm)	14x14		
Zoom Scan Resolution (mm)	6x6x6		
Zoom Scan Size (mm)	30x30x30		
Power Drift (dB)	0.01		
SAR 10g (W/Kg)	0.0487		

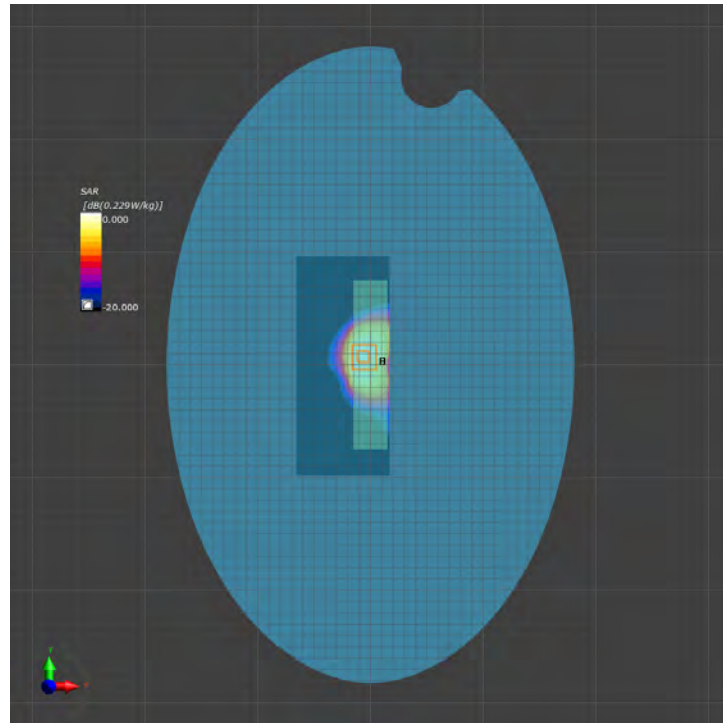

Area and Zoom Scan Plot

Test specification:	Body_Low_802.11n40_2422_Bottom_0mm		
Environ Conditions:	Temp(oC): 22	Result:	Pass
	Humidity (%): 45		
	Atmospheric(mPa): 1010		
Mains Power:	N/A		
Test Date:	04/23/2018 - 04/27/2018		
Tested by:	Cipher		
Remarks:	-		
Frequency (MHz)	2422 (Channel 3)		
Relative permittivity (real part)	53.2		
Conductivity (S/m)	1.99		
Probe SN	EX3DV4 - SN7469		
DAE SN	DAE4 Sn1522		
Conversion Factor (dB)	8.5		
Area Scan Resolution (mm)	14x14		
Zoom Scan Resolution (mm)	6x6x6		
Zoom Scan Size (mm)	30x30x30		
Power Drift (dB)	1.23		
SAR 10g (W/Kg)	0.0066		

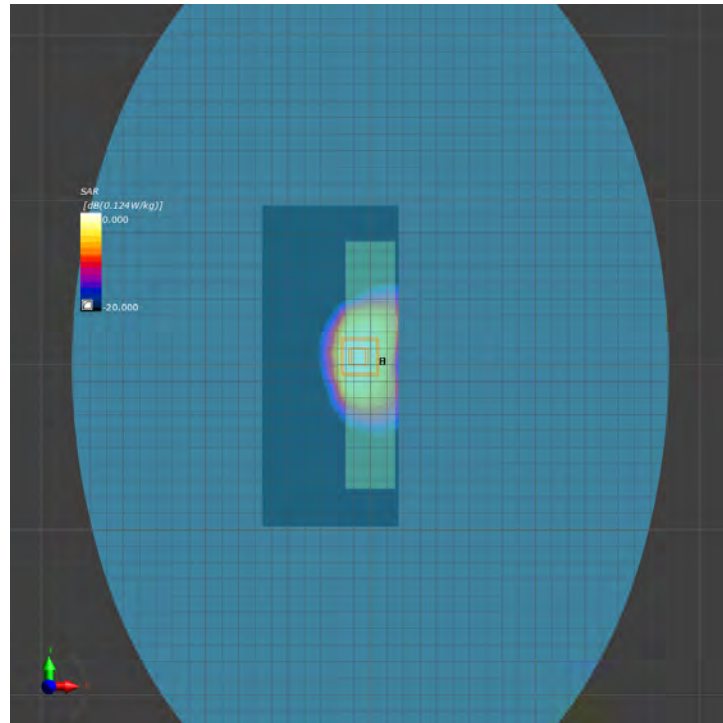

Area and Zoom Scan Plot

Test specification:	Body_Low_802.11n40_2437_Bottom_0mm		
Environ Conditions:	Temp(oC): 22	Result:	Pass
	Humidity (%): 45		
	Atmospheric(mPa): 1010		
Mains Power:	N/A		
Test Date:	04/23/2018 - 04/27/2018		
Tested by:	Cipher		
Remarks:	-		
Frequency (MHz)	2437 (Channel 6)		
Relative permittivity (real part)	53.1		
Conductivity (S/m)	2.00		
Probe SN	EX3DV4 - SN7469		
DAE SN	DAE4 Sn1522		
Conversion Factor (dB)	8.5		
Area Scan Resolution (mm)	14x14		
Zoom Scan Resolution (mm)	6x6x6		
Zoom Scan Size (mm)	30x30x30		
Power Drift (dB)	1.08		
SAR 10g (W/Kg)	0.008		

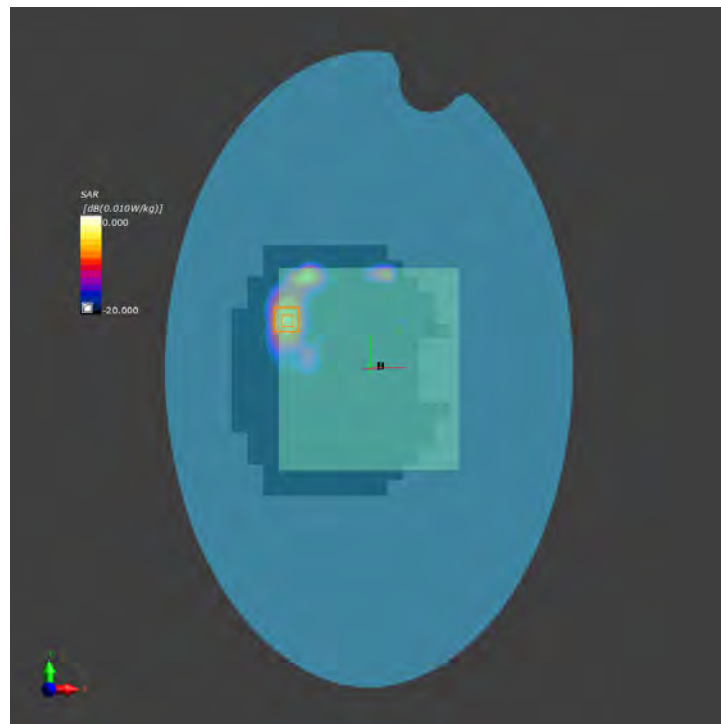

Area and Zoom Scan Plot

Test specification:	Body_Low_802.11n40_2437_Leftside_0mm		
Environ Conditions:	Temp(oC): 22	Result:	Pass
	Humidity (%): 45		
	Atmospheric(mPa): 1010		
Mains Power:	N/A		
Test Date:	04/23/2018 - 04/27/2018		
Tested by:	Cipher		
Remarks:	-		
Frequency (MHz)	2437 (Channel 6)		
Relative permittivity (real part)	53.1		
Conductivity (S/m)	2.00		
Probe SN	EX3DV4 - SN7469		
DAE SN	DAE4 Sn1522		
Conversion Factor (dB)	8.5		
Area Scan Resolution (mm)	14x14		
Zoom Scan Resolution (mm)	6x6x6		
Zoom Scan Size (mm)	30x30x30		
Power Drift (dB)	0.08		
SAR 10g (W/Kg)	0.0253		

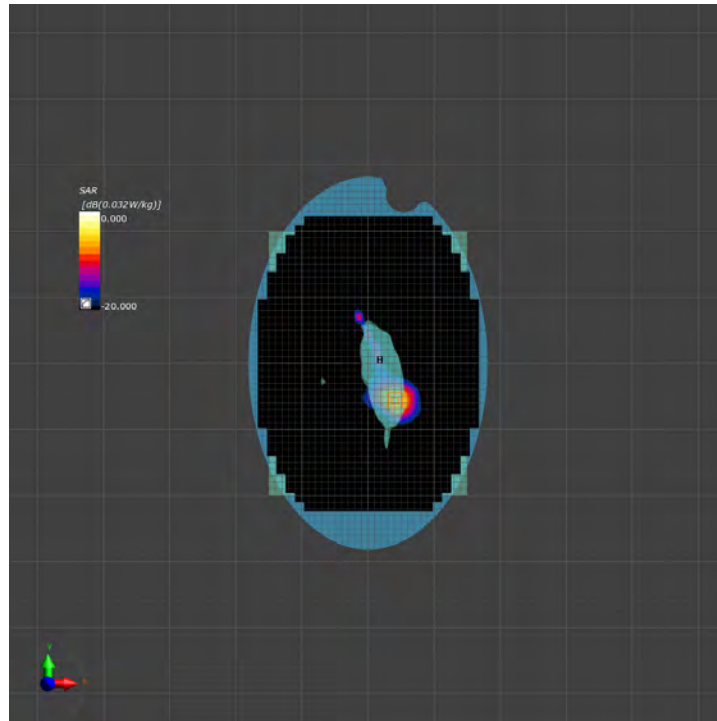

Area and Zoom Scan Plot

Test specification:	Body_Low_802.11n40_2452_Bottom_0mm		
Environ Conditions:	Temp(oC): 22	Result:	Pass
	Humidity (%): 45		
	Atmospheric(mPa): 1010		
Mains Power:	N/A		
Test Date:	04/23/2018 - 04/27/2018		
Tested by:	Cipher		
Remarks:	-		
Frequency (MHz)	2452 (Channel 9)		
Relative permittivity (real part)	53.1		
Conductivity (S/m)	2.02		
Probe SN	EX3DV4 - SN7469		
DAE SN	DAE4 Sn1522		
Conversion Factor (dB)	8.5		
Area Scan Resolution (mm)	14x14		
Zoom Scan Resolution (mm)	6x6x6		
Zoom Scan Size (mm)	30x30x30		
Power Drift (dB)	1.15		
SAR 10g (W/Kg)	0.0058		

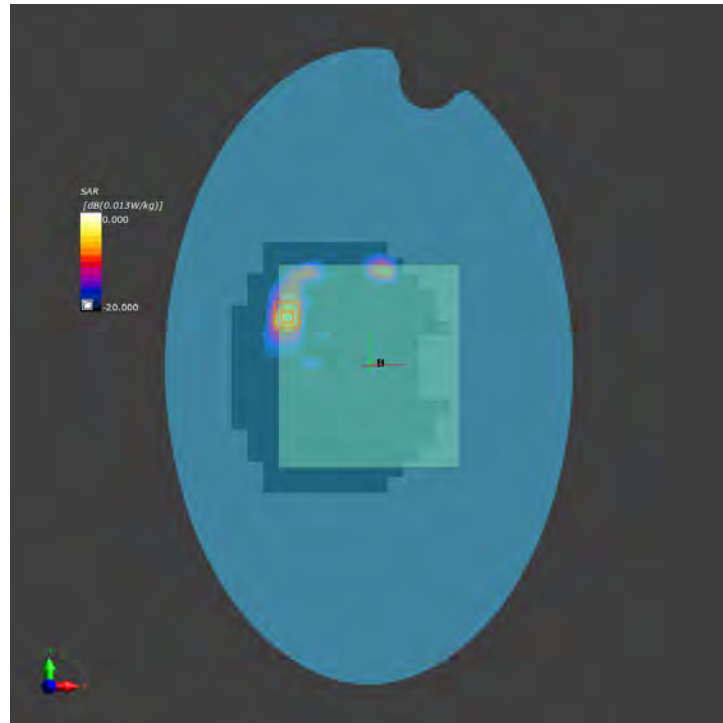

Area and Zoom Scan Plot

802.11a-5G:

Test specification:	Body_Low_802.11a-5180_Leftside_0mm		
Environ Conditions:	Temp(oC): 22	Result:	Pass
	Humidity (%): 45		
	Atmospheric(mPa): 1010		
Mains Power: N/A			
Test Date:	04/23/2018 - 04/27/2018		
Tested by:	Cipher		
Remarks:	-		
Frequency (MHz)	5180 (Channel 36)		
Relative permittivity (real part)	48.3		
Conductivity (S/m)	5.29		
Probe SN	EX3DV4 - SN7469		
DAE SN	DAE4 Sn1522		
Conversion Factor (dB)	5.41		
Area Scan Resolution (mm)	14x14		
Zoom Scan Resolution (mm)	6x6x6		
Zoom Scan Size (mm)	30x30x30		
Power Drift (dB)	0.12		
SAR 10g (W/Kg)	0.05		

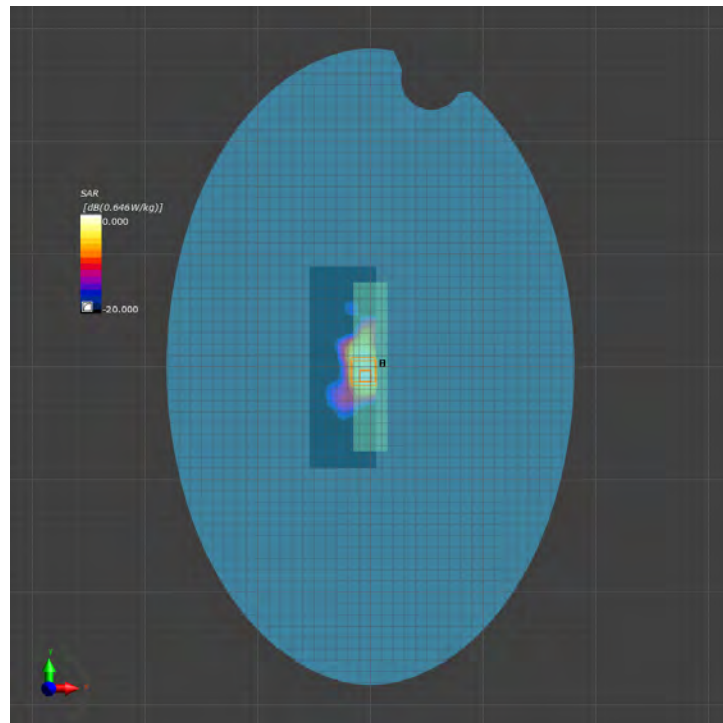

Area and Zoom Scan Plot

Test specification:	Body_Mid_802.11a-5200_Leftside_0mm		
Environ Conditions:	Temp(oC): 22	Result:	Pass
	Humidity (%): 45		
	Atmospheric(mPa): 1010		
Mains Power:	N/A		
Test Date:	04/23/2018 - 04/27/2018		
Tested by:	Cipher		
Remarks:	-		
Frequency (MHz)	5200 (Channel 40)		
Relative permittivity (real part)	48.2		
Conductivity (S/m)	5.40		
Probe SN	EX3DV4 - SN7469		
DAE SN	DAE4 Sn1522		
Conversion Factor (dB)	5.41		
Area Scan Resolution (mm)	14x14		
Zoom Scan Resolution (mm)	6x6x6		
Zoom Scan Size (mm)	30x30x30		
Power Drift (dB)	0.11		
SAR 10g (W/Kg)	0.0564		

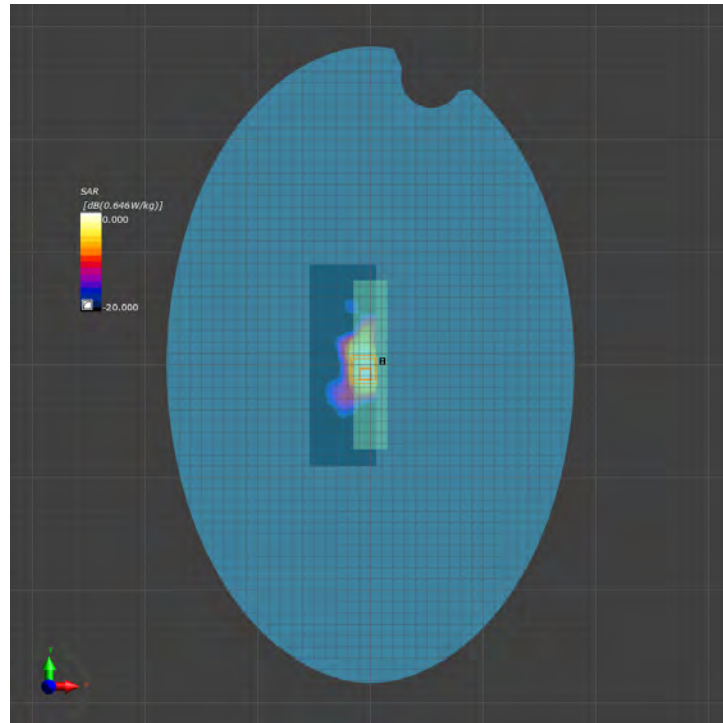

Area and Zoom Scan Plot

Test specification:	Body_Mid_802.11a-5200_Bottom_0mm		
Environ Conditions:	Temp(oC): 22	Result:	Pass
	Humidity (%): 45		
	Atmospheric(mPa): 1010		
Mains Power:	N/A		
Test Date:	04/23/2018 - 04/27/2018		
Tested by:	Cipher		
Remarks:	-		
Frequency (MHz)	5200 (Channel 40)		
Relative permittivity (real part)	48.2		
Conductivity (S/m)	5.40		
Probe SN	EX3DV4 - SN7469		
DAE SN	DAE4 Sn1522		
Conversion Factor (dB)	5.41		
Area Scan Resolution (mm)	14x14		
Zoom Scan Resolution (mm)	6x6x6		
Zoom Scan Size (mm)	30x30x30		
Power Drift (dB)	1.75		
SAR 10g (W/Kg)	0.0024		

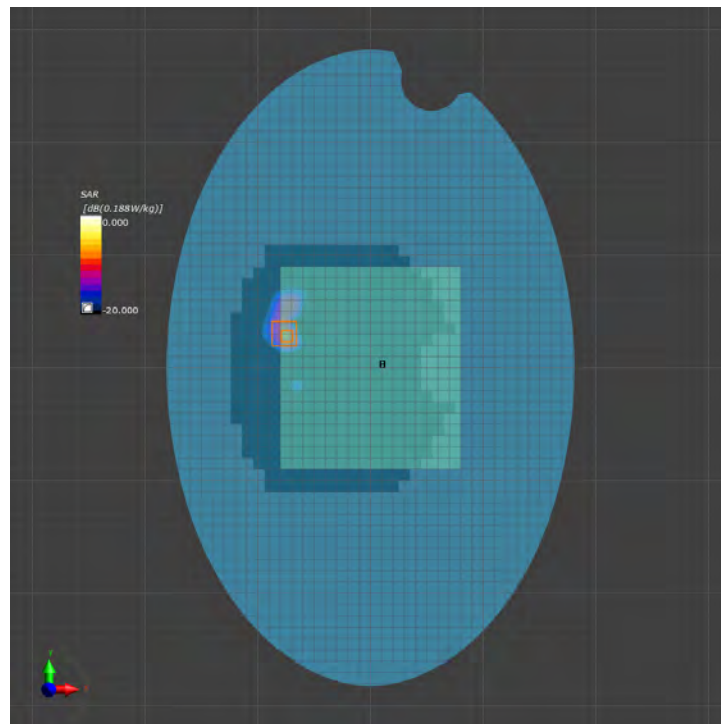

Area and Zoom Scan Plot

Test specification:	Body_High_802.11a-5240_Leftside_0mm		
Environ Conditions:	Temp(oC): 22	Result:	Pass
	Humidity (%): 45		
	Atmospheric(mPa): 1010		
Mains Power:	N/A		
Test Date:	04/23/2018 - 04/27/2018		
Tested by:	Cipher		
Remarks:	-		
Frequency (MHz)	5240 (Channel 48)		
Relative permittivity (real part)	48.2		
Conductivity (S/m)	5.40		
Probe SN	EX3DV4 - SN7469		
DAE SN	DAE4 Sn1522		
Conversion Factor (dB)	5.41		
Area Scan Resolution (mm)	14x14		
Zoom Scan Resolution (mm)	6x6x6		
Zoom Scan Size (mm)	30x30x30		
Power Drift (dB)	0.10		
SAR 10g (W/Kg)	0.0639		

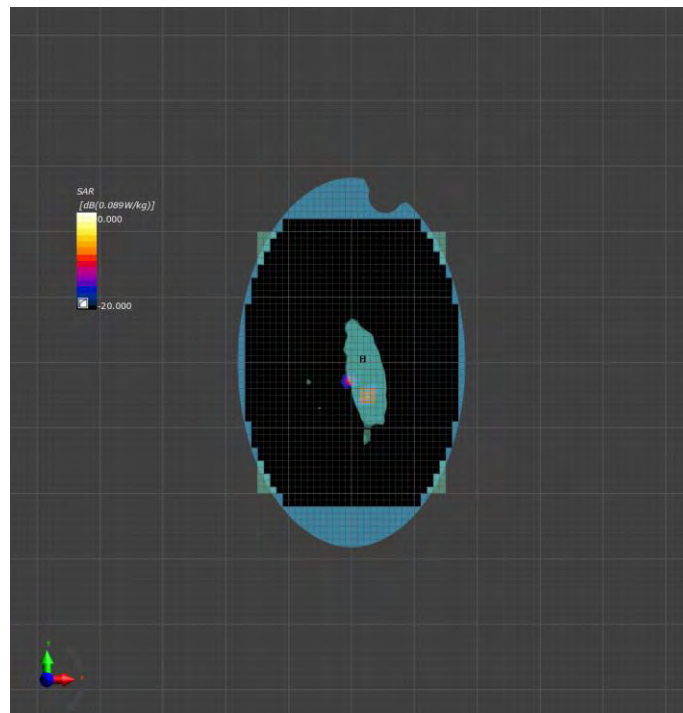

Area and Zoom Scan Plot

Test specification:	Body_Low_802.11a-5260_Leftside_0mm		
Environ Conditions:	Temp(oC): 22	Result:	Pass
	Humidity (%): 45		
	Atmospheric(mPa): 1010		
Mains Power:	N/A		
Test Date:	04/23/2018 - 04/27/2018		
Tested by:	Cipher		
Remarks:	-		
Frequency (MHz)	5260 (Channel 52)		
Relative permittivity (real part)	48.2		
Conductivity (S/m)	5.40		
Probe SN	EX3DV4 - SN7469		
DAE SN	DAE4 Sn1522		
Conversion Factor (dB)	5.41		
Area Scan Resolution (mm)	14x14		
Zoom Scan Resolution (mm)	6x6x6		
Zoom Scan Size (mm)	30x30x30		
Power Drift (dB)	0.1		
SAR 10g (W/Kg)	0.0561		

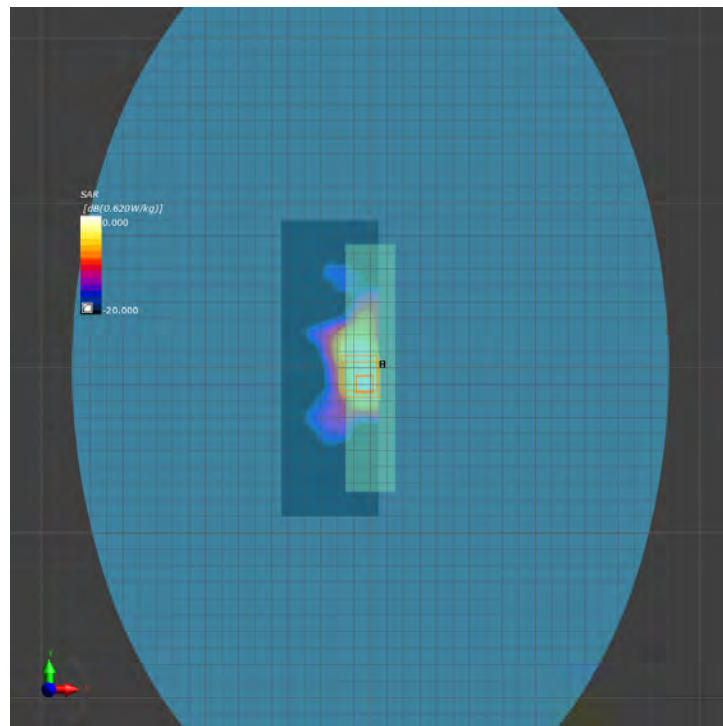

Area and Zoom Scan Plot

Test specification:	Body_Mid_802.11a-5280_Leftside_0mm		
Environ Conditions:	Temp(oC): 22	Result:	Pass
	Humidity (%): 45		
	Atmospheric(mPa): 1010		
Mains Power:	N/A		
Test Date:	04/23/2018 - 04/27/2018		
Tested by:	Cipher		
Remarks:	-		
Frequency (MHz)	5280 (Channel 56)		
Relative permittivity (real part)	48.1		
Conductivity (S/m)	5.42		
Probe SN	EX3DV4 - SN7469		
DAE SN	DAE4 Sn1522		
Conversion Factor (dB)	5.41		
Area Scan Resolution (mm)	14x14		
Zoom Scan Resolution (mm)	6x6x6		
Zoom Scan Size (mm)	30x30x30		
Power Drift (dB)	0.12		
SAR 10g (W/Kg)	0.0433		

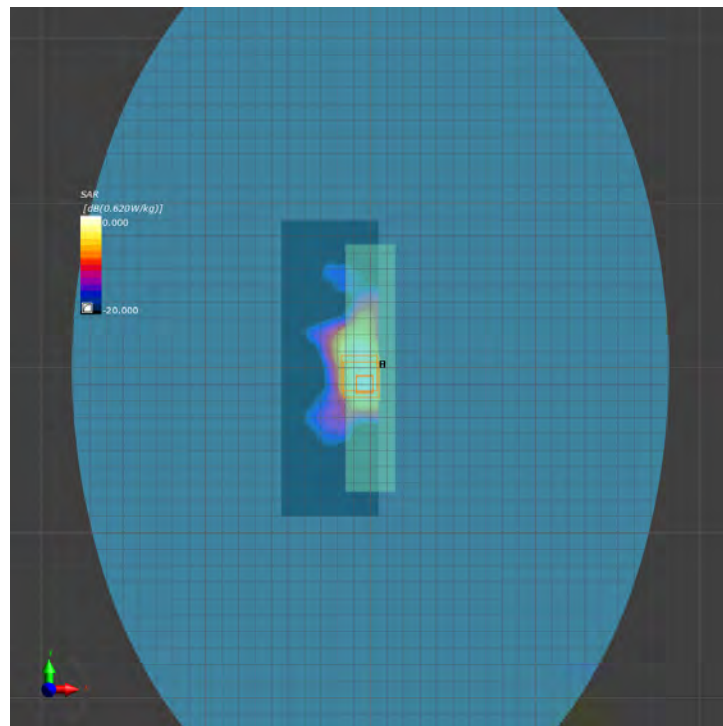

Area and Zoom Scan Plot

Test specification:	Body_Mid_802.11a-5280_Bottom_0mm		
Environ Conditions:	Temp(oC): 22	Result:	Pass
	Humidity (%): 45		
	Atmospheric(mPa): 1010		
Mains Power:	N/A		
Test Date:	04/23/2018 - 04/27/2018		
Tested by:	Cipher		
Remarks:	-		
Frequency (MHz)	5280 (Channel 56)		
Relative permittivity (real part)	48.1		
Conductivity (S/m)	5.42		
Probe SN	EX3DV4 - SN7469		
DAE SN	DAE4 Sn1522		
Conversion Factor (dB)	5.41		
Area Scan Resolution (mm)	14x14		
Zoom Scan Resolution (mm)	6x6x6		
Zoom Scan Size (mm)	30x30x30		
Power Drift (dB)	1.28		
SAR 10g (W/Kg)	0.0104		

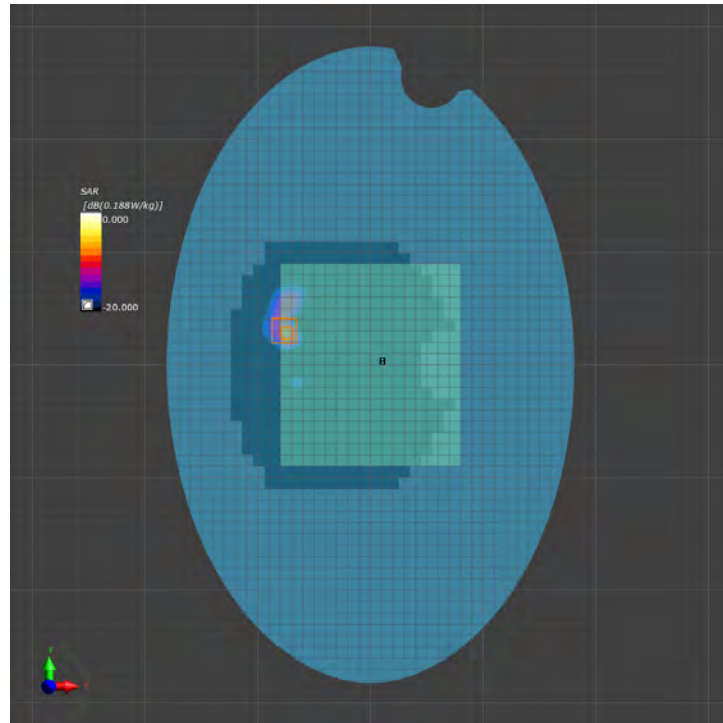

Area and Zoom Scan Plot

Test specification:	Body_High_802.11a-5320_Leftside_0mm		
Environ Conditions:	Temp(oC): 22	Result:	Pass
	Humidity (%): 45		
	Atmospheric(mPa): 1010		
Mains Power:	N/A		
Test Date:	04/23/2018 - 04/27/2018		
Tested by:	Cipher		
Remarks:	-		
Frequency (MHz)	5320 (Channel 64)		
Relative permittivity (real part)	48.1		
Conductivity (S/m)	5.47		
Probe SN	EX3DV4 - SN7469		
DAE SN	DAE4 Sn1522		
Conversion Factor (dB)	5.41		
Area Scan Resolution (mm)	14x14		
Zoom Scan Resolution (mm)	6x6x6		
Zoom Scan Size (mm)	30x30x30		
Power Drift (dB)	0.12		
SAR 10g (W/Kg)	0.0531		

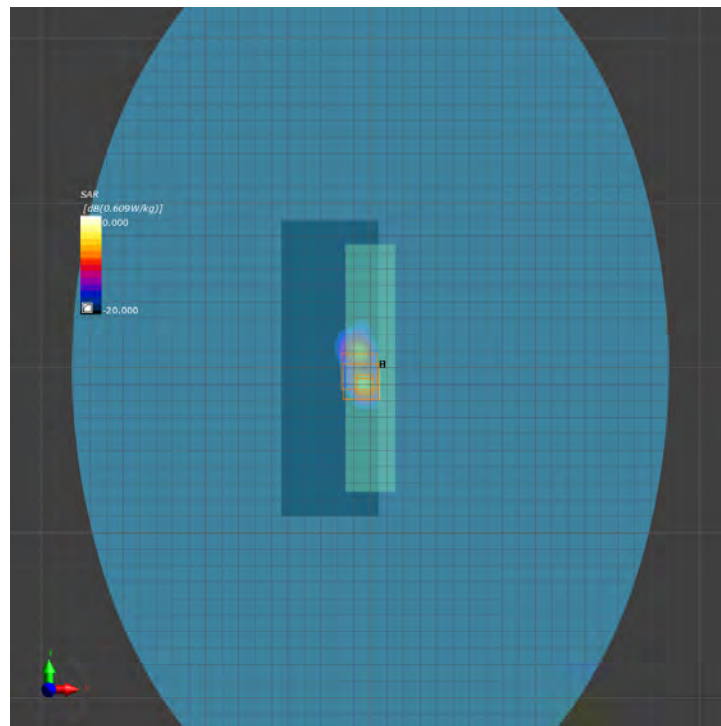

Area and Zoom Scan Plot

Test specification:	Body_Low_802.11a-5500_Leftside_0mm		
Environ Conditions:	Temp(oC): 22	Result:	Pass
	Humidity (%): 45		
	Atmospheric(mPa): 1010		
Mains Power:	N/A		
Test Date:	04/23/2018 - 04/27/2018		
Tested by:	Cipher		
Remarks:	-		
Frequency (MHz)	5500 (Channel 100)		
Relative permittivity (real part)	47.7		
Conductivity (S/m)	5.74		
Probe SN	EX3DV4 - SN7469		
DAE SN	DAE4 Sn1522		
Conversion Factor (dB)	4.65		
Area Scan Resolution (mm)	14x14		
Zoom Scan Resolution (mm)	6x6x6		
Zoom Scan Size (mm)	30x30x30		
Power Drift (dB)	0.11		
SAR 10g (W/Kg)	0.0633		

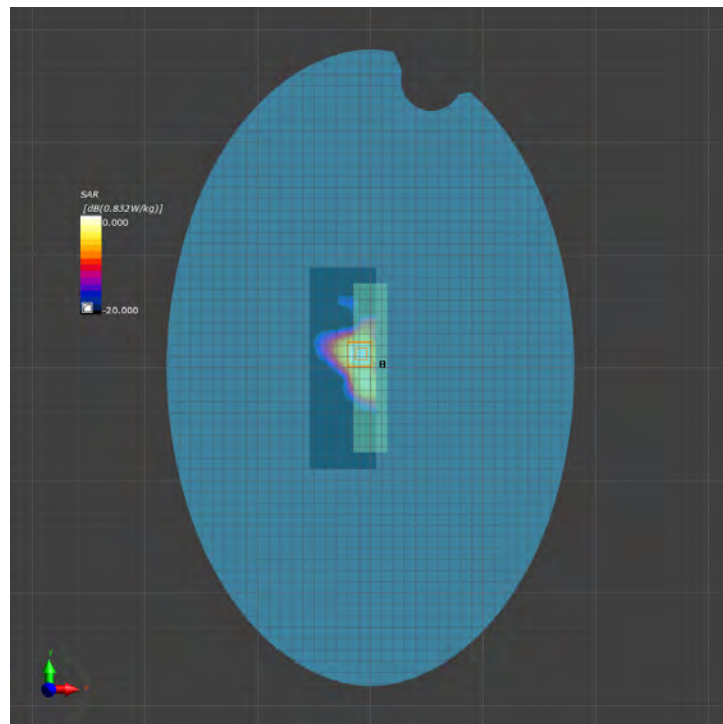

Area and Zoom Scan Plot

Test specification:	Body_Mid_802.11a-5580_Leftside_0mm		
Environ Conditions:	Temp(oC): 22	Result:	Pass
	Humidity (%): 45		
	Atmospheric(mPa): 1010		
Mains Power:	N/A		
Test Date:	04/23/2018 - 04/27/2018		
Tested by:	Cipher		
Remarks:	-		
Frequency (MHz)	5580 (Channel 116)		
Relative permittivity (real part)	47.6		
Conductivity (S/m)	5.84		
Probe SN	EX3DV4 - SN7469		
DAE SN	DAE4 Sn1522		
Conversion Factor (dB)	4.65		
Area Scan Resolution (mm)	14x14		
Zoom Scan Resolution (mm)	6x6x6		
Zoom Scan Size (mm)	30x30x30		
Power Drift (dB)	0.04		
SAR 10g (W/Kg)	0.0625		

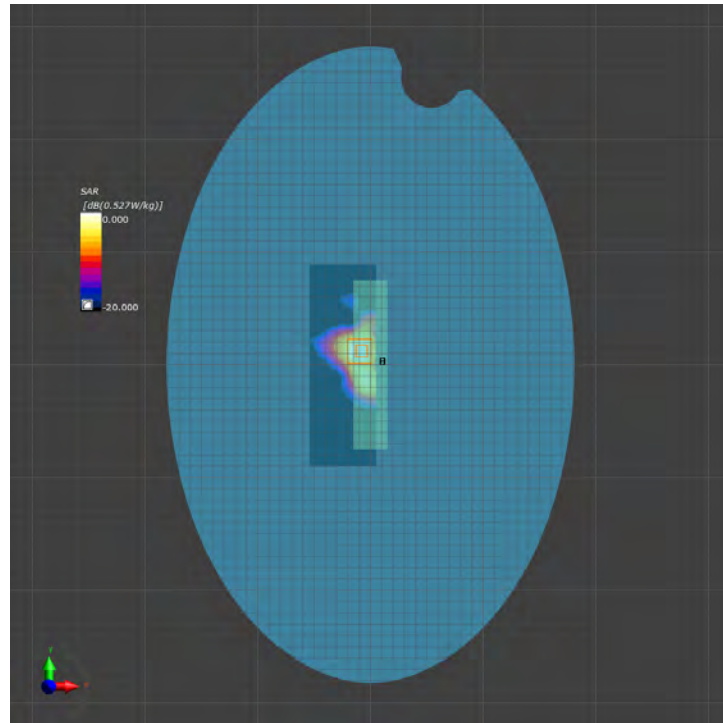

Area and Zoom Scan Plot

Test specification:	Body_Mid_802.11a-5580_Bottom_0mm		
Environ Conditions:	Temp(oC): 22	Result:	Pass
	Humidity (%): 45		
	Atmospheric(mPa): 1010		
Mains Power:	N/A		
Test Date:	04/23/2018 - 04/27/2018		
Tested by:	Cipher		
Remarks:	-		
Frequency (MHz)	5580 (Channel 116)		
Relative permittivity (real part)	47.6		
Conductivity (S/m)	5.84		
Probe SN	EX3DV4 - SN7469		
DAE SN	DAE4 Sn1522		
Conversion Factor (dB)	4.65		
Area Scan Resolution (mm)	14x14		
Zoom Scan Resolution (mm)	6x6x6		
Zoom Scan Size (mm)	30x30x30		
Power Drift (dB)	0.24		
SAR 10g (W/Kg)	0.0171		

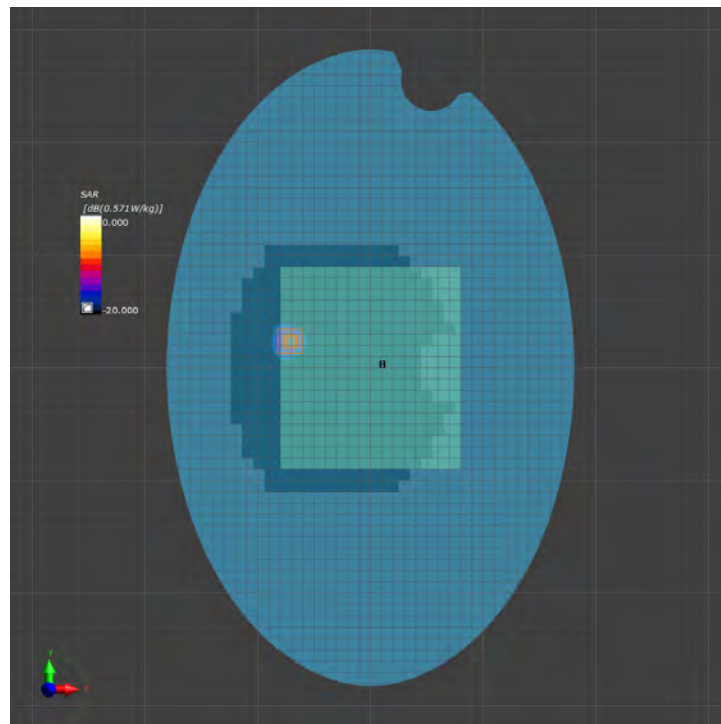

Area and Zoom Scan Plot

Test specification:	Body_High_802.11a-5700_Leftside_0mm		
Environ Conditions:	Temp(oC): 22	Result:	Pass
	Humidity (%): 45		
	Atmospheric(mPa): 1010		
Mains Power:	N/A		
Test Date:	04/23/2018 - 04/27/2018		
Tested by:	Cipher		
Remarks:	-		
Frequency (MHz)	5700 (Channel 140)		
Relative permittivity (real part)	47.2		
Conductivity (S/m)	6.11		
Probe SN	EX3DV4 - SN7469		
DAE SN	DAE4 Sn1522		
Conversion Factor (dB)	4.90		
Area Scan Resolution (mm)	14x14		
Zoom Scan Resolution (mm)	6x6x6		
Zoom Scan Size (mm)	30x30x30		
Power Drift (dB)	0.05		
SAR 10g (W/Kg)	0.0454		

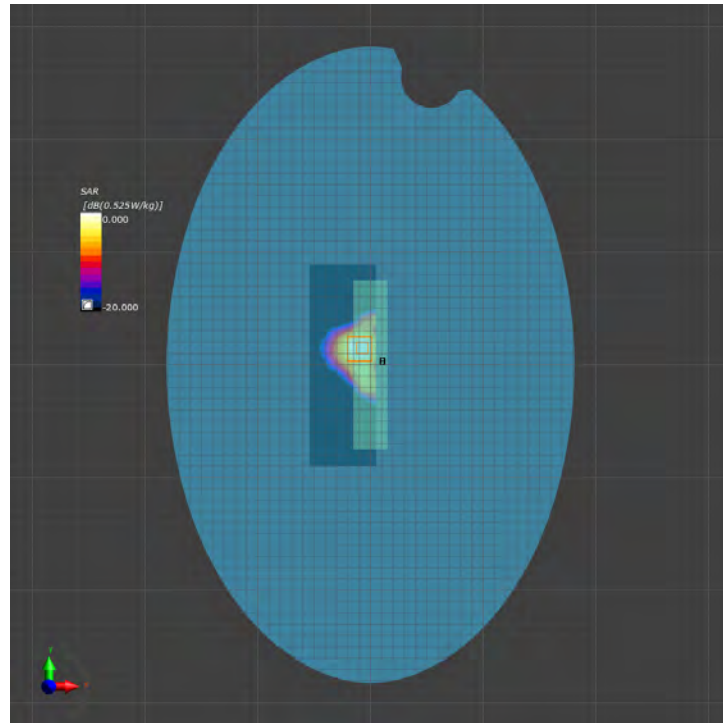

Area and Zoom Scan Plot

Test specification:	Body_Low_802.11a-5745_Leftside_0mm		
Environ Conditions:	Temp(oC): 22	Result:	Pass
	Humidity (%): 45		
	Atmospheric(mPa): 1010		
Mains Power:	N/A		
Test Date:	04/23/2018 - 04/27/2018		
Tested by:	Cipher		
Remarks:	-		
Frequency (MHz)	5745 (Channel 149)		
Relative permittivity (real part)	47.2		
Conductivity (S/m)	6.11		
Probe SN	EX3DV4 - SN7469		
DAE SN	DAE4 Sn1522		
Conversion Factor (dB)	4.90		
Area Scan Resolution (mm)	14x14		
Zoom Scan Resolution (mm)	6x6x6		
Zoom Scan Size (mm)	30x30x30		
Power Drift (dB)	0.05		
SAR 10g (W/Kg)	0.0512		

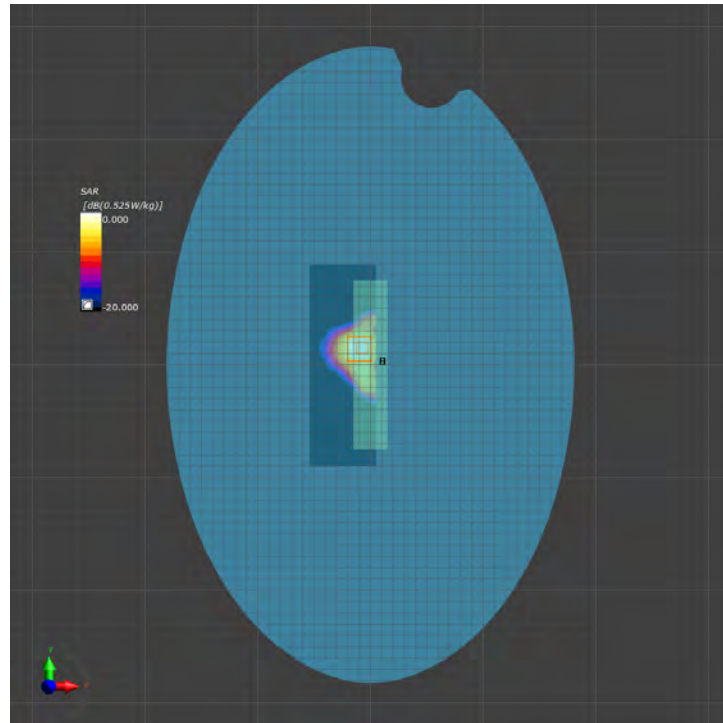

Area and Zoom Scan Plot

Test specification:	Body_Mid_802.11a-5785_Leftside_0mm		
Environ Conditions:	Temp(oC): 22	Result:	Pass
	Humidity (%): 45		
	Atmospheric(mPa): 1010		
Mains Power:	N/A		
Test Date:	04/23/2018 - 04/27/2018		
Tested by:	Cipher		
Remarks:	-		
Frequency (MHz)	5785 (Channel 157)		
Relative permittivity (real part)	47.1		
Conductivity (S/m)	6.16		
Probe SN	EX3DV4 - SN7469		
DAE SN	DAE4 Sn1522		
Conversion Factor (dB)	4.90		
Area Scan Resolution (mm)	14x14		
Zoom Scan Resolution (mm)	6x6x6		
Zoom Scan Size (mm)	30x30x30		
Power Drift (dB)	0.05		
SAR 10g (W/Kg)	0.0659		

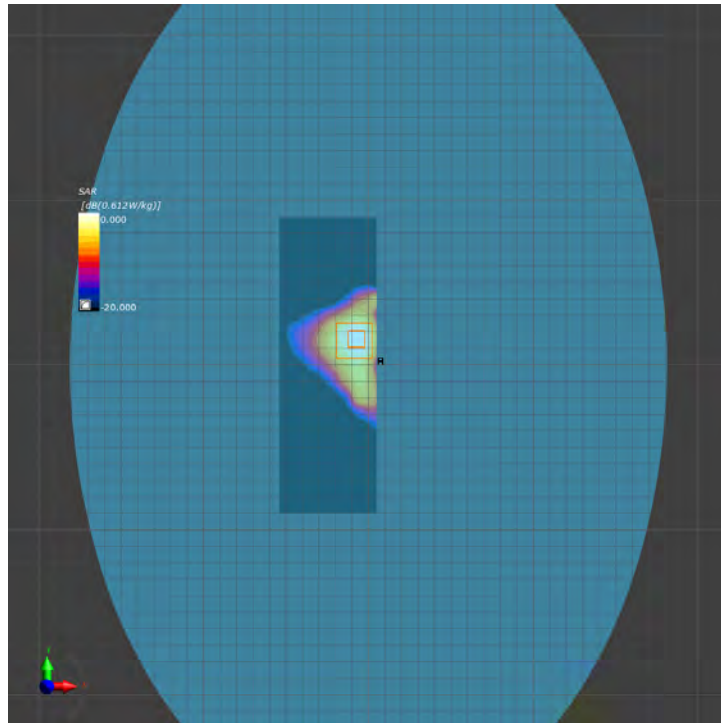

Area and Zoom Scan Plot

Test specification:	Body_Mid_802.11a-5785_Bottom_0mm		
Environ Conditions:	Temp(oC): 22	Result:	Pass
	Humidity (%): 45		
	Atmospheric(mPa): 1010		
Mains Power:	N/A		
Test Date:	04/23/2018 - 04/27/2018		
Tested by:	Cipher		
Remarks:	-		
Frequency (MHz)	5785 (Channel 157)		
Relative permittivity (real part)	47.1		
Conductivity (S/m)	6.16		
Probe SN	EX3DV4 - SN7469		
DAE SN	DAE4 Sn1522		
Conversion Factor (dB)	4.90		
Area Scan Resolution (mm)	14x14		
Zoom Scan Resolution (mm)	6x6x6		
Zoom Scan Size (mm)	30x30x30		
Power Drift (dB)	0.21		
SAR 10g (W/Kg)	0.0231		

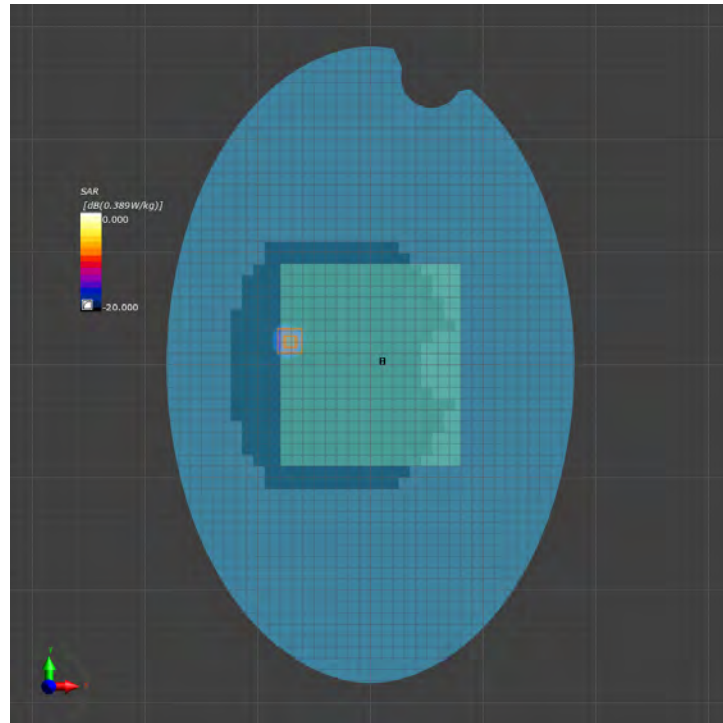

Area and Zoom Scan Plot

Test specification:	Body_High_802.11a-5825_Leftside_0mm		
Environ Conditions:	Temp(oC): 22	Result:	Pass
	Humidity (%): 45		
	Atmospheric(mPa): 1010		
Mains Power:	N/A		
Test Date:	04/23/2018 - 04/27/2018		
Tested by:	Cipher		
Remarks:	-		
Frequency (MHz)	5825 (Channel 165)		
Relative permittivity (real part)	47.1		
Conductivity (S/m)	6.16		
Probe SN	EX3DV4 - SN7469		
DAE SN	DAE4 Sn1522		
Conversion Factor (dB)	4.90		
Area Scan Resolution (mm)	14x14		
Zoom Scan Resolution (mm)	6x6x6		
Zoom Scan Size (mm)	30x30x30		
Power Drift (dB)	0.07		
SAR 10g (W/Kg)	0.0522		

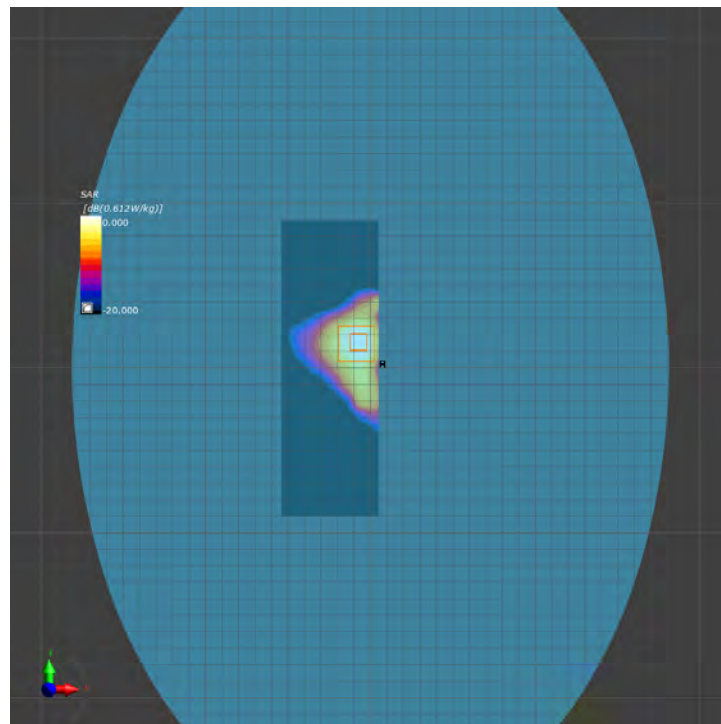

Area and Zoom Scan Plot

802.11HT-40

Test specification:	FBody_Low_802.11HT40-5190_Leftside_0mm		
Environ Conditions:	Temp(oC): 22	Result:	Pass
	Humidity (%): 45		
	Atmospheric(mPa): 1010		
Mains Power:	N/A		
Test Date:	04/23/2018 - 04/27/2018		
Tested by:	Cipher		
Remarks:	-		
Frequency (MHz)	5190 (Channel 38)		
Relative permittivity (real part)	48.3		
Conductivity (S/m)	5.30		
Probe SN	EX3DV4 - SN7469		
DAE SN	DAE4 Sn1522		
Conversion Factor (dB)	5.41		
Area Scan Resolution (mm)	14x14		
Zoom Scan Resolution (mm)	6x6x6		
Zoom Scan Size (mm)	30x30x30		
Power Drift (dB)	0.05		
SAR 10g (W/Kg)	0.0512		

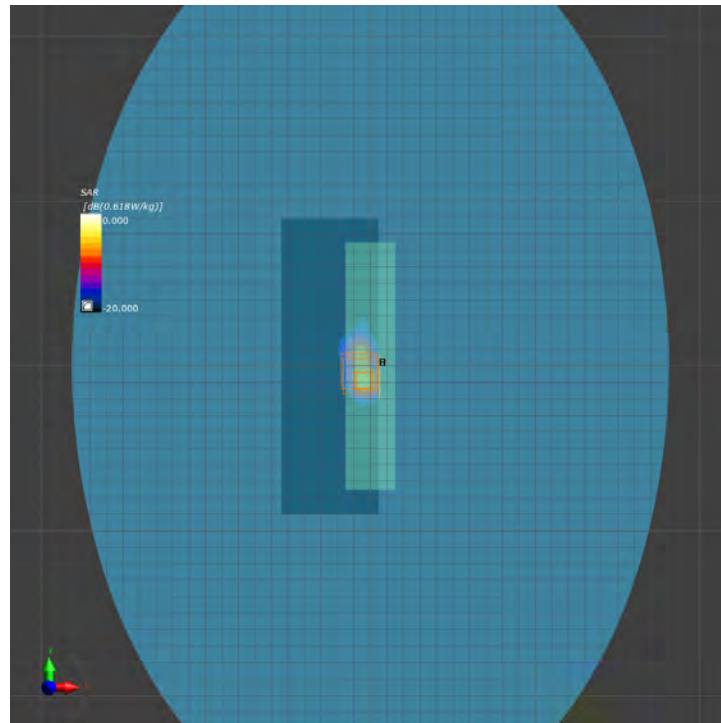

Area and Zoom Scan Plot

Test specification:	Body_High_802.11HT40-5230_Leftside_0mm		
Environ Conditions:	Temp(oC): 22	Result:	Pass
	Humidity (%): 45		
	Atmospheric(mPa): 1010		
Mains Power:	N/A		
Test Date:	04/23/2018 - 04/27/2018		
Tested by:	Cipher		
Remarks:	-		
Frequency (MHz)	5230 (Channel 46)		
Relative permittivity (real part)	48.3		
Conductivity (S/m)	5.30		
Probe SN	EX3DV4 - SN7469		
DAE SN	DAE4 Sn1522		
Conversion Factor (dB)	5.41		
Area Scan Resolution (mm)	14x14		
Zoom Scan Resolution (mm)	6x6x6		
Zoom Scan Size (mm)	30x30x30		
Power Drift (dB)	0.07		
SAR 10g (W/Kg)	0.0522		

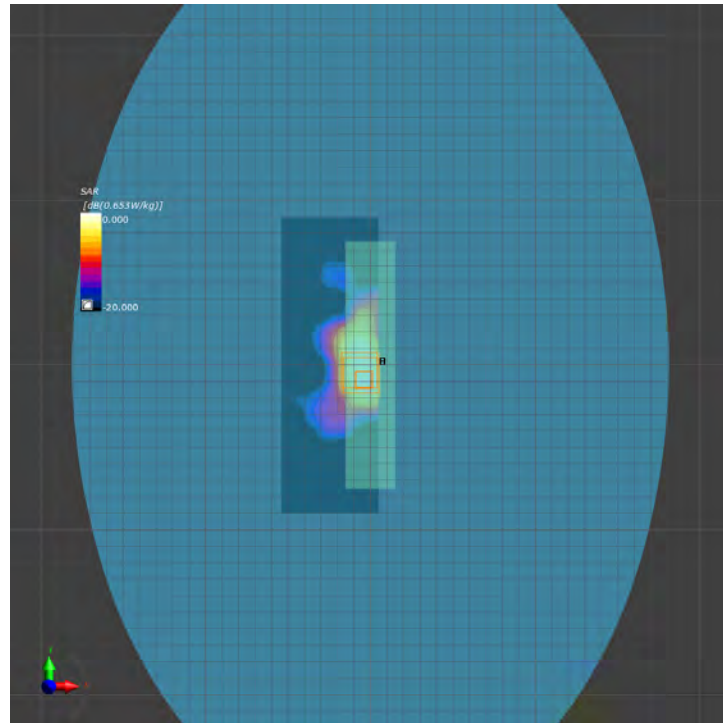

Area and Zoom Scan Plot

Test specification:	Body_High_802.11HT40-5230_Bottom_0mm		
Environ Conditions:	Temp(oC): 22	Result:	Pass
	Humidity (%): 45		
	Atmospheric(mPa): 1010		
Mains Power:	N/A		
Test Date:	04/23/2018 - 04/27/2018		
Tested by:	Cipher		
Remarks:	-		
Frequency (MHz)	5230 (Channel 46)		
Relative permittivity (real part)	48.3		
Conductivity (S/m)	5.30		
Probe SN	EX3DV4 - SN7469		
DAE SN	DAE4 Sn1522		
Conversion Factor (dB)	5.41		
Area Scan Resolution (mm)	14x14		
Zoom Scan Resolution (mm)	6x6x6		
Zoom Scan Size (mm)	30x30x30		
Power Drift (dB)	0.72		
SAR 10g (W/Kg)	0.0089		

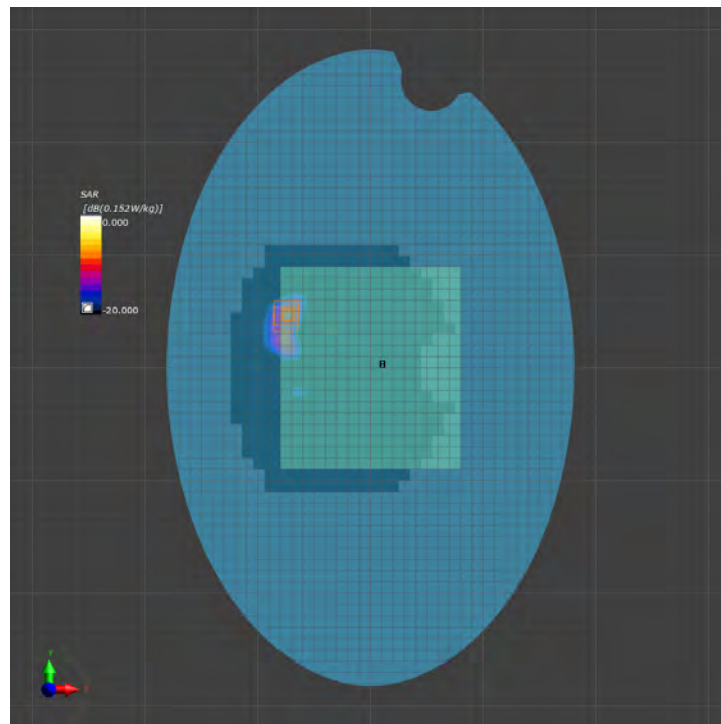

Area and Zoom Scan Plot

Test specification:	Body_Low_802.11HT40-5270_Leftside_0mm		
Environ Conditions:	Temp(oC): 22	Result:	Pass
	Humidity (%): 45		
	Atmospheric(mPa): 1010		
Mains Power:	N/A		
Test Date:	04/23/2018 - 04/27/2018		
Tested by:	Cipher		
Remarks:	-		
Frequency (MHz)	5270 (Channel 54)		
Relative permittivity (real part)	48.1		
Conductivity (S/m)	5.42		
Probe SN	EX3DV4 - SN7469		
DAE SN	DAE4 Sn1522		
Conversion Factor (dB)	5.41		
Area Scan Resolution (mm)	14x14		
Zoom Scan Resolution (mm)	6x6x6		
Zoom Scan Size (mm)	30x30x30		
Power Drift (dB)	0.07		
SAR 10g (W/Kg)	0.0501		

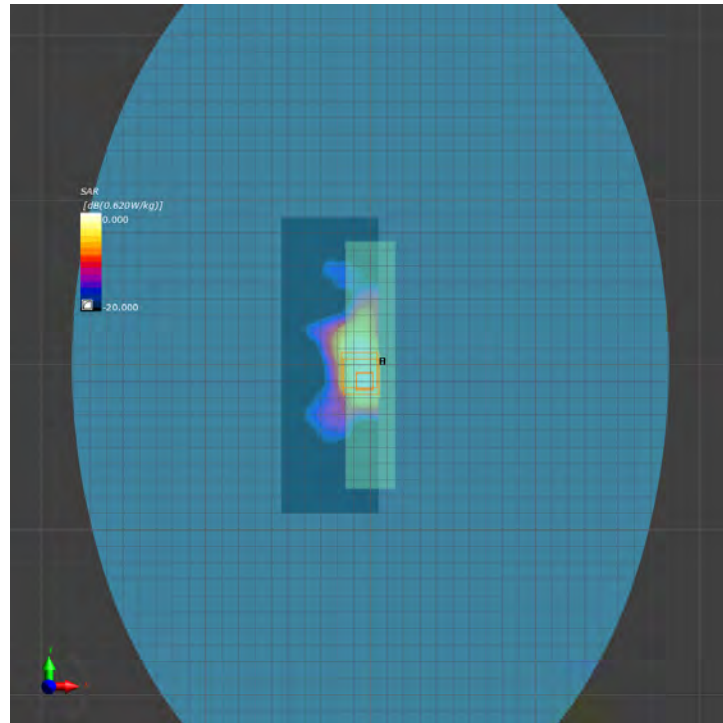

Area and Zoom Scan Plot

Test specification:	Body_Low_802.11HT40-5270_Bottom_0mm		
Environ Conditions:	Temp(oC): 22	Result:	Pass
	Humidity (%): 45		
	Atmospheric(mPa): 1010		
Mains Power:	N/A		
Test Date:	04/23/2018 - 04/27/2018		
Tested by:	Cipher		
Remarks:	-		
Frequency (MHz)	5270 (Channel 54)		
Relative permittivity (real part)	48.1		
Conductivity (S/m)	5.42		
Probe SN	EX3DV4 - SN7469		
DAE SN	DAE4 Sn1522		
Conversion Factor (dB)	5.41		
Area Scan Resolution (mm)	14x14		
Zoom Scan Resolution (mm)	6x6x6		
Zoom Scan Size (mm)	30x30x30		
Power Drift (dB)	0.04		
SAR 10g (W/Kg)	0.0093		

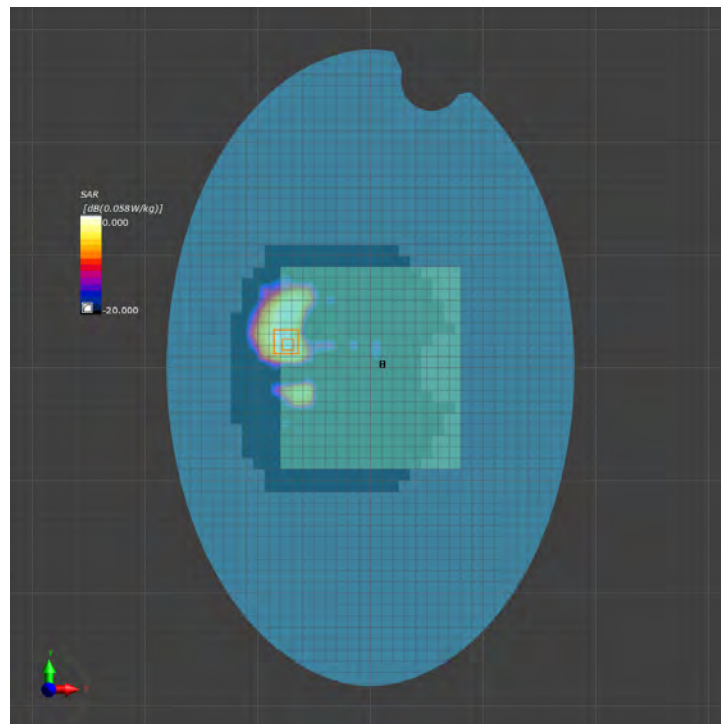

Area and Zoom Scan Plot

Test specification:	Body_High_802.11HT40-5310_Leftside_0mm		
Environ Conditions:	Temp(oC): 22	Result:	Pass
	Humidity (%): 45		
	Atmospheric(mPa): 1010		
Mains Power:	N/A		
Test Date:	04/23/2018 - 04/27/2018		
Tested by:	Cipher		
Remarks:	-		
Frequency (MHz)	5310 (Channel 62)		
Relative permittivity (real part)	48.1		
Conductivity (S/m)	5.47		
Probe SN	EX3DV4 - SN7469		
DAE SN	DAE4 Sn1522		
Conversion Factor (dB)	5.41		
Area Scan Resolution (mm)	14x14		
Zoom Scan Resolution (mm)	6x6x6		
Zoom Scan Size (mm)	30x30x30		
Power Drift (dB)	0.01		
SAR 10g (W/Kg)	0.0455		

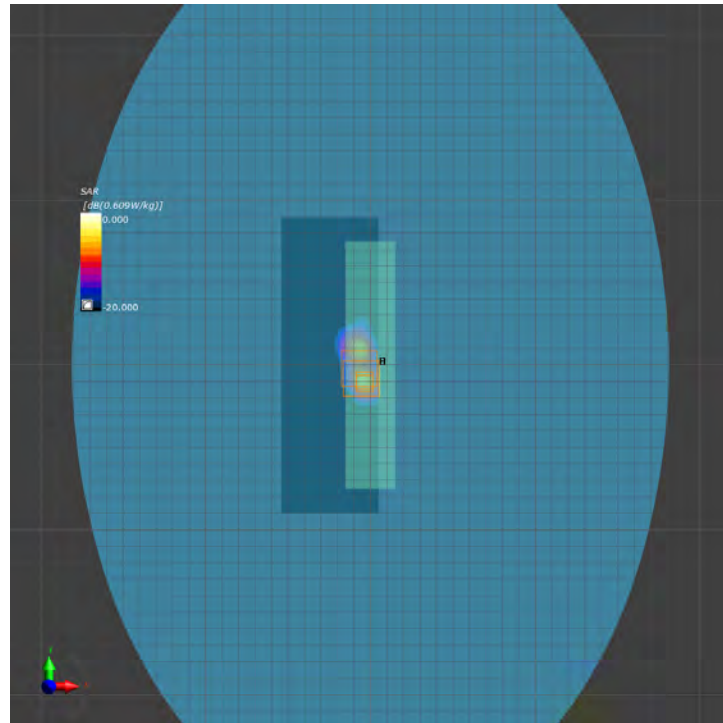

Area and Zoom Scan Plot

Test specification:	Body_Low_802.11HT40-5310_Bottom_0mm		
Environ Conditions:	Temp(oC): 22	Result:	Pass
	Humidity (%): 45		
	Atmospheric(mPa): 1010		
Mains Power:	N/A		
Test Date:	04/23/2018 - 04/27/2018		
Tested by:	Cipher		
Remarks:	-		
Frequency (MHz)	5310 (Channel 62)		
Relative permittivity (real part)	48.1		
Conductivity (S/m)	5.47		
Probe SN	EX3DV4 - SN7469		
DAE SN	DAE4 Sn1522		
Conversion Factor (dB)	5.41		
Area Scan Resolution (mm)	14x14		
Zoom Scan Resolution (mm)	6x6x6		
Zoom Scan Size (mm)	30x30x30		
Power Drift (dB)	0.57		
SAR 10g (W/Kg)	0.0294		

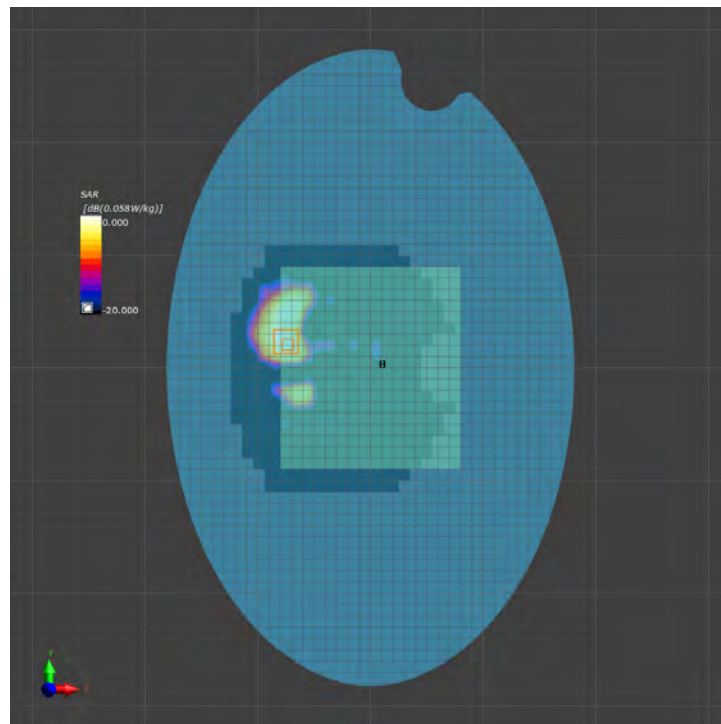

Area and Zoom Scan Plot

Test specification:	Body_Low_802.11HT40-5510_Leftside_0mm		
Environ Conditions:	Temp(oC): 22	Result:	Pass
	Humidity (%): 45		
	Atmospheric(mPa): 1010		
Mains Power:	N/A		
Test Date:	04/23/2018 - 04/27/2018		
Tested by:	Cipher		
Remarks:	-		
Frequency (MHz)	5510 (Channel 102)		
Relative permittivity (real part)	47.7		
Conductivity (S/m)	5.76		
Probe SN	EX3DV4 - SN7469		
DAE SN	DAE4 Sn1522		
Conversion Factor (dB)	4.65		
Area Scan Resolution (mm)	14x14		
Zoom Scan Resolution (mm)	6x6x6		
Zoom Scan Size (mm)	30x30x30		
Power Drift (dB)	0.01		
SAR 10g (W/Kg)	0.0502		

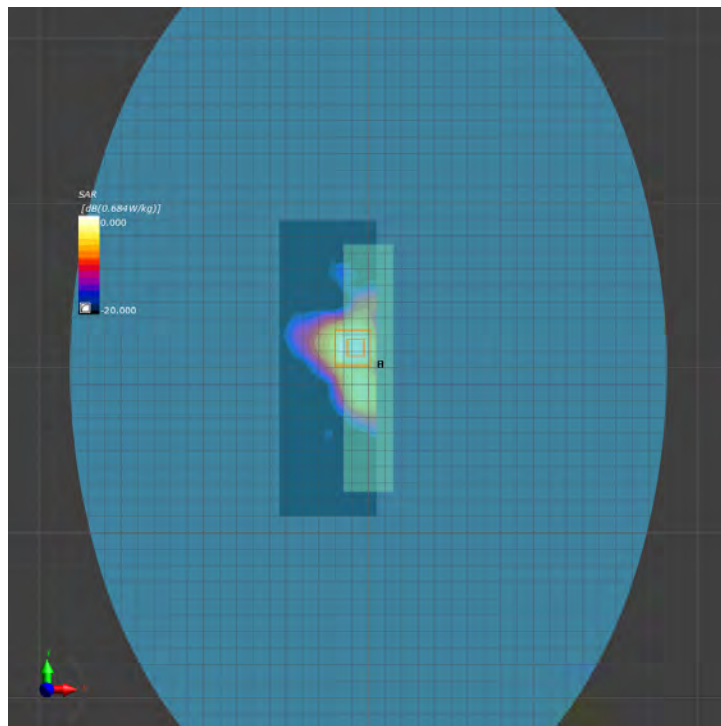

Area and Zoom Scan Plot

Test specification:	Body_Mid_802.11HT40-5550_Leftside_0mm		
Environ Conditions:	Temp(oC): 22	Result:	Pass
	Humidity (%): 45		
	Atmospheric(mPa): 1010		
Mains Power:	N/A		
Test Date:	04/23/2018 - 04/27/2018		
Tested by:	Cipher		
Remarks:	-		
Frequency (MHz)	5550 (Channel 110)		
Relative permittivity (real part)	47.5		
Conductivity (S/m)	5.87		
Probe SN	EX3DV4 - SN7469		
DAE SN	DAE4 Sn1522		
Conversion Factor (dB)	4.65		
Area Scan Resolution (mm)	14x14		
Zoom Scan Resolution (mm)	6x6x6		
Zoom Scan Size (mm)	30x30x30		
Power Drift (dB)	0.01		
SAR 10g (W/Kg)	0.0433		

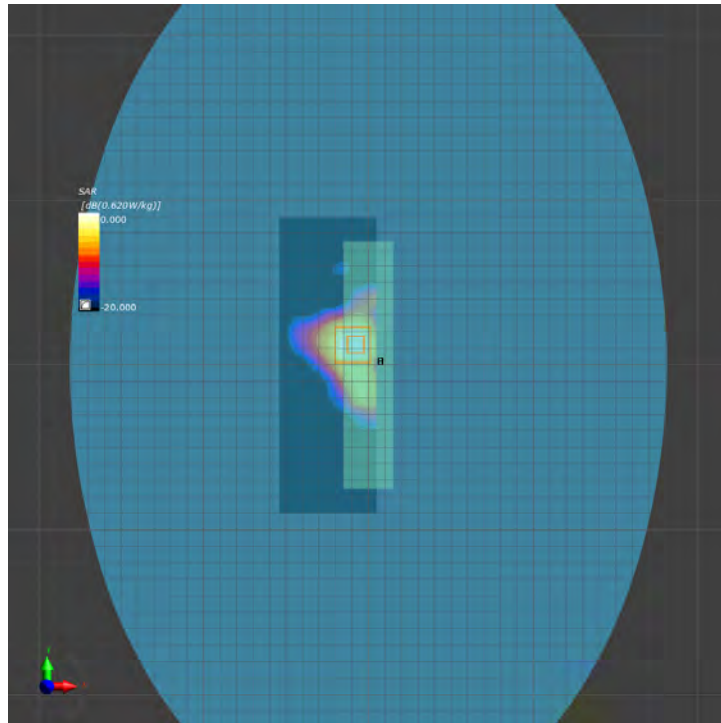

Area and Zoom Scan Plot

Test specification:	Body_Mid_802.11HT40-5550_Bottom_0mm		
Environ Conditions:	Temp(oC): 22	Result:	Pass
	Humidity (%): 45		
	Atmospheric(mPa): 1010		
Mains Power:	N/A		
Test Date:	04/23/2018 - 04/27/2018		
Tested by:	Cipher		
Remarks:	-		
Frequency (MHz)	5550 (Channel 110)		
Relative permittivity (real part)	47.5		
Conductivity (S/m)	5.87		
Probe SN	EX3DV4 - SN7469		
DAE SN	DAE4 Sn1522		
Conversion Factor (dB)	4.65		
Area Scan Resolution (mm)	14x14		
Zoom Scan Resolution (mm)	6x6x6		
Zoom Scan Size (mm)	30x30x30		
Power Drift (dB)	0.27		
SAR 10g (W/Kg)	0.031		

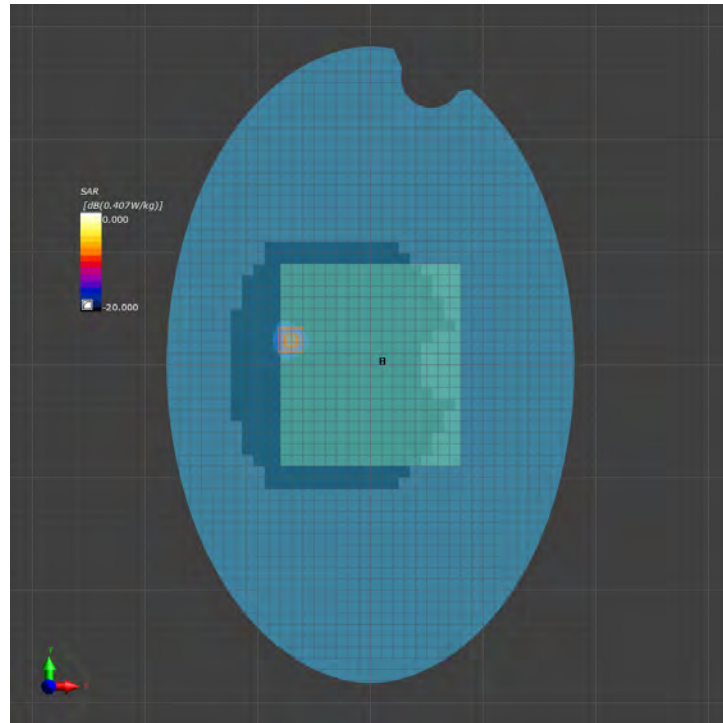

Area and Zoom Scan Plot

Test specification:	Body_High_802.11HT40-5670_Leftside_0mm		
Environ Conditions:	Temp(oC): 22	Result:	Pass
	Humidity (%): 45		
	Atmospheric(mPa): 1010		
Mains Power:	N/A		
Test Date:	04/23/2018 - 04/27/2018		
Tested by:	Cipher		
Remarks:	-		
Frequency (MHz)	5670 (Channel 142)		
Relative permittivity (real part)	47.4		
Conductivity (S/m)	5.99		
Probe SN	EX3DV4 - SN7469		
DAE SN	DAE4 Sn1522		
Conversion Factor (dB)	4.65		
Area Scan Resolution (mm)	14x14		
Zoom Scan Resolution (mm)	6x6x6		
Zoom Scan Size (mm)	30x30x30		
Power Drift (dB)	0.01		
SAR 10g (W/Kg)	0.0397		

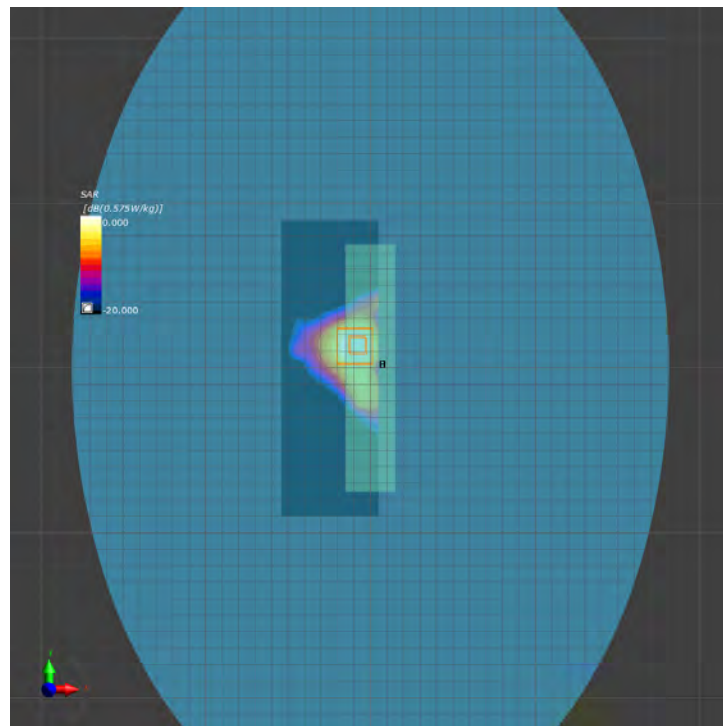

Area and Zoom Scan Plot

Test specification:	Body_Low_802.11HT40-5755_Leftside_0mm		
Environ Conditions:	Temp(oC): 22	Result:	Pass
	Humidity (%): 45		
	Atmospheric(mPa): 1010		
Mains Power:	N/A		
Test Date:	04/23/2018 - 04/27/2018		
Tested by:	Cipher		
Remarks:	-		
Frequency (MHz)	5775 (Channel 151)		
Relative permittivity (real part)	47.2		
Conductivity (S/m)	6.12		
Probe SN	EX3DV4 - SN7469		
DAE SN	DAE4 Sn1522		
Conversion Factor (dB)	4.9		
Area Scan Resolution (mm)	14x14		
Zoom Scan Resolution (mm)	6x6x6		
Zoom Scan Size (mm)	30x30x30		
Power Drift (dB)	0.01		
SAR 10g (W/Kg)	0.0535		

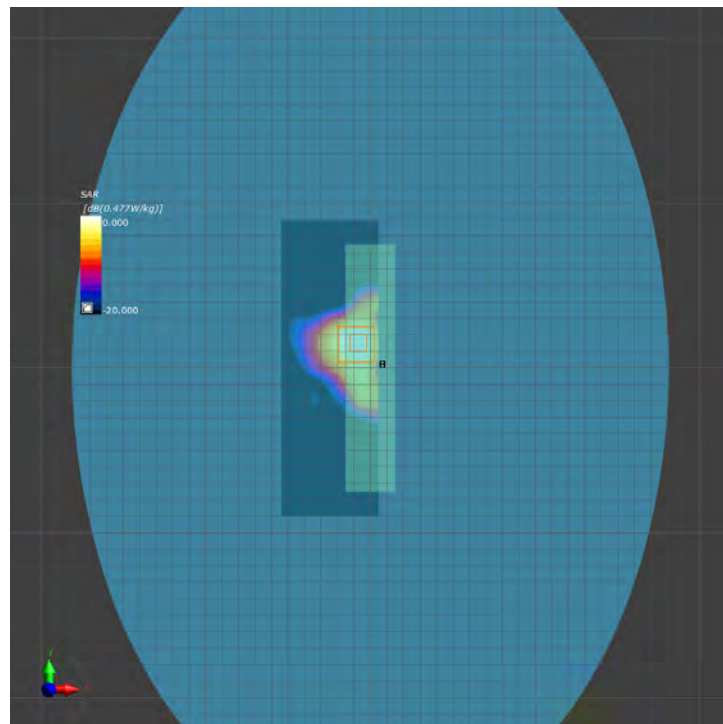

Area and Zoom Scan Plot

Test specification:	Body_Low_802.11HT40-5755_Bottom_0mm		
Environ Conditions:	Temp(oC): 22	Result:	Pass
	Humidity (%): 45		
	Atmospheric(mPa): 1010		
Mains Power:	N/A		
Test Date:	04/23/2018 - 04/27/2018		
Tested by:	Cipher		
Remarks:	-		
Frequency (MHz)	5755 (Channel 151)		
Relative permittivity (real part)	47.2		
Conductivity (S/m)	6.12		
Probe SN	EX3DV4 - SN7469		
DAE SN	DAE4 Sn1522		
Conversion Factor (dB)	4.9		
Area Scan Resolution (mm)	14x14		
Zoom Scan Resolution (mm)	6x6x6		
Zoom Scan Size (mm)	30x30x30		
Power Drift (dB)	0.51		
SAR 10g (W/Kg)	0.032		

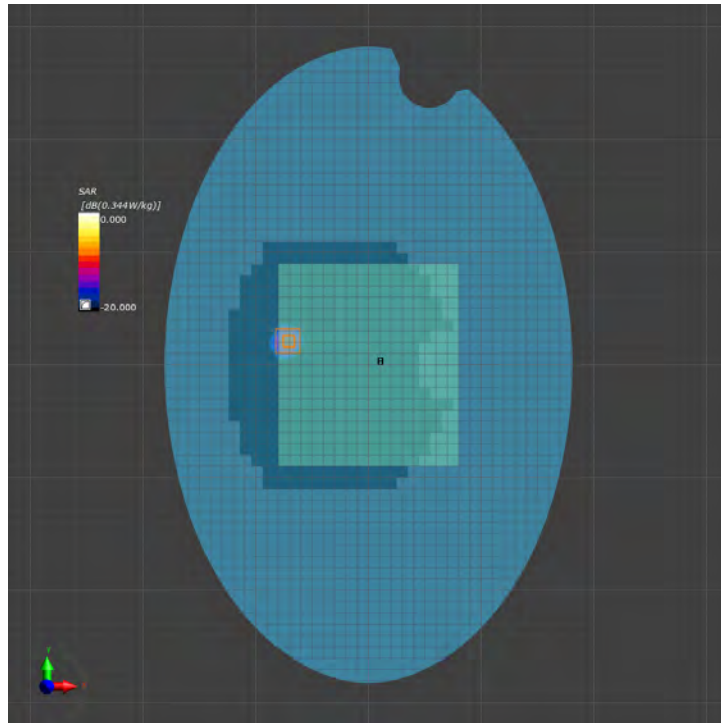

Area and Zoom Scan Plot

Test specification:	Body_High_802.11HT40-5795_Leftside_0mm		
Environ Conditions:	Temp(oC): 22	Result:	Pass
	Humidity (%): 45		
	Atmospheric(mPa): 1010		
Mains Power:	N/A		
Test Date:	04/23/2018 - 04/27/2018		
Tested by:	Cipher		
Remarks:	-		
Frequency (MHz)	5795 (Channel 159)		
Relative permittivity (real part)	47.1		
Conductivity (S/m)	6.18		
Probe SN	EX3DV4 - SN7469		
DAE SN	DAE4 Sn1522		
Conversion Factor (dB)	4.9		
Area Scan Resolution (mm)	14x14		
Zoom Scan Resolution (mm)	6x6x6		
Zoom Scan Size (mm)	30x30x30		
Power Drift (dB)	0.01		
SAR 10g (W/Kg)	0.0463		

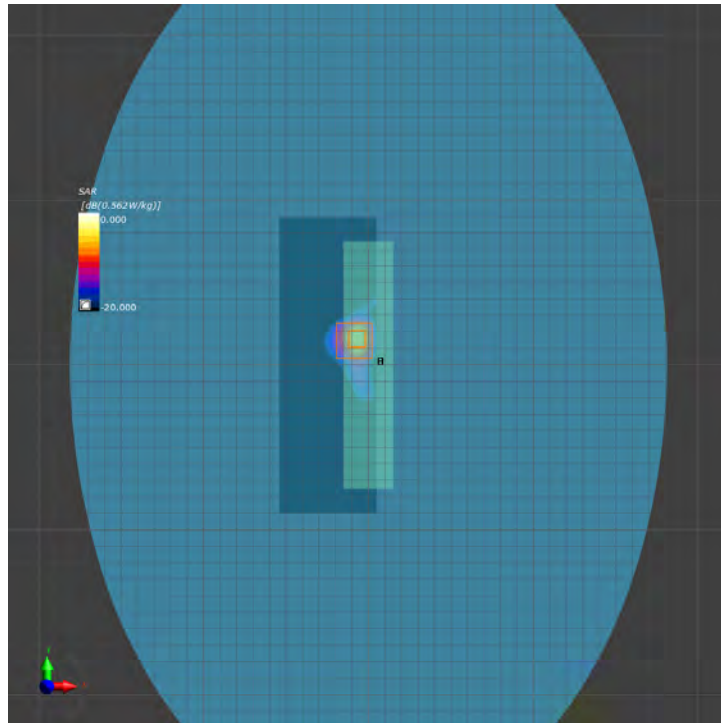

Area and Zoom Scan Plot

Test specification:	Body_High_802.11HT40-5795_Bottom_0mm		
Environ Conditions:	Temp(oC): 22	Result:	Pass
	Humidity (%): 45		
	Atmospheric(mPa): 1010		
Mains Power:	N/A		
Test Date:	04/23/2018 - 04/27/2018		
Tested by:	Cipher		
Remarks:	-		
Frequency (MHz)	5795 (Channel 159)		
Relative permittivity (real part)	47.1		
Conductivity (S/m)	6.18		
Probe SN	EX3DV4 - SN7469		
DAE SN	DAE4 Sn1522		
Conversion Factor (dB)	4.9		
Area Scan Resolution (mm)	14x14		
Zoom Scan Resolution (mm)	6x6x6		
Zoom Scan Size (mm)	30x30x30		
Power Drift (dB)	0.31		
SAR 10g (W/Kg)	0.026		

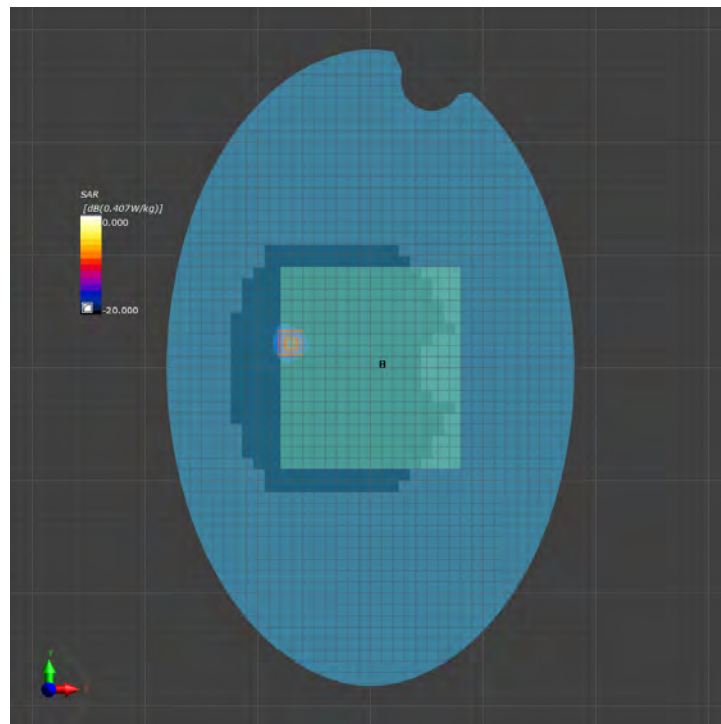

Area and Zoom Scan Plot

802.11VHT-80

Test specification:	Body_Low_802.11VHT80-5210_Leftside_0mm		
Environ Conditions:	Temp(oC): 22	Result:	Pass
	Humidity (%): 45		
	Atmospheric(mPa): 1010		
Mains Power:	N/A		
Test Date:	04/23/2018 - 04/27/2018		
Tested by:	Cipher		
Remarks:	-		
Frequency (MHz)	5210 (Channel 42)		
Relative permittivity (real part)	48.3		
Conductivity (S/m)	5.33		
Probe SN	EX3DV4 - SN7469		
DAE SN	DAE4 Sn1522		
Conversion Factor (dB)	5.41		
Area Scan Resolution (mm)	14x14		
Zoom Scan Resolution (mm)	6x6x6		
Zoom Scan Size (mm)	30x30x30		
Power Drift (dB)	0.01		
SAR 10g (W/Kg)	0.0149		

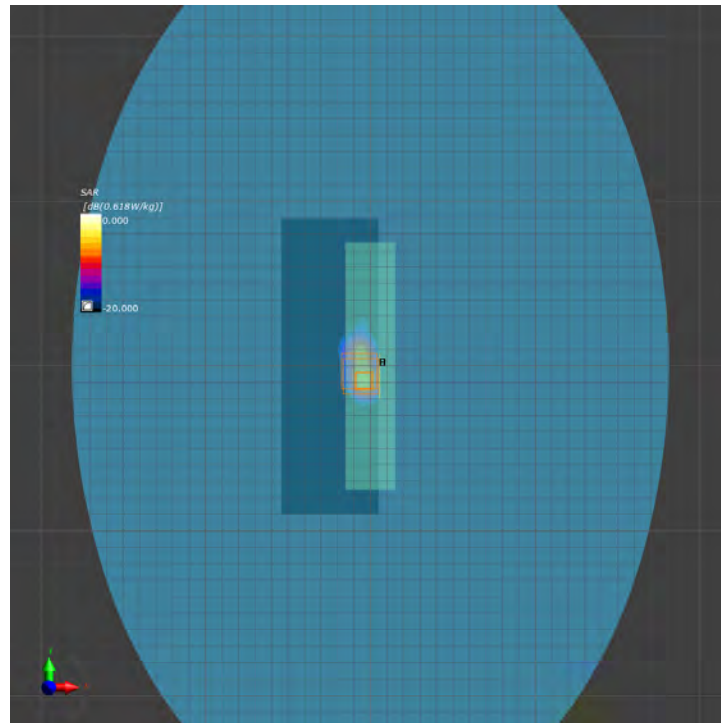

Area and Zoom Scan Plot

Test specification:	Body_Low_802.11VHT80-5210_Bottom_0mm		
Environ Conditions:	Temp(oC): 22	Result:	Pass
	Humidity (%): 45		
	Atmospheric(mPa): 1010		
Mains Power:	N/A		
Test Date:	04/23/2018 - 04/27/2018		
Tested by:	Cipher		
Remarks:	-		
Frequency (MHz)	5210 (Channel 42)		
Relative permittivity (real part)	48.3		
Conductivity (S/m)	5.33		
Probe SN	EX3DV4 - SN7469		
DAE SN	DAE4 Sn1522		
Conversion Factor (dB)	5.41		
Area Scan Resolution (mm)	14x14		
Zoom Scan Resolution (mm)	6x6x6		
Zoom Scan Size (mm)	30x30x30		
Power Drift (dB)	0.01		
SAR 10g (W/Kg)	0.0204		

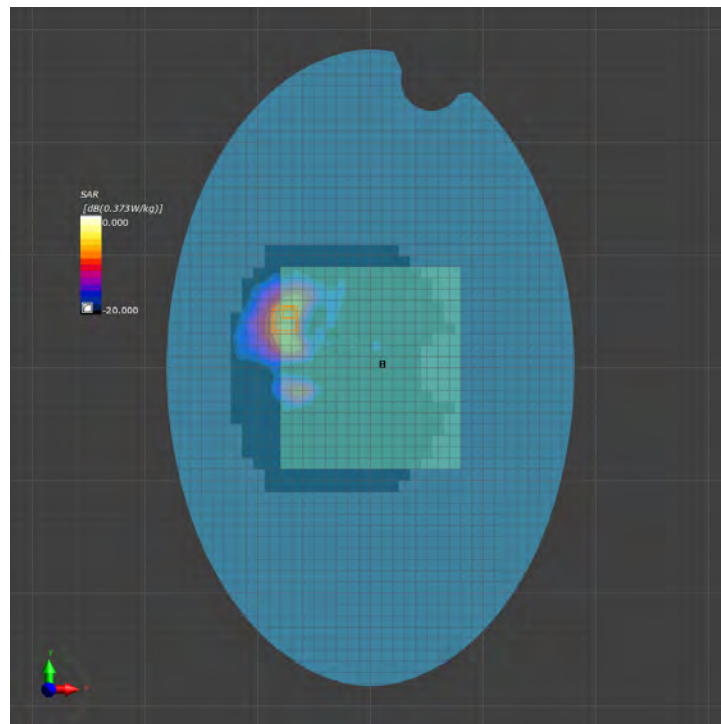

Area and Zoom Scan Plot

Test specification:	Body_High_802.11VHT80-5290_Leftside_0mm		
Environ Conditions:	Temp(oC): 22	Result:	Pass
	Humidity (%): 45		
	Atmospheric(mPa): 1010		
Mains Power:	N/A		
Test Date:	04/23/2018 - 04/27/2018		
Tested by:	Cipher		
Remarks:	-		
Frequency (MHz)	5290 (Channel 58)		
Relative permittivity (real part)	48.1		
Conductivity (S/m)	5.44		
Probe SN	EX3DV4 - SN7469		
DAE SN	DAE4 Sn1522		
Conversion Factor (dB)	5.41		
Area Scan Resolution (mm)	14x14		
Zoom Scan Resolution (mm)	6x6x6		
Zoom Scan Size (mm)	30x30x30		
Power Drift (dB)	0.01		
SAR 10g (W/Kg)	0.0103		

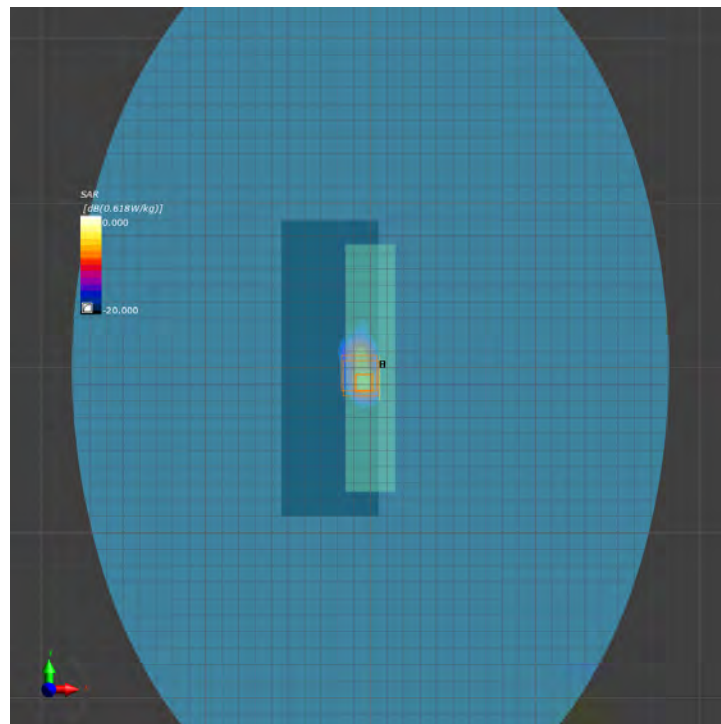

Area and Zoom Scan Plot

Test specification:	Body_High_802.11VHT80-5290_Bottom_0mm		
Environ Conditions:	Temp(oC): 22	Result:	Pass
	Humidity (%): 45		
	Atmospheric(mPa): 1010		
Mains Power:	N/A		
Test Date:	04/23/2018 - 04/27/2018		
Tested by:	Cipher		
Remarks:	-		
Frequency (MHz)	5290 (Channel 58)		
Relative permittivity (real part)	48.1		
Conductivity (S/m)	5.44		
Probe SN	EX3DV4 - SN7469		
DAE SN	DAE4 Sn1522		
Conversion Factor (dB)	5.41		
Area Scan Resolution (mm)	14x14		
Zoom Scan Resolution (mm)	6x6x6		
Zoom Scan Size (mm)	30x30x30		
Power Drift (dB)	0.01		
SAR 10g (W/Kg)	0.0343		

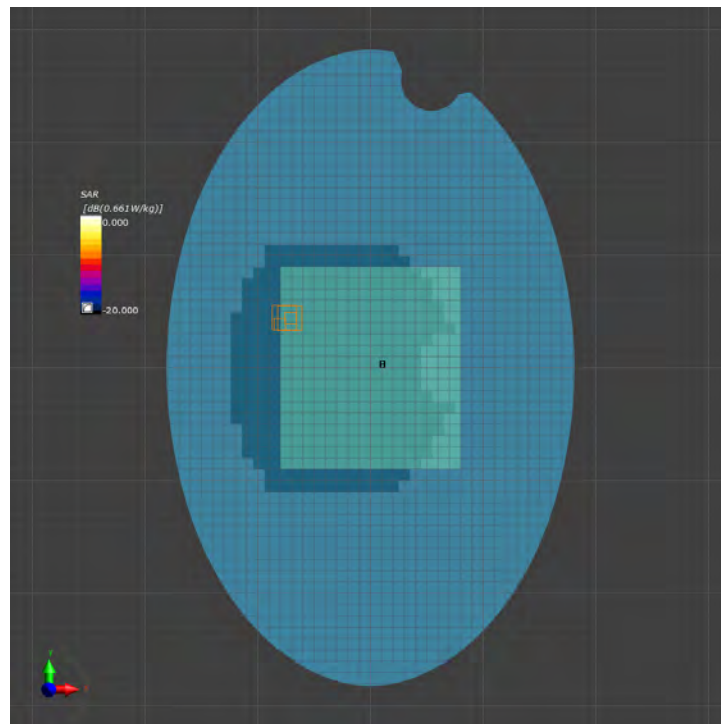

Area and Zoom Scan Plot

Test specification:	Body_Low_802.11VHT80-5530_Leftside_0mm		
Environ Conditions:	Temp(oC): 22	Result:	Pass
	Humidity (%): 45		
	Atmospheric(mPa): 1010		
Mains Power:	N/A		
Test Date:	04/23/2018 - 04/27/2018		
Tested by:	Cipher		
Remarks:	-		
Frequency (MHz)	5530 (Channel 106)		
Relative permittivity (real part)	47.6		
Conductivity (S/m)	5.78		
Probe SN	EX3DV4 - SN7469		
DAE SN	DAE4 Sn1522		
Conversion Factor (dB)	4.65		
Area Scan Resolution (mm)	14x14		
Zoom Scan Resolution (mm)	6x6x6		
Zoom Scan Size (mm)	30x30x30		
Power Drift (dB)	0.05		
SAR 10g (W/Kg)	0.0104		

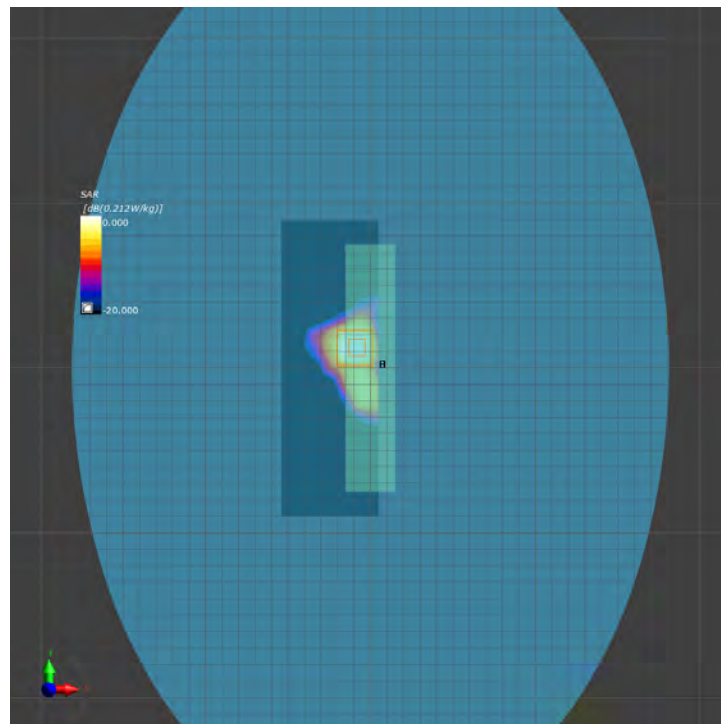

Area and Zoom Scan Plot

Test specification:	Body_Low_802.11VHT80-5530_Bottom_0mm		
Environ Conditions:	Temp(oC): 22	Result:	Pass
	Humidity (%): 45		
	Atmospheric(mPa): 1010		
Mains Power:	N/A		
Test Date:	04/23/2018 - 04/27/2018		
Tested by:	Cipher		
Remarks:	-		
Frequency (MHz)	5530 (Channel 106)		
Relative permittivity (real part)	47.6		
Conductivity (S/m)	5.78		
Probe SN	EX3DV4 - SN7469		
DAE SN	DAE4 Sn1522		
Conversion Factor (dB)	4.65		
Area Scan Resolution (mm)	14x14		
Zoom Scan Resolution (mm)	6x6x6		
Zoom Scan Size (mm)	30x30x30		
Power Drift (dB)	0.29		
SAR 10g (W/Kg)	0.0423		

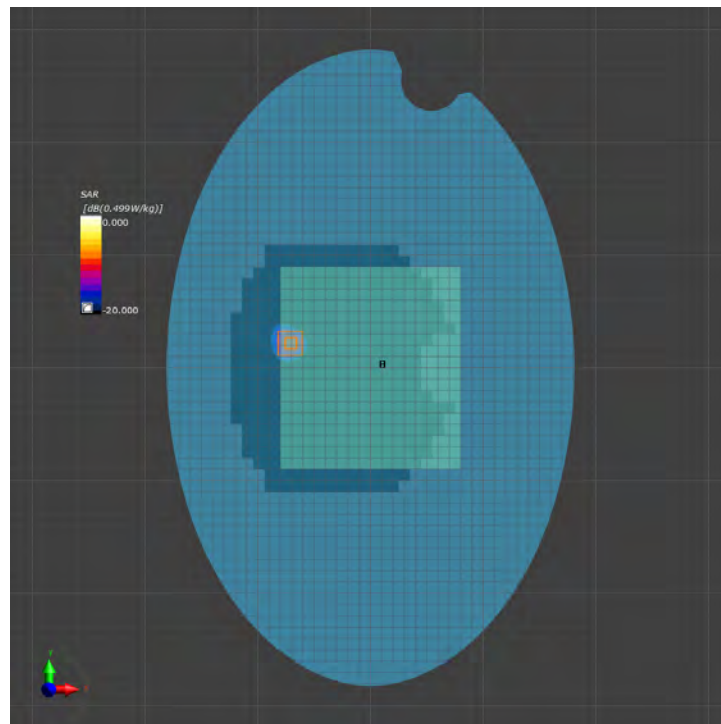

Area and Zoom Scan Plot

Test specification:	Body_Mid_802.11VHT80-5610_Leftside_0mm		
Environ Conditions:	Temp(oC): 22	Result:	Pass
	Humidity (%): 45		
	Atmospheric(mPa): 1010		
Mains Power:	N/A		
Test Date:	04/23/2018 - 04/27/2018		
Tested by:	Cipher		
Remarks:	-		
Frequency (MHz)	5610 (Channel 122)		
Relative permittivity (real part)	47.5		
Conductivity (S/m)	5.91		
Probe SN	EX3DV4 - SN7469		
DAE SN	DAE4 Sn1522		
Conversion Factor (dB)	4.65		
Area Scan Resolution (mm)	14x14		
Zoom Scan Resolution (mm)	6x6x6		
Zoom Scan Size (mm)	30x30x30		
Power Drift (dB)	0.01		
SAR 10g (W/Kg)	0.0059		

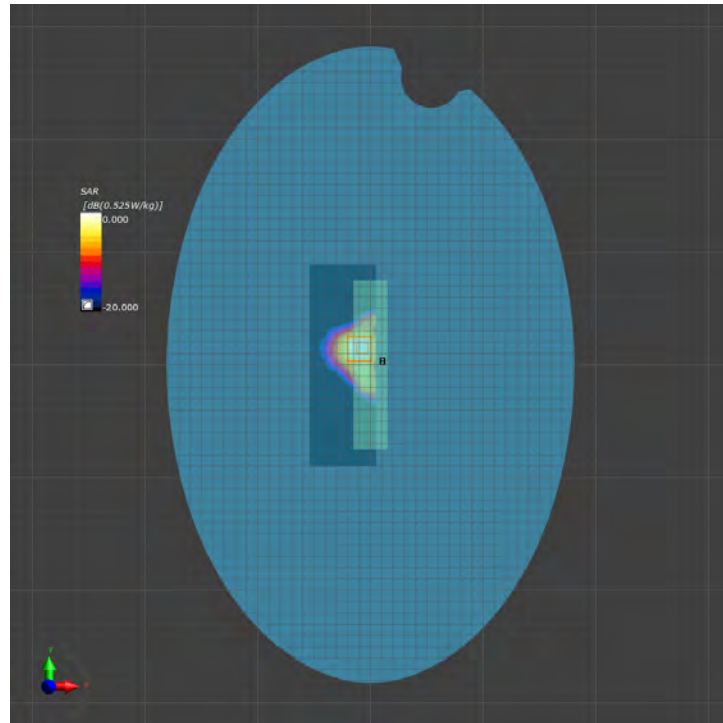

Area and Zoom Scan Plot

Test specification:	Body_Low_802.11VHT80-5610_Bottom_0mm		
Environ Conditions:	Temp(oC): 22	Result:	Pass
	Humidity (%): 45		
	Atmospheric(mPa): 1010		
Mains Power:	N/A		
Test Date:	04/23/2018 - 04/27/2018		
Tested by:	Cipher		
Remarks:	-		
Frequency (MHz)	5610 (Channel 122)		
Relative permittivity (real part)	47.5		
Conductivity (S/m)	5.91		
Probe SN	EX3DV4 - SN7469		
DAE SN	DAE4 Sn1522		
Conversion Factor (dB)	4.65		
Area Scan Resolution (mm)	14x14		
Zoom Scan Resolution (mm)	6x6x6		
Zoom Scan Size (mm)	30x30x30		
Power Drift (dB)	0.47		
SAR 10g (W/Kg)	0.0409		

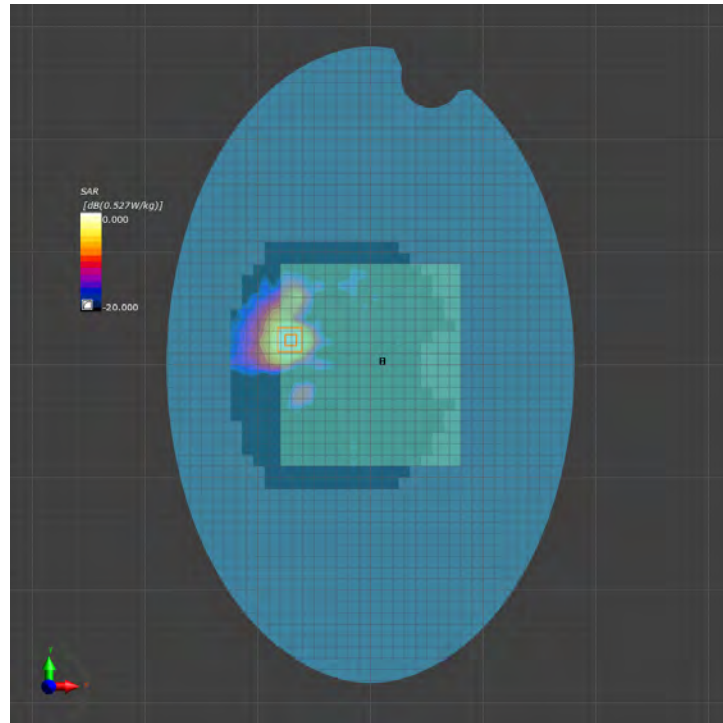

Area and Zoom Scan Plot

Test specification:	Body_Low_802.11VHT80-5775_Leftside_0mm		
Environ Conditions:	Temp(oC): 22	Result:	Pass
	Humidity (%): 45		
	Atmospheric(mPa): 1010		
Mains Power:	N/A		
Test Date:	04/23/2018 - 04/27/2018		
Tested by:	Cipher		
Remarks:	-		
Frequency (MHz)	5775 (Channel 155)		
Relative permittivity (real part)	47.2		
Conductivity (S/m)	6.15		
Probe SN	EX3DV4 - SN7469		
DAE SN	DAE4 Sn1522		
Conversion Factor (dB)	4.9		
Area Scan Resolution (mm)	14x14		
Zoom Scan Resolution (mm)	6x6x6		
Zoom Scan Size (mm)	30x30x30		
Power Drift (dB)	0.01		
SAR 10g (W/Kg)	0.0057		

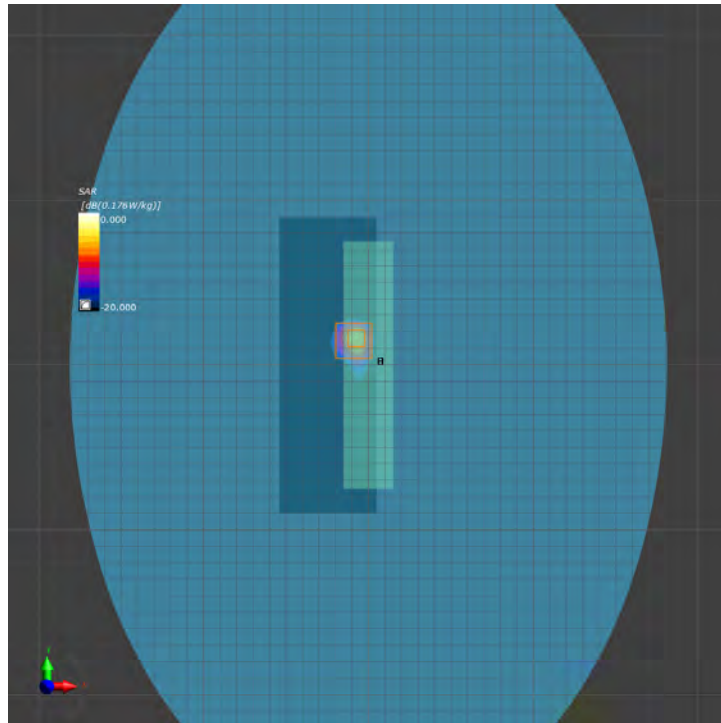

Area and Zoom Scan Plot

Test specification:	Body_Low_802.11VHT80-5775_Bottom_0mm		
Environ Conditions:	Temp(oC): 22	Result:	Pass
	Humidity (%): 45		
	Atmospheric(mPa): 1010		
Mains Power:	N/A		
Test Date:	04/23/2018 - 04/27/2018		
Tested by:	Cipher		
Remarks:	-		
Frequency (MHz)	5775 (Channel 155)		
Relative permittivity (real part)	47.2		
Conductivity (S/m)	6.15		
Probe SN	EX3DV4 - SN7469		
DAE SN	DAE4 Sn1522		
Conversion Factor (dB)	4.9		
Area Scan Resolution (mm)	14x14		
Zoom Scan Resolution (mm)	6x6x6		
Zoom Scan Size (mm)	30x30x30		
Power Drift (dB)	0.01		
SAR 10g (W/Kg)	0.0377		

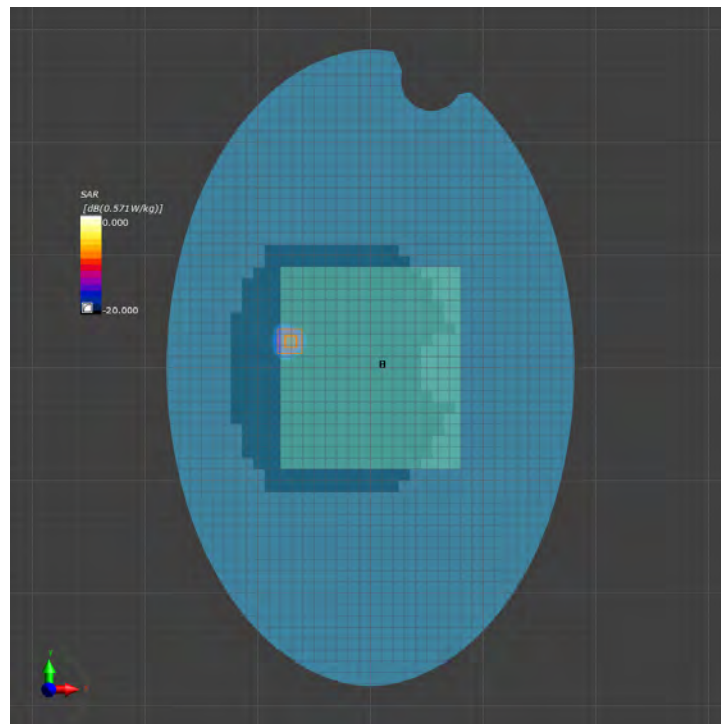

























Area and Zoom Scan Plot

Annex A. TEST INSTRUMENT

Instrument	Model	Serial #	Cal Date	Cal Cycle	Cal Due	In use
SAR						
P C	Dell-U2417H	CN-OXVNNT-WS200-7AE-AONW-AO5	N/A	N/A	N/A	<input checked="" type="checkbox"/>
MXG Vector Signal Generator	N5182A	MY47071065	06/28/2017	1 Year	06/28/2018	<input checked="" type="checkbox"/>
Digital Thermometer	DTM3000	1259033	N/A	N/A	N/A	<input checked="" type="checkbox"/>
S-Parameter Network Analyzer	8753ES	US38161019	11/10/2017	1 Year	11/10/2018	<input checked="" type="checkbox"/>
Data Acquisition Electronics (DAE)	DAE4	1522	08/21/2017	1 Year	08/21/2018	<input checked="" type="checkbox"/>
Data Acquisition Electronics (DAE)	MSTV1	2000H5	08/21/2017	1 Year	08/21/2018	<input checked="" type="checkbox"/>
E-field PROBE	EX3DV4	7469	08/21/2017	1 Year	08/21/2018	<input checked="" type="checkbox"/>
Mother Scan Teaching PROBE	TP6V2	N/A	08/21/2017	1 Year	08/21/2018	<input checked="" type="checkbox"/>
Dipole 2450 MHz	D2450V2	1002	08/17/2017	1 Year	08/17/2018	<input checked="" type="checkbox"/>
Dipole 5.1-5.8 GHz	D5GHzV2	1267	08/17/2017	1 Year	08/17/2018	<input checked="" type="checkbox"/>
Dielectric parameter probes	DAK3.5 probe	1261	08/22/2017	1 Year	08/22/2018	<input checked="" type="checkbox"/>
Light Beam Unit	LB5/80	1037	N/A	N/A	N/A	<input checked="" type="checkbox"/>
Modulation and Interference Analyzer	MAIA	1313	N/A	N/A	N/A	<input type="checkbox"/>
Omni-Directional Ultra-Wideband	ANT	1116	N/A	N/A	N/A	<input checked="" type="checkbox"/>
DUMMY PROBE	None	SN 31/10	N/A	N/A	N/A	<input type="checkbox"/>
SAM-TWIN PHANTOM	Twin-SAM V8.0	1929	N/A	N/A	N/A	<input type="checkbox"/>
ELI Phantom	ELI V8.0	2071	N/A	N/A	N/A	<input checked="" type="checkbox"/>
PHANTOM TABLE	N/A	N/A	N/A	N/A	N/A	<input checked="" type="checkbox"/>
6 AXIS ROBOT	Staubli Tx 60 L	N/A	N/A	N/A	N/A	<input checked="" type="checkbox"/>

Annex B. SIEMIC Accreditation

Accreditations	Document	Scope / Remark
ISO 17025 (A2LA)		Please see the documents for the detailed scope
ISO Guide 65 (A2LA)		Please see the documents for the detailed scope
TCB Designation		A1 , A2 , A3 , A4 , B1 , B2 , B3 , B4 , C
FCC DoC Accreditation		FCC Declaration of Conformity Accreditation
FCC Site Registration		3 meter site
FCC Site Registration		10 meter site
IC Site Registration		3 meter site
IC Site Registration		10 meter site
EU NB		Radio & Telecommunications Terminal Equipment: EN45001 – EN ISO/IEC 17025
		Electromagnetic Compatibility: EN45001 – EN ISO/IEC 17025
Singapore iDA CB(Certification Body)	 	Phase I , Phase II
Vietnam MIC CAB Accreditation		Please see the document for the detailed scope
Hong Kong OFCA		(Phase II) OFCA Foreign Certification Body for Radio and Telecom
		(Phase I) Conformity Assessment Body for Radio and Telecom
Industry Canada CAB		Radio: Scope A – All Radio Standard Specification in Category I
		Telecom: CS-03 Part I, II, V, VI, VII, VIII

Japan Recognized Certification Body Designation	 	Radio: A1. Terminal equipment for purpose of calling Telecom: B1. Specified radio equipment specified in Article 38-2, Paragraph 1, Item 1 of the Radio Law
Korea CAB Accreditation		EMI: KCC Notice 2008-39, RRL Notice 2008-3: CA Procedures for EMI KN22: Test Method for EMIEMS: KCC Notice 2008-38, RRL Notice 2008-4: CA Procedures for EMS KN24, KN61000-4-2, -4-3, -4-4, -4-5, -4-6, -4-8, -4-11: Test Method for EMS
		Radio: RRL Notice 2008-26, RRL Notice 2008-2, RRL Notice 2008-10, RRL Notice 2007-49, RRL Notice 2007-20, RRL Notice 2007-21, RRL Notice 2007-80, RRL Notice 2004-68 Telecom: President Notice 20664, RRL Notice 2007-30, RRL Notice 2008-7 with attachments 1, 3, 5, 6; President Notice 20664, RRL Notice 2008-7 with attachment 4
Taiwan NCC CAB Recognition		LP0002, PSTN01, ADSL01, ID0002, IS6100, CNS14336, PLMN07, PLMN01, PLMN08
Taiwan BSMI CAB Recognition		CNS 13438
Japan VCCI		R-3083: Radiation 3 meter site C-3421: Main Ports Conducted Interference Measurement T-1597: Telecommunication Ports Conducted Interference Measurement
Australia CAB Recognition		EMC: AS/NZS CISPR 11, AS/NZS CISPR 14.1, AS/NZS CISPR22, AS/NZS 61000.6.3, AS/NZS 61000.6.4
		Radio communications: AS/NZS 4281, AS/NZS 4268, AS/NZS 4280.1, AS/NZS 4280.2, AS/NZS 4295, AS/NZS 4582, AS/NZS 4583, AS/NZS 4769.1, AS/NZS 4769.2, AS/NZS 4770, AS/NZS 4771
		Telecommunications: AS/ACIF S002:05, AS/ACIF S003:06, AS/ACIF S004:06, AS/ACIF S006:01, AS/ACIF S016:01, AS/ACIF S031:01, AS/ACIF S038:01, AS/ACIF S040:01, AS/ACIF S041:05, AS/ACIF S043.2:06, AS/ACIF S60950.1
Australia NATA Recognition		AS/ACIF S002, AS/ACIF S003, AS/ACIF S004, AS/ACIF S006, AS/ACIF S016, AS/ACIF S031, AS/ACIF S038, AS/ACIF S040, AS/ACIF S041, AS/ACIF S043.2

Annex C. Probe Calibration Report

**Calibration Laboratory of
Schmid & Partner
Engineering AG**
Zeughausstrasse 43, 8004 Zurich, Switzerland



S Schweizerischer Kalibrierdienst
C Service suisse d'étalonnage
S Servizio svizzero di taratura
S Swiss Calibration Service

Accredited by the Swiss Accreditation Service (SAS)
The Swiss Accreditation Service is one of the signatories to the EA
Multilateral Agreement for the recognition of calibration certificates

Accreditation No.: **SCS 0108**

Client **SIEMIC Inc**

Certificate No: **EX3-7469_Aug17**

CALIBRATION CERTIFICATE

Object	EX3DV4 - SN:7469
Calibration procedure(s)	QA CAL-01.v9, QA CAL-14.v4, QA CAL-23.v5, QA CAL-25.v6 Calibration procedure for dosimetric E-field probes
Calibration date:	August 21, 2017
<p>This calibration certificate documents the traceability to national standards, which realize the physical units of measurements (SI). The measurements and the uncertainties with confidence probability are given on the following pages and are part of the certificate.</p> <p>All calibrations have been conducted in the closed laboratory facility: environment temperature (22 ± 3)°C and humidity < 70%.</p> <p>Calibration Equipment used (M&TE critical for calibration)</p>	

Primary Standards	ID	Cal Date (Certificate No.)	Scheduled Calibration
Power meter NRP	SN: 104778	04-Apr-17 (No. 217-02521/02522)	Apr-18
Power sensor NRP-Z91	SN: 103244	04-Apr-17 (No. 217-02521)	Apr-18
Power sensor NRP-Z91	SN: 103245	04-Apr-17 (No. 217-02525)	Apr-18
Reference 20 dB Attenuator	SN: S5277 (20x)	07-Apr-17 (No. 217-02528)	Apr-18
Reference Probe ES3DV2	SN: 3013	31-Dec-16 (No. ES3-3013_Dec16)	Dec-17
DAE4	SN: 660	7-Dec-16 (No. DAE4-660_Dec16)	Dec-17
Secondary Standards	ID	Check Date (in house)	Scheduled Check
Power meter E4419B	SN: GB41293874	06-Apr-16 (in house check Jun-16)	In house check: Jun-18
Power sensor E4412A	SN: MY41498087	06-Apr-16 (in house check Jun-16)	In house check: Jun-18
Power sensor E4412A	SN: 000110210	06-Apr-16 (in house check Jun-16)	In house check: Jun-18
RF generator HP 8648C	SN: US3642U01700	04-Aug-99 (in house check Jun-16)	In house check: Jun-18
Network Analyzer HP 8753E	SN: US37390585	18-Oct-01 (in house check Oct-16)	In house check: Oct-17

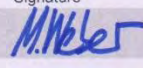
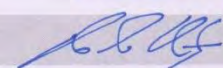
Calibrated by:	Name Michael Weber	Function Laboratory Technician	Signature 
Approved by:	Name Katja Pokovic	Technical Manager	
Issued: August 22, 2017			
This calibration certificate shall not be reproduced except in full without written approval of the laboratory.			

**Calibration Laboratory of
Schmid & Partner
Engineering AG**
Zeughausstrasse 43, 8004 Zurich, Switzerland



S Schweizerischer Kalibrierdienst
C Service suisse d'étalonnage
S Servizio svizzero di taratura
Swiss Calibration Service

Accredited by the Swiss Accreditation Service (SAS)
The Swiss Accreditation Service is one of the signatories to the EA
Multilateral Agreement for the recognition of calibration certificates

Accreditation No.: **SCS 0108**

Glossary:

TSL	tissue simulating liquid
NORM _{x,y,z}	sensitivity in free space
ConvF	sensitivity in TSL / NORM _{x,y,z}
DCP	diode compression point
CF	crest factor (1/duty_cycle) of the RF signal
A, B, C, D	modulation dependent linearization parameters
Polarization ϕ	ϕ rotation around probe axis
Polarization ϑ	ϑ rotation around an axis that is in the plane normal to probe axis (at measurement center), i.e., $\vartheta = 0$ is normal to probe axis
Connector Angle	information used in DASY system to align probe sensor X to the robot coordinate system

Calibration is Performed According to the Following Standards:

- IEEE Std 1528-2013, "IEEE Recommended Practice for Determining the Peak Spatial-Averaged Specific Absorption Rate (SAR) in the Human Head from Wireless Communications Devices: Measurement Techniques", June 2013
- IEC 62209-1, "Measurement procedure for the assessment of Specific Absorption Rate (SAR) from hand-held and body-mounted devices used next to the ear (frequency range of 300 MHz to 6 GHz)", July 2016
- IEC 62209-2, "Procedure to determine the Specific Absorption Rate (SAR) for wireless communication devices used in close proximity to the human body (frequency range of 30 MHz to 6 GHz)", March 2010
- KDB 865664, "SAR Measurement Requirements for 100 MHz to 6 GHz"

Methods Applied and Interpretation of Parameters:

- NORM_{x,y,z}:** Assessed for E-field polarization $\vartheta = 0$ ($f \leq 900$ MHz in TEM-cell; $f > 1800$ MHz: R22 waveguide). NORM_{x,y,z} are only intermediate values, i.e., the uncertainties of NORM_{x,y,z} does not affect the E²-field uncertainty inside TSL (see below ConvF).
- NORM(f)_{x,y,z} = NORM_{x,y,z} * frequency_response** (see Frequency Response Chart). This linearization is implemented in DASY4 software versions later than 4.2. The uncertainty of the frequency response is included in the stated uncertainty of ConvF.
- DCP_{x,y,z}:** DCP are numerical linearization parameters assessed based on the data of power sweep with CW signal (no uncertainty required). DCP does not depend on frequency nor media.
- PAR:** PAR is the Peak to Average Ratio that is not calibrated but determined based on the signal characteristics
- A_{x,y,z}; B_{x,y,z}; C_{x,y,z}; D_{x,y,z}; VR_{x,y,z}:** A, B, C, D are numerical linearization parameters assessed based on the data of power sweep for specific modulation signal. The parameters do not depend on frequency nor media. VR is the maximum calibration range expressed in RMS voltage across the diode.
- ConvF and Boundary Effect Parameters:** Assessed in flat phantom using E-field (or Temperature Transfer Standard for $f \leq 800$ MHz) and inside waveguide using analytical field distributions based on power measurements for $f > 800$ MHz. The same setups are used for assessment of the parameters applied for boundary compensation (alpha, depth) of which typical uncertainty values are given. These parameters are used in DASY4 software to improve probe accuracy close to the boundary. The sensitivity in TSL corresponds to NORM_{x,y,z} * ConvF whereby the uncertainty corresponds to that given for ConvF. A frequency dependent ConvF is used in DASY version 4.4 and higher which allows extending the validity from ± 50 MHz to ± 100 MHz.
- Spherical isotropy (3D deviation from isotropy):** in a field of low gradients realized using a flat phantom exposed by a patch antenna.
- Sensor Offset:** The sensor offset corresponds to the offset of virtual measurement center from the probe tip (on probe axis). No tolerance required.
- Connector Angle:** The angle is assessed using the information gained by determining the NORM_x (no uncertainty required).

EX3DV4 – SN:7469

August 21, 2017

Probe EX3DV4

SN:7469

Manufactured: October 25, 2016
Calibrated: August 21, 2017

Calibrated for DASY/EASY Systems
(Note: non-compatible with DASY2 system!)

EX3DV4- SN:7469

August 21, 2017

DASY/EASY - Parameters of Probe: EX3DV4 - SN:7469

Basic Calibration Parameters

	Sensor X	Sensor Y	Sensor Z	Unc (k=2)
Norm ($\mu\text{V}/(\text{V}/\text{m})^2$) ^A	0.45	0.45	0.57	$\pm 10.1\%$
DCP (mV) ^B	99.0	97.0	92.5	

Modulation Calibration Parameters

UID	Communication System Name		A dB	B dB $\sqrt{\mu\text{V}}$	C	D dB	VR mV	Unc ^E (k=2)
0	CW	X	0.0	0.0	1.0	0.00	139.7	$\pm 3.3\%$
		Y	0.0	0.0	1.0		142.6	
		Z	0.0	0.0	1.0		143.0	

Note: For details on UID parameters see Appendix.

Sensor Model Parameters

	C1 fF	C2 fF	α V ⁻¹	T1 ms.V ⁻²	T2 ms.V ⁻¹	T3 ms	T4 V ⁻²	T5 V ⁻¹	T6
X	33.29	249.7	36.00	8.132	0	5.025	0.000	0.333	1.003
Y	32.92	246.5	35.79	5.819	0	5.006	0.000	0.326	1.002
Z	45.41	349.0	37.55	8.873	0	5.004	0.655	0.392	1.007

The reported uncertainty of measurement is stated as the standard uncertainty of measurement multiplied by the coverage factor k=2, which for a normal distribution corresponds to a coverage probability of approximately 95%.

^A The uncertainties of Norm X,Y,Z do not affect the E²-field uncertainty inside TSL (see Pages 5 and 6).

^B Numerical linearization parameter: uncertainty not required.

^E Uncertainty is determined using the max. deviation from linear response applying rectangular distribution and is expressed for the square of the field value.

EX3DV4- SN:7469

August 21, 2017

DASY/EASY - Parameters of Probe: EX3DV4 - SN:7469

Calibration Parameter Determined in Head Tissue Simulating Media

f (MHz) ^C	Relative Permittivity ^F	Conductivity (S/m) ^F	ConvF X	ConvF Y	ConvF Z	Alpha ^G	Depth (mm) ^G	Unc (k=2)
835	41.5	0.90	11.14	11.14	11.14	0.54	0.80	± 12.0 %
900	41.5	0.97	10.84	10.84	10.84	0.47	0.81	± 12.0 %
1750	40.1	1.37	9.41	9.41	9.41	0.36	0.85	± 12.0 %
1900	40.0	1.40	9.08	9.08	9.08	0.35	0.85	± 12.0 %
2450	39.2	1.80	8.25	8.25	8.25	0.32	0.94	± 12.0 %
5250	35.9	4.71	6.14	6.14	6.14	0.35	1.80	± 13.1 %
5600	35.5	5.07	5.41	5.41	5.41	0.40	1.80	± 13.1 %
5750	35.4	5.22	5.79	5.79	5.79	0.40	1.80	± 13.1 %

^C Frequency validity above 300 MHz of ± 100 MHz only applies for DASY v4.4 and higher (see Page 2), else it is restricted to ± 50 MHz. The uncertainty is the RSS of the ConvF uncertainty at calibration frequency and the uncertainty for the indicated frequency band. Frequency validity below 300 MHz is ± 10, 25, 40, 50 and 70 MHz for ConvF assessments at 30, 64, 128, 150 and 220 MHz respectively. Above 5 GHz frequency validity can be extended to ± 110 MHz.

^F At frequencies below 3 GHz, the validity of tissue parameters (ϵ and σ) can be relaxed to ± 10% if liquid compensation formula is applied to measured SAR values. At frequencies above 3 GHz, the validity of tissue parameters (ϵ and σ) is restricted to ± 5%. The uncertainty is the RSS of the ConvF uncertainty for indicated target tissue parameters.

^G Alpha/Depth are determined during calibration. SPEAG warrants that the remaining deviation due to the boundary effect after compensation is always less than ± 1% for frequencies below 3 GHz and below ± 2% for frequencies between 3-6 GHz at any distance larger than half the probe tip diameter from the boundary.

EX3DV4- SN:7469

August 21, 2017

DASY/EASY - Parameters of Probe: EX3DV4 - SN:7469

Calibration Parameter Determined in Body Tissue Simulating Media

f (MHz) ^C	Relative Permittivity ^F	Conductivity (S/m) ^F	ConvF X	ConvF Y	ConvF Z	Alpha ^G	Depth ^G (mm)	Unc (k=2)
835	55.2	0.97	11.09	11.09	11.09	0.44	0.80	± 12.0 %
900	55.0	1.05	10.93	10.93	10.93	0.48	0.80	± 12.0 %
1750	53.4	1.49	9.38	9.38	9.38	0.30	0.95	± 12.0 %
1900	53.3	1.52	8.90	8.90	8.90	0.42	0.92	± 12.0 %
2450	52.7	1.95	8.50	8.50	8.50	0.39	0.90	± 12.0 %
5250	48.9	5.36	5.41	5.41	5.41	0.40	1.90	± 13.1 %
5600	48.5	5.77	4.65	4.65	4.65	0.45	1.90	± 13.1 %
5750	48.3	5.94	4.90	4.90	4.90	0.50	1.90	± 13.1 %

^C Frequency validity above 300 MHz of ± 100 MHz only applies for DASY v4.4 and higher (see Page 2), else it is restricted to ± 50 MHz. The uncertainty is the RSS of the ConvF uncertainty at calibration frequency and the uncertainty for the indicated frequency band. Frequency validity below 300 MHz is ± 10, 25, 40, 50 and 70 MHz for ConvF assessments at 30, 64, 128, 150 and 220 MHz respectively. Above 5 GHz frequency validity can be extended to ± 110 MHz.

^F At frequencies below 3 GHz, the validity of tissue parameters (ϵ and σ) can be relaxed to ± 10% if liquid compensation formula is applied to measured SAR values. At frequencies above 3 GHz, the validity of tissue parameters (ϵ and σ) is restricted to ± 5%. The uncertainty is the RSS of the ConvF uncertainty for indicated target tissue parameters.

^G Alpha/Depth are determined during calibration. SPEAG warrants that the remaining deviation due to the boundary effect after compensation is always less than ± 1% for frequencies below 3 GHz and below ± 2% for frequencies between 3-6 GHz at any distance larger than half the probe tip diameter from the boundary.

EX3DV4- SN:7469

August 21, 2017

Frequency Response of E-Field (TEM-Cell:ifi110 EXX, Waveguide: R22)

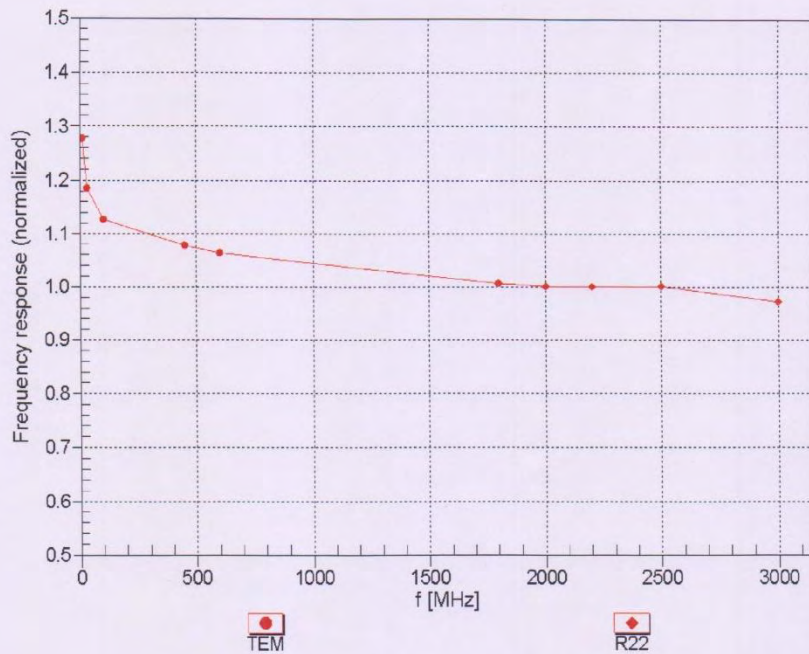

Uncertainty of Frequency Response of E-field: $\pm 6.3\%$ (k=2)

EX3DV4- SN:7469

August 21, 2017

Receiving Pattern (ϕ), $\theta = 0^\circ$

f=600 MHz, TEM

f=1800 MHz, R22

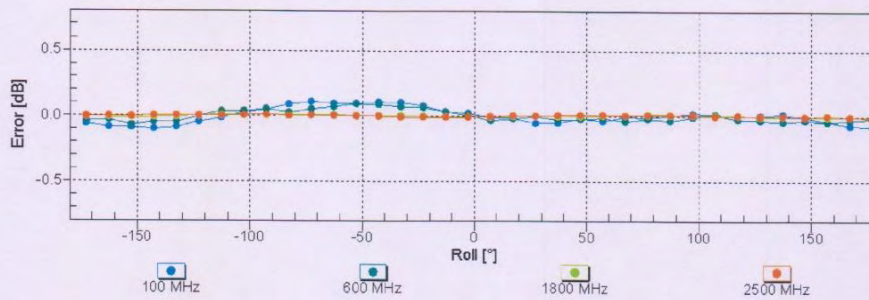
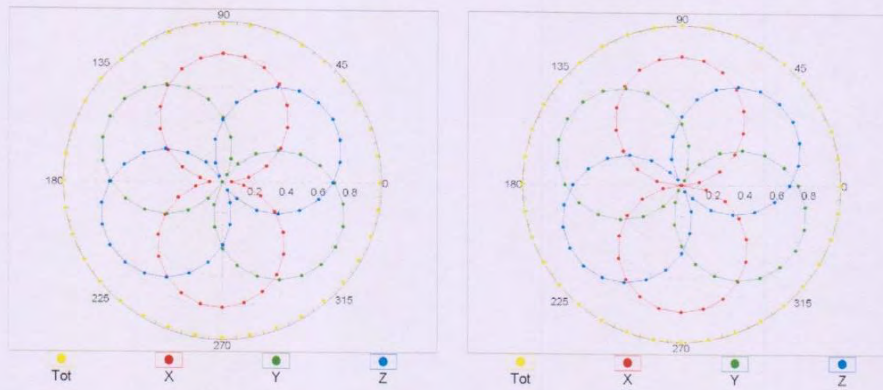

Uncertainty of Axial Isotropy Assessment: $\pm 0.5\%$ (k=2)

EX3DV4- SN:7469

August 21, 2017

Dynamic Range $f(SAR_{head})$ (TEM cell, $f_{eval} = 1900$ MHz)

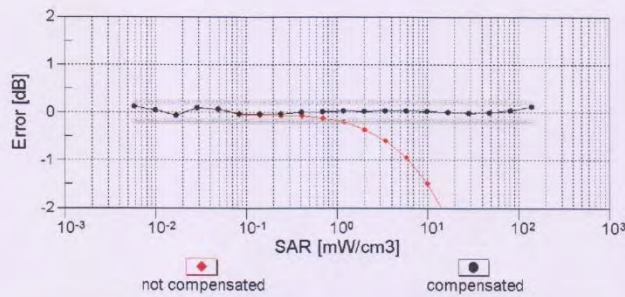
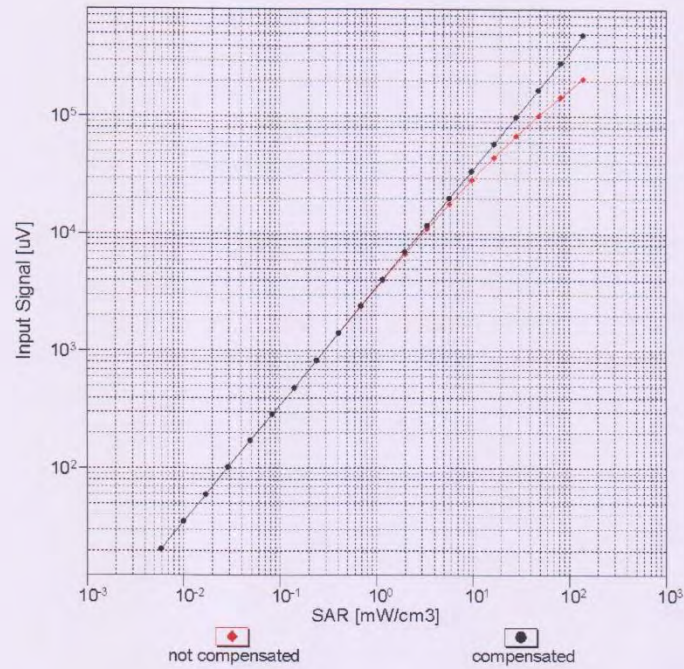

Uncertainty of Linearity Assessment: $\pm 0.6\%$ (k=2)