



SETUP PHOTOS EXHIBIT

Report Number: R14089411-EP2

Applicant : Ademco Inc.
251 Little Falls Drive
Wilmington, DE 19808, USA

Model : CASPIAN

FCC ID : HS9-VBSP02L5

IC : 573R-VBSP02L5

HVIN : VB-SP02Y-002

EUT Description : Water Shutoff Actuator

Test Standard(s) : FCC 47 CFR PART 15 SUBPART C
ISED RSS-247 ISSUE 2
ISED RSS-GEN ISSUE 5 + A1

Date Of Issue:
2022-10-12

Prepared by:
UL LLC
12 Laboratory Dr.
Research Triangle Park, NC 27709 U.S.A.
TEL: (919) 549-1400



REPORT REVISION HISTORY

Rev.	Issue Date	Revisions	Revised By
v1	2022-07-18	Initial Issue	Niklas Haydon
v2	2022-10-12	Added HVIN	Brian Kiewra

TABLE OF CONTENTS

REPORT REVISION HISTORY	2
TABLE OF CONTENTS	3
1. SETUP DIAGRAMS	4
2. SETUP PHOTOS.....	5
END OF TEST REPORT	13

1. SETUP DIAGRAMS

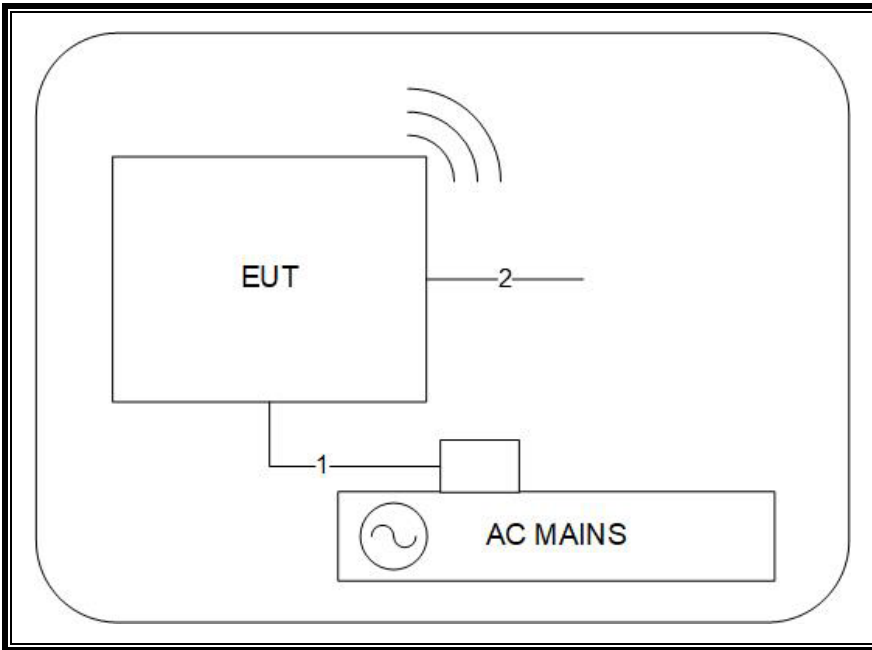

*Note: Port 2 is left unterminated since this cable was used for configuration purposes only.

2. SETUP PHOTOS

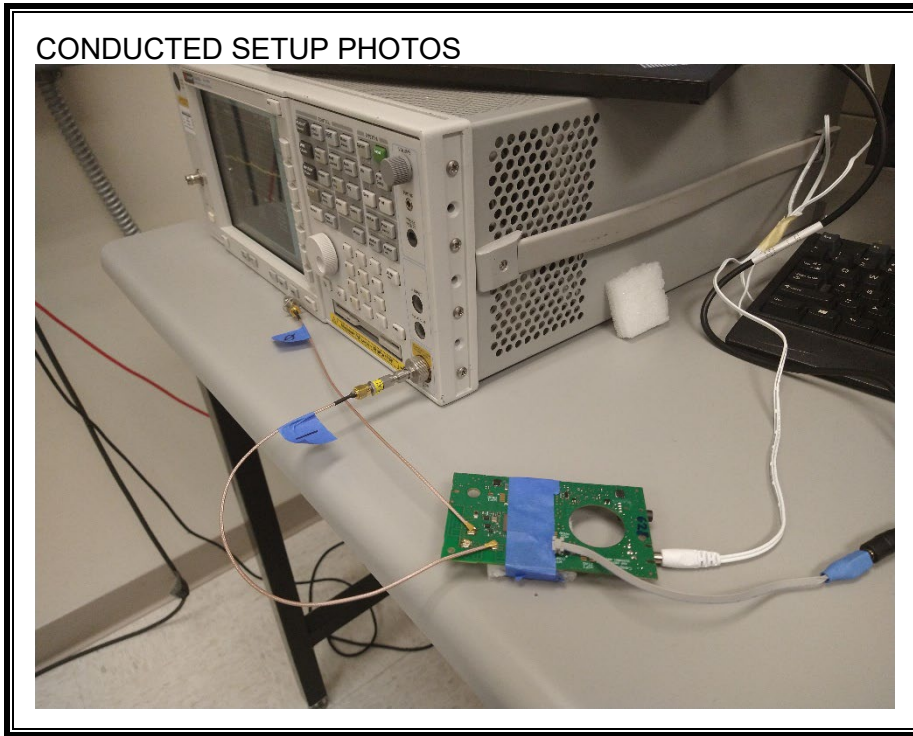

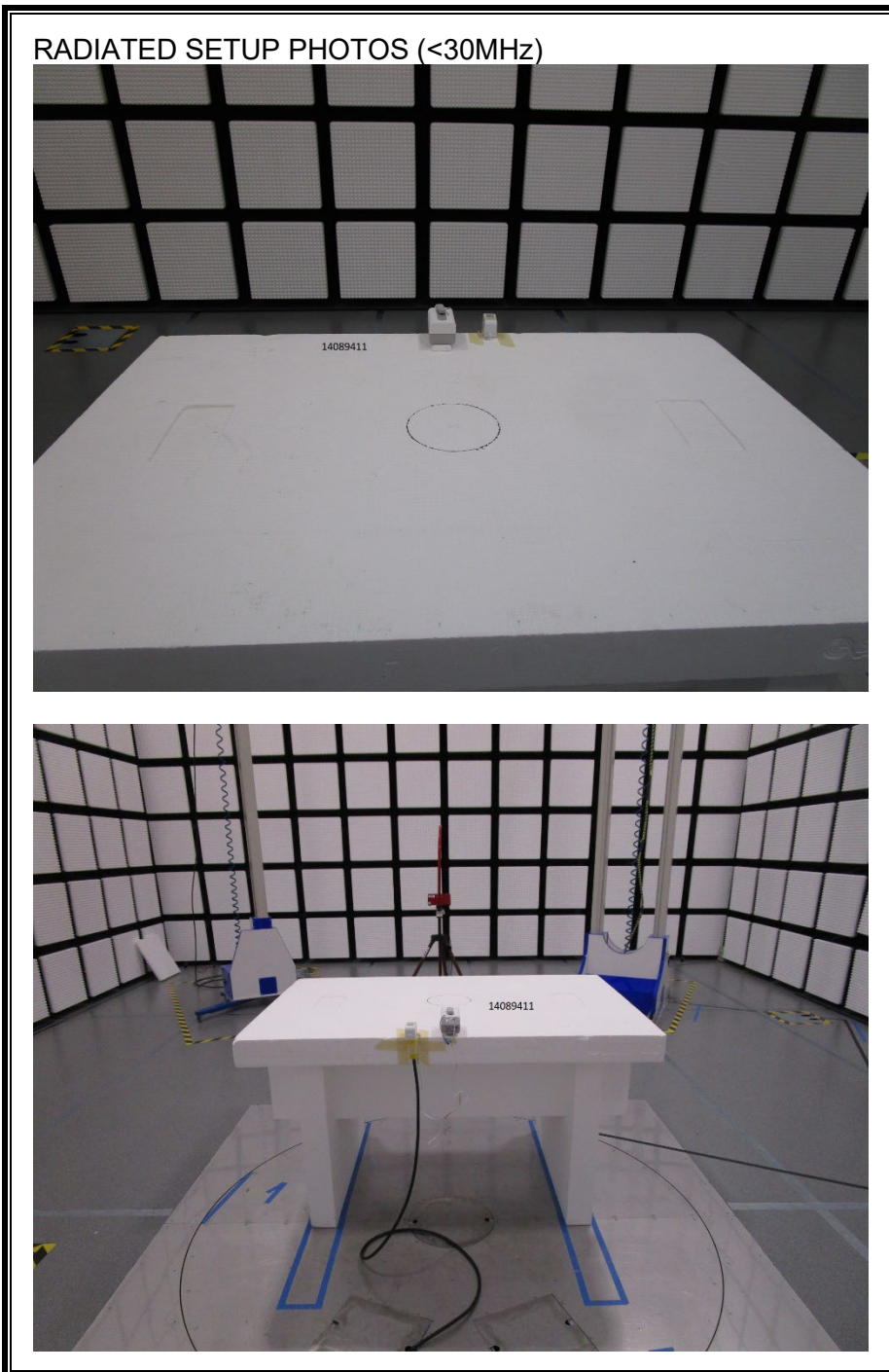

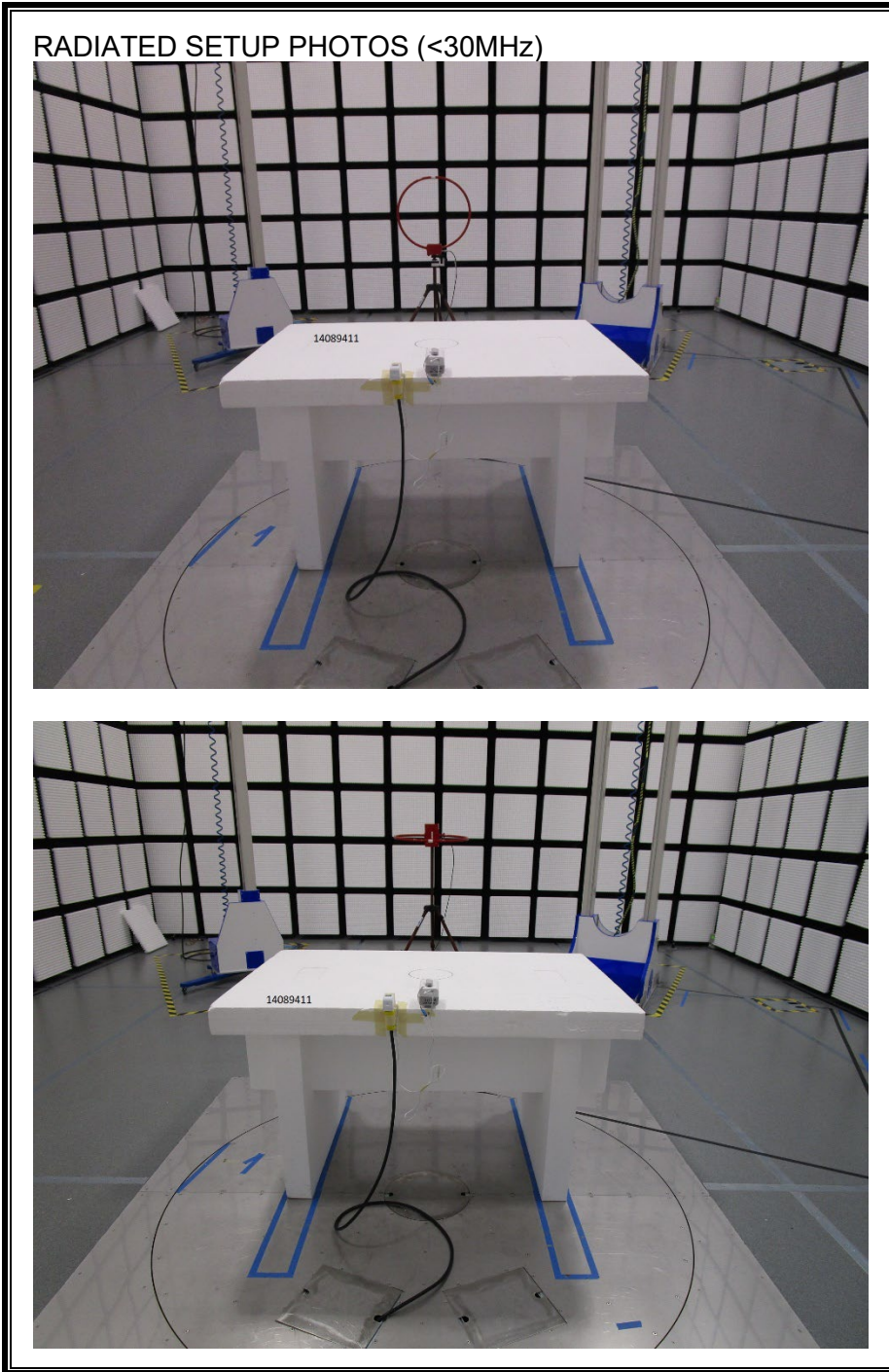

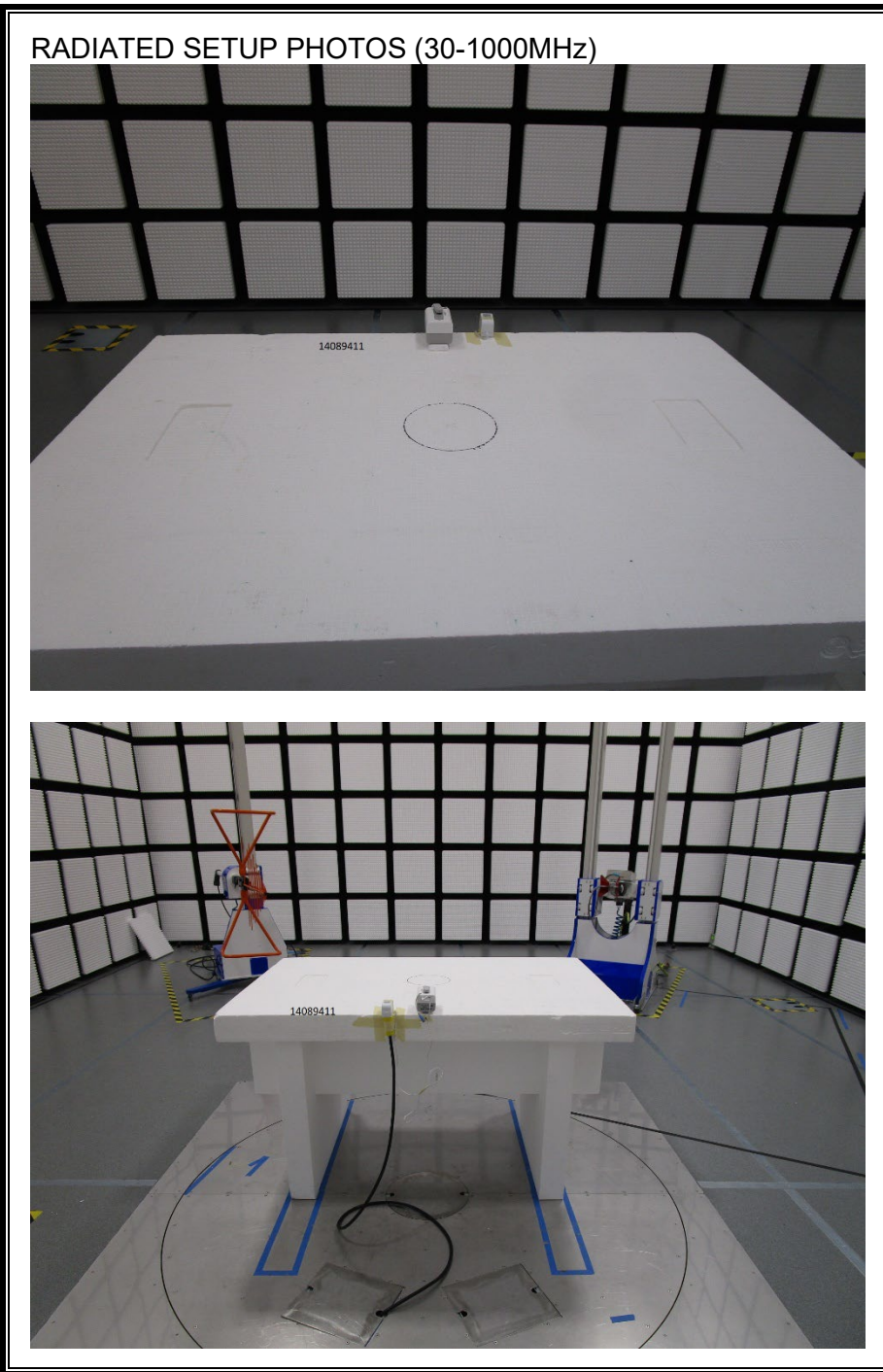



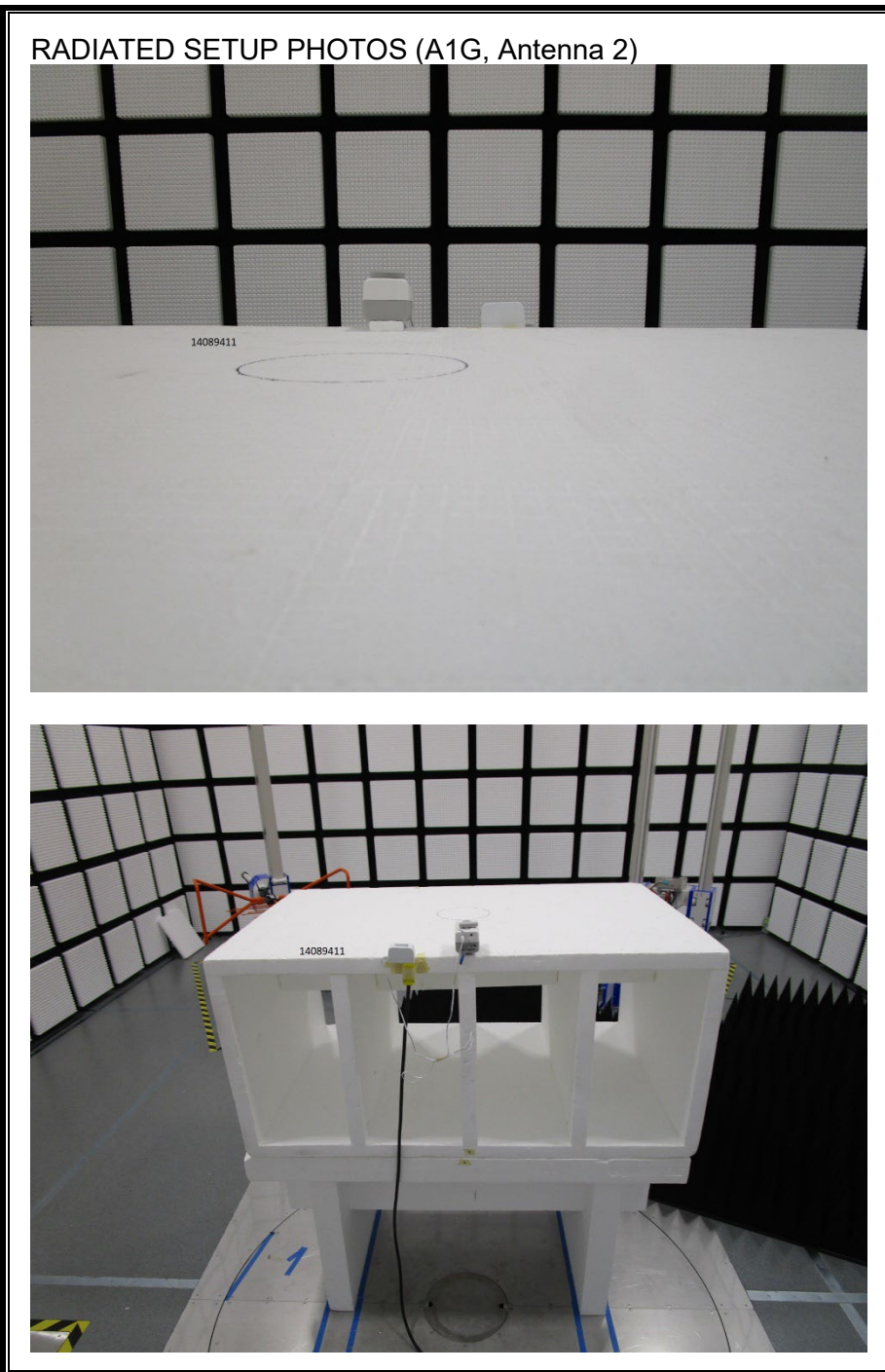



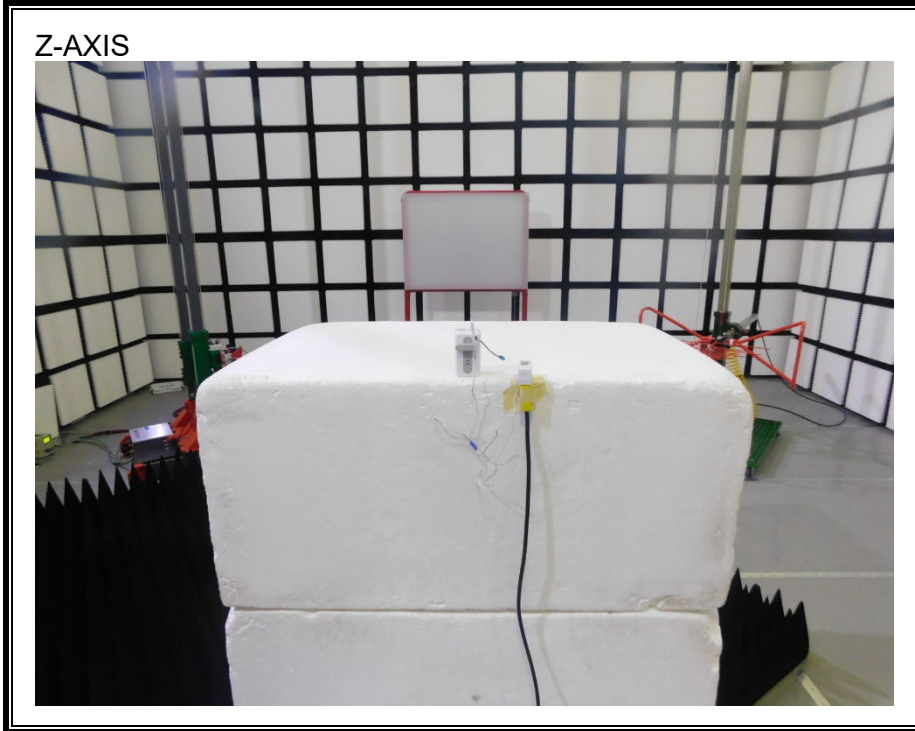

AC LINE CONDUCTED SETUP PHOTOS

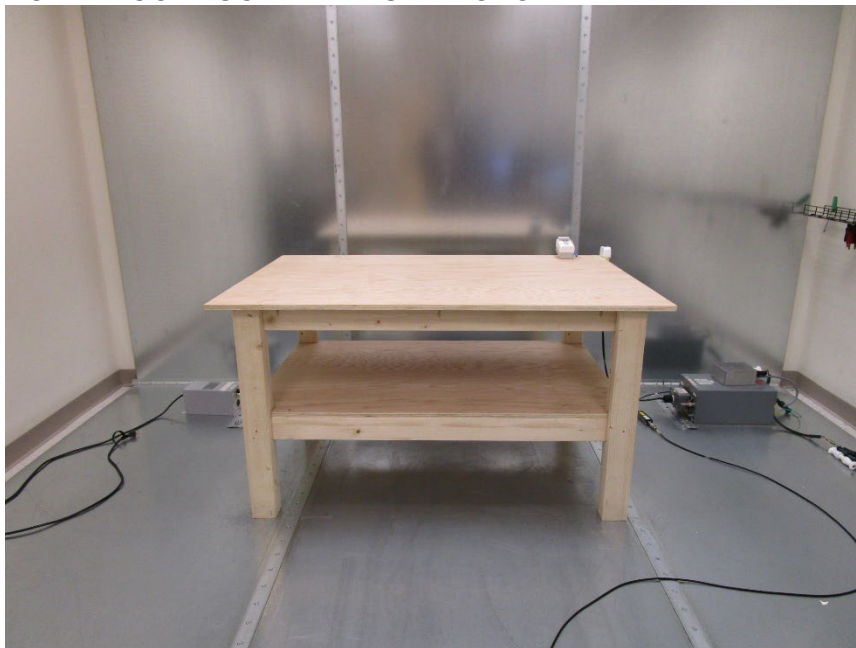

END OF TEST REPORT