

© 2022. All Rights Reserved.

Aspire 5 Spin 14

Covers: A5SP14-51MTN

This revision: December 2022

This manual contains proprietary information that is protected by copyright laws. The information contained in this manual is subject to change without notice. Some features described in this manual may not be supported depending on the Operating System version. Images provided herein are for reference only and may contain information or features that do not apply to your computer. Acer Group shall not be liable for technical or editorial errors or omissions contained in this manual.

Model number: \_\_\_\_\_

Serial number: \_\_\_\_\_

Date of purchase: \_\_\_\_\_

Place of purchase: \_\_\_\_\_

## **ENVIRONMENT**

### **Temperature:**

- Operating: 5 °C to 35 °C
- Storage: -20 °C to 60 °C

### **Humidity (non-condensing):**

- Operating: 20% to 80%
- Storage: 20% to 60%

## First things first

We would like to thank you for making this Acer notebook your choice for meeting your mobile computing needs.

### Your guides

To help you use your Acer notebook, we have designed a set of guides:

First off, the **Setup Guide** helps you get started with setting up your computer.

The **Quick Guide** introduces you to the basic features and functions of your new computer.

For more on how your computer can help you to be more productive, please refer to the **Aspire 5 Spin 14 User's Manual**. The **Aspire 5 Spin 14 User's Manual** contains useful information applying to your new computer. It covers basic topics such as using the keyboard and audio, etc.

This guide contains detailed information on such subjects as system utilities, data recovery, expansion options and troubleshooting. In addition it contains warranty information and the general regulations and safety notices for your notebook.

The User's Manual can be downloaded from the Acer support website by going to:

**<http://go.acer.com/support>**

## Software installation

The first time you turn on your computer, it will automatically install software and set up for use. This may take some time, please do not turn off your computer; wait until the installation has finished.

## Recovery

You should create recovery backups as soon as you can. The *Acer Recovery Management* program allows you to create recovery backups and then to restore or reinstall applications and drivers provided by Acer.

## Having trouble?

Acer provides several options to support your purchase.

### Acer support

Make sure you write down your computer serial number, date and place of purchase and model name on the area provided in this guide; save your proof of purchase. Before you call us, please write down any error message that accompanies the

problem, and have the computer in front of you and switched on if possible. Having these items to hand when contacting us will ensure better and quicker service.

### Acer website

Remember to visit **[www.acer.com](http://www.acer.com)** and refer to the support section for up-to-date information, help, drivers and downloads.

### Warranty and contact information

You can find information about the warranty for your computer and how to contact technical support in your computer's Warranty.

# Your Acer notebook tour

After setting up your computer as illustrated in the Setup Guide, let us show you around your new Acer computer.

## Screen view

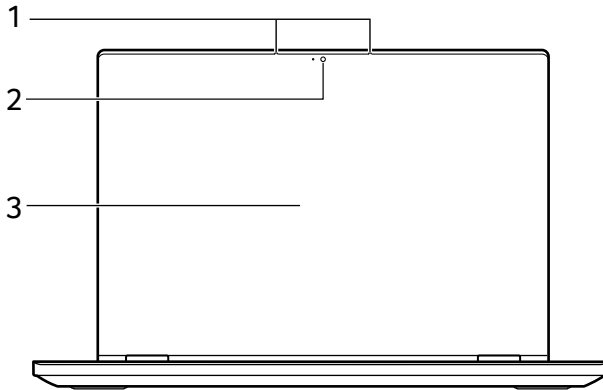

#	Icon	Item	Description
1		Microphones	Internal digital microphones for sound recording.
2		Camera	Camera for video communication or taking photos. <i>A light next to the webcam indicates that the webcam is active.</i>
3		Touchscreen	Displays computer output, supports multi-touch input.



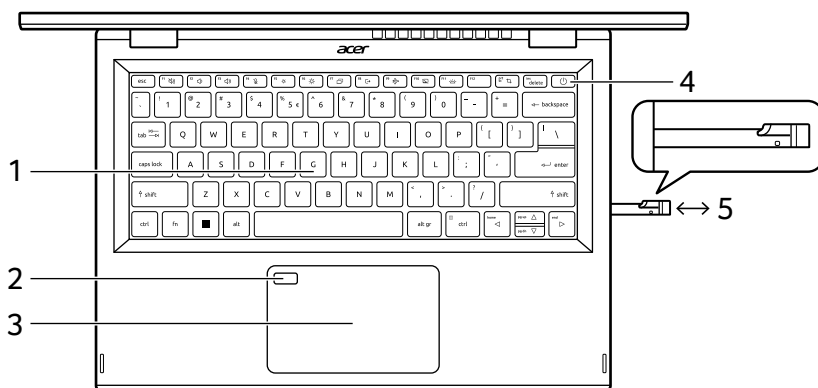

## Keyboard view

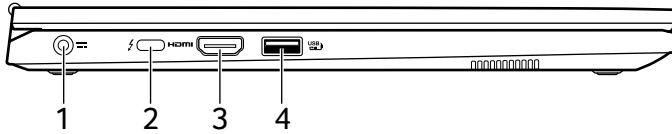

#	Icon	Item	Description
1		Keyboard	For entering data into your computer. See "Using the keyboard" on page 8.
2		Fingerprint reader	Fingerprint reader for Windows Hello and security. <i>Function varies depending on configuration.</i>
3		Touchpad	Touch-sensitive pointing device. <i>The touchpad and selection buttons form a single surface.</i> <i>Press down firmly on the touchpad surface to perform a left click.</i> <i>Press down firmly on the lower right corner to perform a right click.</i>
4		Power button	Turns the computer on and off.
5		Rechargeable active stylus	Remove the pen from the slot and perform touch actions on the screen.

## Left view



#	Icon	Item	Description
1		DC-in jack	Connects to an AC adapter.
2		USB Type-C / Thunderbolt™ 4 port	Connects to the provided USB Type-C power adapter and to USB devices with a USB Type-C connector. Supports Thunderbolt™ 4 and displays.
3		HDMI port	Supports high-definition digital video connections.
4		USB port with power-off charging	Connects to USB devices.

## USB Type-C information





- Supports DisplayPort™ audio/video output.
- Compatible with Thunderbolt™ 4.
- Delivers up to 3 A at 5 V DC for USB charging.
- DC-in: requires power adapter or power source providing 65 W at 19 V.  
For optimal performance, please use a certified Acer power adapter or USB Power Delivery device.

## USB 3.2 Gen 1 information

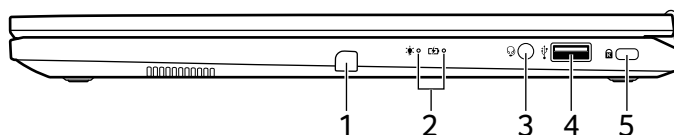
- USB 3.2 Gen 1 compatible ports are blue.
- Compatible with USB 3.2 Gen 1 and earlier devices.
- For optimal performance, use USB 3.2 Gen 1-certified devices.
- Defined by the USB 3.2 Gen 1 specification (SuperSpeed USB).

## Right view



#	Icon	Item	Description
1		Stylus slot	Insert the stylus into the slot completely to start charging. (Specifications vary depending on model.)
		Power indicator	Indicates the computer's power status.
2		Battery indicator	Indicates the computer's battery status. <b>Charging:</b> The light shows amber when the battery is charging. <b>Fully charged:</b> The light shows blue when in AC mode.
3		Headset/speaker jack	Connects to audio devices (e.g., speakers, headphones) or a headset with microphone.
4		USB port	Connects to USB devices.
5		Kensington lock slot	Connects to a Kensington-compatible security lock.

## Rear view

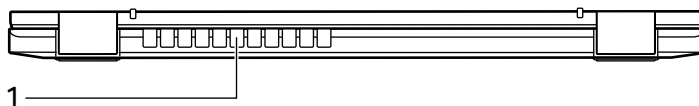

#	Icon	Item	Description
1		Ventilation and cooling fan	Allows the computer to stay cool. <i>Do not cover or obstruct the openings.</i>

## Base view

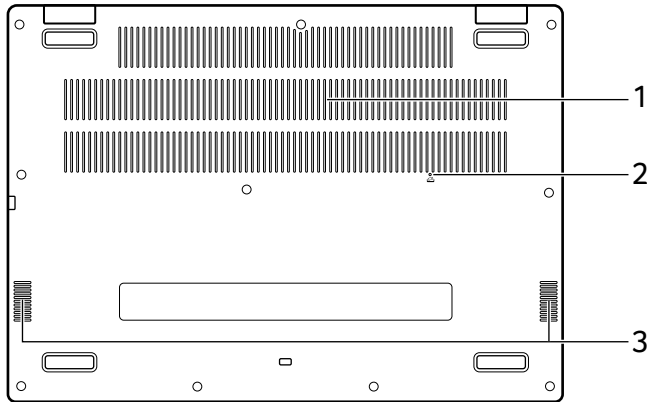



#	Icon	Item	Description
1		Ventilation and cooling fan	Allows the computer to stay cool. <i>Do not cover or obstruct the openings.</i>
2		Battery reset pinhole	Simulates removing and reinstalling the battery. <i>Insert a paperclip into the hole and press for four seconds.</i>
3		Speakers	Deliver stereo audio output.

## Using the keyboard











The keyboard has full-sized keys, a numeric keypad, separate cursor, lock, Windows, special keys and hotkeys.

### Special keys

Your computer's keyboard includes keys that activate special functions. The function of each key is clearly marked with an icon.

Icon	Function	Description
	Speaker toggle	Turns the speakers on and off.
	Volume down	Decreases the sound volume.







Icon	Function	Description
	Volume up	Increases the sound volume.
	Microphone toggle	Turns the microphones on and off.
	Brightness down	Decreases the screen brightness.
	Brightness up	Increases the screen brightness.
	Display toggle	Switches display output between the display screen, external monitor (if connected) and both.
	Lock your computer	Locks your computer to secure your information. You can enter password to continue your work.
	Flight mode	Turns on / off the computer's network devices.
	Touchpad toggle	Turns the built-in touchpad on and off.
	Keyboard backlight control	Adjusts keyboard backlight brightness. <i>Function varies depending on configuration.</i>
	Snipping Tool	Snips a rectangle, freeform, window or full screen to your clipboard.

## Hotkeys

To activate hotkeys, press and hold the **Fn** key before pressing the other key in the hotkey combination.

Hotkey	Icon	Function	Description
<b>Fn + F1-F12</b>		Function keys	Activates the <i>F1</i> to <i>F12</i> keys.
<b>Fn + F</b>			Switches fan mode between Silent, Normal and Performance. For more information on how to achieve optimal cooling efficiency in different scenarios, please launch Acer Quick Access application.
<b>Fn + </b>	<b>prt sc</b>	Print Screen	Take quick screen shots.

Hotkey	Icon	Function	Description
<b>Fn + delete</b>	<b>ins</b>	Insert	Turns Insert on or off.
<b>Fn +</b> 	<b>home</b>	Home	Scrolls to the beginning of a document.
<b>Fn +</b> 	<b>end</b>	End	Scrolls to the end of a document.
<b>Fn +</b> 	<b>pg up</b>	Page up	Scrolls up a page in a document.
<b>Fn +</b> 	<b>pg dn</b>	Page down	Scrolls down a page in a document.