

FCC Test Report

(PART 27)

Report No.: RFBCKT-WTW-P22080510-3 R1

FCC ID: HFS-GW03

Test Model: QTAX57

Received Date: 2022/3/21

Test Date: 2022/8/23 ~ 2022/9/7

Issued Date: 2022/11/9

Applicant: Quanta Computer Inc.

Address: NO.188, Wenhua 2nd Rd., Guishan Dist., Taoyuan City 33377, Taiwan

Issued By: Bureau Veritas Consumer Products Services (H.K.) Ltd., Taoyuan Branch
Lin Kou Laboratories

Lab Address: No. 47-2, 14th Ling, Chia Pau Vil., Lin Kou Dist., New Taipei City, Taiwan

Test Location: No.19, Hwa Ya 2nd Rd., Wen Hwa Vil., Kwei Shan Dist., Taoyuan City 33383, Taiwan

**FCC Registration /
Designation Number:** 788550 / TW0003



This report is governed by, and incorporates by reference, the Conditions of Testing as posted at the date of issuance of this report at <http://www.bureauveritas.com/home/about-us/our-business/cps/about-us/terms-conditions/> and is intended for your exclusive use. Any copying or replication of this report to or for any other person or entity, or use of our name or trademark, is permitted only with our prior written permission. This report sets forth our findings solely with respect to the test samples identified herein. The results set forth in this report are not indicative or representative of the quality or characteristics of the lot from which a test sample was taken or any similar or identical product unless specifically and expressly noted. Our report includes all of the tests requested by you and the results thereof based upon the information that you provided to us. Measurement uncertainty is only provided upon request for accredited tests. Statements of conformity are based on simple acceptance criteria without taking measurement uncertainty into account, unless otherwise requested in writing. You have 60 days from date of issuance of this report to notify us of any material error or omission caused by our negligence or if you require measurement uncertainty; provided, however, that such notice shall be in writing and shall specifically address the issue you wish to raise. A failure to raise such issue within the prescribed time shall constitute your unqualified acceptance of the completeness of this report, the tests conducted and the correctness of the report contents.

Table of Contents

Release Control Record	4
1 Certificate of Conformity	5
2 Summary of Test Results	6
2.1 Measurement Uncertainty.....	7
2.2 Test Site and Instruments	8
3 General Information	9
3.1 General Description of EUT.....	9
3.2 Configuration of System under Test.....	11
3.2.1 Description of Support Units.....	11
3.3 Test Mode Applicability and Tested Channel Detail	12
3.4 EUT Operating Conditions	14
3.5 General Description of Applied Standards and references	15
4 Test Types and Results	16
4.1 Output Power Measurement.....	16
4.1.1 Limits of Output Power Measurement	16
4.1.2 Test Procedures.....	16
4.1.3 Test Setup.....	16
4.1.4 Test Results	17
4.2 Modulation Characteristics Measurement	25
4.2.1 Limits of Modulation Characteristics	25
4.2.2 Test Setup.....	25
4.2.3 Test Procedure	25
4.2.4 Test Results	26
4.3 Frequency Stability Measurement	27
4.3.1 Limits of Frequency Stability Measurement	27
4.3.2 Test Procedure	27
4.3.3 Test Setup.....	27
4.3.4 Test Results	28
4.4 Occupied Bandwidth Measurement.....	36
4.4.1 Limits of Occupied Bandwidth Measurement	36
4.4.2 Test Procedure	36
4.4.3 Test Setup.....	36
4.4.4 Test Result.....	37
4.5 Channel Edge / Out-of-Band Emissions Measurement.....	45
4.5.1 Limits of Band Edge / Out-of-Band Emissions Measurement	45
4.5.2 Test Setup.....	45
4.5.3 Test Procedures.....	45
4.5.4 Test Results	46
4.6 Peak to Average Ratio	54
4.6.1 Limits of Peak to Average Ratio Measurement	54
4.6.2 Test Setup.....	54
4.6.3 Test Procedures.....	54
4.6.4 Test Results	55
4.7 Conducted Spurious Emissions.....	62
4.7.1 Limits of Conducted Spurious Emissions Measurement	62
4.7.2 Test Setup.....	62
4.7.3 Test Procedure	62
4.7.4 Test Results	63
4.8 Radiated Emission Measurement.....	72
4.8.1 Limits of Radiated Emission Measurement	72
4.8.2 Test Procedure	72
4.8.3 Deviation from Test Standard	72
4.8.4 Test Setup.....	73

4.8.5 Test Results	74
5 Pictures of Test Arrangements	91
Appendix – Information of the Testing Laboratories	92

Release Control Record

Issue No.	Description	Date Issued
RFBCKT-WTW-P22080510-3	Original Release	2022/9/19
RFBCKT-WTW-P22080510-3 R1	Add 2 nd Charger cable	2022/11/9



1 Certificate of Conformity

Product: Smart Watch

Brand: NA

Test Model: QTAX57

Sample Status: Engineering Sample

Applicant: Quanta Computer Inc.

Test Date: 2022/8/23 ~ 2022/9/7

Standards: FCC Part 27, Subpart C, F, L

The above equipment has been tested by **Bureau Veritas Consumer Products Services (H.K.) Ltd., Taoyuan Branch**, and found compliance with the requirement of the above standards. The test record, data evaluation & Equipment Under Test (EUT) configurations represented herein are true and accurate accounts of the measurements of the sample's RF characteristics under the conditions specified in this report.

Prepared by :

Gina Liu

Date: 2022/11/9

Gina Liu / Specialist

Approved by :

Jeremy Lin

Date: 2022/11/9

Jeremy Lin / Project Engineer

2 Summary of Test Results

Applied Standard: FCC Part 27 & Part 2 (LTE 4)			
FCC Clause	Test Item	Result	Remarks
2.1046 27.50(d)	Equivalent Isotropically radiated power	Pass	Meet the requirement of limit.
2.1047	Modulation characteristics	Pass	Meet the requirement.
2.1055 27.54	Frequency Stability	Pass	Meet the requirement of limit.
2.1049	Emission Bandwidth	Pass	Meet the requirement of limit.
2.1051 27.53(h)	Out of Band Emission Measurements	Pass	Meet the requirement of limit.
27.50(d)(5)	Peak To Average Ratio	Pass	Meet the requirement of limit.
2.1051 27.53(h)	Conducted Spurious Emissions	Pass	Meet the requirement of limit.
2.1053 27.53(h)	Radiated Spurious Emissions	Pass	Meet the requirement of limit. Minimum passing margin is -38.6 dB at 932.10 MHz.

Applied Standard: FCC Part 27 & Part 2 (LTE 13)			
FCC Clause	Test Item	Result	Remarks
2.1046 27.50(b)	Equivalent radiated power	Pass	Meet the requirement of limit.
2.1047	Modulation characteristics	Pass	Meet the requirement.
2.1055 27.54	Frequency Stability	Pass	Meet the requirement of limit.
2.1049	Emission Bandwidth	Pass	Meet the requirement of limit.
2.1051 27.53(c)	Out of Band Emission Measurements	Pass	Meet the requirement of limit.
--	Peak To Average Ratio	Pass	Meet the requirement of limit.
2.1051 27.53(c)(f)	Conducted Spurious Emissions	Pass	Meet the requirement of limit.
2.1053 27.53(c)(f)	Radiated Spurious Emissions	Pass	Meet the requirement of limit. Minimum passing margin is -13.06 dB at 1564.00 MHz.

Note: Determining compliance based on the results of the compliance measurement, not taking into account measurement instrumentation uncertainty.

2.1 Measurement Uncertainty

Where relevant, the following measurement uncertainty levels have been estimated for tests performed on the EUT as specified in CISPR 16-4-2:

Measurement	Frequency	Expanded Uncertainty (k=2) (\pm)
Radiated Emissions up to 1 GHz	9 kHz ~ 30 MHz	3.04 dB
	30 MHz ~ 200 MHz	2.93 dB
	200 MHz ~ 1000 MHz	2.95 dB
Radiated Emissions above 1 GHz	1 GHz ~ 18 GHz	2.26 dB
	18 GHz ~ 40 GHz	1.94 dB

2.2 Test Site and Instruments

Description & Manufacturer	Model No.	Serial No.	Cal. Date	Cal. Due
Antenna Tower & Turn Max-Full	MFA-440H	AT93021705	N/A	N/A
Bi_Log Antenna Schwarbeck	VULB9168	9168-472	Oct. 28, 2021	Oct. 27, 2022
Loop Antenna TESEQ	HLA 6121	45745	Jul. 27, 2022	Jul. 26, 2023
HORN Antenna SCHWARZBECK	BBHA 9120D	9120D-969	May. 14, 2022	May. 13, 2023
HORN Antenna SCHWARZBECK	BBHA 9170	9170-480	May. 14, 2022	May. 13, 2023
Preamplifier EMC1	EMC 012645	980115	Oct. 05, 2021	Oct. 04, 2022
Preamplifier Agilent	8447D	2944A10638	May. 14, 2022	May. 13, 2023
Pre-amplifier EMC1	EMC 330H	980112	Oct. 05, 2021	Oct. 04, 2022
Pre-amplifier EMC1	EMC 184045	980116	Oct. 05, 2021	Oct. 04, 2022
RF Coaxial Cable EMC1	EMC104-SM-SM-8000	171005	Oct. 05, 2021	Oct. 04, 2022
RF Coaxial Cable HUBER SUHNER	SUCOFLEX 104	EMC104-SM-SM-1000(140807)	Oct. 05, 2021	Oct. 04, 2022
RF Coaxial Cable WOKEN	8D-FB	Cable-Ch10-01	Oct. 05, 2021	Oct. 04, 2022
Software BV ADT	ADT_Radiated_V7.6.15.9.5	N/A	N/A	N/A
Spectrum Analyzer ROHDE & SCHWARZ	FSP40	100040	Sep. 15, 2021	Sep. 14, 2022
Signal Analyzer Agilent	N9010A	MY52220207	Jan. 06, 2022	Jan. 05, 2023
Test Receiver Agilent	N9038A	MY51210203	Sep. 22, 2021	Sep. 21, 2022
Turn Table Max-Full	MFT-201SS	NA	N/A	N/A
Turn Table Controller Max-Full	MG-7802	NA	N/A	N/A
Wideband Power Sensor KEYSIGHT	N1923A	MY58020002	Jan. 17, 2022	Jan. 16, 2023
Peak Power Analyzer KEYSIGHT	8990B	MY51000485	Jan. 18, 2022	Jan. 17, 2023

Note: 1. The calibration interval of the above test instruments is 12 months and the calibrations are traceable to NML/ROC and NIST/USA.
2. The test was performed in HY - 966 chamber 5.

3 General Information

3.1 General Description of EUT

Product	Smart Watch	
Brand	NA	
Test Model	QTAX57	
Status of EUT	Engineering Sample	
Power Supply Rating	3.85 Vdc (Battery) 100-240 Vac (Adapter)	
Modulation Type	LTE	QPSK, 16QAM
Frequency Range	LTE Band 4 (Channel Bandwidth: 1.4 MHz)	1710.7 ~ 1754.3 MHz
	LTE Band 4 (Channel Bandwidth: 3 MHz)	1711.5 ~ 1753.5 MHz
	LTE Band 4 (Channel Bandwidth: 5 MHz)	1712.5 ~ 1752.5 MHz
	LTE Band 4 (Channel Bandwidth: 10 MHz)	1715.0 ~ 1750.0 MHz
	LTE Band 4 (Channel Bandwidth: 15 MHz)	1717.5 ~ 1747.5 MHz
	LTE Band 4 (Channel Bandwidth: 20 MHz)	1720.0 ~ 1745.0 MHz
	LTE Band 13 (Channel Bandwidth: 5 MHz)	779.5 ~ 784.5 MHz
	LTE Band 13 (Channel Bandwidth: 10 MHz)	782.0 MHz
Emission Designator	LTE Band 4 (Channel Bandwidth: 1.4 MHz)	1M09G7D
	LTE Band 4 (Channel Bandwidth: 3 MHz)	2M70D7W
	LTE Band 4 (Channel Bandwidth: 5 MHz)	4M50G7D
	LTE Band 4 (Channel Bandwidth: 10 MHz)	8M96G7D
	LTE Band 4 (Channel Bandwidth: 15 MHz)	13M4G7D
	LTE Band 4 (Channel Bandwidth: 20 MHz)	17M9G7D
	LTE Band 13 (Channel Bandwidth: 5 MHz)	4M50G7D
	LTE Band 13 (Channel Bandwidth: 10 MHz)	8M96G7D
Max. ERP Power	LTE Band 13 (Channel Bandwidth: 5 MHz)	16.827 mW (12.26dBm)
	LTE Band 13 (Channel Bandwidth: 10 MHz)	16.904 mW (12.28dBm)
Max. EIRP Power	LTE Band 4 (Channel Bandwidth: 1.4 MHz)	66.988 mW (18.26dBm)
	LTE Band 4 (Channel Bandwidth: 3 MHz)	66.069 mW (18.20dBm)
	LTE Band 4 (Channel Bandwidth: 5 MHz)	66.988 mW (18.26dBm)
	LTE Band 4 (Channel Bandwidth: 10 MHz)	66.069 mW (18.20dBm)
	LTE Band 4 (Channel Bandwidth: 15 MHz)	66.988 mW (18.26dBm)
	LTE Band 4 (Channel Bandwidth: 20 MHz)	67.453 mW (18.29dBm)
Antenna Type	PIFA Antenna	
Antenna Gain	LTE Band 4	-4.7 dBi
	LTE Band 13	-8.8 dBi
Accessory Device	Refer to Note as below	
Data Cable Supplied	Refer to Note as below	

Note:

1. The EUT contains following accessory devices.

Product	Brand	Model	Description
Battery	EVE (EVE Energy Co., Ltd.)	P0963	3.85V, 495mAh, 1.91Wh
Charger Cable 1	GREATLAND (Greatland Electronics Taiwan Ltd.)	DDEMU080009	Line length : 800mm
Charger Cable 2	GREATLAND (Greatland Electronics Taiwan Ltd.)	DDEMU080012	Line length : 800mm

2. The above Antenna information refers to the manufacturer's antenna specifications, the laboratory shall not be held responsible.
3. The above EUT information is declared by manufacturer and for more detailed features description, please refers to the manufacturer's specifications or user's manual.
4. 16QAM only supports up to 25RB.

3.2 Configuration of System under Test

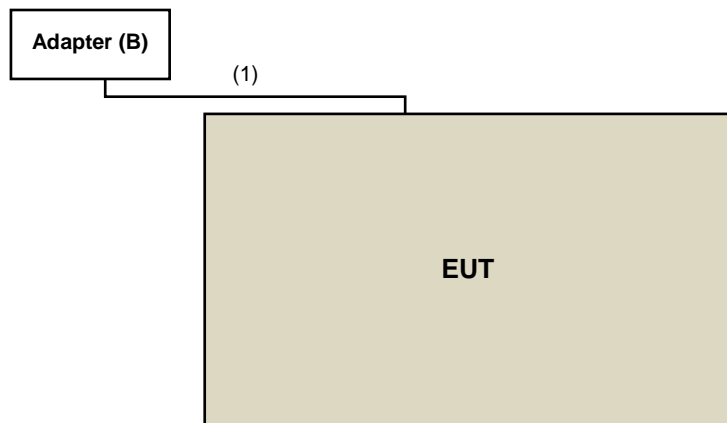

Under Table

Remote Site

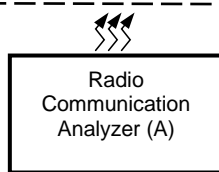

3.2.1 Description of Support Units

The EUT has been tested as an independent unit together with other necessary accessories or support units. The following support units or accessories were used to form a representative test configuration during the tests.

ID	Product	Brand	Model No.	Serial No.	FCC ID	Remarks
A	Radio Communication Analyzer	Anritsu	MT8820C	6201010284	-	Radio Communication Analyzer
B	Adapter	JIANGSU CHENYANG ELECTRON CO.,LTD	CYSM06-050120-UL	N/A	N/A	Supplied by applicant

ID	Cable Descriptions	Qty.	Length (m)	Shielding (Yes/No)	Cores (Qty.)	Remarks
1	Adapter Cable	1	1	Y	N	Accessory of EUT

3.3 Test Mode Applicability and Tested Channel Detail

Pre-Scan has been conducted to determine the worst-case mode from all possible combinations between available modulations, data rates, XYZ axis, and antenna ports

The worst case was found when positioned on Z-plane. Following channel(s) was (were) selected for the final test as listed below:

LTE Band 4

EUT Configure Mode	Test Item	Available Channel	Tested Channel	Channel Bandwidth	Modulation	RB #
-	EIRP	19957 to 20393	19957, 20175, 20393	1.4 MHz	QPSK / 16QAM	1 Half Full
		19965 to 20385	19965, 20175, 20385	3 MHz	QPSK / 16QAM	1 Half Full
		19975 to 20375	19975, 20175, 20375	5 MHz	QPSK / 16QAM	1 Half Full
		20000 to 20350	20000, 20175, 20350	10 MHz	QPSK / 16QAM	1 Half Full
		20025 to 20325	20025, 20175, 20325	15 MHz	QPSK / 16QAM	1 Half Full
		20050 to 20300	20050, 20175, 20300	20 MHz	QPSK / 16QAM	1 Half Full
-	Modulation Characteristics	20050 to 20300	20175	20 MHz	QPSK / 16QAM	Full
-	Frequency Stability	19957 to 20393	19957, 20393	1.4 MHz	QPSK	Full
		19965 to 20385	19965, 20385	3 MHz	QPSK	Full
		19975 to 20375	19975, 20375	5 MHz	QPSK	Full
		20000 to 20350	20000, 20350	10 MHz	QPSK	Full
		20025 to 20325	20025, 20325	15 MHz	QPSK	Full
		20050 to 20300	20050, 20300	20 MHz	QPSK	Full
-	Occupied Bandwidth	19957 to 20393	19957, 20175, 20393	1.4 MHz	QPSK / 16QAM	Full
		19965 to 20385	19965, 20175, 20385	3 MHz	QPSK / 16QAM	Full
		19975 to 20375	19975, 20175, 20375	5 MHz	QPSK / 16QAM	Full
		20000 to 20350	20000, 20175, 20350	10 MHz	QPSK / 16QAM	Full
		20025 to 20325	20025, 20175, 20325	15 MHz	QPSK / 16QAM	Full
		20050 to 20300	20050, 20175, 20300	20 MHz	QPSK / 16QAM	Full
-	Peak to Average Ratio	19957 to 20393	19957, 20175, 20393	1.4 MHz	QPSK / 16QAM	1
		19965 to 20385	19965, 20175, 20385	3 MHz	QPSK / 16QAM	1
		19975 to 20375	19975, 20175, 20375	5 MHz	QPSK / 16QAM	1
		20000 to 20350	20000, 20175, 20350	10 MHz	QPSK / 16QAM	1
		20025 to 20325	20025, 20175, 20325	15 MHz	QPSK / 16QAM	1
		20050 to 20300	20050, 20175, 20300	20 MHz	QPSK / 16QAM	1

EUT Configure Mode	Test Item	Available Channel	Tested Channel	Channel Bandwidth	Modulation	RB #
-	Band Edge	19957 to 20393	19957, 20393	1.4 MHz	QPSK	1 Half Full
		19965 to 20385	19965, 20385	3 MHz	QPSK	1 Half Full
		19975 to 20375	19975, 20375	5 MHz	QPSK	1 Half Full
		20000 to 20350	20000, 20350	10 MHz	QPSK	1 Half Full
		20025 to 20325	20025, 20325	15 MHz	QPSK	1 Half Full
		20050 to 20300	20050, 20300	20 MHz	QPSK	1 Half Full
-	Conducted Emission	19957 to 20393	19957, 20175, 20393	1.4 MHz	QPSK	1
		19965 to 20385	19965, 20175, 20385	3 MHz	QPSK	1
		19975 to 20375	19975, 20175, 20375	5 MHz	QPSK	1
		20000 to 20350	20000, 20175, 20350	10 MHz	QPSK	1
		20025 to 20325	20025, 20175, 20325	15 MHz	QPSK	1
		20050 to 20300	20050, 20175, 20300	20 MHz	QPSK	1
-	Radiated Emission Below 1GHz	20050 to 20300	20175	20 MHz	QPSK	1
-	Radiated Emission Above 1GHz	19957 to 20393	19957, 20175, 20393	1.4 MHz	QPSK	1
		19975 to 20375	19975, 20175, 20375	5 MHz	QPSK	1
		20050 to 20300	20050, 20175, 20300	20 MHz	QPSK	1

Note:

1. For radiated emission below 1GHz, select the worst radiated emission channel (above 1GHz) for final testing.
2. For radiated emission above 1GHz, according to 3GPP 36.521 Section 6.6.3.1.4, choose the lowest, 5MHz & highest channel bandwidth for final test.
3. The output power for QPSK and 16QAM, measured value of QPSK is higher than 16QAM mode. Therefore, only EIRP, Modulation characteristics, occupied bandwidth and Peak to average ratio items had been tested under QPSK and 16QAM modes, the other test items were performed under worse mode according to the maximum output power.

LTE Band 13

EUT Configure Mode	Test Item	Available Channel	Tested Channel	Channel Bandwidth	Modulation	RB #
-	ERP	23205 to 23255	23205, 23230, 23255	5 MHz	QPSK / 16QAM	1 Half Full
		23230	23230	10 MHz	QPSK / 16QAM	1 Half Full
-	Modulation Characteristics	23230	23230	10 MHz	QPSK / 16QAM	Full
-	Frequency Stability	23205 to 23255	23205, 23255	5 MHz	QPSK	Full
		23230	23230	10 MHz	QPSK	Full
-	Occupied Bandwidth	23205 to 23255	23205, 23230, 23255	5 MHz	QPSK / 16QAM	Full
		23230	23230	10 MHz	QPSK / 16QAM	Full
-	Peak to Average Ratio	23205 to 23255	23205, 23230, 23255	5 MHz	QPSK / 16QAM	1
		23230	23230	10 MHz	QPSK / 16QAM	1
-	Band Edge	23205 to 23255	23205, 23255	5 MHz	QPSK	1 Half Full
		23230	23230, 23230	10 MHz	QPSK	1 Half Full
-	Conducted Emission	23205 to 23255	23205, 23230, 23255	5 MHz	QPSK	1
		23230	23230	10 MHz	QPSK	1
-	Radiated Emission Below 1GHz	23205 to 23255	23205	5 MHz	QPSK	1
-	Radiated Emission Above 1GHz	23205 to 23255	23205, 23230, 23255	5 MHz	QPSK	1
		23230	23230	10 MHz	QPSK	1

Note:

1. For radiated emission below 1GHz, select the worst radiated emission channel (above 1GHz) for final testing.
2. The output power for QPSK and 16QAM, measured value of QPSK is higher than 16QAM mode. Therefore, only ERP, Modulation characteristics, occupied bandwidth and Peak to average ratio items had been tested under QPSK and 16QAM modes, the other test items were performed under worse mode according to the maximum output power.

Test Condition:

Test Item	Environmental Conditions	Input Power	Tested By
ERP / EIRP	25 deg. C, 65 % RH	3.85 Vdc	Noah Chang
Modulation Characteristics	25 deg. C, 65 % RH	3.85 Vdc	Noah Chang
Frequency Stability	25 deg. C, 65 % RH	3.85 Vdc	Noah Chang
Occupied Bandwidth	25 deg. C, 65 % RH	3.85 Vdc	Noah Chang
Band Edge	25 deg. C, 65 % RH	3.85 Vdc	Noah Chang
Peak to Average Ratio	25 deg. C, 65 % RH	3.85 Vdc	Noah Chang
Conducted Emission	25 deg. C, 65 % RH	3.85 Vdc	Noah Chang
Radiated Emission	25 deg. C, 65 % RH	120 Vac, 60 Hz	Vincent Chen, Thomas Cheng

3.4 EUT Operating Conditions

The EUT makes a call to the communication simulator. The communication simulator station system controlled a EUT to export maximum output power under transmission mode and specific channel frequency

3.5 General Description of Applied Standards and references

The EUT is a RF Product. According to the specifications of the manufacturer, it must comply with the requirements of the following standards and references:

Test Standard:

FCC 47 CFR Part 2

FCC 47 CFR Part 27

ANSI 63.26-2015

Note: All test items have been performed and recorded as per the above standards.

References Test Guidance:

KDB 971168 D01 Power Meas License Digital Systems v03r01

ANSI/TIA/EIA-603-E 2016

Note: All test items have been performed as a reference to the above KDB test guidance.

4 Test Types and Results

4.1 Output Power Measurement

4.1.1 Limits of Output Power Measurement

For LTE Band 13:

Control stations and mobile stations in the 746-757 MHz, 776-788 MHz, and 805-806 MHz bands and fixed stations transmitting in the 787-788 MHz and 805-806 MHz bands are limited to 30 watts ERP.

Portable stations (hand-held devices) transmitting in the 746-757 MHz, 776-788 MHz, and 805-806 MHz bands are limited to 3 watts ERP.

For LTE Band 4:

Fixed, mobile, and portable (hand-held) stations operating in the 1710-1755 MHz band and mobile and portable stations operating in the 1695-1710 MHz and 1755-1780 MHz bands are limited to 1 watt EIRP.

4.1.2 Test Procedures

Conducted Power Measurement:

The EUT was set up for the maximum power with LTE link data modulation and link up with simulator (Built-in power meter). Set the EUT to transmit under low, middle and high channel and record the power level shown on simulator.

Maximum EIRP / ERP

The relevant equation for determining the maximum ERP or EIRP from the measured RF output power is given in Equation as follows:

$$\text{EIRP} = P_{\text{Meas}} + G_T$$

$$\text{ERP} = P_{\text{Meas}} + G_T - 2.15$$

where

ERP or EIRP effective radiated power or equivalent isotropically radiated power, respectively
(expressed in the same units as P_{Meas} , e.g., dBm or dBW)

P_{Meas} measured transmitter output power or PSD, in dBm or dBW

G_T gain of the transmitting antenna, in dBd (ERP) or dBi (EIRP)

4.1.3 Test Setup

Conducted Power Measurement:

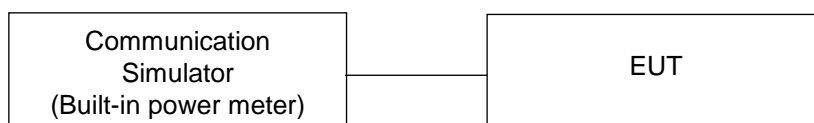

4.1.4 Test Results

Conducted Output Power (dBm)

LTE Band 4						
BW	MCS Index	Channel		19957	20175	20393
		Frequency (MHz)		1710.7	1732.5	1754.3
1.4M	QPSK	1	0	22.81	22.90	22.80
		1	2	22.57	22.96	22.76
		1	5	22.22	22.70	22.76
		3	0	22.82	22.83	22.58
		3	1	22.71	22.65	22.56
		3	3	22.45	22.56	22.51
		6	0	21.48	21.45	21.37
	16QAM	1	0	21.29	21.67	21.52
		1	2	21.66	21.55	21.24
		1	5	21.52	21.56	21.38
		3	0	21.71	21.84	21.62
		3	1	21.78	21.74	21.70
		3	3	21.71	21.69	21.68
		6	0	20.64	20.68	20.62
LTE Band 4						
BW	MCS Index	Channel		19965	20175	20385
		Frequency (MHz)		1711.5	1732.5	1753.5
3M	QPSK	1	0	22.78	22.90	22.72
		1	7	22.49	22.86	22.63
		1	14	22.25	22.63	22.74
		8	0	21.87	21.89	21.59
		8	3	21.63	21.67	21.43
		8	7	21.44	21.70	21.45
		15	0	21.45	21.55	21.31
	16QAM	1	0	21.28	21.70	21.57
		1	7	21.72	21.64	21.26
		1	14	21.56	21.57	21.33
		8	0	20.74	20.87	20.72
		8	3	20.85	20.77	20.71
		8	7	20.70	20.68	20.68
		15	0	20.75	20.68	20.53

LTE Band 4

BW	MCS Index	Channel		19975	20175	20375
		Frequency (MHz)		1712.5	1732.5	1752.5
5M	QPSK	1	0	22.89	22.80	22.82
		1	12	22.50	22.96	22.86
		1	24	22.25	22.67	22.65
		12	0	21.83	21.88	21.59
		12	6	21.73	21.74	21.56
		12	13	21.44	21.64	21.47
		25	0	21.41	21.54	21.26
	16QAM	1	0	21.27	21.73	21.62
		1	12	21.73	21.58	21.28
		1	24	21.53	21.46	21.28
		12	0	20.78	20.72	20.68
		12	6	20.75	20.74	20.71
		12	13	20.75	20.69	20.54
		25	0	20.76	20.69	20.60

LTE Band 4

BW	MCS Index	Channel		20000	20175	20350
		Frequency (MHz)		1715	1732.5	1750
10M	QPSK	1	0	22.79	22.90	22.85
		1	24	22.55	22.88	22.74
		1	49	22.21	22.71	22.74
		25	0	21.83	21.89	21.63
		25	12	21.60	21.79	21.49
		25	25	21.56	21.68	21.47
		50	0	21.49	21.55	21.37
	16QAM	1	0	21.30	21.81	21.58
		1	24	21.73	21.59	21.25
		1	49	21.58	21.53	21.32
		25	0	20.86	20.79	20.76
		25	12	20.79	20.83	20.69
		25	25	20.76	20.69	20.67

LTE Band 4

BW	MCS Index	Channel		20025	20175	20325
		Frequency (MHz)		1717.5	1732.5	1747.5
15M	QPSK	1	0	22.90	22.93	22.94
		1	37	22.64	22.96	22.86
		1	74	22.32	22.76	22.80
		36	0	21.89	21.91	21.65
		36	19	21.74	21.80	21.61
		36	39	21.56	21.71	21.61
	16QAM	75	0	21.53	21.59	21.37
		1	0	21.35	21.81	21.62
		1	37	21.81	21.67	21.39
		1	74	21.61	21.57	21.43

LTE Band 4

BW	MCS Index	Channel		20050	20175	20300
		Frequency (MHz)		1720	1732.5	1745
20M	QPSK	1	0	22.95	22.99	22.98
		1	50	22.66	22.97	22.94
		1	99	22.38	22.81	22.81
		50	0	21.89	21.91	21.71
		50	25	21.75	21.83	21.67
		50	50	21.63	21.72	21.66
	16QAM	100	0	21.61	21.68	21.46
		1	0	21.38	21.87	21.66
		1	50	21.86	21.75	21.45
		1	99	21.71	21.60	21.51

LTE Band 13

BW	MCS Index	Channel		23205	23230	23255
		Frequency (MHz)		779.5	782	784.5
5M	QPSK	1	0	23.14	23.13	23.21
		1	12	23.10	23.11	23.11
		1	24	22.84	22.79	22.77
		12	0	22.07	22.07	22.10
		12	6	22.02	21.96	22.04
		12	13	21.92	21.96	21.86
		25	0	21.88	21.85	21.84
	16QAM	1	0	22.08	22.00	22.08
		1	12	21.82	21.79	21.82
		1	24	21.45	21.47	21.53
		12	0	21.26	21.35	21.32
		12	6	21.18	21.16	21.26
		12	13	21.00	20.95	20.96
		25	0	21.28	21.26	21.36

LTE Band 13

BW	MCS Index	Channel		23230
		Frequency (MHz)		782
10M	QPSK	1	0	23.23
		1	24	23.17
		1	49	22.84
		25	0	22.17
		25	12	22.06
		25	25	21.96
		50	0	21.93
	16QAM	1	0	22.08
		1	24	21.89
		1	49	21.53
		25	0	21.35
		25	12	21.26
		25	25	21.01

EIRP Power(dBm)

LTE Band 4						
BW	MCS Index	Channel		19957	20175	20393
		Frequency (MHz)		1710.7	1732.5	1754.3
1.4M	QPSK	1	0	18.11	18.20	18.10
		1	2	17.87	18.26	18.06
		1	5	17.52	18.00	18.06
		3	0	18.12	18.13	17.88
		3	1	18.01	17.95	17.86
		3	3	17.75	17.86	17.81
	16QAM	6	0	16.78	16.75	16.67
		1	0	16.59	16.97	16.82
		1	2	16.96	16.85	16.54
		1	5	16.82	16.86	16.68
		3	0	17.01	17.14	16.92
		3	1	17.08	17.04	17.00
		3	3	17.01	16.99	16.98
		6	0	15.94	15.98	15.92
LTE Band 4						
BW	MCS Index	Channel		19965	20175	20385
		Frequency (MHz)		1711.5	1732.5	1753.5
3M	QPSK	1	0	18.08	18.20	18.02
		1	7	17.79	18.16	17.93
		1	14	17.55	17.93	18.04
		8	0	17.17	17.19	16.89
		8	3	16.93	16.97	16.73
		8	7	16.74	17.00	16.75
		15	0	16.75	16.85	16.61
	16QAM	1	0	16.58	17.00	16.87
		1	7	17.02	16.94	16.56
		1	14	16.86	16.87	16.63
		8	0	16.04	16.17	16.02
		8	3	16.15	16.07	16.01
		8	7	16.00	15.98	15.98
		15	0	16.05	15.98	15.83

*EIRP = Conducted + antenna gain (-4.7dBi)

LTE Band 4						
BW	MCS Index	Channel		19975	20175	20375
		Frequency (MHz)		1712.5	1732.5	1752.5
5M	QPSK	1	0	18.19	18.10	18.12
		1	12	17.80	18.26	18.16
		1	24	17.55	17.97	17.95
		12	0	17.13	17.18	16.89
		12	6	17.03	17.04	16.86
		12	13	16.74	16.94	16.77
		25	0	16.71	16.84	16.56
	16QAM	1	0	16.57	17.03	16.92
		1	12	17.03	16.88	16.58
		1	24	16.83	16.76	16.58
		12	0	16.08	16.02	15.98
		12	6	16.05	16.04	16.01
		12	13	16.05	15.99	15.84
		25	0	16.06	15.99	15.90
LTE Band 4						
BW	MCS Index	Channel		20000	20175	20350
		Frequency (MHz)		1715	1732.5	1750
10M	QPSK	1	0	18.09	18.20	18.15
		1	24	17.85	18.18	18.04
		1	49	17.51	18.01	18.04
		25	0	17.13	17.19	16.93
		25	12	16.90	17.09	16.79
		25	25	16.86	16.98	16.77
		50	0	16.79	16.85	16.67
	16QAM	1	0	16.60	17.11	16.88
		1	24	17.03	16.89	16.55
		1	49	16.88	16.83	16.62
		25	0	16.16	16.09	16.06
		25	12	16.09	16.13	15.99
		25	25	16.06	15.99	15.97

*EIRP = Conducted + antenna gain (-4.7dBi)

LTE Band 4

BW	MCS Index	Channel		20025	20175	20325
		Frequency (MHz)		1717.5	1732.5	1747.5
15M	QPSK	1	0	18.20	18.23	18.24
		1	37	17.94	18.26	18.16
		1	74	17.62	18.06	18.10
		36	0	17.19	17.21	16.95
		36	19	17.04	17.10	16.91
		36	39	16.86	17.01	16.91
	16QAM	75	0	16.83	16.89	16.67
		1	0	16.65	17.11	16.92
		1	37	17.11	16.97	16.69
		1	74	16.91	16.87	16.73

LTE Band 4

BW	MCS Index	Channel		20050	20175	20300
		Frequency (MHz)		1720	1732.5	1745
20M	QPSK	1	0	18.25	18.29	18.28
		1	50	17.96	18.27	18.24
		1	99	17.68	18.11	18.11
		50	0	17.19	17.21	17.01
		50	25	17.05	17.13	16.97
		50	50	16.93	17.02	16.96
	16QAM	100	0	16.91	16.98	16.76
		1	0	16.68	17.17	16.96
		1	50	17.16	17.05	16.75
		1	99	17.01	16.90	16.81

*EIRP = Conducted + antenna gain (-4.7dBi)

ERP Power (dBm)

LTE Band 13						
BW	MCS Index	Channel		23205	23230	23255
		Frequency (MHz)		779.5	782	784.5
5M	QPSK	1	0	12.19	12.18	12.26
		1	12	12.15	12.16	12.16
		1	24	11.89	11.84	11.82
		12	0	11.12	11.12	11.15
		12	6	11.07	11.01	11.09
		12	13	10.97	11.01	10.91
		25	0	10.93	10.90	10.89
	16QAM	1	0	11.13	11.05	11.13
		1	12	10.87	10.84	10.87
		1	24	10.50	10.52	10.58
		12	0	10.31	10.40	10.37
		12	6	10.23	10.21	10.31
		12	13	10.05	10.00	10.01
		25	0	10.33	10.31	10.41
LTE Band 13						
BW	MCS Index	Channel		23230		
		Frequency (MHz)		782		
10M	QPSK	1	0	12.28		
		1	24	12.22		
		1	49	11.89		
		25	0	11.22		
		25	12	11.11		
		25	25	11.01		
		50	0	10.98		
	16QAM	1	0	11.13		
		1	24	10.94		
		1	49	10.58		
		25	0	10.40		
		25	12	10.31		
		25	25	10.06		

*ERP = Conducted + antenna gain (-8.8dBi)-2.15

4.2 Modulation Characteristics Measurement

4.2.1 Limits of Modulation Characteristics

N/A

4.2.2 Test Setup



4.2.3 Test Procedure

Connect the EUT to Communication Simulator via the antenna connector. The frequency band is set as EUT supported Modulation and Channels, the EUT output is matched with 50 ohm load, the waveform quality and constellation of the EUT was tested.

4.2.4 Test Results

LTE Band 4

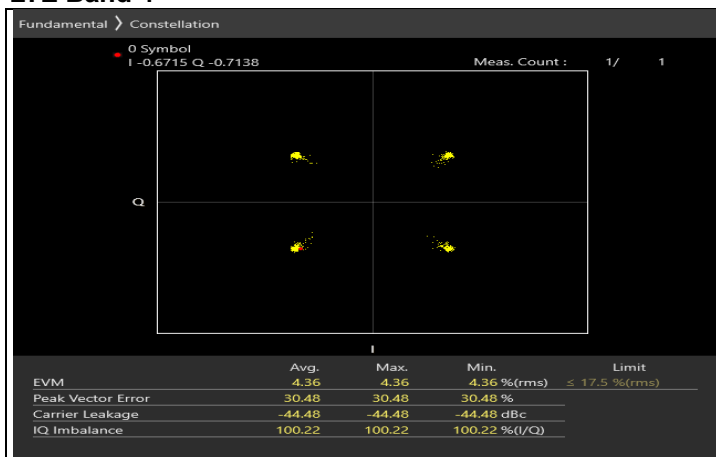

QPSK (1732.5MHz)

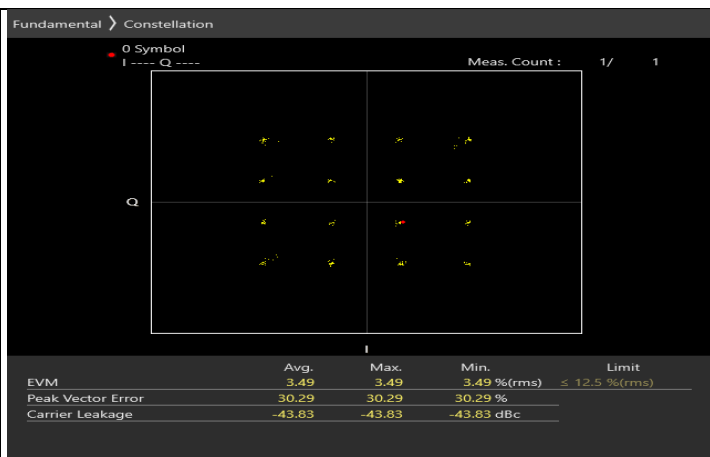

16QAM (1732.5MHz)

LTE Band 13

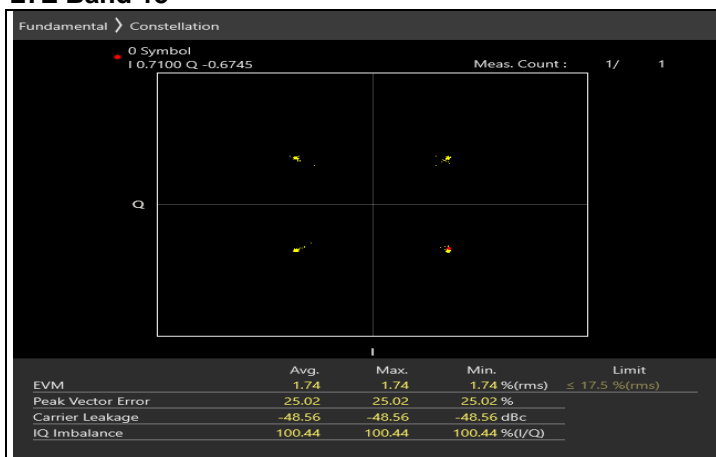

QPSK (782MHz)

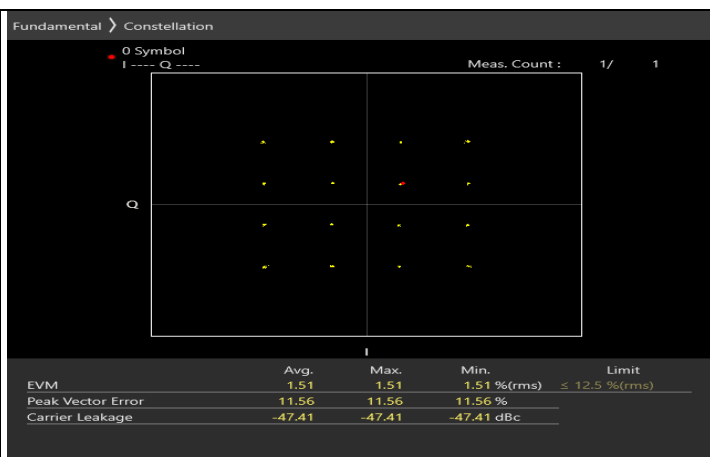

16QAM (782MHz)

4.3 Frequency Stability Measurement

4.3.1 Limits of Frequency Stability Measurement

The frequency stability shall be sufficient to ensure that the fundamental emissions stay within the authorized bands of operation.

4.3.2 Test Procedure

- Device is placed at the oven room. The oven room could control the temperatures and humidity. Power warm up is at least 15 min and power applied should perform before recording frequency error.
- EUT is connected the external power supply to control the DC input power. The test voltage range is from minimum to maximum working voltage. Each step shall be record the frequency error rate.
- The temperature range step is 10 degrees in this test items. All temperature levels shall be hold the $\pm 0.5^{\circ}\text{C}$ during the measurement testing. The each temperature step shall be at least 0.5 hours, consider the EUT could be test under the stability condition.

Note: The frequency error was recorded frequency error from the communication simulator.

4.3.3 Test Setup

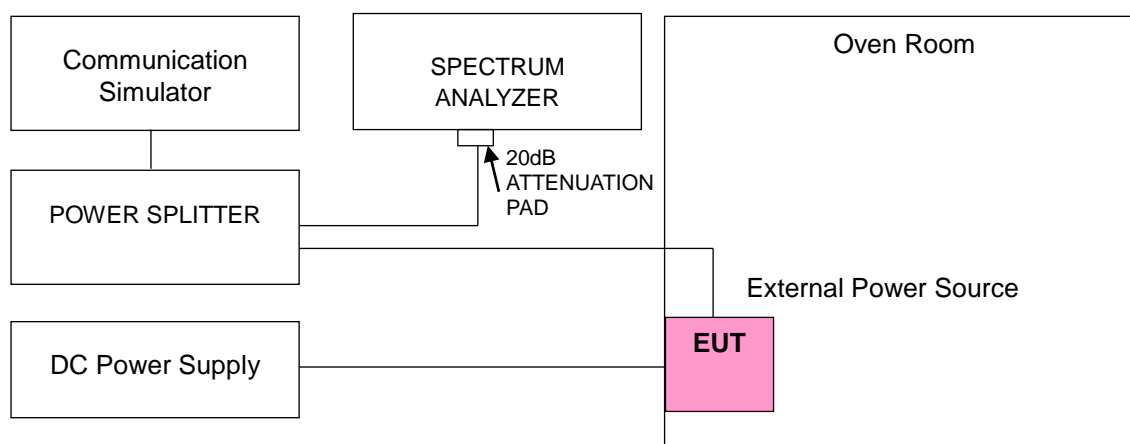

4.3.4 Test Results

Frequency Error vs. Voltage

Voltage (Volts)	LTE Band 4			
	Channel Bandwidth: 1.4 MHz			
	Low Channel		High Channel	
	Frequency (MHz)	Frequency Error (ppm)	Frequency (MHz)	Frequency Error (ppm)
3.27	1710.7000030	0.002	1754.2999960	-0.002
3.85	1710.6999970	-0.002	1754.3000020	0.001
4.43	1710.7000020	0.001	1754.3000040	0.002

Note: The applicant defined the normal working voltage of the battery is from 3.27 Vdc to 4.43 Vdc.

Frequency Error vs. Temperature

Temp. (°C)	LTE Band 4			
	Channel Bandwidth: 1.4 MHz			
	Low Channel		High Channel	
	Frequency (MHz)	Frequency Error (ppm)	Frequency (MHz)	Frequency Error (ppm)
-30	1710.7000010	0.001	1754.2999970	-0.002
-20	1710.6999980	-0.001	1754.2999970	-0.002
-10	1710.6999990	-0.001	1754.2999960	-0.002
0	1710.7000040	0.002	1754.3000040	0.002
10	1710.6999960	-0.002	1754.3000030	0.002
20	1710.6999960	-0.002	1754.3000010	0.001
30	1710.6999990	-0.001	1754.3000010	0.001
40	1710.7000030	0.002	1754.2999970	-0.002
50	1710.7000010	0.001	1754.3000040	0.002
60	1710.6999960	-0.002	1754.2999960	-0.002

Frequency Error vs. Voltage

Voltage (Volts)	LTE Band 4			
	Channel Bandwidth: 3 MHz			
	Low Channel		High Channel	
	Frequency (MHz)	Frequency Error (ppm)	Frequency (MHz)	Frequency Error (ppm)
3.85	1711.5000010	0.001	1753.5000010	0.001
3.27	1711.4999970	-0.002	1753.4999960	-0.002
4.43	1711.4999960	-0.002	1753.5000030	0.002

Note: The applicant defined the normal working voltage of the battery is from 3.27 Vdc to 4.43 Vdc.

Frequency Error vs. Temperature

Temp. (°C)	LTE Band 4			
	Channel Bandwidth: 3 MHz			
	Low Channel		High Channel	
	Frequency (MHz)	Frequency Error (ppm)	Frequency (MHz)	Frequency Error (ppm)
-30	1711.4999980	-0.001	1753.5000040	0.002
-20	1711.5000030	0.002	1753.4999970	-0.002
-10	1711.5000040	0.002	1753.5000020	0.001
0	1711.4999980	-0.001	1753.5000040	0.002
10	1711.4999990	-0.001	1753.4999980	-0.001
20	1711.4999990	-0.001	1753.4999970	-0.002
30	1711.4999960	-0.002	1753.4999970	-0.002
40	1711.5000040	0.002	1753.4999990	-0.001
50	1711.4999990	-0.001	1753.5000010	0.001
60	1711.4999970	-0.002	1753.4999970	-0.002

Frequency Error vs. Voltage

Voltage (Volts)	LTE Band 4			
	Channel Bandwidth: 5 MHz			
	Low Channel		High Channel	
	Frequency (MHz)	Frequency Error (ppm)	Frequency (MHz)	Frequency Error (ppm)
3.85	1712.4999960	-0.002	1752.5000020	0.001
3.27	1712.5000040	0.002	1752.4999980	-0.001
4.43	1712.4999980	-0.001	1752.5000030	0.002

Note: The applicant defined the normal working voltage of the battery is from 3.27 Vdc to 4.43 Vdc.

Frequency Error vs. Temperature

Temp. (°C)	LTE Band 4			
	Channel Bandwidth: 5 MHz			
	Low Channel		High Channel	
	Frequency (MHz)	Frequency Error (ppm)	Frequency (MHz)	Frequency Error (ppm)
-30	1712.5000030	0.002	1752.4999990	-0.001
-20	1712.4999980	-0.001	1752.5000040	0.002
-10	1712.4999970	-0.002	1752.5000020	0.001
0	1712.5000040	0.002	1752.4999990	-0.001
10	1712.4999990	-0.001	1752.4999980	-0.001
20	1712.5000030	0.002	1752.5000020	0.001
30	1712.4999970	-0.002	1752.5000040	0.002
40	1712.4999990	-0.001	1752.4999990	-0.001
50	1712.5000040	0.002	1752.5000030	0.002
60	1712.5000030	0.002	1752.5000040	0.002

Frequency Error vs. Voltage

Voltage (Volts)	LTE Band 4			
	Channel Bandwidth: 10 MHz			
	Low Channel		High Channel	
	Frequency (MHz)	Frequency Error (ppm)	Frequency (MHz)	Frequency Error (ppm)
3.85	1714.9999970	-0.002	1750.0000040	0.002
3.27	1714.9999970	-0.002	1749.9999970	-0.002
4.43	1715.0000030	0.002	1750.0000020	0.001

Note: The applicant defined the normal working voltage of the battery is from 3.27 Vdc to 4.43 Vdc.

Frequency Error vs. Temperature

Temp. (°C)	LTE Band 4			
	Channel Bandwidth: 10 MHz			
	Low Channel		High Channel	
	Frequency (MHz)	Frequency Error (ppm)	Frequency (MHz)	Frequency Error (ppm)
-30	1714.9999990	-0.001	1750.0000010	0.001
-20	1714.9999990	-0.001	1749.9999960	-0.002
-10	1714.9999980	-0.001	1750.0000040	0.002
0	1715.0000010	0.001	1749.9999990	-0.001
10	1715.0000020	0.001	1749.9999970	-0.002
20	1714.9999980	-0.001	1749.9999990	-0.001
30	1715.0000010	0.001	1750.0000040	0.002
40	1715.0000030	0.002	1749.9999980	-0.001
50	1714.9999980	-0.001	1749.9999960	-0.002
60	1714.9999990	-0.001	1750.0000010	0.001

Frequency Error vs. Voltage

Voltage (Volts)	LTE Band 4			
	Channel Bandwidth: 15 MHz			
	Low Channel		High Channel	
	Frequency (MHz)	Frequency Error (ppm)	Frequency (MHz)	Frequency Error (ppm)
3.85	1717.4999990	-0.001	1747.4999980	-0.001
3.27	1717.4999990	-0.001	1747.5000020	0.001
4.43	1717.4999980	-0.001	1747.5000030	0.002

Note: The applicant defined the normal working voltage of the battery is from 3.27 Vdc to 4.43 Vdc.

Frequency Error vs. Temperature

Temp. (°C)	LTE Band 4			
	Channel Bandwidth: 15 MHz			
	Low Channel		High Channel	
	Frequency (MHz)	Frequency Error (ppm)	Frequency (MHz)	Frequency Error (ppm)
-30	1717.4999970	-0.002	1747.5000040	0.002
-20	1717.5000040	0.002	1747.5000010	0.001
-10	1717.5000020	0.001	1747.4999960	-0.002
0	1717.5000030	0.002	1747.4999990	-0.001
10	1717.4999980	-0.001	1747.5000010	0.001
20	1717.5000010	0.001	1747.4999980	-0.001
30	1717.4999960	-0.002	1747.5000010	0.001
40	1717.4999970	-0.002	1747.4999980	-0.001
50	1717.5000020	0.001	1747.4999980	-0.001
60	1717.4999960	-0.002	1747.5000020	0.001

Frequency Error vs. Voltage

Voltage (Volts)	LTE Band 4			
	Channel Bandwidth: 20 MHz			
	Low Channel		High Channel	
	Frequency (MHz)	Frequency Error (ppm)	Frequency (MHz)	Frequency Error (ppm)
3.85	1720.0000040	0.002	1744.9999990	-0.001
3.27	1720.0000030	0.002	1744.9999960	-0.002
4.43	1719.9999970	-0.002	1744.9999960	-0.002

Note: The applicant defined the normal working voltage of the battery is from 3.27 Vdc to 4.43 Vdc.

Frequency Error vs. Temperature

Temp. (°C)	LTE Band 4			
	Channel Bandwidth: 20 MHz			
	Low Channel		High Channel	
	Frequency (MHz)	Frequency Error (ppm)	Frequency (MHz)	Frequency Error (ppm)
-30	1720.0000030	0.002	1745.0000010	0.001
-20	1719.9999990	-0.001	1745.0000030	0.002
-10	1719.9999970	-0.002	1745.0000030	0.002
0	1719.9999960	-0.002	1744.9999990	-0.001
10	1719.9999970	-0.002	1745.0000030	0.002
20	1720.0000010	0.001	1744.9999980	-0.001
30	1719.9999990	-0.001	1744.9999970	-0.002
40	1720.0000040	0.002	1744.9999960	-0.002
50	1720.0000040	0.002	1745.0000040	0.002
60	1719.9999980	-0.001	1745.0000030	0.002

Frequency Error vs. Voltage

Voltage (Volts)	LTE Band 13			
	Channel Bandwidth: 5 MHz			
	Low Channel		High Channel	
	Frequency (MHz)	Frequency Error (ppm)	Frequency (MHz)	Frequency Error (ppm)
3.85	779.4999980	-0.003	784.4999970	-0.004
3.27	779.4999960	-0.005	784.4999980	-0.003
4.43	779.4999980	-0.003	784.5000040	0.005

Note: The applicant defined the normal working voltage of the battery is from 3.27 Vdc to 4.43 Vdc.

Frequency Error vs. Temperature

Temp. (°C)	LTE Band 13			
	Channel Bandwidth: 5 MHz			
	Low Channel		High Channel	
	Frequency (MHz)	Frequency Error (ppm)	Frequency (MHz)	Frequency Error (ppm)
-30	779.4999990	-0.001	784.5000040	0.005
-20	779.4999970	-0.004	784.5000040	0.005
-10	779.5000010	0.001	784.5000040	0.005
0	779.4999980	-0.003	784.5000040	0.005
10	779.4999960	-0.005	784.4999990	-0.001
20	779.4999970	-0.004	784.5000040	0.005
30	779.5000030	0.004	784.4999970	-0.004
40	779.5000030	0.004	784.4999960	-0.005
50	779.5000040	0.005	784.5000020	0.003
60	779.5000040	0.005	784.4999990	-0.001

Frequency Error vs. Voltage

Voltage (Volts)	LTE Band 13	
	Channel Bandwidth: 10 MHz	
	Frequency (MHz)	Frequency Error (ppm)
3.85	782.0000020	0.003
3.27	782.0000030	0.004
4.43	781.9999970	-0.004

Note: The applicant defined the normal working voltage of the battery is from 3.27 Vdc to 4.43 Vdc.

Frequency Error vs. Temperature

Temp. (°C)	LTE Band 13	
	Channel Bandwidth: 10 MHz	
	Frequency (MHz)	Frequency Error (ppm)
-30	781.9999960	-0.005
-20	781.9999970	-0.004
-10	781.9999990	-0.001
0	781.9999980	-0.003
10	782.0000010	0.001
20	782.0000030	0.004
30	781.9999970	-0.004
40	781.9999970	-0.004
50	781.9999990	-0.001
60	781.9999960	-0.005

4.4 Occupied Bandwidth Measurement

4.4.1 Limits of Occupied Bandwidth Measurement

The width of a frequency band such that, below the lower and above the upper frequency limits, the mean powers emitted are each equal to a specified percentage 0.5 % of the total mean power of a given emission.

4.4.2 Test Procedure

The EUT makes a call to the communication simulator. All measurements were done at low, middle and high operational frequency range. The communication simulator station system controlled a EUT to export maximum output power under transmission mode and specific channel frequency.

For the 26dBc bandwidth measurement method, please refer to section 5.4.3 of ANSI C63.26.

- a) The spectrum analyzer center frequency is set to the nominal EUT channel center frequency. The span range for the spectrum analyzer shall be wide enough to see sufficient roll off of the signal to make the measurement.
- b) The nominal RBW shall be in the range of 1% to 5% of the anticipated OBW, and the VBW shall be set $\geq 3 \times$ RBW.
- c) Set the reference level of the instrument as required to prevent the signal amplitude from exceeding the maximum spectrum analyzer input mixer level for linear operation. See guidance provided in 4.2.3.
- d) The dynamic range of the spectrum analyzer at the selected RBW shall be more than 10 dB below the target “-X dB” requirement, i.e., if the requirement calls for measuring the -26 dB OBW, the spectrum analyzer noise floor at the selected RBW shall be at least 36 dB below the reference level.
- e) Set spectrum analyzer detection mode to peak, and the trace mode to max hold.
- f) Determine the following reference values: Set the EUT to transmit a modulated signal. Allow the trace to stabilize. Set the spectrum analyzer marker to the highest level of the displayed trace (this is the reference value).
- g) Determine the “-X dB amplitude” as equal to (Reference Value - X). Alternatively, this calculation can be performed on the spectrum analyzer using the delta-marker measurement function.
- h) Place two markers, one at the lowest and the other at the highest frequency of the envelope of the spectral display such that each marker is at or slightly below the “-X dB amplitude” determined in step f). If a marker is below this “-X dB amplitude” value it should be as close as possible to this value. The OBW is the positive frequency difference between the two markers.
- i) The OBW shall be reported by providing plot(s) of the measuring instrument display, to include markers depicting the relevant frequency and amplitude information (e.g., marker table). The frequency and amplitude axis and scale shall be clearly labeled. Tabular data may be reported in addition to the plot(s).

For the occupied bandwidth measurement method, please refer to section 5.4.4 of ANSI C63.26.

4.4.3 Test Setup

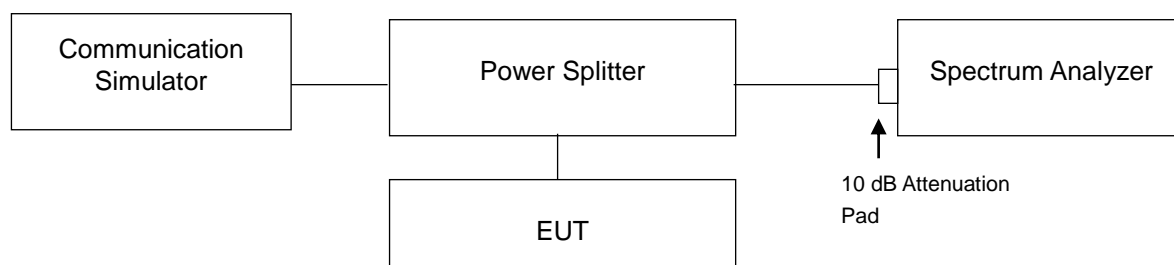

4.4.4 Test Result

LTE Band 4 (Channel Bandwidth 1.4MHz)

Test Condition	Channel	Frequency (MHz)	Occupied bandwidth (MHz)	26 dB Bandwidth (MHz)
QPSK	19957	1710.7	1.0879	1.284
QPSK	20175	1732.5	1.0920	1.288
QPSK	20393	1754.3	1.0926	1.408
16QAM	19957	1710.7	1.0883	1.257
16QAM	20175	1732.5	1.0892	1.262
16QAM	20393	1754.3	1.0889	1.275

NOTE: For the test plots please refer to the below pages.

Spectrum Plot of Worst Value

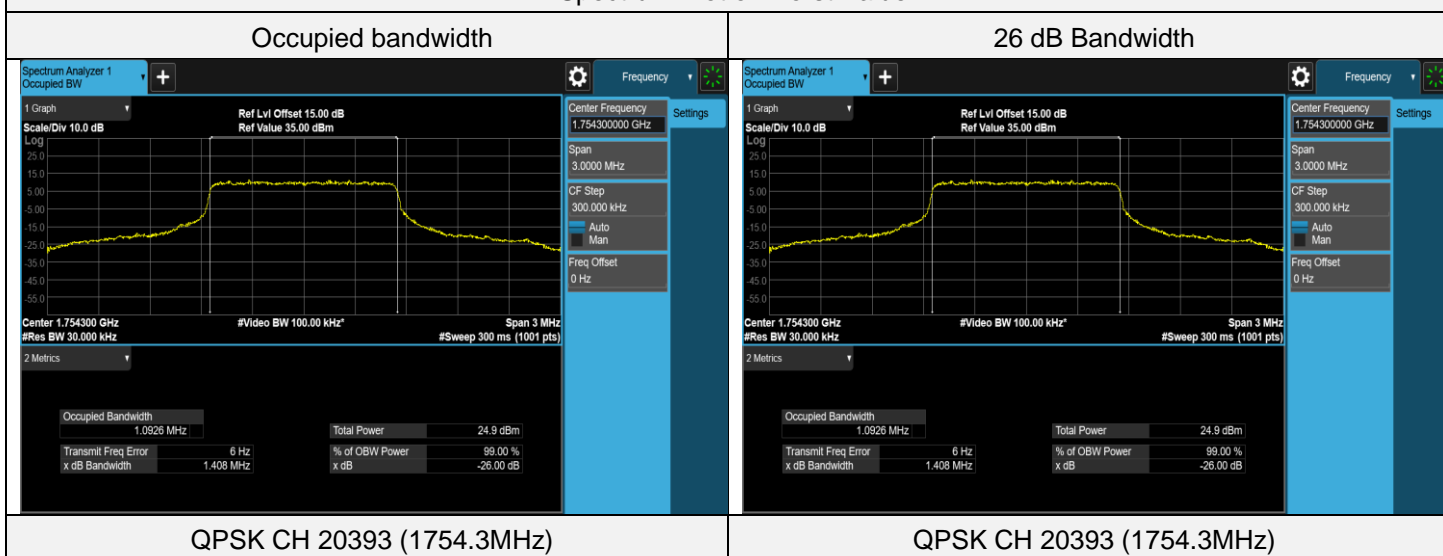

LTE Band 4 (Channel Bandwidth 3MHz)

Test Condition	Channel	Frequency (MHz)	Occupied bandwidth (MHz)	26 dB Bandwidth (MHz)
QPSK	19965	1711.5	2.6952	2.936
QPSK	20175	1732.5	2.6972	2.936
QPSK	20385	1753.5	2.6993	2.980
16QAM	19965	1711.5	2.6976	2.934
16QAM	20175	1732.5	2.6967	2.942
16QAM	20385	1753.5	2.6994	2.968

NOTE: For the test plots please refer to the below pages.

Spectrum Plot of Worst Value

Occupied bandwidth

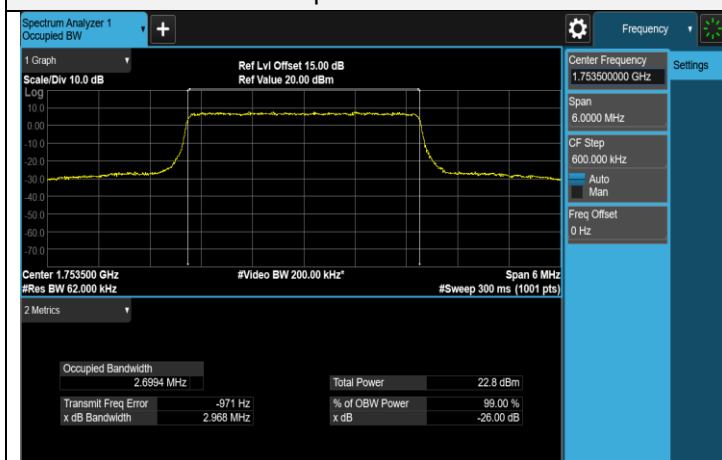

16QAM CH 20385 (1753.5MHz)

26 dB Bandwidth

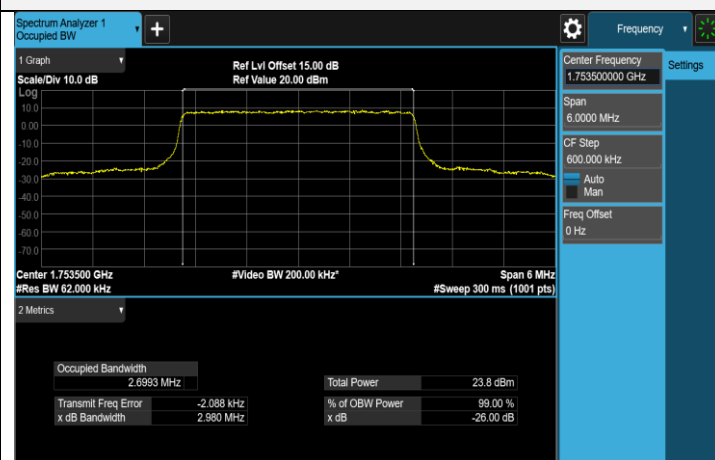

QPSK CH 20385 (1753.5MHz)

LTE Band 4 (Channel Bandwidth 5MHz)

Test Condition	Channel	Frequency (MHz)	Occupied bandwidth (MHz)	26 dB Bandwidth (MHz)
QPSK	19975	1712.5	4.4929	4.864
QPSK	20175	1732.5	4.4940	4.852
QPSK	20375	1752.5	4.4978	4.967
16QAM	19975	1712.5	4.4878	4.843
16QAM	20175	1732.5	4.4907	4.858
16QAM	20375	1752.5	4.4932	4.901

NOTE: For the test plots please refer to the below pages.

Spectrum Plot of Worst Value

Occupied bandwidth

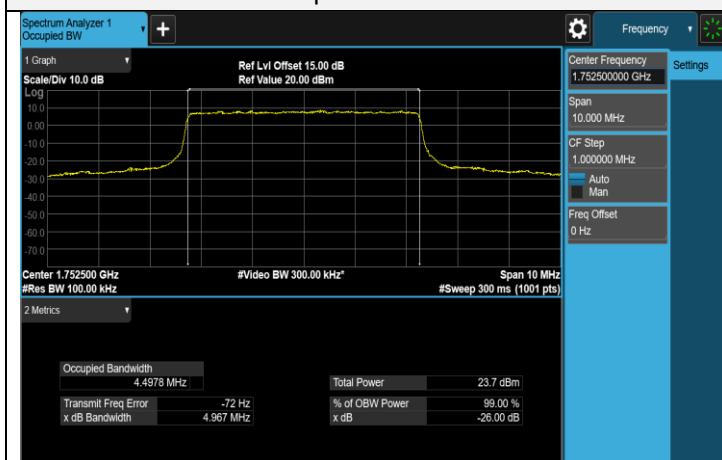

QPSK CH 20375 (1752.5MHz)

26 dB Bandwidth

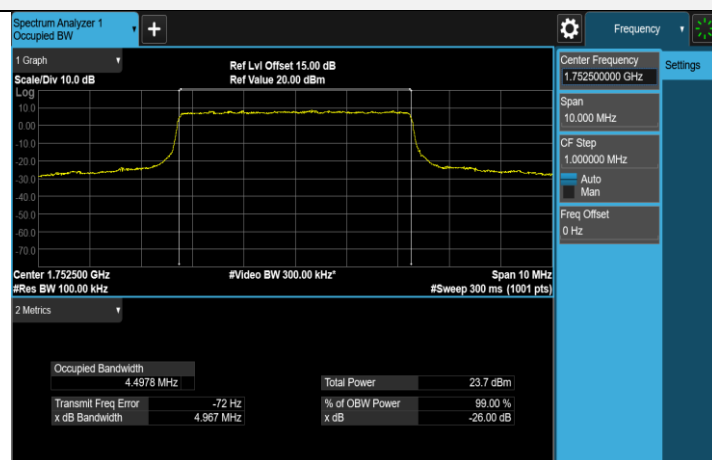

QPSK CH 20375 (1752.5MHz)

LTE Band 4 (Channel Bandwidth 10MHz)

Test Condition	Channel	Frequency (MHz)	Occupied bandwidth (MHz)	26 dB Bandwidth (MHz)
QPSK	20000	1715	8.9466	9.700
QPSK	20175	1732.5	8.9514	9.617
QPSK	20350	1750	8.9611	9.895
16QAM	20000	1715	4.5786	5.213
16QAM	20175	1732.5	4.5770	5.276
16QAM	20350	1750	4.5876	5.674

NOTE: For the test plots please refer to the below pages.

Spectrum Plot of Worst Value

Occupied bandwidth

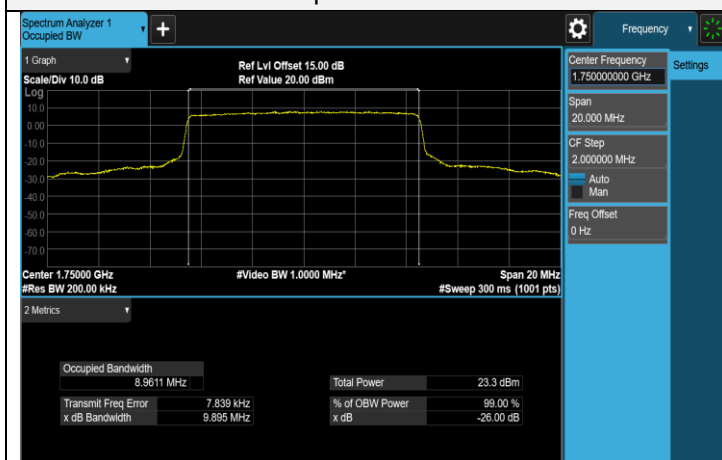

QPSK CH 20350 (1750MHz)

26 dB Bandwidth

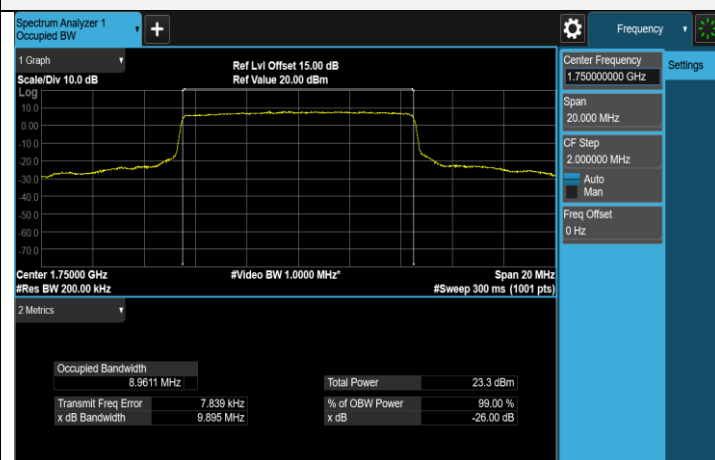

QPSK CH 20350 (1750MHz)

LTE Band 4 (Channel Bandwidth 15MHz)

Test Condition	Channel	Frequency (MHz)	Occupied bandwidth (MHz)	26 dB Bandwidth (MHz)
QPSK	20025	1717.5	13.4065	14.294
QPSK	20175	1732.5	13.4248	14.285
QPSK	20325	1747.5	13.4311	14.389
16QAM	20025	1717.5	4.6848	5.596
16QAM	20175	1732.5	4.6811	5.555
16QAM	20325	1747.5	4.6904	5.628

NOTE: For the test plots please refer to the below pages.

Spectrum Plot of Worst Value

Occupied bandwidth

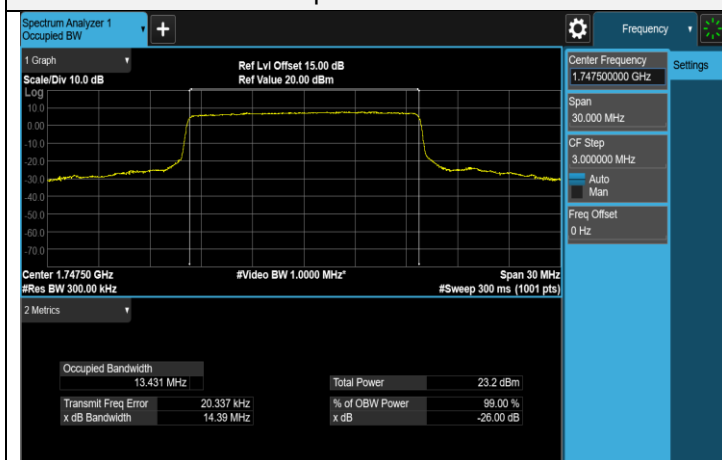

QPSK CH 20325 (1747.5MHz)

26 dB Bandwidth

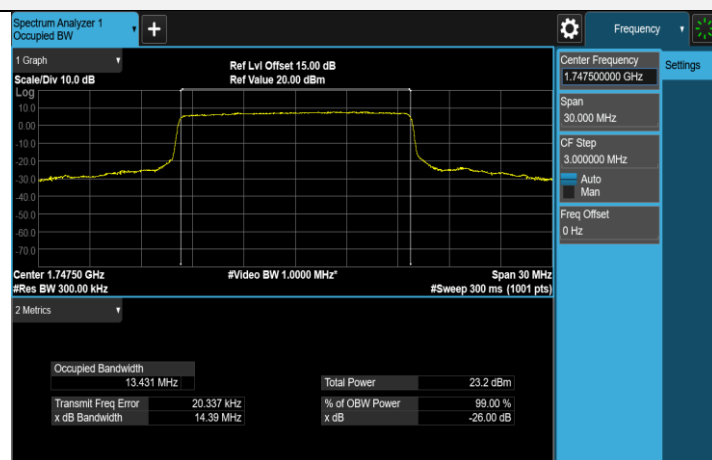

QPSK CH 20325 (1747.5MHz)

LTE Band 4 (Channel Bandwidth 20MHz)

Test Condition	Channel	Frequency (MHz)	Occupied bandwidth (MHz)	26 dB Bandwidth (MHz)
QPSK	20050	1720	17.8203	19.048
QPSK	20175	1732.5	17.8875	19.097
QPSK	20300	1745	17.9218	19.232
16QAM	20050	1720	4.8417	5.835
16QAM	20175	1732.5	4.8305	5.756
16QAM	20300	1745	4.8353	5.767

NOTE: For the test plots please refer to the below pages.

Spectrum Plot of Worst Value

Occupied bandwidth

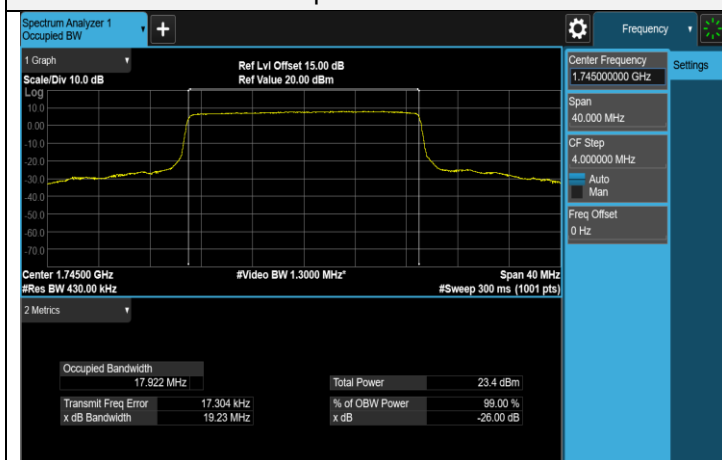

QPSK CH 20300 (1745MHz)

26 dB Bandwidth

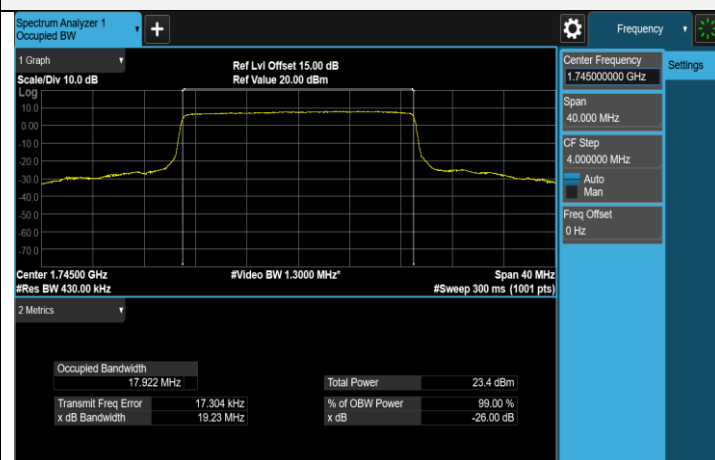

QPSK CH 20300 (1745MHz)

LTE Band 13 (Channel Bandwidth 5MHz)

Test Condition	Channel	Frequency (MHz)	Occupied bandwidth (MHz)	26 dB Bandwidth (MHz)
QPSK	23205	779.5	4.4927	4.827
QPSK	23230	782	4.4826	4.810
QPSK	23255	784.5	4.5004	4.844
16QAM	23205	779.5	4.4954	4.832
16QAM	23230	782	4.4788	4.797
16QAM	23255	784.5	4.4957	4.818

NOTE: For the test plots please refer to the below pages.

Spectrum Plot of Worst Value

Occupied bandwidth

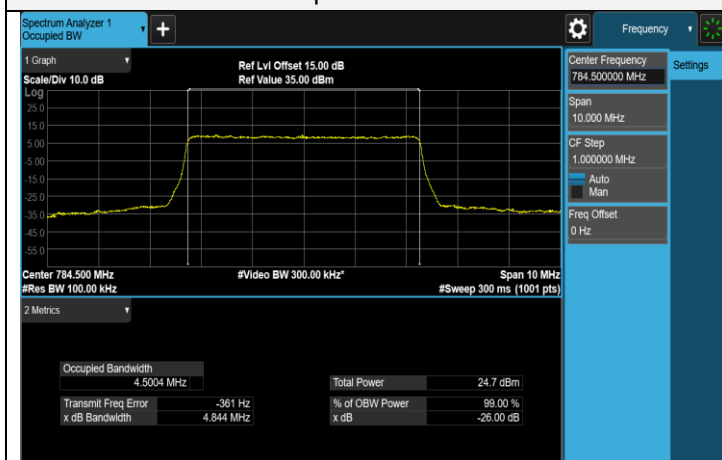

QPSK CH 23255 (784.5MHz)

26 dB Bandwidth

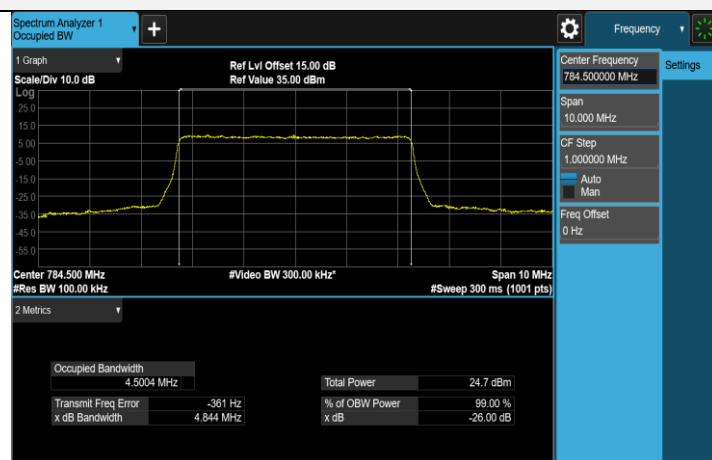

QPSK CH 23255 (784.5MHz)

LTE Band 13 (Channel Bandwidth 10MHz)

Test Condition	Channel	Frequency (MHz)	Occupied bandwidth (MHz)	26 dB Bandwidth (MHz)
QPSK	23230	782	8.9599	9.508
16QAM	23230	782	4.5530	5.052

NOTE: For the test plots please refer to the below pages.

Spectrum Plot of Worst Value

Occupied bandwidth

26 dB Bandwidth

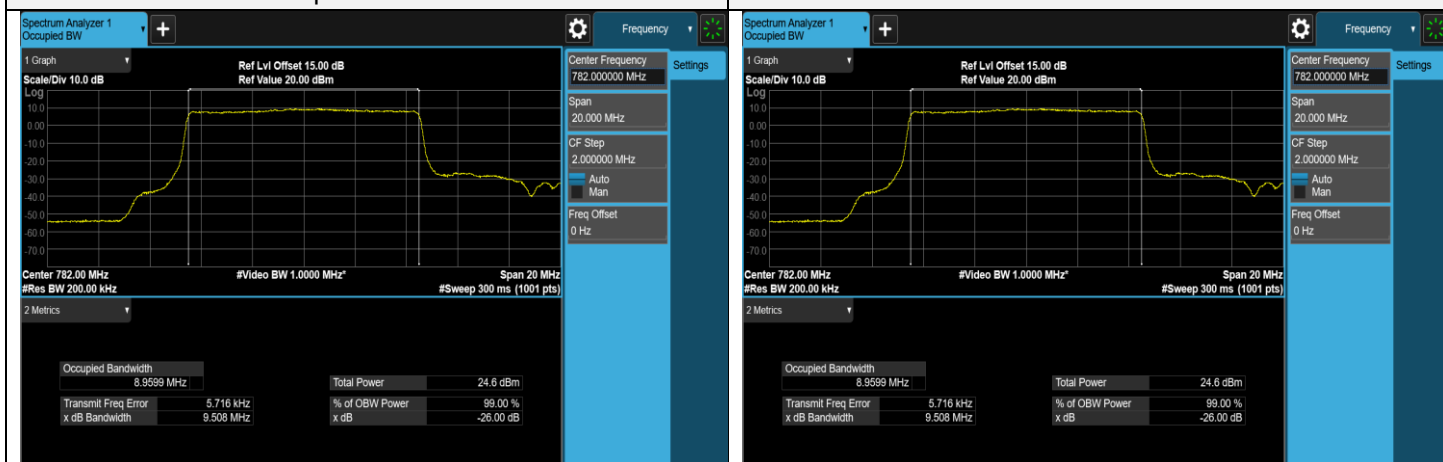

QPSK CH 23230 (782MHz)

QPSK CH 23230 (782MHz)

4.5 Channel Edge / Out-of-Band Emissions Measurement

4.5.1 Limits of Band Edge / Out-of-Band Emissions Measurement

For LTE Band 4:

According to FCC 27.53(h), for operations in the 1695-1710MHz, 1710-1755MHz, 1755-1780 MHz, 1915-1920MHz, 1995-2000 MHz, 2000-2020MHz, 2110-2155MHz, 2155-2180 MHz, and 2180-2200 bands, the power of any emission outside a licensee's frequency block shall be attenuated below the transmitter power (P) in watts by at least $43 + 10 \log (P)$ dB. However, in the 1 megahertz bands immediately outside and adjacent to the licensee's frequency block, a resolution bandwidth of at least one percent of the emission bandwidth of the fundamental emission of the transmitter may be employed.

For LTE Band 13:

According to FCC 27.53(c)(2), for on any frequency outside the 776-788 MHz band, the power of any emission shall be attenuated outside the band below the transmitter power (P) by at least $43 + 10 \log (P)$ dB. Compliance with this provision is based on the use of measurement instrumentation employing a resolution bandwidth of 100 kilohertz or greater. However, in the 100 kilohertz bands immediately outside and adjacent to a licensee's frequency block, a resolution bandwidth of at least 30 kHz may be employed.

According to 27.53(c)(4), on all frequencies between 763-775MHz and 793-805MHz, by a factor not less than $65 + 10 \log (P)$ dB in a 6.25 kHz band segment, for mobile and portable stations

4.5.2 Test Setup

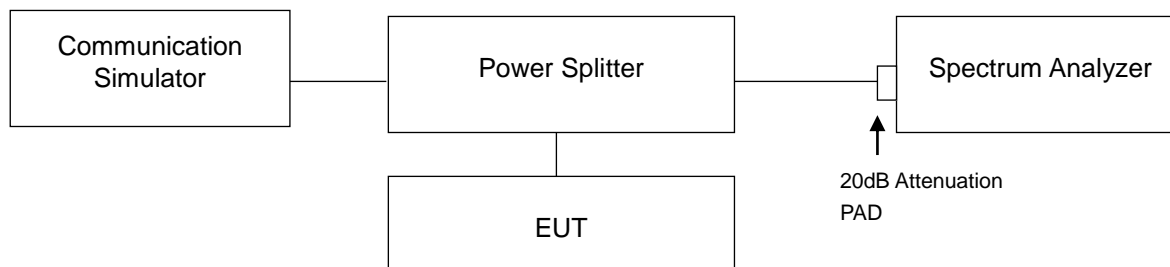

4.5.3 Test Procedures

- a. All measurements were done at low and high operational frequency range.
- b. The detector of the spectrum is RMS, and if the device can be configured to transmit continuously (duty cycle $\geq 98\%$), set the (sweep time) $>$ (number of points in sweep) \times (symbol period) (e.g., by a factor of $10 \times$ symbol period \times number of points). Increasing the sweep time (i.e., slowing the sweep speed) will allow for averaging over multiple symbols
- c. The center frequency of spectrum is the band edge frequency and span is 1 MHz or 2MHz. RB of the spectrum is 30 kHz and VB of the spectrum is 100 kHz.
- d. Measurement method refers to ANSI C63.26 section 5.7.2 and 5.7.3.
- e. For LTE Band 13 measurements in the 763 - 775 MHz and 793 - 805 MHz band, the FCC limit is $65 + 10 \log (P[\text{watt}])$ in a 6.25 kHz bandwidth. Since it was not possible to set the resolution bandwidth to 6.25 kHz with the available equipment, a bandwidth of 6.8 kHz was used instead to show compliance, and the correction factor is compensated at the spectrum.
- f. Record the max. trace plot into the test report.

4.5.4 Test Results

LTE Band 4 (Channel Bandwidth 1.4MHz)

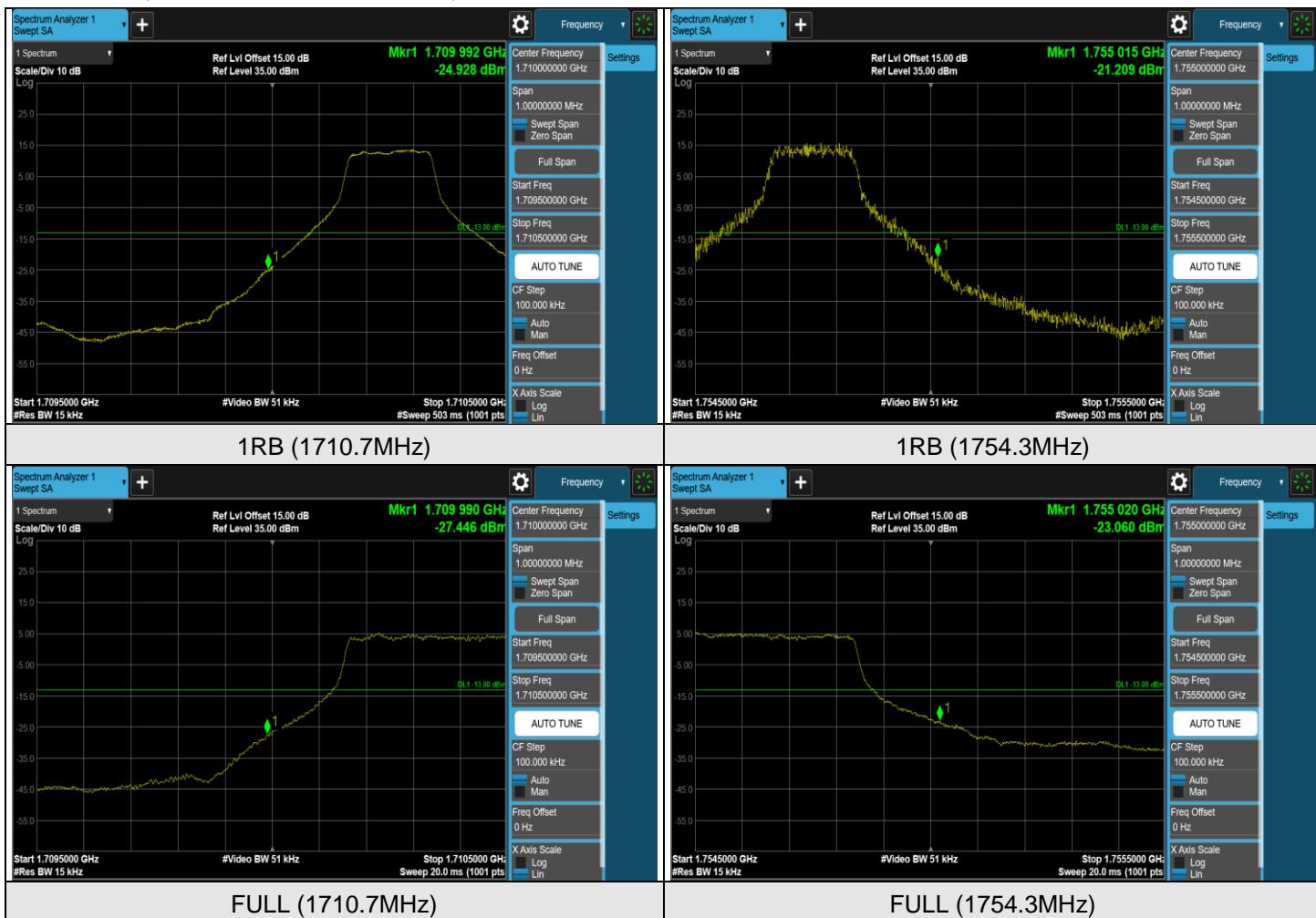

LTE Band 4 (Channel Bandwidth 3MHz)

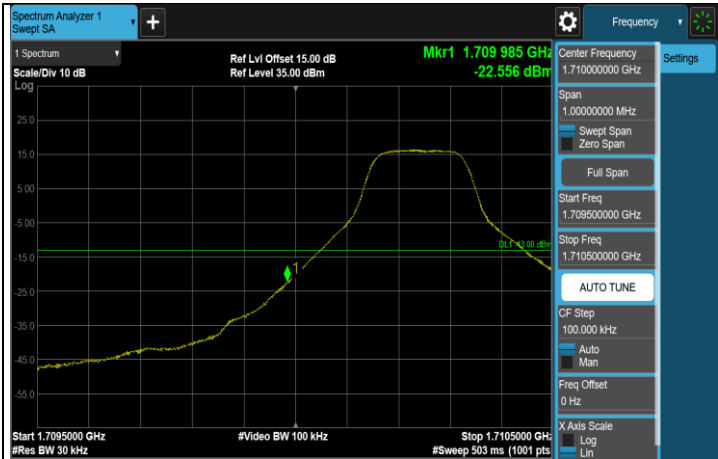

1RB (1711.5MHz)

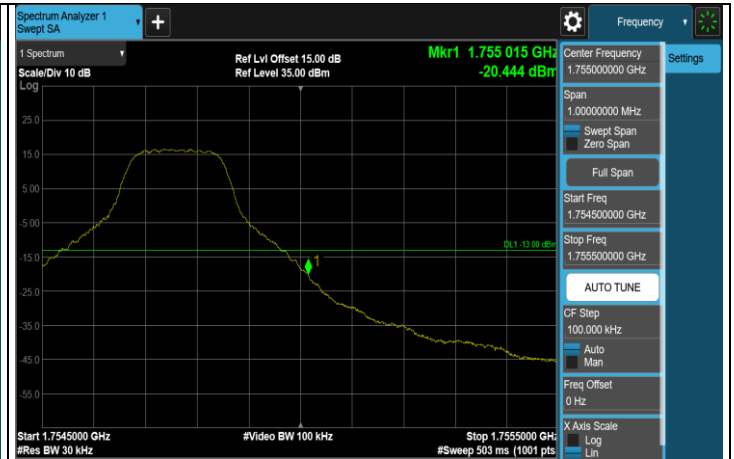

1RB (1753.5MHz)

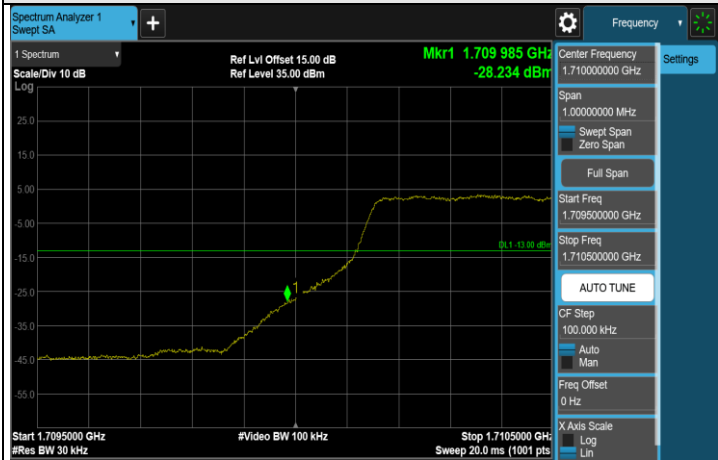

FULL (1711.5MHz)

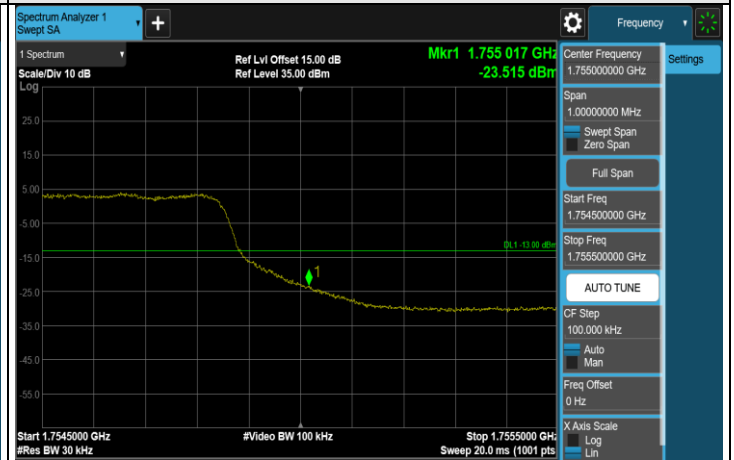

FULL (1753.5MHz)

LTE Band 4 (Channel Bandwidth 5MHz)

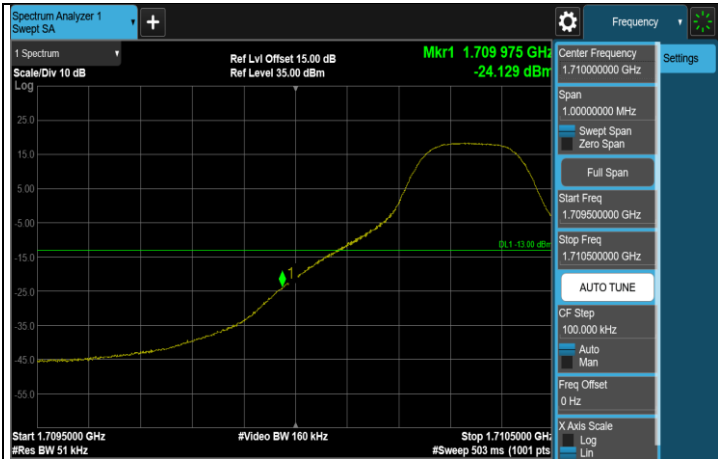

1RB (1712.5MHz)

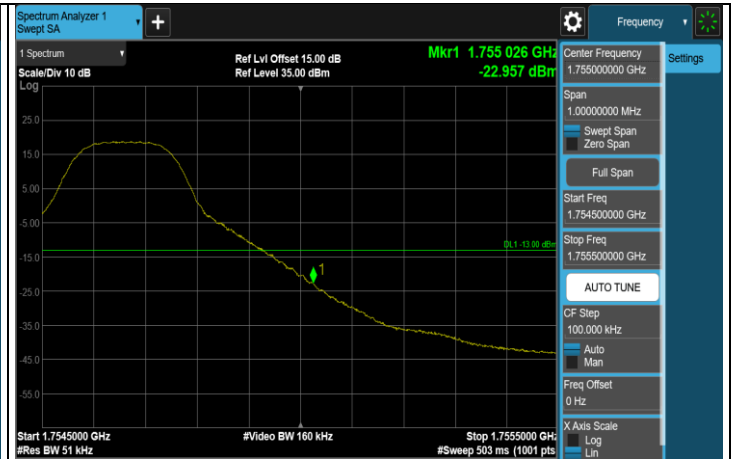

1RB (1752.5MHz)

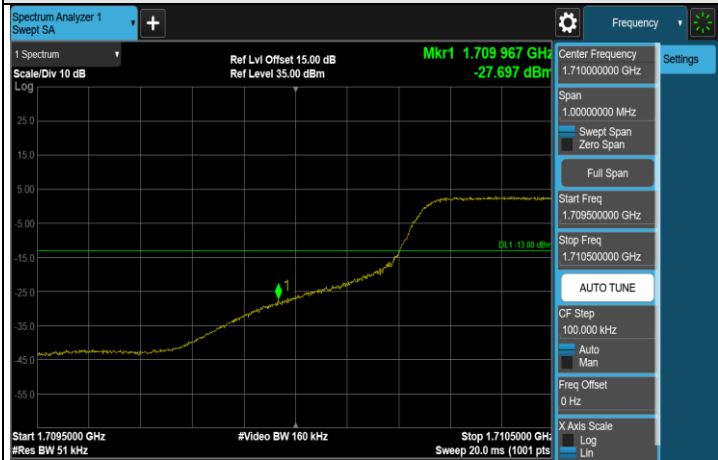

FULL (1712.5MHz)

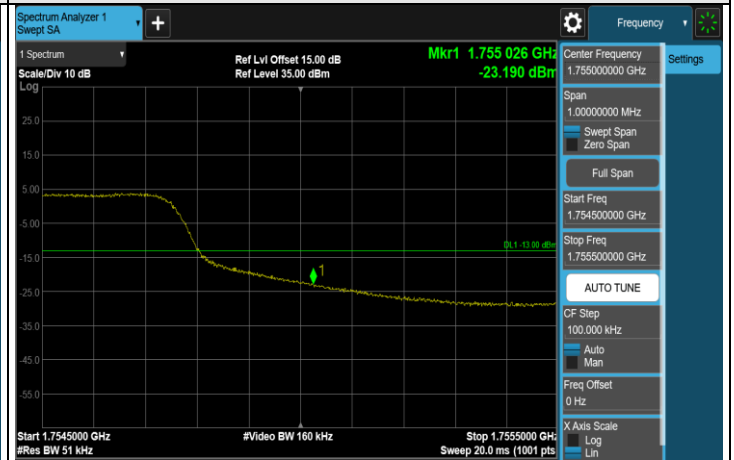

FULL (1752.5MHz)

LTE Band 4 (Channel Bandwidth 10MHz)

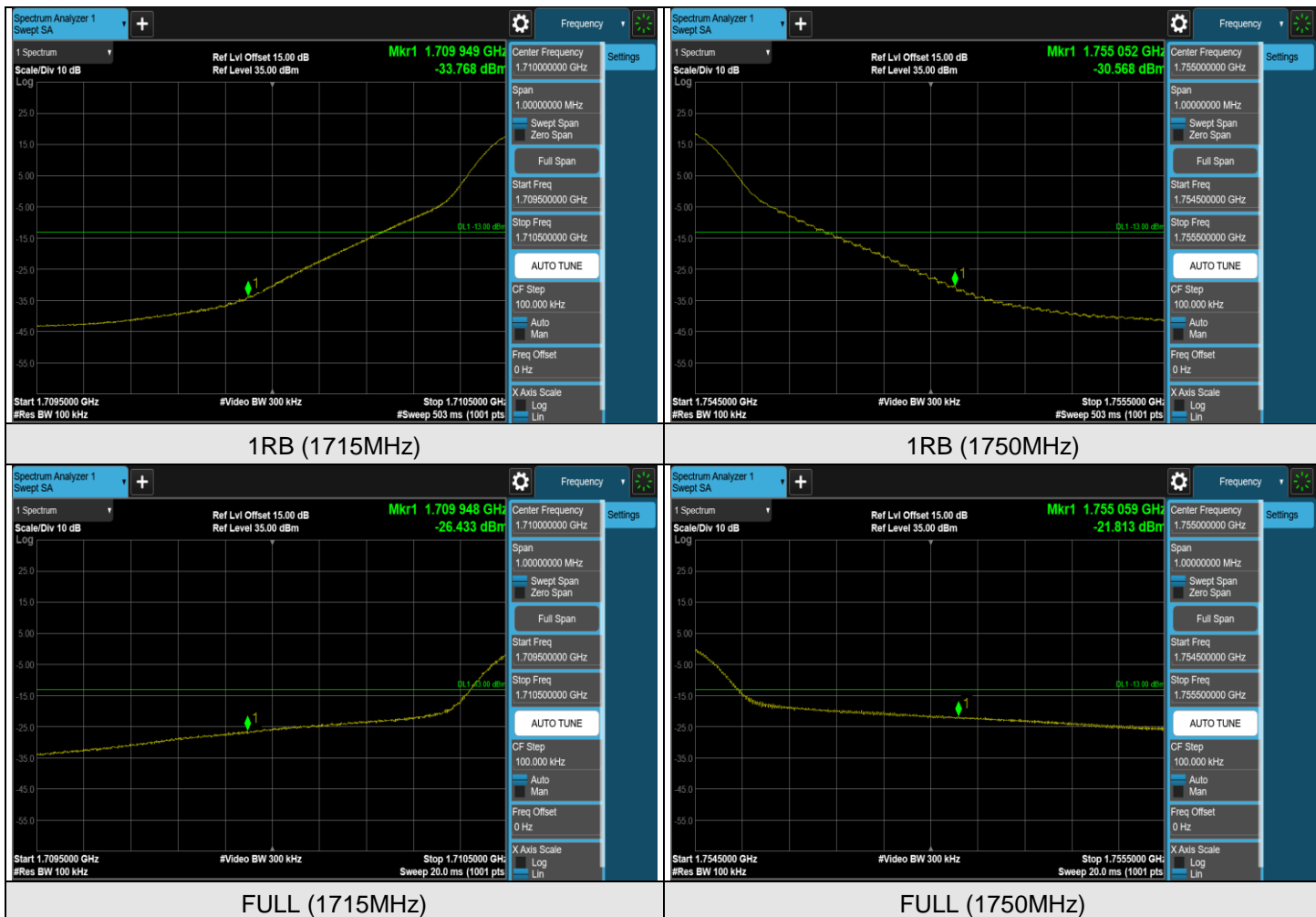



LTE Band 4 (Channel Bandwidth 15MHz)

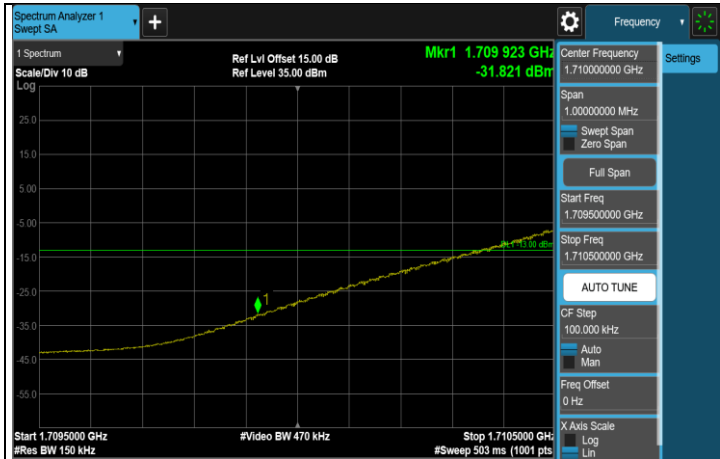

1RB (1717.5MHz)

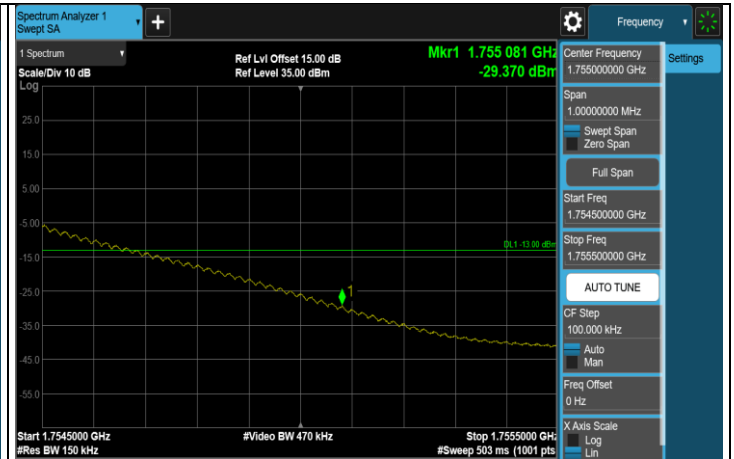

1RB (1747.5MHz)

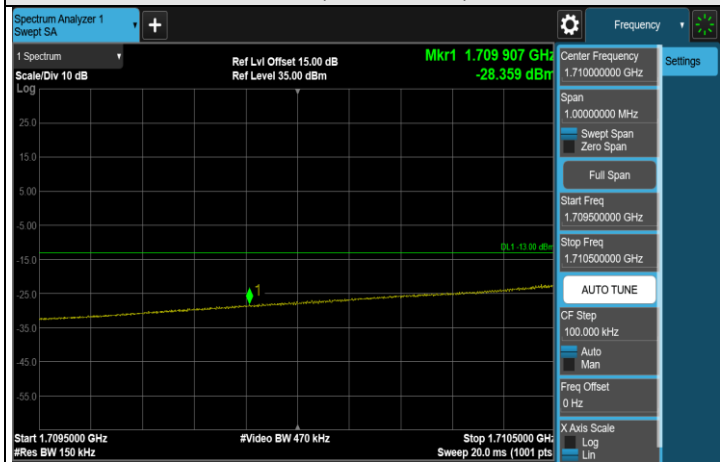

FULL (1717.5MHz)

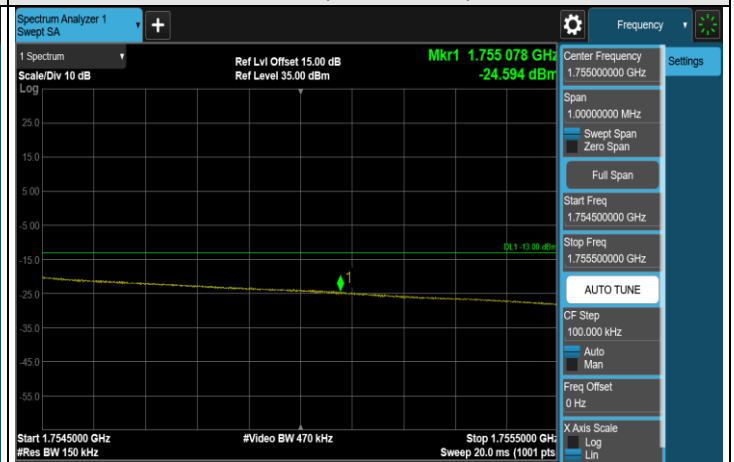

FULL (1747.5MHz)