



FCC RF Test Report

Applicant : Honeywell International Inc.
EQUIPMENT : 99EX Mobile computer
Brand Name : Honeywell
MODEL NAME : 99EX
FCC ID : HD599EXLG
STANDARD : FCC 47 CFR Part 2, 22(H), 24(E), 27(L)
CLASSIFICATION : PCS Licensed Transmitter (PCB)
Tx/Rx FREQUENCY Range : GSM850 : 824.2 ~ 848.8 MHz /
869.2 ~ 893.8 MHz
GSM1900 : 1850.2 ~ 1909.8 MHz /
1930.2 ~ 1989.8 MHz
WCDMA Band V : 826.4 ~ 846.6 MHz /
871.4 ~ 891.6 MHz
WCDMA Band IV : 1712.4 MHz ~ 1752.6 MHz
2112.4 MHz ~ 2152.6 MHz
WCDMA Band II : 1852.4 ~ 1907.6 MHz /
1932.4 ~ 1987.6 MHz
CDMA2000 BC0 : 824.70 ~ 848.31 MHz /
869.70 ~ 893.31 MHz
CDMA2000 BC1 : 1851.25 ~ 1908.75 MHz /
1931.25 ~ 1988.75 MHz
MAX. ERP/EIRP POWER : GSM850 (GPRS 8) : 1.34 W
GSM850 (EDGE 8) : 0.68 W
GSM1900 (GPRS 8) : 0.57 W
GSM1900 (EDGE 8) : 0.46 W
WCDMA Band V (RMC 12.2Kbps) : 0.23 W
WCDMA Band IV (RMC 12.2Kbps) : 0.11 W
WCDMA Band II (RMC 12.2Kbps) : 0.21 W
CDMA2000 BC0 (1xEV-DO Rev. A) : 0.46 W
CDMA2000 BC1 (1xRTT) : 0.36 W
EMISSION DESIGNATOR : GMSK : 244KGXW
8PSK : 248KG7W
QPSK (WCDMA) : 4M16F9W
QPSK (CDMA2000) : 1M28F9W



The product was received on Dec. 06, 2010 and completely tested on Feb. 01, 2011. We, SPORTON INTERNATIONAL INC., would like to declare that the tested sample has been evaluated in accordance with the procedures given in ANSI / TIA / EIA-603-C-2004 and shown compliance with the applicable technical standards.

The test results in this report apply exclusively to the tested model / sample. Without written approval of SPORTON INTERNATIONAL INC., the test report shall not be reproduced except in full.

Reviewed by:

Anderson Chiu

Anderson Chiu / Deputy Manager



SPORTON INTERNATIONAL INC.

No. 52, Hwa Ya 1st Rd., Hwa Ya Technology Park, Kwei-Shan Hsiang, Tao Yuan Hsien, Taiwan, R.O.C.



TABLE OF CONTENTS

REVISION HISTORY..... 4

SUMMARY OF TEST RESULT 5

1 GENERAL DESCRIPTION 6

 1.1 Applicant..... 6

 1.2 Manufacturer 6

 1.3 Feature of Equipment Under Test..... 7

 1.4 Testing Site..... 8

 1.5 Applied Standards 8

 1.6 Ancillary Equipment List..... 8

2 TEST CONFIGURATION OF EQUIPMENT UNDER TEST 9

 2.1 Test Mode..... 9

 2.2 Connection Diagram of Test System 11

3 TEST RESULT..... 12

 3.1 Conducted Output Power Measurement..... 12

 3.2 Effective Radiated Power and Effective Isotropic Radiated Power Measurement 15

 3.3 Occupied Bandwidth Measurement 22

 3.4 Band Edge Measurement..... 41

 3.5 Conducted Emission Measurement 60

 3.6 Field Strength of Spurious Radiation Measurement 84

 3.7 Frequency Stability Measurement..... 104

4 LIST OF MEASURING EQUIPMENT 111

5 UNCERTAINTY OF EVALUATION 112

APPENDIX A. PHOTOGRAPHS OF EUT

APPENDIX B. SETUP PHOTOGRAPHS



REVISION HISTORY

REPORT NO.	VERSION	DESCRIPTION	ISSUED DATE
FG0D0904-05A	Rev. 01	Initial issue of report	Mar. 04, 2011



SUMMARY OF TEST RESULT

Report Section	FCC Rule	IC Rule	Description	Limit	Result	Remark
3.1	§2.1046	N/A	Conducted Output Power	N/A	PASS	-
3.2	§22.913(a)(2)	RSS-132(4.4) SRSP-503(5.1.3)	Effective Radiated Power	< 7 Watts	PASS	-
3.2	§24.232(c)	RSS-133 (6.4) SRSP-510(5.1.2)	Equivalent Isotropic Radiated Power	< 2 Watts	PASS	-
3.3	§2.1049 §22.917(a) §24.238(a)	N/A	Occupied Bandwidth	N/A	PASS	-
3.4	§2.1051 §22.917(a) §24.238(a)	RSS-132 (4.5.1) RSS-133 (6.5.1)	Band Edge Measurement	< 43+10log ₁₀ (P[Watts])	PASS	-
3.5	§2.1051 §22.917(a) §24.238(a)	RSS-132 (4.5.1) RSS-133 (6.5.1)	Conducted Emission	< 43+10log ₁₀ (P[Watts])	PASS	-
3.6	§2.1053 §22.917(a) §24.238(a)	RSS-132 (4.5.1) RSS-133 (6.5.1)	Field Strength of Spurious Radiation	< 43+10log ₁₀ (P[Watts])	PASS	Under limit 12.89 dB at 3760.00 MHz
3.7	§2.1055 §22.355 §24.235	RSS-132(4.3) RSS-133(6.3)	Frequency Stability for Temperature & Voltage	< 2.5 ppm	PASS	-



1 General Description

1.1 Applicant

Honeywell International Inc.
9680 Old Bailes Road, Fort Mill, SC 29707 USA

1.2 Manufacturer

Honeywell International Inc.
9680 Old Bailes Road, Fort Mill, SC 29707 USA

1.3 Feature of Equipment Under Test

Product Feature & Specification	
Equipment	99EX Mobile computer
Brand Name	Honeywell
Model Name	99EX
FCC ID	HD599EXLG
Tx Frequency	GSM850 : 824 MHz ~ 849 MHz GSM1900 : 1850 MHz ~ 1910 MHz WCDMA Band V : 824 MHz ~ 849 MHz WCDMA Band IV : 1710 MHz ~ 1755 MHz WCDMA Band II : 1850 MHz ~ 1910 MHz CDMA2000 BC0 : 824 MHz ~ 849 MHz CDMA2000 BC1 : 1850 MHz ~1910 MHz
Rx Frequency	GSM850 : 869 MHz ~ 894 MHz GSM1900 : 1930 MHz ~ 1990 MHz WCDMA Band V : 869 MHz ~ 894 MHz WCDMA Band IV : 2110 MHz ~ 2155 MHz WCDMA Band II : 1930 MHz ~ 1990 MHz CDMA2000 BC0 : 869 MHz ~ 894 MHz CDMA2000 BC1 : 1930 MHz ~ 1990 MHz
Maximum Output Power to Antenna	GSM850 : 32.02 dBm GSM1900 : 29.41 dBm WCDMA Band V : 23.35 dBm WCDMA Band IV : 23.71 dBm WCDMA Band II : 23.68 dBm CDMA2000 BC0 : 23.95 dBm CDMA2000 BC1 : 23.98 dBm
Maximum ERP/EIRP	GSM850 (GPRS 8) : 1.34 W (31.26 dBm) GSM850 (EDGE 8) : 0.68 W (28.35 dBm) GSM1900 (GPRS 8) : 0.57 W (27.59 dBm) GSM1900 (EDGE 8) : 0.46 W (26.62 dBm) WCDMA Band V (RMC 12.2Kbps) : 0.23 W (23.71 dBm) WCDMA Band IV (RMC 12.2Kbps) : 0.11 W (20.24 dBm) WCDMA Band II (RMC 12.2Kbps) : 0.21 W (23.31 dBm) CDMA2000 BC0 (1xEV-DO Rev. A) : 0.46 W (26.64 dBm) CDMA2000 BC1 (1xRTT) : 0.36 W (25.56 dBm)
Antenna Type	Fixed Internal Antenna
HW Version	5
SW Version	26.02
Type of Modulation	GSM / GPRS : GMSK EDGE : 8PSK WCDMA : QPSK HSDPA : QPSK / 16QAM HSUPA : BPSK CDMA2000 : QPSK
Type of Emission	GMSK : 244KGXW 8PSK : 248KG7W QPSK (WCDMA): 4M16F9W QPSK (CDMA2000) : 1M28F9W
EUT Stage	Production Unit

Remark:

1. For other wireless features of this EUT, the test report will be issued separately.
2. This test report recorded only product characteristics and test results of PCS Licensed Transmitter (PCB).
3. The above EUT's information was declared by manufacturer. Please refer to the specifications or user's manual for more detailed description.

1.4 Testing Site

Test Site	SPORTON INTERNATIONAL INC.		
Test Site Location	No. 52, Hwa Ya 1 st Rd., Hwa Ya Technology Park, Kwei-Shan Hsiang, Tao Yuan Hsien, Taiwan, R.O.C. TEL: +886-3-327-3456 FAX: +886-3-328-4978		
Test Site No.	Sporton Site No.		FCC/IC Registration No.
	TH02-HY	03CH07-HY	722060/4086B-1

1.5 Applied Standards

According to the specifications of the manufacturer, the EUT must comply with the requirements of the following standards:

- ♦ Preliminary Guidance for Receiving Applications for Certification of 3G Device. May 9, 2006.
- ♦ FCC 47 CFR Part 2, 22(H), 24(E), 27(L)
- ♦ ANSI / TIA / EIA-603-C-2004
- ♦ IC RSS-132 Issue 2
- ♦ IC RSS-133 Issue 5
- ♦ IC RSS-139 Issue 2

Remark:

1. All test items were verified and recorded according to the standards and without any deviation during the test.
2. This EUT has also been tested and complied with the requirements of FCC Part 15, Subpart B (DoC), recorded in a separate test report.

1.6 Ancillary Equipment List

Item	Equipment	Trade Name	Model No.	FCC ID	Data Cable	Power Cord
1.	System Simulator	R&S	CMU200	N/A	N/A	Unshielded, 1.8 m
2.	Cradle	Honeywell	99EX-HB	N/A	N/A	N/A
3.	Adapter	ENG	3A-902DB12	N/A	N/A	N/A
4.	USB Cable	N/A	N/A	N/A	N/A	N/A

2 Test Configuration of Equipment Under Test

2.1 Test Mode

During all testing, EUT is in link mode with base station emulator at maximum power level. The spurious emission measurements were carried out in semi-anechoic chamber with 3-meter test range.

Frequency range investigated for radiated emission is as follows:

1. 30 MHz to 9000 MHz for GSM850, WCDMA Band V, and CDMA2000 BC0.
2. 30 MHz to 18000 MHz for WCDMA Band IV.
3. 30 MHz to 19000 MHz for GSM1900, WCDMA Band II, and CDMA2000 BC1.

Test Modes		
Band	Radiated TCs	Conducted TCs
GSM 850	<ul style="list-style-type: none"> ■ GPRS 8 Link ■ EDGE 8 Link 	<ul style="list-style-type: none"> ■ GPRS 8 Link ■ EDGE 8 Link
GSM 1900	<ul style="list-style-type: none"> ■ GPRS 8 Link ■ EDGE 8 Link 	<ul style="list-style-type: none"> ■ GPRS 8 Link ■ EDGE 8 Link
WCDMA Band V	<ul style="list-style-type: none"> ■ RMC 12.2Kbps Link 	<ul style="list-style-type: none"> ■ RMC 12.2Kbps Link
WCDMA Band IV	<ul style="list-style-type: none"> ■ RMC 12.2Kbps Link 	<ul style="list-style-type: none"> ■ RMC 12.2Kbps Link
WCDMA Band II	<ul style="list-style-type: none"> ■ RMC 12.2Kbps Link 	<ul style="list-style-type: none"> ■ RMC 12.2Kbps Link
CDMA2000 BC0	<ul style="list-style-type: none"> ■ 1xEV-DO Rev. A Link Mode 	<ul style="list-style-type: none"> ■ 1xEV-DO Rev. A Link Mode
CDMA2000 BC1	<ul style="list-style-type: none"> ■ 1xRTT Link Mode 	<ul style="list-style-type: none"> ■ 1xRTT Link Mode

Note:

1. The maximum power levels are GPRS multi-slot class 8 mode for GMSK link, EDGE multi-slot class 8 mode for 8PSK link, RMC 12.2Kbps mode for WCDMA band V, WCDMA band IV and WCDMA band II, 1xEV-DO Rev. A RETAP 4096K mode for CDMA2000 BC0 Link, and 1xRTT RC3+SO55 mode for CDMA2000 BC1 Link, only these modes were used for all tests.
2. Because there are individual antennas for each WWAN, WLAN, and Bluetooth, the co-location test modes are not required

The conducted power tables are as follows:

Conducted Power (*Unit: dBm)						
Band	GSM850			GSM1900		
Channel	128	189	251	512	661	810
Frequency	824.2	836.4	848.8	1850.2	1880.0	1909.8
GPRS 8	32.02	32.00	31.83	29.39	29.34	29.41
GPRS 10	31.81	31.75	31.60	29.32	29.24	29.31
EGPRS 8	25.94	25.88	25.89	26.44	26.34	26.36
EGPRS 10	25.80	25.72	25.71	26.25	26.22	26.18

Conducted Power (*Unit: dBm)									
Band	WCDMA Band V			WCDMA Band II			WCDMA Band IV		
Channel	4132	4182	4233	9262	9400	9538	1312	1413	1513
Frequency	826.4	836.4	846.6	1852.4	1880.0	1907.6	1712.4	1732.6	1752.6
RMC 12.2K	23.30	23.35	23.34	23.68	23.58	23.48	23.71	23.68	23.59
HSDPA Subtest-1	23.10	23.02	23.11	23.56	23.39	23.42	22.06	22.40	22.81
HSDPA Subtest-2	23.06	23.14	23.20	23.55	23.44	23.28	23.25	23.44	23.35
HSDPA Subtest-3	22.59	22.68	22.74	23.00	22.96	22.78	22.79	22.89	22.87
HSDPA Subtest-4	22.66	22.58	22.65	23.01	22.93	22.85	22.95	23.10	22.81
HSUPA Subtest-1	22.80	23.04	22.67	23.05	22.97	23.15	23.36	23.10	23.26
HSUPA Subtest-2	21.41	21.73	21.66	21.77	21.73	21.69	21.66	21.40	21.96
HSUPA Subtest-3	21.65	22.02	21.75	22.28	21.99	22.12	22.19	21.95	22.20
HSUPA Subtest-4	21.92	22.08	22.20	22.14	22.08	22.32	22.37	22.15	22.57
HSUPA Subtest-5	22.79	23.08	22.98	22.90	22.91	23.13	22.92	22.92	22.82

Conducted Power (*Unit: dBm)						
Band	CDMA2000 BC0			CDMA2000 BC1		
Channel	1013	384	777	25	600	1175
Frequency	824.7	836.52	848.31	1851.25	1880	1908.75
1xRTT FCH_RC1+SO55	23.75	23.92	23.79	23.97	23.83	23.67
1xRTT FCH_RC3+SO55	23.76	23.85	23.75	23.98	23.85	23.65
1xRTT FCH-SCH_RC3+SO32	23.74	23.73	23.73	23.93	23.83	23.64
1xRTT FCH+SCH_RC3+SO32	23.75	23.78	23.72	23.96	23.84	23.63
1xEV-DO RTAP 153.6K	23.73	23.80	23.76	23.95	23.89	23.66
1xEVDO RETAP 4096K	23.79	23.95	23.82	23.96	23.95	23.78

2.2 Connection Diagram of Test System

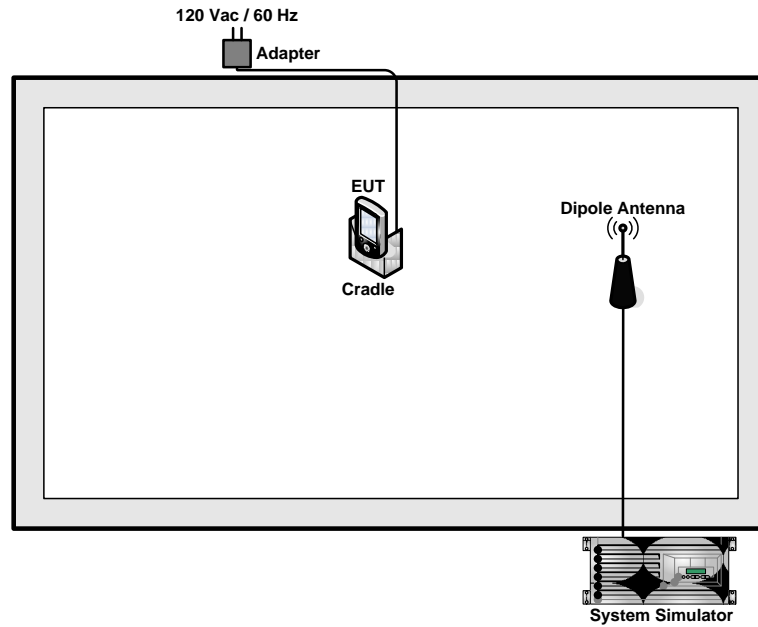

3 Test Result

3.1 Conducted Output Power Measurement

3.1.1 Description of the Conducted Output Power Measurement

A base station simulator was used to establish communication with the EUT. Its parameters were set to transmit the maximum power on the EUT. The measured power in the radio frequency on the transmitter output terminals shall be reported.

3.1.2 Measuring Instruments

See list of measuring instruments of this test report.

3.1.3 Test Procedures

1. The transmitter output port was connected to base station.
2. Set EUT at maximum power through base station.
3. Select lowest, middle, and highest channels for each band and different modulation.

3.1.4 Test Setup

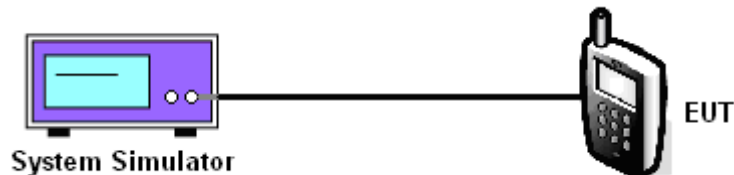



3.1.5 Test Result of Conducted Output Power

Cellular Band				
Modes	Channel	Frequency (MHz)	Conducted Power (dBm)	Conducted Power (Watts)
GSM850 (GPRS 8)	128 (Low)	824.2	32.02	1.59
	189 (Mid)	836.4	32.00	1.58
	251 (High)	848.8	31.83	1.52
GSM850 (EDGE 8)	128 (Low)	824.2	25.94	0.39
	189 (Mid)	836.4	25.88	0.39
	251 (High)	848.8	25.89	0.39
WCDMA Band V (RMC 12.2Kbps)	4132 (Low)	826.4	23.30	0.21
	4182 (Mid)	836.4	23.35	0.22
	4233 (High)	846.6	23.34	0.22
CDMA2000 BC0 (1xEV-DO Rev. A RETAP 4096K)	1013 (Low)	824.70	23.79	0.24
	384 (Mid)	836.52	23.95	0.25
	777 (High)	848.31	23.82	0.24

PCS Band				
Modes	Channel	Frequency (MHz)	Conducted Power (dBm)	Conducted Power (Watts)
GSM1900 (GPRS 8)	512 (Low)	1850.2	29.39	0.87
	661 (Mid)	1880.0	29.34	0.86
	810 (High)	1909.8	29.41	0.87
GSM1900 (EDGE 8)	512 (Low)	1850.2	26.44	0.44
	661 (Mid)	1880.0	26.34	0.43
	810 (High)	1909.8	26.36	0.43
WCDMA Band II (RMC 12.2Kbps)	9262 (Low)	1852.4	23.68	0.23
	9400 (Mid)	1880.0	23.58	0.23
	9538 (High)	1907.6	23.48	0.22
CDMA2000 BC1 (1xRTT RC3+SO55)	25 (Low)	1851.25	23.98	0.25
	600 (Mid)	1880.00	23.85	0.24
	1175 (High)	1908.75	23.65	0.23



AWS Band				
Modes	Channel	Frequency (MHz)	Conducted Power (dBm)	Conducted Power (Watts)
WCDMA Band IV (RMC 12.2Kbps)	1312 (Low)	1712.4	23.71	0.23
	1413 (Mid)	1732.6	23.68	0.23
	1513 (High)	1752.6	23.59	0.23



3.2 Effective Radiated Power and Effective Isotropic Radiated Power Measurement

3.2.1 Description of the ERP/EIRP Measurement

ERP/EIRP is measured by substitution method according to ANSI / TIA / EIA-603-C-2004. The ERP of mobile transmitters must not exceed 7 Watts and the EIRP of mobile transmitters are limited to 2 Watts.

3.2.2 Measuring Instruments

See list of measuring instruments of this test report.

3.2.3 Test Procedures

1. The EUT was placed on an non-conductive rotating platform with 0.8 meter height in a semi-anechoic chamber. The radiated emission at the fundamental frequency was measured at 3 m with a test antenna and a spectrum analyzer with RBW= 3MHz,VBW= 3MHz, and peak detector settings.
2. During the measurement, the EUT was enforced in maximum power and linked with a base station. The highest emission was recorded from analyzer power level (LVL) from the 360 degrees rotation of the turntable and the test antenna raised and lowered over a range from 1 to 4 meters in both horizontally and vertically polarized orientations.
3. Effective Isotropic Radiated Power (EIRP) was measured by substitution method according to TIA/EIA-603-C. The EUT was replaced by dipole antenna (substitution antenna) at same location, and then a known power from S.G. was applied into the dipole antenna through a Tx cable, and then recorded the maximum Analyzer reading through raised and lowered the test antenna. The correction factor (in dB) = S.G. - Tx Cable loss + Substitution antenna gain - Analyzer reading. Then the EUT's EIRP was calculated with the correction factor, $EIRP = LVL + \text{Correction factor}$ and $ERP = EIRP - 2.15$.

3.2.4 Test Setup

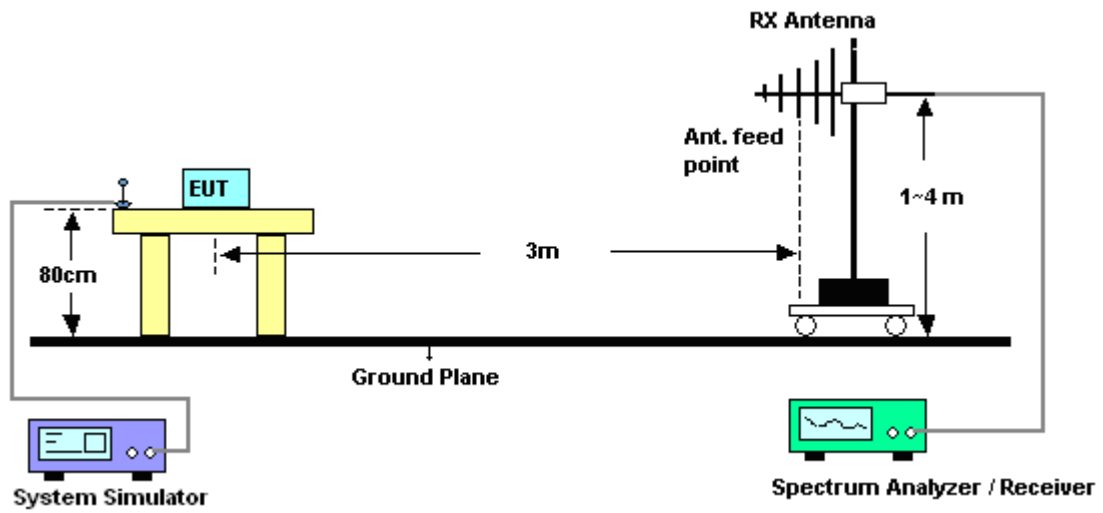

3.2.5 Test Result of ERP

GSM850 (GPRS 8) Radiated Power ERP				
Horizontal Polarization				
Frequency (MHz)	LVL (dBm)	Correction Factor (dB)	ERP (dBm)	ERP (W)
824.2	0.91	31.97	30.73	1.18
836.4	0.81	32.44	31.10	1.29
848.8	0.78	32.63	31.26	1.34
Vertical Polarization				
Frequency (MHz)	LVL (dBm)	Correction Factor (dB)	ERP (dBm)	ERP (W)
824.2	-7.93	35.39	25.31	0.34
836.4	-6.89	35.2	26.16	0.41
848.8	-6.42	35.69	27.12	0.52

* ERP = LVL (dBm) + Correction Factor (dB) – 2.15

GSM850 (EDGE 8) Radiated Power ERP				
Horizontal Polarization				
Frequency (MHz)	LVL (dBm)	Correction Factor (dB)	ERP (dBm)	ERP (W)
824.2	-2.62	31.97	27.20	0.52
836.4	-2.60	32.44	27.69	0.59
848.8	-2.13	32.63	28.35	0.68
Vertical Polarization				
Frequency (MHz)	LVL (dBm)	Correction Factor (dB)	ERP (dBm)	ERP (W)
824.2	-9.85	35.39	23.39	0.22
836.4	-9.39	35.2	23.66	0.23
848.8	-8.54	35.69	25.00	0.32

* ERP = LVL (dBm) + Correction Factor (dB) – 2.15



WCDMA Band V (RMC 12.2Kbps) Radiated Power ERP				
Horizontal Polarization				
Frequency (MHz)	LVL (dBm)	Correction Factor (dB)	ERP (dBm)	ERP (W)
826.40	-7.22	31.97	22.60	0.18
836.40	-6.58	32.44	23.71	0.23
846.60	-6.87	32.63	23.61	0.23
Vertical Polarization				
Frequency (MHz)	LVL (dBm)	Correction Factor (dB)	ERP (dBm)	ERP (W)
826.40	-17.45	35.39	15.79	0.04
836.40	-16.26	35.2	16.79	0.05
846.60	-16.87	35.69	16.67	0.05

* ERP = LVL (dBm) + Correction Factor (dB) – 2.15

CDMA2000 BC0 1xEV-DO Rev. A RETAP 4096K Radiated Power ERP				
Horizontal Polarization				
Frequency (MHz)	LVL (dBm)	Correction Factor (dB)	ERP (dBm)	ERP (W)
824.70	-3.47	31.97	26.35	0.43
836.52	-3.65	32.44	26.64	0.46
848.31	-3.95	32.63	26.53	0.45
Vertical Polarization				
Frequency (MHz)	LVL (dBm)	Correction Factor (dB)	ERP (dBm)	ERP (W)
824.70	-13.46	35.39	19.78	0.10
836.52	-12.71	35.2	20.34	0.11
848.31	-13.36	35.69	20.18	0.10

* ERP = LVL (dBm) + Correction Factor (dB) – 2.15

3.2.6 Test Result of EIRP

GSM1900 (GPRS 8) Radiated Power EIRP				
Horizontal Polarization				
Frequency (MHz)	LVL (dBm)	Correction Factor (dB)	EIRP (dBm)	EIRP (W)
1850.2	-13.76	41.24	27.48	0.56
1880.0	-13.87	41.46	27.59	0.57
1909.8	-14.48	41.21	26.73	0.47
Vertical Polarization				
Frequency (MHz)	LVL (dBm)	Correction Factor (dB)	EIRP (dBm)	EIRP (W)
1850.2	-16.95	41.52	24.57	0.29
1880.0	-16.12	43.10	26.98	0.50
1909.8	-16.11	42.73	26.62	0.46

* EIRP = LVL (dBm) + Correction Factor (dB)

GSM1900 (EDGE 8) Radiated Power EIRP				
Horizontal Polarization				
Frequency (MHz)	LVL (dBm)	Correction Factor (dB)	EIRP (dBm)	EIRP (W)
1850.2	-14.62	41.24	26.62	0.46
1880.0	-15.30	41.46	26.16	0.41
1909.8	-15.71	41.21	25.50	0.35
Vertical Polarization				
Frequency (MHz)	LVL (dBm)	Correction Factor (dB)	EIRP (dBm)	EIRP (W)
1850.2	-18.06	41.52	23.46	0.22
1880.0	-18.48	43.10	24.62	0.29
1909.8	-18.05	42.73	24.68	0.29

* EIRP = LVL (dBm) + Correction Factor (dB)



WCDMA Band IV (RMC 12.2Kbps) Radiated Power EIRP				
Horizontal Polarization				
Frequency (MHz)	LVL (dBm)	Correction Factor (dB)	EIRP (dBm)	EIRP (W)
1712.4	-20.80	39.24	18.44	0.07
1732.6	-21.23	40.25	19.02	0.08
1752.6	-22.40	40.31	17.91	0.06
Vertical Polarization				
Frequency (MHz)	LVL (dBm)	Correction Factor (dB)	EIRP (dBm)	EIRP (W)
1712.4	-23.87	44.11	20.24	0.11
1732.6	-24.70	42.66	17.96	0.06
1752.6	-24.03	41.70	17.67	0.06

WCDMA Band II (RMC 12.2Kbps) Radiated Power EIRP				
Horizontal Polarization				
Frequency (MHz)	LVL (dBm)	Correction Factor (dB)	EIRP (dBm)	EIRP (W)
1852.40	-17.93	41.24	23.31	0.21
1880.00	-19.12	41.46	22.34	0.17
1907.60	-20.00	41.21	21.21	0.13
Vertical Polarization				
Frequency (MHz)	LVL (dBm)	Correction Factor (dB)	EIRP (dBm)	EIRP (W)
1852.40	-21.93	41.52	19.59	0.09
1880.00	-22.17	43.10	20.93	0.12
1907.60	-22.61	42.73	20.12	0.10

* EIRP = LVL (dBm) + Correction Factor (dB)



CDMA2000 BC1 1xRTT RC3+SO55				
Radiated Power EIRP				
Horizontal Polarization				
Frequency (MHz)	LVL (dBm)	Correction Factor (dB)	EIRP (dBm)	EIRP (W)
1851.30	-15.68	41.24	25.56	0.36
1880.00	-16.69	41.46	24.77	0.30
1908.80	-16.64	41.21	24.57	0.29
Vertical Polarization				
Frequency (MHz)	LVL (dBm)	Correction Factor (dB)	EIRP (dBm)	EIRP (W)
1851.30	-19.28	41.52	22.24	0.17
1880.00	-19.59	43.10	23.51	0.22
1908.80	-19.34	42.73	23.39	0.22

* EIRP = LVL (dBm) + Correction Factor (dB)

3.3 Occupied Bandwidth Measurement

3.3.1 Description of Occupied Bandwidth Measurement

The emission bandwidth is defined as the width of the signal between two points, located at the 2 sides of the carrier frequency, outside of which all emissions are attenuated at least 26 dB below the transmitter power.

3.3.2 Measuring Instruments

See list of measuring instruments of this test report.

3.3.3 Test Procedures

1. The EUT was connected to Spectrum Analyzer and Base Station via power divider.
2. The 99% and 26 dB occupied bandwidth (BW) of the middle channel for the highest RF powers were measured.

3.3.4 Test Setup

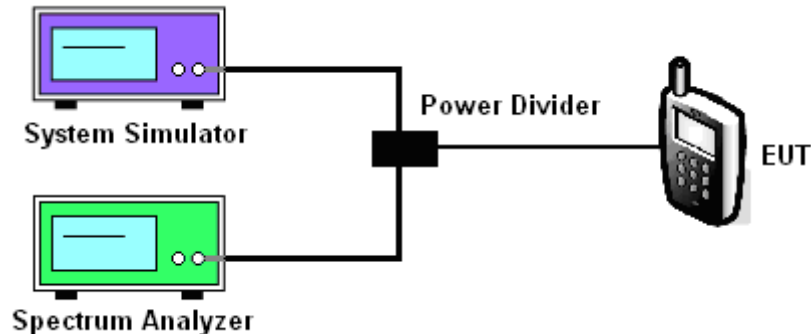



3.3.5 Test Result (Plots) of Occupied Bandwidth

Band :	GSM 850	Power Stage :	High
Test Mode :	GPRS 8 Link		

99% Occupied Bandwidth Plot on Channel 189

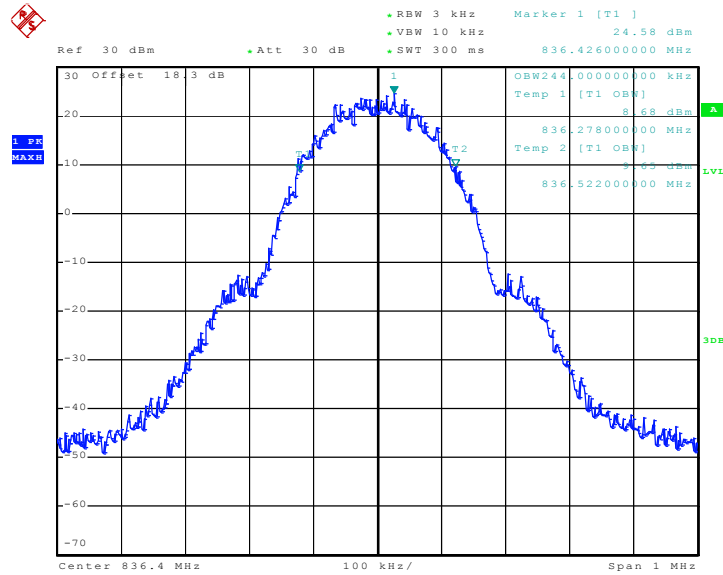

Date: 5.JAN.2011 14:53:31

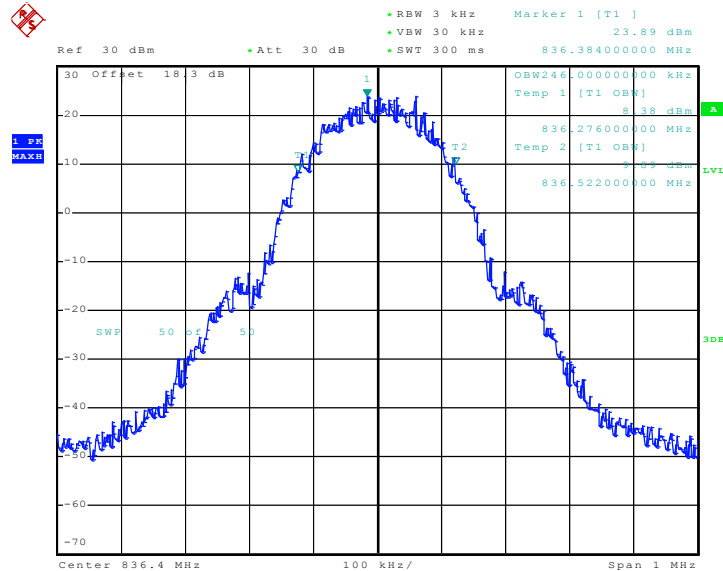

Date: 5.JAN.2011 14:54:47



26dB Bandwidth Plot on Channel 189

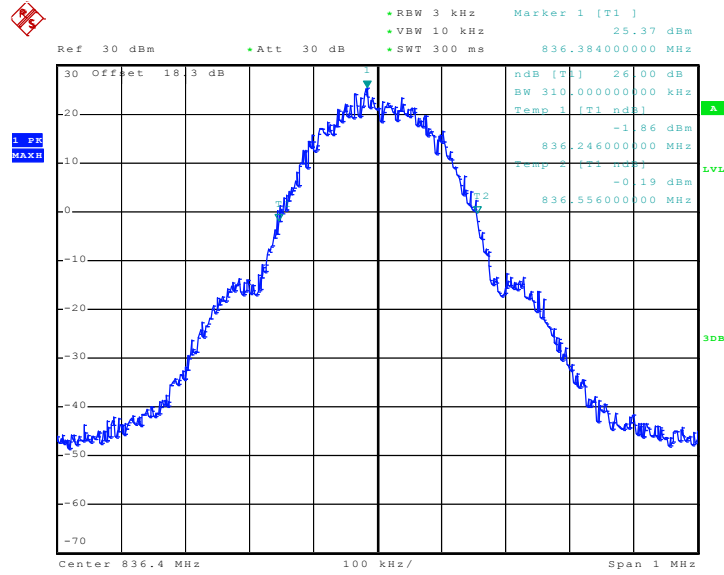

Date: 5.JAN.2011 14:52:11



Band :	GSM 850	Power Stage :	High
Test Mode :	EDGE 8 Link		

99% Occupied Bandwidth Plot on Channel 189

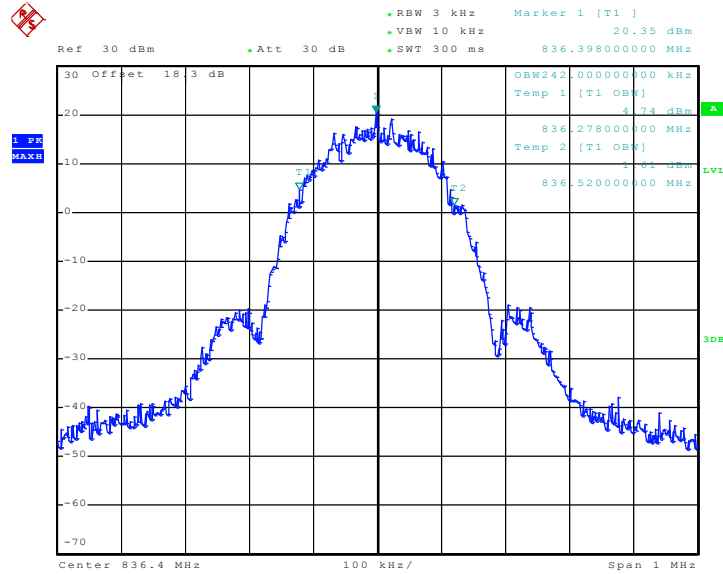

Date: 5.JAN.2011 15:37:15

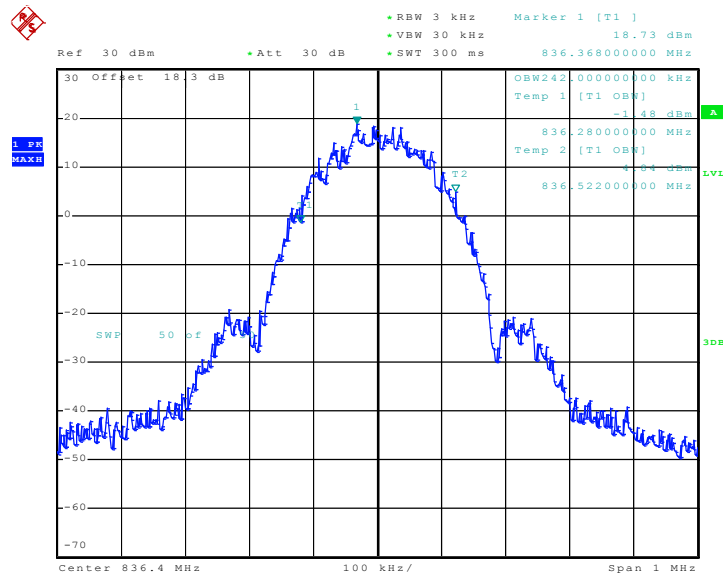

Date: 5.JAN.2011 15:38:28



26dB Bandwidth Plot on Channel 189

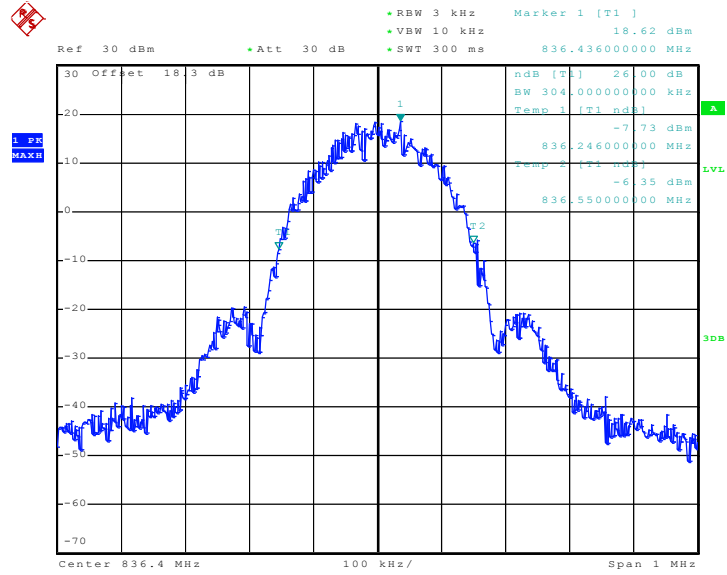

Date: 5.JAN.2011 15:35:56



Band :	GSM 1900	Power Stage :	High
Test Mode :	GPRS 8 Link		

99% Occupied Bandwidth Plot on Channel 661

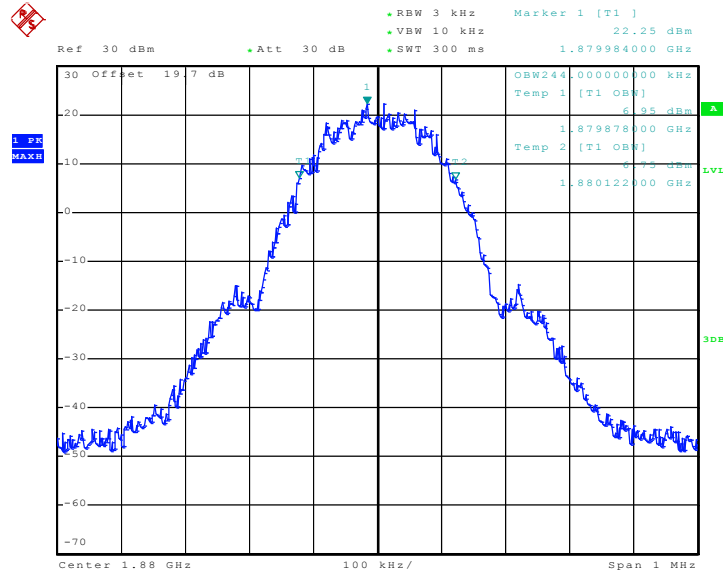

Date: 5.JAN.2011 15:18:43

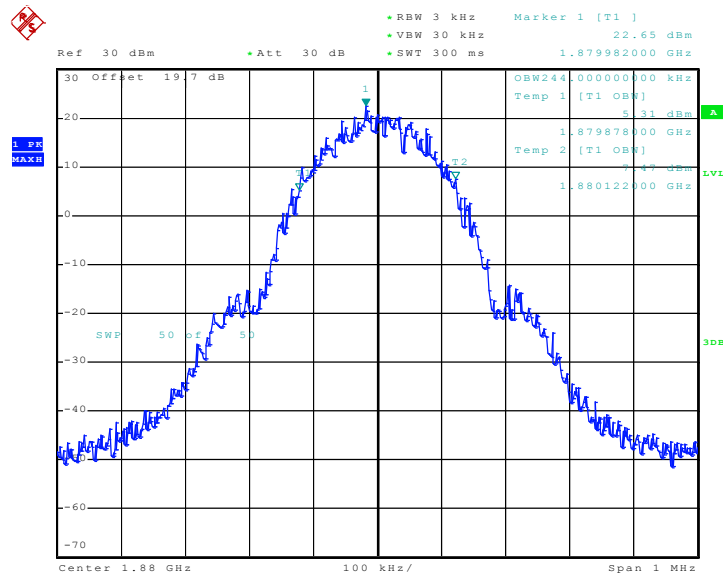

Date: 5.JAN.2011 15:20:10



26dB Bandwidth Plot on Channel 661

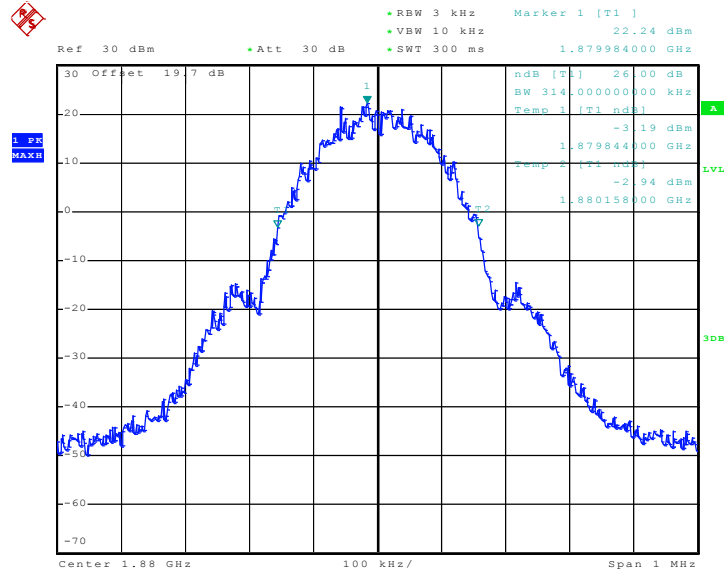

Date: 5.JAN.2011 15:17:23



Band :	GSM 1900	Power Stage :	High
Test Mode :	EDGE 8 Link		

99% Occupied Bandwidth Plot on Channel 661

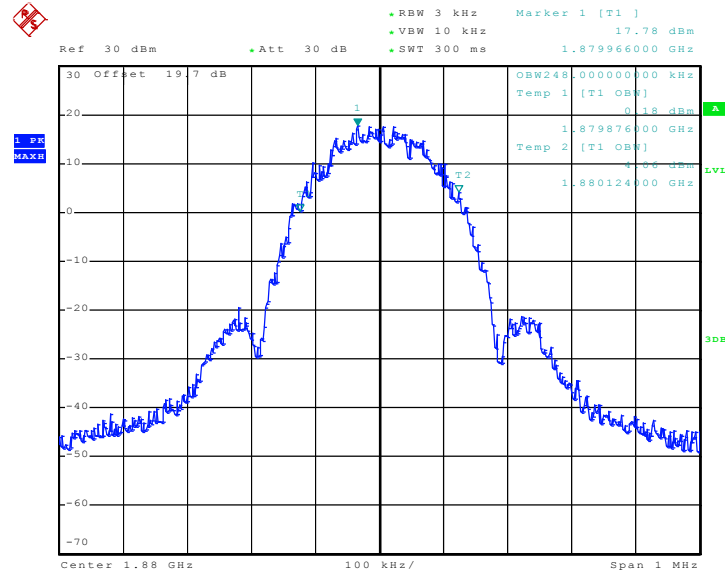

Date: 5.JAN.2011 16:03:19

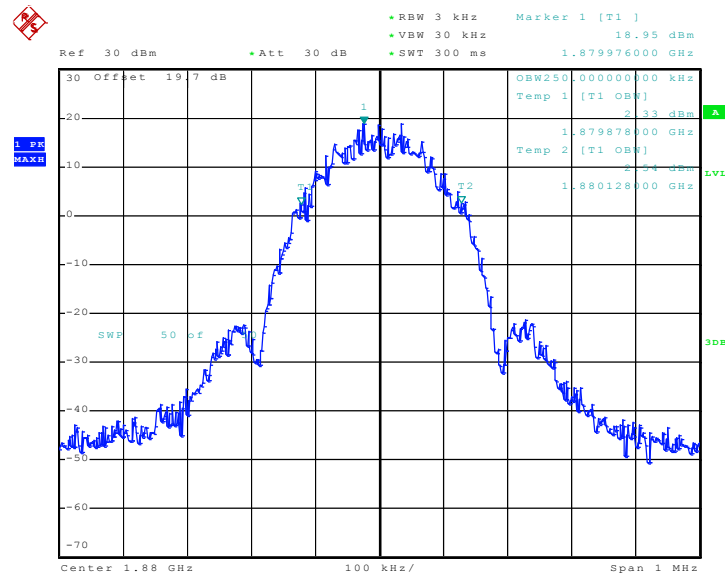

Date: 5.JAN.2011 16:04:31



26dB Bandwidth Plot on Channel 661

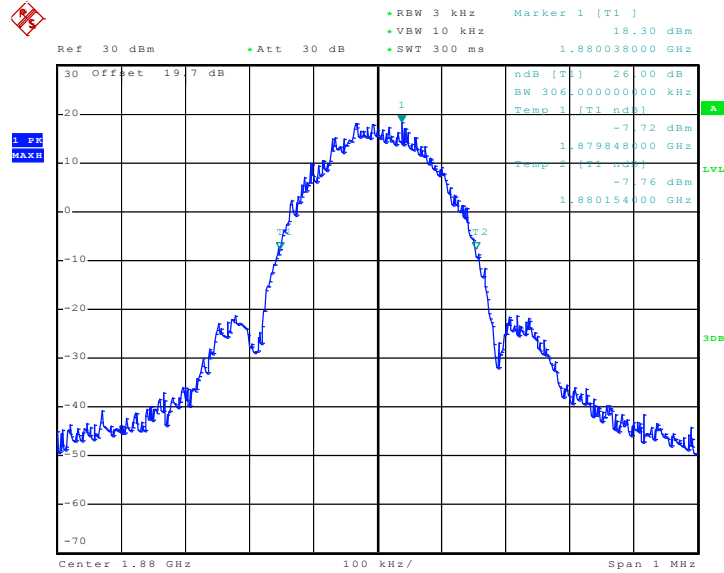

Date: 5.JAN.2011 16:02:00



Band :	WCDMA Band V	Power Stage :	High
Test Mode :	RMC 12.2Kbps Link		

99% Occupied Bandwidth Plot on Channel 4182

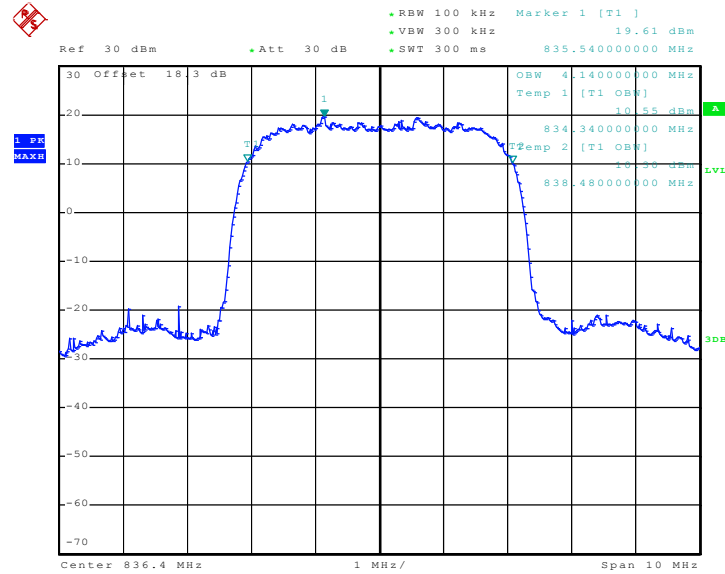

Date: 5.JAN.2011 16:37:19

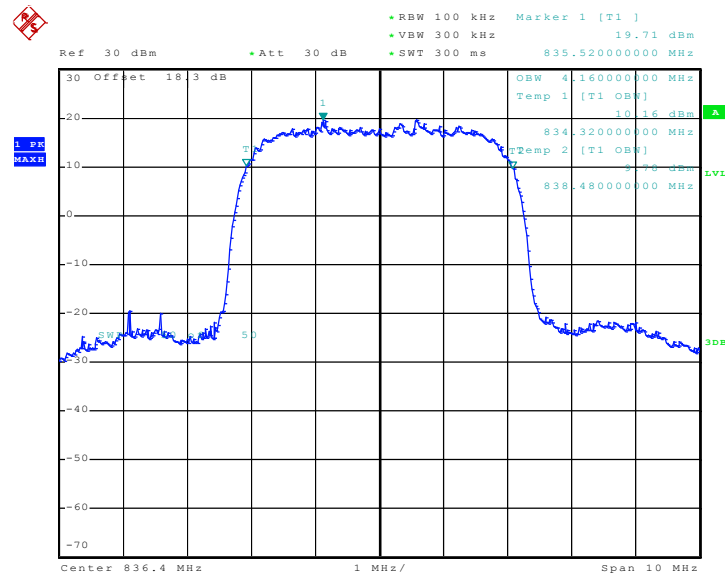

Date: 5.JAN.2011 16:38:56



26dB Bandwidth Plot on Channel 4182

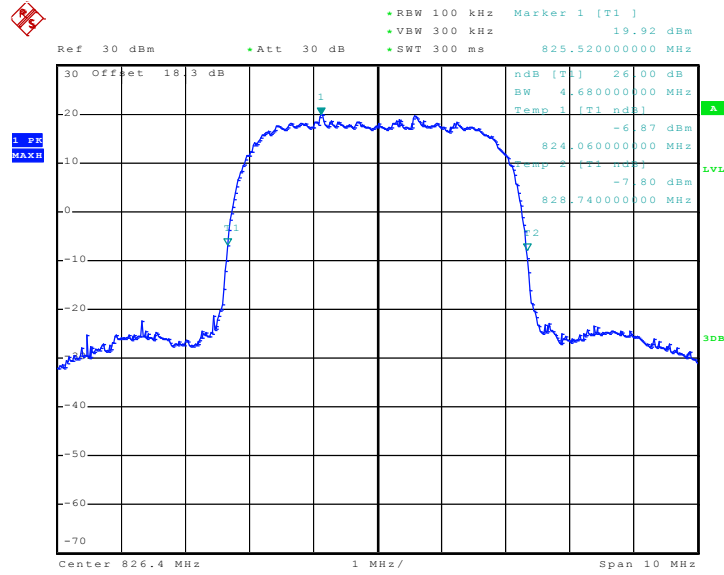

Date: 5.JAN.2011 16:35:34



Band :	WCDMA Band IV	Power Stage :	High
Test Mode :	RMC 12.2Kbps Link		

99% Occupied Bandwidth Plot on Channel 1413

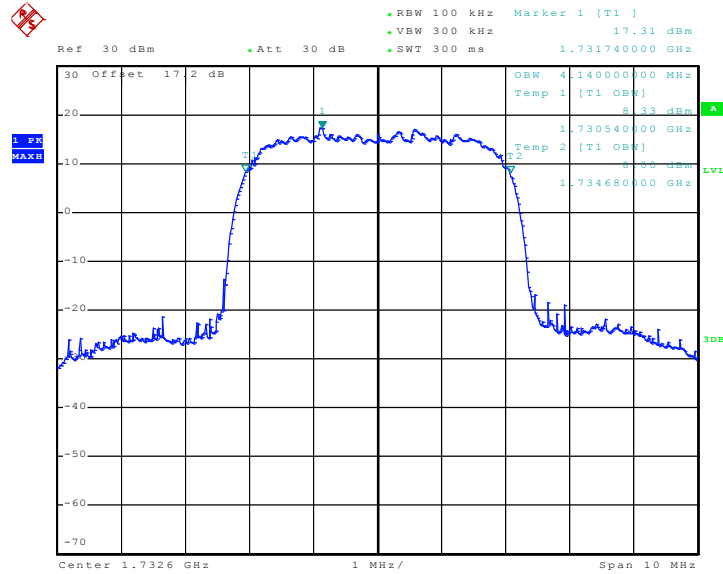

Date: 28.JAN.2011 16:30:55

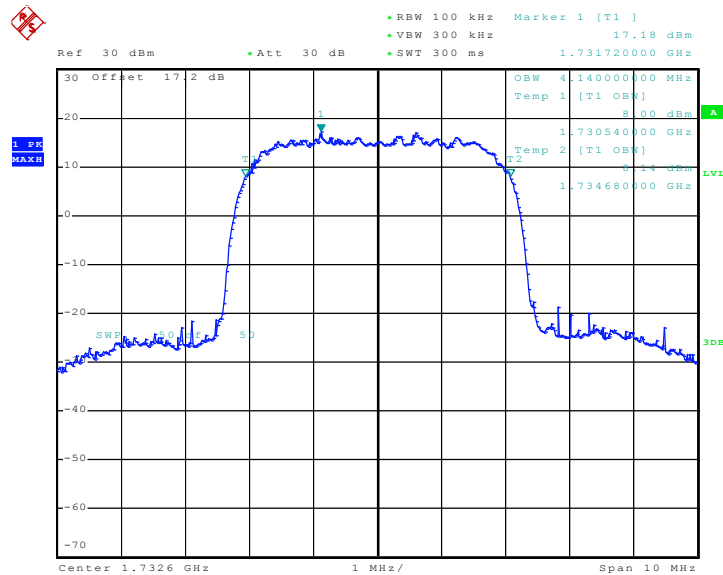

Date: 28.JAN.2011 16:32:02



26dB Bandwidth Plot on Channel 1413

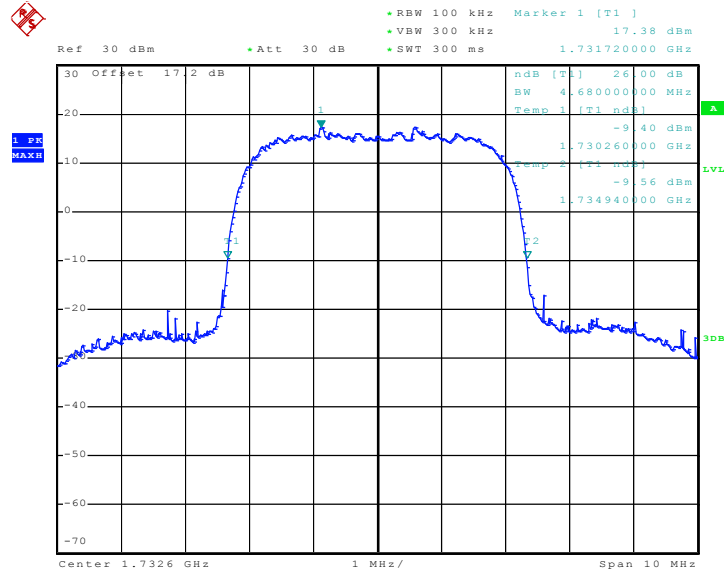

Date: 28.JAN.2011 16:29:35



Band :	WCDMA Band II	Power Stage :	High
Test Mode :	RMC 12.2Kbps Link		

99% Occupied Bandwidth Plot on Channel 9400

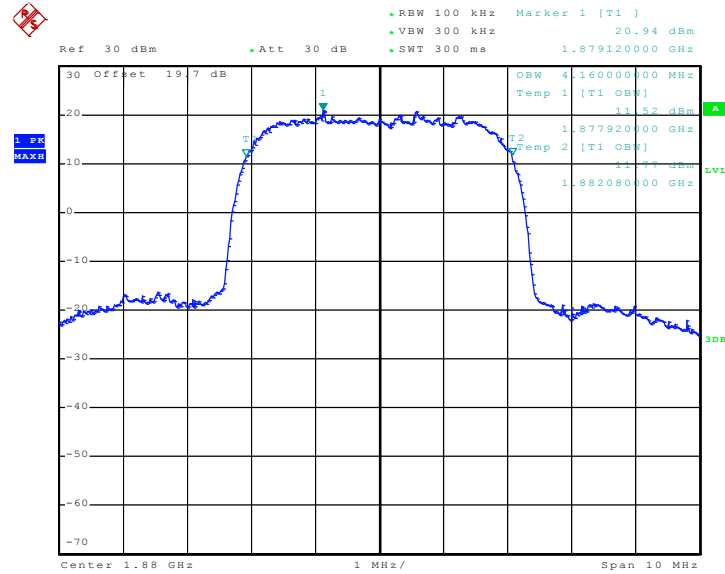

Date: 5.JAN.2011 16:53:05

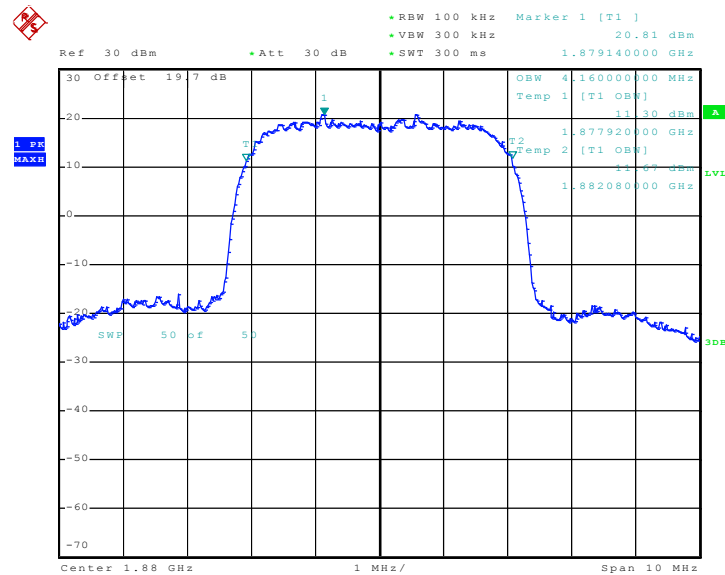

Date: 5.JAN.2011 16:54:40



26dB Bandwidth Plot on Channel 9400

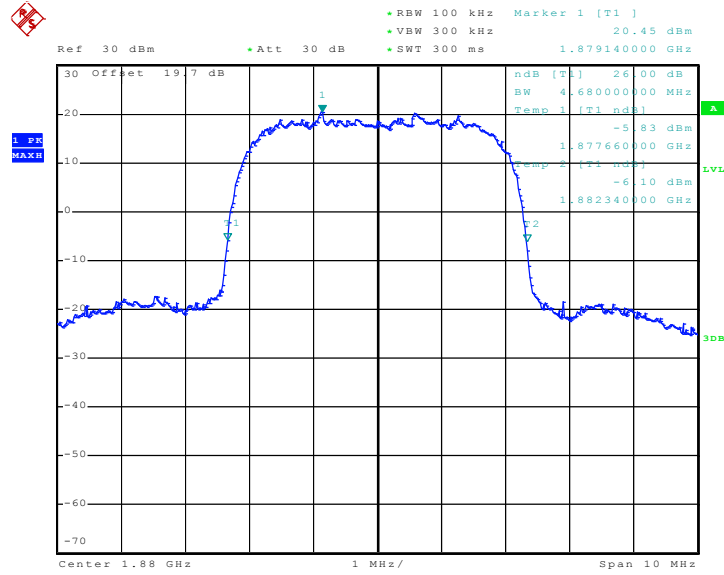

Date: 5.JAN.2011 16:51:46



Band :	CDMA2000 BC0	Power Stage :	High
Test Mode :	1xEV-DO Rev. A_RETAP 4096K		

99% Occupied Bandwidth Plot on Channel 384

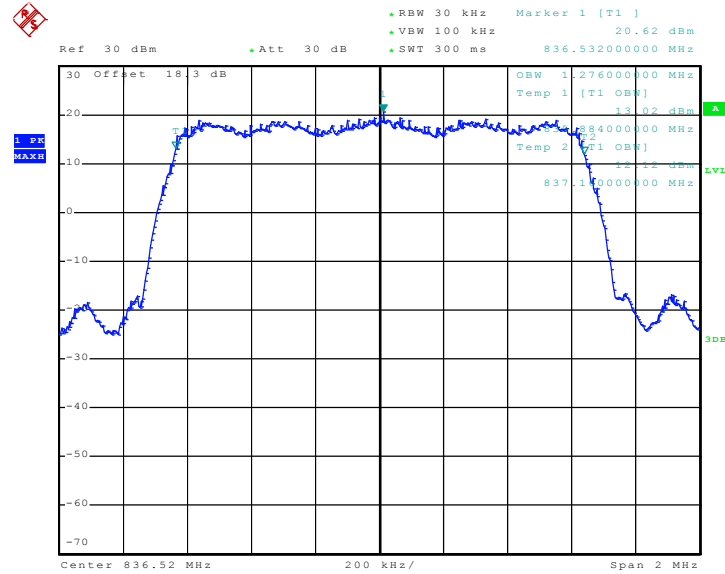

Date: 6.JAN.2011 09:03:27

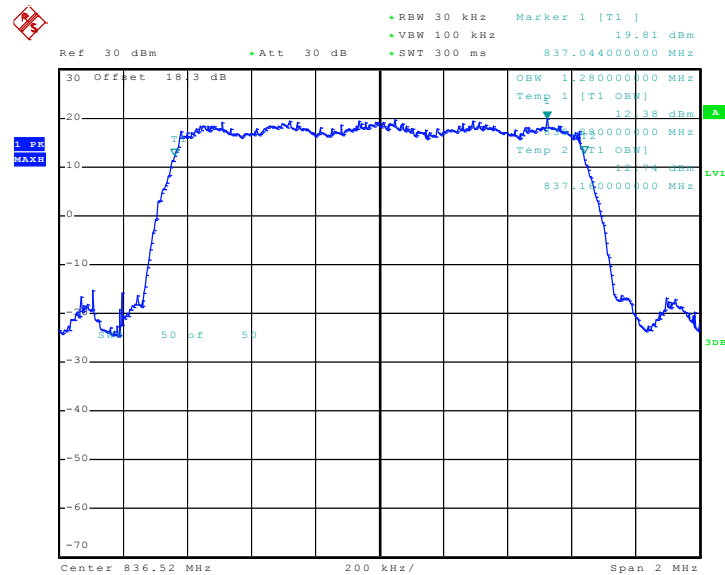

Date: 6.JAN.2011 09:06:07



26dB Bandwidth Plot on Channel 384

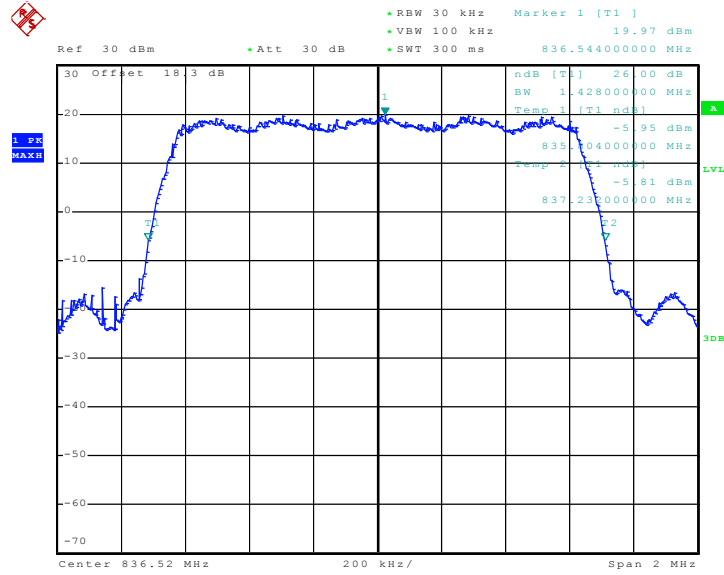

Date: 6.JAN.2011 08:55:39



Band :	CDMA2000 BC1	Power Stage :	High
Test Mode :	1xRTT_RC3+SO55		

99% Occupied Bandwidth Plot on Channel 600

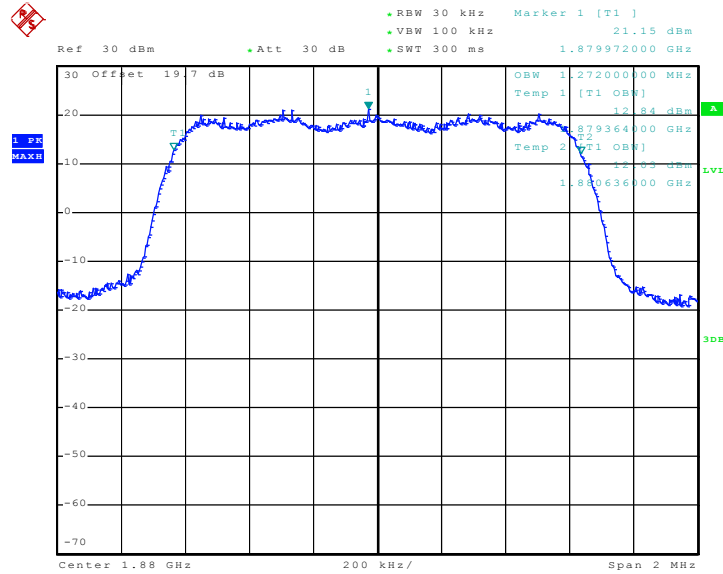

Date: 6.JAN.2011 10:38:20

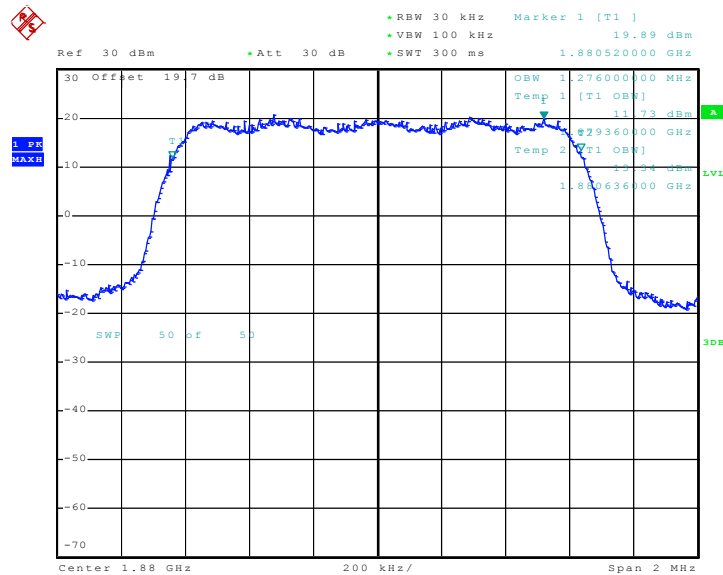

Date: 6.JAN.2011 10:41:55



26dB Bandwidth Plot on Channel 600

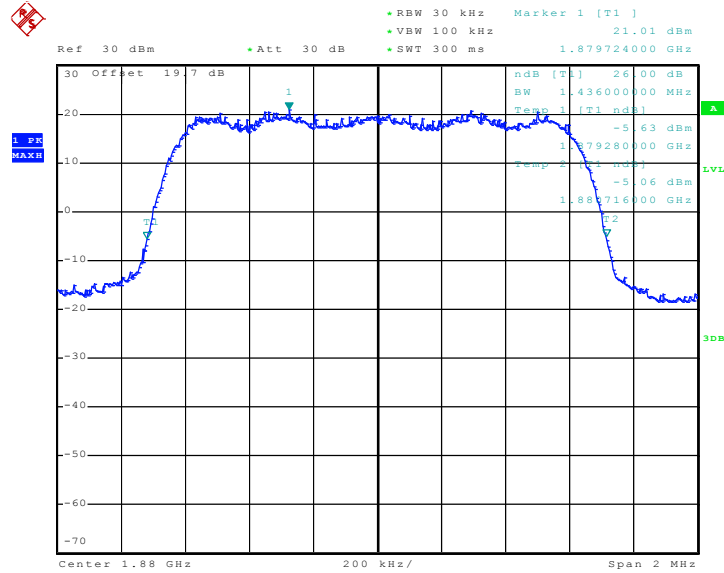

Date: 6.JAN.2011 10:33:52

3.4 Band Edge Measurement

3.4.1 Description of Band Edge Measurement

The power of any emission outside of the authorized operating frequency ranges must be lower than the transmitter power (P) by a factor of at least $43 + 10 \log (P)$ dB.

3.4.2 Measuring Instruments

See list of measuring instruments of this test report.

3.4.3 Test Procedures

1. The EUT was connected to Spectrum Analyzer and Base Station via power divider.
2. The band edges of low and high channels for the highest RF powers were measured. Setting RBW as roughly BW/100.

3.4.4 Test Setup

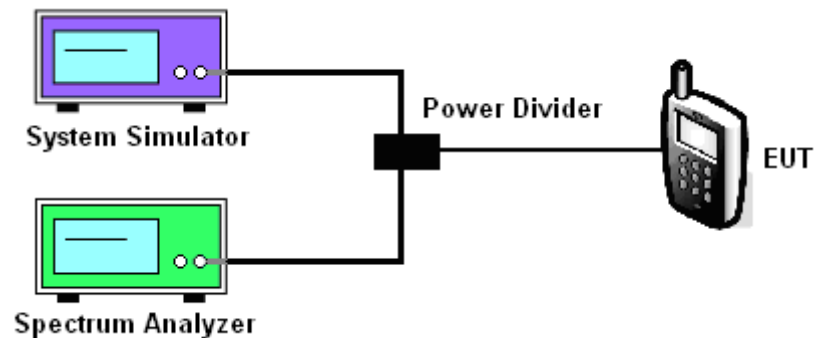



3.4.5 Test Result (Plots) of Conducted Band Edge

Band :	GSM850	Power Stage :	High
Test Mode :	GPRS 8 Link		

Lower Band Edge Plot on Channel 128

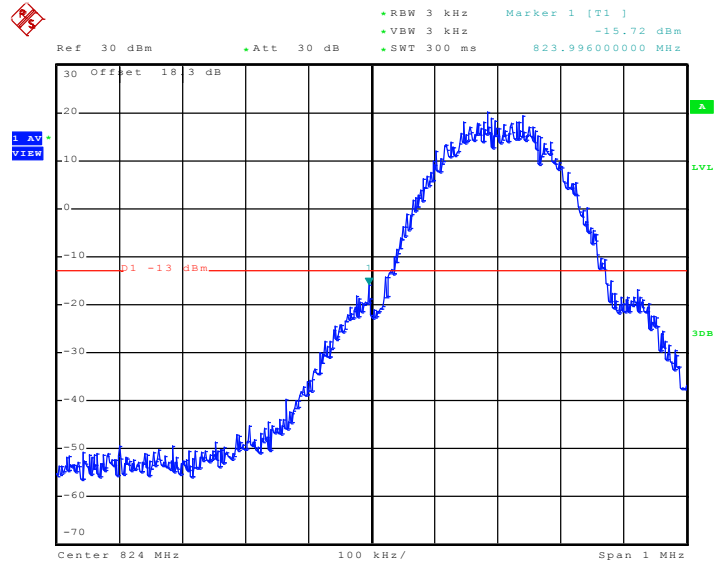

Date: 5.JAN.2011 14:55:36

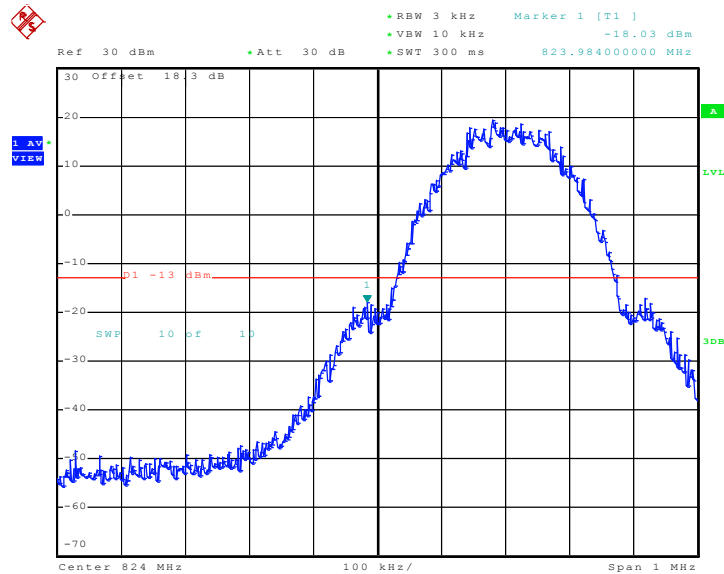

Date: 5.JAN.2011 14:56:34



Higher Band Edge Plot on Channel 251

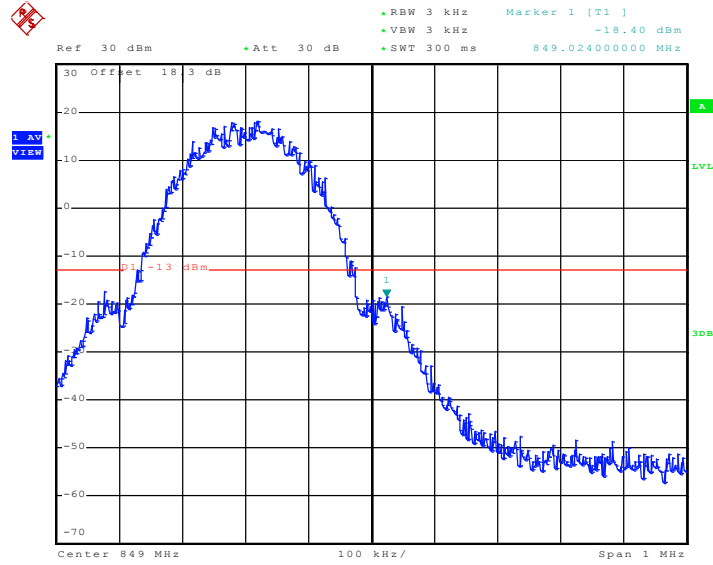

Date: 5.JAN.2011 14:56:03

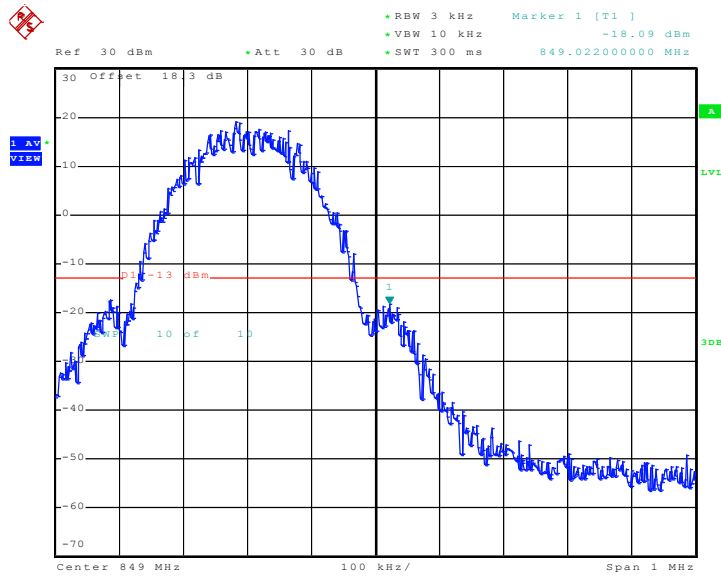

Date: 5.JAN.2011 14:57:05



Band :	GSM850	Power Stage :	High
Test Mode :	EDGE 8 Link		

Lower Band Edge Plot on Channel 128

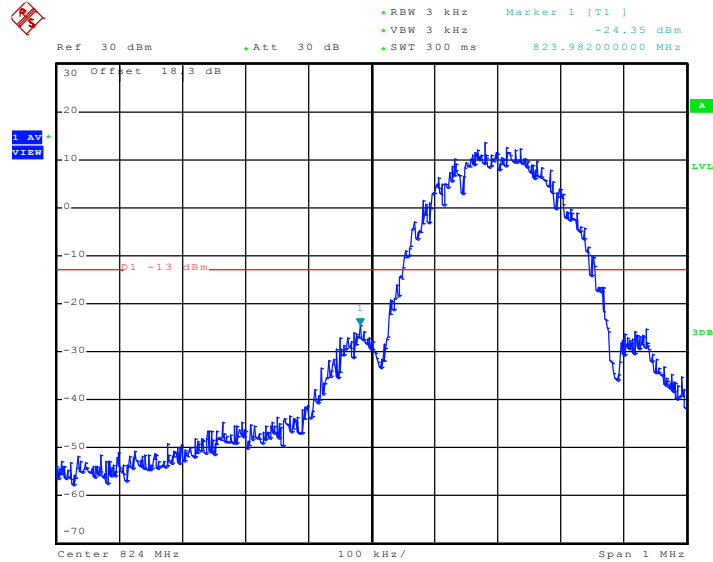

Date: 5.JAN.2011 15:39:18

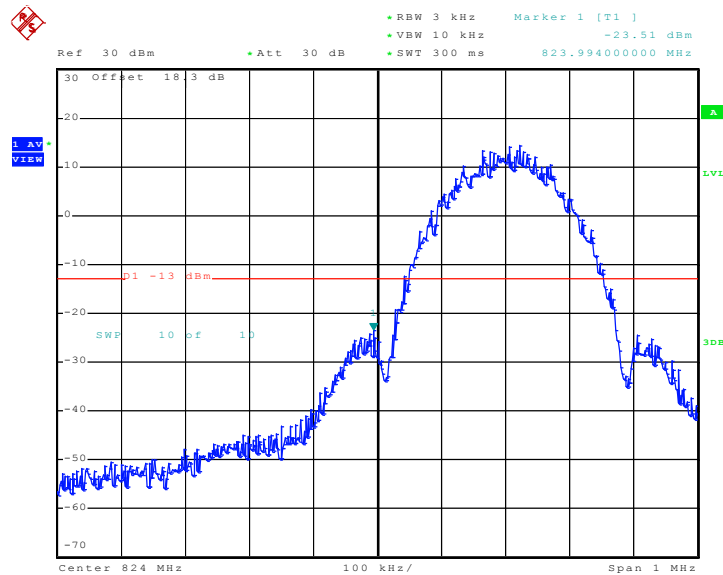

Date: 5.JAN.2011 15:40:15



Higher Band Edge Plot on Channel 251

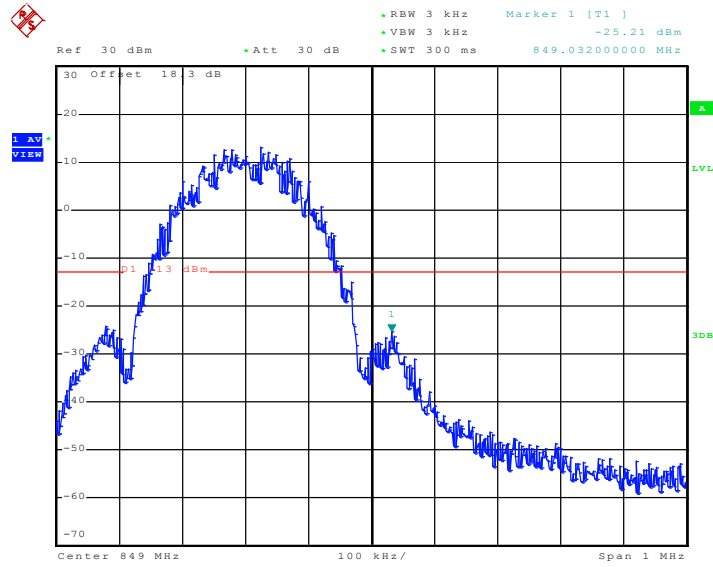

Date: 5.JAN.2011 15:39:45

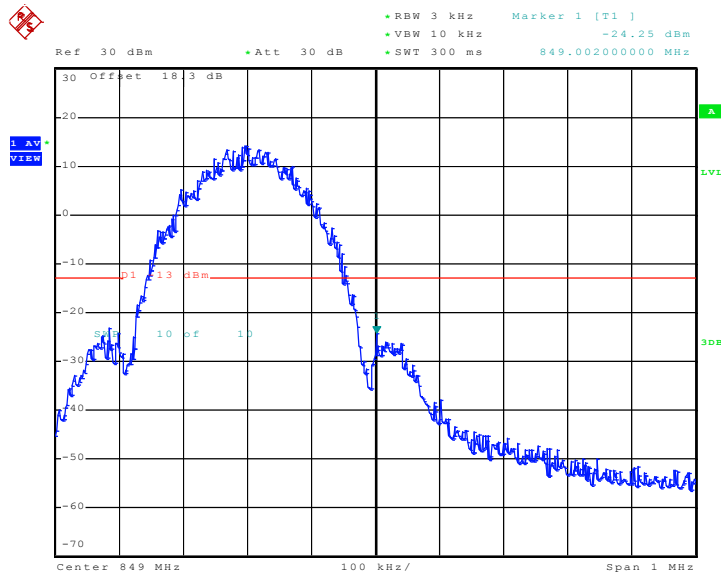

Date: 5.JAN.2011 15:42:16



Band :	GSM1900	Power Stage :	High
Test Mode :	GPRS 8 Link		

Lower Band Edge Plot on Channel 512

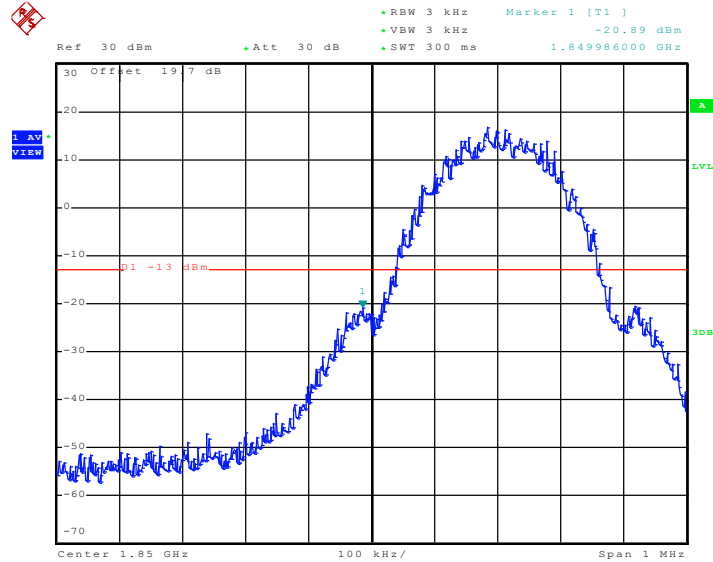

Date: 5.JAN.2011 15:20:58

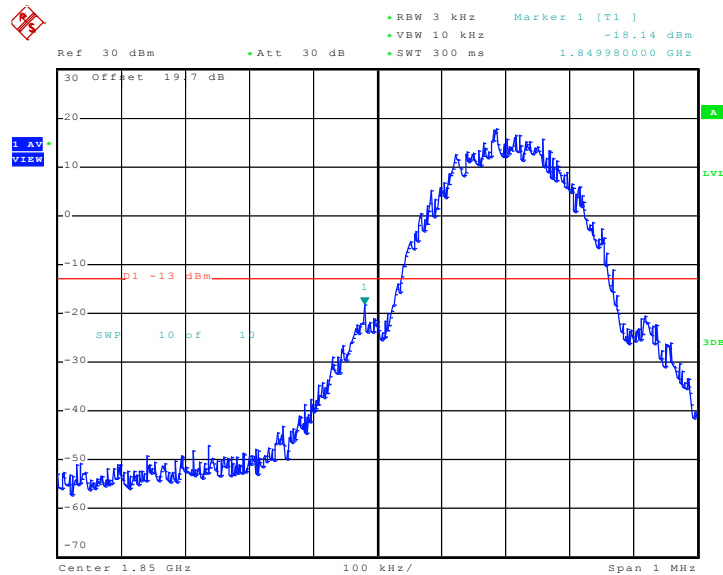

Date: 5.JAN.2011 15:21:55



Higher Band Edge Plot on Channel 810

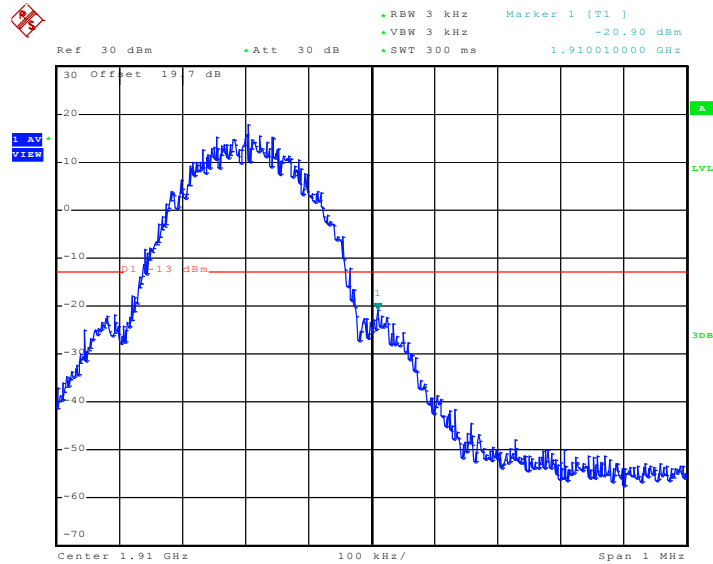

Date: 5.JAN.2011 15:21:25

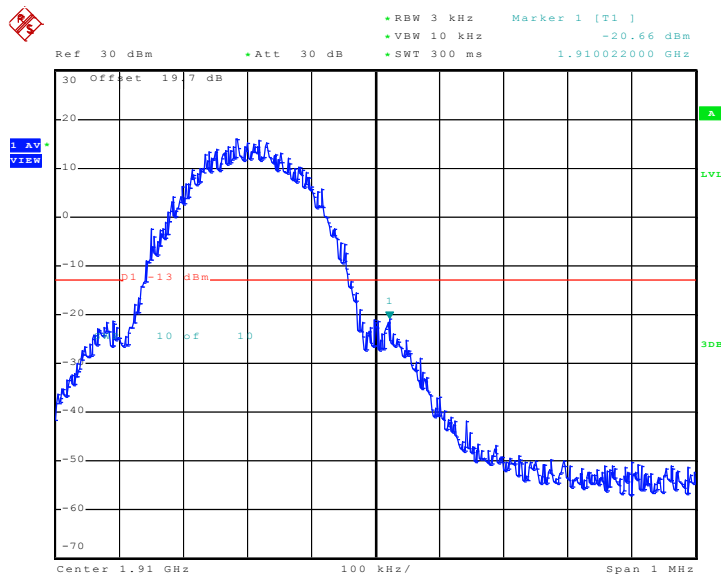

Date: 5.JAN.2011 15:22:26



Band :	GSM1900	Power Stage :	High
Test Mode :	EDGE 8 Link		

Lower Band Edge Plot on Channel 512

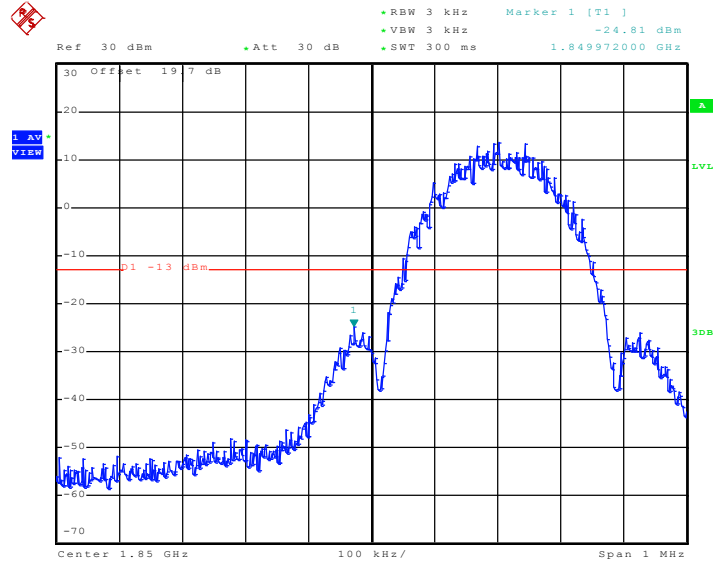

Date: 5.JAN.2011 16:05:21

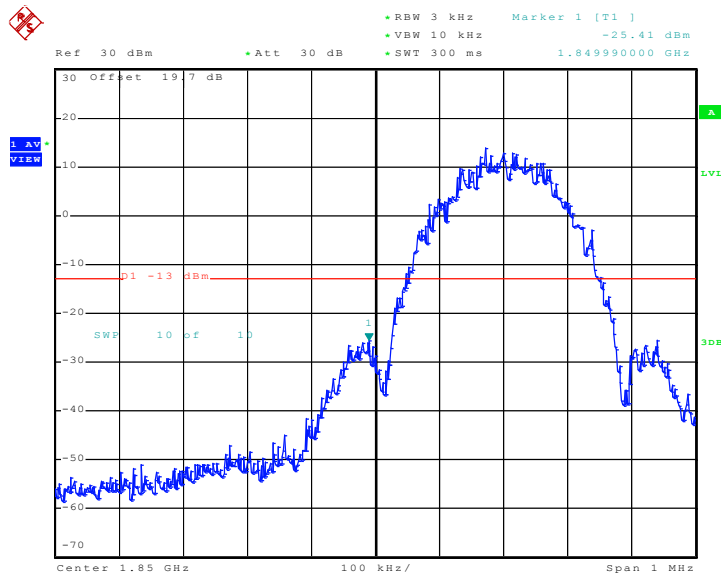

Date: 5.JAN.2011 16:06:18



Higher Band Edge Plot on Channel 810

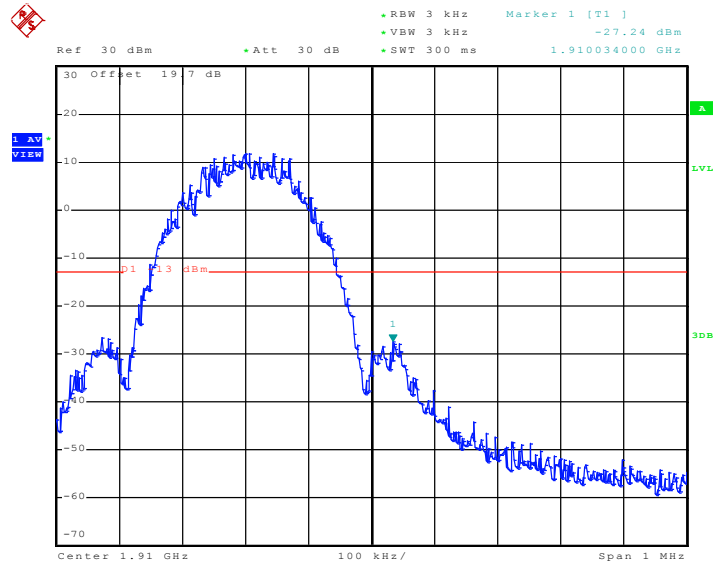

Date: 5.JAN.2011 16:05:47

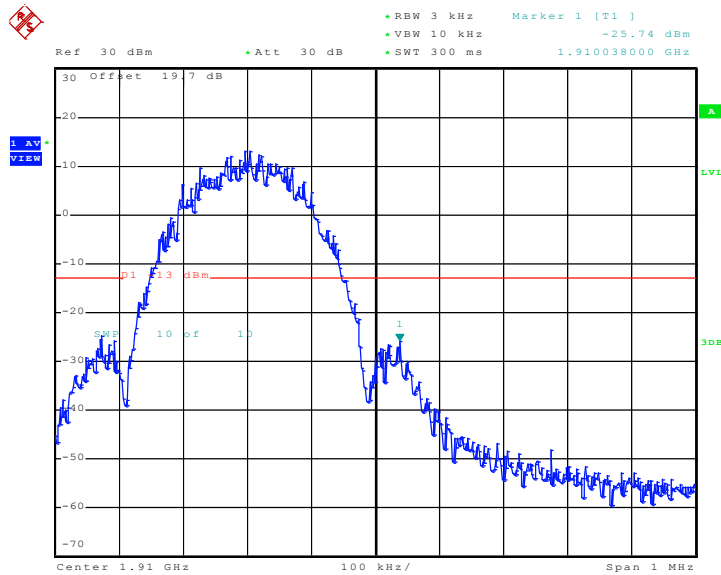

Date: 5.JAN.2011 16:06:48



Band :	WCDMA Band V	Power Stage :	High
Test Mode :	RMC 12.2Kbps Link		

Lower Band Edge Plot on Channel 4132

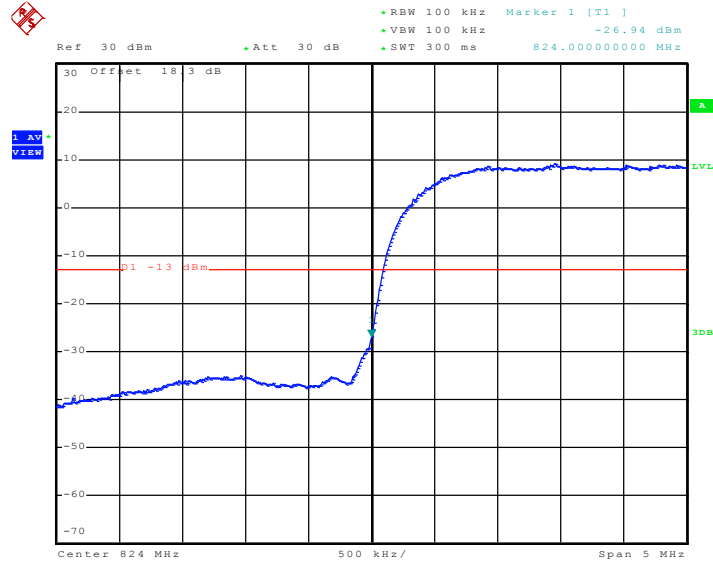

Date: 5.JAN.2011 16:39:55

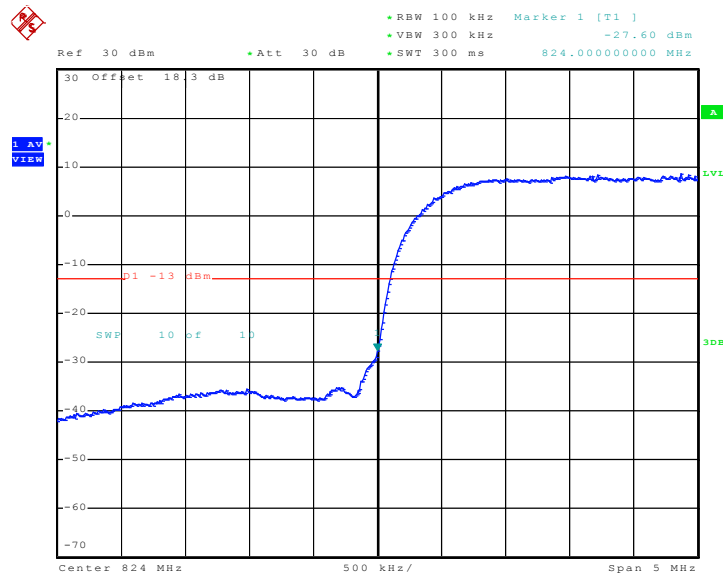

Date: 5.JAN.2011 16:40:54



Higher Band Edge Plot on Channel 4233

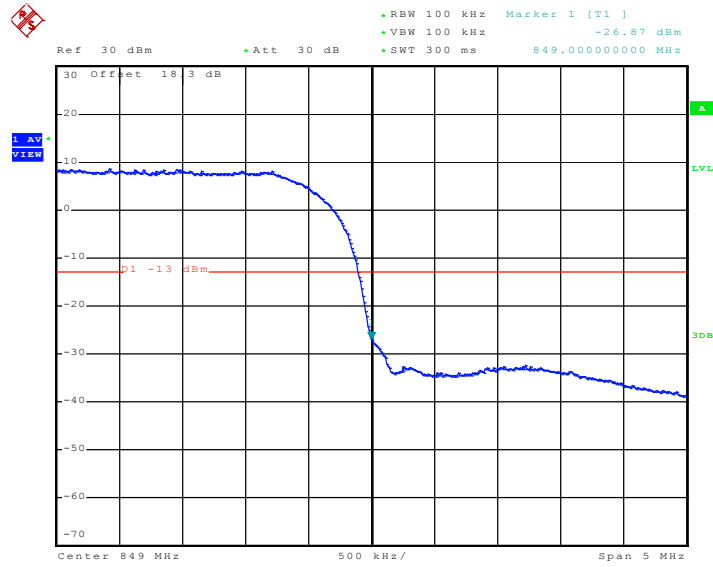

Date: 5.JAN.2011 16:40:21

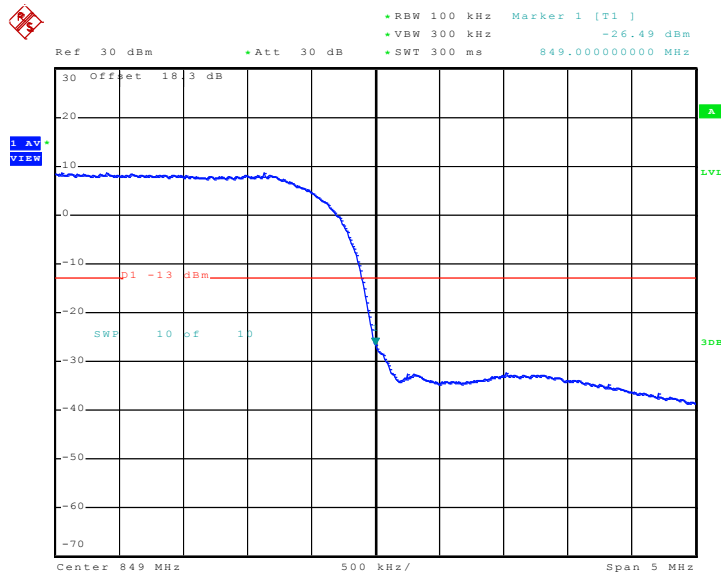

Date: 5.JAN.2011 16:41:25



Band :	WCDMA Band IV	Power Stage :	High
Test Mode :	RMC 12.2Kbps Link		

Lower Band Edge Plot on Channel 1312

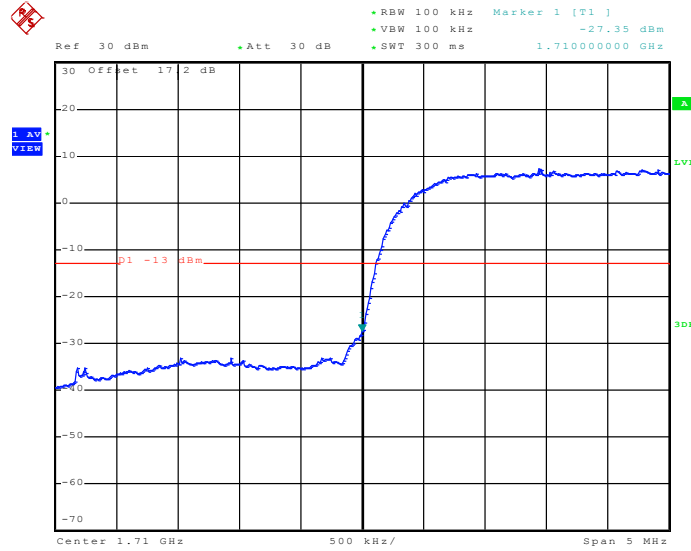

Date: 28.JAN.2011 16:32:49

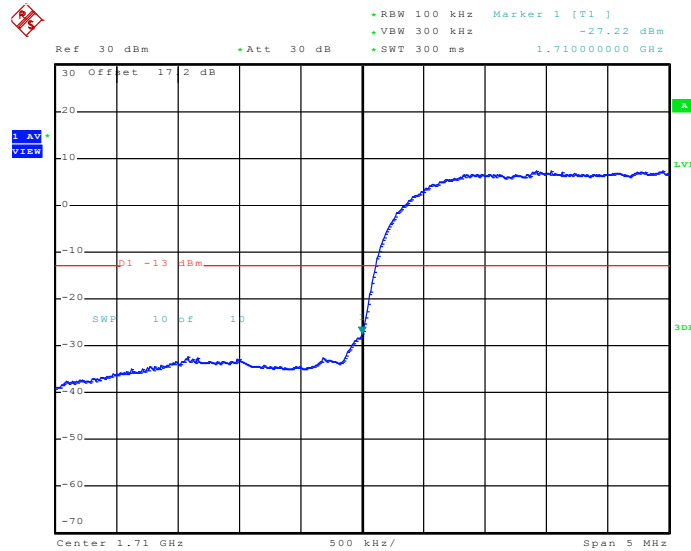

Date: 28.JAN.2011 16:33:46



Higher Band Edge Plot on Channel 1513

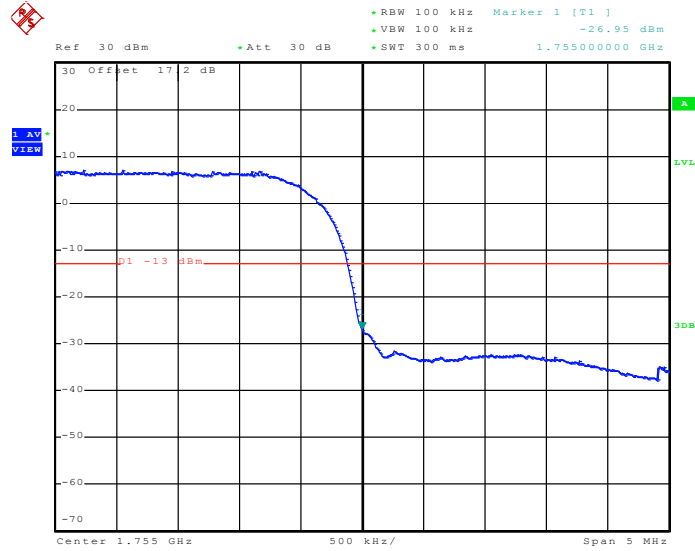

Date: 28.JAN.2011 16:33:16

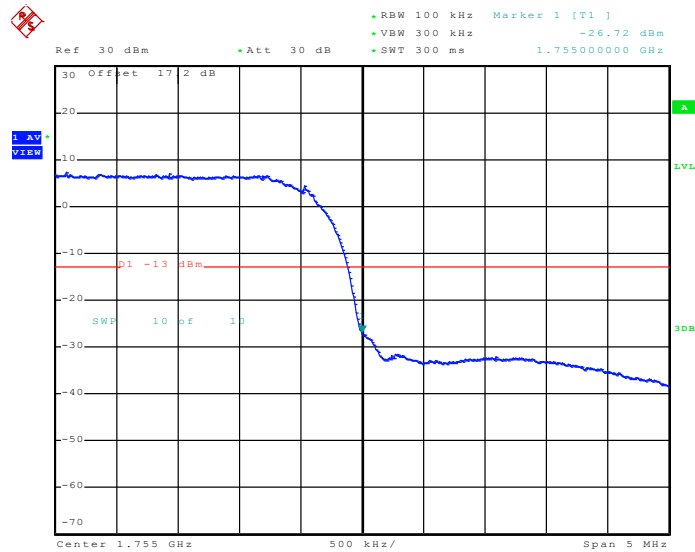

Date: 28.JAN.2011 16:34:15



Band :	WCDMA Band II	Power Stage :	High
Test Mode :	RMC 12.2Kbps Link		

Lower Band Edge Plot on Channel 9262

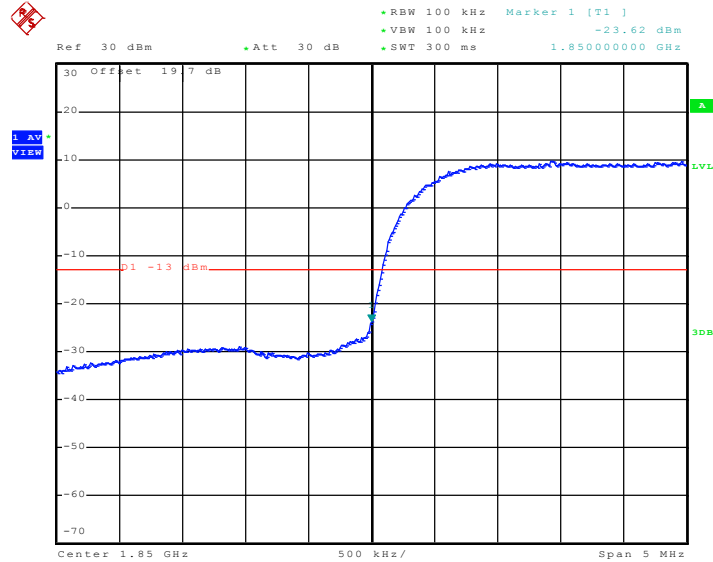

Date: 5.JAN.2011 16:55:43

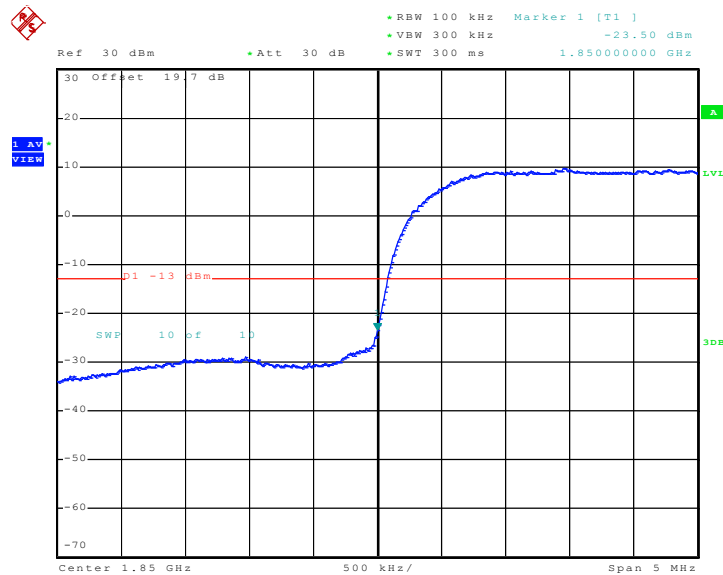

Date: 5.JAN.2011 16:56:41



Higher Band Edge Plot on Channel 9538

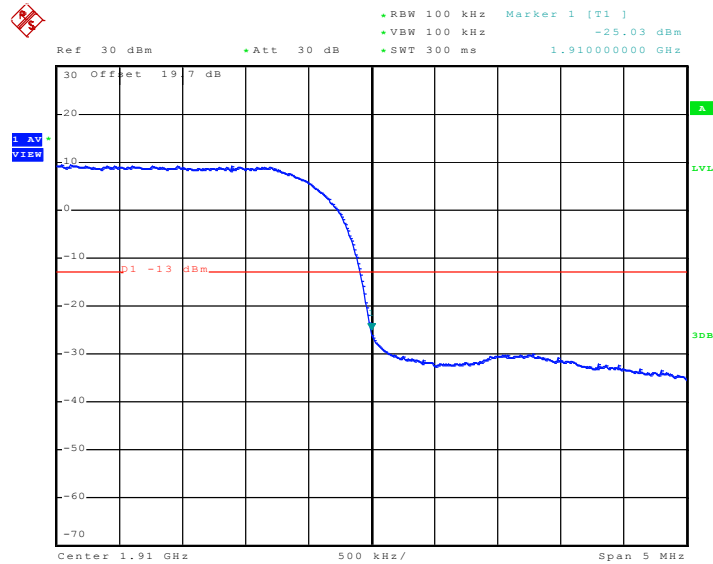

Date: 5.JAN.2011 16:56:10

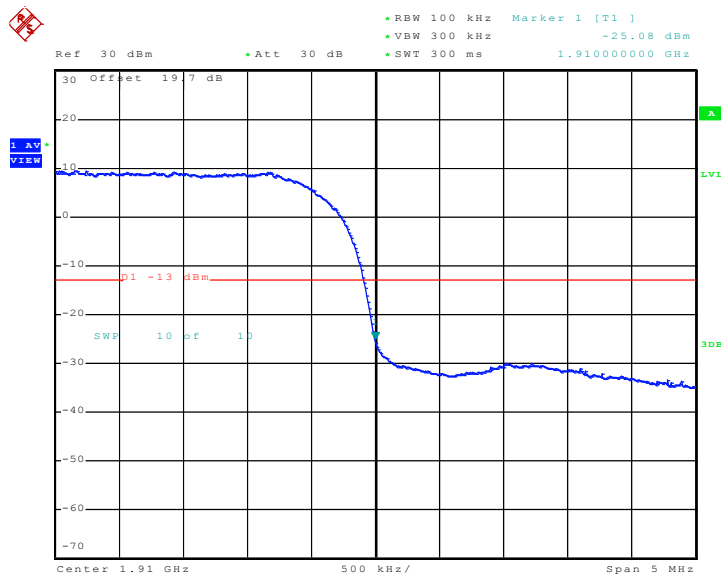

Date: 5.JAN.2011 16:57:12



Band :	CDMA2000 BC0	Power Stage :	High
Test Mode :	1xEV-DO Rev. A_RETAP 4096K		

Lower Band Edge Plot on Channel 1013

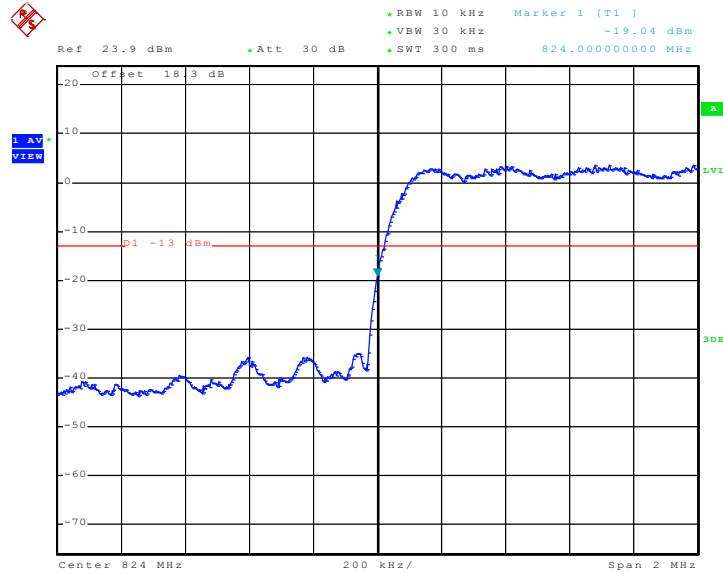

Date: 6.JAN.2011 09:08:42

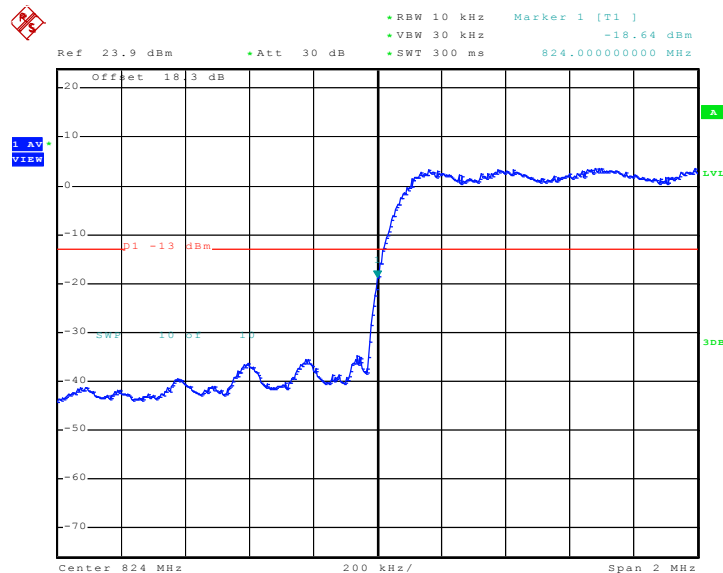

Date: 6.JAN.2011 09:09:53



Higher Band Edge Plot on Channel 777

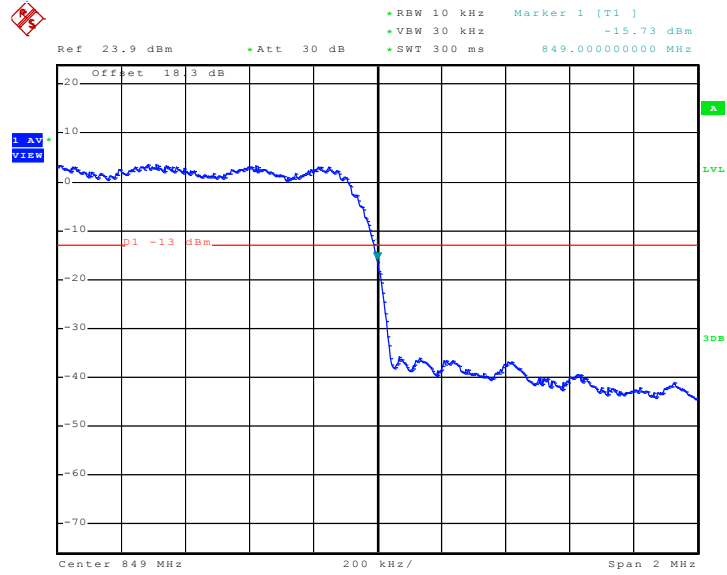

Date: 6.JAN.2011 09:14:20

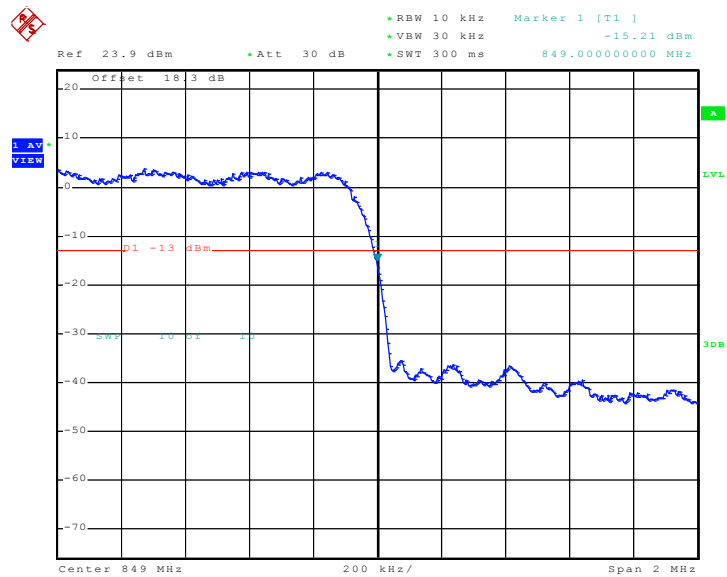

Date: 6.JAN.2011 09:13:39



Band :	CDMA2000 BC1	Power Stage :	High
Test Mode :	1xRTT_RC3+SO55		

Lower Band Edge Plot on Channel 25

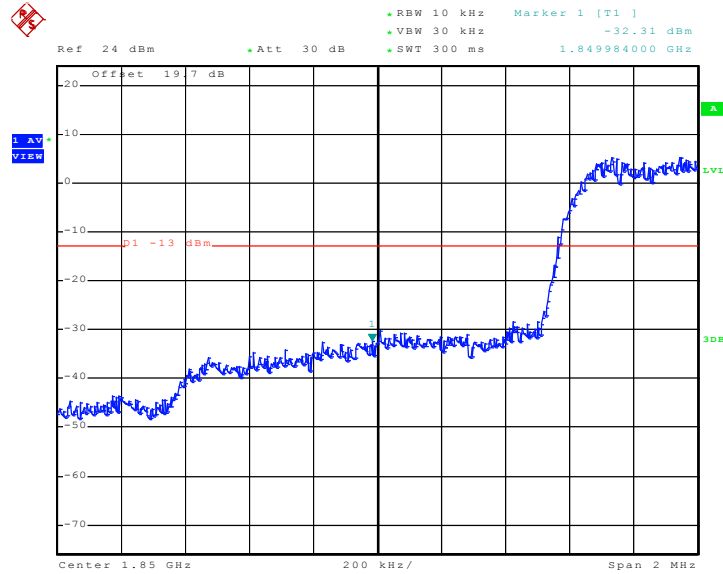

Date: 6.JAN.2011 10:45:59

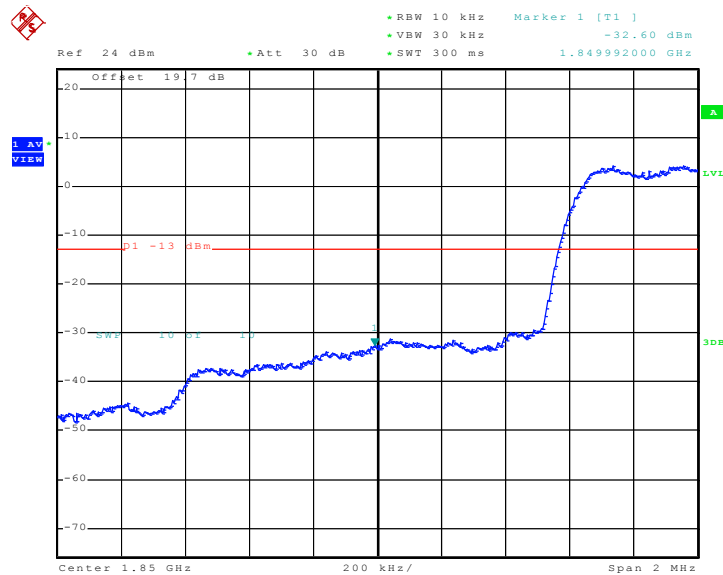

Date: 6.JAN.2011 10:46:45



Higher Band Edge Plot on Channel 1175

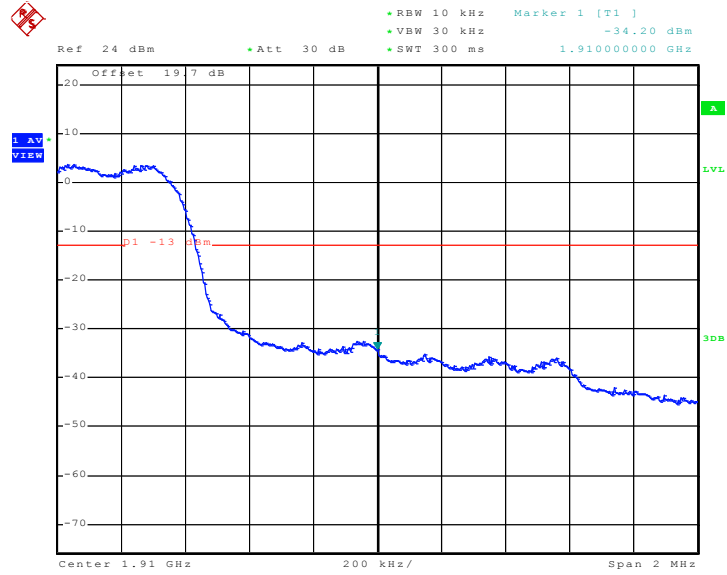

Date: 6.JAN.2011 10:48:25

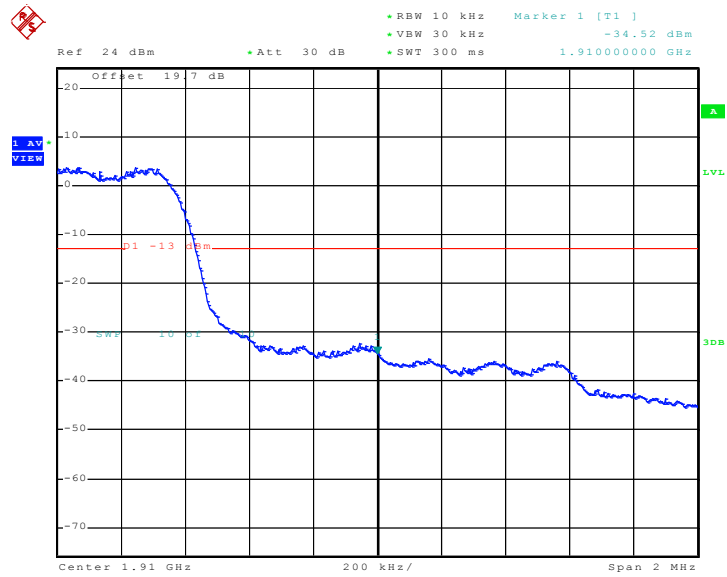

Date: 6.JAN.2011 10:47:39

3.5 Conducted Emission Measurement

3.5.1 Description of Conducted Emission Measurement

The power of any emission outside of the authorized operating frequency ranges must be lower than the transmitter power (P) by a factor of at least $43 + 10 \log (P)$ dB.

It is measured by means of a calibrated spectrum analyzer and scanned from 30 MHz up to a frequency including its 10th harmonic.

3.5.2 Measuring Instruments

See list of measuring instruments of this test report.

3.5.3 Test Procedures

1. The EUT was connected to spectrum analyzer and base station via power divider.
2. The middle channel for the highest RF power within the transmitting frequency was measured.
3. The conducted spurious emission for the whole frequency range was taken.

3.5.4 Test Setup

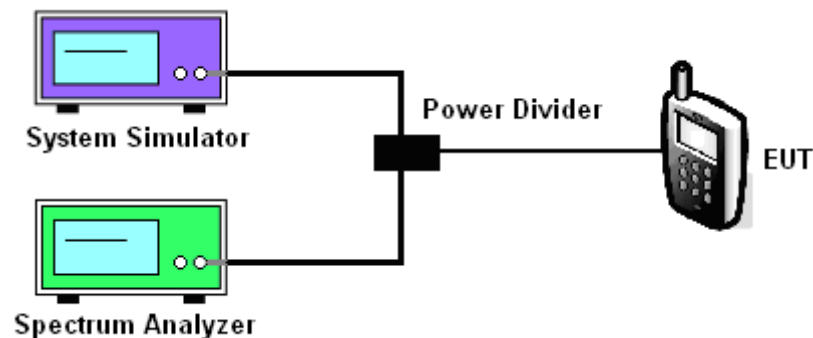

3.5.5 Test Result (Plots) of Conducted Emission

Band :	GSM850	Channel :	CH189
Test Mode :	GPRS 8 Link		

Conducted Emission Plot between 30MHz ~ 1GHz

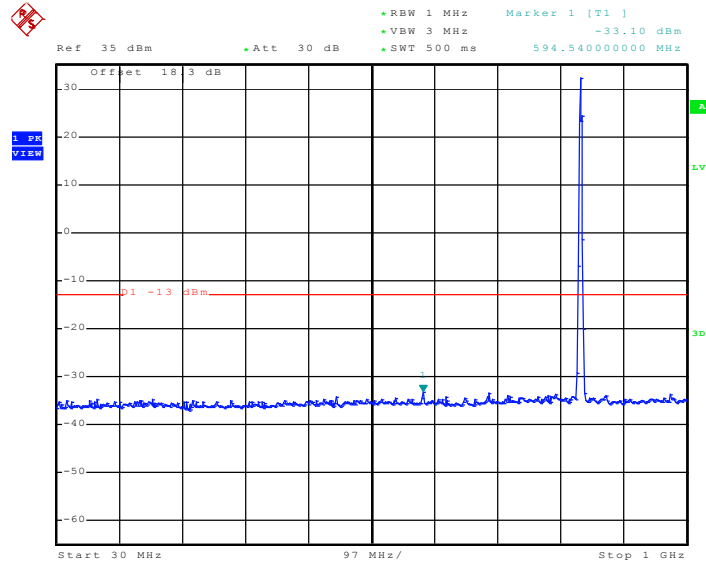

Date: 5.JAN.2011 15:08:38

Conducted Emission Plot between 1GHz ~ 3GHz

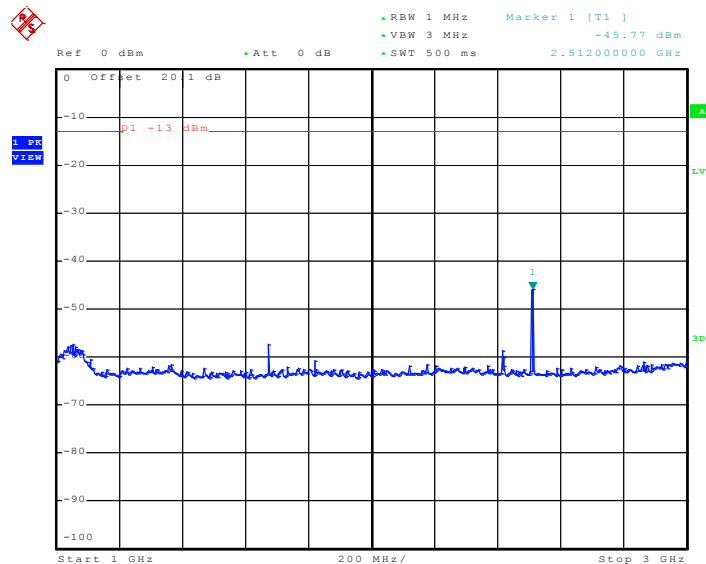

Date: 5.JAN.2011 15:05:50



Conducted Emission Plot between 3GHz ~ 7GHz

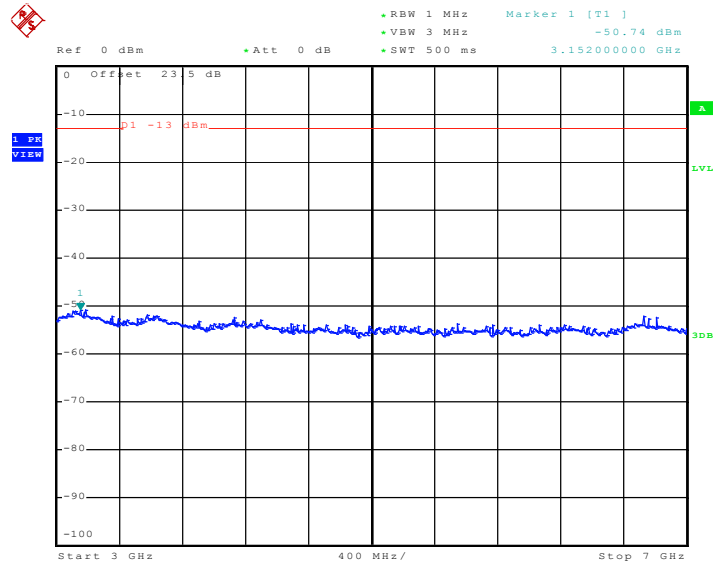

Date: 5.JAN.2011 15:06:02

Conducted Emission Plot between 7GHz ~ 9GHz

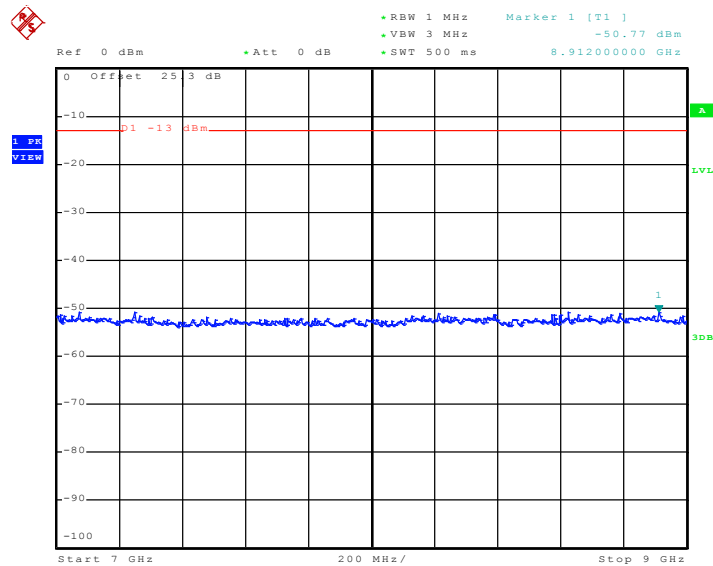

Date: 5.JAN.2011 15:06:15



Band :	GSM850	Channel :	CH189
Test Mode :	EDGE 8 Link		

Conducted Emission Plot between 30MHz ~ 1GHz

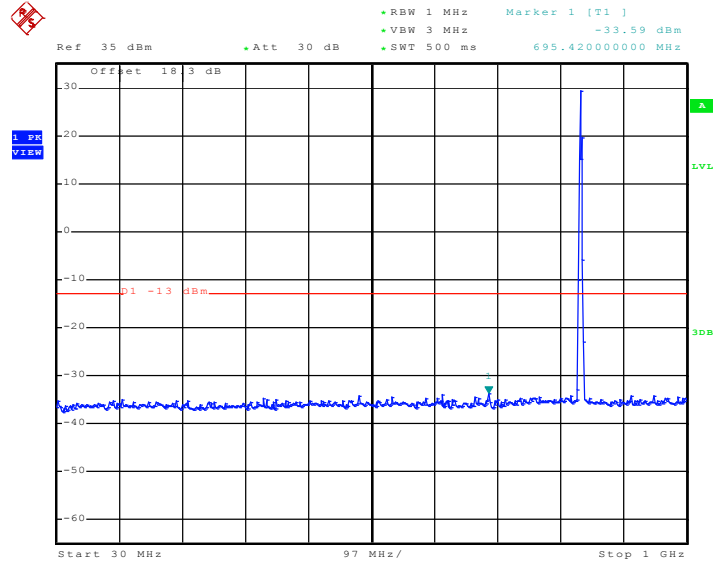

Date: 5.JAN.2011 15:47:29

Conducted Emission Plot between 1GHz ~ 3GHz

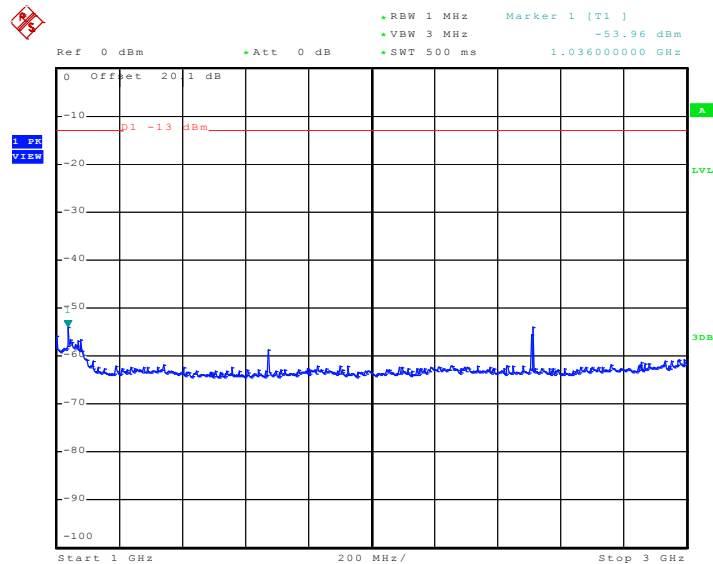

Date: 5.JAN.2011 15:51:11



Conducted Emission Plot between 3GHz ~ 7GHz

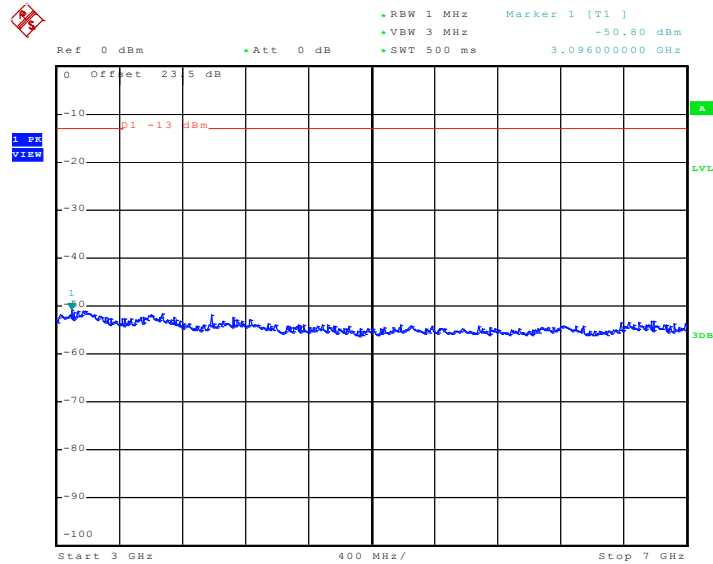

Date: 5.JAN.2011 15:51:23

Conducted Emission Plot between 7GHz ~ 9GHz

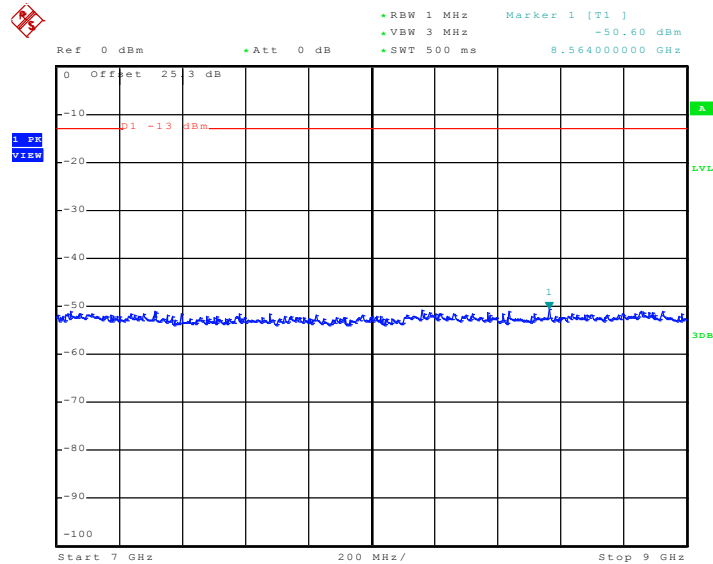

Date: 5.JAN.2011 15:51:35



Band :	GSM1900	Channel :	CH661
Test Mode :	GPRS 8 Link		

Conducted Emission Plot between 30MHz ~ 1GHz

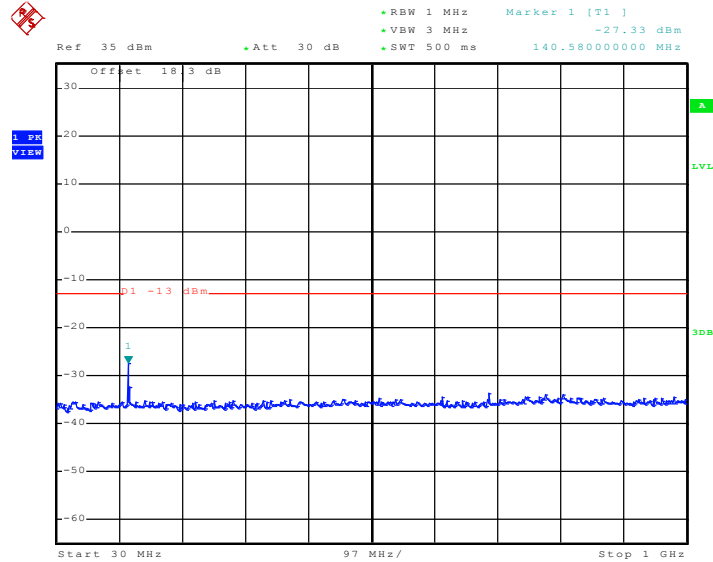

Date: 5.JAN.2011 15:11:46

Conducted Emission Plot between 1GHz ~ 3GHz

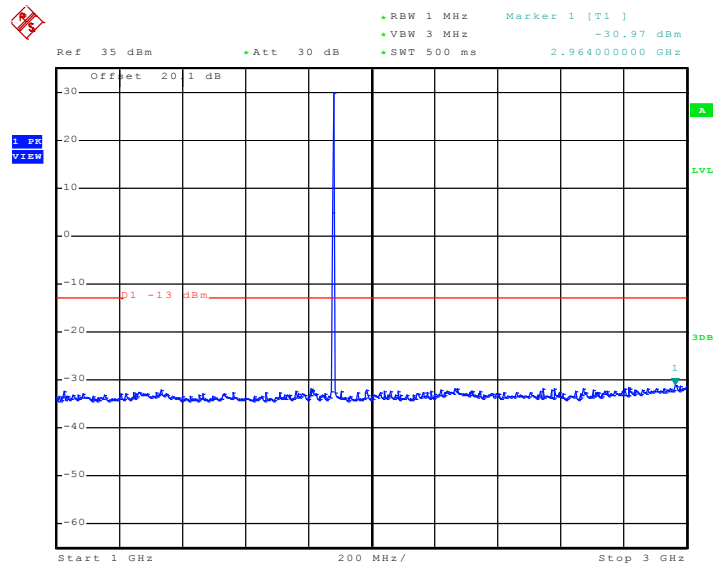

Date: 5.JAN.2011 15:13:00



Conducted Emission Plot between 3GHz ~ 7GHz

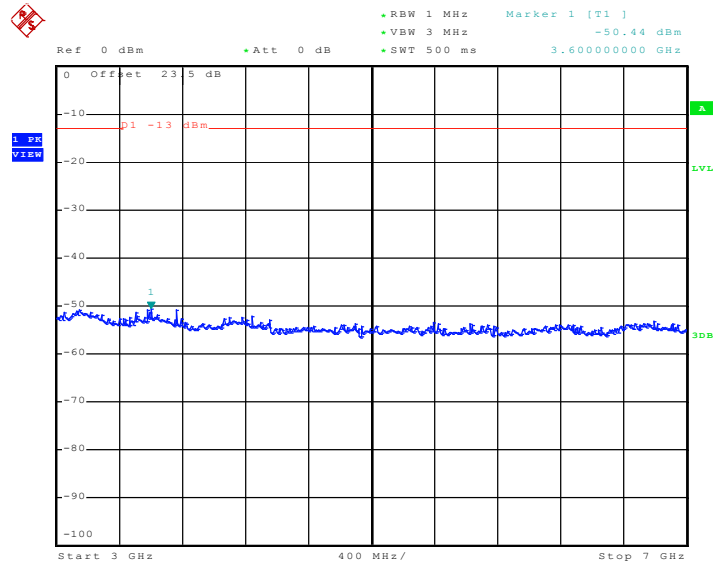

Date: 5.JAN.2011 15:13:12

Conducted Emission Plot between 7GHz ~ 13.6GHz

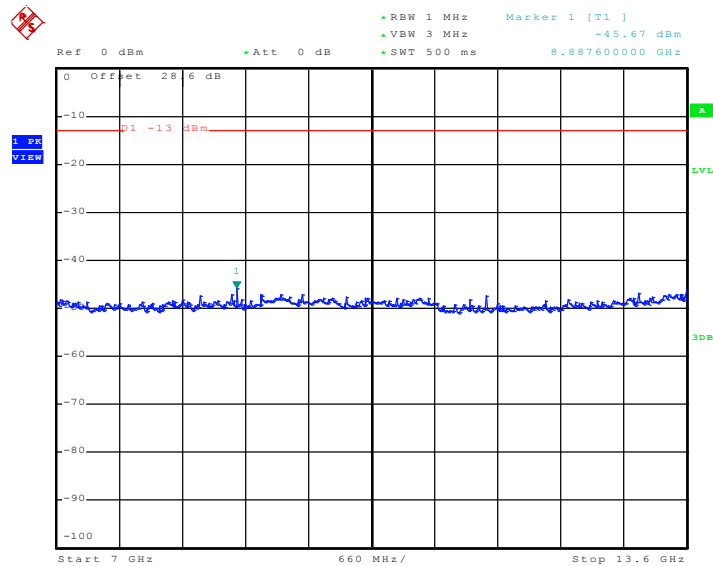

Date: 5.JAN.2011 15:13:24



Conducted Emission Plot between 13.6GHz ~ 19.1GHz

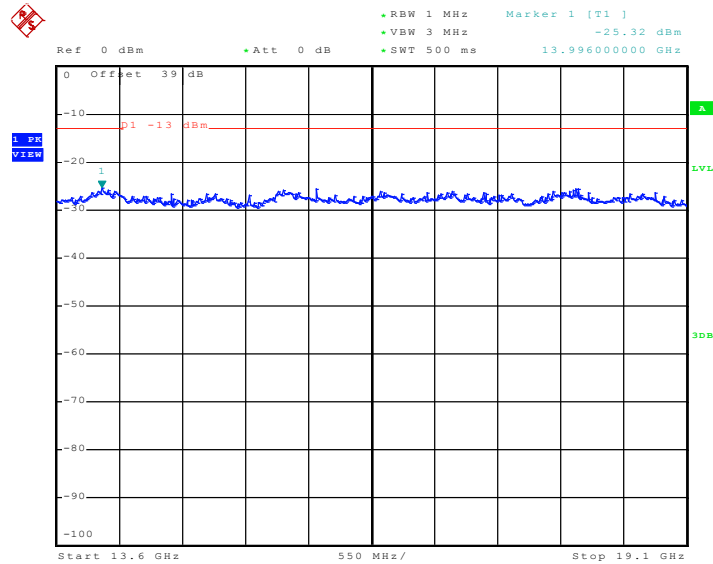

Date: 5.JAN.2011 15:13:37



Band :	GSM1900	Channel :	CH661
Test Mode :	EDGE 8 Link		

Conducted Emission Plot between 30MHz ~ 1GHz

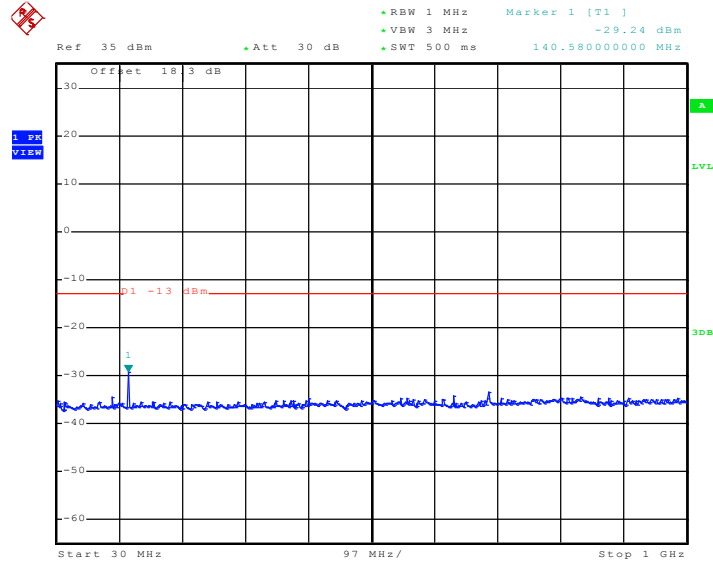

Date: 5.JAN.2011 15:57:27

Conducted Emission Plot between 1GHz ~ 3GHz

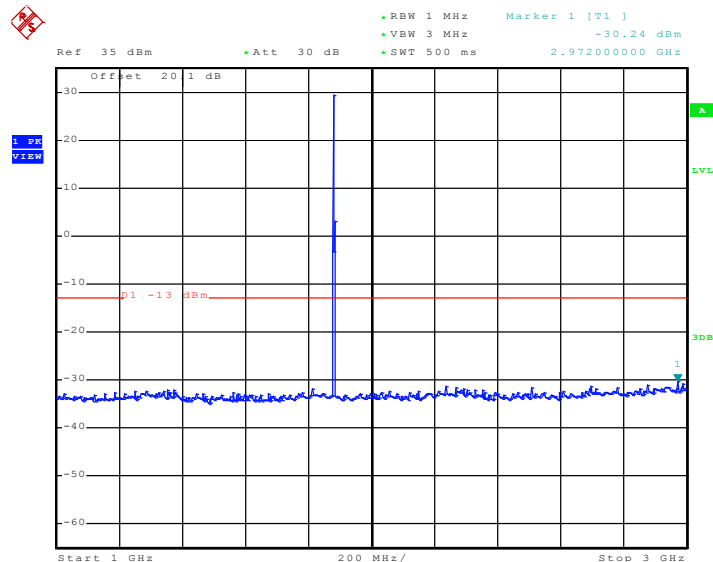

Date: 5.JAN.2011 15:57:44



Conducted Emission Plot between 13.6GHz ~ 19.1GHz

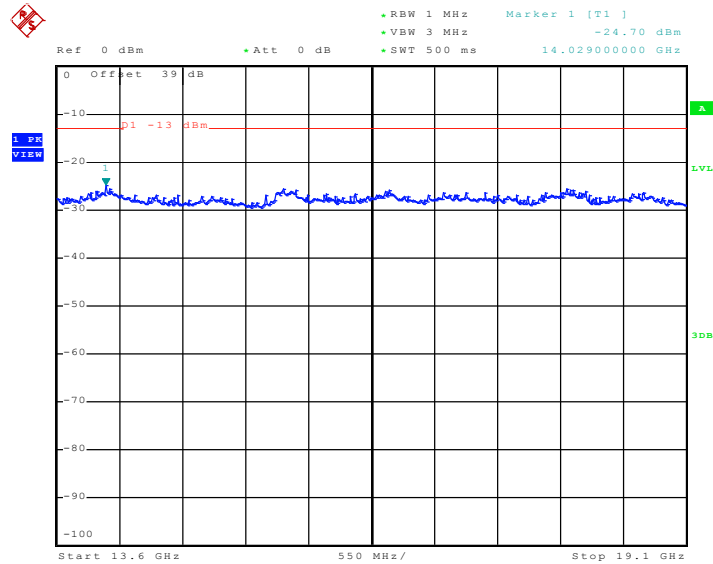

Date: 5.JAN.2011 15:58:21



Band :	WCDMA Band V	Channel :	CH4182
Test Mode :	RMC 12.2Kbps Link		

Conducted Emission Plot between 30MHz ~ 1GHz

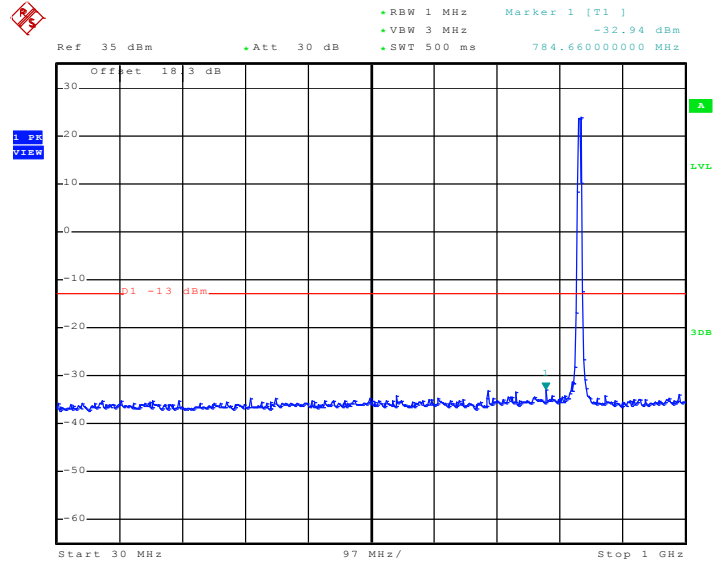

Date: 5.JAN.2011 16:27:29

Conducted Emission Plot between 1GHz ~ 3GHz

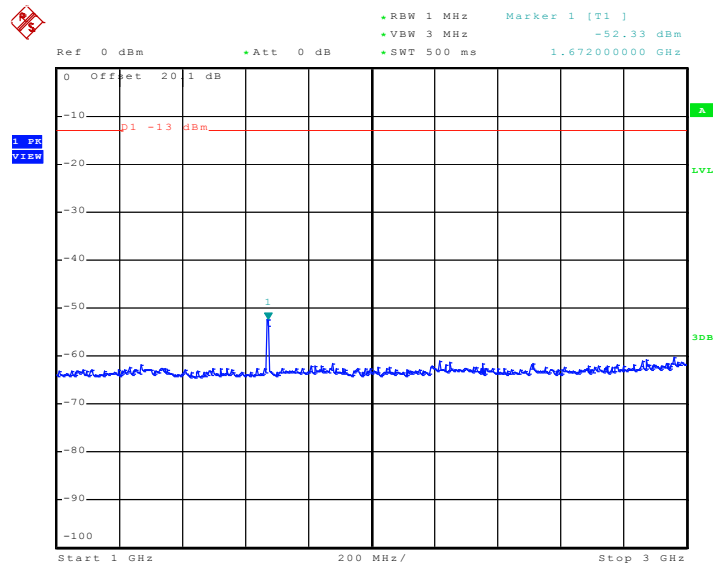

Date: 5.JAN.2011 16:28:13



Conducted Emission Plot between 3GHz ~ 7GHz

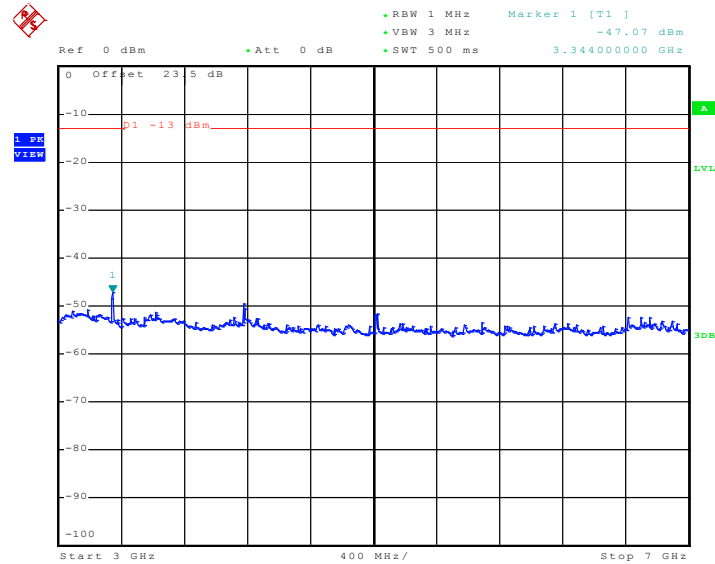

Date: 5.JAN.2011 16:28:25

Conducted Emission Plot between 7GHz ~ 9GHz

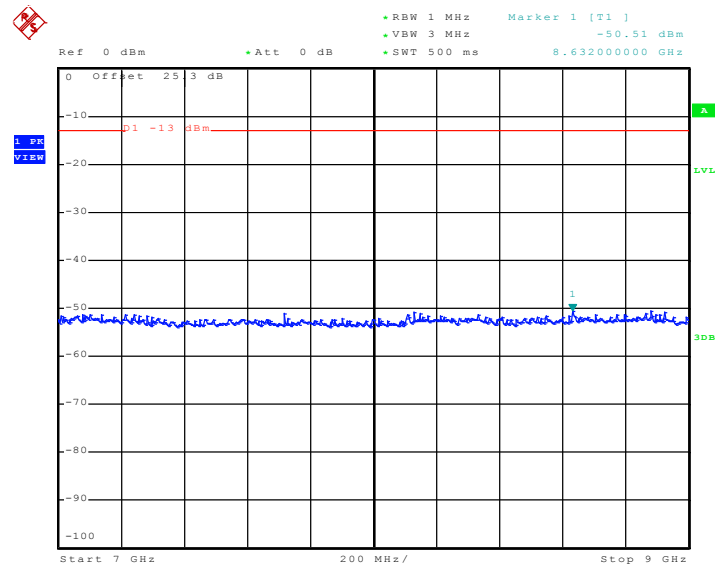

Date: 5.JAN.2011 16:28:38



Band :	WCDMA Band IV	Channel :	CH1413
Test Mode :	RMC 12.2Kbps Link		

Conducted Emission Plot between 30MHz ~ 1GHz

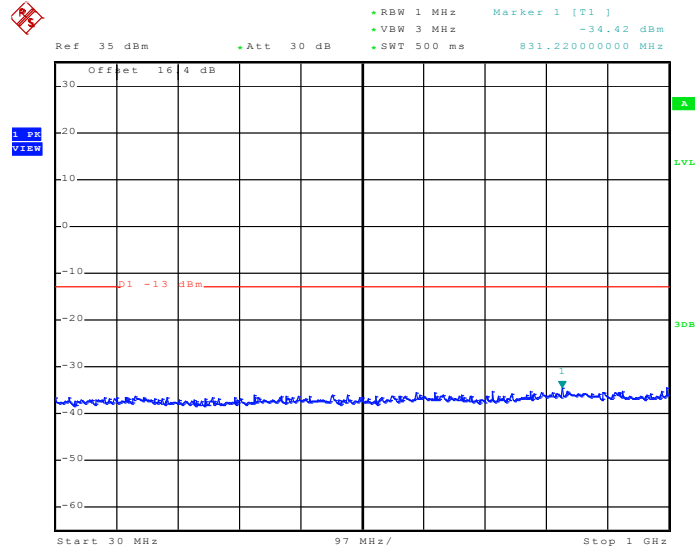

Date: 28.JAN.2011 16:48:47

Conducted Emission Plot between 1GHz ~ 3GHz

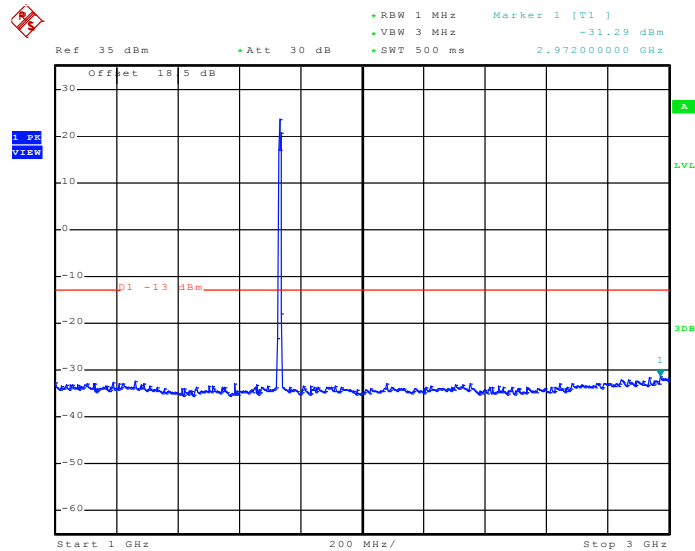

Date: 28.JAN.2011 16:49:00



Conducted Emission Plot between 3GHz ~ 7GHz

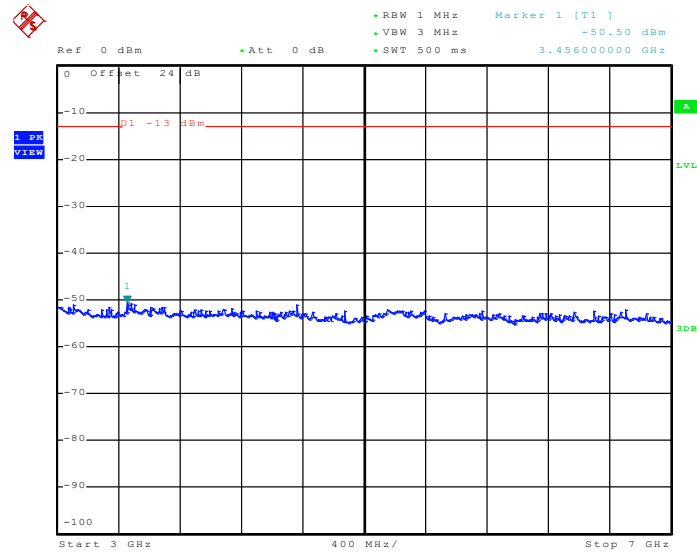

Date: 28.JAN.2011 16:49:17

Conducted Emission Plot between 7GHz ~ 13.6GHz

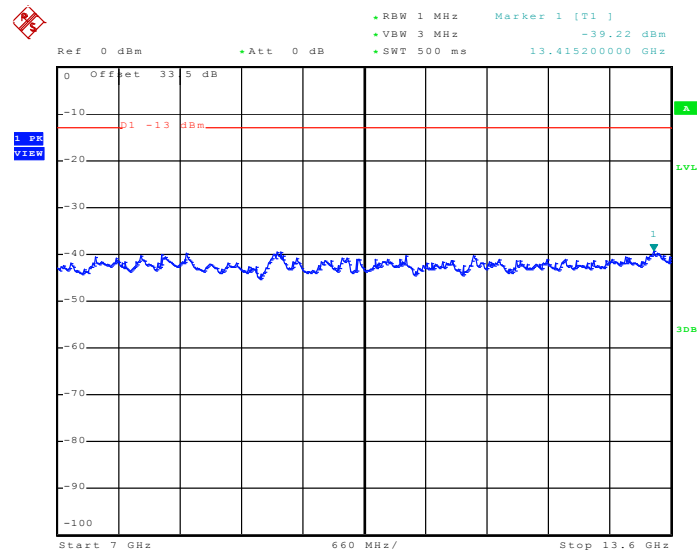

Date: 28.JAN.2011 16:49:30



Conducted Emission Plot between 13.6GHz ~ 18GHz

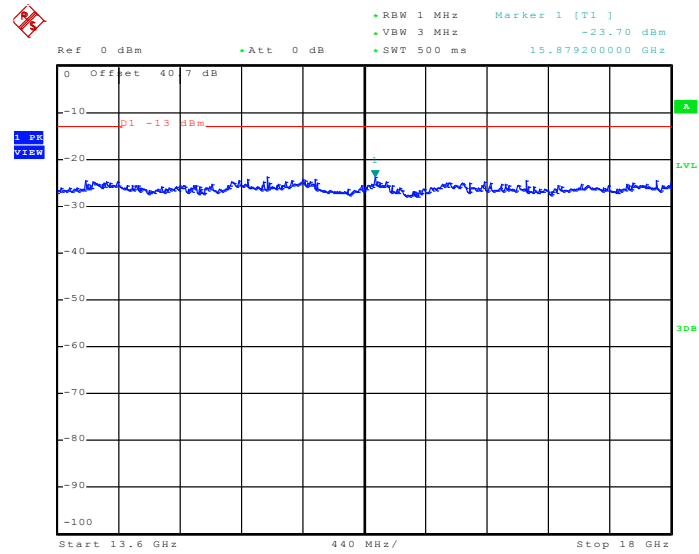

Date: 28.JAN.2011 16:49:42



Band :	WCDMA Band II	Channel :	CH9400
Test Mode :	RMC 12.2Kbps Link		

Conducted Emission Plot between 30MHz ~ 1GHz

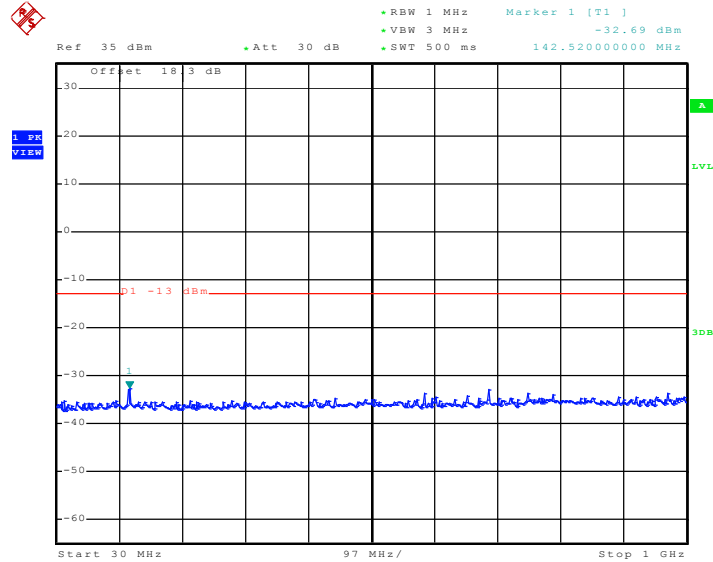

Date: 5.JAN.2011 16:22:15

Conducted Emission Plot between 1GHz ~ 3GHz

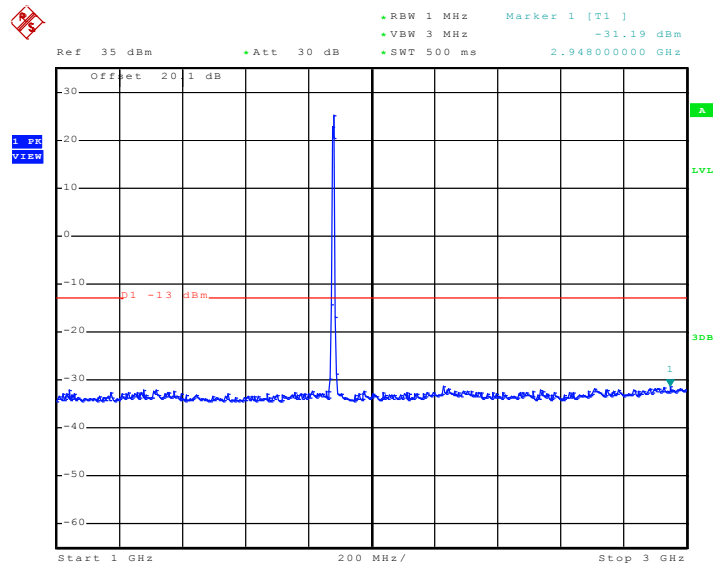

Date: 5.JAN.2011 16:22:33



Conducted Emission Plot between 3GHz ~ 7GHz

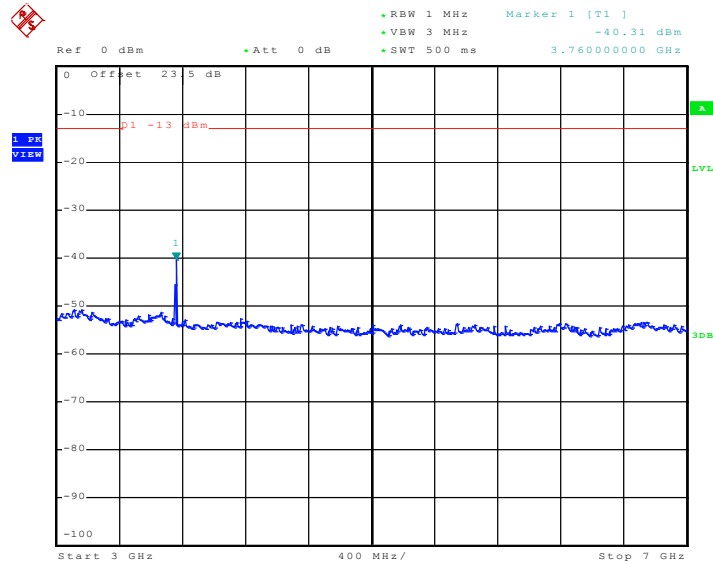

Date: 5.JAN.2011 16:22:46

Conducted Emission Plot between 7GHz ~ 13.6GHz

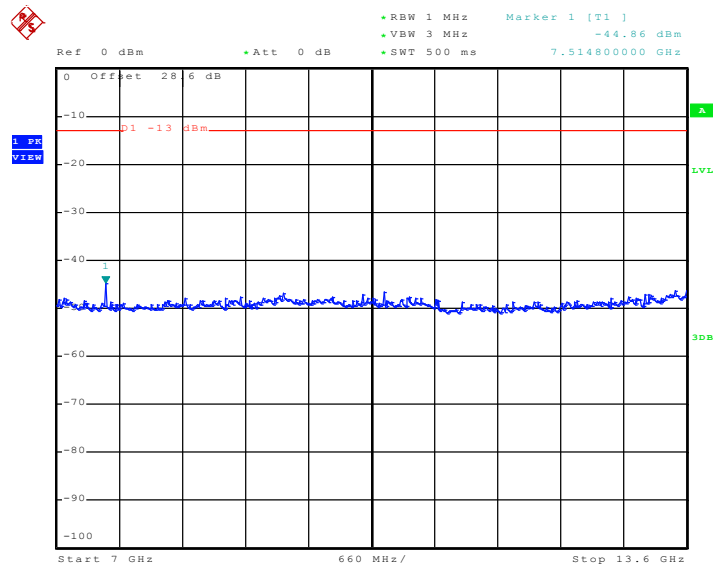

Date: 5.JAN.2011 16:22:58



Conducted Emission Plot between 13.6GHz ~ 19.1GHz

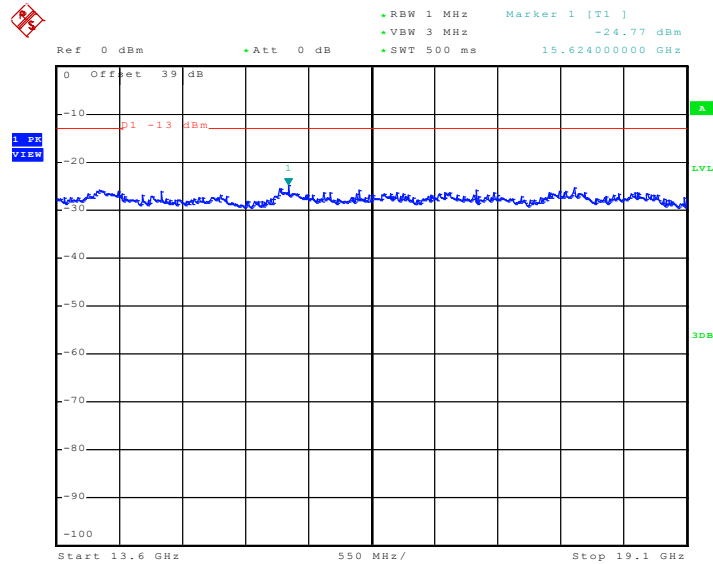

Date: 5.JAN.2011 16:23:10



Band :	CDMA2000 BC0	Power Stage :	High
Test Mode :	1xEV-DO Rev. A_RETAP 4096K		

Conducted Emission Plot between 30MHz ~ 1GHz

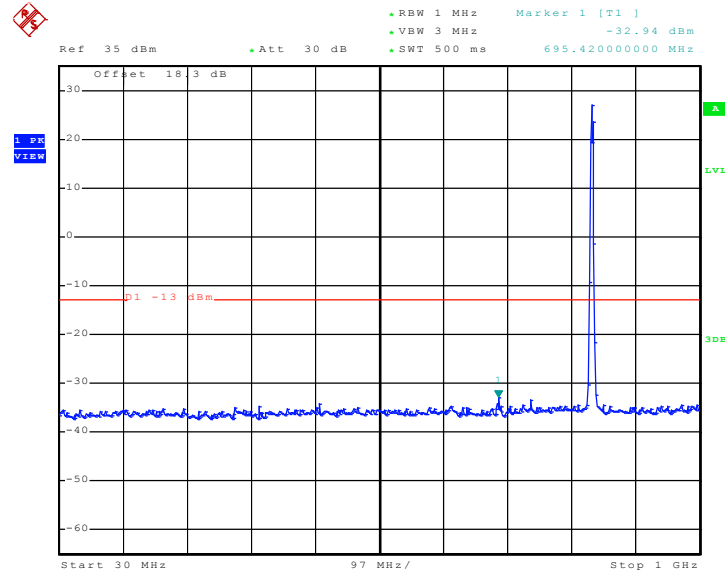

Date: 5.JAN.2011 17:57:13

Conducted Emission Plot between 1GHz ~ 3GHz

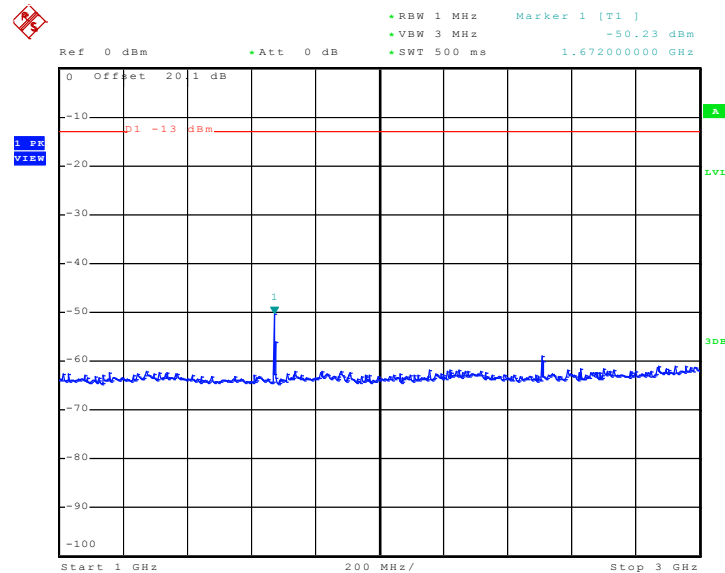

Date: 5.JAN.2011 17:59:38



Conducted Emission Plot between 3GHz ~ 7GHz

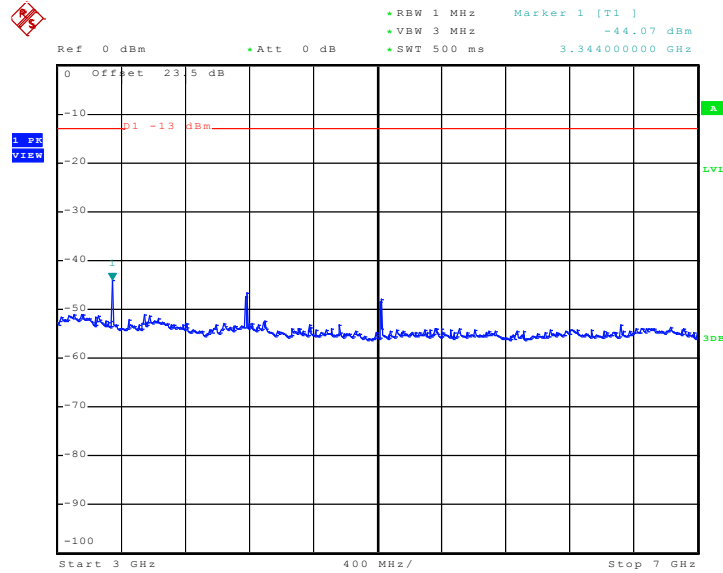

Date: 5.JAN.2011 17:59:51

Conducted Emission Plot between 7GHz ~ 9GHz

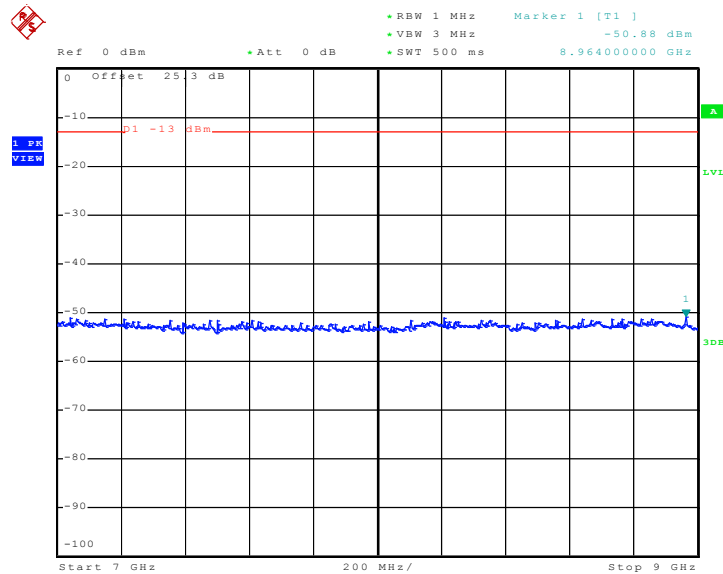

Date: 5.JAN.2011 18:00:04



Band :	CDMA2000 BC1	Power Stage :	High
Test Mode :	1xRTT_RC3+SO55		

Conducted Emission Plot between 30MHz ~ 1GHz

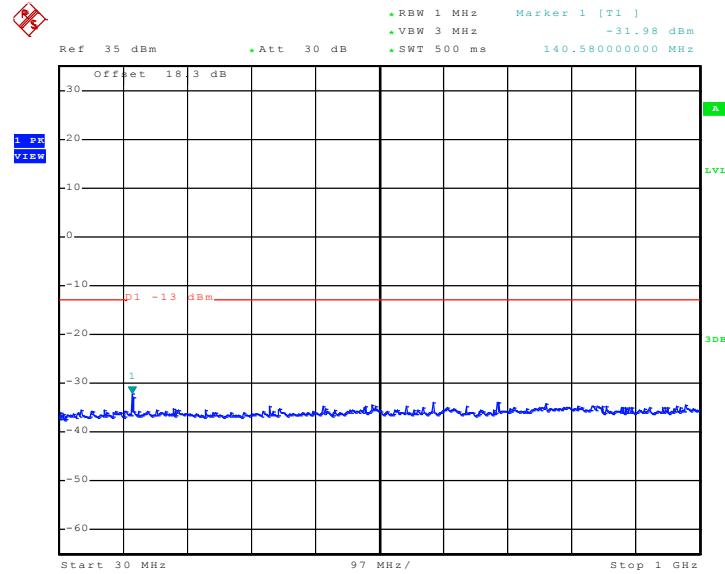

Date: 5.JAN.2011 18:04:28

Conducted Emission Plot between 1GHz ~ 3GHz

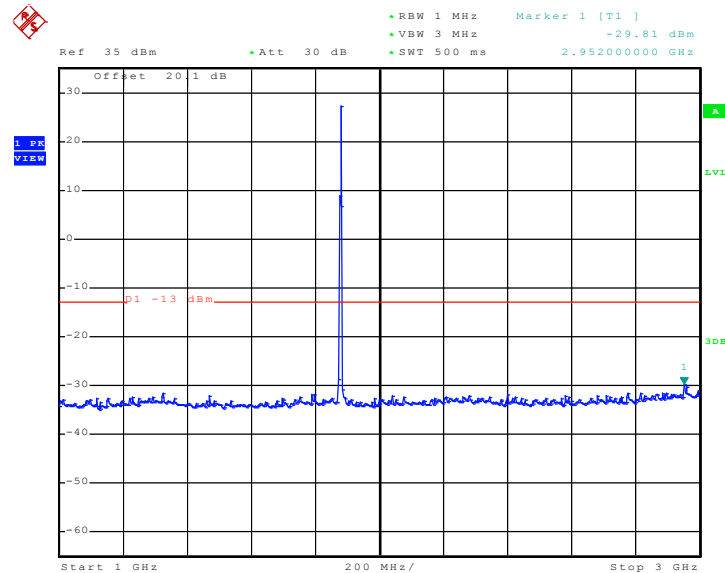

Date: 5.JAN.2011 18:04:48



Conducted Emission Plot between 3GHz ~ 7GHz

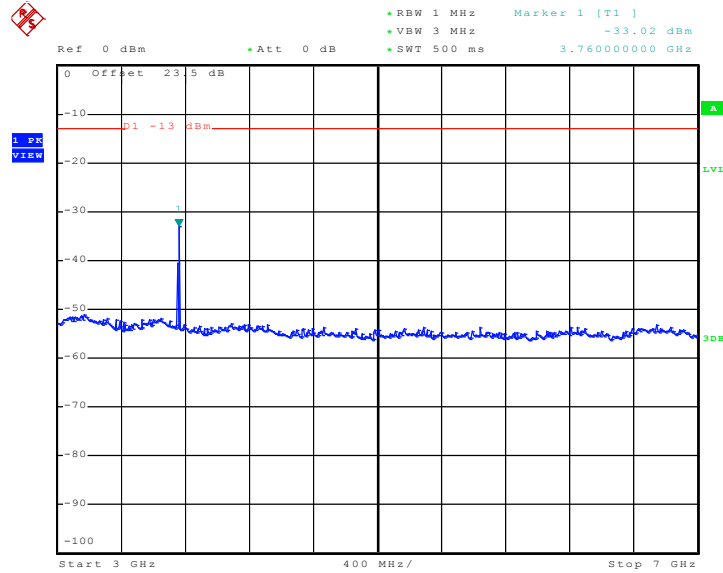

Date: 5.JAN.2011 18:05:01

Conducted Emission Plot between 7GHz ~ 13.6GHz

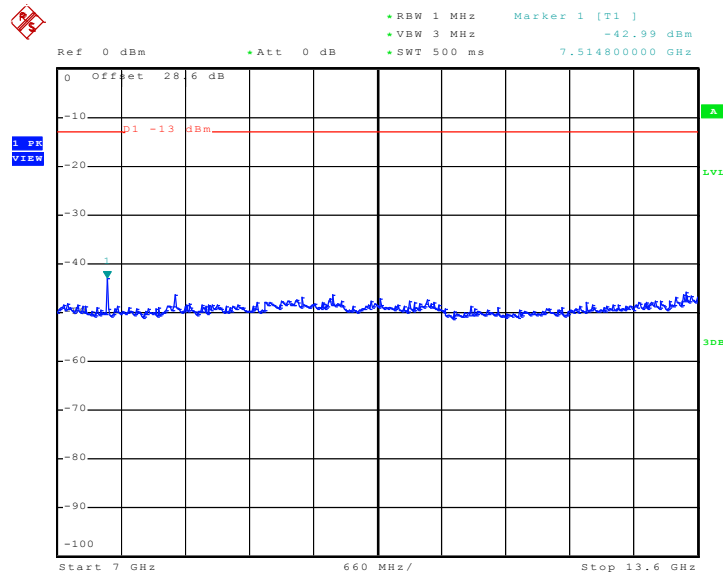

Date: 5.JAN.2011 18:05:13



Conducted Emission Plot between 13.6GHz ~ 19.1GHz

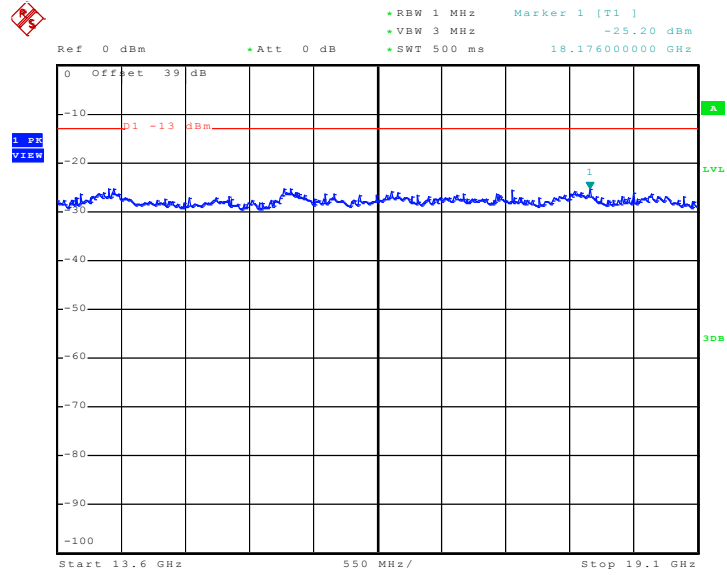

Date: 5.JAN.2011 18:05:25



3.6 Field Strength of Spurious Radiation Measurement

3.6.1 Description of Field Strength of Spurious Radiated Measurement

The radiated spurious emission was measured by substitution method according to ANSI / TIA / EIA-603-C-2004. The power of any emission outside of the authorized operating frequency ranges must be attenuated below the transmitter power (P) by a factor of at least $43 + 10 \log (P)$ dB. The spectrum is scanned from 30 MHz up to a frequency including its 10th harmonic.

3.6.2 Measuring Instruments

See list of measuring instruments of this test report.

3.6.3 Test Procedures

1. The EUT was placed on a rotatable wooden table with 0.8 meter about ground.
2. The EUT was set 3 meters from the receiving antenna, which was mounted on the antenna tower.
3. The table was rotated 360 degrees to determine the position of the highest spurious emission.
4. The height of the receiving antenna is varied between one meter and four meters to search the maximum spurious emission for both horizontal and vertical polarizations.
5. Make the measurement with the spectrum analyzer's RBW = 1MHz, VBW = 3MHz, Sweep = 500ms, Taking the record of maximum spurious emission.
6. A horn antenna was substituted in place of the EUT and was driven by a signal generator.
7. Tune the output power of signal generator to the same emission level with EUT maximum spurious emission.
8. Taking the record of output power at antenna port.
9. Repeat step 7 to step 8 for another polarization.
10. $EIRP \text{ (dBm)} = S.G. \text{ Power} - Tx \text{ Cable Loss} + Tx \text{ Antenna Gain}$
11. $ERP \text{ (dBm)} = EIRP - 2.15$

3.6.4 Test Setup

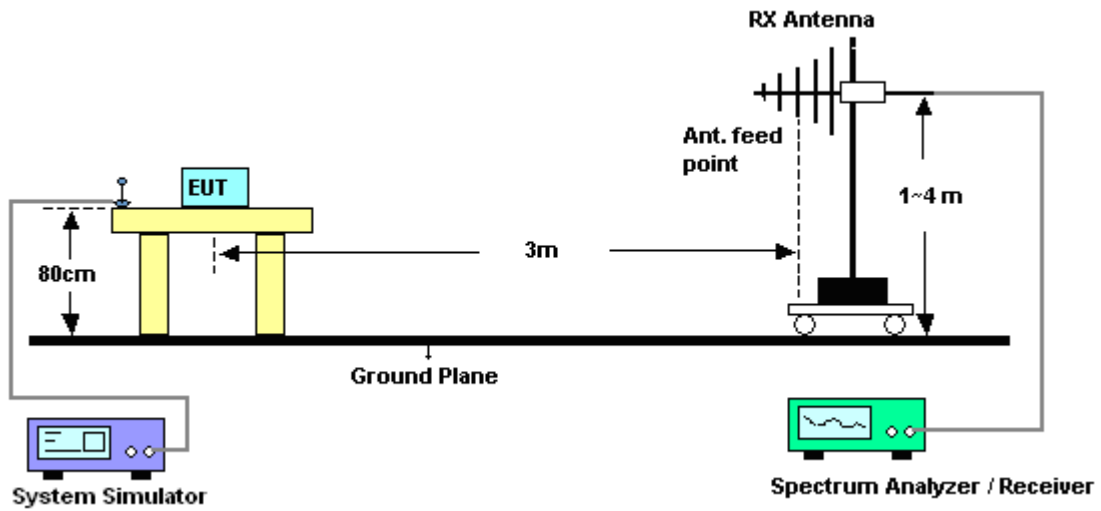



3.6.5 Test Result of Field Strength of Spurious Radiated

Band :	GSM850	Temperature :	23~24°C
Test Mode :	GPRS 8 Link	Relative Humidity :	44~46%
Test Engineer :	David Yang	Polarization :	Horizontal
Remark :	Spurious emissions within 30-1000MHz were found more than 20dB below limit line.		

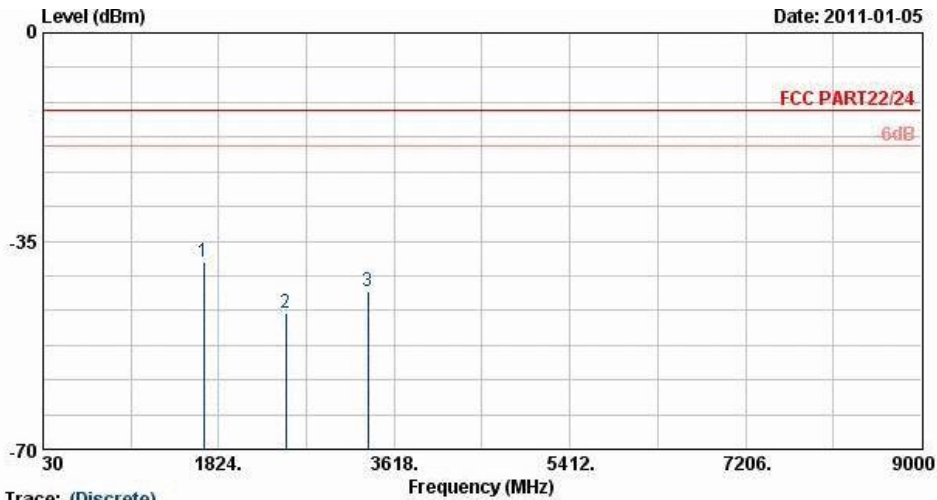

Trace: (Discrete)
 Site : 03CH07-HY
 Condition : FCC PART22/24 HF-ETRP(080306) HORIZONTAL
 Project : FG 0D0904

Frequency (MHz)	ERP (dBm)	Limit (dBm)	Over Limit (dB)	SPA Reading (dBm)	S.G. Power (dBm)	TX Cable loss (dB)	TX Antenna Gain (dBi)	Polarization (H/V)	Result
1669	-38.46	-13	-25.46	-47.4	-40.18	1.62	5.49	H	Pass
2509	-47.08	-13	-34.08	-59.22	-49.05	2.1	6.22	H	Pass
3346	-43.42	-13	-30.42	-57.57	-46.31	3.03	8.07	H	Pass



Band :	GSM850	Temperature :	23~24°C
Test Mode :	GPRS 8 Link	Relative Humidity :	44~46%
Test Engineer :	David Yang	Polarization :	Vertical
Remark :	Spurious emissions within 30-1000MHz were found more than 20dB below limit line.		

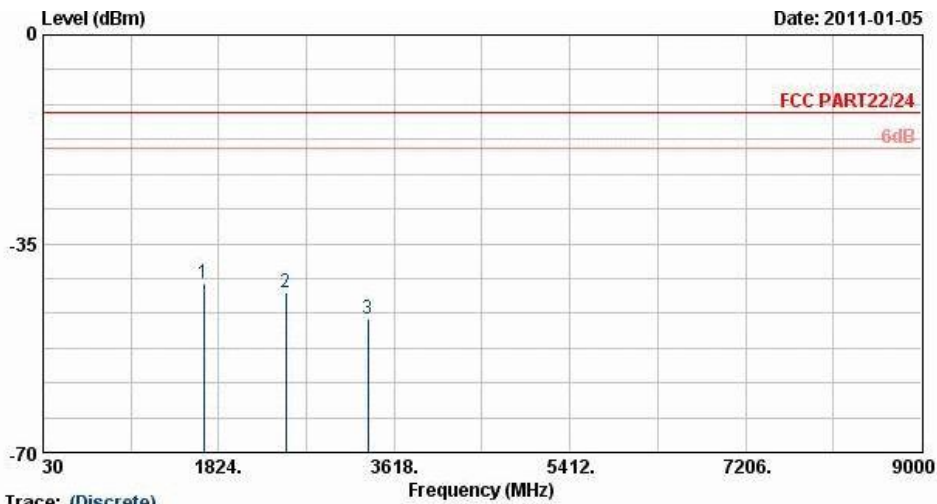

Trace: (Discrete)
 Site : 03CH07-HY
 Condition : FCC PART22/24 HF-ETRP(080306) VERTICAL
 Project : FG 0D0904

Frequency (MHz)	ERP (dBm)	Limit (dBm)	Over Limit (dB)	SPA Reading (dBm)	S.G. Power (dBm)	TX Cable loss (dB)	TX Antenna Gain (dBi)	Polarization (H/V)	Result
1669	-41.68	-13	-28.68	-52.55	-43.4	1.62	5.49	V	Pass
2509	-43.29	-13	-30.29	-55.48	-45.26	2.1	6.22	V	Pass
3346	-47.61	-13	-34.61	-62.07	-50.5	3.03	8.07	V	Pass



Band :	GSM850	Temperature :	23~24°C
Test Mode :	EDGE 8 Link	Relative Humidity :	44~46%
Test Engineer :	David Yang	Polarization :	Horizontal
Remark :	Spurious emissions within 30-1000MHz were found more than 20dB below limit line.		

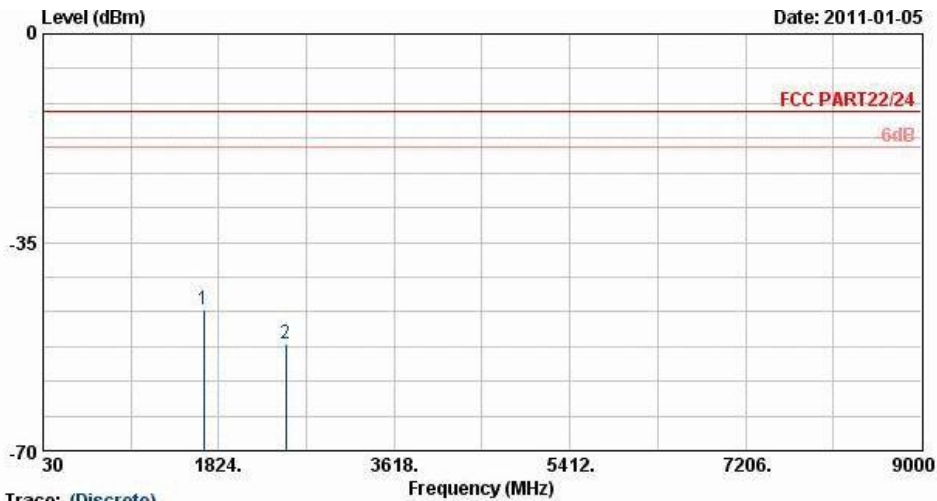

Trace: (Discrete)
 Site : 03CH07-HY
 Condition : FCC PART22/24 HF-ETRP(080306) HORIZONTAL
 Project : RG 000904

Frequency (MHz)	ERP (dBm)	Limit (dBm)	Over Limit (dB)	SPA Reading (dBm)	S.G. Power (dBm)	TX Cable loss (dB)	TX Antenna Gain (dBi)	Polarization (H/V)	Result
1669	-46.37	-13	-33.37	-53.26	-48.09	1.62	5.49	H	Pass
2506	-52.14	-13	-39.14	-64.24	-54.11	2.1	6.22	H	Pass



Band :	GSM850	Temperature :	23~24°C
Test Mode :	EDGE 8 Link	Relative Humidity :	44~46%
Test Engineer :	David Yang	Polarization :	Vertical
Remark :	Spurious emissions within 30-1000MHz were found more than 20dB below limit line.		

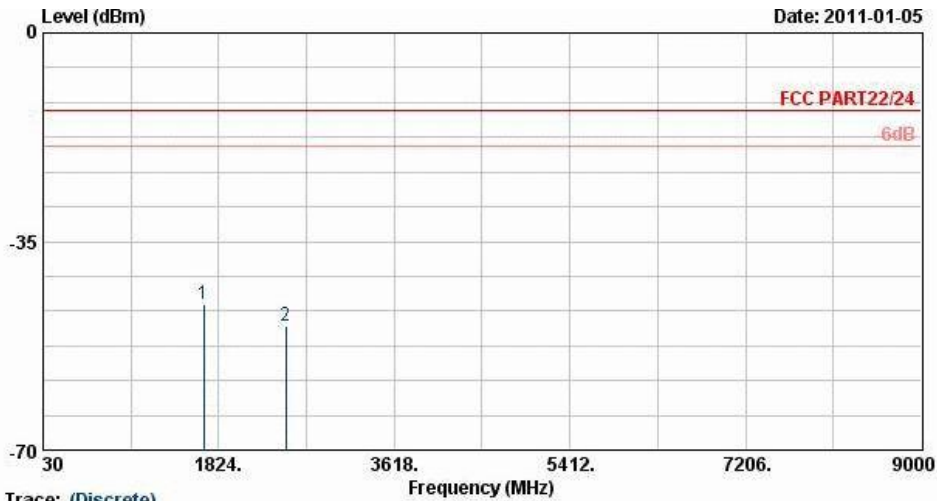

Trace: (Discrete)
 Site : 03CH07-HY
 Condition : FCC PART22/24 HF-ETRP(080306) VERTICAL
 Project : FG 0D0904

Frequency (MHz)	ERP (dBm)	Limit (dBm)	Over Limit (dB)	SPA Reading (dBm)	S.G. Power (dBm)	TX Cable loss (dB)	TX Antenna Gain (dBi)	Polarization (H/V)	Result
1669	-45.63	-13	-32.63	-56.05	-47.35	1.62	5.49	V	Pass
2509	-49.30	-13	-36.30	-63.29	-51.27	2.1	6.22	V	Pass



Band :	GSM1900	Temperature :	23~24°C
Test Mode :	GPRS 8 Link	Relative Humidity :	44~46%
Test Engineer :	David Yang	Polarization :	Horizontal
Remark :	Spurious emissions within 30-1000MHz were found more than 20dB below limit line.		

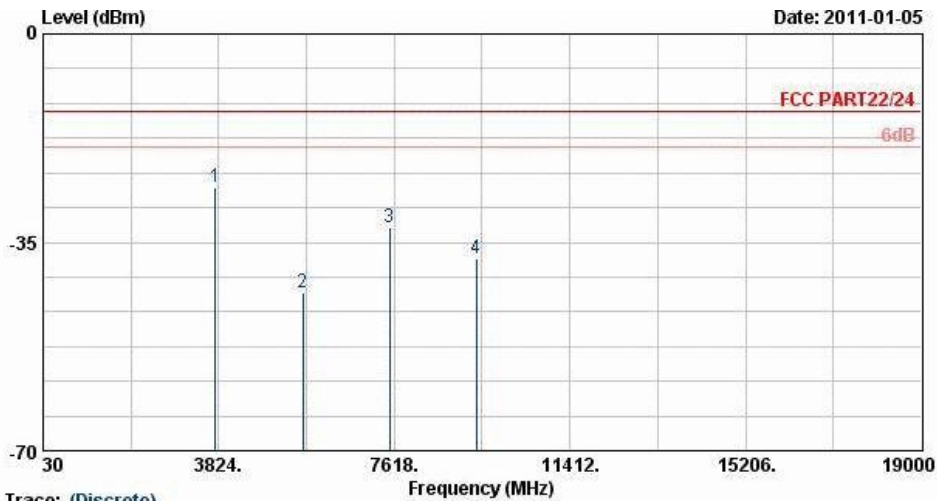

Trace: (Discrete)
 Site : 03CH07-HY
 Condition : FCC PART22/24 HF-ETRP(080306) HORIZONTAL
 Project : RG 000904

Frequency (MHz)	EIRP (dBm)	Limit (dBm)	Over Limit (dB)	SPA Reading (dBm)	S.G. Power (dBm)	TX Cable loss (dB)	TX Antenna Gain (dBi)	Polarization (H/V)	Result
3760	-25.89	-13	-12.89	-40.87	-32.19	2.51	8.81	H	Pass
5636	-43.53	-13	-30.53	-64.39	-51.24	2.99	10.70	H	Pass
7520	-32.53	-13	-19.53	-57.63	-41.06	3.59	12.12	H	Pass
9396	-37.72	-13	-24.72	-62.77	-46.82	4.1	13.20	H	Pass



Band :	GSM1900	Temperature :	23~24°C
Test Mode :	GPRS 8 Link	Relative Humidity :	44~46%
Test Engineer :	David Yang	Polarization :	Vertical
Remark :	Spurious emissions within 30-1000MHz were found more than 20dB below limit line.		

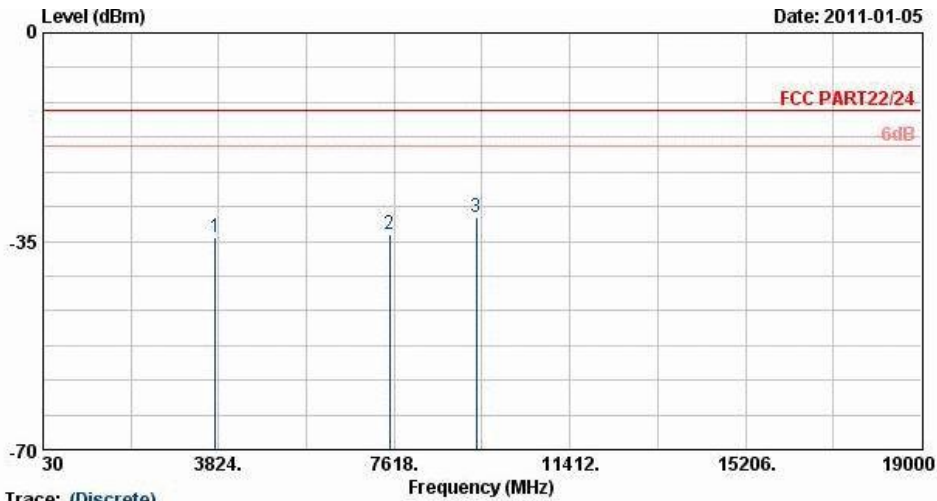

Trace: (Discrete)
 Site : 03CH07-HY
 Condition : FCC PART22/24 HF-EIRP(080306) VERTICAL
 Project : FG 0D0904

Frequency (MHz)	EIRP (dBm)	Limit (dBm)	Over Limit (dB)	SPA Reading (dBm)	S.G. Power (dBm)	TX Cable loss (dB)	TX Antenna Gain (dBi)	Polarization (H/V)	Result
3760	-34.39	-13	-21.39	-48.32	-40.69	2.51	8.81	V	Pass
7520	-33.83	-13	-20.83	-58.31	-42.36	3.59	12.12	V	Pass
9396	-31.02	-13	-18.02	-55.73	-40.12	4.1	13.20	V	Pass



Band :	GSM1900	Temperature :	23~24°C
Test Mode :	EDGE 8 Link	Relative Humidity :	44~46%
Test Engineer :	David Yang	Polarization :	Horizontal
Remark :	Spurious emissions within 30-1000MHz were found more than 20dB below limit line.		

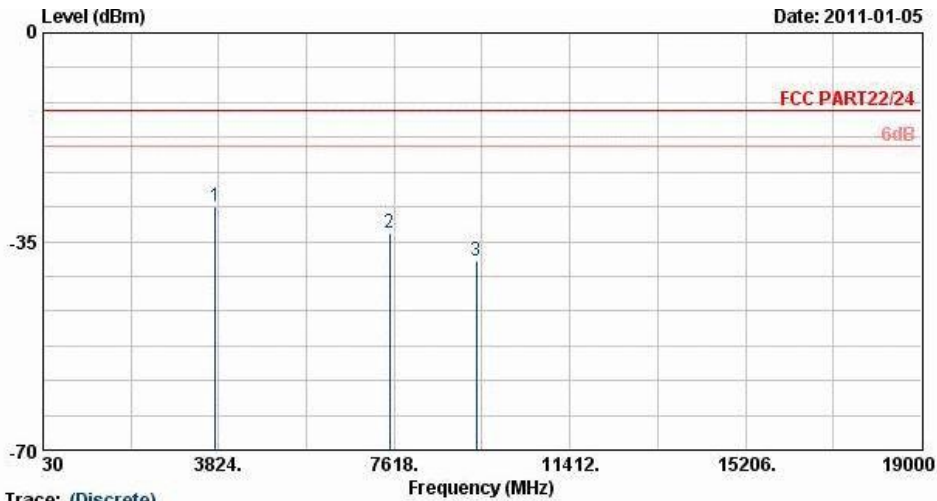

Trace: (Discrete)
 Site : 03CH07-HY
 Condition : FCC PART22/24 HF-ETRP(080306) HORIZONTAL
 Project : FG 0D0904

Frequency (MHz)	EIRP (dBm)	Limit (dBm)	Over Limit (dB)	SPA Reading (dBm)	S.G. Power (dBm)	TX Cable loss (dB)	TX Antenna Gain (dBi)	Polarization (H/V)	Result
3760	-29.13	-13	-16.13	-43.35	-35.43	2.51	8.81	H	Pass
7520	-33.60	-13	-20.60	-60.65	-42.13	3.59	12.12	H	Pass
9396	-38.31	-13	-25.31	-62.84	-47.41	4.1	13.20	H	Pass



Band :	GSM1900	Temperature :	23~24°C
Test Mode :	EDGE 8 Link	Relative Humidity :	44~46%
Test Engineer :	David Yang	Polarization :	Vertical
Remark :	Spurious emissions within 30-1000MHz were found more than 20dB below limit line.		

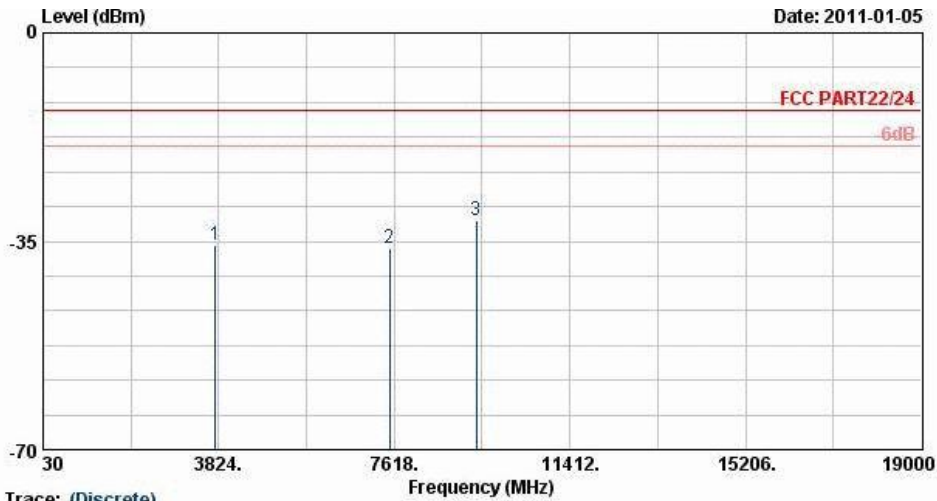

Trace: (Discrete)
 Site : 03CH07-HY
 Condition : FCC PART22/24 HF-ETRP(080306) VERTICAL
 Project : FG 0D0904

Frequency (MHz)	EIRP (dBm)	Limit (dBm)	Over Limit (dB)	SPA Reading (dBm)	S.G. Power (dBm)	TX Cable loss (dB)	TX Antenna Gain (dBi)	Polarization (H/V)	Result
3760	-35.72	-13	-22.72	-50.82	-42.02	2.51	8.81	V	Pass
7520	-36.08	-13	-23.08	-61.61	-44.61	3.59	12.12	V	Pass
9396	-31.48	-13	-18.48	-57.17	-40.58	4.1	13.20	V	Pass



Band :	WCDMA Band V	Temperature :	23~24°C
Test Mode :	RMC 12.2Kbps Link	Relative Humidity :	44~46%
Test Engineer :	David Yang	Polarization :	Horizontal
Remark :	Spurious emissions within 30-1000MHz were found more than 20dB below limit line.		

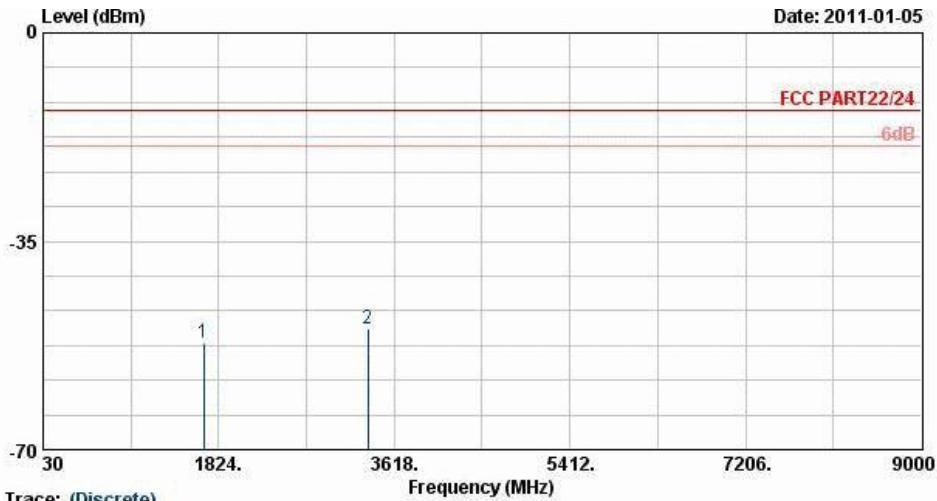

Site : 03CH07-HY
 Condition : FCC PART22/24 HF-ETRP(080306) HORIZONTAL
 Project : FG 0D0904

Frequency (MHz)	ERP (dBm)	Limit (dBm)	Over Limit (dB)	SPA Reading (dBm)	S.G. Power (dBm)	TX Cable loss (dB)	TX Antenna Gain (dBi)	Polarization (H/V)	Result
1669	-51.99	-13	-38.99	-59.3	-53.71	1.62	5.49	H	Pass
3346	-49.60	-13	-36.60	-62.97	-52.49	3.03	8.07	H	Pass



Band :	WCDMA Band V	Temperature :	23~24°C
Test Mode :	RMC 12.2Kbps Link	Relative Humidity :	44~46%
Test Engineer :	David Yang	Polarization :	Vertical
Remark :	Spurious emissions within 30-1000MHz were found more than 20dB below limit line.		

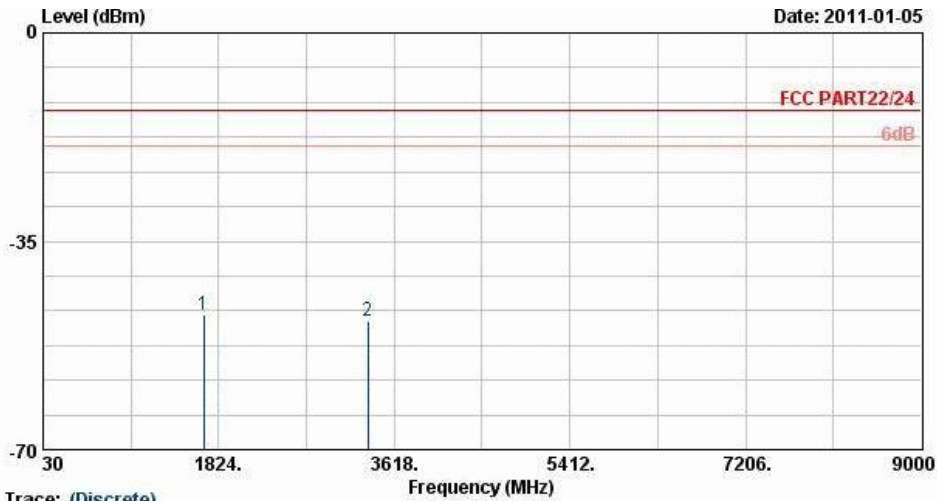

Trace: (Discrete)
 Site : 03CH07-HY
 Condition : FCC PART22/24 HF-ETRP(080306) VERTICAL
 Project : FG 0D0904

Frequency (MHz)	ERP (dBm)	Limit (dBm)	Over Limit (dB)	SPA Reading (dBm)	S.G. Power (dBm)	TX Cable loss (dB)	TX Antenna Gain (dBi)	Polarization (H/V)	Result
1669	-47.33	-13	-34.33	-56.58	-49.05	1.62	5.49	V	Pass
3349	-48.37	-13	-35.37	-63.21	-51.26	3.03	8.07	V	Pass



Band :	WCDMA Band IV	Temperature :	23~24°C
Test Mode :	RMC 12.2Kbps Link	Relative Humidity :	44~46%
Test Engineer :	David Yang	Polarization :	Horizontal
Remark :	Spurious emissions within 30-1000MHz were found more than 20dB below limit line.		

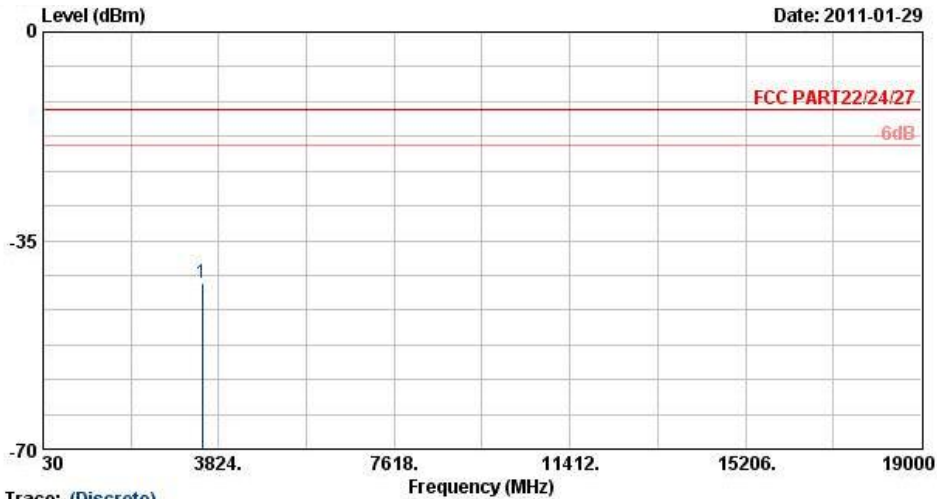

Trace: (Discrete)
 Site : 03CH07-HY
 Condition : FCC PART22/24/27 HF-ETRP(060306) HORIZONTAL
 Project : FC 0D0904

Frequency (MHz)	EIRP (dBm)	Limit (dBm)	Over Limit (dB)	SPA Reading (dBm)	S.G. Power (dBm)	TX Cable loss (dB)	TX Antenna Gain (dBi)	Polarization (H/V)	Result
3460	-42.22	-13	-29.22	-56.31	-46.05	4.48	8.31	H	Pass



Band :	WCDMA Band IV	Temperature :	23~24°C
Test Mode :	RMC 12.2Kbps Link	Relative Humidity :	44~46%
Test Engineer :	David Yang	Polarization :	Vertical
Remark :	Spurious emissions within 30-1000MHz were found more than 20dB below limit line.		

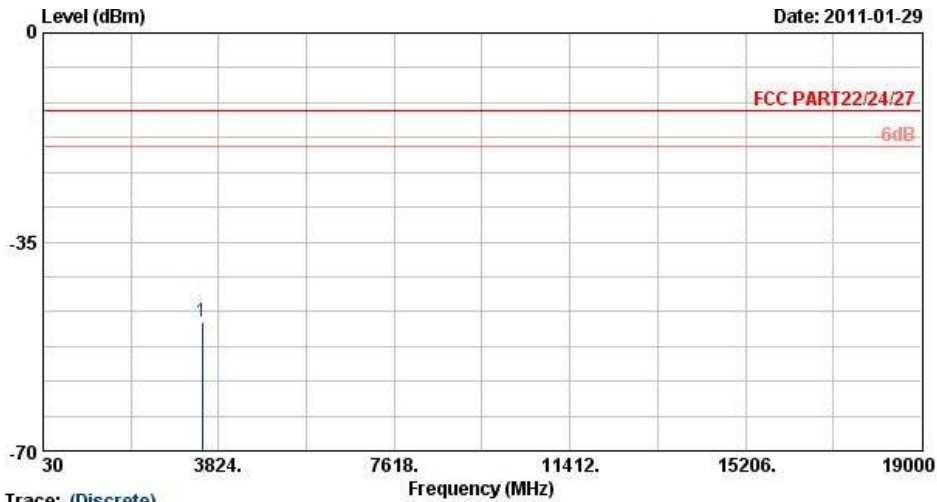

Trace: (Discrete)
 Site : 08CH07-HY
 Condition : FCC PART22/24/27 HF-ETRP(060306) VERTICAL
 Project : FG 0D0904

Frequency (MHz)	EIRP (dBm)	Limit (dBm)	Over Limit (dB)	SPA Reading (dBm)	S.G. Power (dBm)	TX Cable loss (dB)	TX Antenna Gain (dBi)	Polarization (H/V)	Result
3460	-48.30	-13	-35.30	-63.72	-52.13	4.48	8.31	V	Pass



Band :	WCDMA Band II	Temperature :	23~24°C
Test Mode :	RMC 12.2Kbps Link	Relative Humidity :	44~46%
Test Engineer :	David Yang	Polarization :	Horizontal
Remark :	Spurious emissions within 30-1000MHz were found more than 20dB below limit line.		

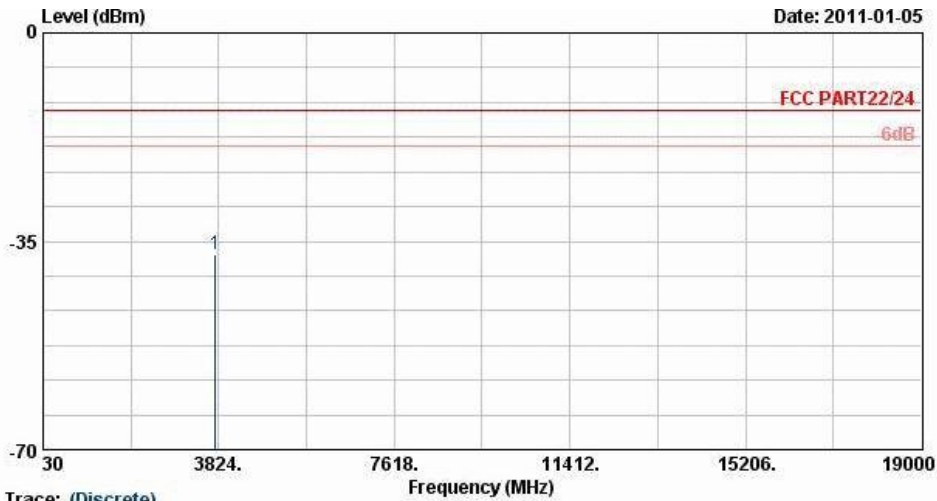

Trace: (Discrete)
 Site : 03CH07-HY
 Condition : FCC PART22/24 HF-ETRP(080306) HORIZONTAL
 Project : FG 0D0904

Frequency (MHz)	EIRP (dBm)	Limit (dBm)	Over Limit (dB)	SPA Reading (dBm)	S.G. Power (dBm)	TX Cable loss (dB)	TX Antenna Gain (dBi)	Polarization (H/V)	Result
3760	-37.28	-13	-24.28	-51.9	-43.58	2.51	8.81	H	Pass



Band :	WCDMA Band II	Temperature :	23~24°C
Test Mode :	RMC 12.2Kbps Link	Relative Humidity :	44~46%
Test Engineer :	David Yang	Polarization :	Vertical
Remark :	Spurious emissions within 30-1000MHz were found more than 20dB below limit line.		

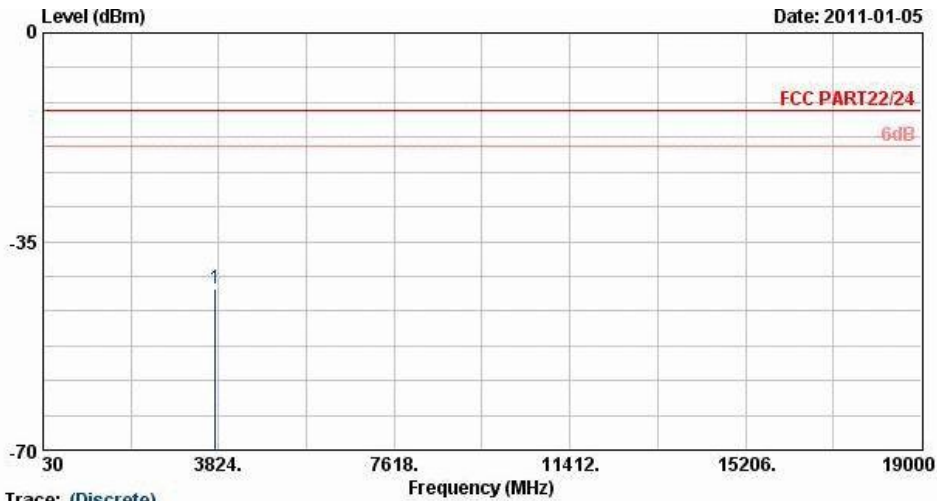

Trace: (Discrete)
 Site : 03CH07-HY
 Condition : FCC PART22/24 HF-ETRP(080306) VERTICAL
 Project : FG 0D0904

Frequency (MHz)	EIRP (dBm)	Limit (dBm)	Over Limit (dB)	SPA Reading (dBm)	S.G. Power (dBm)	TX Cable loss (dB)	TX Antenna Gain (dBi)	Polarization (H/V)	Result
3760	-42.92	-13	-29.92	-59.1	-49.22	2.51	8.81	V	Pass



Band :	CDMA2000 BC0	Temperature :	23~24°C
Test Mode :	1xEV-DO Rev. A_RETAP 4096K	Relative Humidity :	44~46%
Test Engineer :	David Yang	Polarization :	Horizontal
Remark :	Spurious emissions within 30-1000MHz were found more than 20dB below limit line.		

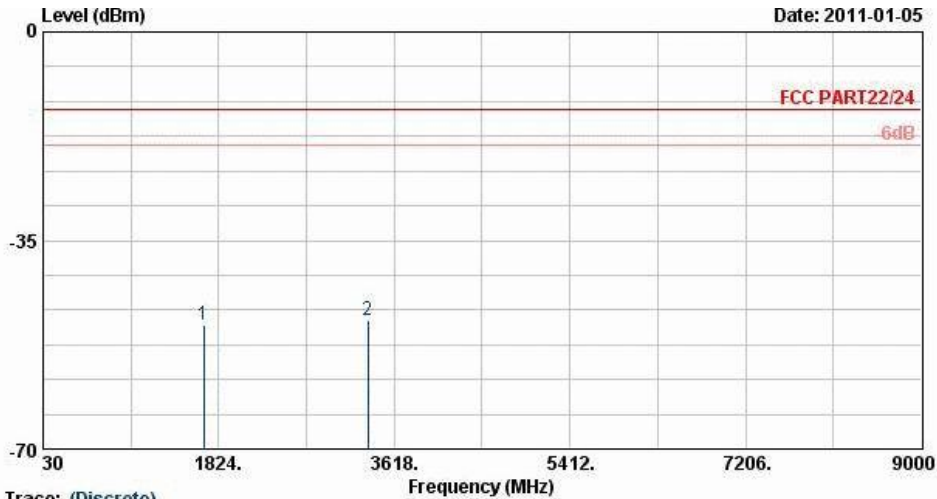

Trace: (Discrete)
 Site : 03CH07-HY
 Condition : FCC PART22/24 HF-ETRP(080306) HORIZONTAL
 Project : FG 0D0904

Frequency (MHz)	ERP (dBm)	Limit (dBm)	Over Limit (dB)	SPA Reading (dBm)	S.G. Power (dBm)	TX Cable loss (dB)	TX Antenna Gain (dBi)	Polarization (H/V)	Result
1669	-49.12	-13	-36.12	-57.47	-50.84	1.62	5.49	H	Pass
3346	-48.44	-13	-35.44	-62.52	-51.33	3.03	8.07	H	Pass



Band :	CDMA2000 BC0	Temperature :	23~24°C
Test Mode :	1xEV-DO Rev. A_RETAP 4096K	Relative Humidity :	44~46%
Test Engineer :	David Yang	Polarization :	Vertical
Remark :	Spurious emissions within 30-1000MHz were found more than 20dB below limit line.		

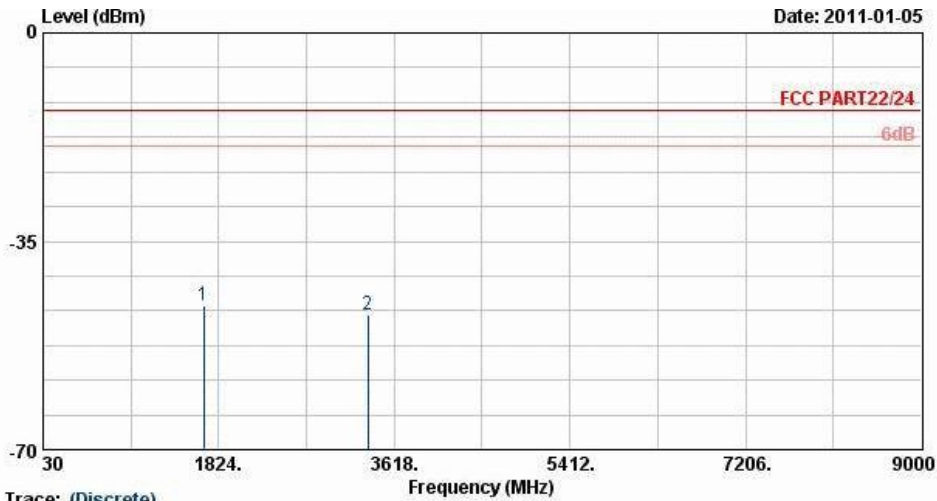

Trace: (Discrete)
 Site : 03CH07-HY
 Condition : FCC PART22/24 HF-ETRP(080306) VERTICAL
 Project : FG 0D0904

Frequency (MHz)	ERP (dBm)	Limit (dBm)	Over Limit (dB)	SPA Reading (dBm)	S.G. Power (dBm)	TX Cable loss (dB)	TX Antenna Gain (dBi)	Polarization (H/V)	Result
1669	-45.90	-13	-32.90	-55.21	-47.62	1.62	5.49	V	Pass
3346	-47.24	-13	-34.24	-62.05	-50.13	3.03	8.07	V	Pass



Band :	CDMA2000 BC1	Temperature :	23~24°C
Test Mode :	1xRTT_RC3+SO55	Relative Humidity :	44~46%
Test Engineer :	David Yang	Polarization :	Horizontal
Remark :	Spurious emissions within 30-1000MHz were found more than 20dB below limit line.		

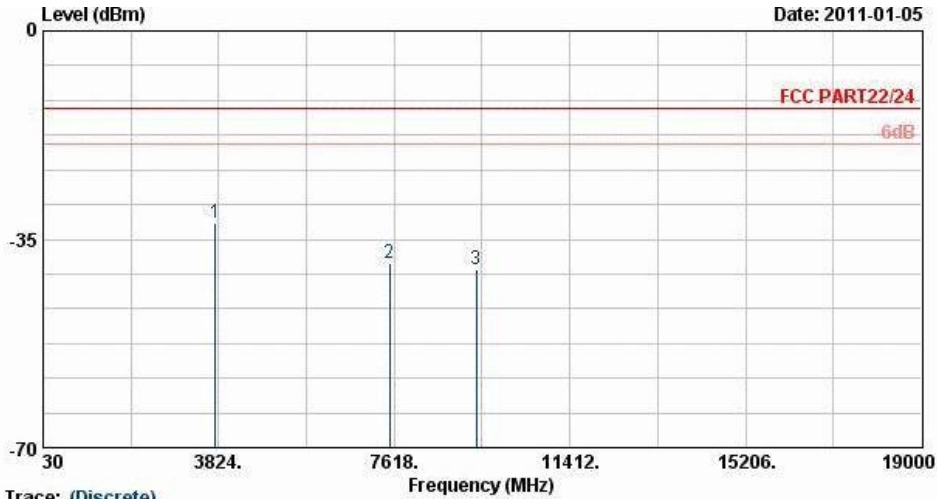

Trace: (Discrete)
 Site : 03CH07-HY
 Condition : FCC PART22/24 HF-ETRP(080306) HORIZONTAL
 Project : FG 0D0904

Frequency (MHz)	EIRP (dBm)	Limit (dBm)	Over Limit (dB)	SPA Reading (dBm)	S.G. Power (dBm)	TX Cable loss (dB)	TX Antenna Gain (dBi)	Polarization (H/V)	Result
3760	-32.31	-13	-19.31	-46.53	-38.61	2.51	8.81	H	Pass
7520	-38.99	-13	-25.99	-64.95	-47.52	3.59	12.12	H	Pass
9396	-40.01	-13	-27.01	-64.8	-49.11	4.1	13.20	H	Pass



Band :	CDMA2000 BC1	Temperature :	23~24°C
Test Mode :	1xRTT_RC3+SO55	Relative Humidity :	44~46%
Test Engineer :	David Yang	Polarization :	Vertical
Remark :	Spurious emissions within 30-1000MHz were found more than 20dB below limit line.		

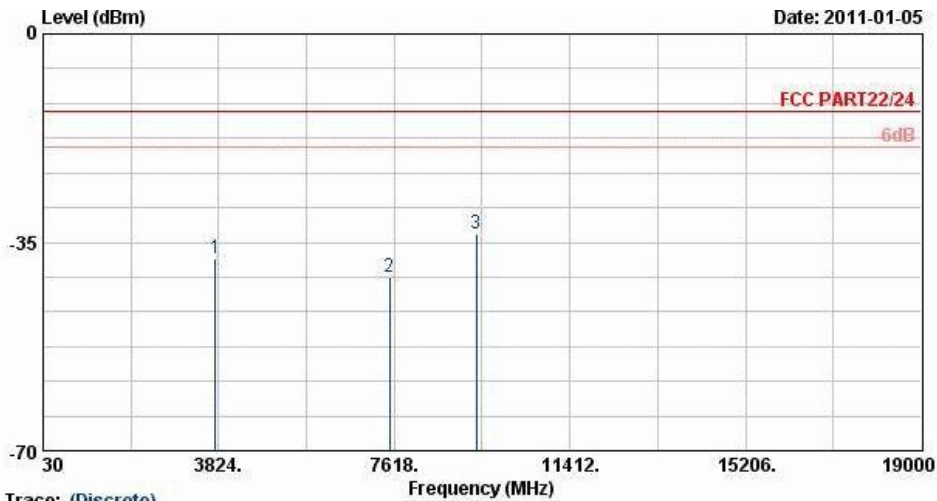

Trace: (Discrete)
 Site : 03CH07-HY
 Condition : FCC PART22/24 HF-ETRP(080306) VERTICAL
 Project : FG 0D0904

Frequency (MHz)	EIRP (dBm)	Limit (dBm)	Over Limit (dB)	SPA Reading (dBm)	S.G. Power (dBm)	TX Cable loss (dB)	TX Antenna Gain (dBi)	Polarization (H/V)	Result
3760	-37.73	-13	-24.73	-52.59	-44.03	2.51	8.81	V	Pass
7520	-40.75	-13	-27.75	-65.57	-49.28	3.59	12.12	V	Pass
9396	-33.61	-13	-20.61	-59.47	-42.71	4.1	13.20	V	Pass

3.7 Frequency Stability Measurement

3.7.1 Description of Frequency Stability Measurement

The frequency stability shall be measured by variation of ambient temperature and variation of primary supply voltage to ensure that the fundamental emission stays within the authorized frequency block. The frequency stability of the transmitter shall be maintained within $\pm 0.00025\%$ ($\pm 2.5\text{ppm}$) of the center frequency.

3.7.2 Measuring Instruments

See list of measuring instruments of this test report.

3.7.3 Test Procedures for Temperature Variation

1. The EUT was set up in the thermal chamber and connected with the base station.
2. With power OFF, the temperature was decreased to -30°C and the EUT was stabilized for three hours. Power was applied and the maximum change in frequency was recorded within one minute.
3. With power OFF, the temperature was raised in 10°C step up to 50°C . The EUT was stabilized at each step for at least half an hour. Power was applied and the maximum frequency change was recorded within one minute.
4. If the EUT can not be turned on at -30°C , the testing lowest temperature will be raised in 10°C step until the EUT can be turned on.

3.7.4 Test Procedures for Voltage Variation

1. The EUT was placed in a temperature chamber at $25\pm 5^{\circ}\text{C}$ and connected with the base station.
2. The power supply voltage to the EUT was varied from BEP to 115% of the nominal value measured at the input to the EUT.
3. The variation in frequency was measured for the worst case.

3.7.5 Test Setup

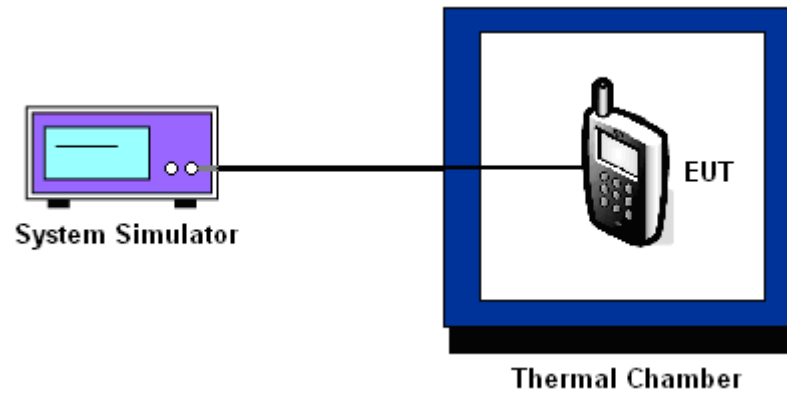



3.7.6 Test Result of Temperature Variation

Band :	GSM 850	Channel :	189
Limit (ppm) :	2.5		

Temperature (°C)	GPRS 8		EDGE 8		Result
	Freq. Dev. (Hz)	Deviation (ppm)	Freq. Dev. (Hz)	Deviation (ppm)	
-30	N/A	N/A	N/A	N/A	PASS
-20	N/A	N/A	N/A	N/A	
-10	15	0.02	-30	-0.04	
0	26	0.03	57	0.07	
10	12	0.01	55	0.06	
20	15	0.02	48	0.06	
30	-17	-0.02	14	0.02	
40	-21	-0.02	30	0.04	
50	-19	-0.02	-36	-0.04	

Band :	GSM 1900	Channel :	661
Limit (ppm) :	2.5		

Temperature (°C)	GPRS 8		EDGE 8		Result
	Freq. Dev. (Hz)	Deviation (ppm)	Freq. Dev. (Hz)	Deviation (ppm)	
-30	N/A	N/A	N/A	N/A	PASS
-20	N/A	N/A	N/A	N/A	
-10	46	0.02	37	0.02	
0	61	0.03	75	0.04	
10	55	0.03	95	0.05	
20	48	0.03	98	0.05	
30	19	0.01	22	0.01	
40	22	0.01	24	0.01	
50	26	0.01	62	0.03	

Note:

1. The EUT stops transmitting at temperatures -20°C and -30°C.
2. The manufacturer declared that the EUT could work properly between temperatures -10°C~50°C.



Band :	WCDMA Band V	Channel :	4182
Limit (ppm) :	2.5		

Temperature (°C)	RMC 12.2Kbps		Result
	Freq. Dev. (Hz)	Deviation (ppm)	
-30	N/A	N/A	PASS
-20	N/A	N/A	
-10	-15	-0.02	
0	-12	-0.01	
10	13	0.02	
20	-16	-0.02	
30	20	0.02	
40	-18	-0.02	
50	-22	-0.03	

Band :	WCDMA Band IV	Channel :	1413
Limit (ppm) :	2.5		

Temperature (°C)	RMC 12.2Kbps		Result
	Freq. Dev. (Hz)	Deviation (ppm)	
-30	N/A	N/A	PASS
-20	N/A	N/A	
-10	17	0.01	
0	-16	-0.01	
10	22	0.01	
20	26	0.02	
30	24	0.01	
40	-19	-0.01	
50	-29	-0.02	

Note:

1. The EUT stops transmitting at temperatures -20°C and -30°C.
2. The manufacturer declared that the EUT could work properly between temperatures -10°C~50°C.



Band :	WCDMA Band II	Channel :	9400
Limit (ppm) :	2.5		

Temperature (°C)	RMC 12.2Kbps		Result
	Freq. Dev. (Hz)	Deviation (ppm)	
-30	N/A	N/A	PASS
-20	N/A	N/A	
-10	31	0.02	
0	34	0.02	
10	35	0.02	
20	-22	-0.01	
30	36	0.02	
40	41	0.02	
50	-32	-0.02	

Note:

1. The EUT stops transmitting at temperatures -20°C and -30°C.
2. The manufacturer declared that the EUT could work properly between temperatures -10°C~50°C.



Band :	CDMA2000 BC0	Channel :	384
Test Mode :	1xEV-DO Rev. A_RETAP 4096K	Limit (ppm) :	2.5

Temperature (°C)	Freq. Dev. (Hz)	Deviation (ppm)	Result
-30	N/A	N/A	PASS
-20	N/A	N/A	
-10	-10	-0.01	
0	19	0.02	
10	-18	-0.02	
20	17	0.02	
30	-18	-0.02	
40	27	0.03	
50	20	0.02	

Band :	CDMA2000 BC1	Channel :	600
Test Mode :	1xRTT_RC3+SO55	Limit (ppm) :	2.5

Temperature (°C)	Freq. Dev. (Hz)	Deviation (ppm)	Result
-30	N/A	N/A	PASS
-20	N/A	N/A	
-10	17	0.01	
0	-16	-0.01	
10	11	0.01	
20	16	0.01	
30	-19	-0.01	
40	17	0.01	
50	-20	-0.01	

Note:

1. The EUT stops transmitting at temperatures -20°C and -30°C.
2. The manufacturer declared that the EUT could work properly between temperatures -10°C~50°C.



3.7.7 Test Result of Voltage Variation

Band & Channel	Mode	Voltage (Volt)	Freq. Dev. (Hz)	Deviation (ppm)	Limit (ppm)	Result
GSM 850 CH189	GPRS 8	3.7	-22	-0.03	2.5	PASS
		BEP	-17	-0.02		
		4.2	-15	-0.02		
	EDGE 8	3.7	31	0.04		
		BEP	35	0.04		
		4.2	34	0.04		
GSM 1900 CH661	GPRS 8	3.7	21	0.01		
		BEP	16	0.01		
		4.2	22	0.01		
	EDGE 8	3.7	-23	-0.01		
		BEP	-18	-0.01		
		4.2	15	0.01		
WCDMA Band V CH4182	RMC 12.2Kbps	3.7	-17	-0.02		
		BEP	-12	-0.01		
		4.2	-14	-0.02		
WCDMA Band IV CH1413	RMC 12.2Kbps	3.7	26	0.02		
		BEP	-22	-0.01		
		4.2	34	0.02		
WCDMA Band II CH9400	RMC 12.2Kbps	3.7	22	0.01		
		BEP	-22	-0.01		
		4.2	27	0.01		
CDMA2000 BC0 CH384	1xEV-DO Rev. A RETAP 4096K	3.7	-22	-0.03		
		BEP	24	0.03		
		4.2	21	0.02		
CDMA2000 BC1 CH600	1xRTT RC3+SO55	3.7	-17	-0.01		
		BEP	-18	-0.01		
		4.2	-24	-0.01		

Note:

1. Normal Voltage = 3.7V.
2. Battery End Point (BEP) = 3.4 V.



4 List of Measuring Equipment

Instrument	Manufacturer	Model No.	Serial No.	Characteristics	Calibration Date	Due Date	Remark
System Simulator	R&S	CMU200	117995	N/A	Mar. 19, 2009	Mar. 18, 2011	Conducted (TH02-HY)
Spectrum Analyzer	R&S	FSP30	101329	9kHz~30GHz	Apr. 26, 2010	Apr. 25, 2011	Conducted (TH02-HY)
Thermal Chamber	Ten Billion	TTH-D35P	TBN-930701	N/A	Jul. 30,2010	Jul. 29, 2011	Conducted (TH02-HY)
Bilog Antenna	SCHAFFNER	CBL6111C	2726	30MHz ~ 1GHz	Oct. 31, 2010	Oct. 30, 2011	Radiation (03CH07-HY)
Spectrum Analyzer	R&S	FSP	101067	9KHz ~ 30GHz	Dec. 03, 2010	Dec. 02, 2011	Radiation (03CH07-HY)
Double Ridge Horn Antenna	ESCO	3117	00075962	1GHz ~ 18GHz	Aug. 19, 2010	Aug. 18, 2011	Radiation (03CH07-HY)
SHF-EHF Horn Antenna	SCHWARZBECK	BBHA 9170	BBHA917025 1	15GHz- 40GHz	Oct. 18, 2010	Oct. 17, 2011	Radiation (03CH07-HY)
Pre Amplifier	Agilent	8449B	3008A02362	1GHz~ 26.5GHz	Dec. 06, 2010	Dec. 05, 2011	Radiation (03CH07-HY)
Pre Amplifier	COM-POWER	PA-103A	161241	10-1000MHz.32dB. GAIN	Mar. 27, 2010	Mar. 26, 2011	Radiation (03CH07-HY)
Loop Antenna	R&S	HFH2-Z2	860004/001	9 kHz~30 MHz	Jul. 29, 2010	Jul. 28, 2011	Radiation (03CH07-HY)
System Simulator	R&S	CMU200	117995	N/A	Mar. 19, 2009	Mar. 18, 2011	-

5 Uncertainty of Evaluation

Uncertainty of Radiated Emission Measurement (30 MHz ~ 1000 MHz)

Contribution	Uncertainty of X_i		$u(X_i)$
	dB	Probability Distribution	
Receiver Reading	0.41	Normal (k=2)	0.21
Antenna Factor Calibration	0.83	Normal (k=2)	0.42
Cable Loss Calibration	0.25	Normal (k=2)	0.13
Pre-Amplifier Gain Calibration	0.27	Normal (k=2)	0.14
RCV/SPA Specification	2.50	Rectangular	0.72
Antenna Factor Interpolation for Frequency	1.00	Rectangular	0.29
Site Imperfection	1.43	Rectangular	0.83
Mismatch	+0.39 / -0.41	U-Shape	0.28
Combined Standard Uncertainty $U_c(y)$	1.27		
Measuring Uncertainty for a Level of Confidence of 95% ($U = 2U_c(y)$)	2.54		

Uncertainty of Radiated Emission Measurement (1 GHz ~ 40 GHz)

Contribution	Uncertainty of X_i		$u(X_i)$	C_i	$C_i * u(X_i)$
	dB	Probability Distribution			
Receiver Reading	± 0.10	Normal (k=2)	0.10	1	0.10
Antenna Factor Calibration	± 1.70	Normal (k=2)	0.85	1	0.85
Cable Loss Calibration	± 0.50	Normal (k=2)	0.25	1	0.25
Receiver Correction	± 2.00	Rectangular	1.15	1	1.15
Antenna Factor Directional	± 1.50	Rectangular	0.87	1	0.87
Site Imperfection	± 2.80	Triangular	1.14	1	1.14
Mismatch Receiver VSWR $\Gamma_1 = 0.197$ Antenna VSWR $\Gamma_2 = 0.194$ Uncertainty = $20\text{Log}(1-\Gamma_1*\Gamma_2)$	+0.34 / -0.35	U-Shape	0.244	1	0.244
Combined Standard Uncertainty $U_c(y)$	2.36				
Measuring Uncertainty for a Level of Confidence of 95% ($U = 2U_c(y)$)	4.72				



Appendix A. Photographs of EUT

Please refer to Sporton report number EP0D0904-05 as below.



1. External Photograph of EUT



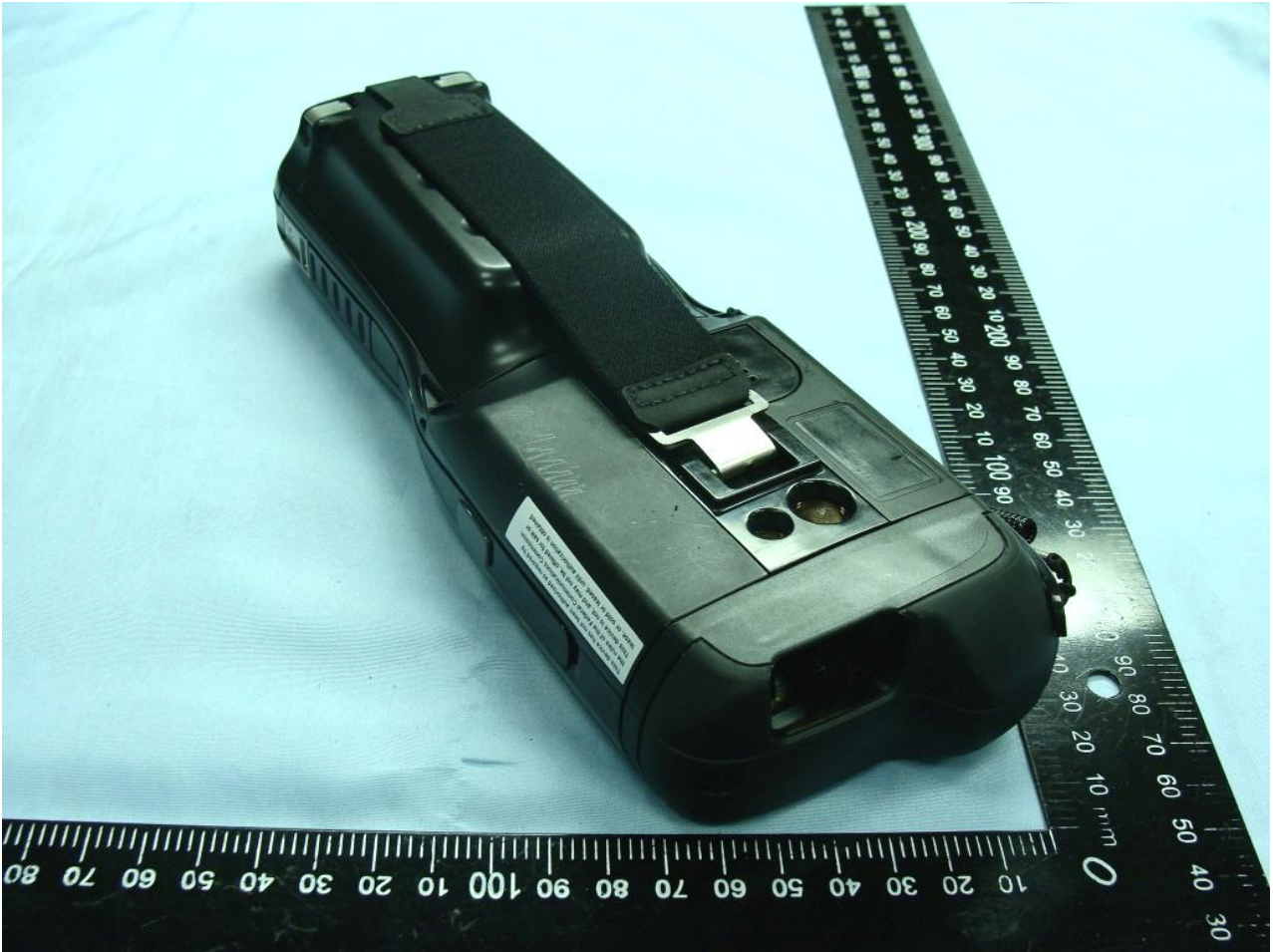



2. Photograph of Accessory

List of Accessory:

Specification of Accessory		
Battery	Brand Name	Honeywell
	Model Name	99EX-BTEC
Holster	Model Name	99EX-Holster
LCD Panel	Brand Name	Casio
	Model Name	OM37H3M04XLC
Camera	Brand Name	LITE-ON Semiconductor Corp.
	Model Name	DCM-300MCB
WWAN Module	Brand Name	Sierra wireless
	Model Name	Gobi3000

Remark: For accessories equipped with this EUT, please refer to the following photos.





3. Internal Photograph of EUT

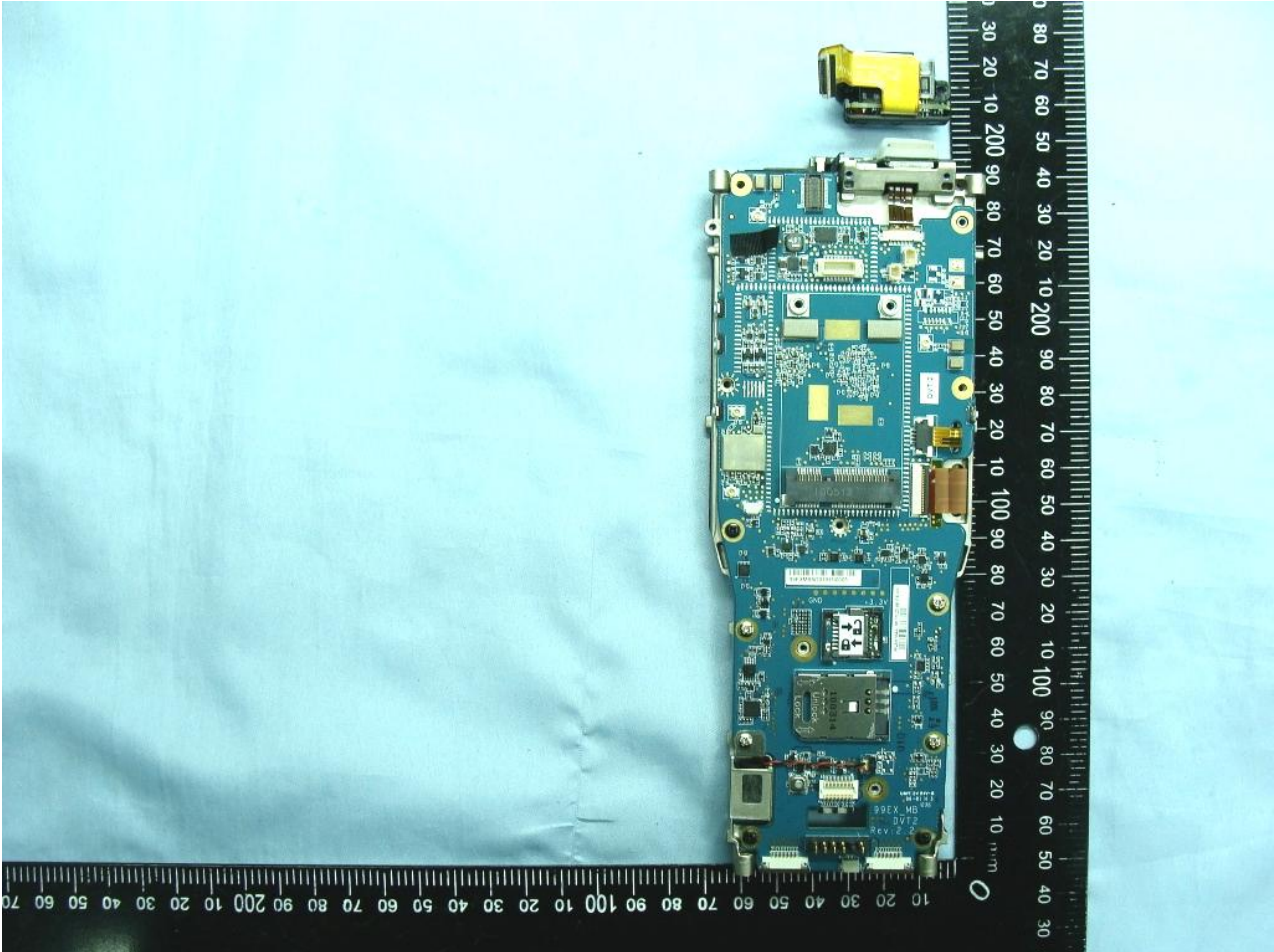

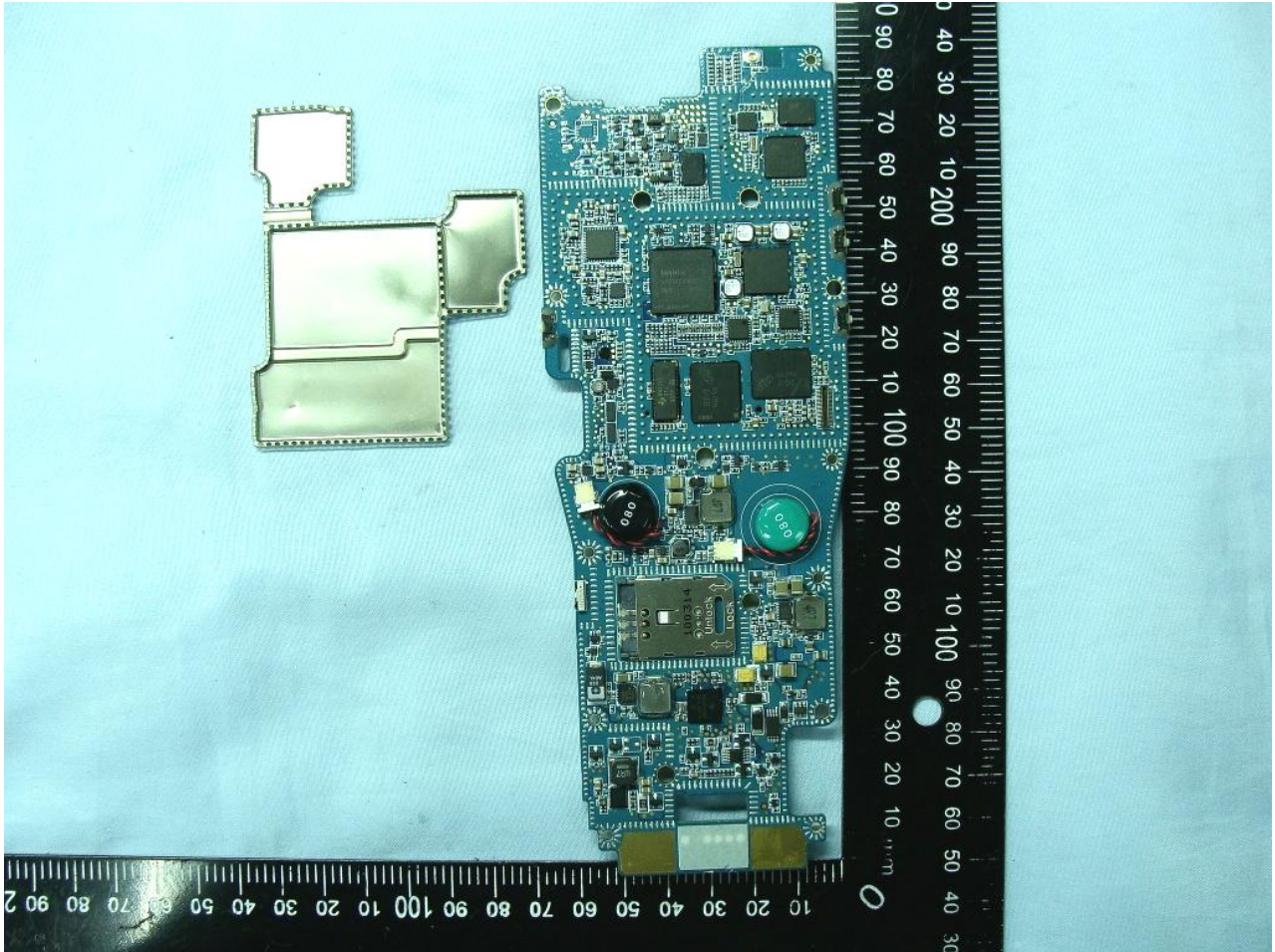

WWAN Module

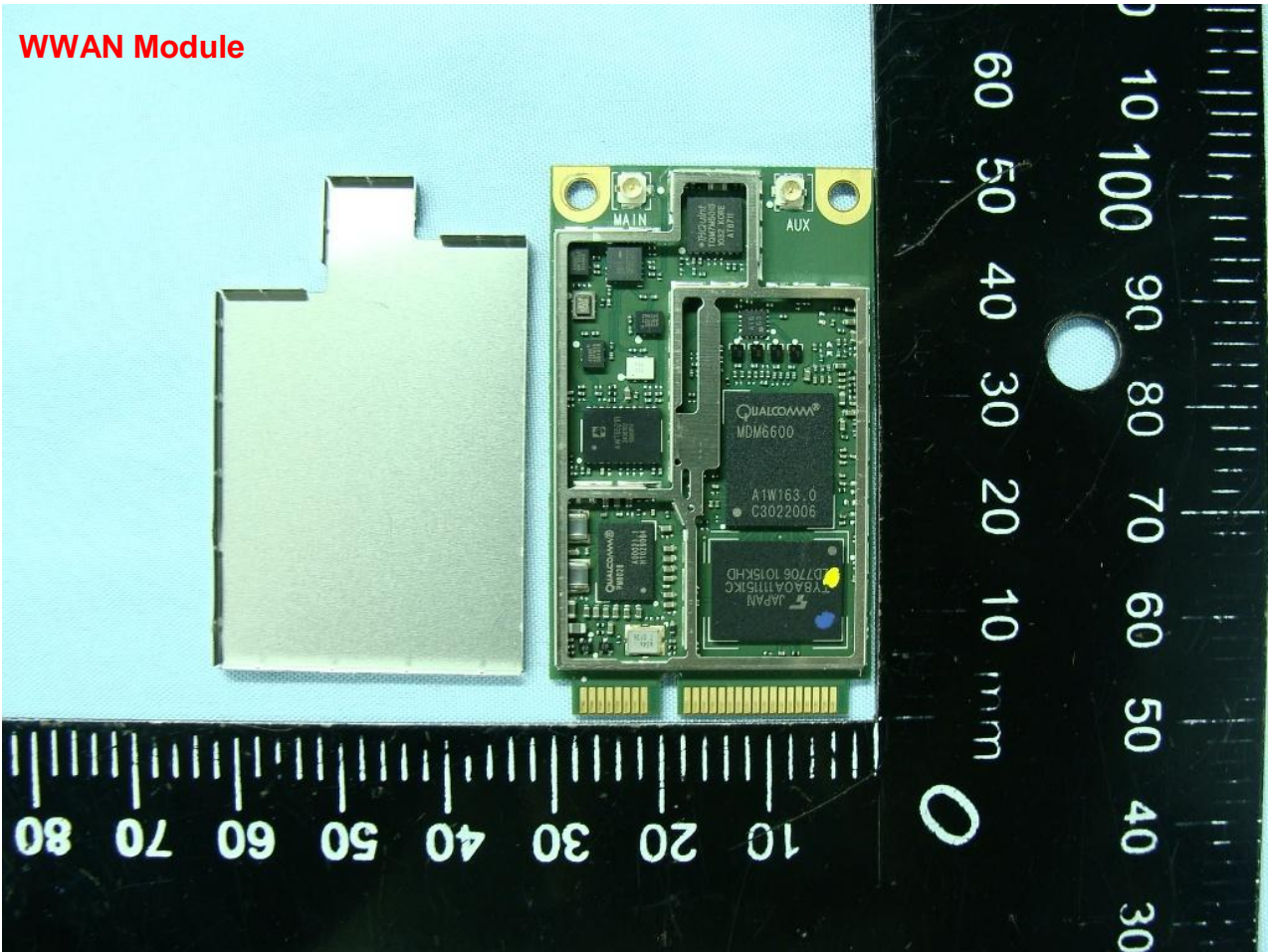

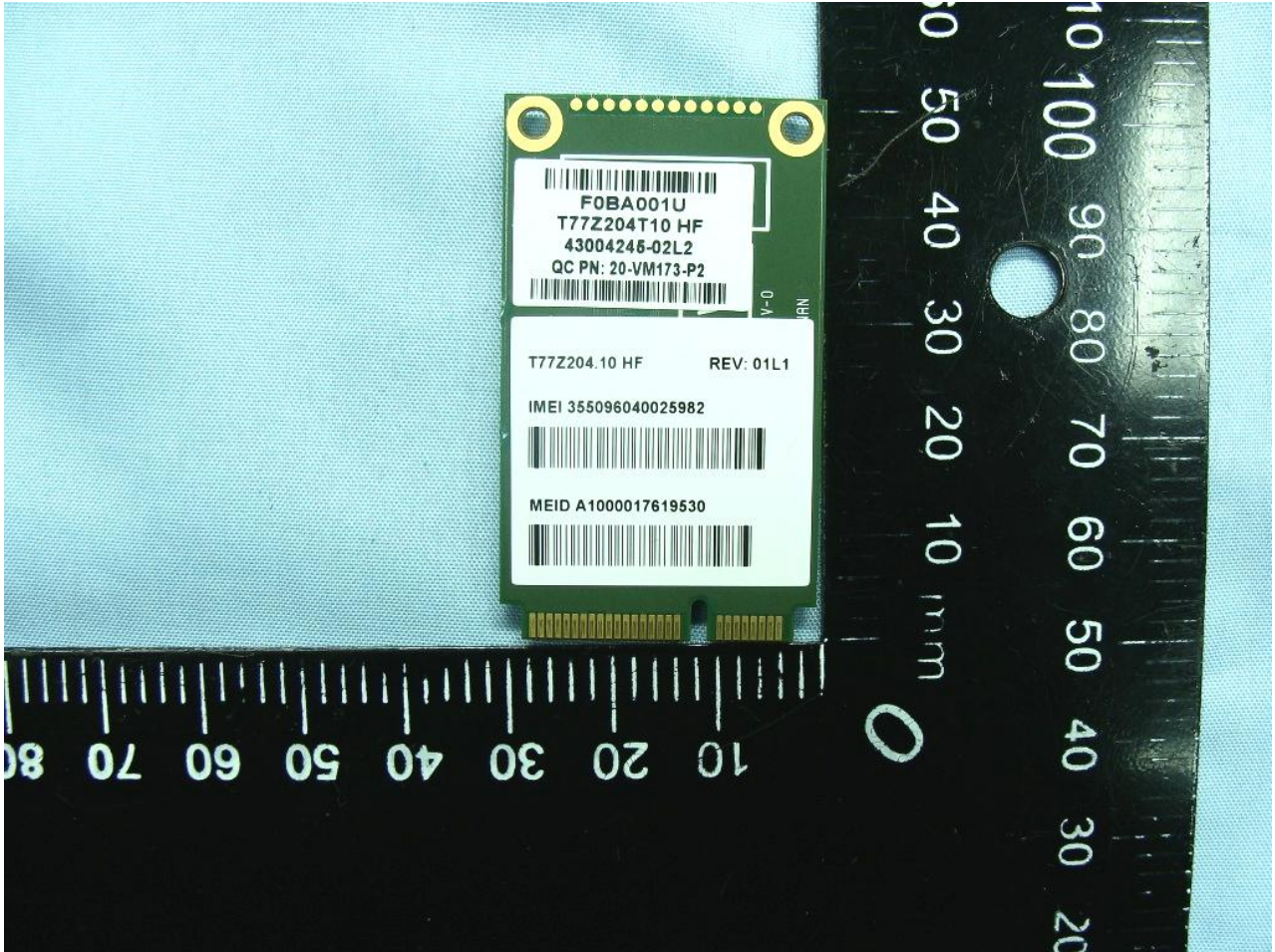

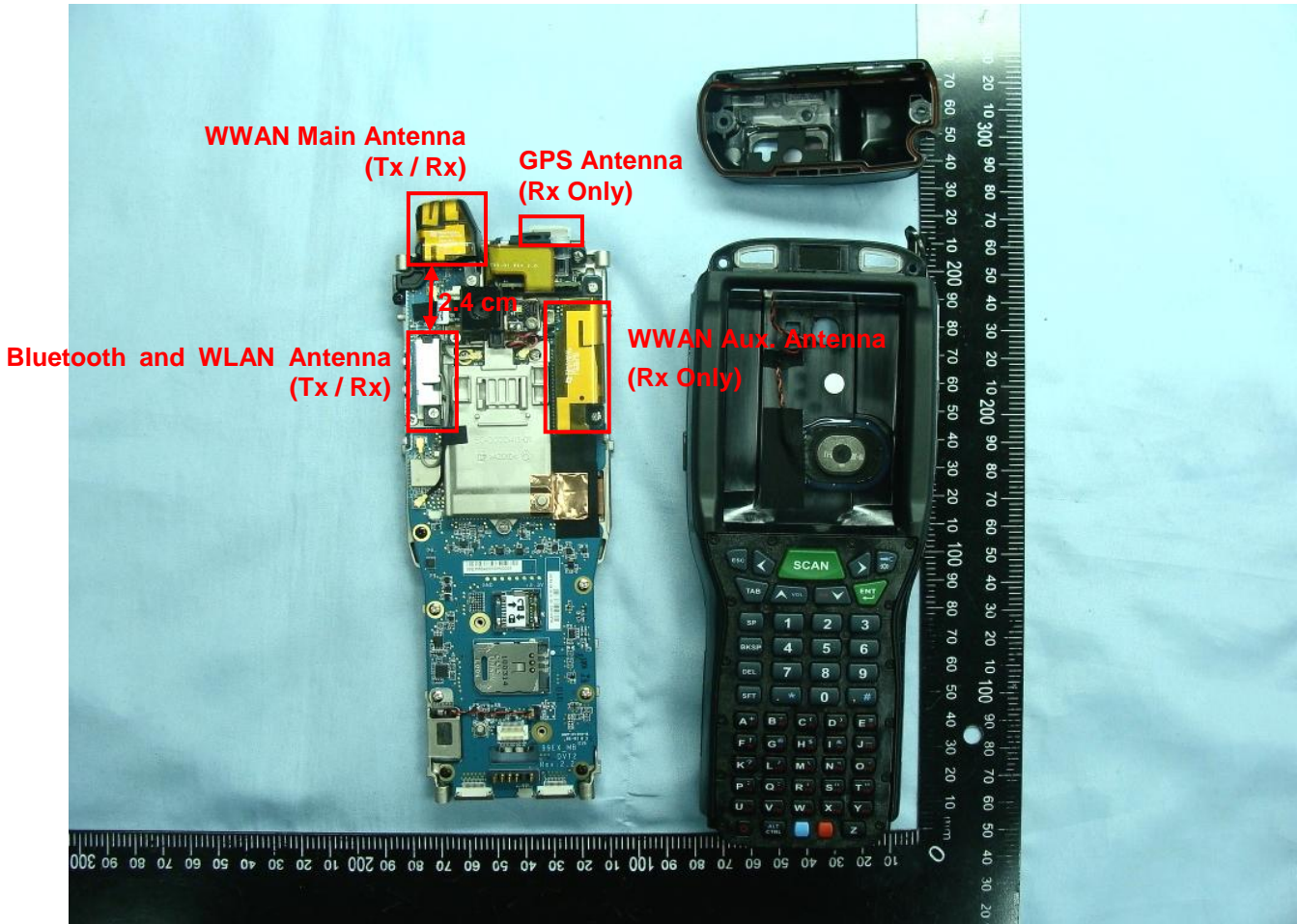

WWAN Main Antenna



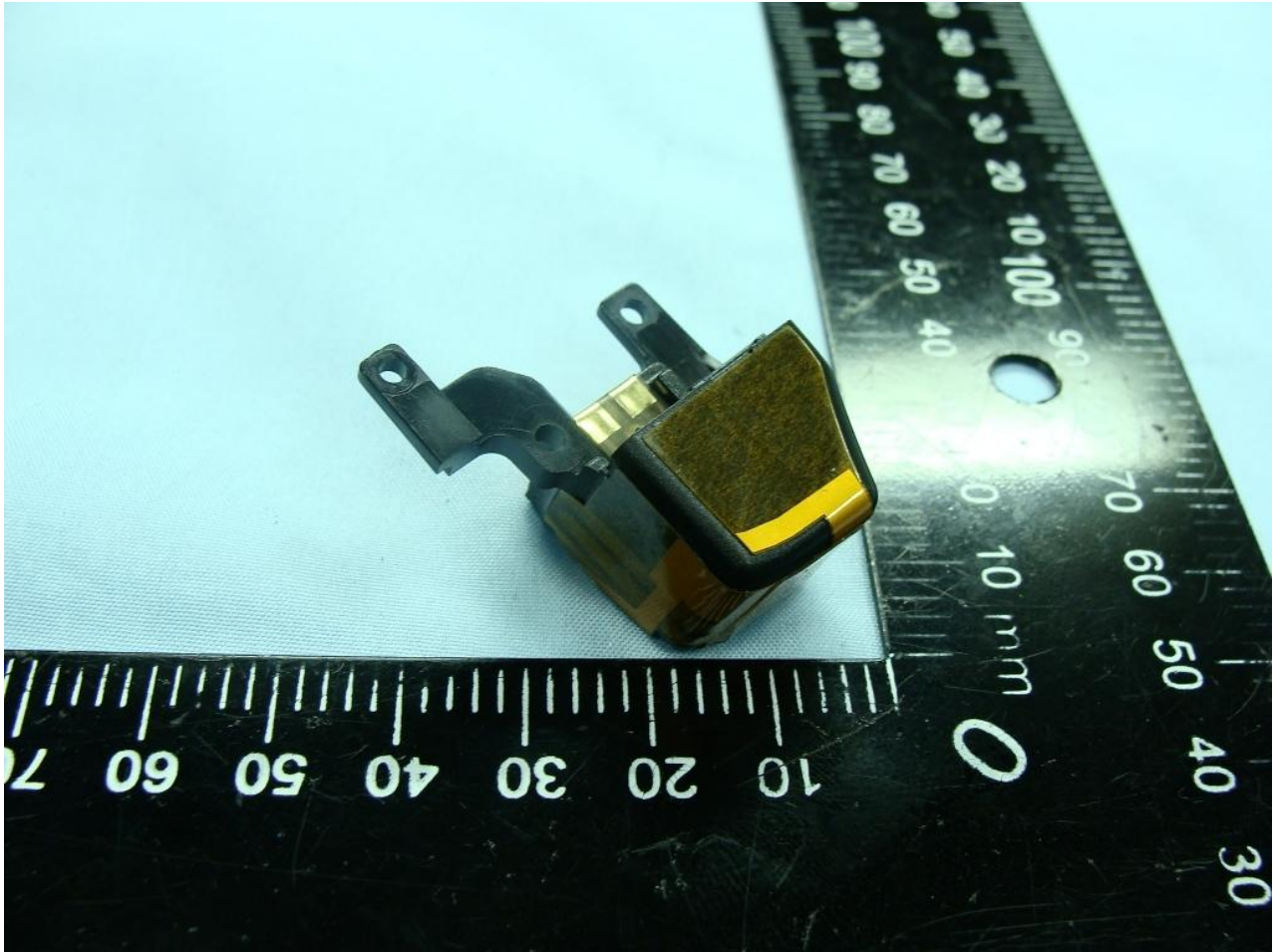

WWAN Aux. Antenna



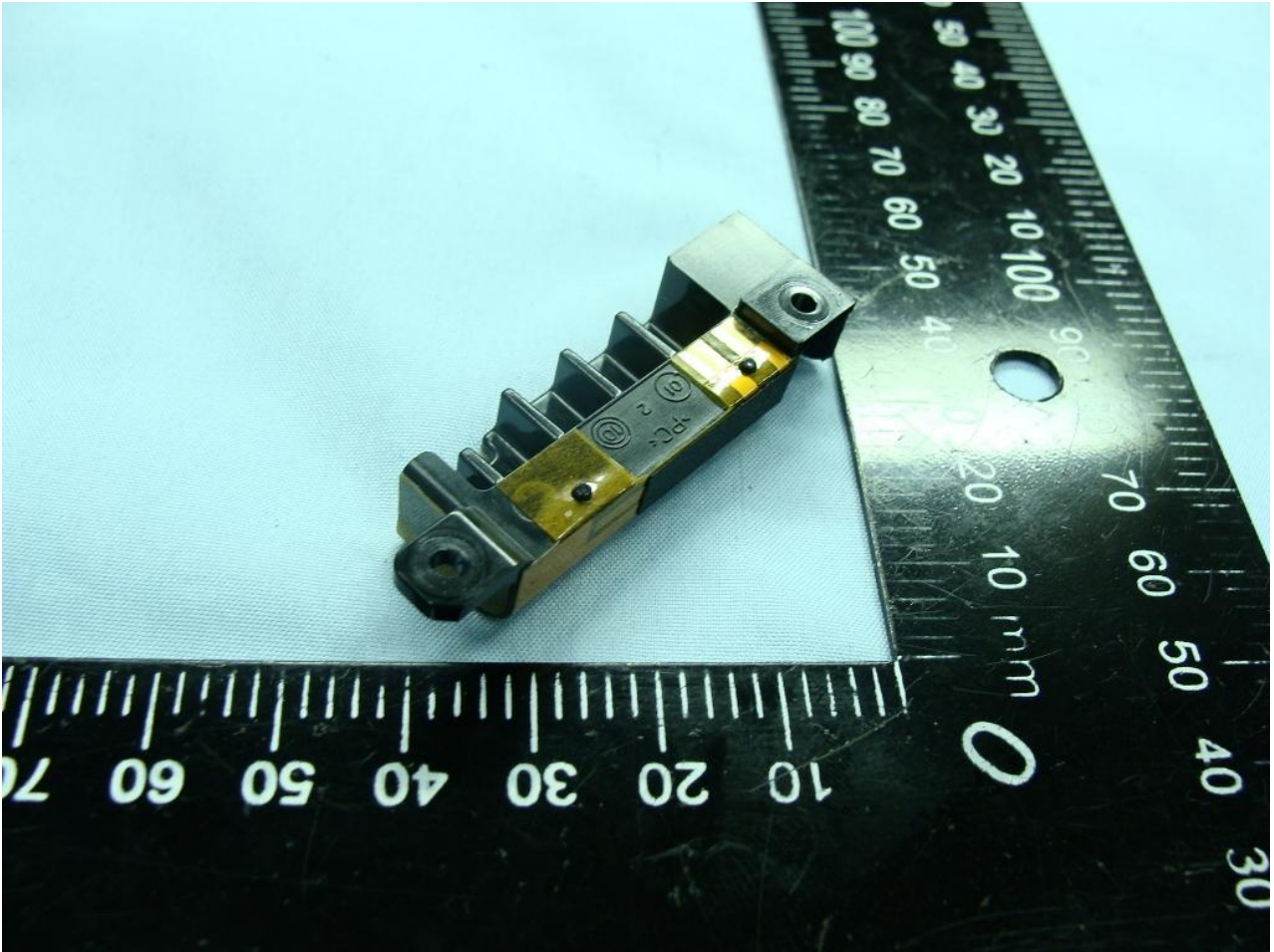

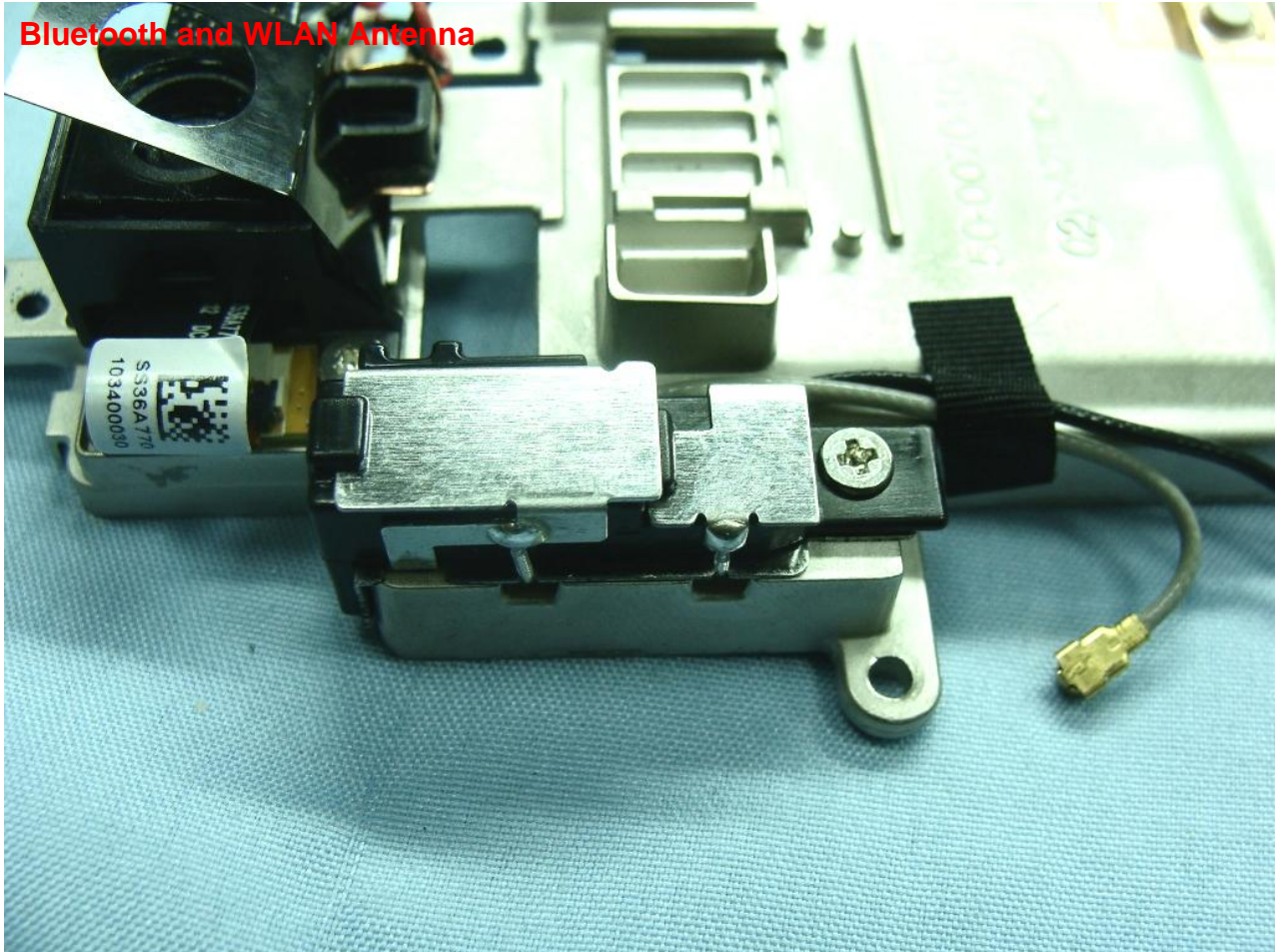

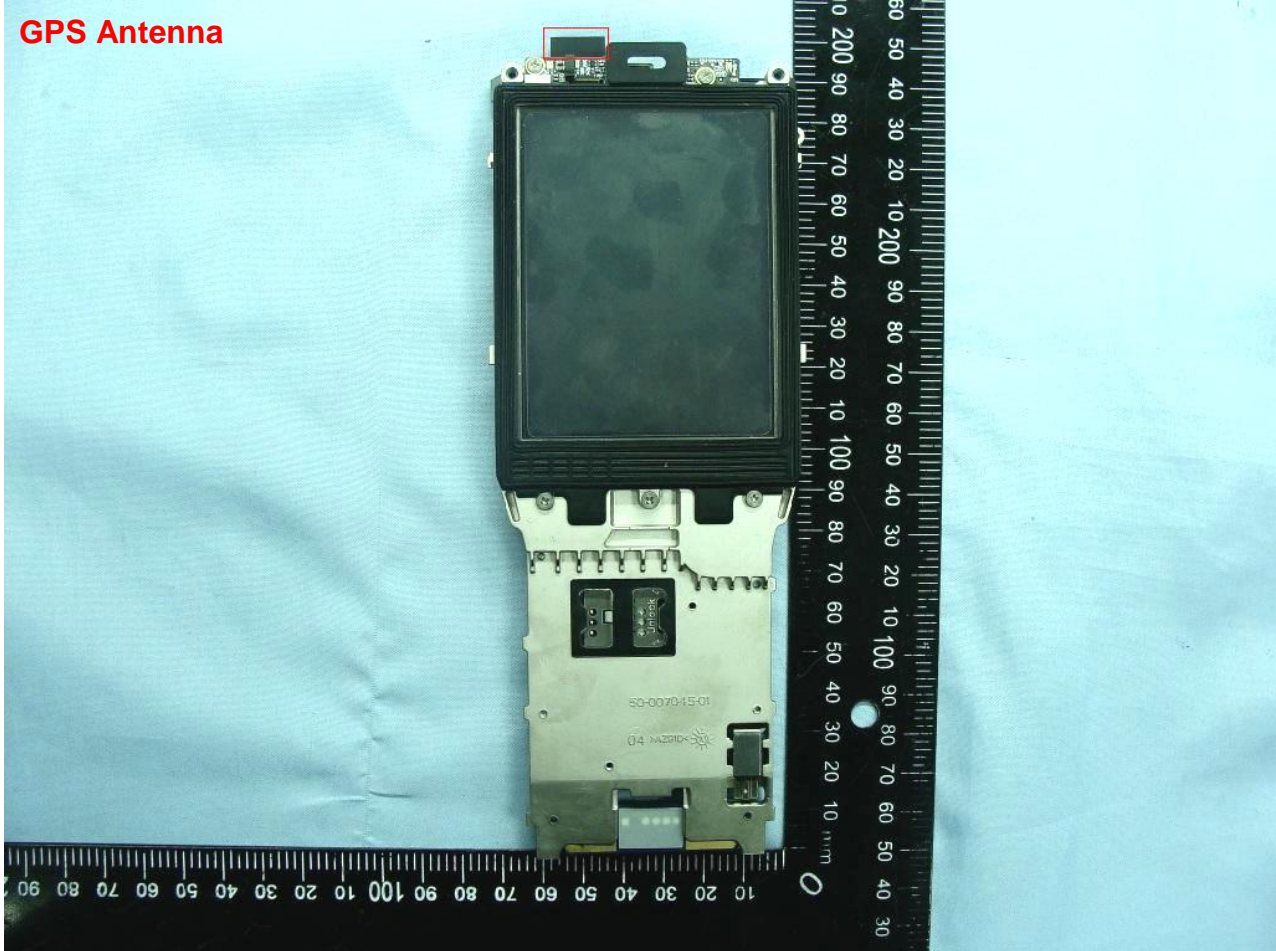

Appendix B. Setup Photographs

<Radiated Emission>

