

MANAGE AND MAINTAIN THE COMPUTER

Use this chapter to understand how to upgrade software, reset, and maintain the computer.

About Software Updates

Honeywell provides patches and security updates for existing software products at no additional charge. Software upgrades (from one major version to another) may involve additional charges. Some licensed software that Honeywell distributes requires user registration and log in before the software can be downloaded.



Support for Honeywell Safety and Productivity Solutions products is available online through the [Technical Support Portal](#).

Software downloads can be accessed through the [Technical Support Downloads Portal](#).

1. Go to www.honeywellaidc.com.
2. Select **Get Resources** > **Software**.
3. Click on the *Technical Support Downloads Portal* link, <https://hsmftp.honeywell.com>.
4. Create an account if you have not already created one. You must login to download the software.
5. Install the *Honeywell Download Manager* tool on your workstation (e.g., laptop or desktop computer) prior to trying to download any files.
6. Locate the app or upgrade you want to download in the Software directory tree.
7. Select **Download**. Follow the prompts to download the file.

Install Software Updates with AutoInstall

Important: *The Thor VM3A must have power for the entire length of the upgrade process or it could become unstable.*

1. Swipe up from the bottom of the Home screen to access all apps.
2. Tap **Settings**  > **Honeywell Settings** > **Provisioning mode**.
3. Tap the toggle button to turn Provisioning mode **On**.
4. Save the upgrade file (*.zip or *.apk) in one of the following folders on the VM3A computer:
 - **Internal shared storage\honeywell\autoinstall**
Software upgrades saved to this folder for installation, do not persist when a Full factory reset or Enterprise data reset is performed.
 - **IPSM card\honeywell\autoinstall**
Software upgrades saved to this folder, do not persist when a Full factory reset is performed. However, the upgrade does persist if an Enterprise data reset is performed.
5. Swipe up from the bottom of the Home screen to access all apps.
6. Tap **AutoInstall Settings**  and verify **Autoinstall** is enabled .
7. Tap **Packages Update** from the AutoInstall Settings screen.



The computer automatically initiates a reboot and installs the software upgrade. The system update screen appears during the upgrade process. When the update is finished, the lock screen appears.
8. Once installation is complete, turn Provisioning mode **Off**.

Note: *Some updates do not require the computer to reboot before installation.*

Optional SD Card Method

The VM3A comes equipped with a SD card socket. You can install an upgrade from an SD card you insert in the computer.

Important: *The Thor VM3A must have power for the entire length of the upgrade process or it could become unstable.*

1. On the computer, swipe up from the bottom of the Home screen to access all apps.
2. Tap **Settings**  > **Provisioning mode** under *Honeywell Settings*.
3. Tap the toggle button to turn Provisioning mode **On**.
4. Tap **AutoInstall Settings** . Verify **AutoInstall** is enabled .

5. Press and hold the **Power** button, and then tap **Power off**.
6. On your workstation (e.g., laptop, desktop computer), format the SD card and create a **\honeywell\autoinstall** folder on the root of the card.
7. Save the upgrade file in the **autoinstall** folder.
8. Install the SD card, and then press the **Power** button.

The computer automatically runs the upgrade found in the autoinstall folder on the card. The system update screen appears during the upgrade process. When the upgrade is finished, the lock screen appears.

9. Once installation is complete, turn Provisioning mode **Off**.

About the Honeywell Upgrader

Use the Honeywell Upgrader app (HUpgrader) to check for and install OTA updates or view the current OTA version installed on the computer.

Install OTA Updates

To use the HUpgrader to install an OTA update file downloaded from the [Technical Support Downloads Portal](#):

Save the OTA file (*.zip) in the following folder on the VM3A computer:

- **Internal shared storage\Download**

10. Tap **HUpgrader**  to open the Honeywell Updater app.

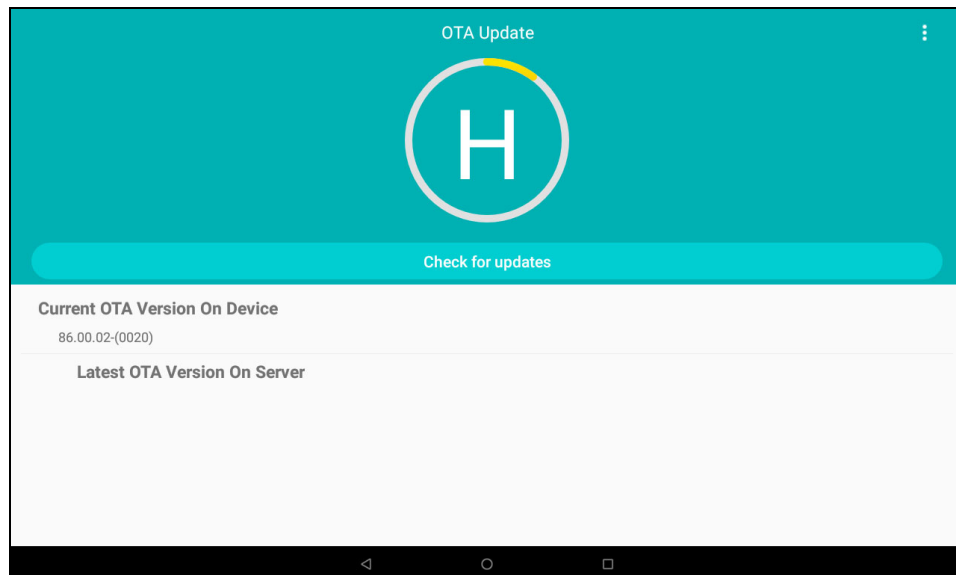

11. Tap  in the upper right corner, and then tap **Select OTA from storage**.
12. Select the storage location (i.e., Internal Storage) where you saved the file.

13. Tap the OTA update file. The computer examines the file, and then starts the installation.

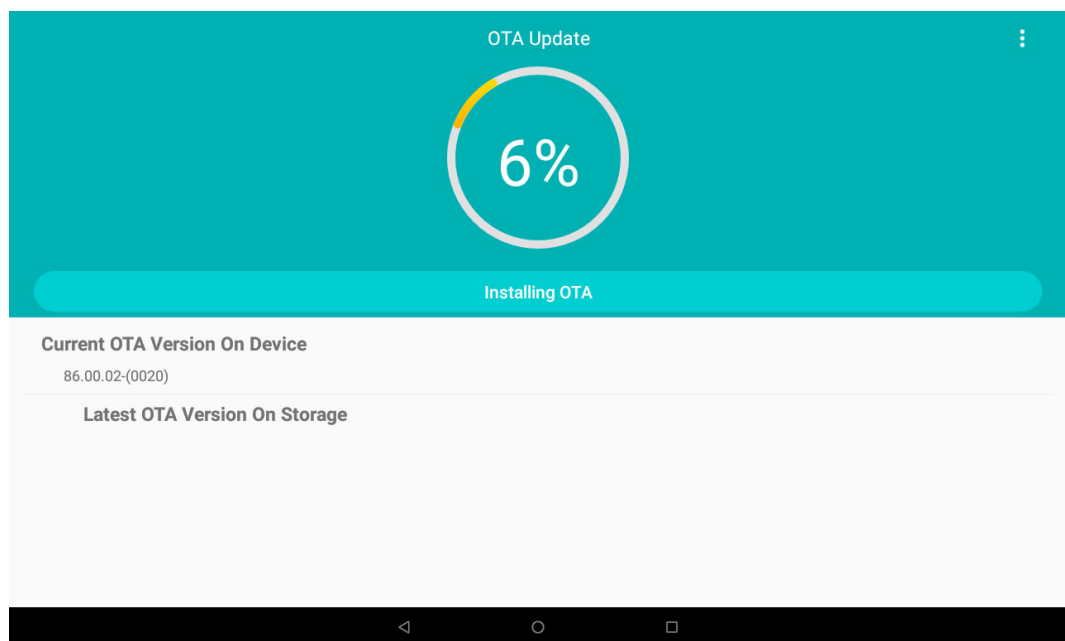
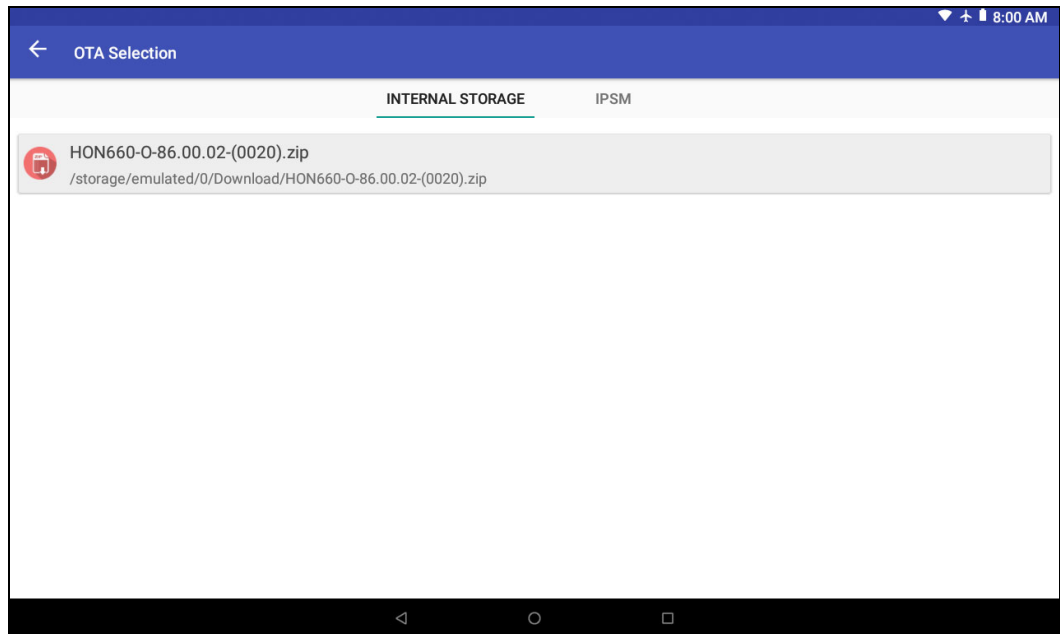

14. Once the installation is complete (100%), select **OK** when prompted to **Reboot** the computer. The computer reboots and finishes the update.

Restart (Reboot) the Computer

You may need to restart the computer to correct conditions where an application stops responding to the system.

1. Save your files and close any open applications.
2. Press and hold the **Power** button until the options screen appears.
3. Tap **Restart**.

If the touch panel display is unresponsive:

- Press and hold the **Power** button for approximately 8 seconds until the computer reboots.

About an Enterprise Data Reset

You can perform an Enterprise data reset if a Reboot did not improve the condition and all other troubleshooting methods have not resolved the issue. This method provides a clean configuration for troubleshooting by erasing all data from the **Internal shared storage** location on the computer. Data is not erased from the **IPSM Card** location.





Caution: An Enterprise data reset results in data loss, only perform this procedure if all other recovery methods have failed. All personal content is erased including, but not limited to emails, pictures, contacts, Google account information, system settings and app settings.

Note: *This method of recovery may not be available if your system administrator has set policies to prevent the reset use.*

Before You Begin

- If you recently reset your Google Account password, wait 24 hours before performing a Enterprise data reset.
- Make sure you have your screen lock password, PIN or pattern if you activated one. You will need this to reset the computer.
- If you have a Google Account, back up your data and settings to your Google Account so you can restore them if needed.
- Connect the computer to an external power source or make sure you have a full battery charge.
- Make sure you have an Internet connection.

Enterprise Data Reset the Computer

1. Swipe up from the bottom of the Home screen to access all apps.
2. Select **Settings**  > **System** > **Reset Options**.
3. Tap **Enterprise data reset**.
4. Tap **Reset Phone**.
5. If prompted, type your screen lock security pattern, PIN, or password and tap next ().
6. Tap **Erase Everything**. A message appears informing you an Enterprise data reset is being performed.

About a Factory Data Reset

A Factory Data Reset should only be performed if you have exhausted all other troubleshooting options. This method reverts the computer back to the factory state by erasing all data in **Internal shared storage** and the **IPSM Card** storage locations on the computer.





Caution: A factory data reset results in data loss. Perform this procedure only if all other recovery methods have failed and have no other option. All personal content is erased including, but not limited to emails, pictures, contacts, Google account information, system settings and app settings.

Note: *This method of recovery may not be available if your system administrator has set policies to prevent the reset use.*

Before You Begin

- If you added a Google Account to the computer, make sure you have your Google username and password associated with the computer. If you do not have the username and password, you will not be able to use the computer after the reset. This is a security measure that prevents unauthorized users from using the device if they try a Full factory reset.
- If you did not add a Google Account to the computer, the extra security level is not enabled and you will not need a Google username and password.
- If you recently reset your Google Account password, wait 24 hours before performing a Full factory reset.
- Connect the computer to an external power source or make sure you have a full battery charge.
- Make sure you have an Internet connection.

Factory Data Reset the Computer

1. Swipe up from the bottom of the Home screen to access all apps.
2. Select **Settings**  > **System** > **Reset Options**.
3. Tap **Erase all data (factory reset)**.
4. Tap **Reset Phone**.
5. If prompted, type your screen lock security pattern, PIN, or password and tap next ().
6. Tap **Erase Everything**. A message appears informing you an Full factory reset is being performed.

Clean the Computer

To keep the computer in good working order, you may need to clean the touch screen. Clean the touch screen as often as needed for the environment in which you are using the computer. The computer withstands application of the following cleaning agents when applied to a clean soft cloth and removed immediately with a dry soft cloth:

- Acetic acid, 10% in water
 - Ethyl alcohol, 10% in water
 - Mild soap solutions
1. Press the **Power** button to put the computer into Sleep mode.
 2. Dip a clean cloth towel in the cleaning agent and wring out the excess.
 3. Wipe dry.
 4. Let the computer completely air dry before using again.

Maintenance - Vehicle Mounted Devices

Check the vehicle mounting hardware frequently and re-tighten if necessary.

If the vehicle mounting hardware and connections become broken, loose or cracked, the assembly must be taken out of service and replaced. Contact [Technical Assistance](#) for help.

Replace the Front Panel

-

Equipment Required

The following equipment is user-supplied:

- Torque tool capable of measuring inch pounds
- #2 Phillips screwdriver bit

Replacement Procedure



Caution: Before replacing the Thor VM3A front panel, **Disconnect the UPS Battery.**

1. Place the computer on a clean, well-lit surface before performing the front panel replacement.
2. Press and hold the **Power** button until the options menu appears. Tap **Power Off**.
3. Remove the computer from the dock.
4. [Disconnect the UPS Battery.](#)
5. Loosen the fourteen (14) captive M3 screws holding the front panel. Use a #2 Phillips bit.

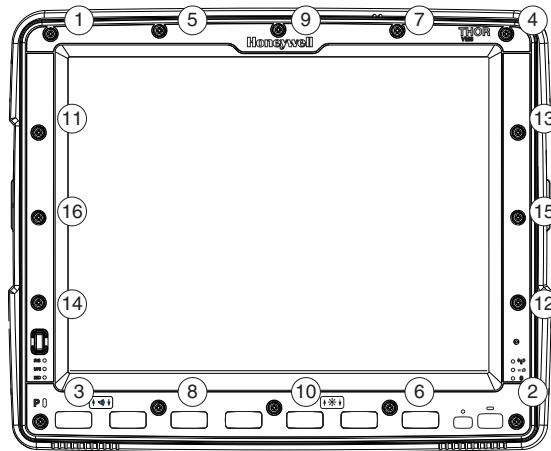

6. Carefully lift the front panel away from the device.

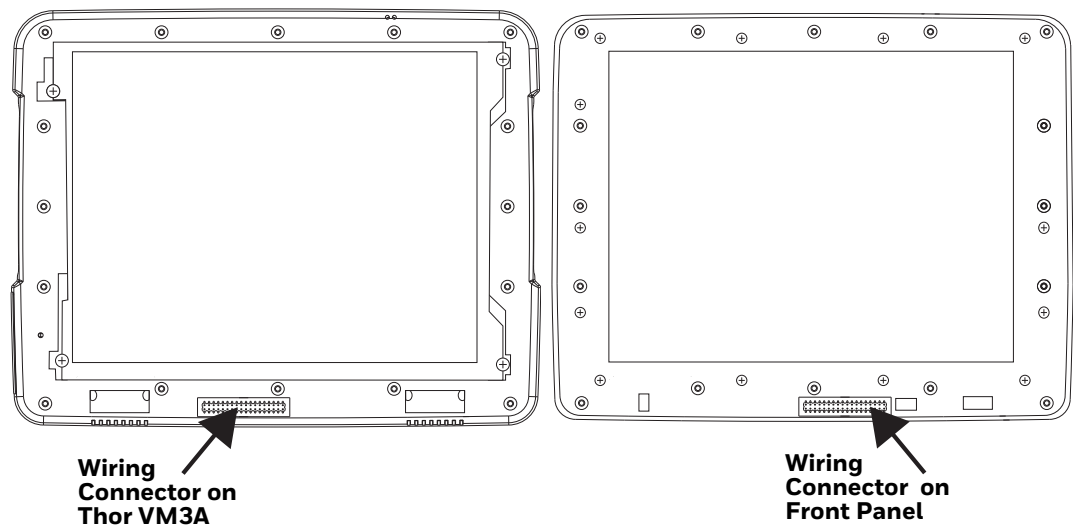

7. Position the replacement front panel so the tab on the back of the front panel lines up with the alignment slot on the VM3A. Be sure the two wiring connectors are also aligned.
8. Position the replacement front panel so wiring connector on the back of the front panel lines up with the connector on the computer.
9. Gently press the front panel into place.
10. Tighten the fourteen (14) captive M3 screws. In the order shown in the top figure above, use a #2 Phillips bit and torque the screws to 6-7 inch pounds.
11. Reinstall the computer in the dock.
12. When the computer is placed in the powered dock, the UPS battery automatically reconnects.
13. Press the **Power** button to turn on the computer.
14. The computer is ready for use.

Integrated Keypad



There are seven integrated programmable keys located on the Thor VM3 below the display. Each programmable key can be modified by the Orange key for a total of 14 programmable keys.

See [Remap a Button or Key](#) to remap these keys.

The default values for these keys are:

To get this Programmable Key	Press These Keys in this Order		Default Key Value
P1 (Programmable key 1)	P1		F1
P2 (Programmable key 2)	P2		F2
P3 (Programmable key 3)	P3		F3
P4 (Programmable key 4)	P4		F4
P5 (Programmable key 5)	P5		F5
P6 (Programmable key 6)	P6		Open/Close Soft Keyboard
P7 (Programmable key 7)	P7		Enter
P8 (Programmable key 8)	Orange	P1	<none>
P9 (Programmable key 9)	Orange	P2	<none>
P10 (Programmable key 10)	Orange	P3	<none>
P10 (Programmable key 11)	Orange	P4	<none>
P10 (Programmable key 12)	Orange	P5	<none>
P10 (Programmable key 13)	Orange	P6	<none>
P10 (Programmable key 14)	Orange	P7	<none>
Increase speaker volume	Blue	P1	Increase speaker volume
Decrease speaker volume	Blue	P2	Decrease speaker volume
Increase display brightness	Blue	P5	Increase display brightness

To get this Programmable Key	Press These Keys in this Order		Default Key Value
Decrease display brightness	Blue	P6	Decrease display brightness

The following key press sequences are not programmable:

To get this function	Press These Keys in this Order	
Increase speaker volume	Blue	P1
Decrease speaker volume	Blue	P2
Increase display brightness	Blue	P5
Decrease display brightness	Blue	P6

The Blue plus P3, P4 or P7 key press sequences cause no action.

Integrated Keypad and BIOS

The front panel keys have limited functionality before booting completes. However, the following key functions are available during BIOS setup and before Windows has completed loading (i.e.: to maneuver a Windows boot menu).

- P1 - Up Arrow
- P2 - F2
- P3 - Down Arrow
- P4 - Left Arrow
- P5 - F5
- P6 - Right Arrow
- P7 - Esc (Escape)
- Blue - Tab
- Orange - Enter

External 21-Key Keyboard



The table below shows the results of the keypress combinations. Each key has an unshifted mode, a Yellow shifted mode and a Green shifted mode.

- To enter Yellow shifted mode, press the Yellow key. The keypad remains in Yellow shifted mode until any other key is pressed or the Yellow key is pressed again.
- To enter Green shifted mode, press the Green key. The keypad remains in Green shifted mode until any other key is pressed or the Green key is pressed again.
- Pressing the Yellow key then the Green key cancels Yellow mode and the keypad is in Green shifted mode.
- Pressing the Green key then the Yellow key cancels Green mode and the keypad is in Yellow shifted mode.
- Arrow keys are unaffected by Yellow or Green shifted mode.
- Keypress combinations marked as N/A do nothing (the keystroke is consumed by the keyboard and not sent to the Thor VM3).
- Pressing the backlight key (alone or after the Green or Yellow keys) cycles the keypad backlight through Low, Medium, High, Off then repeats.

Key	Non-Shifted	Yellow-Shifted	Green-Shifted
1	1	F1	F11
2	2	F2	F12
3	3	F3	F13
4	4	F4	F14
5	5	F5	F15
6	6	F6	F16
7	7	F7	F17
8	8	F8	F18
9	9	F9	F19
0	0	F10	F20
PF	Programmable	Programmable	N/A

Key	Non-Shifted	Yellow-Shifted	Green-Shifted
Del	Delete	Backspace	N/A
Tab	Tab	Backtab	N/A
Left	Left	Left	Left
Right	Right	Right	Right
Up	Up	Up	Up
Down	Down	Down	Down

External 95-Key Keyboard



The key map table that follows lists the commands used for the Thor VM3. Note that since the Thor VM3 uses a Microsoft Windows operating system, no DOS Terminal Emulation keypress sequences are provided.

There are 10 hidden keys on the 95 key keyboard. Each of the hidden keys is accessed by pressing the <Fn> key (located in the top right hand corner) plus a key on the numeric keypad on the right. Additional function keys are supported as well.

To get this Key / Function	Press These Keys in this Order	
Insert	FN	0 (numeric keypad)
Home	FN	7 (numeric keypad)
Page Up	FN	9 (numeric keypad)
Delete	FN	. (numeric keypad)
End	FN	1 (numeric keypad)
Page Down	FN	3 (numeric keypad)
Up Arrow	FN	8 (numeric keypad)
Left Arrow	FN	4 (numeric keypad)
Down Arrow	FN	2 (numeric keypad)
Right Arrow	FN	6 (numeric keypad)

External 60-Key Keyboard

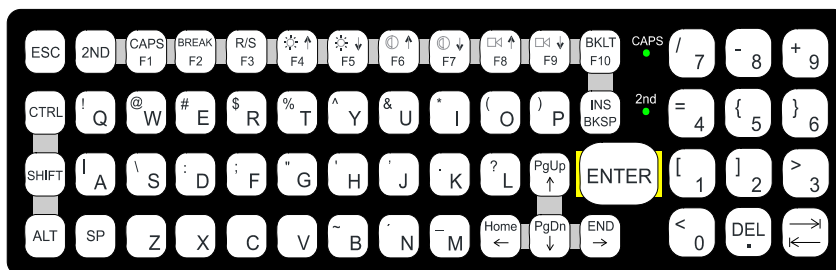

The key map table that follows lists the commands used when using the Thor VM3 with the 60-key PS/2 Keyboard.

The 60-key keyboard does not have a NumLock indicator or key. NumLock can be toggled On or Off using the **2nd SHIFT F10** keypress sequence. The default for NumLock is On. Changes made to the NumLock status persist across a Windows restart.

When running RFTerm, please refer to the RFTerm Reference Guide for equivalent keys and keypress sequences.

60 Key KeyMap 101-Key Equivalencies

- The following keymap is used on a Thor VM3 that is NOT running RFTerm.
- When using a sequence of keys that includes the 2nd key, press the 2nd key first then the rest of the key sequence.
- When the Thor VM3 boots, the default condition of Caps (or CapsLock) is Off. The Caps (or CapsLock) condition can be toggled with a **2nd + F1** key sequence. The CAPS LED is illuminated when CapsLock is On. The keymaps below assume Caps is Off.
- The Thor VM3 keyboard has several control keys. The following control keys are not used:
 - The 2nd function of the **F3** key is not used as Windows Power Management controls all power management modes on the Thor VM3.
 - The 2nd functions of the **F4** and **F5** keys are not used as the display brightness is adjusted via the buttons on the front of the Thor VM3.
 - The 2nd functions of the **F6** and **F7** keys are not used as the Thor VM3 has TFT LCD screen with no provision for contrast adjustments.
 - The 2nd functions of the **F8** and **F9** keys are not used as the sound volume on the Thor VM3 is controlled with a Microsoft Windows Control Panel.
 - The 2nd function of the **F10** key is not used as the display backlight timer also controls the keyboard backlight.

To get this Key / Function	Press These Keys in this Order		
Power On/Off	Power		
2nd	2nd		
Shift	Shift		
Alt	Alt		
Ctrl	Ctrl		
Esc	Esc		
Space	Sp		
Enter	Enter		
Enter (numeric)	2nd	Enter	
CapsLock (Toggle)	2nd	F1	
Back Space	BkSp		
Tab	Tab		

To get this Key / Function	Press These Keys in this Order		
Back Tab	2nd	Tab	
Ctrl-Break	Ctrl	2nd	F2
Pause	2nd	F2	
Up Arrow	Up Arrow		
Down Arrow	Down Arrow		
Right Arrow	Right Arrow		
Left Arrow	Left Arrow		
Insert	2nd	Bksp	
Delete (numeric)	2nd	DOT	
Home	2nd	Left Arrow	
End	2nd	Right Arrow	
Page Up	2nd	Up Arrow	
Page Down	2nd	Down Arrow	
ScrollLock	2nd	Shift	F10
F1	F1		
F2	F2		
F3	F3		
F4	F4		
F5	F5		
F6	F6		
F7	F7		
F8	F8		
F9	F9		
F10	F10		
F11	2nd	Shift	F1
F12	2nd	Shift	F2
a	A		
b	B		
c	C		
d	D		
e	E		
f	F		
g	G		
h	H		
i	I		
j	J		
k	K		
l	L		
m	M		
n	N		

To get this Key / Function	Press These Keys in this Order		
o	O		
p	P		
q	Q		
r	R		
s	S		
t	T		
u	U		
v	V		
w	W		
x	X		
y	Y		
z	Z		
A	Shift	A	
B	Shift	B	
C	Shift	C	
D	Shift	D	
E	Shift	E	
F	Shift	F	
G	Shift	G	
H	Shift	H	
I	Shift	I	
J	Shift	J	
K	Shift	K	
L	Shift	L	
M	Shift	M	
N	Shift	N	
O	Shift	O	
P	Shift	P	
Q	Shift	Q	
R	Shift	R	
S	Shift	S	
T	Shift	T	
U	Shift	U	
V	Shift	V	
W	Shift	W	
X	Shift	X	
Y	Shift	Y	
Z	Shift	Z	
1	1		
2	2		

To get this Key / Function	Press These Keys in this Order		
3	3		
4	4		
5	5		
6	6		
7	7		
8	8		
9	9		
0	0		
DOT	DOT		
<	2nd	0	
[2nd	1	
]	2nd	2	
>	2nd	3	
=	2nd	4	
{	2nd	5	
}	2nd	6	
/ (numeric)	2nd	Ctrl	7
/ (alpha)	2nd	7	
- (numeric)	2nd	Ctrl	8
- (alpha)	2nd	8	
+ (numeric)	2nd	Ctrl	9
+ (alpha)	2nd	9	
* (numeric)	2nd	I (letter i)	
* (alpha)	2nd	Ctrl	I (letter i)
: (colon)	2nd	D	
;(semicolon)	2nd	F	
?	2nd	L	
`	2nd	N	
_ (underscore)	2nd	M	
, (comma)	2nd	J	
' (apostrophe)	2nd	H	
~ (tilde)	2nd	B	
\	2nd	S	
	2nd	A	
"	2nd	G	
!	2nd	Q	
@	2nd	W	
#	2nd	E	
\$	2nd	R	
%	2nd	T	

To get this Key / Function	Press These Keys in this Order		
^	2nd	Y	
&	2nd	U	
(2nd	O	
)	2nd	P	

SPECIFICATIONS AND REFERENCE MATERIALS

Technical Specifications

Thor VM3A

Processor	2.2 GHz Qualcomm Snapdragon™ 660 octacore processor
Memory	4 GB SDRAM
Storage Expansion	User installable, supports 512GB microSD card
Operating System	Android 8, upgradeable through Android R
Radio Modules	802.11 a/b/g/n/ac radio / Bluetooth
Scanner Options	No integrated scanner, Optional serial, USB or Bluetooth scanners
Display Technology	Intel GMA 500 graphics processor, WVGA compatible Active matrix TFT Resolution: 1280x768 pixels 400 NIT (indoor) or 900 NIT (outdoor) brightness 8" (measured horizontal) display Transmissive with LED backlight Automatic brightness control on outdoor display Vehicle motion screen blanking available
Touch Screen	eGalaxCalibrator Mercury Impact resistant Signature capture capability Resistive and Capacitive (PCAP) options Optional defroster resistive Field replaceable front panel optional indoor, outdoor, defroster resistive, indoor PCAP, or outdoor PCAP
External Connectors	Optional external 802.11 antenna connectors Additional connectors on dock
Beeper	Minimum loudness greater than 95dBm at 10 cm in front of unit
Power Supply	10 to 60 VDC isolated
Uninterruptible Power Supply	Internal UPS battery, field replaceable, 30-minute life at 20°C (68°F)
Backup Battery (RCT)	Internal lithium battery maintains Real Time Clock

VM1D Standard Dock



Caution: This dock is designed for DC power vehicle-mounted applications only.

SKUs	VM1001VMCRADLE (with DC power cable) VM1002VMCRADLE (with RAM ball) VM1003VMCRADLE (dock only)
Power Connector	6-pin connector: Direct 10-60 VDC input power Optional external converter for extended range DC (60-150 VDC)
COM1 Connector	9-pin male, RS-232 serial port, COM1 with power on pin 9
COM2 Connector	9-pin male, RS-232 serial port, COM1 with power on pin 9
CANbus/Audio Connector	15-pin male, Audio connector supports either audio/microphone via adapter cable
USB Connector	9-pin female, USB connector supports USB host port via adapter cable
Power Switch	Sealed power switch
Input Power	DC Input Voltage: 10-60 VDC, Input Current: 4.6 Amps (typical) Input Fuse: 8A Time Delay, Replace with same size, rating and type of fuse: <ul style="list-style-type: none"> • Littlefuse 0215008.MXP • Cooper Bussmann BK1/S506-8-R • Bel Fuse 5HT 8-R • or equivalent
External Power Supply	50-150 VDC DC power supply available for vehicles over 60 VDC Note: Use dock VMX005VMCRADLE (VMXD Enhanced Dock of Off-Vehicle Use) in AC power applications.

VM3D Enhanced Dock



Caution: This dock is designed for DC power vehicle-mounted applications only.

SKUs	VM3001VMCRADLE
Power Connector	6-pin connector: Direct 10-60 VDC input power Optional external converter for extended range DC (60-150 VDC)
COM1 Connector	9-pin male, RS-232 serial port, COM1 with power on pin 9
COM2 Connector	9-pin male, RS-232 serial port, COM1 with power on pin 9
CANbus/Audio Connector	15-pin male, Audio connector supports either audio/microphone via adapter cable
USB1 Connector	9-pin female, USB connector supports USB host port via adapter cable
USB2 Connector	15-pin female, USB connector supports two USB host ports via adapter cable
USB Host Connector	One USB type A Host connector behind waterproof cap
Ethernet	One RJ45 Ethernet connector behind waterproof cap
Power Switch	Sealed power switch

Input Power	DC Input Voltage: 10-60 VDC, Input Current: 4.6 Amps (typical) Input Fuse: 8A Time Delay, Replace with same size, rating and type o f fuse: <ul style="list-style-type: none"> • Littlefuse 0215008.MXP • Cooper Bussmann BK1/S506-8-R • Bel Fuse 5HT 8-R • or equivalent
External Power Supply	50-150 VDC DC power supply available for vehicles over 60 VDC Note: Use dock VMX005VMCRADLE (VMXD Enhanced Dock of Off-Vehicle Use) in AC power applications.

VMXD Enhanced Dock



Caution: This dock is designed for DC power vehicle-mounted applications only.

SKUs	VMX004VMCRADLE (when replacing VX8 or VX9 installation that uses screen blanking)
Power Connector	6-pin connector: 13.2 VDC input power; requires DC power supply Connector is also used for screen blanking via COM1 CTS and RTS signals
COM1 Connector	9-pin male, RS-232 serial port, COM1 with power on pin 9 Do not use COM1 when screen blanking box is attached to avoid port conflicts
COM2 Connector	9-pin male, RS-232 serial port, COM1 with power on pin 9
CANbus/Audio Connetor	15-pin male, Audio connector supports either audio/microphone via adapter cable
USB1 Connector	9-pin female, USB connector supports USB host port via adapter cable
USB2 Connector	15-pin female, USB connector supports two USB host ports via adapter cable
USB Host Connector	One USB type A Host connector behind waterproof cap
Ethernet	One RJ45 Ethernet connector behind waterproof cap
Power Switch	Sealed power switch
Input Power	DC Input Voltage: 13.2 VDC, Input Current: 4.6 Amps (typical) Input Fuse: 8A Time Delay, Replace with same size, rating and type o f fuse: <ul style="list-style-type: none"> • Littlefuse 0215008.MXP • Cooper Bussmann BK1/S506-8-R • Bel Fuse 5HT 8-R • or equivalent
External Power Supply	50-150 VDC DC power supply available for vehicles over 60 VDC Note: Use dock VMX005VMCRADLE (VMXD Enhanced Dock of Off-Vehicle Use) in AC power applications.

VMXD Enhanced Dock for Off-Vehicle Use (QM3AC)



Caution: This dock is designed for AC power (non vehicle-mounted) applications only.

SKUs	VMX005VMCRADLE
Power Connector	6-pin connector: 15 VDC input power via required AC/DC power
COM1 Connector	9-pin male, RS-232 serial port, COM1 with power on pin 9
COM2 Connector	9-pin male, RS-232 serial port, COM1 with power on pin 9
CANbus/Audio Connetor	15-pin male, Audio connector supports either audio/microphone via adapter cable
USB1 Connector	9-pin female, USB connector supports USB host port via adapter cable
USB2 Connector	15-pin female, USB connector supports two USB host ports via adapter cable
USB Host Connector	One USB type A Host connector behind waterproof cap
Ethernet	One RJ45 Ethernet connector behind waterproof cap
Power Switch	Sealed power switch
Input Power	DC Input Voltage: 10-60 VDC, Input Current: 4.6 Amps (typical) Input Fuse: 8A Time Delay, Replace with same size, rating and type of fuse: <ul style="list-style-type: none"> • Littlefuse 0215008.MXP • Cooper Bussmann BK1/S506-8-R • Bel Fuse 5HT 8-R • or equivalent
External Power Supply	AC Adapter, 120-240 VAC to 15 VDC required Note: <i>This dock for use in AC power applications. See other docks for DC power applications.</i>

Dimensions

Thor VM3A

Width	12.5" (31.9 cm)
Height	10.3" (26.1 cm)
Depth	2.4" (6.2 cm)

VM1D Standard Dock

Note: The RAM ball is not included in the following measurements.

Length	7.1" (18.0 cm)
Width	6.1" (15.5 cm)
Height	2.5" (6.4 cm), measurement includes strain relief cable clamps
Weight	3.2 lb. (1.5 kg)

VM3D and VMXD Enhanced Dock

Note: The RAM ball is not included in the following measurements.

Length	7.1" (18.0 cm)
Width	6.1" (15.5cm)
Height	2.1" (5.4 cm), measurement includes strain relief cable clamps
Weight	2.4 lb. (1.1 kg)

Environmental Specifications

Thor VM3A and Dock

Operating Temperature	Standard: -4°F to 122°F (-20°C to 50°C) [non-condensing] Cold Storage: -22°F to 122°F (-30°C to 50°C) [condensing]
Storage Temperature	Standard and Cold Storage: -22°F to 140°F (-30°C to 60°C) [non-condensing]
ESD	8 KV air, 4kV direct contact
Operating Humidity	Standard: Up to 90% non-condensing at 104°F (40°C) Cold Storage: 100%
Water and Dust	IEC 60529 compliant to IP66
Vibration	MIL-STD-810F, composite wheeled vehicles
Crash	SAE-J1455

Port and Connector Pinouts

Power Supply Connector

VM1D Standard Dock and VM3D Enhanced Dock

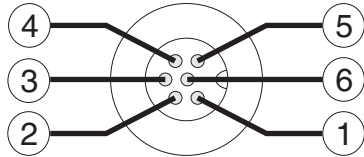

Pin	Signal	Description
1	V In+	10-60V DC Input +
2	V In+	10-60V DC Input +
3	V In-	Input -
4	V In-	Input -
5	GND	Chassis ground
6	Ignition	+0V to 60V to start terminal

VMXD Enhanced Dock

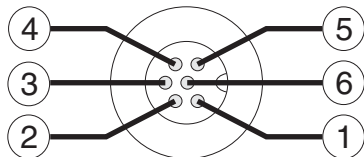

Pin	Signal	Description
1	V In+	13.2V DC input + provided by AC/DC adapter
2	V In+	13.2V DC input + provided by AC/DC adapter
3	V In-	Input -
4	V In-	Input -
5	COM1 RTS	Screen Blanking Box + The green wire in the power cable must be connected to the switched side of the screen blanking box. See the applicable wiring diagram below.
6	COM1 CTS	Screen Blanking Box - The white wire in the power cable must be connected to the unswitched side of the screen blanking box. See the applicable wiring diagram below.
Cable shell provides chassis ground connection.		

VMXD Enhanced Dock for Off-Vehicle Use (QM3AC)

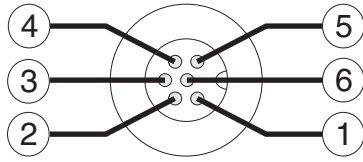

Pin	Signal	Description
1	V In+	15V DC Input + provided by AC/DC adapter
2	V In+	15V DC Input + provided by AC/DC adapter
3	V In-	Input -
4	V In-	Input -
5	GND	No Connection
6	Ignition	No Connection

VMXD enhanced dock for off-vehicle use requires adapter cable VM1076CABLE to connect the dock to the AC/DC adapter. This cable is included in the AC kit for off-vehicle use.

COM1 and COM2 Connector

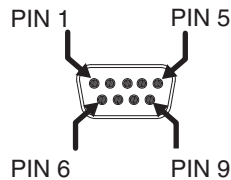

Pin	Signal	Description
1	V In+	15V DC Input + provided by AC/DC adapter
2	V In+	15V DC Input + provided by AC/DC adapter
3	V In-	Input -
4	V In-	Input -
5	GND	No Connection
6	Ignition	No Connection

VMXD Enhanced Dock only: Because the power supply connector port for the VMXD Enhanced Dock contains COM1 RTS and CTS signals, the COM1 port on the dock should not be used when the power cable is used for screen blanking to avoid port conflicts.

USB and USB1 Connector

The Standard Dock has a USB connector. The Enhanced Dock has a USB1 connector.

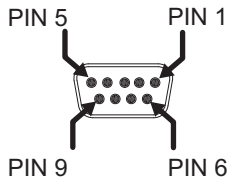

Pin	Signal	Description
1	DCD	Data Carrier Detect - Input
2	RXD	Receive Data - Input
3	TXD	Transmit Data - Output
4	DTR	Data Terminal Ready - Output
5	GND	Signal/Power Ground
6	DSR	Data Set Ready - Input
7	RTS	Request to Send - Output
8	CTS	Clear to Send - Input
9	+5VDC	Bar Code Scanner Power - 500mA max
Shell	CGND	Chassis Ground

USB Host/Client Y Cable

D9 Male Connector

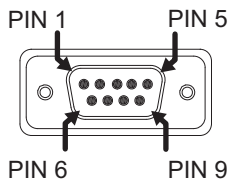

Pin	Signal	Description
1	GND	Common ground
2	USBC_D+	USB client data signal
3	USBC_D-	USB client data signal
4	USB_H1_PWR	USB host 1; 5V output power
5	GND	Common ground
6	GND	Common ground
7	USB_H1_D+	USB host 1 data signal
8	USB_H1_D-	USB host 1 data signal

Pin	Signal	Description
9	USBC_VBUS	USB client 5V detect from attached host (not used)

USB Host Connector

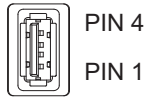

Pin	Signal	Description
1	5V_USB	USB Power, Current Limited
2	USB_H1_D-	USB D-
3	USB_H1_D+	USB D+
4	GND	USB Power Return
Shell	CGND	Chassis Ground

USB Host to Scanner Cable

D9 Male Connector

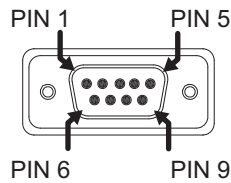

Pin	Signal	Description
1	Not used	
2	Not used	
3	Not used	
4	USB_H1_PWR	USB host 5V output power
5	GND	Common ground
6	Not used	
7	USB_H1_D+	USB host 1 data signal (twisted pair)
8	USB_H1_D-	USB host 1 data signal (twisted pair)
9	USBC_VBUS	USB client 5V detect from attached host

RJ50 Connector

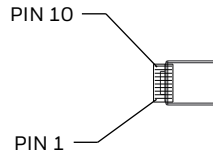

Pin	Signal	Description
1	Drain	To D9 connector shell
2	Not used	
3	GND	Common Ground
4	Not used	
5	Not used	
6	Not used	
7	USB_H1_PWR	USB host 5V output power
8	Not used	
9	USB_H1_D+	USB host 1 data signal (twisted pair)
10	USB_H1_D-	USB host 1 data signal (twisted pair)

USB2 Connector

The USB2 connector is only present on the Enhanced Dock.

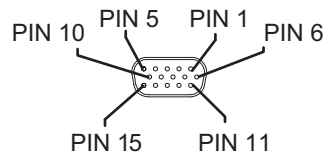

Pin	Signal	Description
1	Not used	
2	Not used	
3	Not used	
4	Not used	
5	Not used	
6	USB_H2_PWR	USB host 2 5V output power
7	USB_H2_D+	USB host 2 data signal
8	USB_H2_D-	USB host 2 data signal
9	GND	Common ground
10	GND	Common ground
11	USB_H3_PWR	USB host 3 5V output power
12	USB_H3_D+	USB host 3 data signal
13	USB_H3_D-	USB host 3 data signal

Pin	Signal	Description
14	GND	Common ground
15	GND	Common ground

USB Dual Host Y Cable

D15 Male Connector

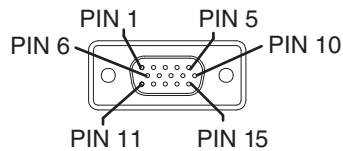

Pin	Signal	Description
1	Not Used	
2	Not Used	
3	Not Used	
4	Not Used	
5	Not Used	
6	USB_H2_PWR	USB host 2 5V output power
7	USB_H2_D+	USB host 2 data signal
8	USB_H2_D-	USB host 2 data signal
9	GND	Common ground
10	GND	Common ground
11	USB_H3_PWR	USB host 3 5V output power
12	USB_H3_D+	USB host 3 data signal
13	USB_H3_D-	USB host 3 data signal
14	GND	Common ground
15	GND	Common ground

USB Host Connectors

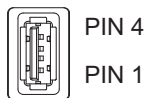

Pin	Signal	Description
1	5V_USB	USB Power, Current Limited
2	USB_H2_D-	USB D-
3	USB_H2_D+	USB D+
4	GND	USB Power Return

Pin	Signal	Description
Shell	CGND	Chassis Ground

Audio Connector

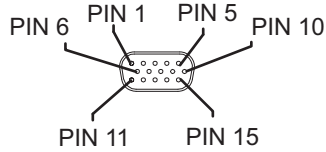

Pin	Signal	Description
1	-	CAN reserved
2	CAN_L	CAN_L bus line dominant low
3	CAN_GND	CAN Ground
4	-	CAN reserved
5	GND	Optional ground
6	Audio return	Headset return
7	Audio output	Headset output
8	Mic input	Microphone input
9	Mic return	Microphone output
10	Audio return	
11	GND	Optional ground
12	CAN_SHLD	
13	CAN_H	CAN_H bus line dominant high
14	-	CAN reserved
15	CAN_V+	Optional CAN external Power Supply

Headset Adapter Cable

D15 Female Connector

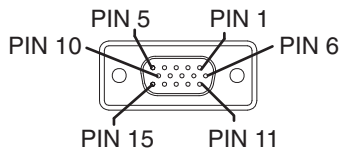

Pin	Signal	Description
1	Not used	
2	Not used	
3	Not used	
4	Not used	

Pin	Signal	Description
5	Not used	
6	Audio return	Headset return
7	Audio output	Headset output
8	Mic input	Microphone input
9	Mic return	Microphone return
10	Not used	
11	Not used	
12	Not used	
13	Not used	
14	Not used	
15	Not used	

Quick Connect Headset Connector

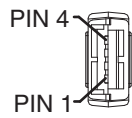

Pin	Signal	Description
1	Mic input	Microphone input
2	Mic return	Microphone return
3	Audio output	Headset output
4	Audio return	Headset return

AGENCY INFORMATION

Thor VM3A vehicle-mount computers meet or exceed the requirements of all applicable standards organizations for safe operation. The best way to ensure safe operation is to use the vehicle-mounted computer according to the agency guidelines in this user guide and on the regulatory sheet shipped with the vehicle-mounted computer. Read all guidelines before using your vehicle-mounted computer. To download product documentation for the Thor VM3A computer, go to www.honeywellaidc.com.

This documentation is relevant for the following Thor models: VM3ALON.

The EU declaration of conformity, if applicable, and other publicly downloadable certificates are available at www.honeywellaidc.com/compliance.

Label Locations

Compliance labels are located in the dock well area on the back of the Thor VM3A, as indicated by the shaded areas below. The VM3A must be removed from the dock to view the labels.

Model number, serial number and other identifiers are located on these labels.

Honeywell
9680 Old Bailes Road
Fort Mill, SC 29707

www.honeywellaidc.com