



FCC TEST REPORT (Part 24)

REPORT NO.: RF940825L08

MODEL NO.: MC7094

RECEIVED: Aug. 24, 2005

TESTED: Sep. 02 ~ Sep 24, 2005

ISSUED: Oct. 06, 2005

APPLICANT: Symbol Technologies Inc

ADDRESS: One Symbol Plaza, Holtsville, NY 11742, U.S.A.

ISSUED BY: Advance Data Technology Corporation

LAB ADDRESS: No. 47, 14th Ling, Chia Pau Tsuen, Lin Kou Hsiang
244, Taipei Hsien, Taiwan, R.O.C.

TEST LOCATION: No. 19, Hwa Ya 2nd Rd., Wen Hwa Tsuen, Kwei
Shan Hsiang, Taoyuan Hsien 333, Taiwan, R.O.C.

This test report consists of 55 pages in total. It may be duplicated completely for legal use with the approval of the applicant. It should not be reproduced except in full, without the written approval of our laboratory. The client should not use it to claim product endorsement by CNLA, A2LA or any government agencies. The test results in the report only apply to the tested sample.





TABLE OF CONTENTS

1	CERTIFICATION	4
2	SUMMARY OF TEST RESULTS	5
2.1	MEASUREMENT UNCERTAINTY	6
3	GENERAL INFORMATION.....	7
3.1	GENERAL DESCRIPTION OF EUT	7
3.2	DESCRIPTION OF TEST MODES	9
3.3	GENERAL DESCRIPTION OF APPLIED STANDARDS.....	10
3.4	DESCRIPTION OF SUPPORT UNITS.....	10
4	TEST TYPES AND RESULTS	11
4.1	MODULATION CHARACTERISTICS.....	11
4.1.1	DESCRIPTION OF MODULATION TECHNIQUE	11
4.1.2	THE ACTIVE TIME SLOT 8 MODULATED FRAME PLOT	12
4.2	OUTPUT POWER MEASUREMENT	13
4.2.1	LIMITS OF OUTPUT POWER MEASUREMENT	13
4.2.2	TEST INSTRUMENTS	14
4.2.3	TEST PROCEDURES.....	15
4.2.4	TEST SETUP	16
4.2.5	EUT OPERATING CONDITIONS.....	17
4.2.6	TEST RESULTS.....	18
4.3	FREQUENCY STABILITY MEASUREMENT	20
4.3.1	LIMITS OF FREQUENCY STABILITY MEASUREMENT	20
4.3.2	TEST INSTRUMENTS	20
4.3.3	TEST PROCEDURE	21
4.3.4	TEST SETUP	21
4.3.5	TEST RESULTS.....	22
4.4	OCCUPIED BANDWIDTH MEASUREMENT.....	24
4.4.1	LIMITS OF OCCUPIED BANDWIDTH MEASUREMENT	24
4.4.2	TEST INSTRUMENTS	24
4.4.3	TEST SETUP	24
4.4.4	TEST PROCEDURES.....	25
4.4.5	EUT OPERATING CONDITION.....	25
4.4.6	TEST RESULTS.....	26
4.5	BAND EDGE MEASUREMENT	28
4.5.1	LIMITS OF BAND EDGE MEASUREMENT.....	28
4.5.2	TEST INSTRUMENTS	28



4.5.3	TEST SETUP	28
4.5.4	TEST PROCEDURES.....	29
4.5.5	EUT OPERATING CONDITION	29
4.5.6	TEST RESULTS.....	30
4.6	CONDUCTED SPURIOUS EMISSIONS.....	31
4.6.1	LIMITS OF CONDUCTED SPURIOUS EMISSIONS MEASUREMENT ...	31
4.6.2	TEST INSTRUMENTS	31
4.6.3	TEST PROCEDURE	32
4.6.4	TEST SETUP	32
4.6.5	EUT OPERATING CONDITIONS.....	32
4.6.6	TEST RESULTS.....	33
4.7	RADIATED EMISSION MEASUREMENT (BELOW 1GHz)	42
4.7.1	LIMITS OF RADIATED EMISSION MEASUREMENT	42
4.7.2	TEST INSTRUMENTS	43
4.7.3	TEST PROCEDURES.....	44
4.7.4	DEVIATION FROM TEST STANDARD	44
4.7.5	TEST SETUP	45
4.7.6	EUT OPERATING CONDITIONS.....	45
4.7.7	TEST RESULTS.....	46
4.8	EFFECTIVE RADIATED POWER MEASUREMENT (ABOVE 1GHz)	47
4.8.1	LIMITS OF RADIATED EMISSION MEASUREMENT	47
4.8.2	TEST INSTRUMENTS	48
4.8.3	TEST PROCEDURES.....	49
4.8.4	DEVIATION FROM TEST STANDARD	49
4.8.5	TEST SETUP	50
4.8.6	EUT OPERATING CONDITIONS.....	50
4.8.7	TEST RESULTS.....	51
5	PHOTOGRAPHS OF THE TEST CONFIGURATION.....	54
6	INFORMATION ON THE TESTING LABORATORIES	55



1 CERTIFICATION

PRODUCT : EDA (Enterprise Digital Assistant)
MODEL NO. : MC7094
BRAND NAME: Symbol
APPLICANT : Symbol Technologies Inc
TESTED : Sep. 02 ~ Sep 24, 2005
TEST SAMPLE : PROTOTYPE
TEST STANDARDS : **FCC Part 24, Subpart E**
ANSI C63.4-2003

The above equipment has been tested by **Advance Data Technology Corporation**, and found compliance with the requirement of the above standards. The test record, data evaluation & Equipment Under Test (EUT) configurations represented herein are true and accurate accounts of the measurements of the sample's EMC characteristics under the conditions specified in this report.

PREPARED BY : Wendy Liao , **DATE:** Oct. 06, 2005
Wendy Liao

TECHNICAL
ACCEPTANCE : Gary Chang , **DATE:** Oct. 06, 2005
Responsible for RF Gary Chang

APPROVED BY : Cody Chang , **DATE:** Oct. 06, 2005
Cody Chang / Deputy Manager

2 SUMMARY OF TEST RESULTS

The EUT has been tested according to the following specifications:

APPLIED STANDARD: FCC Part 24 & Part 2 / IC RSS-133			
STANDARD SECTION	TEST TYPE AND LIMIT	RESULT	REMARK
2.1047(d)	Modulation Characteristics	PASS	NA
2.1046 24.232	Maximum Peak Output Power Limit: max. 2 watts e.i.r.p peak power	PASS	Meet the requirement of limit. Minimum passing margin is 29.15dBm at 1909.80MHz.
2.1055 24.235	Frequency Stability AFC Freq. Error vs. Voltage AFC Freq. Error vs. Temperature Limit: max. ± 2.5 ppm	PASS	Meet the requirement of limit.
2.1049 24.238(b)	Occupied Bandwidth	PASS	Meet the requirement of limit.
24.238(b)	Band Edge Measurements	PASS	NA
2.1051 24.238	Conducted Spurious Emissions	PASS	Meet the requirement of limit. Minimum passing margin is -27.95dB at 11100.00MHz.
2.1053 24.238	Radiated Spurious Emissions	PASS	Meet the requirement of limit. Minimum passing margin is -45.47dB at 88.32MHz.



2.1 MEASUREMENT UNCERTAINTY

Where relevant, the following measurement uncertainty levels have been estimated for tests performed on the EUT as specified in CISPR 16-4:

MEASUREMENT	FREQUENCY	UNCERTAINTY
Conducted emissions	9kHz ~ 30MHz	2.44 dB
Radiated emissions	30MHz ~ 200MHz	3.55 dB
	200MHz ~ 1000MHz	3.58 dB
	1GHz ~ 18GHz	1.10 dB
	18GHz ~ 40GHz	0.91 dB

This uncertainty represents an expanded uncertainty expressed at approximately the 95% confidence level using a coverage factor of $k=2$.



3 GENERAL INFORMATION

3.1 GENERAL DESCRIPTION OF EUT

PRODUCT	EDA (Enterprise Digital Assistant)
MODEL NO.	MC7094
POWER SUPPLY	3.7Vdc from rechargeable lithium battery 5.4Vdc from power adapter for charger 12.0Vdc from power adapter for cradle
MODULATION TYPE	GMSK / 8BPSK
FREQUENCY RANGE	Tx Frequency: 1850.2MHz ~ 1909.8MHz (PCS band) Rx Frequency: 1930.2MHz ~ 1989.8MHz (PCS band)
NUMBER OF CHANNEL	299
MAX. CONDUCTED PEAK OUTPUT POWER	29.33dBm (0.857Watts)
MAX. EIRP POWER	29.15dBm (0.822Watts)
ANTENNA TYPE	Internal PIFA antenna with 0dBi gain (For PCS band)
DATA CABLE	0.92m non-shielded cable for earphone
I/O PORTS	Refer to user's manual
ASSOCIATED DEVICES	Earphone, cradle
EUT EXTREME VOL. RANGE	3.3Vdc to 4.2Vdc

NOTE:

1. The applicant defined the normal working voltage of the battery is from 3.3Vdc to 4.2Vdc.
2. The EUT is an EDA (Enterprise Digital Assistant) with wireless LAN, bluetooth and mobile phone functions. This report is only covered the functions of PCS1900. The wireless LAN and bluetooth functions are covered in another test report, which standard used is FCC Part 15. And the GSM850 mobile phone function is covered in another test report, which standard used is FCC Part 22.
3. IMEI Code: 355634 000001 ~ 999999.



4. The EUT have two lithium batteries listed as below:

HEAVY BATTERY:	
BRAND:	Symbol
MODEL:	82-71364-01
RATING:	3.7Vdc, 3800mAh

MAIN BATTERY:	
BRAND:	Symbol
MODEL:	82-71363-01
RATING:	3.7Vdc, 1900mAh

5. The cradle was operated with following power adapter:

BRAND:	HIPRO
MODEL:	HP-O2040D43
INPUT:	100-240Vac, 50-60Hz, 1.5A
OUTPUT:	12Vdc, 3.33A
POWER LINE:	AC 1.8m non-shielded cable without core DC 1.8m non-shielded cable with one core

6. The EUT was operated with following charging cable:

BRAND:	Delta
MODEL:	ADP-16GB A
INPUT:	100-240Vac, 50-60Hz, 0.4A
OUTPUT:	5.4Vdc, 3A
POWER LINE:	AC 0.7m non-shielded cable without core DC 1.87m non-shielded cable with one core

7. The above EUT information was declared by manufacturer and for more detailed features description, please refer to the manufacturer's specifications or User's Manual.



3.2 DESCRIPTION OF TEST MODES

299 channels are provided to this EUT in the PCS1900 band. Therefore, the low, middle and high channels are chosen for testing.

	CHANNEL	FREQUENCY	TX MODE
LOW	512	1850.2 MHz	GSM
MIDDLE	661	1880.0 MHz	GSM
HIGH	810	1909.8 MHz	GSM

NOTE:

1. Below 1 GHz, the channel 512, 661, and 810 were pre-tested in chamber. The channel 512 was chosen for final test.
2. Above 1 GHz, the channel 512, 661, and 810 were tested individually.
3. When the Power Control Level set 0, the worst case, was chosen for final test.
4. The channel space is 0.2MHz.
5. Since the EUT is considered a portable unit, it was pre-tested on the positioned of each 3 axis. The worst case was found when positioned on Y-plane. Therefore only the test data of this Y-plane was used for radiated emission measurement test.
6. The EDA supports two battery options, Heavy (high capacity) and Main (normal). Both options were assessed and the heavy battery was found to be worst case and was selected for the final test configuration
7. The EUT is a GPRS class 12 device, which provide 4 up-link / E-GPRS class 10 device, which provide 2 up-link.
8. The EUT have GSM, GPRS, E-GPRS functions. After pre-testing, GSM function is the worst case for the final test, and recorded in this report.



3.3 GENERAL DESCRIPTION OF APPLIED STANDARDS

The EUT is a EDA (Enterprise Digital Assistant). According to the specifications of the manufacturer, it must comply with the requirements of the following standards:

FCC 47 CFR Part 2

FCC 47 CFR Part 24

IC RSS-133

ANSI C63.4-2003

NOTE: All test items have been performed and recorded as per the above standards.

3.4 DESCRIPTION OF SUPPORT UNITS

The EUT has been tested as an independent unit together with other necessary accessories or support units. The following support units or accessories were used to form a representative test configuration during the tests.

NO.	PRODUCT	BRAND	MODEL NO.	SERIAL NO.	CAL. DATE
1	Universal Radio Communication Tester	R&S	CMU200	101095	Oct. 10, 2005

NO.	SIGNAL CABLE DESCRIPTION OF THE ABOVE SUPPORT UNITS
1	NA

NOTE: All power cords of the above support units are non shielded (1.8m).



4 TEST TYPES AND RESULTS

4.1 MODULATION CHARACTERISTICS

4.1.1 DESCRIPTION OF MODULATION TECHNIQUE

According to FCC 2.1047(d), the system is used the digital modulation and accomplished with the PCS requirement as defined in the 3GPP TS 05:01, TS 05:02, TS 05:04. It uses narrowband TDMA. Eight simultaneous calls can occupy the same radio frequency.

There are 299 channels and channel space is 200kHz. The frequency band 1850 ~ 1910MHz is allocated to the uplink and 1930 ~ 1990MHz to the downlink. The uplink and downlink channel space is 80MHz and is duplex at the same time.

The modulation scheme used the GMSK (Gaussian Minimum Shift Keying) that is the special case of FSK (frequency Shift Keying). The each time slot is last about 580 μ s and data length is 156.25bits. A frame contains the eight time slots.



4.1.2 THE ACTIVE TIME SLOT 8 MODULATED FRAME PLOT

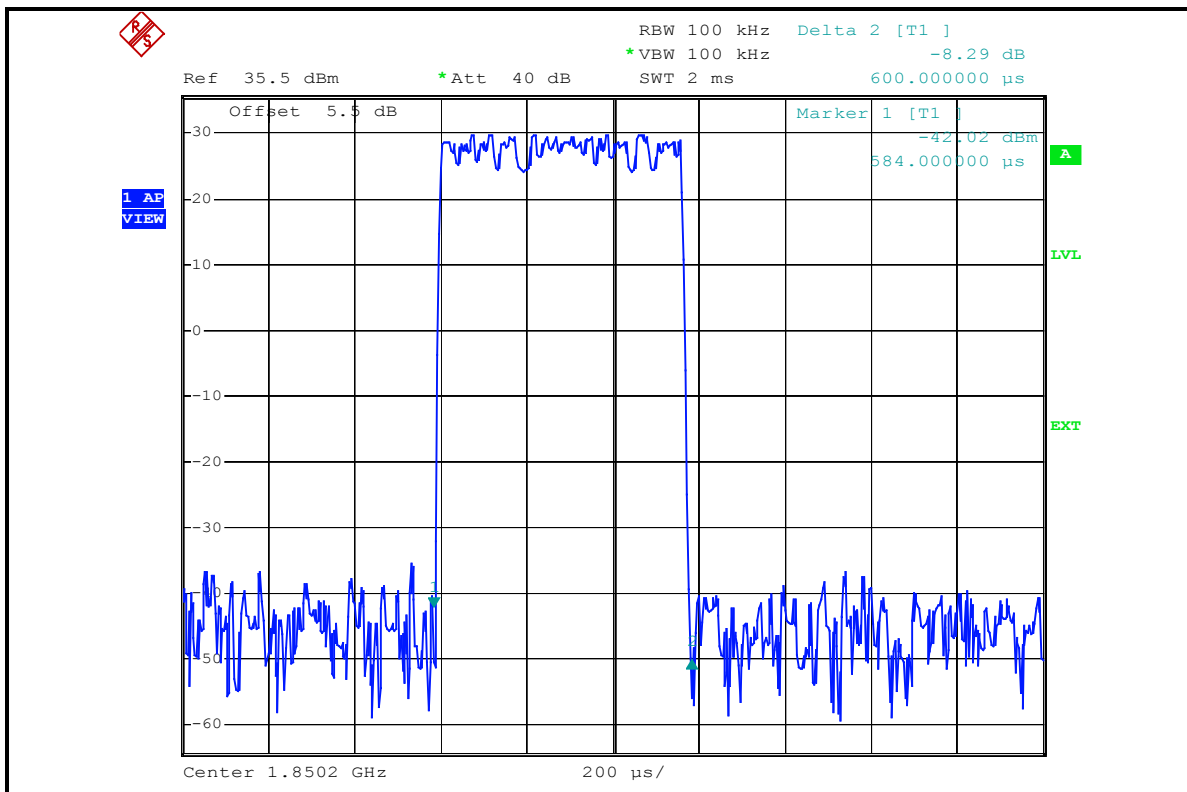
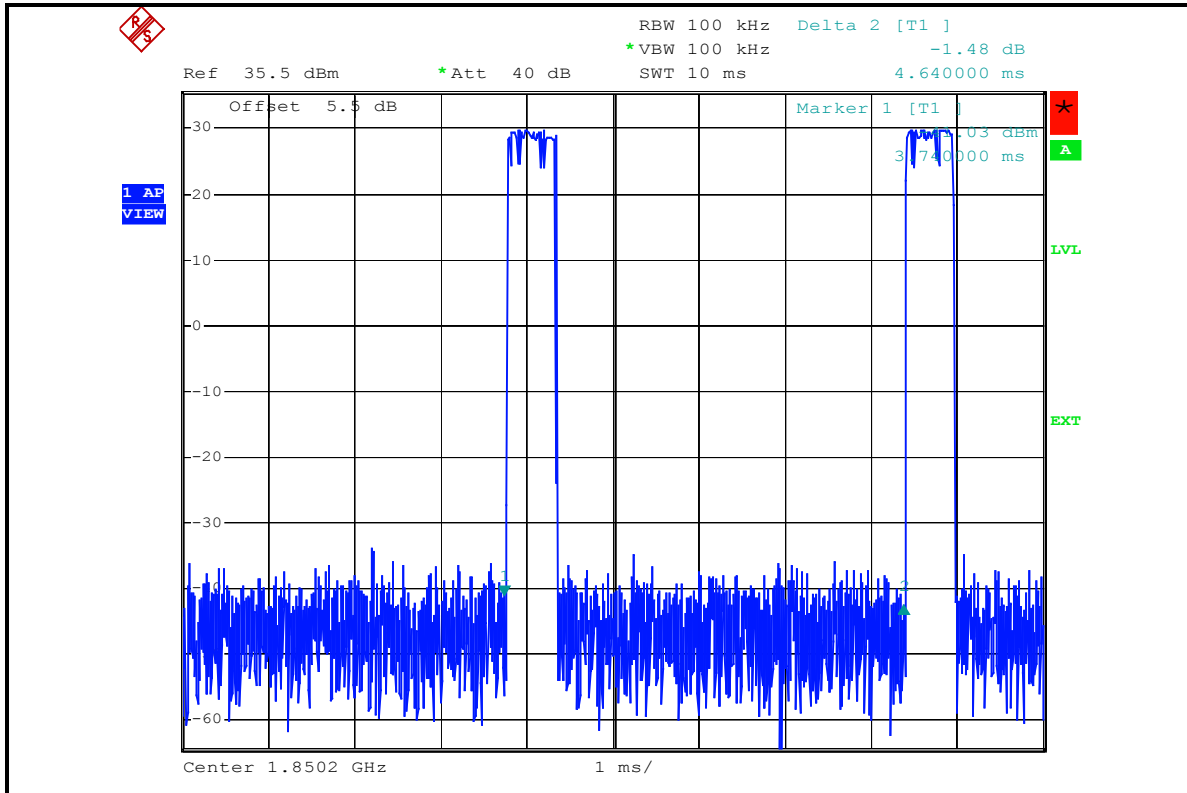



4.2 OUTPUT POWER MEASUREMENT

4.2.1 LIMITS OF OUTPUT POWER MEASUREMENT

The radiated peak output power shall be according to the specific rule Part 24.232(b) that “Mobile / Portable station are limited to 2 watts e.i.r.p” and 24.232(c) specific that “Peak transmit power must be measure over any interval of continuous transmission using instrumentation calibration in terms of rms-equivalent voltage.”



4.2.2 TEST INSTRUMENTS

DESCRIPTION & MANUFACTURER	MODEL NO.	SERIAL NO.	CALIBRATED UNTIL
Test Receiver ROHDE & SCHWARZ	ESIB7	100188	Dec. 19, 2005
Spectrum Analyzer ROHDE & SCHWARZ	FSP40	100039	Nov. 21, 2005
BILOG Antenna SCHWARZBECK	VULB9168	9168-157	Jan. 22, 2006
HORN Antenna SCHWARZBECK	BBHA 9120 D	9120D-407	Jan. 16, 2006
HORN Antenna SCHWARZBECK	BBHA 9170	BBHA 9170241	Feb. 23, 2006
Preamplifier Agilent	8449B	3008A01961	Nov. 09, 2005
Preamplifier Agilent	8447D	2944A10629	Nov. 09, 2005
RF signal cable HUBER+SUHNER	SUCOFLEX 104	218182/4	Feb. 17, 2006
RF signal cable HUBER+SUHNER	SUCOFLEX 104	218194/4	Feb. 17, 2006
Software ADT.	ADT_Radiated_V5.14	NA	NA
Antenna Tower ADT.	AT100	AT93021702	NA
Turn Table ADT.	TT100.	TT93021702	NA
Controller ADT.	SC100.	SC93021702	NA

- NOTE:**
1. The calibration interval of the above test instruments is 12 months and the calibrations are traceable to NML/ROC and NIST/USA.
 2. The test was performed in HwaYa Chamber 1.
 3. The horn antenna and HP preamplifier (model: 8449B) are used only for the measurement of emission frequency above 1GHz if tested.
 4. The IC Site Registration No. is IC4924-2.



4.2.3 TEST PROCEDURES

- a. The EUT was set up for the maximum peak power with GSM link data modulation. The power was measured with R&S Spectrum Analyzer. All measurements were done at 3 channels, 512, 661 and 810(low, middle and high operational frequency range.)
- b. The conducted peak output power used the power splitter via EUT RF power connector between simulation base station and spectrum analyzer. The path loss included the splitter loss, cable loss and 20dB pad loss. The spectrum set RB/VB 3MHz, then read peak power value and record to the test. (All transmitted path loss shall be considered in the test report data.)
- c. E.I.R.P peak power measurement. In the fully anechoic chamber, EUT placed on the 1.5m height of Turn Table, rotated the table around 360 degrees to search the maximum radiation power and receiver antenna shall be rotated vertical and horizontal polarization to find the maximum polar radiated power. The “Read Value” is the spectrum reading the maximum power value.
- d. The substitution horn antenna is substituted for EUT at the same position and signal generator export the CW signal to the calibration antenna. Rotated the Turn Table to find the maximum radiation power. “Raw” is the spectrum reading value, “SG” is signal generator export power, “TX Gain” is calibration antenna isotropic gain value, “TX cable” is the transmitted cable loss between the calibration antenna and signal generator. The “Factor” means that the transmission path loss is equal to “SG” - “TX cable” + “TX Gain” – “Raw”.
- e. Actually the real E.I.R.P peak power is equal to “Read Value” + “Factor”
- f. E.R.P power can be calculated form E.I.R.P power by subtracting the gain of dipole, E.R.P power = E.I.P.R power - 2.15dBi.

NOTE: The resolution bandwidth and video bandwidth of test receiver/spectrum analyzer is 3MHz for Peak detection (PK)

4.2.4 TEST SETUP

EIRP POWER MEASUREMENT:

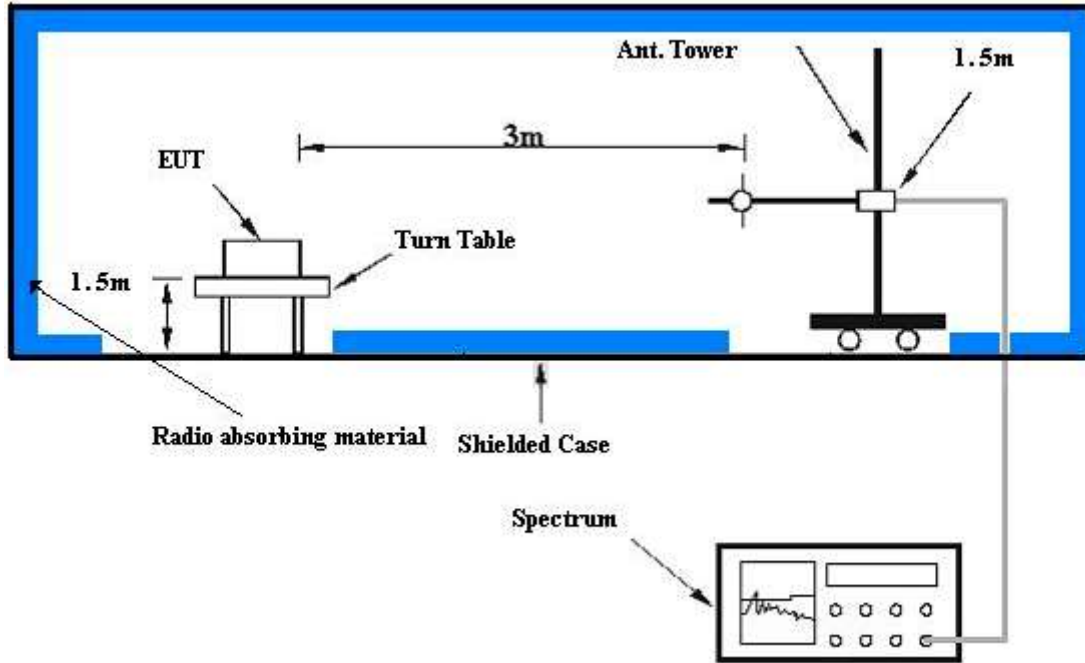

For the actual test configuration, please refer to the related item – Photographs of the Test Configuration.

CONDUCTED POWER MEASUREMENT:

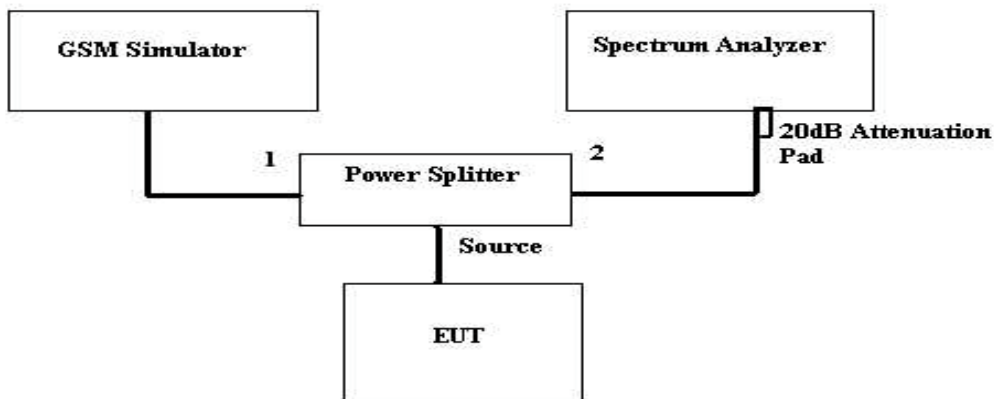

For the actual test configuration, please refer to the related item – Photographs of the Test Configuration.



4.2.5 EUT OPERATING CONDITIONS

- a. The EUT makes a phone call to the GSM simulator.
- b. The GSM simulator station system controlled an EUT to export maximum output power under transmission mode and specific channel frequency.



4.2.6 TEST RESULTS

EUT	EDA (Enterprise Digital Assistant)	MODEL	MC7094
MODE	TX connected	POWER CONTROL LEVEL	0
INPUT POWER (SYSTEM)	120Vac, 60 Hz	DETECTOR FUNCTION	Peak
ENVIRONMENTAL CONDITIONS	26deg. C, 65%RH, 991hPa	TESTED BY	Long Chen

CONDUCTED PEAK OUTPUT POWER					
CHANNEL NO.	FREQUENCY (MHz)	RAW VALUE (dBm)	CORRECTION FACTOR (dB)	PEAK OUTPUT POWER	
				dBm	Watt
512	1850.2	23.83	5.50	29.33	0.857
661	1880.0	23.72	5.50	29.22	0.836
810	1909.8	23.62	5.50	29.12	0.817

REMARKS: 1. Peak Output Power (dBm) = Raw Value (dBm) + Correction Factor (dB).
 2. Correction Factor (dB) = Power Splitter Loss (dB) + Cable Loss (dB).



EUT	EDA (Enterprise Digital Assistant)	MODEL	MC7094
MODE	TX connected	POWER CONTROL LEVEL	0
INPUT POWER (SYSTEM)	120Vac, 60 Hz	DETECTOR FUNCTION	Peak
ENVIRONMENTAL CONDITIONS	26deg. C, 65%RH, 991hPa	TESTED BY	Long Chen

EIRP RADIATED PEAK OUTPUT POWER					
CHANNEL NO.	FREQUENCY (MHz)	RAW VALUE (dBm)	CORRECTION FACTOR (dB)	PEAK OUTPUT POWER	
				dBm	Watt
512	1850.2	-11.50	40.39	28.89	0.774
661	1880.0	-11.60	40.67	29.07	0.807
810	1909.8	-11.80	40.95	29.15	0.822

REMARKS: 1. Peak Output Power (dBm) = Raw Value (dBm) + Correction Factor (dB).
 2. Correction Factor (dB) = Receiver Antenna Gain (dBi) + Cable Loss (dB) + Free Space Loss (dB).



4.3 FREQUENCY STABILITY MEASUREMENT

4.3.1 LIMITS OF FREQUENCY STABILITY MEASUREMENT

According to the FCC part 2.4235 shall be tested the frequency stability. The rule is defined that "The frequency stability shall be sufficient to ensure that the fundamental emission stays within the authorized frequency block." The frequency error rate is according to the JTC standard that the frequency error rate shall be accurate to within 2.5ppm of the received frequency from the base station. The test extreme voltage is according to the 2.1055(d)(1) Vary primary supply voltage from 85 to 115 percent of the nominal value for other than hand carried battery equipment and the extreme temperature rule is comply with the 2.1055(a)(1) $-30^{\circ}\text{C} \sim 50^{\circ}\text{C}$.

4.3.2 TEST INSTRUMENTS

DESCRIPTION & MANUFACTURER	MODEL NO.	SERIAL NO.	CALIBRATED UNTIL
* Hewlett Packard RF cable	8120-6192	01428251	NA
* Suhner RF cable	Sucoflex104	204850/4	NA
* WIT Standard Temperature & Humidity Chamber	TH-4S-C	W981030	Jul. 18, 2006

- NOTE:**
1. The calibration interval of the above test instruments is 12 months. And the calibrations are traceable to NML/ROC and NIST/USA.
 2. "*" = These equipments are used for the final measurement.
 3. The test was performed in ADT RF OVEN room.



4.3.3 TEST PROCEDURE

- a. Because of the measure the carrier frequency under the condition of the AFC lock, it shall be used the mobile station in the GSM / GPRS / E-GPRS link mode. This is accomplished with the use of the R&S CMU200 simulator station. The oven room could control the temperatures and humidity. The GSM link channel is the 661.
- b. Power must be removed when changing from one temperature to another or one voltage to another voltage. Power warm up is at least 15 min and power applied should perform before recording frequency error.
- c. EUT is connected the external power supply to control the DC input power. The various Volts from the minimum 3.3 Volts to 4.2 Volts. Each step shall be record the frequency error rate.
- d. The temperature range step is 10 degrees in this test items. All temperature levels shall be hold the $\pm 0.5^{\circ}\text{C}$ during the measurement testing.
- e. The each temperature step shall be at least 0.5 hours, consider the EUT could be test under the stability condition.

NOTE: The frequency error was recorded frequency error from the GSM simulator.

4.3.4 TEST SETUP

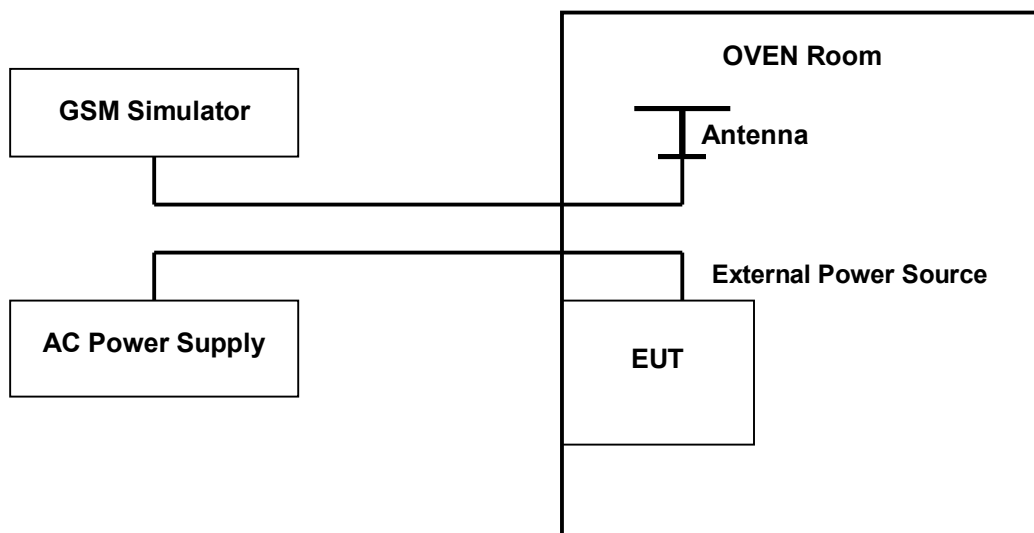



4.3.5 TEST RESULTS

EUT	EDA (Enterprise Digital Assistant)	MODEL	MC7094
MODE	TX channel 661	POWER CONTROL LEVEL	0
INPUT POWER (SYSTEM)	120Vac, 60 Hz	ENVIRONMENTAL CONDITIONS	26deg. C, 65%RH, 991hPa
TESTED BY	Long Chen		

AFC FREQUENCY ERROR vs. VOLTAGE			
VOLTAGE (Volts)	FREQUENCY ERROR (Hz)	FREQUENCY ERROR (ppm)	LIMIT (ppm)
3.3	-13	-0.007027027	2.5
3.4	-11	-0.005945946	2.5
3.5	-15	-0.008108108	2.5
3.6	-12	-0.006486486	2.5
3.7	-13	-0.007027027	2.5
3.8	-15	-0.008108108	2.5
3.9	-14	-0.007567568	2.5
4.0	-18	-0.00972973	2.5
4.1	-14	-0.007567568	2.5
4.2	-16	-0.008648649	2.5

NOTE: The applicant defined the normal working voltage of the battery is from 3.3Vdc to 4.2Vdc.



EUT	EDA (Enterprise Digital Assistant)	MODEL	MC7094
MODE	TX channel 661	POWER CONTROL LEVEL	0
INPUT POWER (SYSTEM)	120Vac, 60 Hz	ENVIRONMENTAL CONDITIONS	26deg. C, 65%RH, 991hPa
TESTED BY	Long Chen		

AFC FREQUENCY ERROR vs. VOLTAGE			
TEMP. (°C)	FREQUENCY ERROR (Hz)	FREQUENCY ERROR (ppm)	LIMIT (ppm)
50	-10	-0.005405405	2.5
40	-9	-0.004864865	2.5
30	-8	-0.004324324	2.5
20	-5	-0.002702703	2.5
10	-2	-0.001081081	2.5
0	-6	-0.003243243	2.5
-10	-10	-0.005405405	2.5
-20	-8	-0.004324324	2.5
-30	-12	-0.006486486	2.5



4.4 OCCUPIED BANDWIDTH MEASUREMENT

4.4.1 LIMITS OF OCCUPIED BANDWIDTH MEASUREMENT

According to FCC 24.238(b) specified that emission bandwidth is defined as the width of the signal between two points, one below the carrier center frequency and one above the carrier center frequency, outside of which all emissions are attenuated at least 26 dB below the transmitter power.

4.4.2 TEST INSTRUMENTS

DESCRIPTION & MANUFACTURER	MODEL NO.	SERIAL NO.	CALIBRATED UNTIL
* ROHDE & SCHWARZ Spectrum Analyzer	FSP40	100035	Apr. 13, 2006
* Mini-Circuits Power Splitter	ZAPD-4	400005	NA
* Hewlett Packard RF cable	8120-6192	01428251	NA
* JFW 20dB attenuation	50HF-020-SMA	NA	NA
* Suhner RF cable	Sucoflex104	204850/4	NA

- NOTE:** 1. The calibration interval of the above test instruments is 12 months. And the calibrations are traceable to NML/ROC and NIST/USA.
2. "*" = These equipments are used for the final measurement.

4.4.3 TEST SETUP

Same as Item 4.2.4 (Conducted Power Setup)



4.4.4 TEST PROCEDURES

- a. The EUT was set up for the maximum peak power with GSM link data modulation. The power was measured with R&S Spectrum Analyzer. All measurements were done at 3 channels, 512, 661 and 810(low, middle and high operational frequency range.)
- b. The conducted occupied bandwidth used the power splitter via EUT RF power connector between simulation base station and spectrum analyzer. This splitter loss and cable loss are the worst loss 4dB in the transmitted path track.
- c. FCC 24.238(b) required a measurement bandwidth is the fundamental emission below 26dB bandwidth.

4.4.5 EUT OPERATING CONDITION

- a. The EUT makes a phone call to the GSM simulator.
- b. The GSM simulator station system controlled a EUT to export maximum and minimum output power under transmission mode and specific channel frequency Same as Item 4.4.5



4.4.6 TEST RESULTS

FREQUENCY (MHz)	OUTPUT POWER -26 dBc BANDWIDTH (kHz)
1850.2	282
1880.0	300
1909.8	308

CH 512 POWER

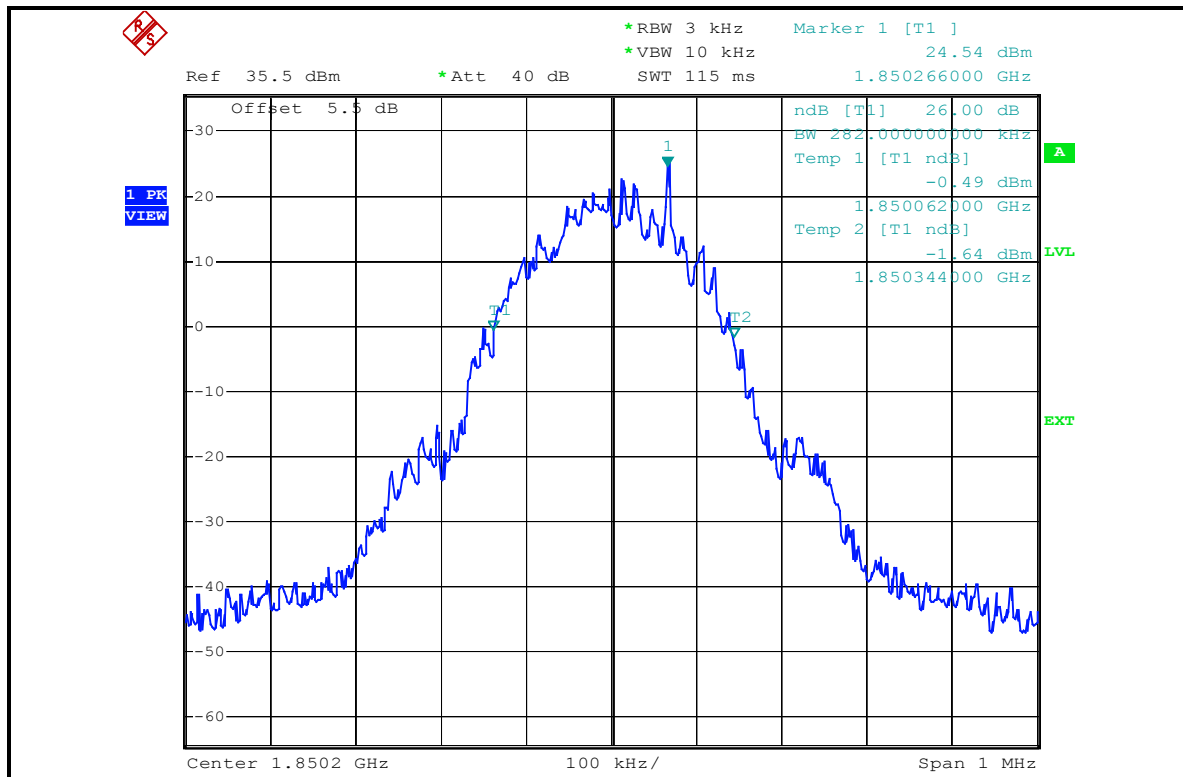



CH 661 POWER

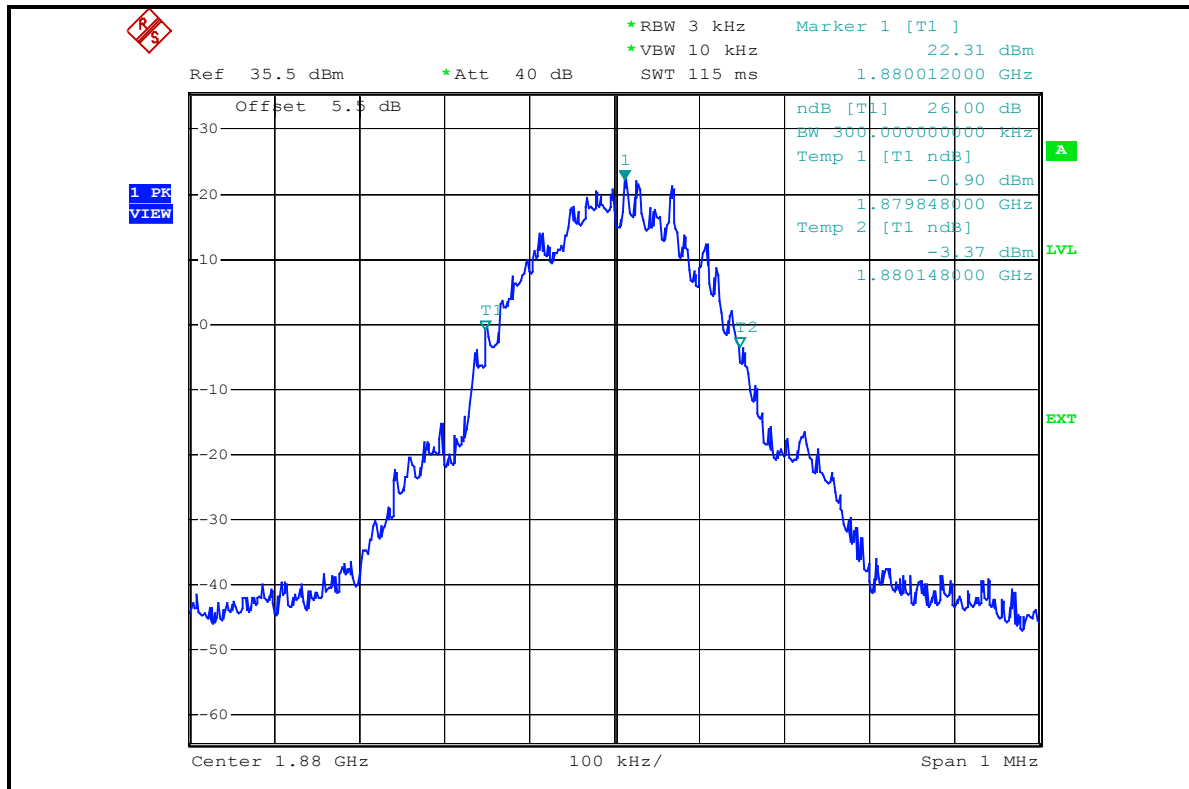

CH 810 POWER

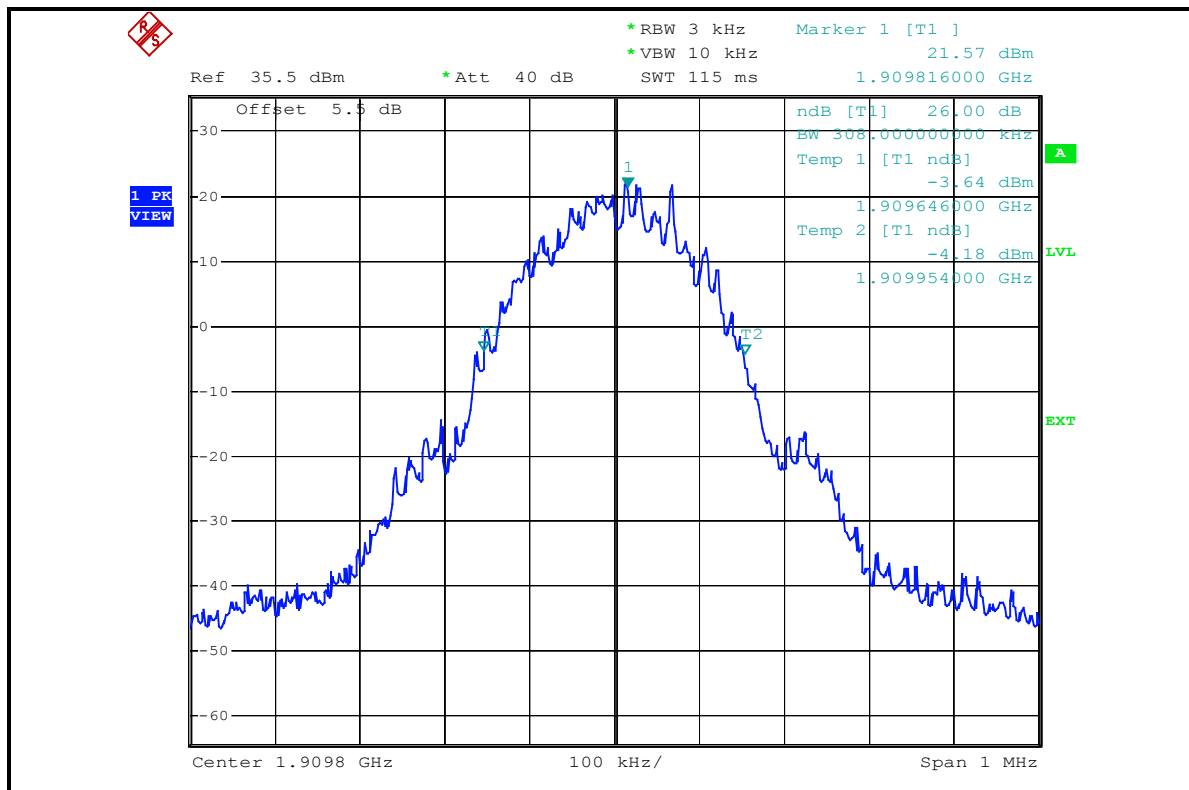



4.5 BAND EDGE MEASUREMENT

4.5.1 LIMITS OF BAND EDGE MEASUREMENT

The PCS frequency bands refer to the FCC 24.229 rule. According to FCC 24.238(a) specified that power of any emission outside of the authorized operating frequency ranges must be attenuated below the transmitting power (P) by a factor of at least $43 + 10 \log(P)$ dB. In the 1 MHz bands immediately outside and adjacent to the frequency block a resolution bandwidth of at least one percent of the emission bandwidth of the fundamental emission of the transmitter may be employed. Then we measure that the bandwidth is about 300kHz and the resolution bandwidth is 3kHz.

4.5.2 TEST INSTRUMENTS

DESCRIPTION & MANUFACTURER	MODEL NO.	SERIAL NO.	CALIBRATED UNTIL
* ROHDE & SCHWARZ Spectrum Analyzer	FSP40	100035	Apr. 13, 2006
* Mini-Circuits Power Splitter	ZAPD-4	400005	NA
* Hewlett Packard RF cable	8120-6192	01428251	NA
* JFW 20dB attenuation	50HF-020-SMA	NA	NA
* Suhner RF cable	Sucoflex104	204850/4	NA

NOTE: 1. The calibration interval of the above test instruments is 12 months. And the calibrations are traceable to NML/ROC and NIST/USA.

2. "*" = These equipments are used for the final measurement.

4.5.3 TEST SETUP

Same as Item 4.2.4 (Conducted Power Setup)



4.5.4 TEST PROCEDURES

- a. The EUT was set up for the maximum peak power with GSM link data modulation. The power was measured with R&S Spectrum Analyzer. All measurements were done at 2 channels, 512 and 810(low and high operational frequency range.)
- b. The band edge measurement used the power splitter via EUT RF power connector between simulation base station and spectrum analyzer. This splitter loss and cable loss are the worst loss 4dB in the transmitted path track.
- c. The center frequency of spectrum is the band edge frequency and span is 1.5 MHz. RB of the spectrum is 3kHz and VB of the spectrum is 10KHz.
- d. Record the max trace plot into the test report.

4.5.5 EUT OPERATING CONDITION

- a. The EUT makes a phone call to the GSM simulator.
- b. The GSM simulator station system controlled a EUT to export maximum output power under transmission mode and specific channel frequency Same as Item 4.4.5.



4.5.6 TEST RESULTS

LOWER BAND EDGE

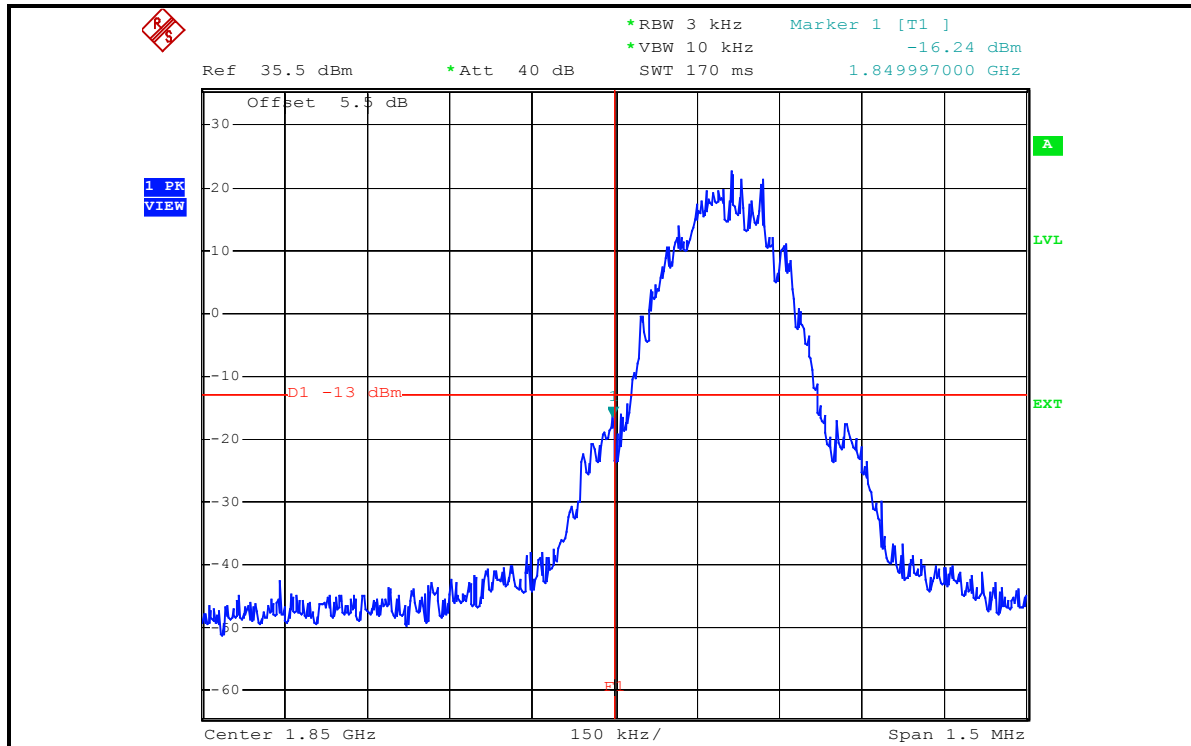

HIGHER BAND EDGE

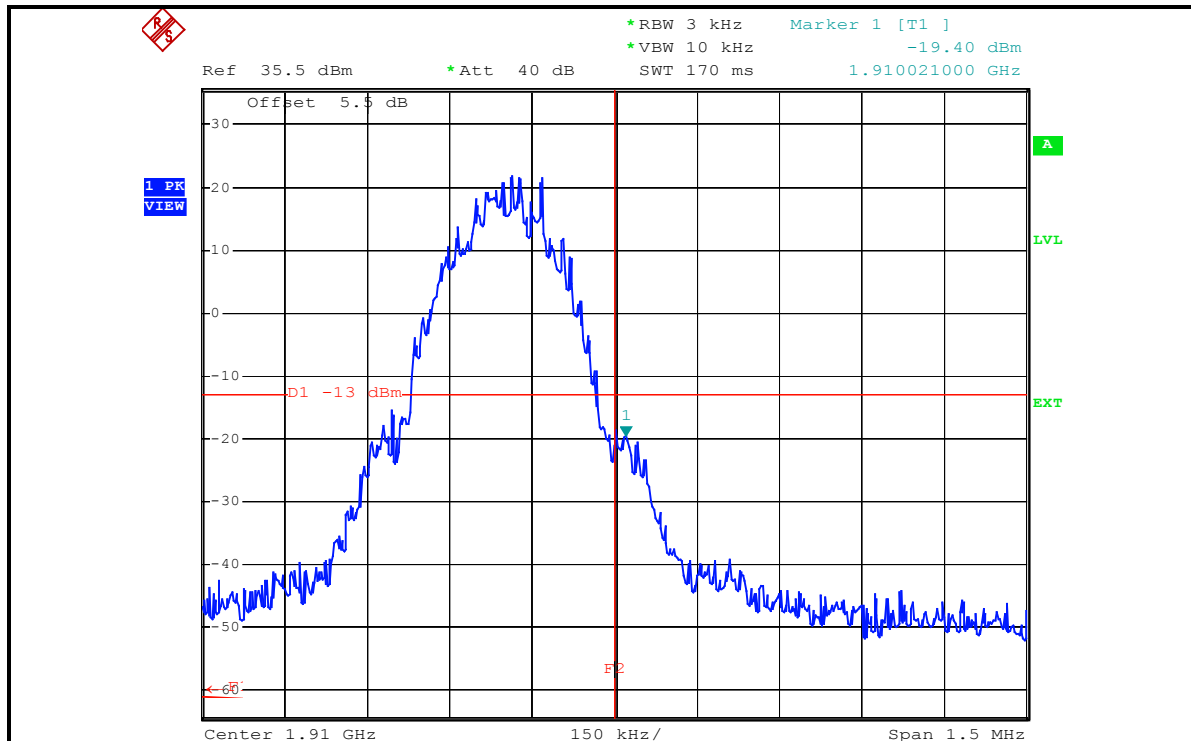



4.6 CONDUCTED SPURIOUS EMISSIONS

4.6.1 LIMITS OF CONDUCTED SPURIOUS EMISSIONS MEASUREMENT

In the FCC 24.238(a), On any frequency outside a licensee's frequency block within USPCS spectrum, the power of any emission shall be attenuated below the transmitter power (P) by at least $43 + 10 \log (P)$ dB. The limit translates in the relevant power range (1 to 0.001W). At 1W(Power Control Level 0) the specified minimum attenuation becomes 43dB and the limit of emission equal to -13dBm . At 0.001W(Power Control Level 15) the specified minimum attenuation becomes 13dB and the emission of limit equal to -13dBm . So the limit of emission is the same absolute specified line. In the FCC 24.238(c), When measuring the emission limits, the nominal carrier frequency shall be adjusted as close to the licensee's frequency block edges (low channel 512 and high channel 810), both upper and lower edges are compliance with FCC 24.238(b), Adjacent to the frequency block a resolution bandwidth of at least one percent of the emission bandwidth of the fundamental emission of the transmitter may be employed.

4.6.2 TEST INSTRUMENTS

DESCRIPTION & MANUFACTURER	MODEL NO.	SERIAL NO.	CALIBRATED UNTIL
* ROHDE & SCHWARZ Spectrum Analyzer	FSP40	100035	Apr. 13, 2006
* Wainwright Instruments Band Reject Filter	WRCG1850/1910- 1830/1930-60/10SS	SN1	NA
* Wainwright Instruments High Pass Filter	WHK3.1/18G-10SS	SN1	NA
* Mini-Circuits Power Splitter	ZAPD-4	400005	NA
* Hewlett Packard RF cable	8120-6192	01428251	NA
* JFW 20dB attenuation	50HF-020-SMA	NA	NA
* Suhner RF cable	Sucoflex104	204850/4	NA

- NOTE:**
1. The calibration interval of the above test instruments is 12 months. And the calibrations are traceable to NML/ROC and NIST/USA.
 2. "*" = These equipments are used for the final measurement.

4.6.3 TEST PROCEDURE

- a. The EUT was set up for the maximum peak power with GSM link data modulation. The power was measured with R&S Spectrum Analyzer. All measurements were done at 3 channels, 512, 661 and 810(low, middle and high operational frequency range.)
- b. The conducted spurious emission used the power splitter via EUT RF power connector between simulation base station and spectrum analyzer. This splitter loss and cable loss are the worst loss 4dB in the transmitted path track.
- c. When the spectrum scanned from 9kHz to 3GHz, it shall be connected to the band reject filter attenuated the carried frequency. The spectrum set RB/VB 1MHz.
- d. When the spectrum scanned from 3kHz to 20GHz, it shall be connected to the high pass filter attenuated the carried frequency. The spectrum set RB/VB 1MHz.

4.6.4 TEST SETUP

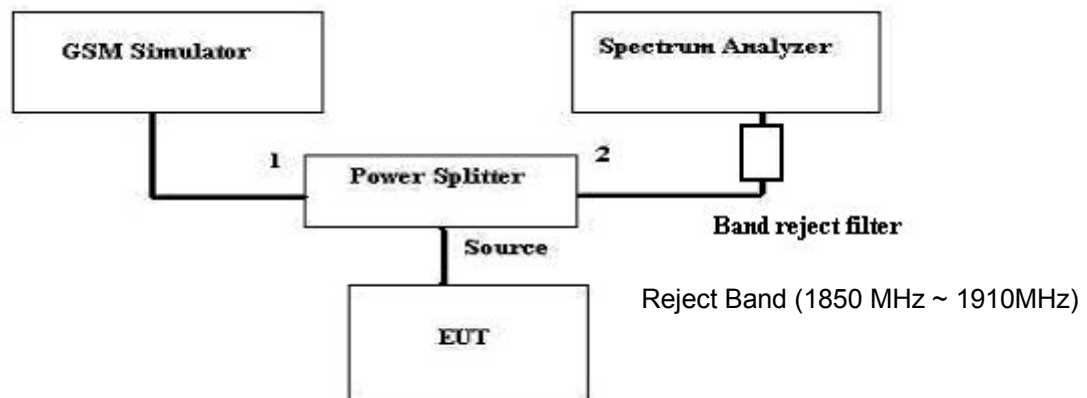

4.6.5 EUT OPERATING CONDITIONS

- a. The EUT makes a phone call to the GSM simulator.
- b. The GSM simulator station system controlled a EUT to export maximum output power under transmission mode and specific channel frequency.



4.6.6 TEST RESULTS

CH 512: 9kHz ~ 3GHz

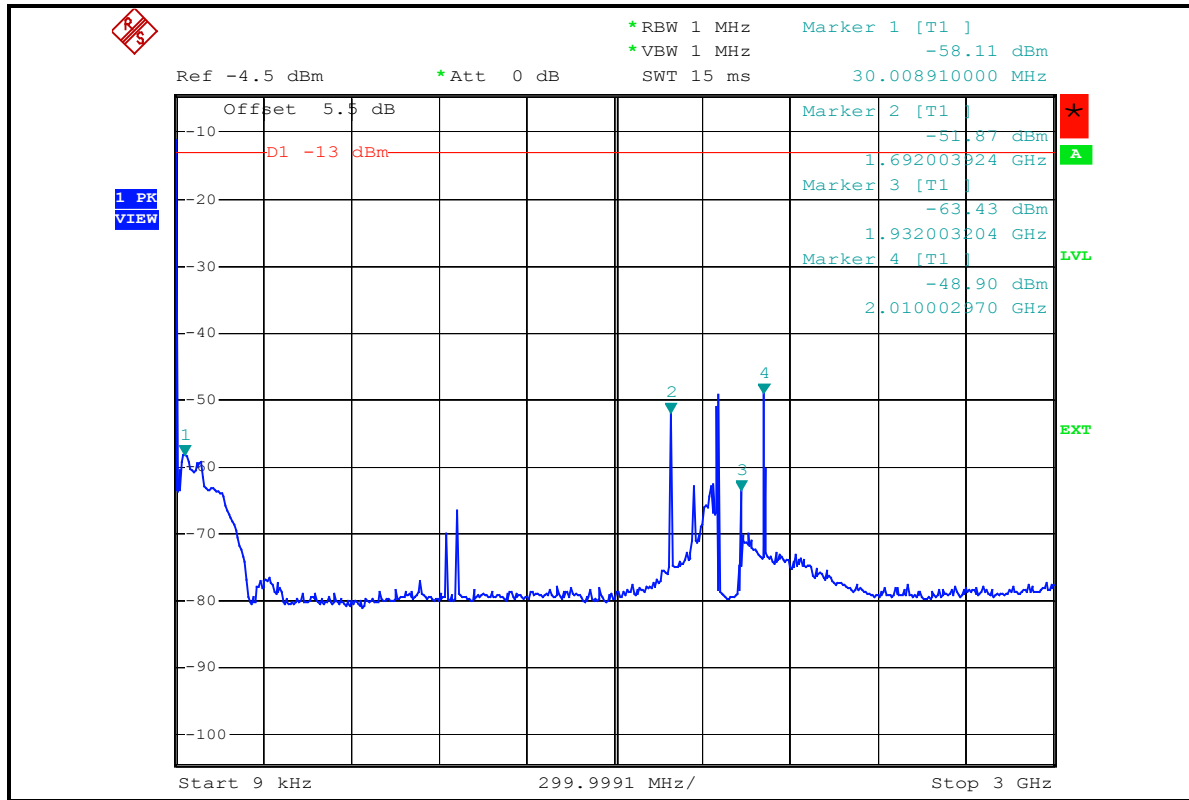

3GHz ~ 10GHz

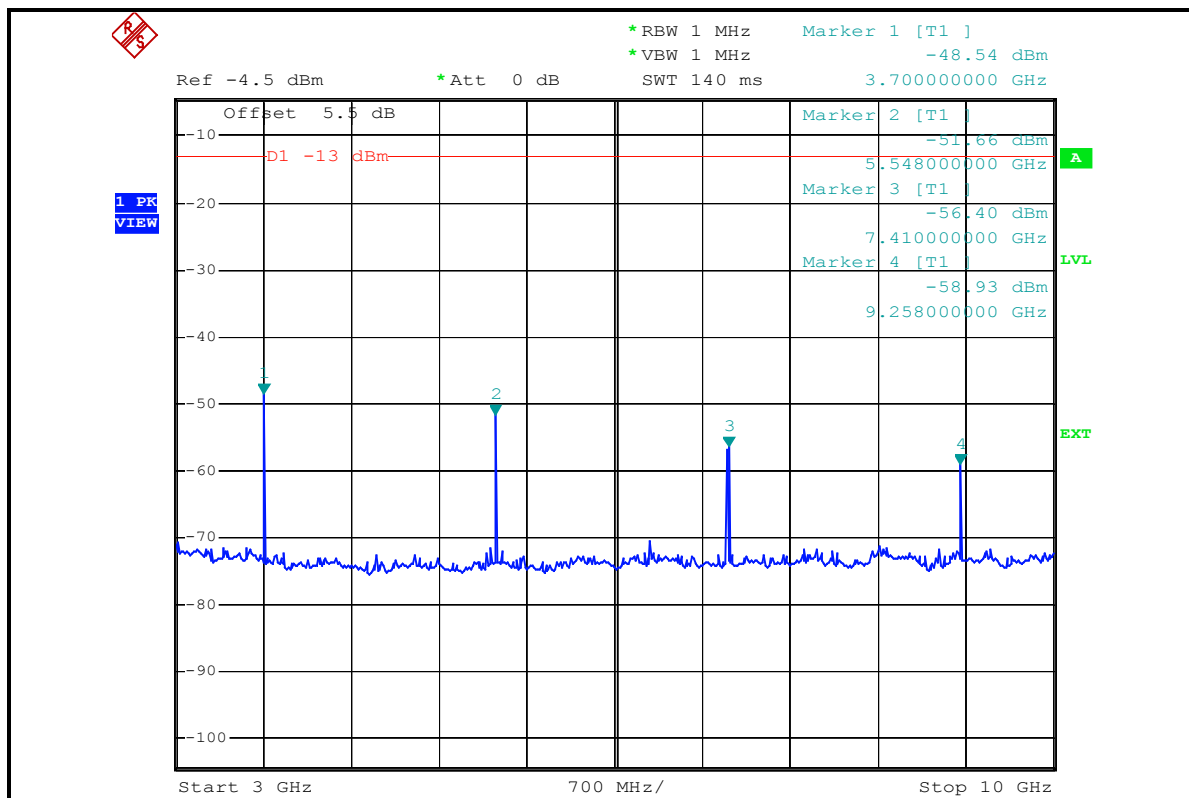



10GHz ~ 20GHz

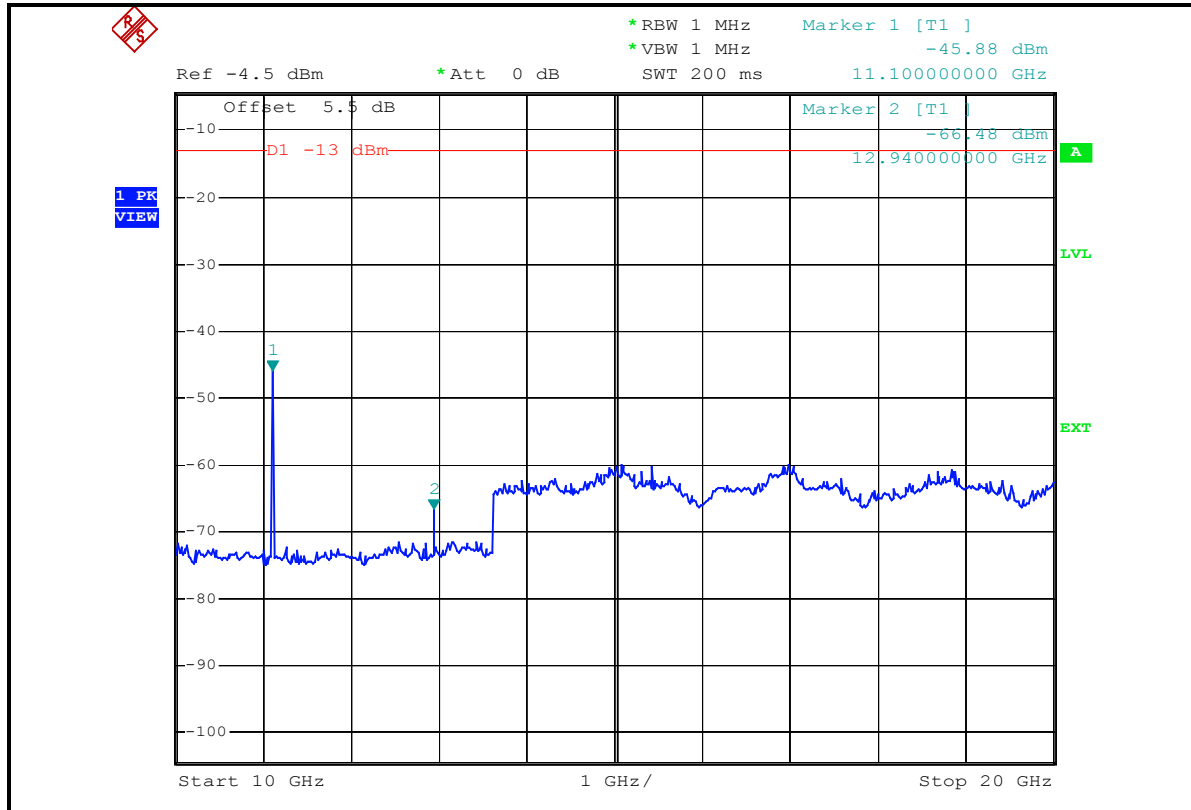



CH 661: 9kHz ~ 3GHz

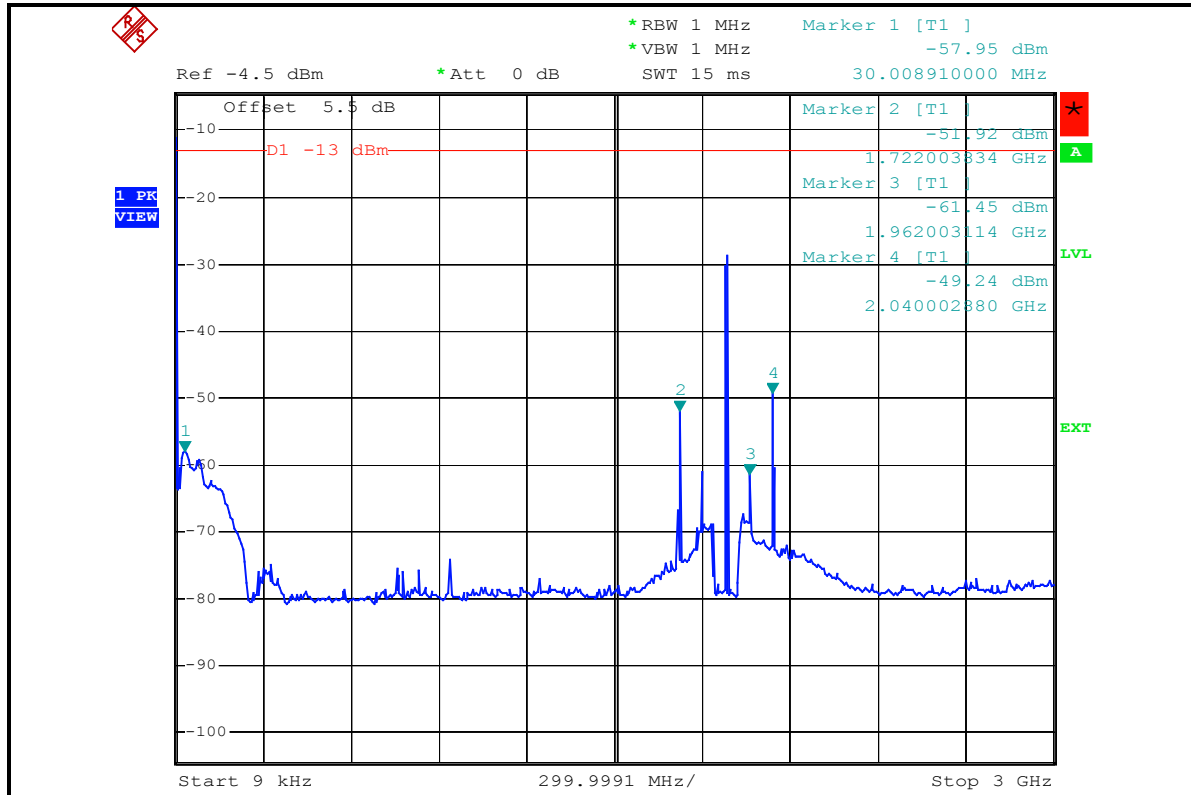

3GHz ~ 10GHz

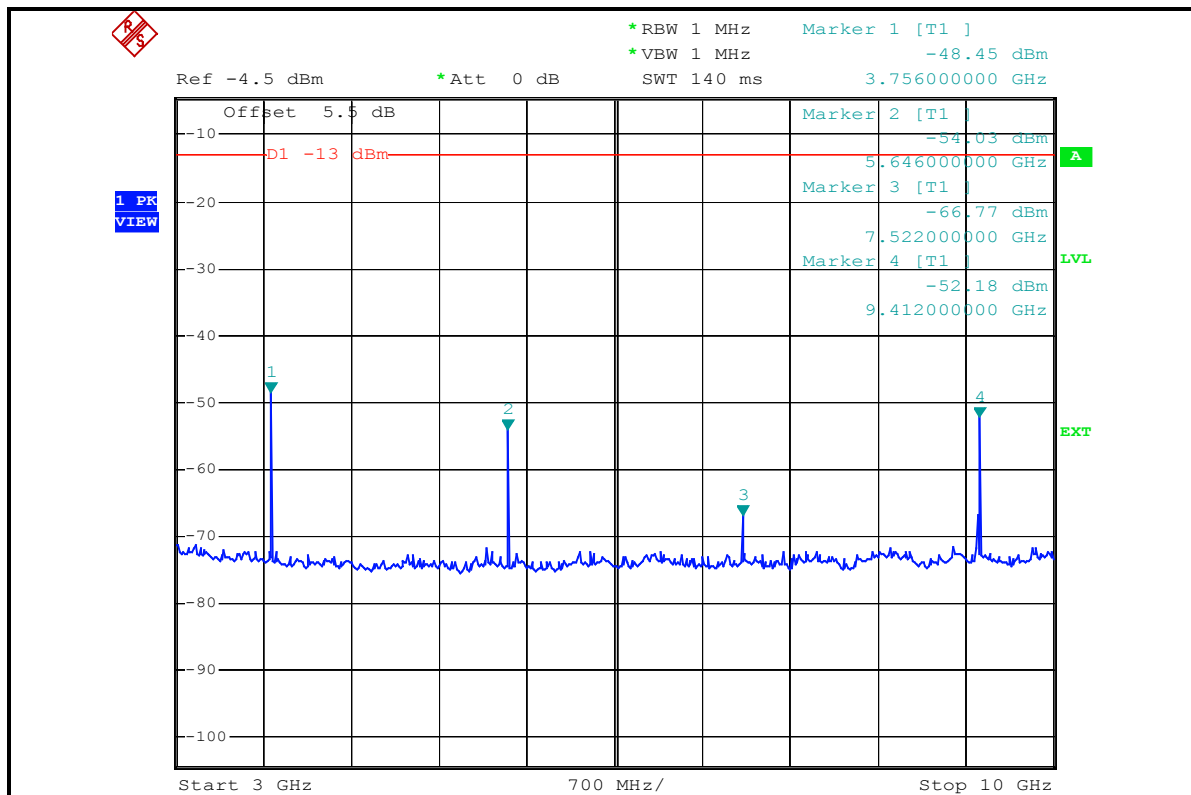



10GHz ~ 20GHz

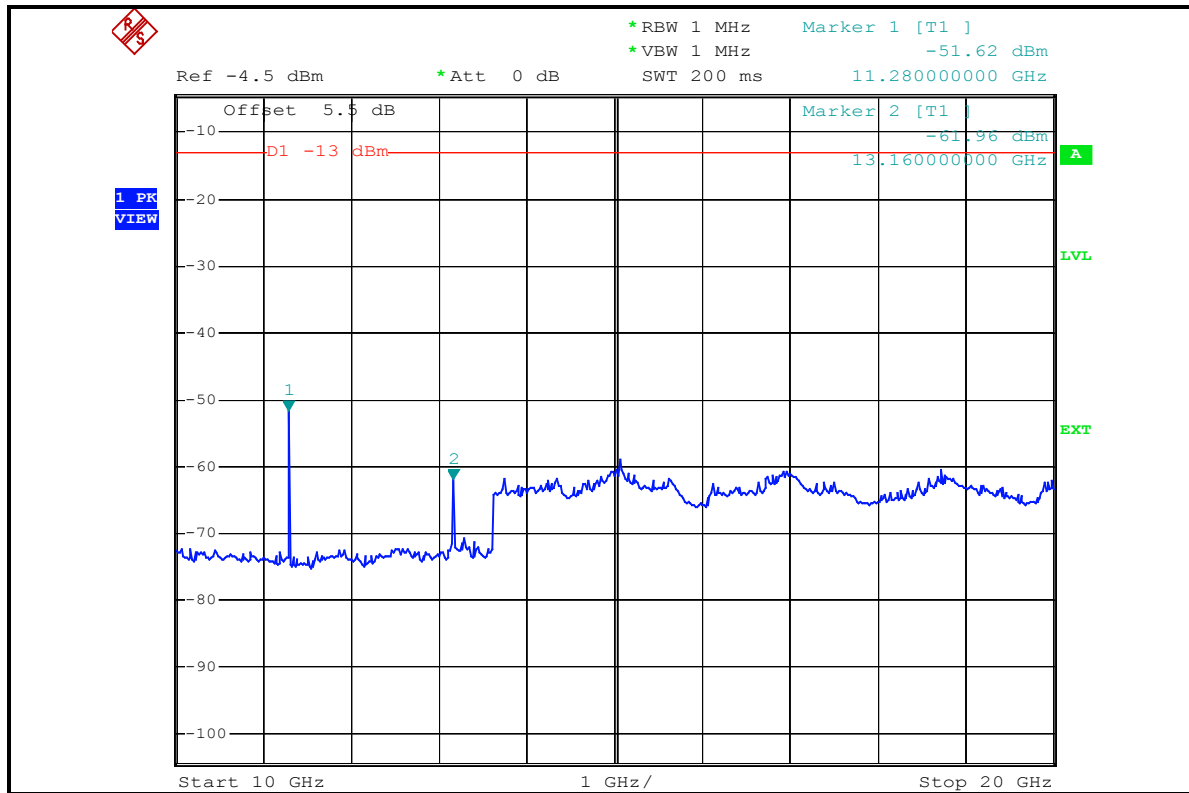



CH 810: 9kHz ~ 3GHz

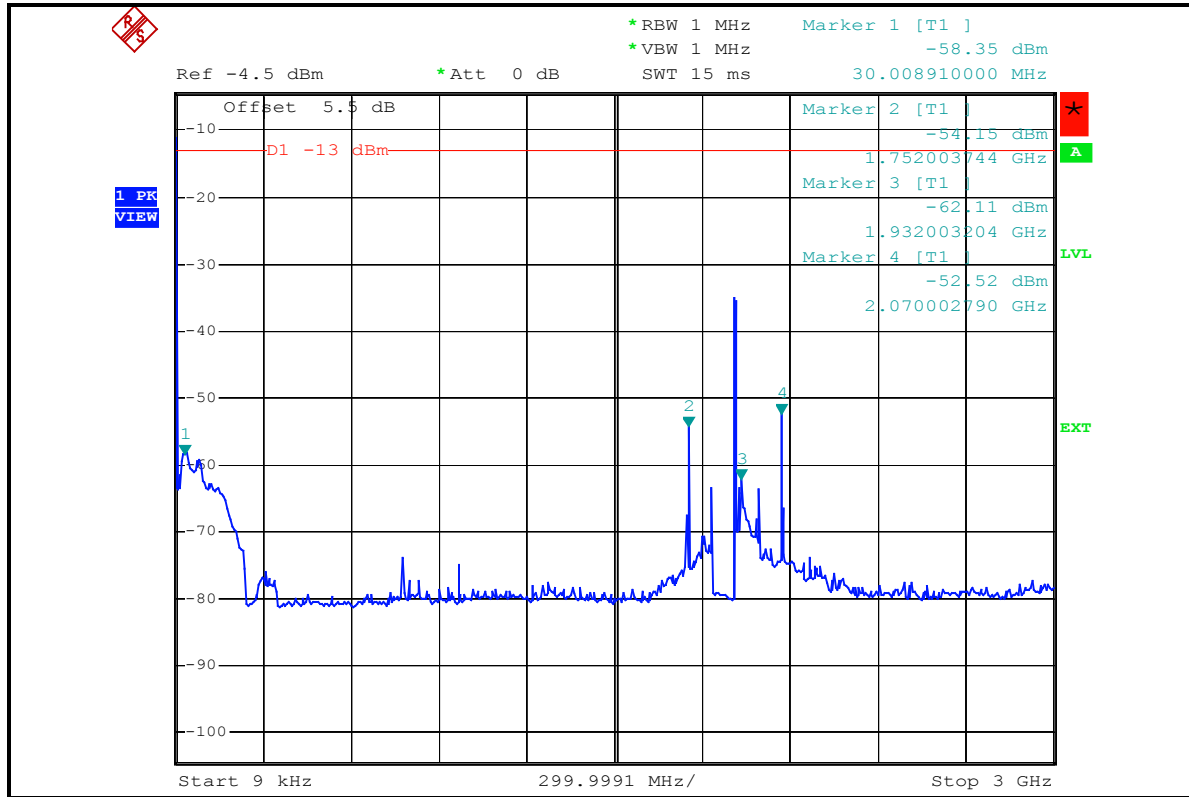

3GHz ~ 10GHz

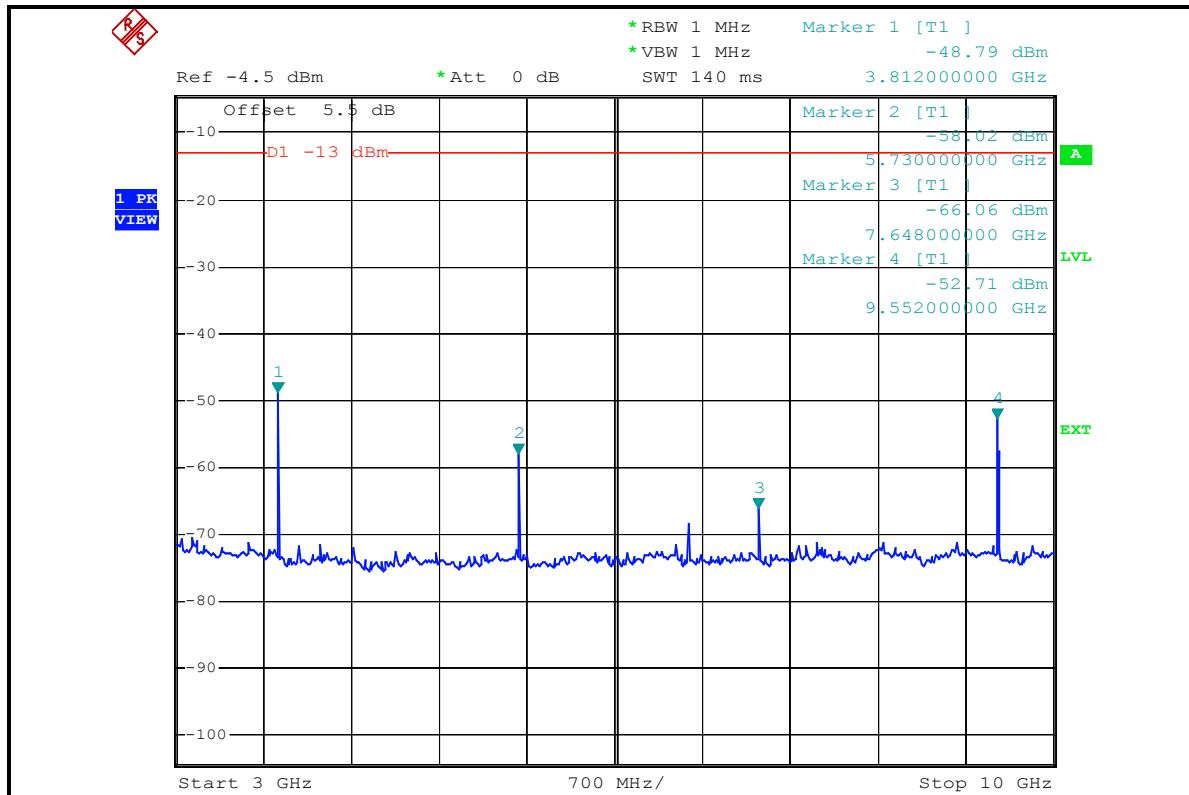



10GHz ~ 20GHz

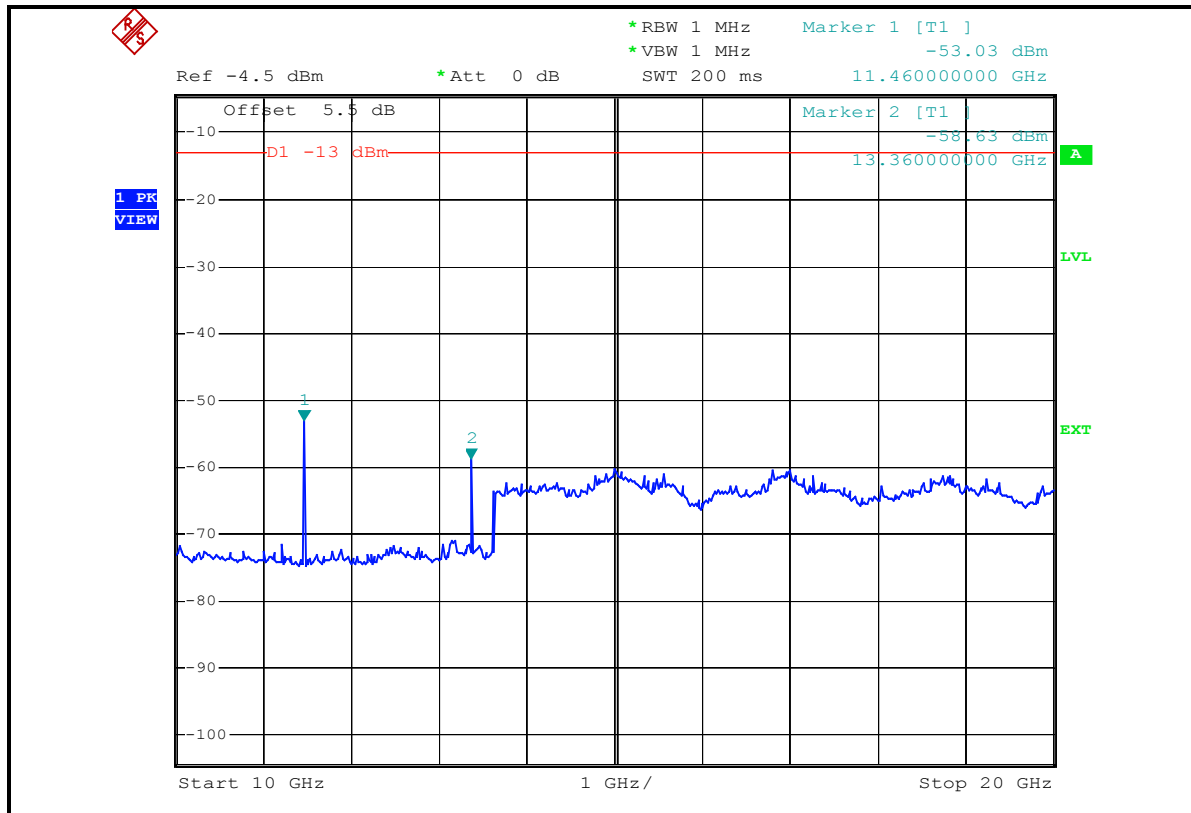



EUT	EDA (Enterprise Digital Assistant)	MODEL	MC7094
MODE	TX channel 512	POWER CONTROL LEVEL	0
INPUT POWER (SYSTEM)	120Vac, 60 Hz	DETECTOR FUNCTION	Peak
ENVIRONMENTAL CONDITIONS	26deg. C, 65%RH, 991hPa	TESTED BY	Long Chen

CONDUCTED SPURIOUS EMISSION					
FREQUENCY (MHz)	CORRECTION FACTOR (dB)	S.A READING (dBm)	CONDUCTED LEVEL (dBm)	LIMIT (dBm)	MARGIN (dB)
30.00	1.80	-58.11	-56.31	-13.00	-43.31
1692.00	3.81	-51.87	-48.06	-13.00	-35.06
1932.00	3.83	-63.43	-59.60	-13.00	-46.60
2010.00	3.83	-48.90	-45.07	-13.00	-32.07
3700.00	4.21	-48.54	-44.33	-13.00	-31.33
5548.00	4.32	-51.66	-47.34	-13.00	-34.34
7410.00	4.46	-56.40	-51.94	-13.00	-38.94
9258.00	4.55	-58.93	-54.38	-13.00	-41.38
11100.00	4.93	-45.88	-40.95	-13.00	-27.95
12940.00	5.35	-66.48	-61.13	-13.00	-48.13

REMARKS: 1. Peak Output Power (dBm) = Raw Value (dBm) + Correction Factor (dB).
 2. Correction Factor (dB) = Power Splitter Loss (dB) + Cable Loss (dB).



EUT	EDA (Enterprise Digital Assistant)	MODEL	MC7094
MODE	TX channel 661	POWER CONTROL LEVEL	0
INPUT POWER (SYSTEM)	120Vac, 60 Hz	DETECTOR FUNCTION	Peak
ENVIRONMENTAL CONDITIONS	26deg. C, 65%RH, 991hPa	TESTED BY	Long Chen

CONDUCTED SPURIOUS EMISSION					
FREQUENCY (MHz)	CORRECTION FACTOR (dB)	S.A READING (dBm)	CONDUCTED LEVEL (dBm)	LIMIT (dBm)	MARGIN (dB)
30.00	1.80	-57.95	-56.15	-13.00	-43.15
1722.00	3.81	-51.92	-48.11	-13.00	-35.11
1962.00	3.83	-61.45	-57.62	-13.00	-44.62
2040.00	3.83	-49.24	-45.41	-13.00	-32.41
3756.00	4.21	-48.45	-44.24	-13.00	-31.24
5646.00	4.32	-54.03	-49.71	-13.00	-36.71
7522.00	4.46	-66.77	-62.31	-13.00	-49.31
9412.00	4.56	-52.18	-47.62	-13.00	-34.62
11280.00	4.93	-51.62	-46.69	-13.00	-33.69
13160.00	5.35	-61.96	-56.61	-13.00	-43.61

- REMARKS:** 1. Peak Output Power (dBm) = Raw Value (dBm) + Correction Factor (dB).
 2. Correction Factor (dB) = Power Splitter Loss (dB) + Cable Loss (dB).



EUT	EDA (Enterprise Digital Assistant)	MODEL	MC7094
MODE	TX channel 810	POWER CONTROL LEVEL	0
INPUT POWER (SYSTEM)	120Vac, 60 Hz	DETECTOR FUNCTION	Peak
ENVIRONMENTAL CONDITIONS	26deg. C, 65%RH, 991hPa	TESTED BY	Long Chen

CONDUCTED SPURIOUS EMISSION					
FREQUENCY (MHz)	CORRECTION FACTOR (dB)	S.A READING (DbM)	CONDUCTED LEVEL (dBm)	LIMIT (dBm)	MARGIN (dB)
30.00	1.80	-58.30	-56.50	-13.00	-43.50
1752.00	3.81	-54.22	-50.41	-13.00	-37.41
1932.00	3.83	-62.87	-59.04	-13.00	-46.04
2070.00	3.83	-55.29	-51.46	-13.00	-38.46
3812.00	4.21	-47.44	-43.23	-13.00	-30.23
5730.00	4.32	-57.47	-53.15	-13.00	-40.15
7648.00	4.47	-66.04	-61.57	-13.00	-48.57
9552.00	4.56	-52.69	-48.13	-13.00	-35.13
11460.00	4.94	-52.32	-47.38	-13.00	-34.38
13360.00	5.36	-58.10	-52.74	-13.00	-39.74

REMARKS: 1. Peak Output Power (dBm) = Raw Value (dBm) + Correction Factor (dB).
 2. Correction Factor (dB) = Power Splitter Loss (dB) + Cable Loss (dB).



4.7 RADIATED EMISSION MEASUREMENT (BELOW 1GHz)

4.7.1 LIMITS OF RADIATED EMISSION MEASUREMENT

In the FCC 24.238(a), On any frequency outside a licensee’s frequency block within USPCS spectrum, the power of any emission shall be attenuated below the transmitter power (P) by at least 43 +10 log (P) dB. The limit translates in the relevant power range (1 to 0.001W). At 1W(Power Control Level 0) the specified minimum attenuation becomes 43dB and the limit of emission equal to –13dBm. At 0.001W(Power Control Level 15) the specified minimum attenuation becomes 13dB and the emission of limit equal to –13dBm. So the limit of emission is the same absolute specified line.

LIMIT (dBm)	EQUIVALENT FIELD STRENGTH AT 3m (dBuV/m) (NOTE)
-13	82.22

NOTE: The following formula is used to convert the equipment radiated power to field strength.

$$E = [1000000\sqrt{(30P)}] / 3 \text{ uV/m, where P is the eirp (Watts)}$$



4.7.2 TEST INSTRUMENTS

DESCRIPTION & MANUFACTURER	MODEL NO.	SERIAL NO.	CALIBRATED UNTIL
Test Receiver ROHDE & SCHWARZ	ESIB7	100188	Dec. 19, 2005
Spectrum Analyzer ROHDE & SCHWARZ	FSP40	100039	Nov. 21, 2005
BILOG Antenna SCHWARZBECK	VULB9168	9168-157	Jan. 22, 2006
HORN Antenna SCHWARZBECK	BBHA 9120 D	9120D-407	Jan. 16, 2006
HORN Antenna SCHWARZBECK	BBHA 9170	BBHA 9170241	Feb. 23, 2006
Preamplifier Agilent	8449B	3008A01961	Nov. 09, 2005
Preamplifier Agilent	8447D	2944A10629	Nov. 09, 2005
RF signal cable HUBER+SUHNER	SUCOFLEX 104	218182/4	Feb. 17, 2006
RF signal cable HUBER+SUHNER	SUCOFLEX 104	218194/4	Feb. 17, 2006
Software ADT.	ADT_Radiated_V5.14	NA	NA
Antenna Tower ADT.	AT100	AT93021702	NA
Turn Table ADT.	TT100.	TT93021702	NA
Controller ADT.	SC100.	SC93021702	NA

- NOTE:** 1. The calibration interval of the above test instruments is 12 months and the calibrations are traceable to NML/ROC and NIST/USA.
2. The test was performed in HwaYa Chamber 1.
3. The horn antenna and HP preamplifier (model: 8449B) are used only for the measurement of emission frequency above 1GHz if tested.
4. The IC Site Registration No. is IC4924-2.



4.7.3 TEST PROCEDURES

- a. The EUT was placed on the top of a rotating table 0.8 meters above the ground. The table was rotated 360 degrees to determine the position of the highest radiation.
- b. The EUT was set 3 meters away from the receiving antenna, which was mounted on antenna tower and its position at 0.8 m above the ground.
- c. For each suspected emission, the EUT was arranged to its worst case and the rotatable table was turned from 0 degrees to 360 degrees to find the maximum reading and recorded the value.
- d. Repeat step a ~ c for horizontal polarization.

NOTE: 1. The resolution bandwidth of spectrum analyzer is 10 kHz and the video bandwidth is 300 kHz for spurious emission below 1GHz.
2. The resolution bandwidth of spectrum analyzer is 1 MHz and the video bandwidth is 3 MHz for spurious emission above 1GHz.

4.7.4 DEVIATION FROM TEST STANDARD

No deviation

4.7.5 TEST SETUP

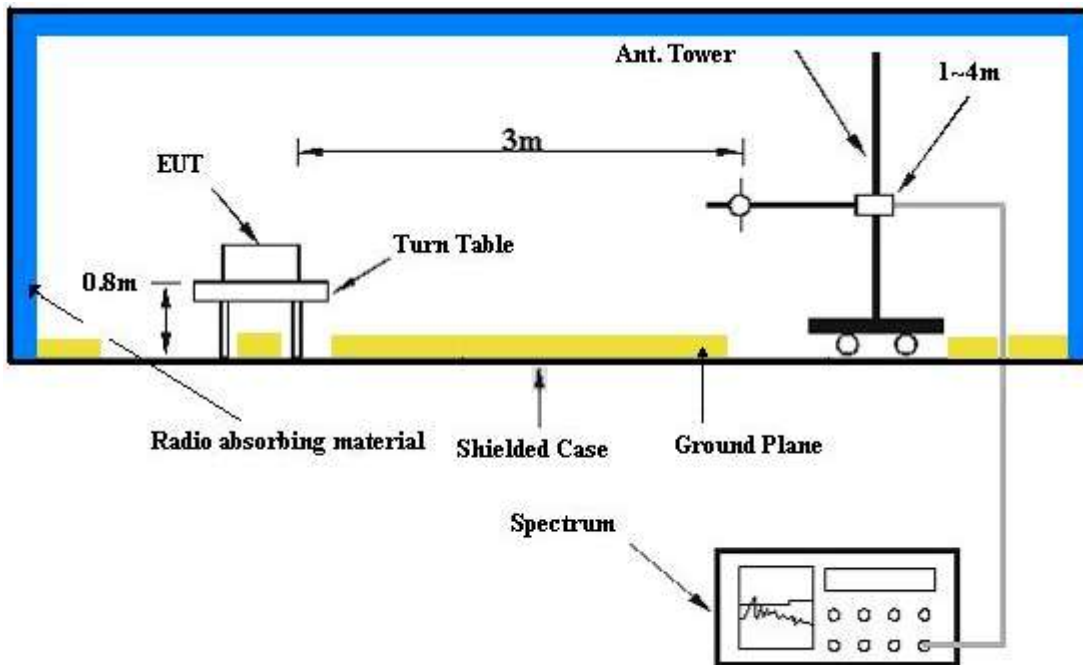

For the actual test configuration, please refer to the related item – Photographs of the Test Configuration.

4.7.6 EUT OPERATING CONDITIONS

- The EUT makes a phone call to the GSM simulator.
- The GSM simulator station system controlled an EUT to export maximum output power under transmission mode and specific channel frequency.



4.7.7 TEST RESULTS

EUT	EDA (Enterprise Digital Assistant)	MODEL	MC7094
MODE	TX channel 810	FREQUENCY RANGE	Below 1000 MHz
INPUT POWER (SYSTEM)	120Vac, 60 Hz	DETECTOR FUNCTION	Quasi-Peak
ENVIRONMENTAL CONDITIONS	26deg. C, 62%RH, 991hPa	TESTED BY	Match Tsui

ANTENNA POLARITY & TEST DISTANCE: HORIZONTAL AT 3 M								
No.	Freq. (MHz)	Emission Level (dBuV/m)	Limit (dBuV/m)	Margin (dB)	Antenna Height (m)	Table Angle (Degree)	Raw Value (dBuV)	Correction Factor (dB/m)
1	51.38	25.32 QP	82.22	-56.90	2.00 H	190	10.99	14.33
2	88.32	36.75 QP	82.22	-45.47	2.00 H	316	26.84	9.91
3	129.14	27.69 QP	82.22	-54.53	2.00 H	253	14.24	13.45
4	168.02	26.94 QP	82.22	-55.28	1.50 H	238	13.06	13.88
5	576.23	26.23 QP	82.22	-55.99	1.00 H	58	5.95	20.28
6	792.00	26.13 QP	82.22	-56.09	1.50 H	115	2.47	23.66

ANTENNA POLARITY & TEST DISTANCE: VERTICAL AT 3 M								
No.	Freq. (MHz)	Emission Level (dBuV/m)	Limit (dBuV/m)	Margin (dB)	Antenna Height (m)	Table Angle (Degree)	Raw Value (dBuV)	Correction Factor (dB/m)
1	51.38	31.66 QP	82.22	-50.56	1.00 V	103	17.33	14.33
2	86.37	32.60 QP	82.22	-49.62	1.00 V	220	22.72	9.88
3	117.47	34.01 QP	82.22	-48.21	1.00 V	151	21.47	12.54
4	162.18	33.30 QP	82.22	-48.92	1.00 V	13	18.86	14.45
5	863.93	25.84 QP	82.22	-56.38	1.00 V	76	1.44	24.40
6	928.08	25.70 QP	82.22	-56.52	1.00 V	46	0.31	25.39

NOTE:

1. Emission level (dBuV/m) = Raw Value (dBuV) + Correction Factor (dB).
2. Correction Factor (dB/m) = Antenna Factor (dB/m) + Cable Factor (dB).
3. The other emission levels were very low against the limit.
4. Margin value = Emission level – Limit value.
5. This is valid for all 3 channels.



4.8 EFFECTIVE RADIATED POWER MEASUREMENT (ABOVE 1GHz)

4.8.1 LIMITS OF RADIATED EMISSION MEASUREMENT

In the FCC 24.238(a), On any frequency outside a licensee's frequency block within USPCS spectrum, the power of any emission shall be attenuated below the transmitter power (P) by at least $43 + 10 \log (P)$ dB. The limit translates in the relevant power range (1 to 0.001W). At 1W(Power Control Level 0) the specified minimum attenuation becomes 43dB and the limit of emission equal to -13dBm . At 0.001W(Power Control Level 15) the specified minimum attenuation becomes 13dB and the emission of limit equal to -13dBm . So the limit of emission is the same absolute specified line.



4.8.2 TEST INSTRUMENTS

DESCRIPTION & MANUFACTURER	MODEL NO.	SERIAL NO.	CALIBRATED UNTIL
Test Receiver ROHDE & SCHWARZ	ESIB7	100188	Dec. 19, 2005
Spectrum Analyzer ROHDE & SCHWARZ	FSP40	100039	Nov. 21, 2005
BILOG Antenna SCHWARZBECK	VULB9168	9168-157	Jan. 22, 2006
HORN Antenna SCHWARZBECK	BBHA 9120 D	9120D-407	Jan. 16, 2006
HORN Antenna SCHWARZBECK	BBHA 9170	BBHA 9170241	Feb. 23, 2006
Preamplifier Agilent	8449B	3008A01961	Nov. 09, 2005
Preamplifier Agilent	8447D	2944A10629	Nov. 09, 2005
RF signal cable HUBER+SUHNER	SUCOFLEX 104	218182/4	Feb. 17, 2006
RF signal cable HUBER+SUHNER	SUCOFLEX 104	218194/4	Feb. 17, 2006
Software ADT.	ADT_Radiated_V5.14	NA	NA
Antenna Tower ADT.	AT100	AT93021702	NA
Turn Table ADT.	TT100.	TT93021702	NA
Controller ADT.	SC100.	SC93021702	NA
AGILENT SIGNAL GENERATOR	E8257C	MY43320668	Dec. 06, 2005

- NOTE:** 1. The calibration interval of the above test instruments is 12 months and the calibrations are traceable to NML/ROC and NIST/USA.
2. The test was performed in HwaYa Chamber 1.
3. The horn antenna and HP preamplifier (model: 8449B) are used only for the measurement of emission frequency above 1GHz if tested.
4. The IC Site Registration No. is IC4924-2.



4.8.3 TEST PROCEDURES

- a. The EUT was placed on the top of a rotating table 0.8 meters above the ground. The table was rotated 360 degrees to determine the position of the highest radiation.
- b. The EUT was set 3 meters away from the receiving antenna, which was mounted on antenna tower and its position at 0.8 m above the ground.
- c. For each suspected emission, the EUT was arranged to its worst case and the rotatable table was turned from 0 degrees to 360 degrees to find the maximum reading and recorded the value.
- d. The EUT is replaced by a horn antenna connected to a signal generator tuned to the frequency of emission.
- e. The signal generator level has to be adjusted to have the same emission nature.
- f. The radiated power can be calculated via the factor and antenna gain.
- g. Repeat step a ~ f for horizontal polarization.

NOTE: 1. The resolution bandwidth of spectrum analyzer is 10 kHz and the video bandwidth is 300 kHz for spurious emission below 1GHz.
2. The resolution bandwidth of spectrum analyzer is 1 MHz and the video bandwidth is 3 MHz for spurious emission above 1GHz.

4.8.4 DEVIATION FROM TEST STANDARD

No deviation

4.8.5 TEST SETUP

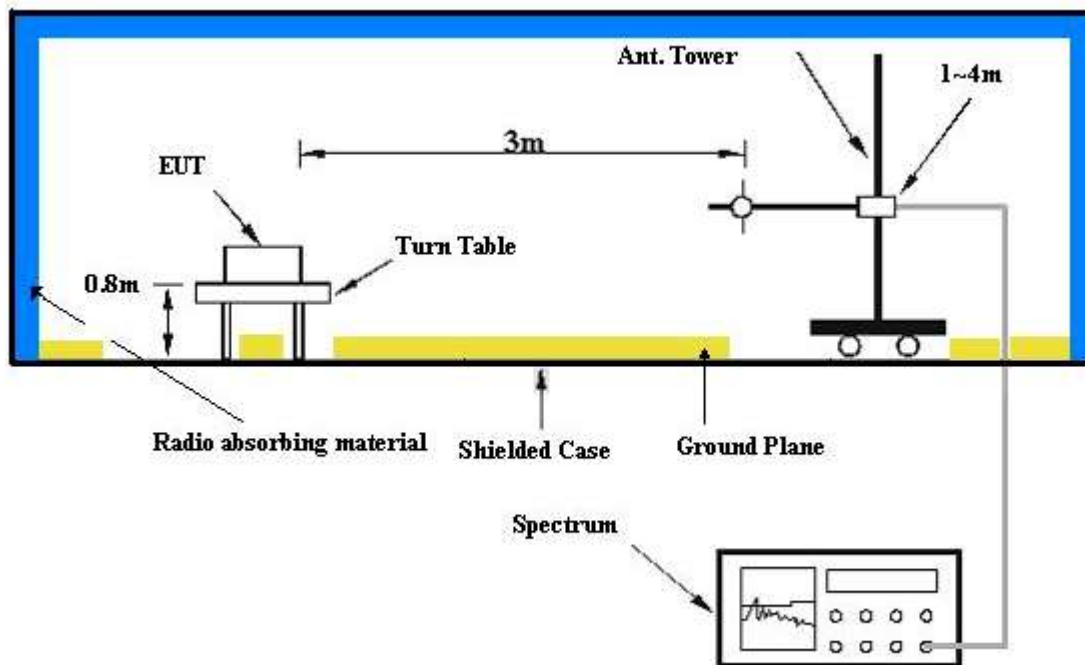

For the actual test configuration, please refer to the related item – Photographs of the Test Configuration.

4.8.6 EUT OPERATING CONDITIONS

- The EUT makes a phone call to the GSM simulator.
- The GSM simulator station system controlled an EUT to export maximum output power under transmission mode and specific channel frequency.



4.8.7 TEST RESULTS

EUT	EDA (Enterprise Digital Assistant)	MODEL	MC7094
MODE	TX channel 512	FREQUENCY RANGE	Above 1000 MHz
INPUT POWER (SYSTEM)	120Vac, 60 Hz	ENVIRONMENTAL CONDITIONS	26deg. C, 65%RH, 991hPa
TESTED BY	Long Chen		

ANTENNA POLARITY & TEST DISTANCE: HORIZONTAL AT 3 M

No.	Freq. (MHz)	Emission Level (dBUV)	Limit (dBm)	S.G Power Value (dBm)	Correction Factor (dB)	Power Value (dBm)
1	3700.00	69.18	-13.00	-39.70	13.65	-26.05
2	5500.00	57.24	-13.00	-52.33	14.34	-37.99
3	7401.00	62.76	-13.00	-45.63	13.16	-32.47
4	9251.00	66.72	-13.00	-42.20	13.69	-28.51
5	11100.00	56.29	-13.00	-53.23	14.29	-38.94

ANTENNA POLARITY & TEST DISTANCE: VERTICAL AT 3 M

No.	Freq. (MHz)	Emission Level (dBUV)	Limit (dBm)	S.G Power Value (dBm)	Correction Factor (dB)	Power Value (dBm)
1	3700.00	66.08	-13.00	-42.80	13.65	-29.15
2	5500.00	57.99	-13.00	-51.58	14.34	-37.24
3	7401.00	63.14	-13.00	-45.25	13.16	-32.09
4	9251.00	64.82	-13.00	-44.10	13.69	-30.41
5	11100.00	58.79	-13.00	-50.73	14.29	-36.44

NOTE: Power Value (dBum) = S.G Power Value (dBm) + Correction Factor (dB).



EUT	EDA (Enterprise Digital Assistant)	MODEL	MC7094
MODE	TX channel 661	FREQUENCY RANGE	Above 1000 MHz
INPUT POWER (SYSTEM)	120Vac, 60 Hz	ENVIRONMENTAL CONDITIONS	26deg. C, 65%RH, 991hPa
TESTED BY	Long Chen		

ANTENNA POLARITY & TEST DISTANCE: HORIZONTAL AT 3 M

No.	Freq. (MHz)	Emission Level (dBuV)	Limit (dBm)	S.G Power Value (dBm)	Correction Factor (dB)	Power Value (dBm)
1	3760.00	68.96	-13.00	-39.92	13.65	-26.27
2	5640.00	58.63	-13.00	-50.97	14.37	-36.60
3	7520.00	62.57	-13.00	-45.81	13.15	-32.66
4	9400.00	67.35	-13.00	-41.75	13.87	-27.88
5	11280.00	57.68	-13.00	-51.88	14.33	-37.55

ANTENNA POLARITY & TEST DISTANCE: VERTICAL AT 3 M

No.	Freq. (MHz)	Emission Level (dBuV)	Limit (dBm)	S.G Power Value (dBm)	Correction Factor (dB)	Power Value (dBm)
1	3760.00	66.12	-13.00	-42.76	13.65	-29.11
2	5640.00	57.48	-13.00	-52.12	14.37	-37.75
3	7520.00	64.08	-13.00	-44.30	13.15	-31.15
4	9400.00	65.13	-13.00	-43.97	13.87	-30.10
5	11280.00	59.11	-13.00	-50.45	14.33	-36.12

NOTE: Power Value (dBum) = S.G Power Value (dBm) + Correction Factor (dB).



EUT	EDA (Enterprise Digital Assistant)	MODEL	MC7094
MODE	TX channel 810	FREQUENCY RANGE	Above 1000 MHz
INPUT POWER (SYSTEM)	120Vac, 60 Hz	ENVIRONMENTAL CONDITIONS	26deg. C, 65%RH, 991hPa
TESTED BY	Long Chen		

ANTENNA POLARITY & TEST DISTANCE: HORIZONTAL AT 3 M

No.	Freq. (MHz)	Emission Level (dBuV)	Limit (dBm)	S.G Power Value (dBm)	Correction Factor (dB)	Power Value (dBm)
1	3819.00	70.52	-13.00	-38.37	13.66	-24.71
2	5729.00	57.62	-13.00	-52.00	14.39	-37.61
3	7639.00	63.10	-13.00	-45.28	13.15	-32.13
4	9549.00	65.86	-13.00	-43.23	13.86	-29.37
5	11458.00	57.49	-13.00	-52.07	14.33	-37.74

ANTENNA POLARITY & TEST DISTANCE: VERTICAL AT 3 M

No.	Freq. (MHz)	Emission Level (dBuV)	Limit (dBm)	S.G Power Value (dBm)	Correction Factor (dB)	Power Value (dBm)
1	3819.00	66.54	-13.00	-42.35	13.66	-28.69
2	5729.00	58.06	-13.00	-51.56	14.39	-37.17
3	7639.00	62.48	-13.00	-45.90	13.15	-32.75
4	9549.00	65.14	-13.00	-43.95	13.86	-30.09
5	11458.00	57.49	-13.00	-52.07	14.33	-37.74

NOTE: Power Value (dBum) = S.G Power Value (dBm) + Correction Factor (dB).

5 PHOTOGRAPHS OF THE TEST CONFIGURATION

RADIATED EMISSION TEST





6 INFORMATION ON THE TESTING LABORATORIES

We, ADT Corp., were founded in 1988 to provide our best service in EMC, Radio, Telecom and Safety consultation. Our laboratories are accredited and approved by the following approval agencies according to ISO/IEC 17025.

USA	FCC, NVLAP, UL, A2LA
GERMANY	TUV Rheinland
JAPAN	VCCI
NORWAY	NEMKO
CANADA	INDUSTRY CANADA , CSA
R.O.C.	CNLA, BSMI, DGT
NETHERLANDS	Telefication
SINGAPORE	PSB , GOST-ASIA (MOU)
RUSSIA	CERTIS (MOU)

Copies of accreditation certificates of our laboratories obtained from approval agencies can be downloaded from our web site:

www.adt.com.tw/index.5/phtml. If you have any comments, please feel free to contact us at the following:

Linko EMC/RF Lab:

Tel: 886-2-26052180

Fax: 886-2-26052943

Hsin Chu EMC/RF Lab:

Tel: 886-3-5935343

Fax: 886-3-5935342

Hwa Ya EMC/RF/Safety/Telecom Lab:

Tel: 886-3-3183232

Fax: 886-3-3185050

Linko RF Lab.

Tel: 886-3-3270910

Fax: 886-3-3270892

Email: service@adt.com.tw

Web Site: www.adt.com.tw

The address and road map of all our labs can be found in our web site also.