

FCC RADIO TEST REPORT

Report Reference No. : NTEK-2011DG11012655F

Compiled by (+ signature) : Jim He



Approved by (+ signature) : Bovey Yang

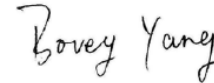

Applicant's name : ZF Friedrichshafen AG, Electronic Systems

Address : Cherryst., 91275 Auerbach/Opf., Germany

Manufacture's Name : Dongguan Togran Electronic Technology Co, Ltd.

Address : 262 Shidan Rd., 3rd Industrial Area, Juzhou, Shijie, Dongguan, Guangdong,.

Test specification:

Standard : FCC Part15.249

Test procedure : ANSI C63.4-2003

Test item description

Product name : Dongle

FCC ID : GDDJF-T01-D

Model and/or type reference : JF-T01-D

Rating(s) : DC 5V

Testing Laboratory information:

Testing Laboratory Name : NTEK Testing Technology Co., Ltd

Address : 1/F, Building E, Fenda Science Park, Sanwei Community, Xixiang Street, Bao ' an District, Shenzhen P.R. China.

This device described above has been tested by NTEK Testing Technology Co., Ltd, and the test results show that the equipment under test (EUT) is in compliance with the FCC requirements. And it is applicable only to the tested sample identified in the report.

This report shall not be reproduced except in full, without the written approval of NTEK Testing Technology Co., Ltd, this document may be altered or revised by NTEK Testing Technology Co., Ltd, personal only, and shall be noted in the revision of the document

Testing :

Date of receipt of test item : 20 Oct. 2011

Date (s) of performance of tests : 20 Oct. 2011 ~02 Nov. 2011

Date of Issue : 02 Nov. 2011

Test Result : **Pass**

Table of Contents	Page
1 . SUMMARY OF TEST RESULTS	3
1.1 MEASUREMENT UNCERTAINTY	4
2 . GENERAL INFORMATION	5
2.1 GENERAL DESCRIPTION OF EUT	5
2.2 DESCRIPTION OF TEST MODES	7
2.3 BLOCK DIGRAM SHOWING THE CONFIGURATION OF SYSTEM TESTED	8
2.4 DESCRIPTION OF SUPPORT UNITS(CONDUCTED MODE)	9
2.5 EQUIPMENTS LIST FOR ALL TEST ITEMS	10
3 . TEST RESULT	11
3.1 ANTENNA REQUIREMENT	11
3.1.1 STANDARD REQUIREMENT	11
3.1.2 EUT ANTENNA	11
3.2 CONDUCTED EMISSION MEASUREMENT	12
3.2.1 POWER LINE CONDUCTED EMISSION LIMITS	12
3.2.2 TEST PROCEDURE	13
3.2.3 DEVIATION FROM TEST STANDARD	13
3.2.4 TEST SETUP	13
3.2.5 TEST RESULT	14
3.3 RADIATED EMISSION MEASUREMENT	16
3.3.1 RADIATED EMISSION LIMITS	16
3.3.2 TEST PROCEDURE	17
3.3.3 DEVIATION FROM TEST STANDARD	17
3.3.4 TEST SETUP	18
3.3.5 TEST RESULTS (BLOW 30MHZ)	20
3.3.6 TEST RESULTS (BETWEEN 30 – 1000 MHZ)	21
3.3.7 TEST RESULTS (ABOVE 1000 MHZ)	23
3.3.8 TEST RESULTS (RESTRICTED BANDS REQUIREMENTS)	29
4 . BANDWIDTH TEST	33
4.1 TEST PROCEDURE	33
4.2 DEVIATION FROM STANDARD	33
4.3 TEST SETUP	33
4.4 TEST RESULTS	34
5 . EUT TEST PHOTO	36
6 . APPENDIX-Photographs of EUT Constructional Details	

1. SUMMARY OF TEST RESULTS

Test procedures according to the technical standards:

FCC Part15, Subpart C (15.249) & RSS-Gen Issue 3 & RSS-210 Issue 8			
Standard Section	Test Item	Judgment	Remark
15.207	Conducted Emission	N/A	Note(1)
15.203	Antenna Requirement	Pass	
15.249	Radiated Spurious Emission	Pass	
15.249	Occupied Bandwidth	Pass	

NOTE:

(1) " N/A" denotes test is not applicable in this Test Report.

1.1 MEASUREMENT UNCERTAINTY

The reported uncertainty of measurement $y \pm U$, where expanded uncertainty U is based on a standard uncertainty multiplied by a coverage factor of $k=2$, providing a level of confidence of approximately **95 %**.

No.	Item	Uncertainty
1	Conducted Emission Test	$\pm 3.2\text{dB}$
2	Radiated Emission Test	$\pm 4.7\text{dB}$
3	RF power,conducted	$\pm 0.16\text{dB}$
4	Spurious emissions,conducted	$\pm 0.21\text{dB}$
5	All emissions,radiated(<1G)	$\pm 4.68\text{dB}$
6	All emissions,radiated(>1G)	$\pm 4.89\text{dB}$

2. GENERAL INFORMATION

2.1 GENERAL DESCRIPTION OF EUT

Equipment	Dongle	
Trade Name	CHERRY 	
Model Name	JF-T01-D	
OEM Brand/Model Name	N/A	
Model Difference	N/A	
Product Description	The EUT is a Dongle	
	Operation Frequency:	2403~2478 MHz
	Channel Number	20
	Modulation Type:	GFSK
	Antenna Designation:	PCB antenna
	Antenna Gain(Peak)	0 dBi
Channel List	Please refer to the Note 2.	
Power Source	DC Voltage supplied from PC	
Power Rating	DC 5V	
Connecting I/O Port(s)	Please refer to the User's Manual	
Products Covered	N/A	
EUT Modification(s)	N/A	

Note:

1. For a more detailed features description, please refer to the manufacturer's specifications or the User's Manual.
- 2.

Channel List					
Group	Frequency (MHz)	Frequency (MHz)	Frequency (MHz)	Frequency (MHz)	Frequency (MHz)
01	2403	2478	2453	2413	2466
02	2404	2474	2444	2424	2464
03	2405	2475	2445	2415	2465
04	2406	2476	2436	2456	2416

3.

Table for Filed Antenna

Ant	Brand	Model Name	Antenna Type	Connector	Gain (dBi)	NOTE
1	N/A	N/A	PCB Antenna	NA	0	Antenna

2.2 DESCRIPTION OF TEST MODES

To investigate the maximum EMI emission characteristics generates from EUT, the test system was pre-scanning tested base on the consideration of following EUT operation mode or test configuration mode which possible have effect on EMI emission level. Each of these EUT operation mode(s) or test configuration mode(s) mentioned above was evaluated respectively.

Pretest Mode	Description
Mode 1	2403MHz
Mode 2	2453MHz
Mode 3	2478MHz

For Conducted Emission	
Final Test Mode	Description
-	"N/A" denotes test is not applicable in this Test Report

For Radiated Emission	
Final Test Mode	Description
Mode 1	2403MHz
Mode 2	2453MHz
Mode 3	2478MHz

Note:

- (1) The measurements are performed at the highest, middle, lowest available channels.
- (2) The EUT use new battery.

2.3 BLOCK DIGRAM SHOWING THE CONFIGURATION OF SYSTEM TESTED

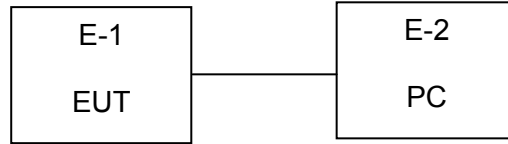

2.4 DESCRIPTION OF SUPPORT UNITS(CONDUCTED MODE)

The EUT has been tested as an independent unit together with other necessary accessories or support units. The following support units or accessories were used to form a representative test configuration during the tests.

Item	Equipment	Mfr/Brand	Model/Type No.	FCC ID	Series No.	Note
E-1	Dongle	CHERRY 	JF-T01-D	CDDJF-T01-DRX	N/A	EUT
E-2	Notebook	IBM	22336	N/A		

Item	Shielded Type	Ferrite Core	Length	Note

Note:

- (1) The support equipment was authorized by Declaration of Confirmation.
- (2) For detachable type I/O cable should be specified the length in cm in 『Length』 column.

2.5 EQUIPMENTS LIST FOR ALL TEST ITEMS

Radiation Test equipment

Item	Kind of Equipment	Manufacturer	Type No.	Serial No.	Calibrated until
1	Spectrum Analyzer	Agilent	E4407B	160400005	Jul. 06. 2012
2	Test Dongle	R&S	ESPI	101318	Jul. 06. 2012
3	Bilog Antenna	TESEQ	CBL6111D	31216	Jul. 06. 2012
4	50Ω Coaxial Switch	Anritsu	MP59B	6200264416	Jul. 06. 2012
5	Spectrum Analyzer	ADVANTEST	R3132	150900201	Jul. 06. 2012
6	Horn Antenna	EM	EM-AH-10180	2011071402	Jul. 06. 2012
7	Horn Ant	Schwarzbeck	BBHA 9170	9170-181	Jul. 06. 2012
8	Amplifier	EM	EM-30180	060538	Jul. 06. 2012
9	Loop Antenna	ARA	PLA-1030/B	1029	Jul. 06. 2012
10	Power Meter	R&S	NRVS	100696	Jul. 06. 2012

Conduction Test equipment

Item	Kind of Equipment	Manufacturer	Type No.	Serial No.	Calibrated until
1	Test Dongle	R&S	ESCI	101160	Jul. 06. 2012
2	LISN	R&S	ENV216	101313	Jul. 06. 2012
3	LISN	EMCO	3816/2	00042990	Jul. 06. 2012
4	50Ω Coaxial Switch	Anritsu	MP59B	6200264417	Jul. 06. 2012
5	Passive Voltage Probe	R&S	ESH2-Z3	100196	Jul. 06. 2012
6	Absorbing clamp	R&S	MOS-21	100423	Jul. 06. 2012

3. TEST RESULT

3.1 ANTENNA REQUIREMENT

3.1.1 STANDARD REQUIREMENT

15.203 requirement: For intentional device, according to 15.203: an intentional radiator shall be designed to ensure that no antenna other than that furnished by the responsible party shall be used with the device.

3.1.2 EUT ANTENNA

The EUT antenna is integral Antenna. It comply with the standard requirement.

3.2 CONDUCTED EMISSION MEASUREMENT

3.2.1 POWER LINE CONDUCTED EMISSION Limits (Frequency Range 150KHz-30MHz)

FREQUENCY (MHz)	Class A (dBuV)		Class B (dBuV)		Standard
	Quasi-peak	Average	Quasi-peak	Average	
0.15 -0.5			66 - 56 *	56 - 46 *	CISPR
0.50 -5.0			56.00	46.00	CISPR
5.0 -30.0			60.00	50.00	CISPR

0.15 -0.5			66 - 56 *	56 - 46 *	LP002.
0.50 -5.0			56.00	46.00	LP002.
5.0 -30.0			60.00	50.00	LP002.

Note:

- (1) The tighter limit applies at the band edges.
- (2) The limit of " * " marked band means the limitation decreases linearly with the logarithm of the frequency in the range.

The following table is the setting of the receiver

Dongle Parameters	Setting
Attenuation	10 dB
Start Frequency	0.15 MHz
Stop Frequency	30 MHz
IF Bandwidth	9 kHz

3.2.2 TEST PROCEDURE

- a. The EUT was placed 0.4 meters from the horizontal ground plane with EUT being connected to the power mains through a line impedance stabilization network (LISN). All other support equipments powered from additional LISN(s). The LISN provide 50 Ohm/ 50uH of coupling impedance for the measuring instrument.
- b. Interconnecting cables that hang closer than 40 cm to the ground plane shall be folded back and forth in the center forming a bundle 30 to 40 cm long.
- c. I/O cables that are not connected to a peripheral shall be bundled in the center. The end of the cable may be terminated, if required, using the correct terminating impedance. The overall length shall not exceed 1 m.
- d. LISN at least 80 cm from nearest part of EUT chassis.
- e. For the actual test configuration, please refer to the related Item –EUT Test Photos.

3.2.3 DEVIATION FROM TEST STANDARD

No deviation

3.2.4 TEST SETUP

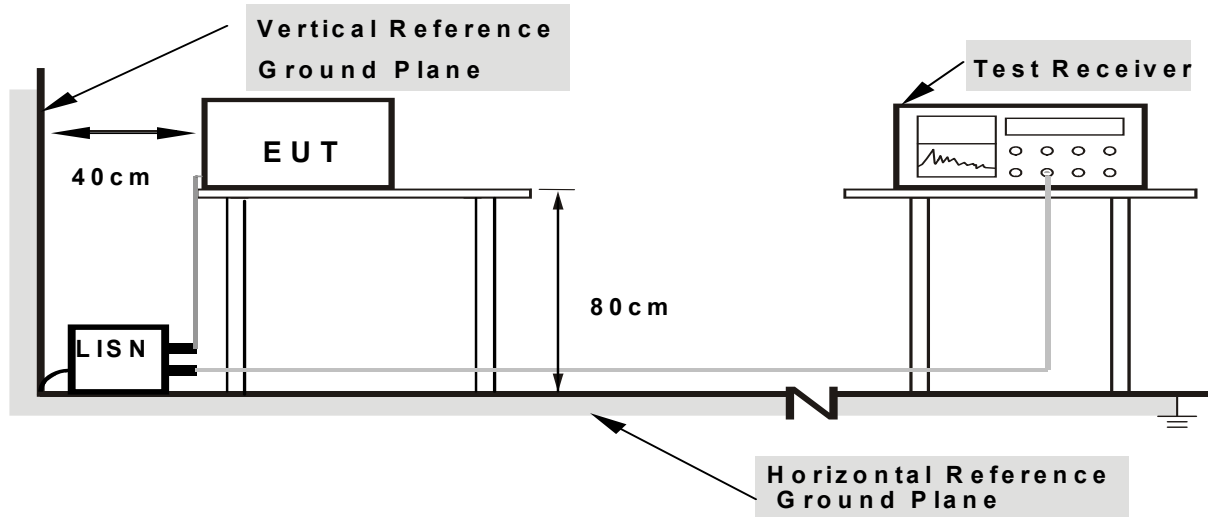

- Note:**
- 1.Support units were connected to second LISN.
 - 2.Both of LISNs (AMN) are 80 cm from EUT and at least 80 from other units and other metal planes

3.2.5 TEST RESULT

EUT :	Dongle	Model Name :	JF-T01-D
Temperature :	26 °C	Relative Humidity :	54%
Pressure :	1010hPa	Phase :	L
Test Mode :	TX		
Test Voltage :	DC 5V from PC AC 120V/60Hz		

Frequency (MHz)	Reading Level (dBμV)	Correct Factor (dB)	Measure-ment (dBμV)	Limits (dBμV)	Margin (dB)	Detector Type
0.294	21.54	10.43	31.97	50.41	-18.44	AVG
0.302	37.84	10.43	48.27	60.19	-11.92	peak
0.33	41.74	10.42	52.16	59.45	-7.29	peak
0.378	25.09	10.42	35.51	48.32	-12.81	AVG
0.562	38.82	10.4	49.22	56	-6.78	peak
0.5899	14.49	10.4	24.89	46	-21.11	AVG
1.106	39.52	10.41	49.93	56	-6.07	peak
1.13	18.57	10.41	28.98	46	-17.02	AVG
3.278	36.86	10.5	47.36	56	-8.64	peak
3.39	21.94	10.59	32.53	46	-13.47	AVG

Remark:

1. All readings are Quasi-Peak and Average values.
2. Factor = Insertion Loss + Cable Loss.

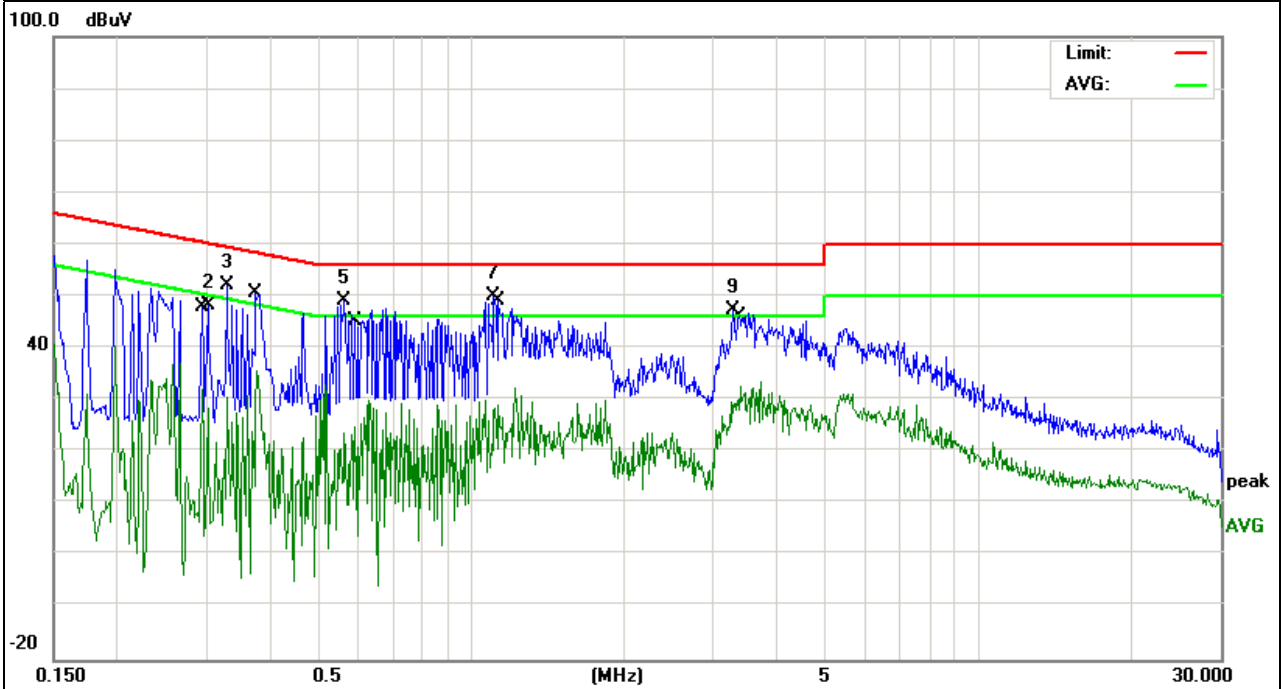

EUT :	Dongle	Model Name :	JF-T01-D
Temperature :	26 °C	Relative Humidity :	54%
Pressure :	1010hPa	Phase :	N
Test Mode :	TX		
Test Voltage :	DC 5V from PC AC 120V/60Hz		

Frequency (MHz)	Reading Level (dBμV)	Correct Factor (dB)	Measure-ment (dBμV)	Limits (dBμV)	Margin (dB)	Detector Type
0.238	39.74	10.43	50.17	62.16	-11.99	peak
0.238	19.88	10.43	30.31	52.16	-21.85	AVG
*0.406	40.66	10.41	51.07	57.73	-6.66	peak
0.4062	15.96	10.41	26.37	47.72	-21.35	AVG
0.618	36.4	10.41	46.81	56	-9.19	peak
0.626	21.61	10.41	32.02	46	-13.98	AVG
1.69	35.34	10.42	45.76	56	-10.24	peak
1.81	17.87	10.42	28.29	46	-17.71	AVG

Remark:

1. All readings are Quasi-Peak and Average values.
2. Factor = Insertion Loss + Cable Loss.
3. '*' means the worst case

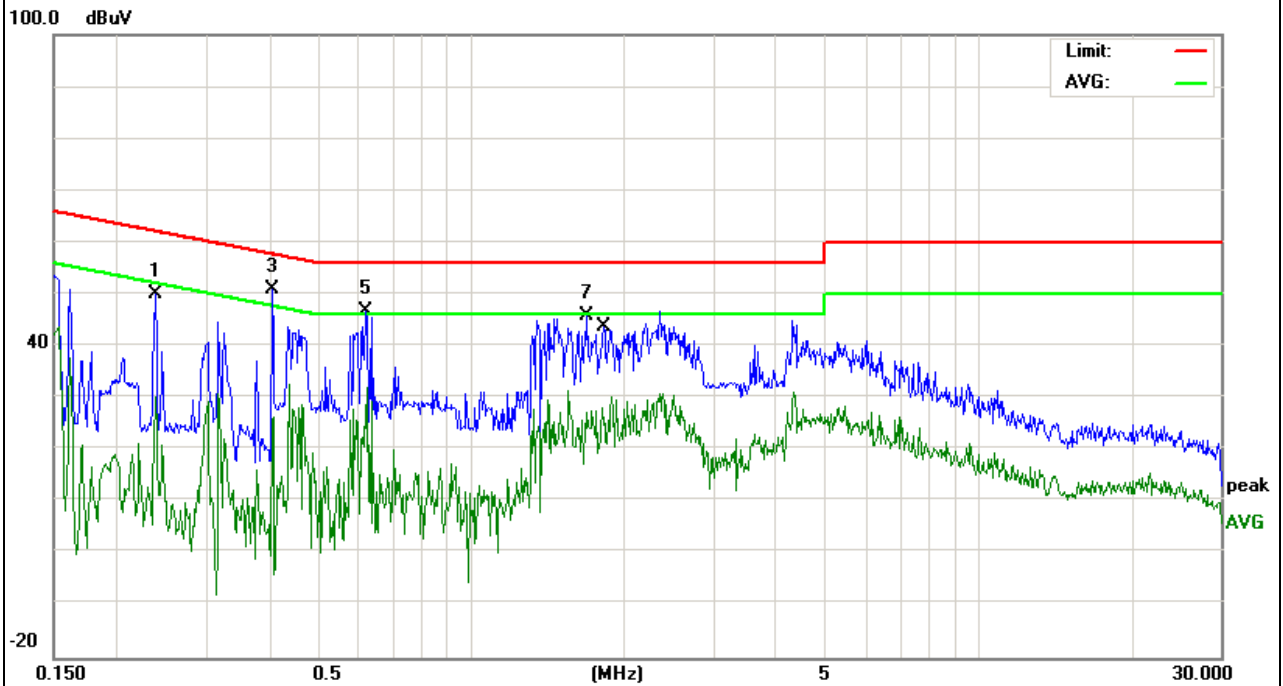

3.3 RADIATED EMISSION MEASUREMENT

3.3.1 Radiated Emission Limits (FCC 15.209)

Frequencies (MHz)	Field Strength (microrvolts/meter)	Measurement Distance (meters)
0.009~0.490	2400/F(KHz)	300
0.490~1.705	24000/F(KHz)	30
1.705~30.0	30	30
30~88	100	3
88~216	150	3
216~960	200	3
Above 960	500	3

Note:

- (1) The tighter limit applies at the band edges.
- (2) Emission level (dBuV/m)=20log Emission level (uV/m).

LIMITS OF RADIATED EMISSION MEASUREMENT (FCC 15.249)

Frequency of Emission (MHz)	Field Strength of fundamental ((millivolts /meter)	Field Strength of Harmonics (microvolts/meter)
2400 - 2483.5	50	500

Notes:

- (1) Emissions radiated outside of the specified frequency bands, except for harmonics, shall be attenuated by at least 50 dB below the level of the fundamental or to the general radiated emission limits in Section 15.209, whichever is the lesser attenuation.

Spectrum Parameter	Setting
Attenuation	Auto
Start Frequency	1000 MHz
Stop Frequency	10th carrier harmonic
RB / VB (emission in restricted band)	1MHz / 1MHz for Peak

Dongle Parameter	Setting
Attenuation	Auto
Start ~ Stop Frequency	9kHz~150kHz / RB 200Hz for QP
Start ~ Stop Frequency	150kHz~30MHz / RB 9kHz for QP
Start ~ Stop Frequency	30MHz~1000MHz / RB 120kHz for QP

3.3.2 TEST PROCEDURE

- a. The measuring distance of at 3 m shall be used for measurements at frequency up to 1GHz. For frequencies above 1GHz, any suitable measuring distance may be used.
- b. The EUT was placed on the top of a rotating table 0.8 meters above the ground at a 3m meter open area test site. The table was rotated 360 degrees to determine the position of the highest radiation.
- c. The height of the equipment or of the substitution antenna shall be 0.8 m; the height of the test antenna shall vary between 1 m to 4 m. Both horizontal and vertical polarizations of the antenna are set to make the measurement. performed pretest to three orthogonal axis.
- d. The initial step in collecting conducted emission data is a spectrum analyzer peak detector mode pre-scanning the measurement frequency range. Significant peaks are then marked and then Quasi Peak detector mode re-measured.
- e. If the Peak Mode measured value compliance with and lower than Quasi Peak Mode Limit, the EUT shall be deemed to meet QP Limits and then no additional QP Mode measurement performed.
- f. For the actual test configuration, please refer to the related Item –EUT Test Photos.

3.3.3 DEVIATION FROM TEST STANDARD

No deviation

3.3.4 TEST SETUP

(A) Radiated Emission Test Set-Up Frequency Below 30 MHz

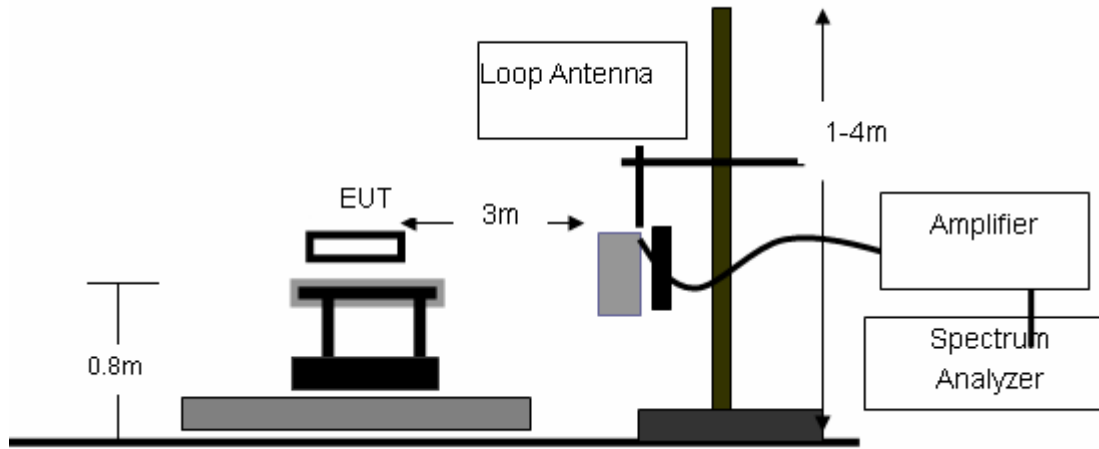

(B) Radiated Emission Test Set-Up, Frequency Below 1000MHz

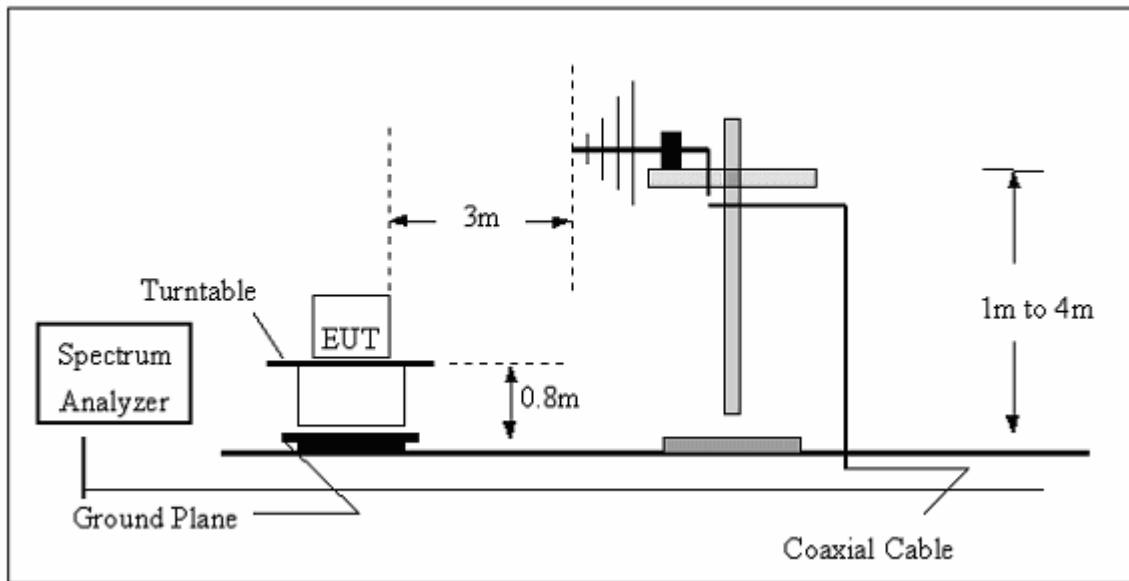

(C) Radiated Emission Test Set-Up Frequency Above 1 GHz

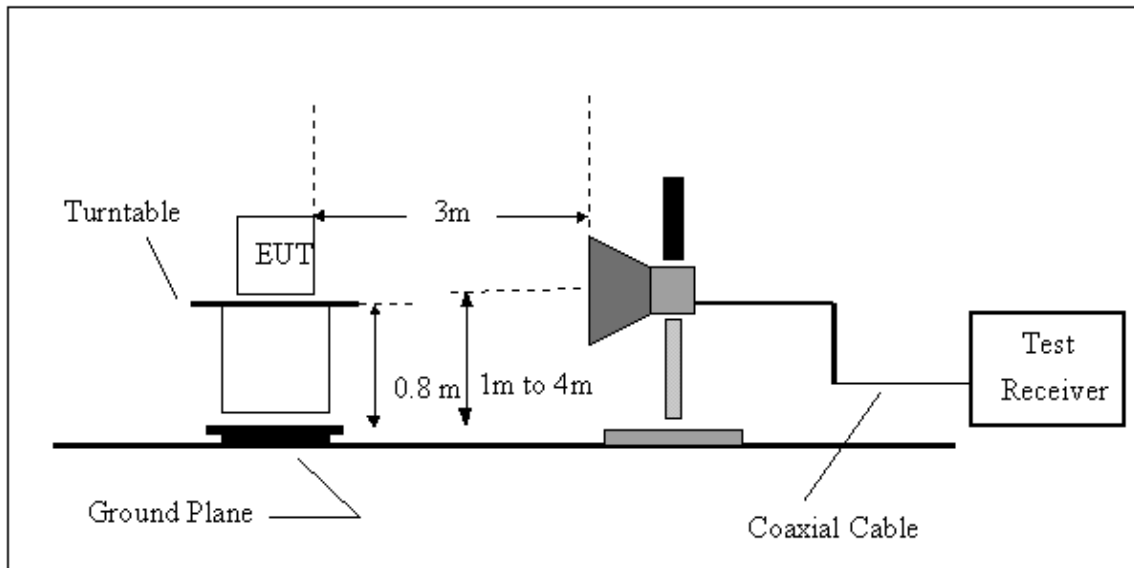

3.3.5 TEST RESULTS (BLOW 30MHz)

EUT :	Dongle	Model Name. :	JF-T01-D
Temperature :	20 °C	Relative Humidity :	48%
Pressure :	1010 hPa	Test Voltage :	DC5V
Test Mode :	TX	Polarization :	--

Freq.	Reading	Limit	Margin	State
(MHz)	(dBuV/m)	(dBuV/m)	(dB)	P/F
--	--	--	--	PASS
--	--	--	--	PASS

NOTE:

The amplitude of spurious emissions which are attenuated by more than 20dB below the permissible value has no need to be reported.

Distance extrapolation factor = $20 \log(\text{specific distance}/\text{test distance})$ (dB);

Limit line = specific limits(dBuv) + distance extrapolation factor.

3.3.6 TEST RESULTS (BETWEEN 30 – 1000 MHZ)

EUT :	Dongle	Model Name :	JF-T01-D
Temperature :	24 °C	Relative Humidity :	54%
Pressure :	1010 hPa	Polarization :	Horizontal
Test Mode :	TX		
Test Power :	DC 5V from PC AC 120V/60Hz		

Frequency (MHz)	Meter Reading (dBμV)	Factor (dB)	Emission Level (dBμV/m)	Limits (dBμV/m)	Margin (dB)	Detector Type
30.12	11.85	18.28	30.13	40	-9.87	QP
180.23	25.83	9.65	35.48	43.5	-8.02	QP
300.54	22.32	14.57	36.89	46	-9.11	QP
494.53	22.53	19.25	41.78	46	-4.22	QP

Remark:

1. Factor = Antenna Factor + Cable Loss – Pre-amplifier.

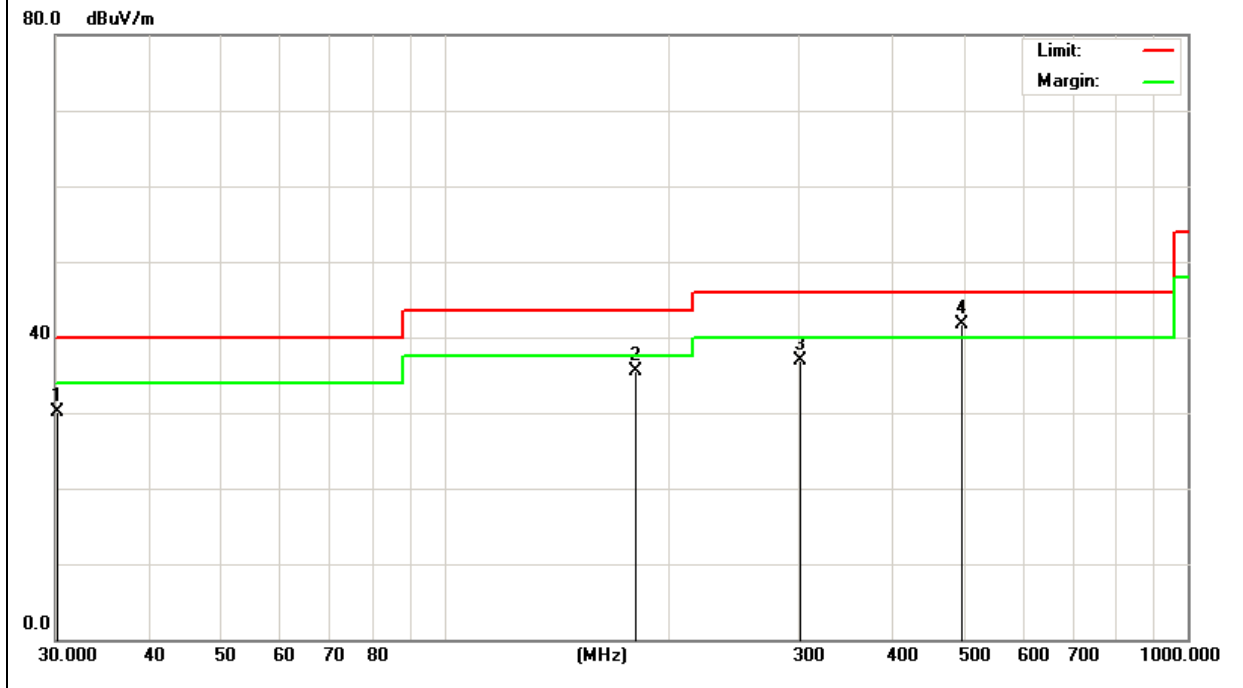

EUT :	Dongle	Model Name :	JF-T01-D
Temperature :	24 °C	Relative Humidity :	54%
Pressure :	1010 hPa	Polarization :	Vertical
Test Mode :	TX		
Test Power :	DC 5V from PC AC 120V/60Hz		

Frequency (MHz)	Meter Reading (dBμV)	Factor (dB)	Emission Level (dBμV/m)	Limits (dBμV/m)	Margin (dB)	Detector Type
98.56	26.49	10.38	36.87	43.5	-6.63	QP
135.047	20.08	11.99	32.07	43.5	-11.43	QP
320.45	26.14	14.73	40.87	46	-5.13	QP
420.78	22.19	17.92	40.11	46	-5.89	QP

Remark:

1. Factor = Antenna Factor + Cable Loss – Pre-amplifier.

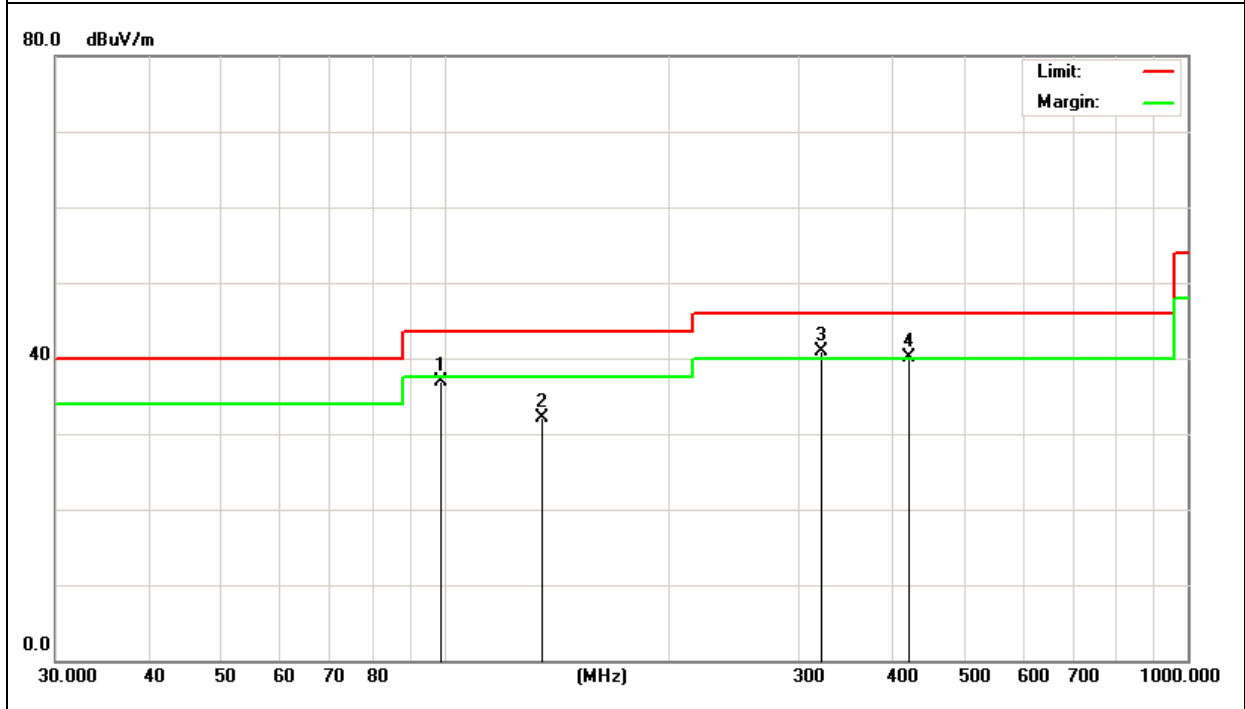

3.3.7 TEST RESULTS (ABOVE 1000 MHZ)

EUT :	Dongle	Model Name :	JF-T01-D
Temperature :	24 °C	Relative Humidity :	54%
Pressure :	1010 hPa	Polarization :	Horizontal
Test Mode :	TX 2403MHz		
Test Power :	DC 5V from PC AC 120V/60Hz		

Frequency (MHz)	Meter Reading (dBμV)	Factor (dB)	Emission Level (dBμV/m)	Limits (dBμV/m)	Margin (dB)	Detector Type
1201.19	60.28	-4.01	56.27	74	-17.73	peak
1201.19	44.24	-4.01	40.23	54	-13.77	AVG
2403.25	98.05	-0.69	97.36	114.0 0	-16.64	peak
2403.25	90.14	-0.69	89.45	94	-4.55	AVG
4806.52	42.38	10.4	52.78	74	-21.22	peak
4806.52	33.96	10.4	44.36	54	-9.64	AVG
7209.52	38.35	12.39	50.74	74	-23.26	peak
7209.52	27.16	12.39	39.55	54	-14.45	AVG

Remark:

- Factor = Antenna Factor + Cable Loss – Pre-amplifier.

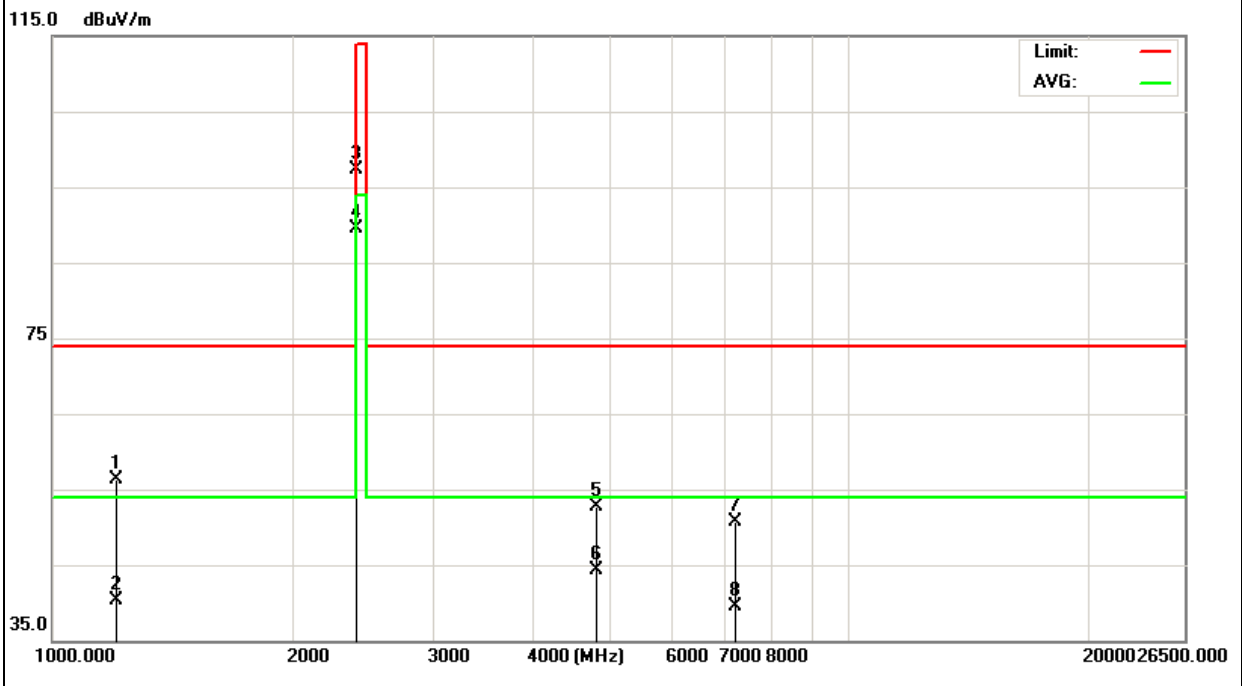

EUT :	Dongle	Model Name :	JF-T01-D
Temperature :	24 °C	Relative Humidity :	54%
Pressure :	1010 hPa	Polarization :	Vertical
Test Mode :	TX 2403MHz		
Test Power :	DC 5V from PC AC 120V/60Hz		

Frequency (MHz)	Meter Reading (dBμV)	Factor (dB)	Emission Level (dBμV/m)	Limits (dBμV/m)	Margin (dB)	Detector Type
1122.23	55.64	-4.9	50.74	74	-23.26	peak
1122.23	45.15	-4.9	40.25	54	-13.75	AVG
2403.26	99.22	-0.69	98.53	114.0 0	-15.47	peak
2403.26	85.93	-0.69	85.24	94	-8.76	AVG
4806.52	42.07	10.4	52.47	74	-21.53	peak
4806.52	35.14	10.4	45.54	54	-8.46	AVG
7209.52	36.96	12.39	49.35	74	-24.65	peak
7209.52	28.03	12.39	40.42	54	-13.58	AVG

Remark:

1. Factor = Antenna Factor + Cable Loss – Pre-amplifier.

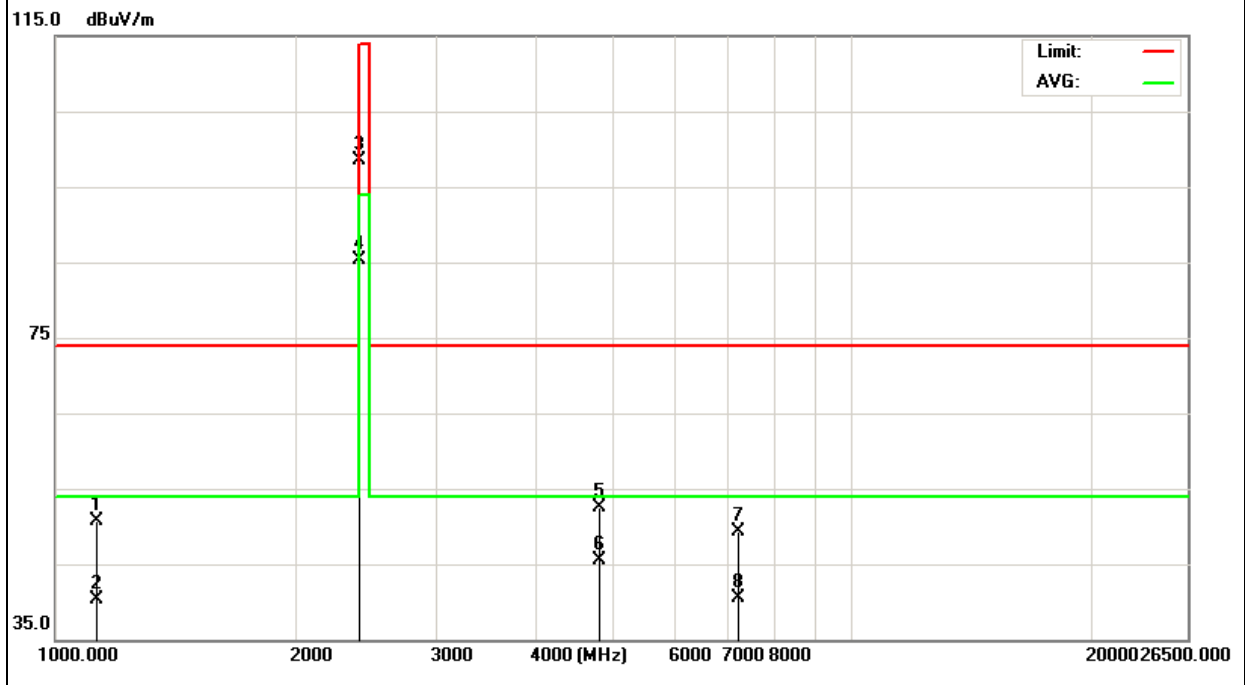

EUT :	Dongle	Model Name :	JF-T01-D
Temperature :	24 °C	Relative Humidity :	54%
Pressure :	1010 hPa	Polarization :	Horizontal
Test Mode :	TX 2453MHz		
Test Power :	DC 5V from PC AC 120V/60Hz		

Frequency (MHz)	Meter Reading (dBμV)	Factor (dB)	Emission Level (dBμV/m)	Limits (dBμV/m)	Margin (dB)	Detector Type
1896.29	53.25	-1.8	51.45	74	-22.55	peak
1896.29	46.58	-1.8	44.78	54	-9.22	AVG
2453.19	95.93	-0.6	95.33	114.0 0	-18.67	peak
2453.19	88.14	-0.6	87.54	94	-6.46	AVG
4906.38	44.24	10.3	54.54	74	-19.46	peak
4906.38	33.45	10.3	43.75	54	-10.25	AVG
7359.68	34.54	12.78	47.32	74	-26.68	peak
7359.68	28.41	12.78	41.19	54	-12.81	AVG

Remark:

1. Factor = Antenna Factor + Cable Loss – Pre-amplifier.

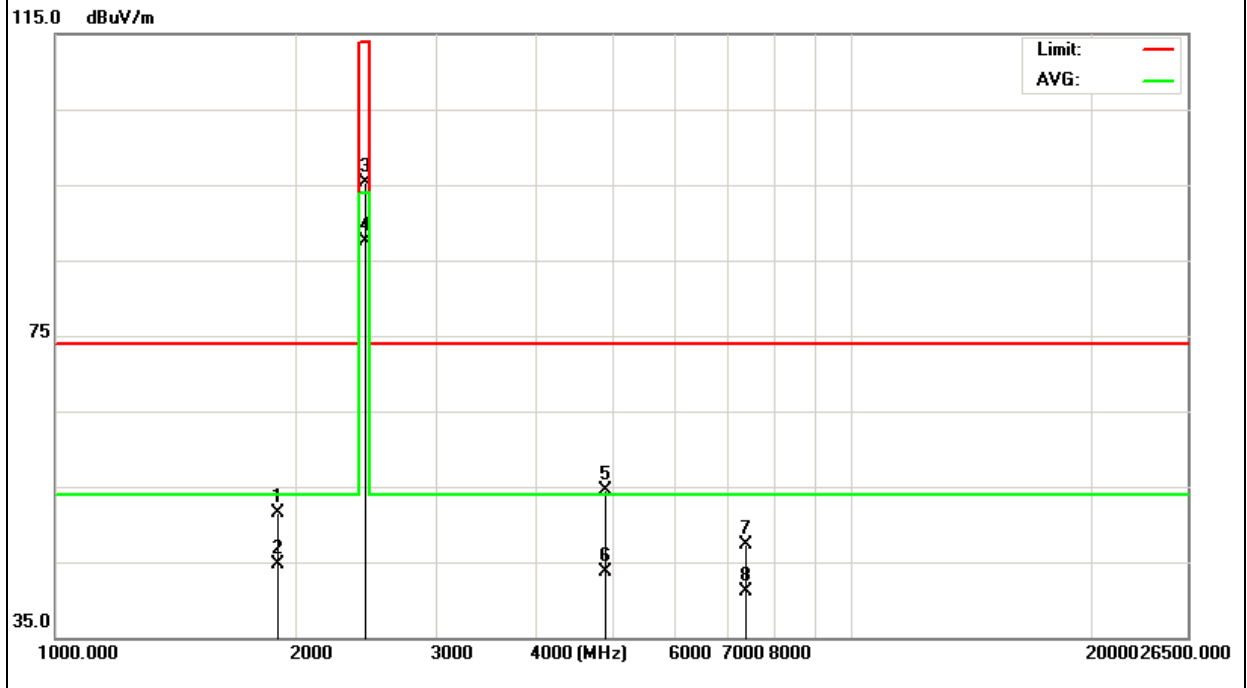

EUT :	Dongle	Model Name :	JF-T01-D
Temperature :	24 °C	Relative Humidity :	54%
Pressure :	1010 hPa	Polarization :	Vertical
Test Mode :	TX 2453MHz		
Test Power :	DC 5V from PC AC 120V/60Hz		

Frequency (MHz)	Meter Reading (dBμV)	Factor (dB)	Emission Level (dBμV/m)	Limits (dBμV/m)	Margin (dB)	Detector Type
1556.35	53.46	-3.68	49.78	74	-24.22	peak
1556.35	38.95	-3.68	35.27	54	-18.73	AVG
2453.19	100.07	-0.6	99.47	114.0 0	-14.53	peak
2453.19	89.26	-0.6	88.66	94	-5.34	AVG
4906.38	44.26	10.3	54.56	74	-19.44	peak
4906.38	32.98	10.3	43.28	54	-10.72	AVG
7359.68	37.96	12.78	50.74	74	-23.26	peak
7359.68	28.86	12.78	41.64	54	-12.36	AVG

Remark:

1. Factor = Antenna Factor + Cable Loss – Pre-amplifier.

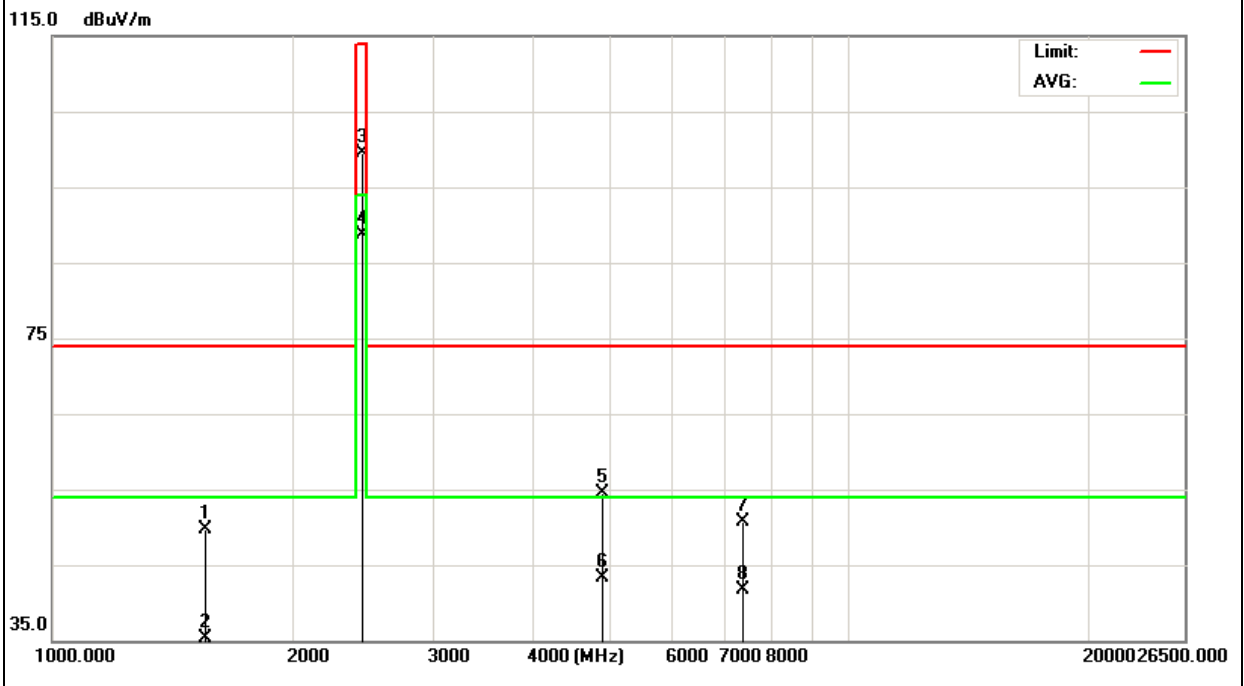

EUT :	Dongle	Model Name :	JF-T01-D
Temperature :	24 °C	Relative Humidity :	54%
Pressure :	1010 hPa	Polarization :	Horizontal
Test Mode :	TX 2478MHz		
Test Power :	DC 5V from PC AC 120V/60Hz		

Frequency (MHz)	Meter Reading (dBμV)	Factor (dB)	Emission Level (dBμV/m)	Limits (dBμV/m)	Margin (dB)	Detector Type
1657.35	53.24	-2.99	50.25	74	-23.75	peak
1657.35	44.4	-2.99	41.41	54	-12.59	AVG
2478.32	96.04	-0.5	95.54	114.0 0	-18.46	peak
2478.32	85.85	-0.5	85.35	94	-8.65	AVG
4956.64	41	10.47	51.47	74	-22.53	peak
4956.64	33.49	10.47	43.96	54	-10.04	AVG
7434.96	38.48	13.08	51.56	74	-22.44	peak
7434.96	27.7	13.08	40.78	54	-13.22	AVG

Remark:

1. Factor = Antenna Factor + Cable Loss – Pre-amplifier.

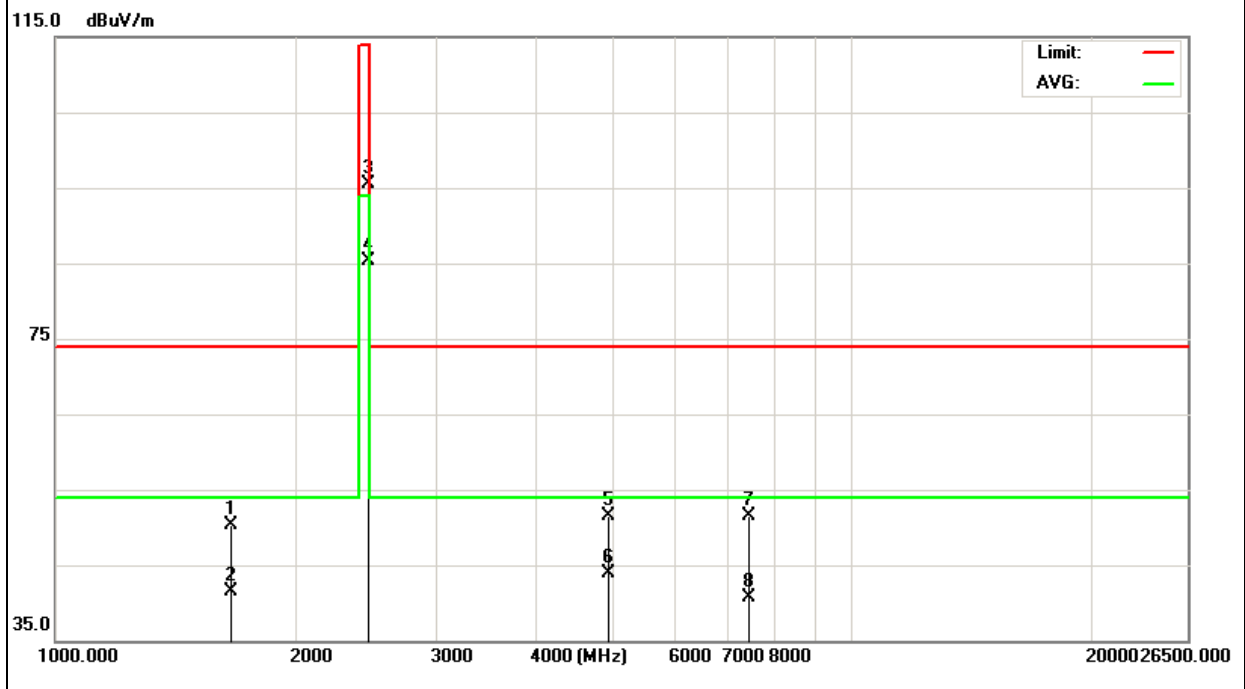

EUT :	Dongle	Model Name :	JF-T01-D
Temperature :	24 °C	Relative Humidity :	54%
Pressure :	1010 hPa	Polarization :	Vertical
Test Mode :	TX 2478MHz		
Test Power :	DC 5V from PC AC 120V/60Hz		

Frequency (MHz)	Meter Reading (dBμV)	Factor (dB)	Emission Level (dBμV/m)	Limits (dBμV/m)	Margin (dB)	Detector Type
1754.16	52.22	-2.54	49.68	74	-24.32	peak
1754.16	44.28	-2.54	41.74	54	-12.26	AVG
2478.32	99.64	-0.5	99.14	114.0 0	-14.86	peak
2478.32	89.11	-0.5	88.61	94	-5.39	AVG
4956.64	38.4	10.47	48.87	74	-25.13	peak
4956.64	28.9	10.47	39.37	54	-14.63	AVG
7434.96	37.03	13.08	50.11	74	-23.89	peak
7434.96	25.39	13.08	38.47	54	-15.53	AVG

Remark:

1. Factor = Antenna Factor + Cable Loss – Pre-amplifier.

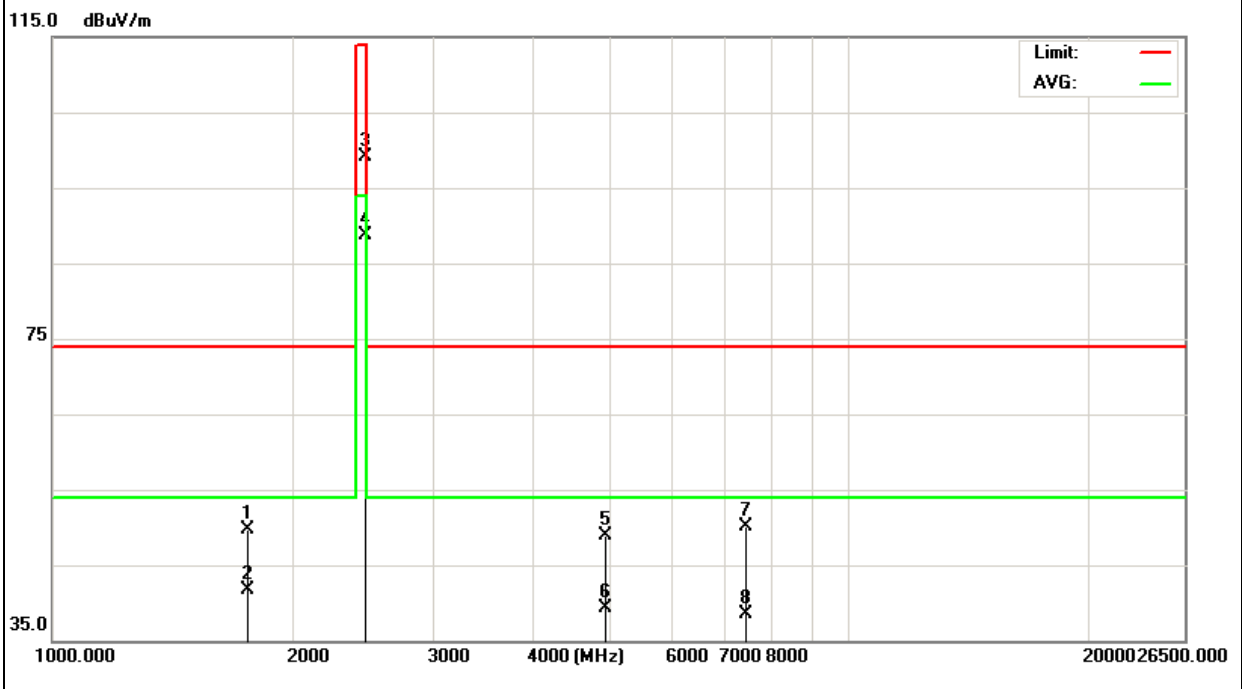

3.3.8 TEST RESULTS (RESTRICTED BANDS REQUIREMENTS)

EUT :	Dongle	Model Name :	JF-T01-D
Temperature :	25 °C	Relative Humidity :	60%
Pressure :	1012 hPa	Polarization :	Horizontal
Test Voltage :	DC 5V from PC AC 120V/60Hz		
Test Mode :	CH1		
Note :	1. The transmitter was setup to transmit at the lowest channel. Then the field strength was measured at 2310-2390 MHz. 2. The transmitter was setup to transmit at the highest channel. Then the field strength was measured at 2483.5-2500 MHz.		

Frequency (MHz)	Meter Reading (dBμV)	Factor (dB)	Emission Level (dBμV/m)	Limits (dBμV/m)	Margin (dB)	Detector Type
2390.00	28.26	35	63.26	74	-10.74	peak
2390.00	15.23	35	50.23	54	-3.77	AVG

Remark:

- Factor = Antenna Factor + Cable Loss – Pre-amplifier.
- Radiated emissions measured in frequency range above 1000MHz were made with an instrument using Peak detector mode
- During the measurements above 1 GHz it is taken care of that the EUT is always within the 3 dB cone of radiation BW of the used antenna

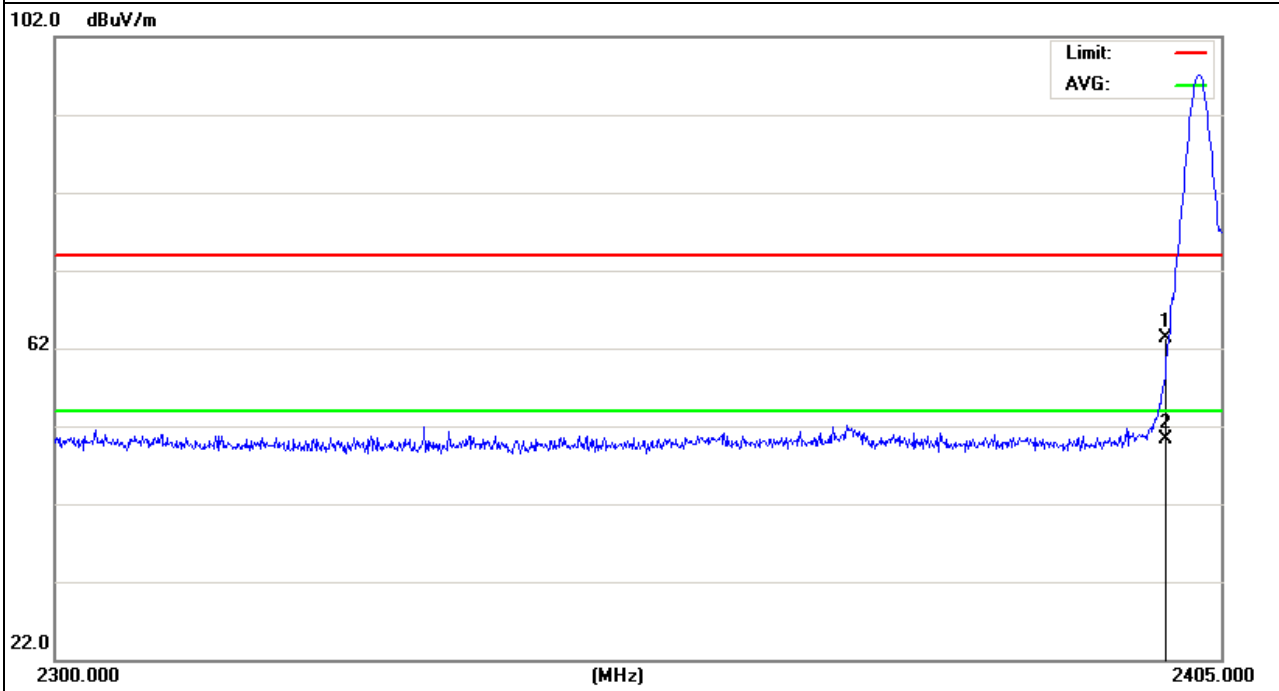

EUT :	Dongle	Model Name :	JF-T01-D
Temperature :	25 °C	Relative Humidity :	60%
Pressure :	1012 hPa	Polarization :	Vertical
DC 5V from PC AC 120V/60Hz			
Test Mode :	CH1		
Note :	1. The transmitter was setup to transmit at the lowest channel. Then the field strength was measured at 2310-2390 MHz. 2. The transmitter was setup to transmit at the highest channel. Then the field strength was measured at 2483.5-2500 MHz.		

Frequency (MHz)	Meter Reading (dBµV)	Factor (dB)	Emission Level (dBµV/m)	Limits (dBµV/m)	Margin (dB)	Detector Type
2390.00	29.81	35	64.81	74	-9.19	peak
2390.00	16.19	35	51.19	54	-2.81	AVG

Remark:

- Factor = Antenna Factor + Cable Loss – Pre-amplifier.
- Radiated emissions measured in frequency range above 1000MHz were made with an instrument using Peak detector mode
- During the measurements above 1 GHz it is taken care of that the EUT is always within the 3 dB cone of radiation BW of the used antenna

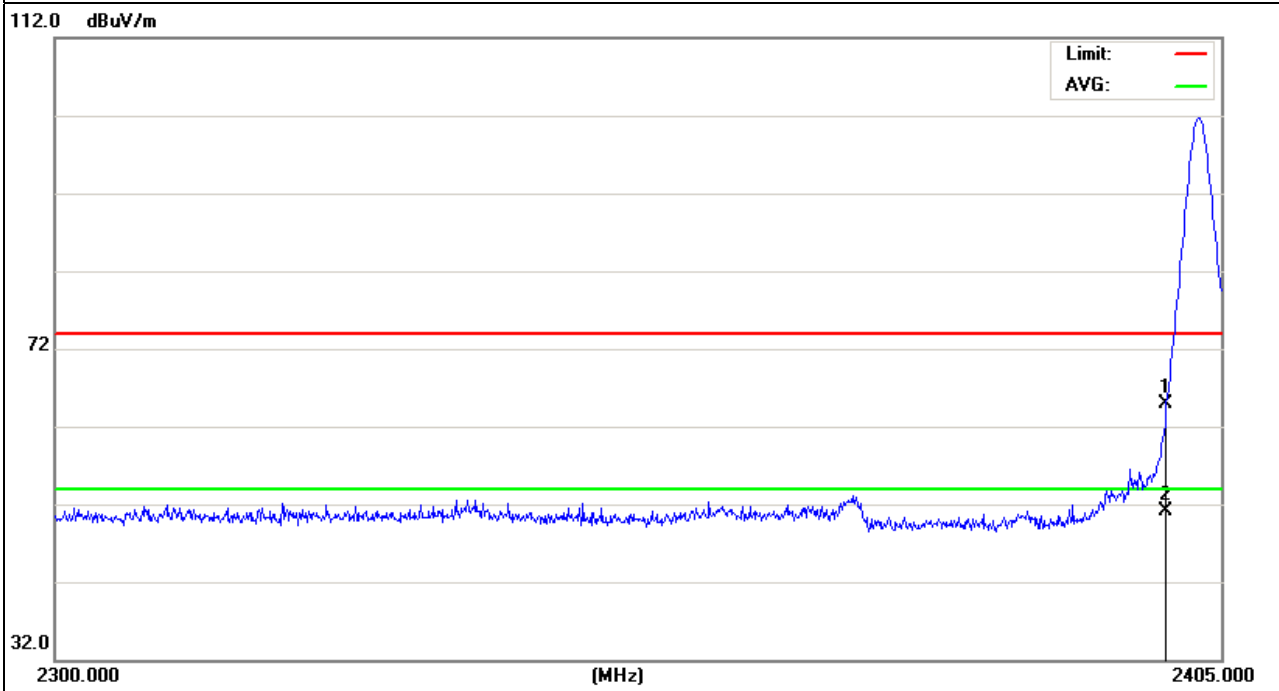

EUT :	Dongle	Model Name :	JF-T01-D
Temperature :	25 °C	Relative Humidity :	60%
Pressure :	1012 hPa	Polarization :	Horizontal
Test Voltage :	DC 5V from PC AC 120V/60Hz		
Test Mode :	CH20		
Note :	1. The transmitter was setup to transmit at the lowest channel. Then the field strength was measured at 2310-2390 MHz. 2. The transmitter was setup to transmit at the highest channel. Then the field strength was measured at 2483.5-2500 MHz.		

Frequency (MHz)	Meter Reading (dBμV)	Factor (dB)	Emission Level (dBμV/m)	Limits (dBμV/m)	Margin (dB)	Detector Type
2483.5	14.62	35.25	49.87	74	-24.13	peak
2483.5	3.7	35.25	38.95	54	-15.05	AVG

Remark:

4. Factor = Antenna Factor + Cable Loss – Pre-amplifier.
5. Radiated emissions measured in frequency range above 1000MHz were made with an instrument using Peak detector mode
6. During the measurements above 1 GHz it is taken care of that the EUT is always within the 3 dB cone of radiation BW of the used antenna

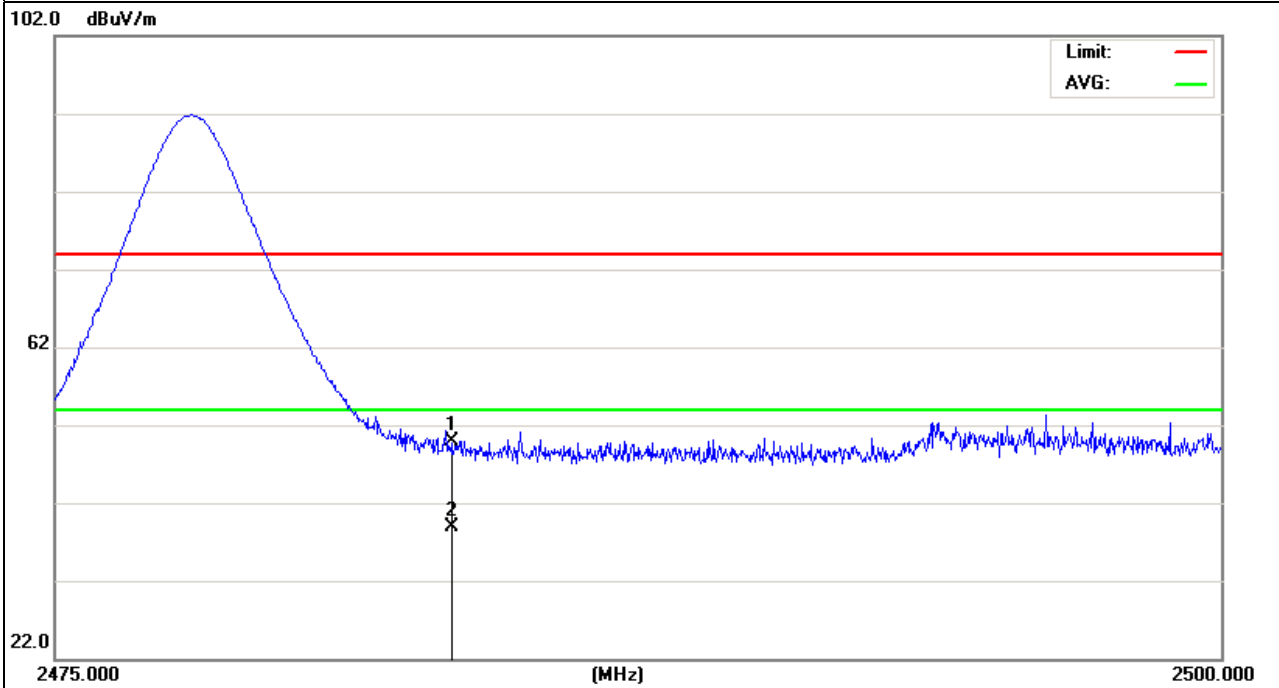

EUT :	Dongle	Model Name :	JF-T01-D
Temperature :	25 °C	Relative Humidity :	60%
Pressure :	1012 hPa	Polarization :	Vertical
DC 5V from PC AC 120V/60Hz			
Test Mode :	CH20		
Note :	1. The transmitter was setup to transmit at the lowest channel. Then the field strength was measured at 2310-2390 MHz. 2. The transmitter was setup to transmit at the highest channel. Then the field strength was measured at 2483.5-2500 MHz.		

Frequency (MHz)	Meter Reading (dBµV)	Factor (dB)	Emission Level (dBµV/m)	Limits (dBµV/m)	Margin (dB)	Detector Type
2483.5	12.64	35.25	47.89	74	-26.11	peak
2483.5	3.05	35.25	38.3	54	-15.7	AVG

Remark:

4. Factor = Antenna Factor + Cable Loss – Pre-amplifier.
5. Radiated emissions measured in frequency range above 1000MHz were made with an instrument using Peak detector mode
6. During the measurements above 1 GHz it is taken care of that the EUT is always within the 3 dB cone of radiation BW of the used antenna

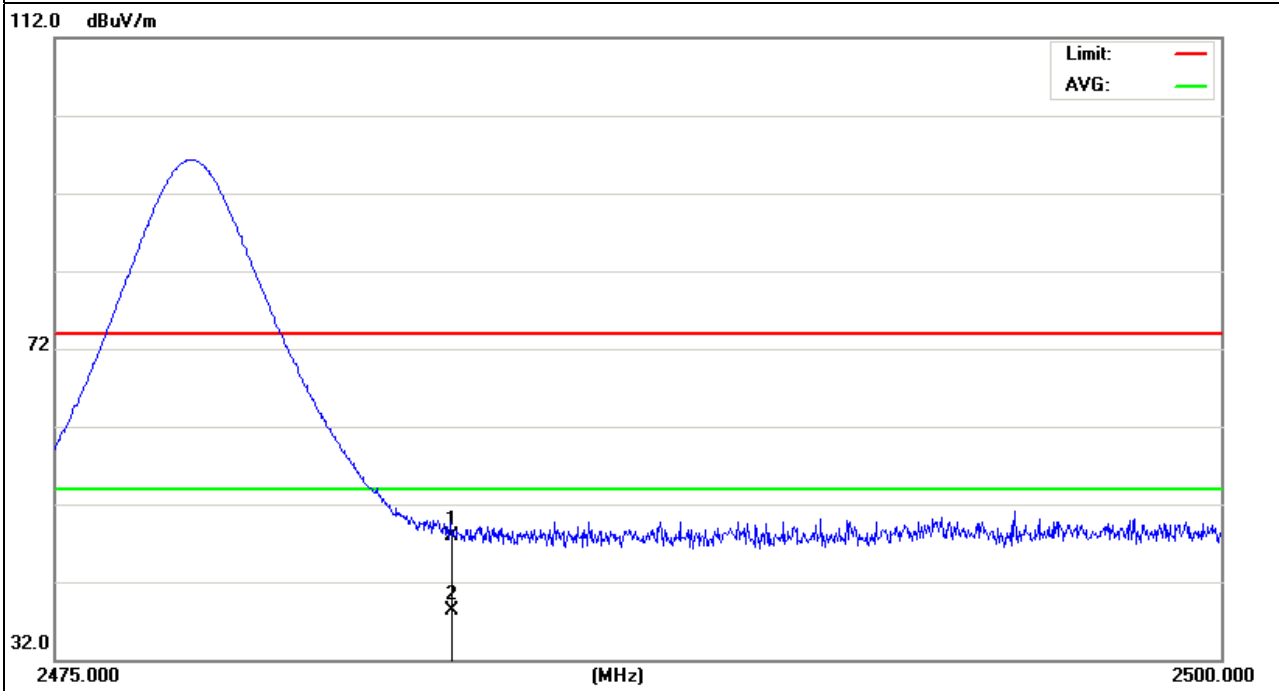

4. BANDWIDTH TEST

4.1 TEST PROCEDURE

- a. The EUT was directly connected to the spectrum analyzer and antenna output port as show in the block diagram below,
- b. Spectrum Setting : RBW= 100KHz, VBW \geq RBW, Sweep time = Auto.

4.2 DEVIATION FROM STANDARD

No deviation.

4.3 TEST SETUP



4.4 TEST RESULTS

EUT :	Dongle	Model Name :	JF-T01-D
Temperature :	26 °C	Relative Humidity :	53%
Pressure :	1020 hPa	Test Power :	DC 5V from PC AC 120V/60Hz
Test Mode :	TX (L/M/H)		

Test Channel	Frequency (MHz)	20 dBc Bandwidth (MHz)
Low	2403	0.323
Middle	2453	0.321
High	2478	0.321

The Lowest Channel:2403MHz

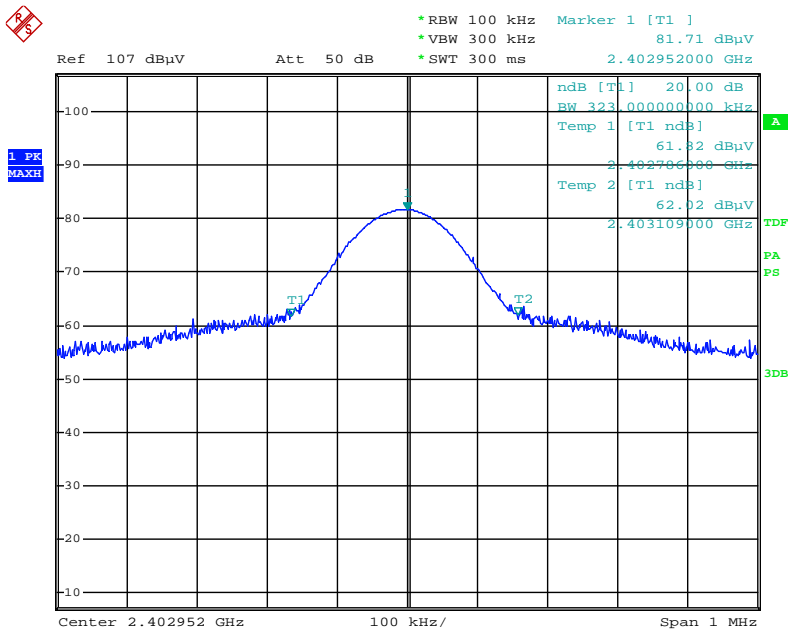

Date: 31.OCT.2011 12:59:05

The Middle Channel:2453MHz

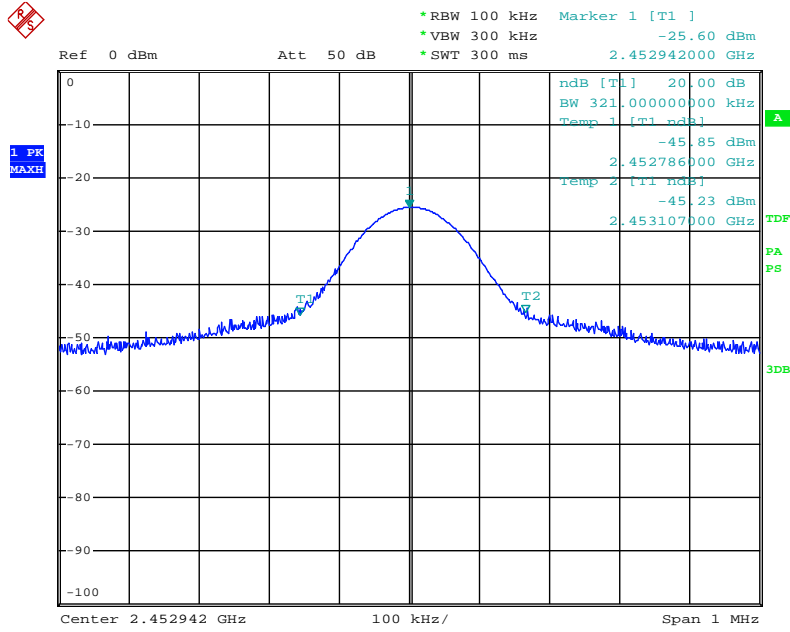

Date: 31.OCT.2011 13:00:33

The Middle Channel:2478MHz

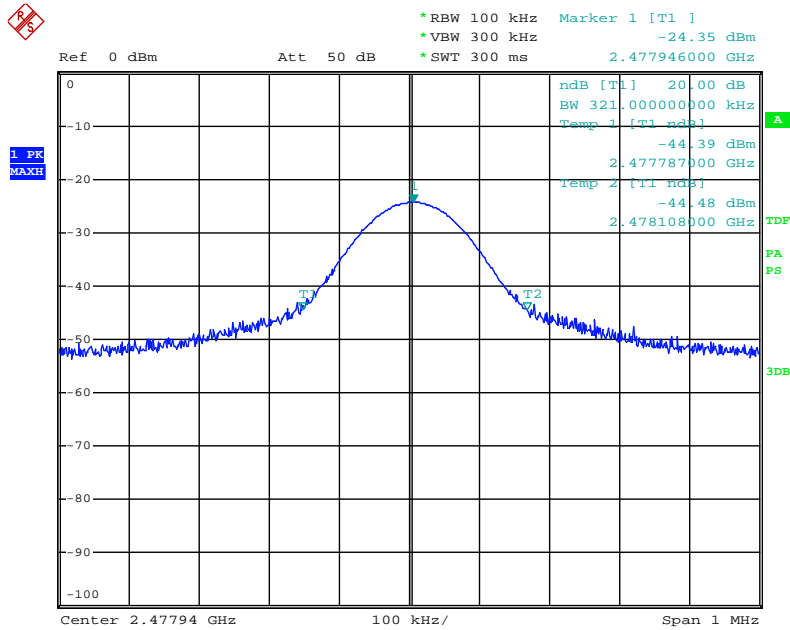

Date: 31.OCT.2011 13:03:04