



A D T

DFS TEST REPORT

REPORT NO.: RF981005A05-2

MODEL NO.: T7MD1

RECEIVED: Oct. 05, 2009

TESTED: Apr. 08, 2010

ISSUED: Apr. 12, 2010

APPLICANT: TWINHEAD INTERNATIONAL CORP.

ADDRESS: 10F, No. 550, Rueiguang Rd., Neihu Chiu, Taipei, Taiwan 114, R.O.C.

ISSUED BY : Bureau Veritas Consumer Products Services (H.K.) Ltd., Taoyuan Branch

LAB ADDRESS : No. 47, 14th Ling, Chia Pau Tsuen, Lin Kou Hsiang, Taipei Hsien 244, Taiwan, R.O.C.

TEST LOCATION : No. 19, Hwa Ya 2nd Rd, Wen Hwa Tsuen, Kwei Shan Hsiang, Taoyuan Hsien 333, Taiwan, R.O.C.

This test report consists of 22 pages in total. It may be duplicated completely for legal use with the approval of the applicant. It should not be reproduced except in full, without the written approval of our laboratory. The client should not use it to claim product endorsement by TAF or any government agencies. The test results in the report only apply to the tested sample.





Table of Contents

- 1. LAB DECLARATION.....3
- 2. EUT INFORMATION.....4
 - 2.1 OPERATING FREQUENCY BANDS AND MODE OF EUT4
 - 2.2 EUT SOFTWARE AND FIRMWARE VERSION4
 - 2.3 DESCRIPTION OF AVAILABLE ANTENNAS TO THE EUT4
 - 2.4 EUT MAXIMUM AND MINIMUM CONDUCTED POWER.....5
 - 2.5 EUT MAXIMUM AND MINIMUM E.I.R.P. POWER6
 - 2.6 STATEMENT OF MAUNFACTURER6
- 3. U-NII DFS RULE REQUIREMENTS.....7
 - 3.1 WORKING MODES AND REQUIRED TEST ITEMS7
 - 3.2 TEST LIMITS AND RADAR SIGNAL PARAMETERS8
- 4. TEST & SUPPORT EQUIPMENT LIST10
 - 4.1 TEST INSTRUMENTS10
 - 4.2 DESCRIPTION OF SUPPORT UNITS10
- 5. TEST PROCEDURE.....11
 - 5.1 ADT DFS MEASUREMENT SYSTEM:.....11
 - 5.2 CALIBRATION OF DFS DETECTION THRESHOLD LEVEL:.....12
 - 5.3 DEVIATION FROM TEST STANDARD13
 - 5.4 CONDUCTED TEST SETUP CONFIGURATION.....13
 - 5.4.1 CLIENT WITHOUT RADAR DETECTION MODE13
- 6. TEST RESULTS14
 - 6.1 SUMMARY OF TEST RESULTS14
 - 6.2 DETELED TEST RESULTS.....15
 - 6.2.1 TEST MODE: DEVICE OPERATING IN CLIENT WITHOUT RADAR DETECTION MODE15
 - 6.2.1.1 DFS DETECTION THRESHOLD.....15
 - 6.2.1.2 CHANNEL CLOSING TRANSMISSION AND CHANNEL MOVE TIME.....16
 - 6.2.1.3 NON- OCCUPANCY PERIOD.....19
- 7. TESTING LABORATORIES INFORMATION.....21
- 8. APPENDIX A - MODIFICATIONS RECORDERS FOR ENGINEERING CHANGES TO THE EUT BY THE LAB22



1. LAB DECLARATION

PRODUCT: Tablet PC
MODEL NO.: T7MD1
BRAND NAME: DURABOOK, TabletKiosk, MobileDemand™, PaceBlade, LOGIC INSTRUMENT
APPLICANT: TWINHEAD INTERNATIONAL CORP.
TESTED: Apr. 08, 2010
TEST SAMPLE: ENGINEERING SAMPLE
STANDARDS: FCC Part 15, Subpart E (Section 15.407)
FCC 06-96

The above equipment (model: T7MD1) has been tested by **Bureau Veritas Consumer Products Services (H.K.) Ltd., Taoyuan Branch**, and found compliance with the requirement of the above standards. The test record, data evaluation & Equipment Under Test (EUT) configurations represented herein are true and accurate accounts of the measurements of the sample's EMC characteristics under the conditions specified in this report.

PREPARED BY : Andrea Hsia , **DATE:** Apr. 12, 2010
Andrea Hsia / Specialist

TECHNICAL ACCEPTANCE : Dylan Chiou , **DATE:** Apr. 12, 2010
Responsible for RF Dylan Chiou / Senior Engineer

APPROVED BY : Gary Chang , **DATE:** Apr. 12, 2010
Gary Chang / Assistant Manager

2. EUT INFORMATION

2.1 OPERATING FREQUENCY BANDS AND MODE OF EUT

TABLE 1: OPERATING FREQUENCY BANDS AND MODE OF EUT

OPERATIONAL MODE	OPERATING FREQUENCY RANGE	
	5250~5350MHz	5470~5725MHz
Client without radar detection and ad hoc function	✓	✓

**The EUT has disabled the 5600 ~ 5650 MHz band

2.2 EUT SOFTWARE AND FIRMWARE VERSION

TABLE 2: THE EUT SOFTWARE/FIRMWARE VERSION

NO.	PRODUCT	MODEL NO.	SOFTWARE/FIRMWARE VERSION
1	tablet PC	T7MD1	Firmware: 12.1.0.14 (2008/08/28)

2.3 DESCRIPTION OF AVAILABLE ANTENNAS TO THE EUT

TABLE 3: ANTENNA LIST

ANT NO.	ANTENNA TYPE	OPERATION FREQUENCY RANGE (MHz)	MAX. GAIN (dBi)
1	PIFA	5250~5350	2.87
1	PIFA	5470~5725	2.87

2.4 EUT MAXIMUM AND MINIMUM CONDUCTED POWER

TABLE 4: THE MEASURED CONDUCTED OUTPUT POWER

IEEE 802.11a

ANT NO.	FREQUENCY BAND (MHz)	MAX. POWER		MIN. POWER	
		OUTPUT POWER(dBm)	OUTPUT POWER(mW)	OUTPUT POWER(dBm)	OUTPUT POWER(mW)
1	5250~5350	15.2	33.1	10	10
1	5470~5725	12.4	17.4	10	10

DRAFT 802.11n (20MHz)

ANT NO.	FREQUENCY BAND (MHz)	MAX. POWER		MIN. POWER	
		OUTPUT POWER(dBm)	OUTPUT POWER(mW)	OUTPUT POWER(dBm)	OUTPUT POWER(mW)
1	5250~5350	14.9	30.9	10	10
1	5470~5725	12.6	18.2	10	10

DRAFT 802.11n (40MHz)

ANT NO.	FREQUENCY BAND (MHz)	MAX. POWER		MIN. POWER	
		OUTPUT POWER(dBm)	OUTPUT POWER(mW)	OUTPUT POWER(dBm)	OUTPUT POWER(mW)
1	5250~5350	15.0	31.6	10	10
1	5470~5725	12.6	18.2	10	10

2.5 EUT MAXIMUM AND MINIMUM E.I.R.P. POWER

TABLE 5: THE E.I.R.P OUTPUT POWER LIST

IEEE 802.11a

ANT NO.	FREQUENCY BAND (MHz)	MAX. POWER		MIN. POWER	
		OUTPUT POWER(dBm)	OUTPUT POWER(mW)	OUTPUT POWER(dBm)	OUTPUT POWER(mW)
1	5250~5350	18.1	64.1	12.9	19.4
1	5470~5725	15.3	33.7	12.9	19.4

DRAFT 802.11n (20MHz)

ANT NO.	FREQUENCY BAND (MHz)	MAX. POWER		MIN. POWER	
		OUTPUT POWER(dBm)	OUTPUT POWER(mW)	OUTPUT POWER(dBm)	OUTPUT POWER(mW)
1	5250~5350	17.8	59.8	12.9	19.4
1	5470~5725	15.5	35.2	12.9	19.4

DRAFT 802.11n (40MHz)

ANT NO.	FREQUENCY BAND (MHz)	MAX. POWER		MIN. POWER	
		OUTPUT POWER(dBm)	OUTPUT POWER(mW)	OUTPUT POWER(dBm)	OUTPUT POWER(mW)
1	5250~5350	17.9	61.2	12.9	19.4
1	5470~5725	15.5	35.2	12.9	19.4

2.6 STATEMENT OF MAUNFACTURER

Manufacturer statement confirming that information regarding the parameters of the detected Radar Waveforms is not available to the end user. **And the device doesn't have Ad Hoc mode on DFS frequency band.**

3. U-NII DFS RULE REQUIREMENTS

3.1 WORKING MODES AND REQUIRED TEST ITEMS

The manufacturer shall state whether the UUT is capable of operating as a Master and/or a Client. If the UUT is capable of operating in more than one operating mode then each operating mode shall be tested separately. See tables 1 and 2 for the applicability of DFS requirements for each of the operational modes.

TABLE 6: APPLICABILITY OF DFS REQUIREMENTS PRIOR TO USE A CHANNEL

REQUIREMENT	OPERATIONAL MODE		
	MASTER	CLIENT WITHOUT RADAR DETECTION	CLIENT WITH RADAR DETECTION
Non-Occupancy Period	✓	Not required	✓
DFS Detection Threshold	✓	Not required	✓
Channel Availability Check Time	✓	Not required	Not required
Uniform Spreading	✓	Not required	Not required
U-NII Detection Bandwidth	✓	Not required	✓

TABLE 7: APPLICABILITY OF DFS REQUIREMENTS DURING NORMAL OPERATION

REQUIREMENT	OPERATIONAL MODE		
	MASTER	CLIENT WITHOUT RADAR DETECTION	CLIENT WITH RADAR DETECTION
DFS Detection Threshold	✓	Not required	✓
Channel Closing Transmission Time	✓	✓	✓
Channel Move Time	✓	✓	✓
U-NII Detection Bandwidth	✓	Not required	✓

3.2 TEST LIMITS AND RADAR SIGNAL PARAMETERS

DETECTION THRESHOLD VALUES

TABLE 8: DFS DETECTION THRESHOLDS FOR MASTER DEVICES AND CLIENT DEVICES WITH RADAR DETECTION

MAXIMUM TRANSMIT POWER	VALUE (SEE Note 1 and 2)
≥ 200 milliwatt	-64 dBm
< 200 milliwatt	-62 dBm

Note 1: This is the level at the input of the receiver assuming a 0 dBi receive antenna.

Note 2: Throughout these test procedures an additional 1 dB has been added to the amplitude of the test transmission waveforms to account for variations in measurement equipment. This will ensure that the test signal is at or above the detection threshold level to trigger a DFS response.

TABLE 9: DFS RESPONSE REQUIREMENT VALUES

PARAMETER	VALUE
Non-occupancy period	Minimum 30 minutes
Channel Availability Check Time	60 seconds
Channel Move Time	10 seconds See Note 1.
Channel Closing Transmission Time	200 milliseconds + an aggregate of 60 milliseconds over remaining 10 second period. See Notes 1 and 2.
U-NII Detection Bandwidth	Minimum 80% of the UNII 99% transmission power bandwidth. See Note 3.

Note 1: The instant that the Channel Move Time and the Channel Closing Transmission Time begins is as follows:

- For the Short Pulse Radar Test Signals this instant is the end of the Burst.
- For the Frequency Hopping radar Test Signal, this instant is the end of the last radar Burst generated.
- For the Long Pulse Radar Test Signal this instant is the end of the 12 second period defining the Radar Waveform.

Note 2: The Channel Closing Transmission Time is comprised of 200 milliseconds starting at the beginning of the Channel Move Time plus any additional intermittent control signals required to facilitate a Channel move (an aggregate of 60 milliseconds) during the remainder of the 10 second period. The aggregate duration of control signals will not count quiet periods in between transmissions.

Note 3: During the U-NII Detection Bandwidth detection test, radar type 1 is used and for each frequency step the minimum percentage of detection is 90 percent. Measurements are performed with no data traffic.



PARAMETERS OF DFS TEST SIGNALS

Step intervals of 0.1 microsecond for Pulse Width, 1 microsecond for PRI, 1 MHz for chirp width and 1 for the number of pulses will be utilized for the random determination of specific test waveforms.

TABLE 10: SHORT PULSE RADAR TEST WAVEFORMS

RADAR TYPE	PULSE WIDTH (μsec)	PRI (μsec)	NUMBER OF PULSES	MINIMUM PERCENTAGE OF SUCCESSFUL DETECTION	MINIMUM NUMBER OF TRIALS
1	1	1428	18	60%	30
2	1-5	150-230	23-29	60%	30
3	6-10	200-500	16-18	60%	30
4	11-20	200-500	12-16	60%	30
Aggregate (Radar Types 1-4)				80%	120

TABLE 11: LONG PULSE RADAR TEST WAVEFORM

RADAR TYPE	PULSE WIDTH (μsec)	CHIRP WIDTH (MHz)	PRI (μsec)	NUMBER OF PULSES PER BURST	NUMBER OF BURSTS	MINIMUM PERCENTAGE OF SUCCESSFUL DETECTION	MINIMUM NUMBER OF TRIALS
5	50-100	5-20	1000-2000	1-3	8-20	80%	30

TABLE 12: FREQUENCY HOPPING RADAR TEST WAVEFORM

RADAR TYPE	PULSE WIDTH (μsec)	PRI (μsec)	PULSES PER HOP	HOPPING RATE (kHz)	HOPPING SEQUENCE LENGTH (msec)	MINIMUM PERCENTAGE OF SUCCESSFUL DETECTION	MINIMUM NUMBER OF TRIALS
6	1	333	9	0.333	300	70%	30

4. TEST & SUPPORT EQUIPMENT LIST

4.1 TEST INSTRUMENTS

TABLE 1: TEST INSTRUMENTS LIST.

DESCRIPTION & MANUFACTURER	MODEL NO.	BRAND	DATE OF CALIBRATION	DUE DATE OF CALIBRATION
R&S Spectrum analyzer	FSP40	R&S	May. 26, 2009	May. 25, 2010
Signal generator	8645A	Agilent	Jun. 05, 2009	Jun. 04, 2010
Oscilloscope	TDS 5104	Tektronix	Sep. 16, 2009	Sep. 15, 2010

4.2 DESCRIPTION OF SUPPORT UNITS

TABLE 2: SUPPORT UNIT INFORMATION.

NO.	PRODUCT	BRAND	MODEL NO.	FCC ID
1	802.11a/b/g/n Access Point	Cisco	AIR-AP1252AG-A-K9	LDK102061

NOTE: This device was functioned as a Master Slave device during the DFS test.

TABLE 3: SOFTWARE/FIRMWARE INFORMATION.

NO.	PRODUCT	MODEL NO.	SOFTWARE/FIRMWARE VERSION
1.	802.11a/b/g/n Access Point	AIR-AP1252AG-A-K9	12.4(10b)JA1

5. TEST PROCEDURE

5.1 ADT DFS MEASUREMENT SYSTEM:

A complete ADT DFS Measurement System consists of two subsystems: (1) the Radar Signal Generating Subsystem and (2) the Traffic Monitoring Subsystem. The control PC is necessary for generating the Radar waveforms in Table 6, 7 and 8. The traffic monitoring subsystem is specified to the type of unit under test (UUT).

CONDUCTED SETUP CONFIGURATION OF ADT DFS MEASUREMENT SYSTEM

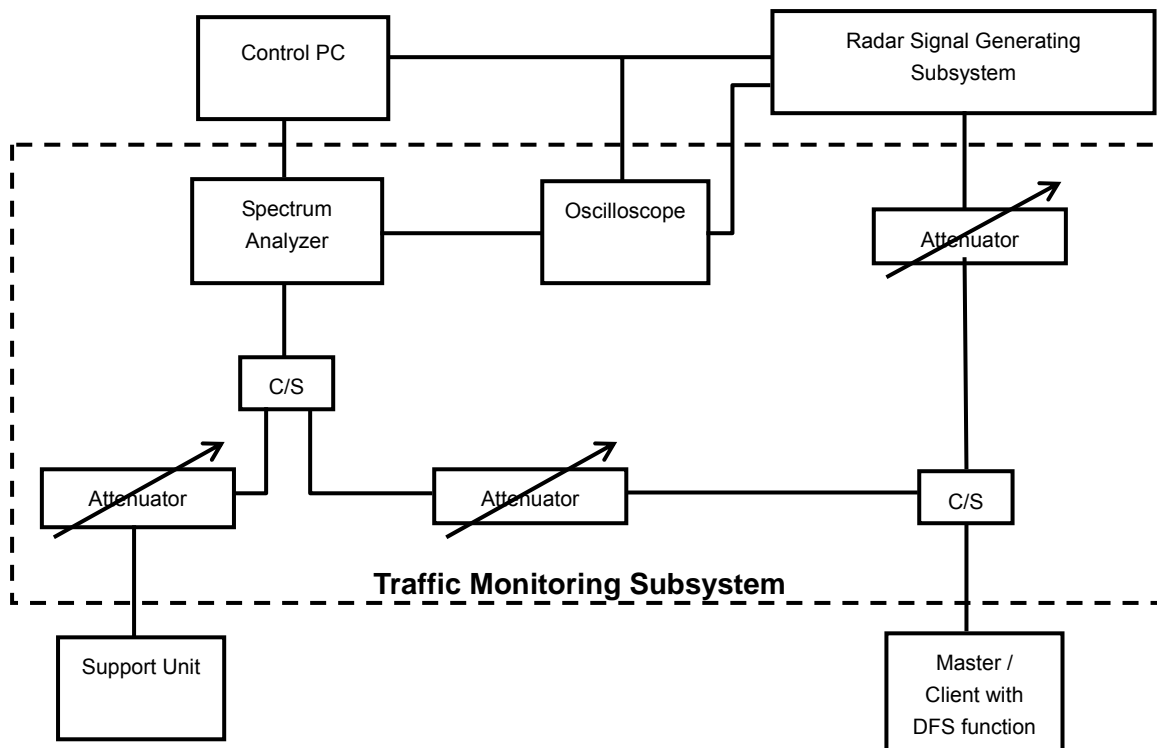

The test transmission will always be from the Master Device to the Client Device. While the Client device is set up to associate with the Master device and play the MPEG file (6 $\frac{1}{2}$ Magic Hours) from Master device, the designated MPEG test file and instructions are located at:

<http://ntiacsd.ntia.doc.gov/dfs/>.

5.2 CALIBRATION OF DFS DETECTION THRESHOLD LEVEL:

The measured channel is 5500, 5510 MHz. The radar signal was the same as transmitted channels, and injected into the antenna port of AP (master) or Client Device with Radar Detection, measured the channel closing transmission time and channel move time. The Master antenna gain is 3dBi and required detection threshold is -59dBm (= -62 +3)dBm. The calibrated conducted detection threshold level is set to -59dBm. The tested level is lower than required level hence it provides margin to the limit.

CONDUCTED SETUP CONFIGURATION OF CALIBRATION OF DFS DETECTION THRESHOLD LEVEL

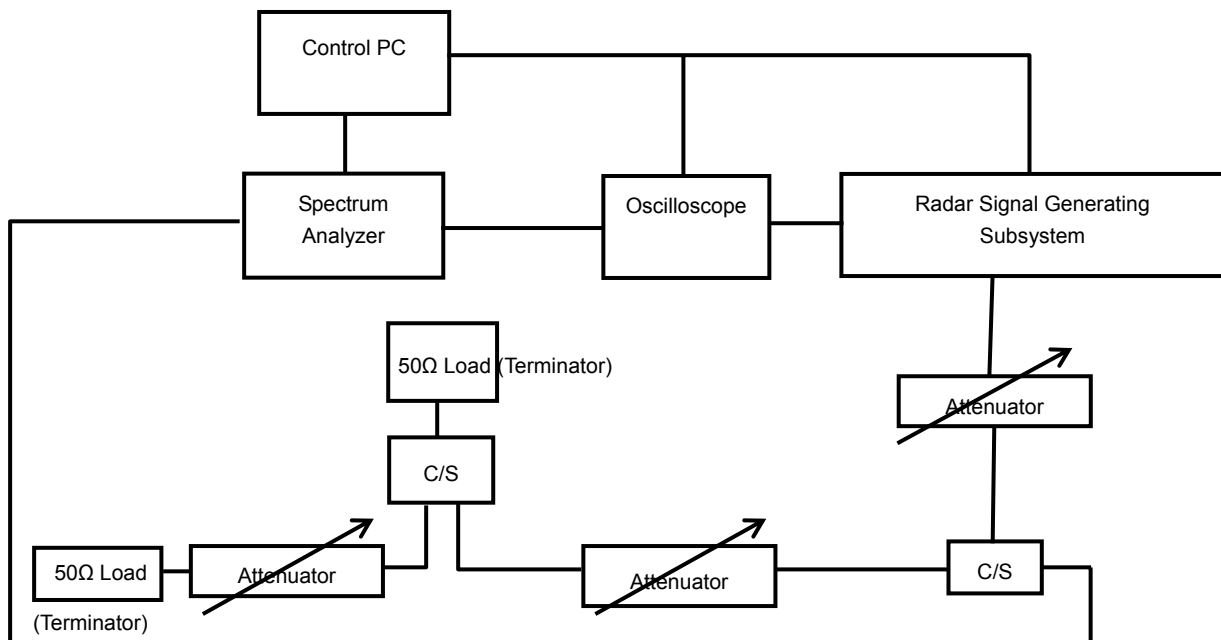

5.3 DEVIATION FROM TEST STANDARD

No deviation.

5.4 CONDUCTED TEST SETUP CONFIGURATION

5.4.1 CLIENT WITHOUT RADAR DETECTION MODE

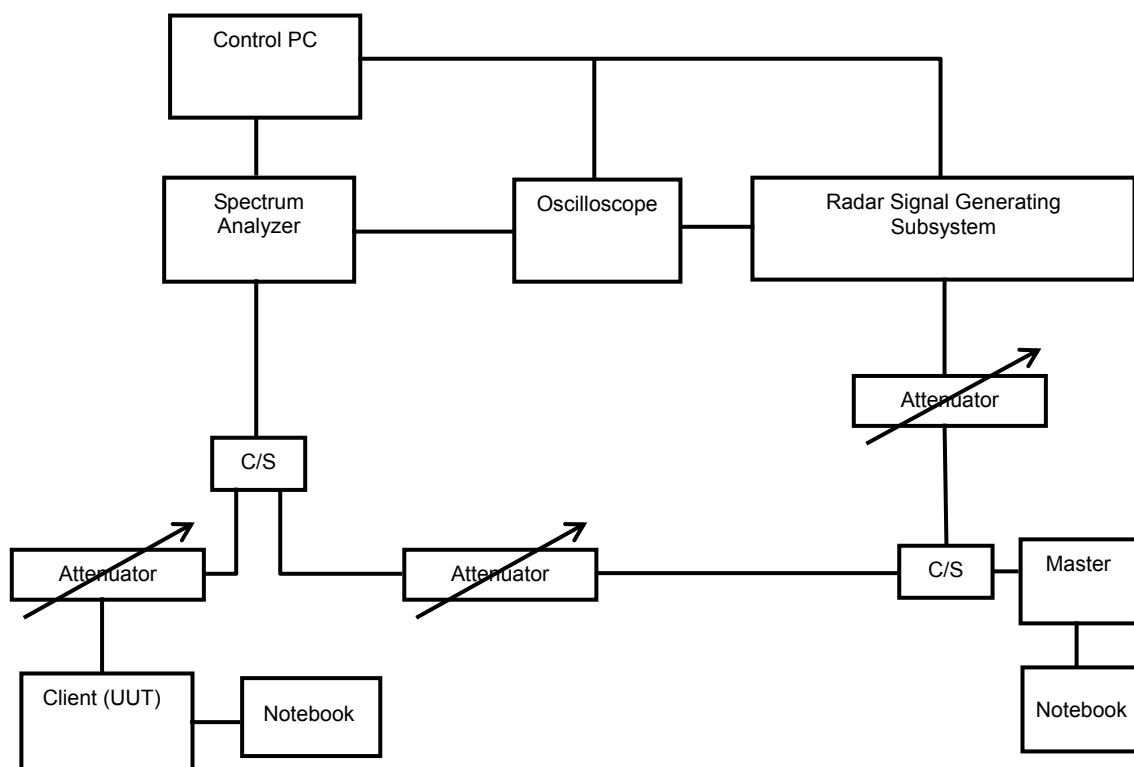

The UUT is a U-NII Device operating in Client mode without radar detection. The radar test signals are injected into the Master Device.



A D T

6. TEST RESULTS

6.1 SUMMARY OF TEST RESULTS

CLAUSE	TEST PARAMETER	REMARKS	PASS/FAIL
15.407	DFS Detection Threshold	Not Applicable	NA
15.407	Channel Availability Check Time	Not Applicable	NA
15.407	Channel Move Time	Applicable	Pass
15.407	Channel Closing Transmission Time	Applicable	Pass
15.407	Non- Occupancy Period	Applicable	Pass
15.407	Uniform Spreading	Not Applicable	NA
15.407	U-NII Detection Bandwidth	Not Applicable	NA
15.407	Non-associated test	Not Applicable	NA

6.2 DETELED TEST RESULTS

6.2.1 TEST MODE: DEVICE OPERATING IN CLIENT WITHOUT RADAR DETECTION MODE.

Client with injection at the Master. (The radar test signals are injected into the Master Device)

6.2.1.1 DFS DETECTION THRESHOLD

For a detection threshold level of -62dBm and the Master antenna gain is 3dBi . The Required detection threshold is -59dBm ($= -62 + 3$) dBm . The tested level is lower than required level hence it provides margin to the limit.

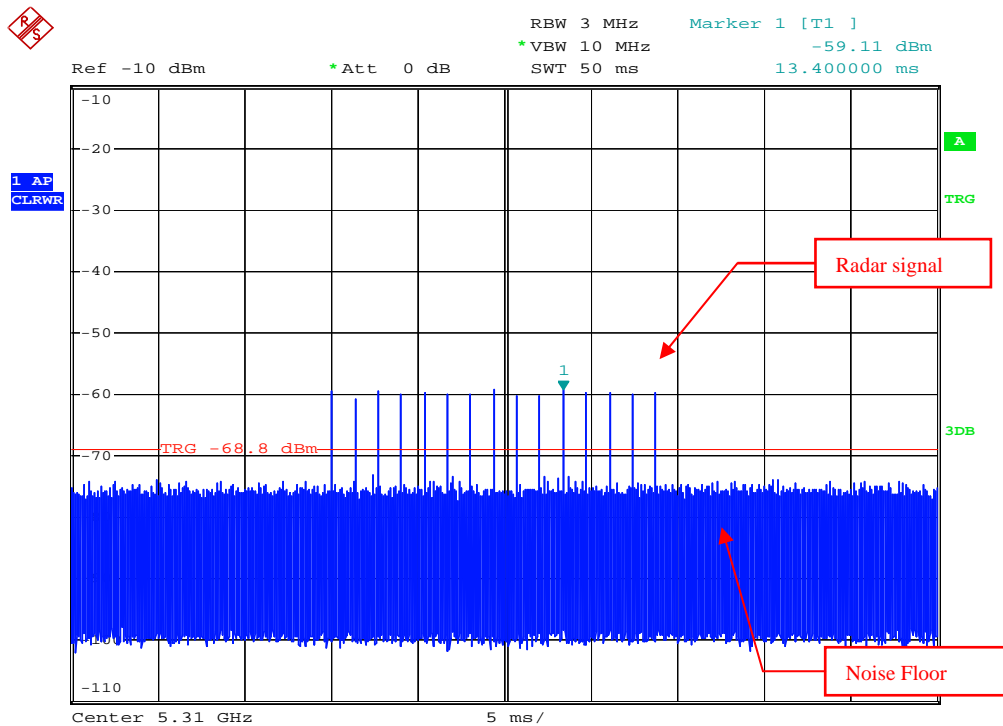

Radar Signal 1

6.2.1.2 CHANNEL CLOSING TRANSMISSION AND CHANNEL MOVE TIME

RADAR SIGNAL 1

802.11a

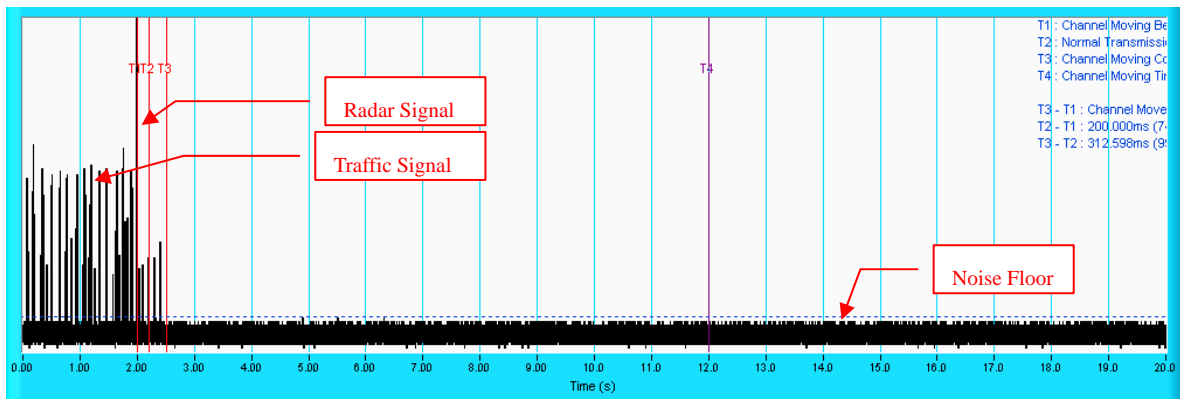

NOTE: T1 denotes the start of Channel Move Time upon the end of the last Radar burst. T2 denotes the data transmission time of 200ms from T1. T3 denotes the end of Channel Move Time. T4 denotes the 10 second from T1 to observe the aggregate duration of transmissions.

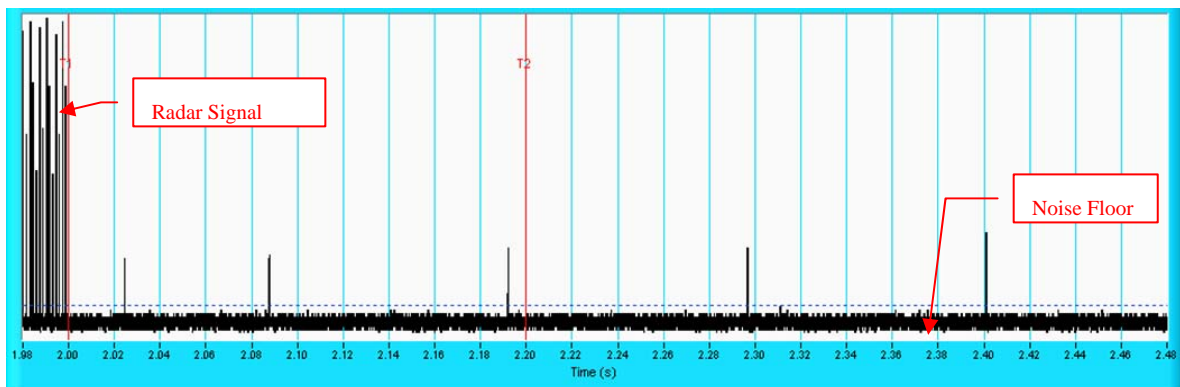

NOTE: An expanded plot for the device vacates the channel in the required 500ms.

802.11n (20MHz)

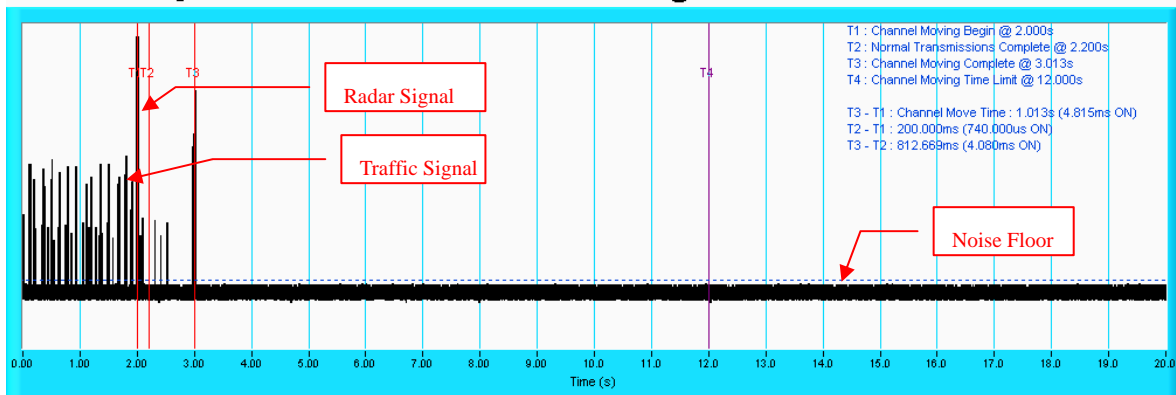

NOTE: T1 denotes the start of Channel Move Time upon the end of the last Radar burst. T2 denotes the data transmission time of 200ms from T1. T3 denotes the end of Channel Move Time. T4 denotes the 10 second from T1 to observe the aggregate duration of transmissions.

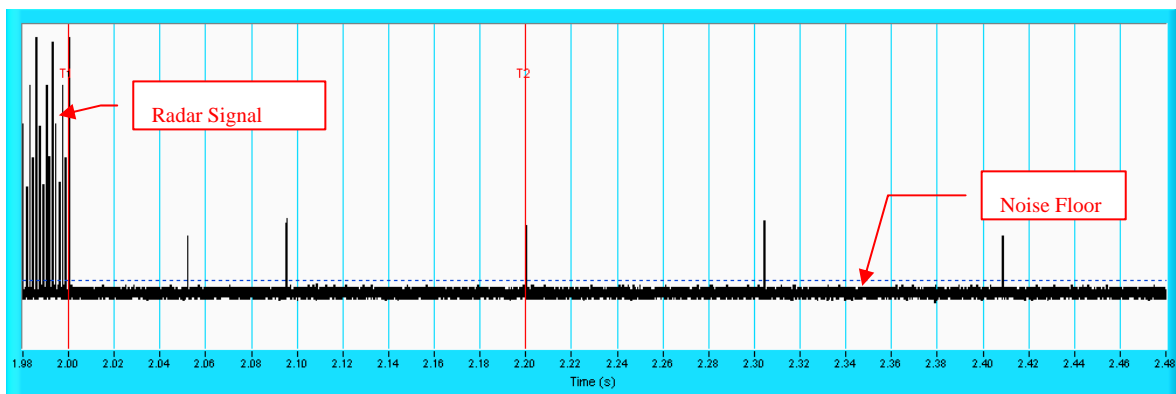

NOTE: An expanded plot for the device vacates the channel in the required 500ms.

802.11n (40MHz)

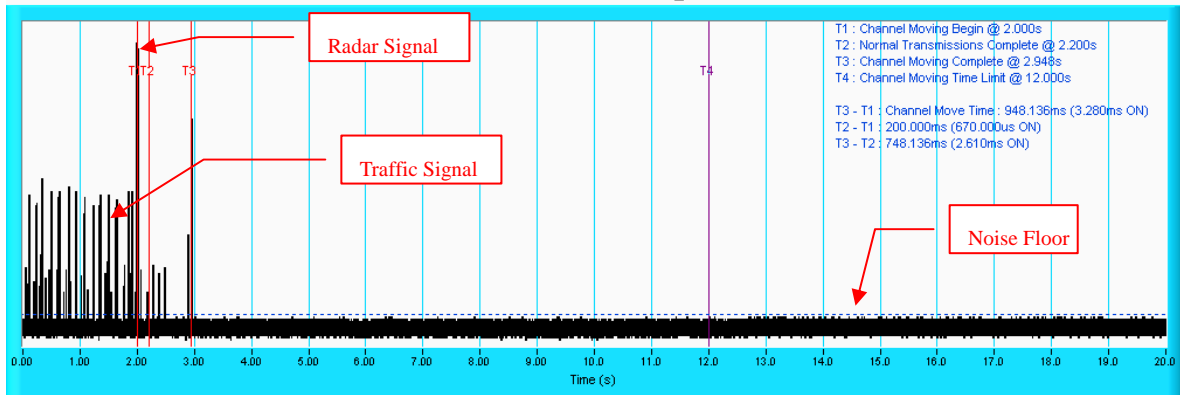

NOTE: T1 denotes the start of Channel Move Time upon the end of the last Radar burst. T2 denotes the data transmission time of 200ms from T1. T3 denotes the end of Channel Move Time. T4 denotes the 10 second from T1 to observe the aggregate duration of transmissions.

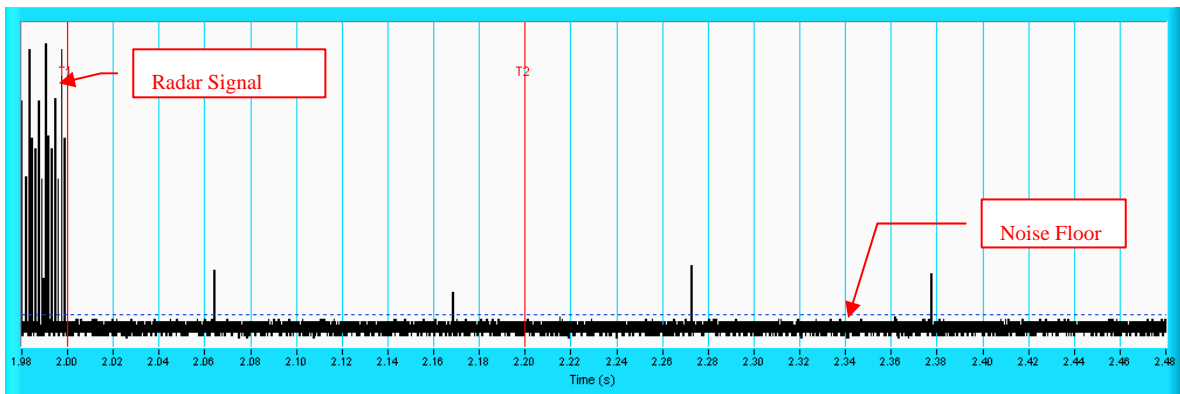

NOTE: An expanded plot for the device vacates the channel in the required 500ms.

6.2.1.3 NON- OCCUPANCY PERIOD

Associate test:

During the 30 minutes observation time, UUT did not make any transmissions on a channel after a radar signal was detected on that channel by either the Channel Availability Check or the In-Service Monitoring.

1) EUT links up with Master at 5500MHz.

Waveform of EUT links up with Master

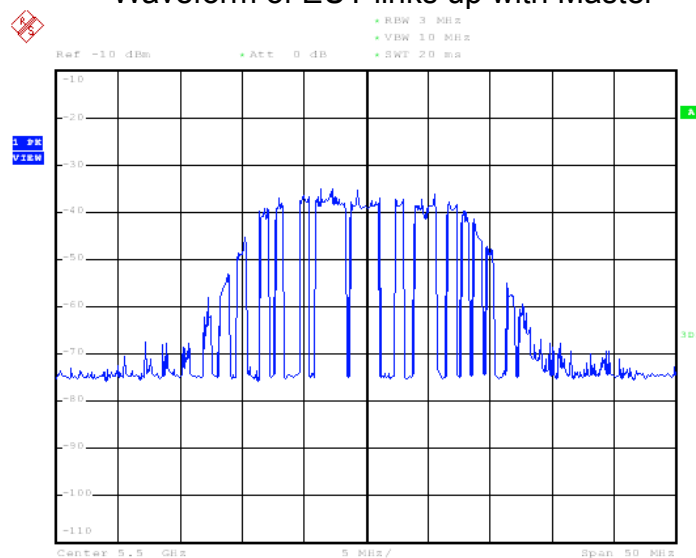

2) EUT plays test movie from Master.

Waveform of transmission

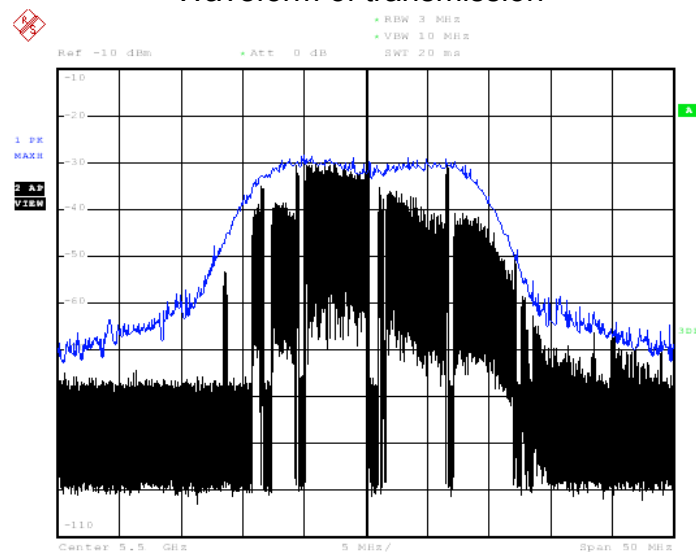

3) . Radar 1 is used for DFS testing

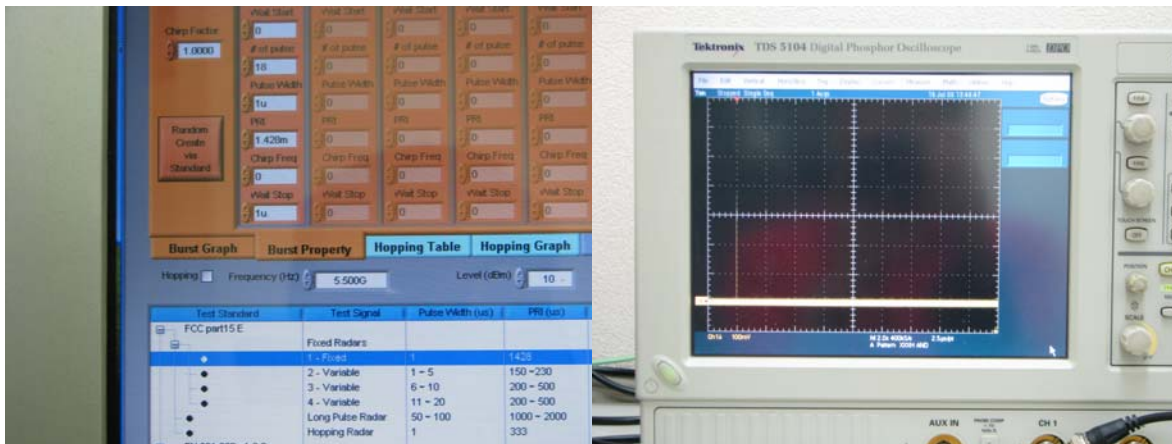

4) 5500MHz has been monitored in 30 minutes period. In this period, no any transmission occurs.

Plot of 30minutes period

802.11n 20MHz

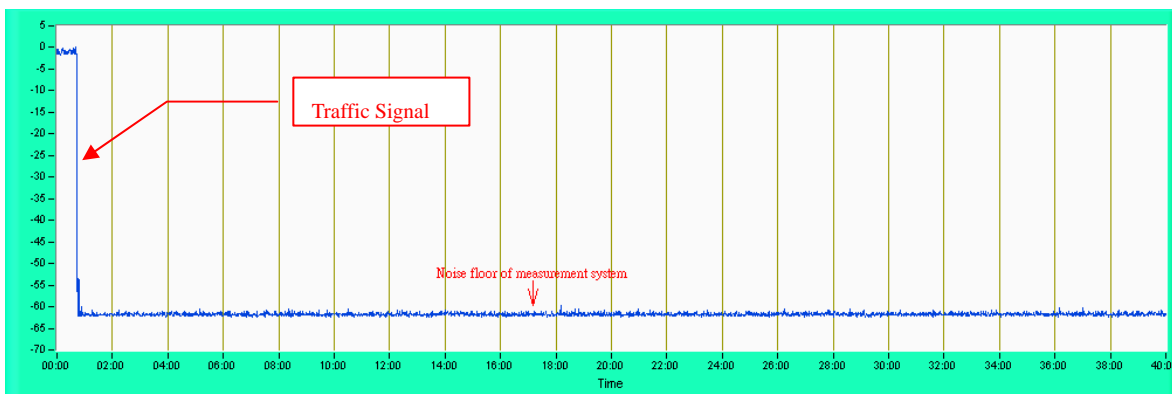

NOTE: Test setup are shown on TSup_FKGT7M.pdf



7. TESTING LABORATORIES INFORMATION

We, Bureau Veritas Consumer Products Services (H.K.) Ltd., Taoyuan Branch, were founded in 1988 to provide our best service in EMC, Radio, Telecom and Safety consultation. Our laboratories are accredited and approved according to ISO/IEC 17025.

Copies of accreditation certificates of our laboratories obtained from approval agencies can be downloaded from our web site:

www.adt.com.tw/index.5/phtml. If you have any comments, please feel free to contact us at the following:

Linko EMC/RF Lab:

Tel: 886-2-26052180

Fax: 886-2-26051924

Hsin Chu EMC/RF Lab:

Tel: 886-3-5935343

Fax: 886-3-5935342

Hwa Ya EMC/RF/Safety Telecom Lab:

Tel: 886-3-3183232

Fax: 886-3-3185050

Web Site: www.adt.com.tw

The address and road map of all our labs can be found in our web site also.



A D T

8. **APPENDIX A - MODIFICATIONS RECORDERS FOR ENGINEERING CHANGES TO THE EUT BY THE LAB**

No any modifications are made to the EUT by the lab during the test.

---END---