

VT9111/VT9115

900MHz CORDLESS TELEPHONE

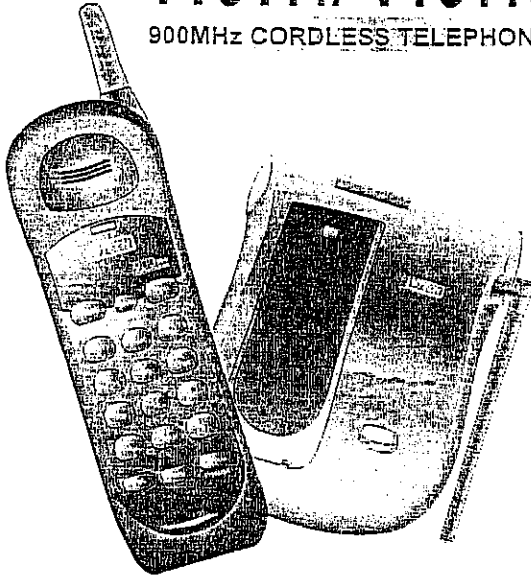

VTECH COMMUNICATIONS LTD.
PRINTED IN CHINA 91-5017-50-00

BEFORE USING YOUR NEW PHONE, WE STRONGLY RECOMMEND YOU READ THIS MANUAL THOROUGHLY.

INTRODUCTION

Parts Check List:

1. Handset
2. Base Unit
3. Telephone line cord
4. AC adapter
5. Battery Pack
6. Wall mount bracket



HANDBSET

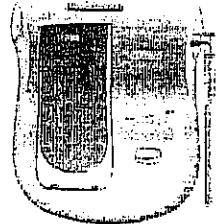

BASE UNIT

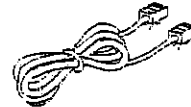

TELEPHONE LINE CORD



AC ADAPTER



BATTERY PACK



WALL MOUNT BRACKET

IMPORTANT SAFETY INSTRUCTIONS

When using your telephone equipment, basic safety precautions should always be followed to reduce the risk of fire, electric shock and injury to persons, including the following:

1. Read and understand all instructions.
2. Follow all warnings and instructions marked on the product.
3. Unplug this product from the wall outlet before cleaning. Do not use liquid cleaners or aerosol cleaners. Use a damp cloth for cleaning.
4. Do not use this product near water (for example, near a bath tub, kitchen sink, or swimming pool).
5. Do not place this product on an unstable cart, stand, or table. The product may fall, causing serious damage to the product.
6. Slots and openings in the cabinet and the back or bottom are provided for ventilation. To protect it from overheating, these openings must not be blocked by placing the product on the bed, sofa, rug, or other similar surface. This product should never be placed near or over a radiator or heat register. This product should not be placed in a built-in installation where proper ventilation is not provided.
7. This product should be operated only from the type of power source indicated on the marking label. If you are not sure of the type of power supply to your home, consult your dealer or local power company.
8. Do not allow anything to rest on the power cord. Do not locate this product where the cord will be abused by persons walking on it.
9. Never push objects of any kind into this product through cabinet slots as they may touch dangerous voltage points or short out parts that could result in a risk of fire or electric shock. Never spill liquid of any kind on the product.

10. To reduce the risk of electric shock, do not disassemble this product. If service or repair work is required, contact VTech Customer Service at 1-800-595-9511. Opening or removing cabinet parts other than specified access doors may expose you to dangerous voltages or other risks. Incorrect reassembling can cause electric shock when the appliance is subsequently used.
11. Do not overload wall outlets and extension cords as this can result in the risk of fire or electric shock.
12. Unplug this product from the wall outlet:
 - a) When the power supply cord or plug is damaged or frayed.
 - b) If liquid has been spilled into the product.
 - c) If the product has been exposed to rain or water.
 - d) If the product does not operate normally by following the operating instructions. Adjust only those controls that are covered by the operating instructions because improper adjustment of other controls may result in damage and will often require extensive work to restore the product to normal operation.
 - e) If the product has been dropped and the cabinet has been damaged.
 - f) If the product exhibits a distinct change in performance.
13. Avoid using a telephone (other than a cordless type) during an electrical storm. There may be a remote risk of electric shock from lightning.
14. Do not use the telephone to report a gas leak in the vicinity of the leak.

SAVE THESE INSTRUCTIONS

2

REPLACING THE HANDBSET BATTERIES



The RBRC™ Seal
The RBRC™ Seal on the nickel-cadmium battery indicates that VTech Communications, Inc. is voluntarily participating in an industry program to collect and recycle these batteries at the end of their useful lives, when taken out of service within the United States and Canada.

The RBRC™ program provides a convenient alternative to placing used nickel-cadmium batteries into the trash or municipal waste, which may be illegal in your area.

VTech's participation with RBRC™ makes it easy for you to drop off the spent battery at local retailers participating in the RBRC™ program or at authorized VTech product service centers. Please call 1-800-8-BATTERY™ for information on Ni-Cd battery recycling and disposal bans / restrictions in your area. VTech's involvement in this program is part of its commitment to protecting our environment and conserving natural resources.

RBRC™ is a registered trademark of Rechargeable Battery Recycling Corporation.

1. Remove the battery cover by pressing on the ridged lines and sliding downward.
2. Remove the old battery pack. Don't put the old battery pack in a trash compactor or a fire - it could burst.
3. Place the new battery pack in the battery compartment. Make sure the metal contacts on the underside of the battery are aligned with charging contacts in battery compartment.
4. Replace the battery cover by sliding it into place.

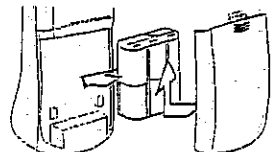
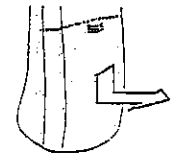

5. The new battery pack must be charged before using your telephone. Place the handset in cradle of the base unit to allow it to charge 24 hours. Maximum battery life below charges is more than 7 hours of continuous talk time or 6 days of standby.

CAUTION: To reduce the risk of fire or injury, read and follow these instructions.

1. Use only VTECH battery.
2. Do not open or mutilate the battery. Release electrolyte is corrosive and may cause damage to the eyes or skin. It may be toxic if swallowed.
3. Exercise care in handling batteries in order to short the battery with conducting material such as rings, bracelets, and keys. The ball or conductor may overheat and cause burn.
4. Do not dispose of the battery in a fire. The battery may explode.

3

GETTING STARTED

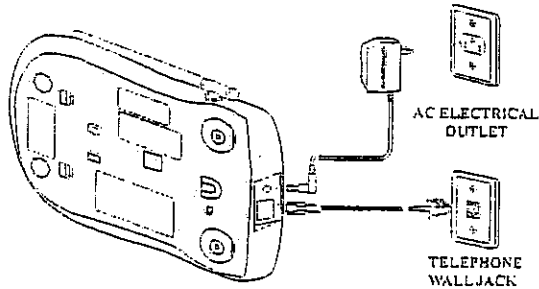

Setting Up Your VT 9111/VT 9115

1. Choose an area near an electrical outlet and a telephone wall jack.

2. Plug the AC power adapter into an electrical outlet and the DC connector to the back of the base unit.

CAUTION: Use only the AC adapter shipped with your VT 9111/VT 9115. It is specifically designed for this product.

NOTE: Connect power to the base unit before placing the handset in the cradle.

3. **CHARGE THE HANDSET BATTERY PACK BEFORE USE.** The batteries recharge automatically whenever the handset is in the base unit cradle. The batteries must be charged for 24 hours before using your phone for the first time.

4. Connect the telephone line cord, insert one end of the telephone line cord into the jack at the rear of the base unit. Plug the other end into a telephone wall jack. Make sure the plugs snap securely into place.

5. **CHECK FOR A DIAL TONE.** After the batteries are charged, pick up the handset and press the PHONE key. The IN USE indicator should light up, and you should hear a dial tone. If not, see IN CASE OF DIFFICULTY.

CAUTION:

- Never install telephone wiring during a lightning storm.
- Never install telephone jacks in wet locations unless the jack is specifically designed for wet locations.
- Never touch uninsulated telephone wires or terminals unless the telephone line has been disconnected at the network interface.
- Use caution when installing or modifying telephone lines.

4

WALL MOUNTING

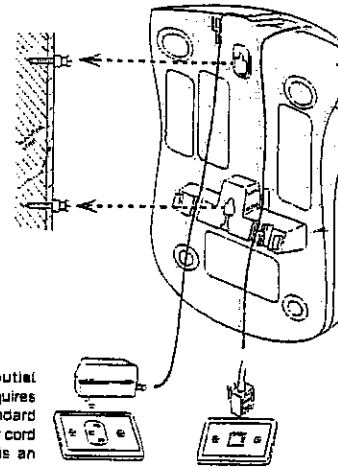

1. Choose a spot near an electrical outlet and a telephone jack. Your phone requires a modular telephone jack and a standard electrical outlet (120V AC). The power cord is six feet long; make sure there is an electrical outlet within reach of the base. The outlet should not be controlled by a wall switch. If the switch is ever turned off, the phone will not operate.

2. Position the wall mount adapter on the base. Line up the tabs on the wall mount adapter with the holes on the bottom of the base. Snap the wall mount adapter firmly in place.

3. Mount the base on the wall. Position the base so the mounting studs will fit into the holes on the bottom of the base. Position the power cord to extend down the wall the phone is to be mounted on. Slide the base down on the mounting studs until it locks into place.

4. Connect the telephone cord. The telephone line cord has a snap-in at each end. Insert one of the plugs into the jack on the bottom of the base. Insert the other end of the plug into the jack.

5. Connect the power cord. Plug the connector into the DC jack at the rear of the base unit. Plug the AC power cord into an electrical outlet.

5

HANDSET FEATURES

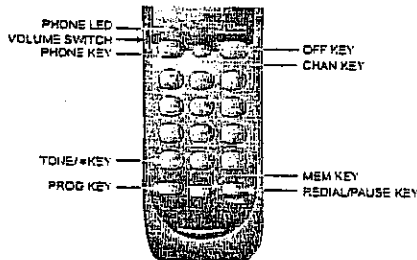

PHONE LED

- The PHONE LED lights when the handset is on an active call.
- It flashes in cadence with an incoming ring.
- It flashes quickly during PROG mode.
- It flashes slowly when battery is low.

PHONE KEY/FLASH KEY

- Press the PHONE key to make a call.
- If you are currently on a call, pressing PHONE flashes the line. This would be used with a feature like call waiting to answer your second call.

CHAN KEY

- Pressing the CHAN key when the handset is in use will activate a channel change to the next free channel.
- This is used if you are experiencing noise or interference on the current channel.

OFF KEY

- Press the OFF key to exit all modes of operation.

MEM KEY

- Press the MEM key to enter MEMORY mode.
- The sequence for dialing out a speed dial number in memory is: PHONE, MEM, Number Button (0-9).

PROG KEY

- Press PROG key to enter PROGRAM mode. See Programming Speed Dial Numbers for more details.

REDIAL / PAUSE KEY

- When you hear the dial tone, pressing the REDIAL key will dial out the last number that was called on your phone.
- It can also be used to store the last number dialed into the speed dial memory. See Storing a Redial Number into Speed Dial for details.

TONE/* KEY

- In PULSE dialing mode, this key is used to switch to Temporary TONE dialing mode.

VOLUME SWITCH

- 3 levels of volume intensity ()
- Upper position of switch is high volume level.
- Middle position is medium.
- Lower position is low.

BATTERY LOW WARNING BEEP

- The handset will make two beeps when the handset battery is getting low and needs to be recharged.

6

BASE UNIT FEATURES

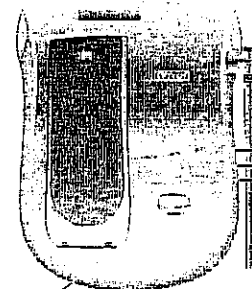

PAGE KEY

- Press the PAGE key to page the handset.
- Press it a second time to cancel a page.
- The base will ring the handset 4 times before ending the page automatically.
- The handset can also cancel the page by pressing the OFF key.

CHARGING LED

- The CHARGING LED illuminates when the handset is in the base cradle.
- The CHARGING LED indicates that the handset battery is being charged.

IN USE LED

- Immediately after placing the handset in base cradle, the IN USE LED flashes to indicate that the initialization (assigning a security code and channel) is in progress.
- The IN USE LED will stop flashing and off when the initialization is complete.
- The IN USE LED illuminates whenever handset is being used.
- This LED also flashes with the cadence of the incoming ring.

POWER LED

- The POWER LED illuminates when the power adapter is plugged in and power applied to the base unit.

7

REPLACEMENT BATTERY ORDER FORM

For VT 9111/9115 Cordless Telephone

Name: _____ Address: _____

City: _____ State: _____ Zip: _____

Daytime Phone Number: (_____) _____

ORDER INFORMATION

For Model VT 9111/VT 9115

(Qty.) Batteries @ \$19.95 each _____ \$ _____

Shipping/Handling @ \$4.95 per battery _____ \$ _____

METHOD OF PAYMENT; DO NOT SEND CASH

CHECK/M.O. VISA MASTERCARD DISCOVER AMERICAN EXPRESS

Credit Card: _____ EXP. DATE: _____

CARD HOLDER'S SIGNATURE: _____

PLACE ORDER FORM AND PAYMENT IN ENVELOPE AND SEND TO:

VTECH COMMUNICATIONS

8770 SW NIMBUS AVENUE

BEAVERTON, OREGON 97006-7195 USA

YOU MAY ALSO ORDER BY PHONE CALL 1-800-943-8311

OPERATING INSTRUCTIONS

Making Calls

Pick up the handset and press PHONE. When you hear a dial tone, dial the number. The PHONE LED will illuminate while the handset is in use.

If you make a mistake when dialing, press OFF to hang up, then press PHONE to get the dial tone again.

You must always press PHONE before you can dial a call on the handset.

Answering Calls

When an incoming call is ringing, the IN USE LED on the base and PHONE LED on the handset will flash. To make sure your phone rings when the handset is away from the base, please keep the base antenna in the upright position.

To answer a call when the handset is in the base, just pick up the handset.

To answer a call when the handset is away from the base, just press any key on the handset (except OFF). This is very useful in a dark environment; you do not have to fumble around looking for the PHONE key to answer the call.

Disconnecting

To end a call, either place the handset back in the base, or press OFF on the handset.

Changing Channels

If you notice interference when using your handset, press CHAN to switch to a clear channel. This function is only available when you are on a call.

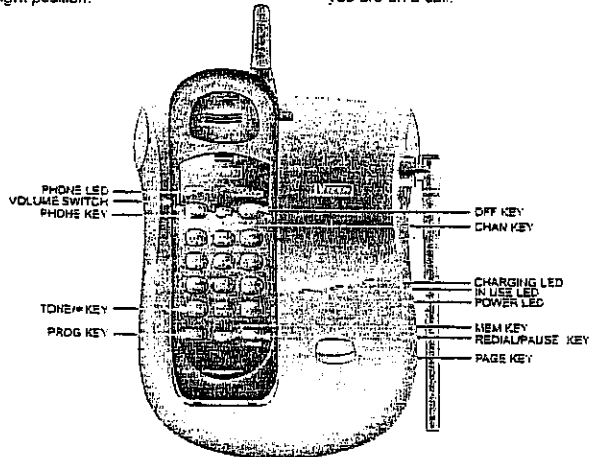

8

OPERATING INSTRUCTIONS

TONE/PULSE Setting

If you have touch tone service on phone line. Press PROG * * MEM to switch to TONE dialing. If you have rotary service, press PROG * * #MEM to switch to PULSE. NOTE: Your VT9111/VT9115 is preset at the factory for TONE dialing.

Temporary Tone

If you have a rotary (dial-pulse) telephone service, (TONE/PULSE setting is set to PULSE), this feature allows you to enter special codes and tones to operate answering machines, use electronic banking services, calling cards, or other special services.

First, dial the call normally. Then activate the Temporary Tone feature by pressing TONE (the # key). You can then press the numbers or symbols you need, and your phone will send the proper signals.

To end the call, press OFF or place the handset back in the base. The phone will automatically go back to rotary (dial-pulse) service.

Programming The Ringer Type

The handset ringer is capable of four different types of ringing tones. The following sections detail how to change the different tones and to turn off a ringer on the handset.

To program, the handset must be OFF. To select a different ringer type do the following:

- * Press PROG
- * Press the # key;
- * Press a key 1..4 to select a ringer type.
- * Press the MEM key to confirm.

Turning Off The Ringer

To turn off the ringer on the handset, do the following:

- * Press PROG

- * Press the # key
- * Press 5 to turn off the ringer
- * Press the MEM key to confirm
- * To turn the ringer on again, : Programming the Ringer Type.

Checking The Ringer

To check the ringer which is currently programmed, do the following:

- * Press PROG
- * Press the # key
- * Press 0
- * Press the MEM key to confirm

Memory Dialing

The VT 9111/VT 9115 can store up to different phone numbers that you can just by pressing phone, MEM and one of number keys (0-9).

Programming Speed Dial Numbers

The handset must be OFF.

1. Press PROG. The PHONE LED will be lit to indicate that you are in programming mode.
2. Press the number of the memory local you wish to store the number in (0-9)
3. Using the dial pad, dial the number you want to store. The number can be up to 16 digits long. The number can be entered manually or by using REDIAL
4. Press MEM to store the phone number the key you selected.

The phone now exits PROG mode and rings a tone.

Speed Number Dialing

1. Press PHONE to get a dial tone.
2. Press MEM and the memory local number key (0-9).

For example, to dial the number assigned to key '8', you would press PHONE MEM, 8.

OPERATING INSTRUCTIONS

To Change or Replace a Speed Dial Number

To change or replace a stored number in speed dial memory simply enter the new number and store it in the memory location you wish to change.

For example, to change the number stored in memory position 7 to 555-1111, you would press PROG, 7, 555-1111, MEM.

Storing Pauses in Memory

To insert a pause in a phone number, press and hold the number before the position where the pause is to be inserted. Hold the number key down until it beeps twice. The pause is 2 seconds in length. For longer pauses, press and hold the key until it beeps three or four times. Each additional beep indicates an additional 2 second pause.

If your phone is connected to a PBX you can store the PBX access number and a pause before the phone number. For example, to store 9-PAUSE-555-1234 in memory location 6 do the following:

1. Press PROG
2. Press 8
3. Press 9
4. Press REDIAL / PAUSE
4. Dial 555-1234
5. Press MEM

Using REDIAL

To REDIAL the last number you called, press PHONE then press REDIAL. The phone will automatically dial the number.

Storing a Redial Number into Speed Dial
To store the last number you dialed as a regular Speed Dial number, press PROG, a number key (0-9), REDIAL, MEM.

The Page Feature

From the base unit, press PAGE to signal the person at the handset. To end the page at the base, press PAGE again. To end the page at the handset, press OFF.

This feature is also useful if you have misplaced the handset.

10

IN CASE OF DIFFICULTY

If you have difficulty operating your phone, the suggestions below should solve the problem. If you still have difficulty after trying these suggestions.

In the US Call:

VTECH Communications at
1-800-595-9511.

In Canada Call:

VTECH Electronics at
1-800-267-7377.

THE PHONE DOESN'T WORK AT ALL.

- * Make sure the power cord is plugged in.
- * Make sure the telephone line cord is plugged firmly into the base unit and the telephone wall jack.
- * Make sure the batteries are properly charged. If the handset makes two beeps, the batteries need charging. If the IN USE indicators do not light when you press PHONE, you must charge the batteries.
- * If you recently installed a new battery pack, make sure it is installed correctly.

NO DIAL TONE.

- * First check all the suggestions above.
- * If you still don't hear a dial tone, disconnect the base unit from the telephone jack and connect a different phone. If there is no dial tone on that phone either, the problem is in your wiring or local service. Call your local telephone company.

YOU GET NOISE, STATIC, OR A WEAK SIGNAL EVEN WHEN YOU'RE NEAR THE BASE UNIT.
Household appliances plugged into the same circuit as the base unit can sometimes cause interference. Try moving the appliance or the base unit to another outlet.

YOU GET NOISE, STATIC, OR A WEAK SIGNAL WHEN YOU'RE AWAY FROM THE BASE UNIT.

- * You may be out of range. Either move closer to the base, or relocate the base unit.
- * The layout of your home may be limiting the range. Try moving the base unit to the second or third floor, or to some other location.

THE HANDSET DOES NOT RING WHEN YOU RECEIVE A CALL.

- * Ensure that the ringer is turned on.
- * Make sure the telephone line cord is plugged

- firmly into the base unit and the telephone line cord is plugged in.
- * You may be too far from the base unit.
- * You may have too many extension phones your telephone line to allow all of them to ring. Try unplugging some of the other phones.

YOUR CALLER FADES IN AND OUT.
You may be nearly out of range. Move closer or relocate the base.

YOU HEAR OTHER CALLS WHILE USING YOUR PHONE.

- * Replace the handset in the base cradle, wait a few moments and try again.
- * Disconnect your base unit from the telephone jack, and plug in a regular telephone. If you hear other calls, the problem is probably in your wiring or local service. Call your local telephone company.

YOU HEAR NOISE IN THE HANDSET. A NONE OF THE KEYS OR BUTTONS WORK.

- * Make sure the power cord is plugged in.
- * Your base unit and handset may not be operating on the same channel or security code. Place the handset in the cradle for a moment to reload the security code and reselect the channel.

COMMON CURE FOR ELECTRONIC EQUIPMENT

Electronics, like people, can sometimes be confused. If the unit does not seem to be responding normally, then try pulling the handset out of the cradle to re-initialize the unit. If it still will not seem to respond, perform the following steps (in the order listed):

1. Disconnect the power to the base.
2. Disconnect (remove) the handset battery.
3. Remove the base unit battery pack, when applicable.
4. Wait a few minutes.
5. Connect power to the base.
6. Install the handset battery.
7. Install the base unit battery pack, when applicable.
8. Place the handset in the base unit cradle. The handset has not been recently charged; allow 8 hours before use.

11

WARRANTY STATEMENT

WHAT DOES OUR WARRANTY COVER?

- Any defect in material or workmanship.

FOR HOW LONG AFTER THE ORIGINAL PURCHASE?

- One Year.

WHAT WILL VTECH DO?

- At our option, repair or replace your unit.

HOW DO I SEND MY UNIT, IN OR OUT OF WARRANTY?

- Call VTECH Electronics customer service for Return Authorization at: 1-800-595-8511
- Properly pack your unit. Include any cables & accessories which were originally provided with the product. We recommend using the original carton and packing materials.
- Include in the package a copy of the sales receipt or other evidence of date of original purchase (if the unit was purchased within the last twelve months.)
- Print your name and address, along with a description of the defect, and include this in the package.
- Include payment for any service or repair not covered by the warranty, as determined by VTECH Communications.
- In the US, ship the unit via UPS Insured, or equivalent to:
VTECH COMMUNICATIONS
11035 SW 11th Street
Bldg. B Suite 270
Beaverton, OR 97005

VTECH Communications assumes no responsibility for units sent without prior Return Authorization.

WHAT DOES OUR WARRANTY NOT COVER?

- Batteries
- Damage from misuse, neglect, or acts of nature (lightning, floods, power surges, etc.)
- Products which may have been modified or incorporated into other products
- Products purchased outside the USA
- Products serviced by the owner or a service facility not expressly authorized by VTECH Communications
- Products purchased more than 12 months from current date

HOW DOES STATE LAW RELATE TO THIS WARRANTY?

- This warranty gives you specific rights. You may also have other rights which vary from state to state.

IF YOU PURCHASED YOUR TELEPHONE IN CANADA

Please call: 1-800-267-7377 for return authorization.

Ship to: VTECH ELECTRONICS
200-7671 ALDERBRIDGE WAY
RICHMOND, BC V6X 1Z9 12

FCC AND IC REGULATIONS

FCC AND IC REGULATIONS

This equipment complies with Parts 15 and 68 of the Federal Communications Commission (FCC) rules for the United States. It also complies with regulations RSS-210 and CS-03 of Industry Canada (IC).

A label is located on the underside of the base unit containing either the FCC registration number and Ringer Equivalence Number (REN) or the IC registration number and Load Number. You must, upon request, provide this information to your local telephone company.

This equipment is compatible with inductively coupled hearing aids.

FCC Part 15

Warning: Changes or modifications to this unit not expressly approved by the party responsible for compliance could void the user's authority to operate the equipment.

The equipment has been tested and found to comply with part 15 of the FCC rules. These limits are designed to provide reasonable protection against harmful interference in a residential installation. This equipment generates, uses and can radiate radio frequency energy and, if not installed and used in accordance with the instructions, may cause harmful interference to radio communications. However, there is no guarantee that interference will not occur in a particular installation. If this equipment does cause harmful interference to radio or television reception, which can be determined by turning the equipment off and

on, the user is encouraged to try and correct the interference by one or more of the following measures:

- Reorient or relocate the receiving antenna.
- Increase the separation between the equipment and receiver.
- Connect the equipment into an outlet on a circuit different from that to which the receiver is connected.
- Consult the dealer or an experienced radio/TV technician for help.

FCC Part 68

The FCC requires that you connect your cordless telephone to the nationwide telephone network through a modular telephone jack (USOC RJ11C or RJ11W).

Your telephone company may discontinue your service if your equipment causes harm to the telephone network. They will notify you in advance of disconnection, if possible. During notification, you will be informed of your right to file a complaint with the FCC.

If it is determined that your telephone equipment is malfunctioning, the FCC requires that it not be used and that it be unplugged from the modular jack until the problem has been corrected. Repairs to this telephone equipment can only be made by the manufacturer or its authorized agents or by others who may be authorized by the FCC. For repair procedures, follow the instructions outlined under the VTECH Limited Warranty.

The REN is useful in determining the number of devices you may connect to your telephone line and still enable the devices to ring when you receive a call. The general rule is that

MAINTENANCE

TAKING CARE OF YOUR TELEPHONE.

Your VT 9111/VT 9115 cordless telephone contains sophisticated electronic parts so it must be treated with care.

Avoid rough treatment

Place the handset down gently. Save the original packing materials to protect your telephone if you ever need to ship it.

Avoid Water

Your telephone can be damaged if it gets wet. Do not use the handset outdoors in the rain, or handle it with wet hands. Do not install your base unit near a sink, bathtub or shower.

Remember that electrical appliances can cause serious injury if used when you are wet or standing in water. If your base unit should fall into water, **DO NOT RETRIEVE IT UNTIL YOU UNPLUG THE POWER CORD AND TELEPHONE LINE CORDS FROM THE WALL.** Then pull the unit out by the unplugged cords.

Electrical Storms

Electrical storms can sometimes cause power surges harmful to electronic equipment.

For your own safety, use caution when using electric appliances during storms.

Cleaning your telephone

Your telephone has a durable plastic casing that should retain its luster for many years. Clean it only with a soft cloth slightly dampened with water or a mild soap. Do not use excess water or cleaning solvents of any kind.

TECHNICAL SPECIFICATIONS

FREQUENCY CONTROL

Crystal Controlled Dual PLL Synthesizer

TRANSMIT FREQUENCY

Handset: 923.10 MHz to 927.75 MHz
Base: 902.3 MHz to 906.65 MHz

RECEIVE FREQUENCY

Handset: 902.3 MHz to 906.65 MHz
Base: 923.10 MHz to 927.75 MHz

NOMINAL EFFECTIVE RANGE

Maximum power allowed by FCC and Actual operating range may vary according to environmental conditions at the time of use.

SIZE

Handset: 17.5cm x 5.5cm x 3.9cm (L x W x T) maximum (antenna excluded)
Base: 19.3cm x 14.8cm x 5.4cm (L x W x T) maximum (antenna excluded)

WEIGHT

Handset: 146 grams
Base: 283 grams

POWER REQUIREMENTS

Handset: Self-contained nickel cadmium recharge battery supply, 3 nominal, 400mAh capacity
Power Adapter: 9V DC @ 300mA

SPECIFICATIONS ARE TYPICAL, MAY CHANGE WITHOUT NOTICE.

13

FCC AND IC REGULATIONS

the REN value should not exceed 5.0 total; however, contact your local telephone company for the specific number in your area.

IC (Industry Canada)

This telephone is registered for use in Canada.

Notice: The Industry Canada label identifies certified equipment. This certification means that the equipment meets certain telecommunications network, protective, operational and safety requirements. Industry Canada does not guarantee the equipment will operate to the user's satisfaction.

Before installing this equipment, users should ensure that it is permissible to be connected to the facilities of the local telecommunications company. The equipment must also be installed using an acceptable method of connections. The customer should be aware that compliance with the above conditions may not prevent degradation of service in situations.

Repairs to certified equipment should be made by an authorized Canadian maintenance facility designated by the supplier. Any repairs or alterations made by the user to this equipment, or equipment malfunctions, may give the telecommunications company cause to request the user to disconnect the equipment.

Users should ensure for their protection that the electrical power connections of the power utility, telephone lines and internal metallic water system, if present, are connected together. This precaution may be particularly important in rural areas.

Caution: Users should not attempt to make such connections themselves but should contact appropriate electric inspection authority or electrician, as appropriate.

The Load Number (LN) assigned to a device denotes the percentage of the load to be connected to a telephone line which is used by the device to prevent overloading. The termination on a loop consist of any combination of devices subject only to the requirement that total of the load numbers of all devices does not exceed 100.

This device complies with RSS-211 Industry Canada. Operation is subject to the following two conditions: (1) this device may not cause interference, and (2) this device must accept any interference including interference that may cause undesired operation of the device.

14

15