

Figure 1. Audio Circuit in Base Unit

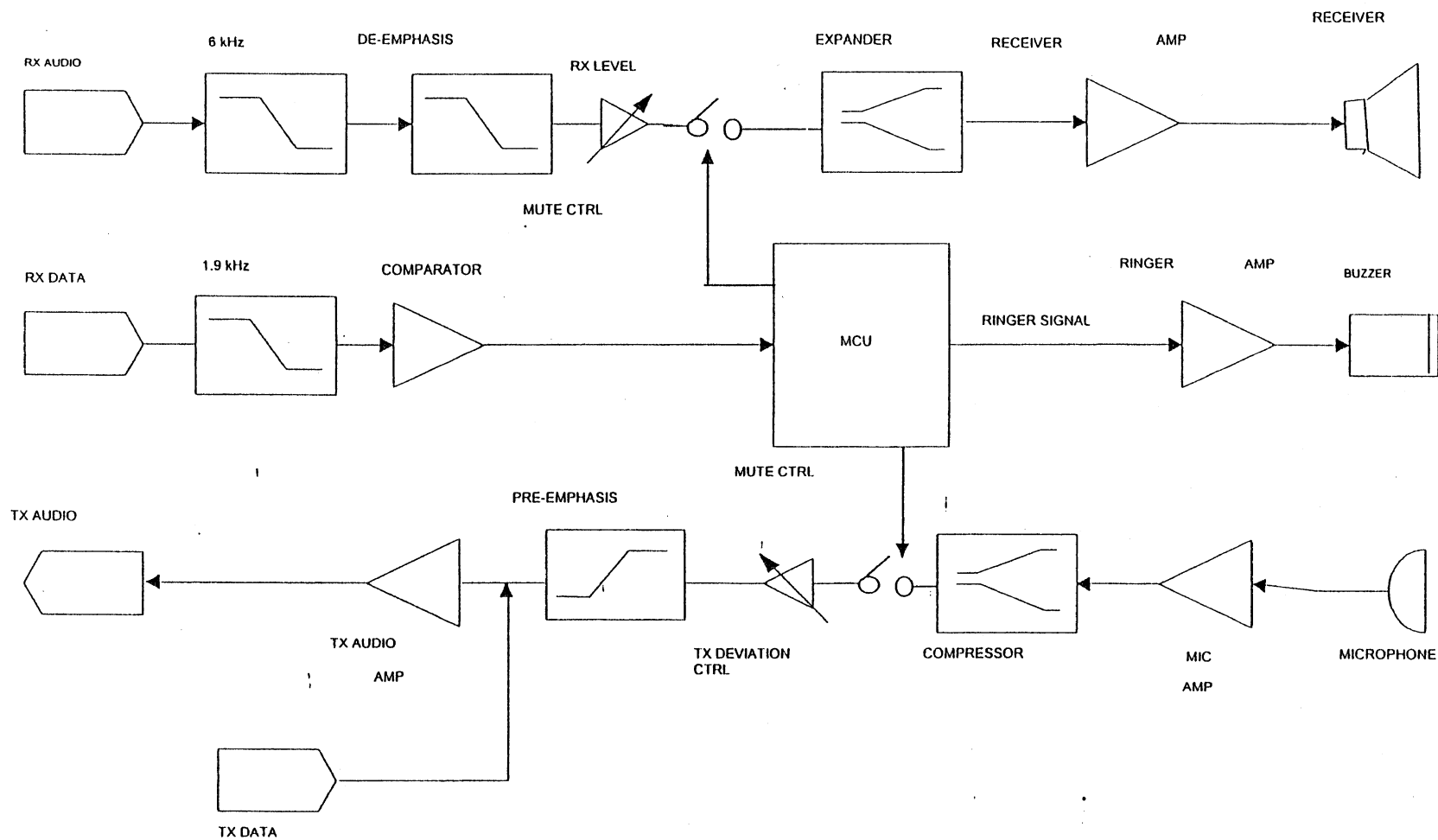
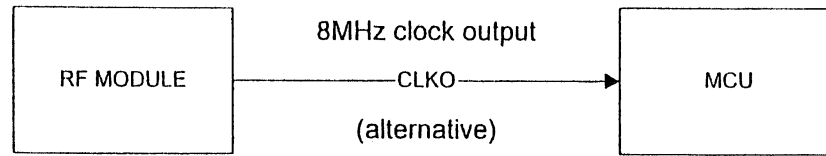

Figure 2. Audio Circuit in Handset Unit

# The supplement for figure 3. RF Module Block Diagram

Point A



Used in the Base only.

Point B

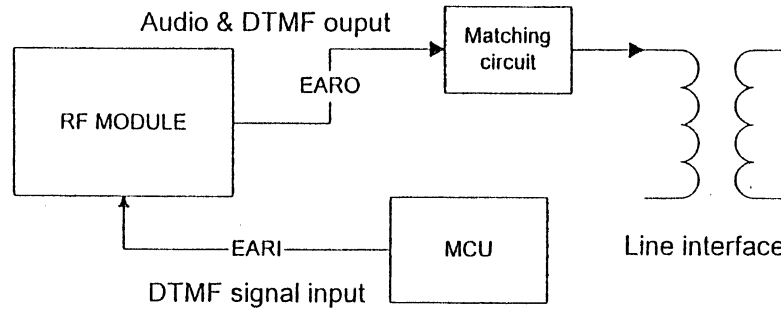

In Base Unit

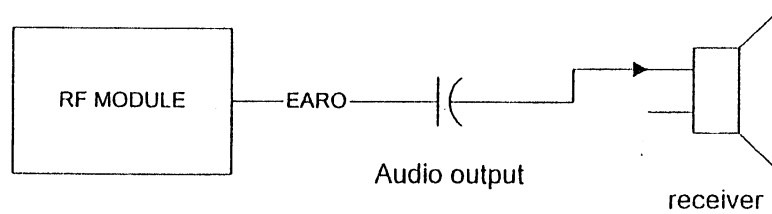

In Handset Unit

Point C

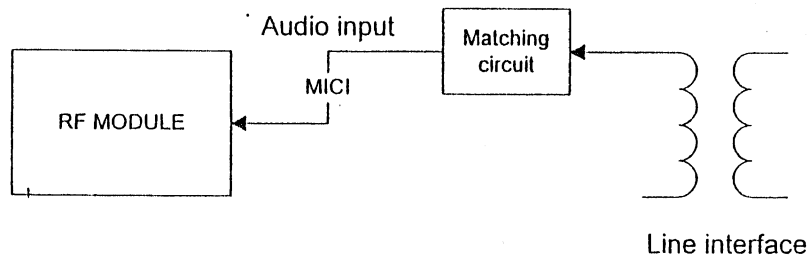

In Base Unit

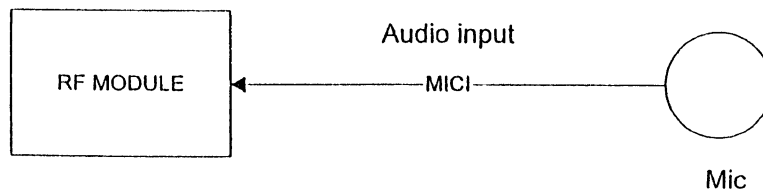

In Handset Unit



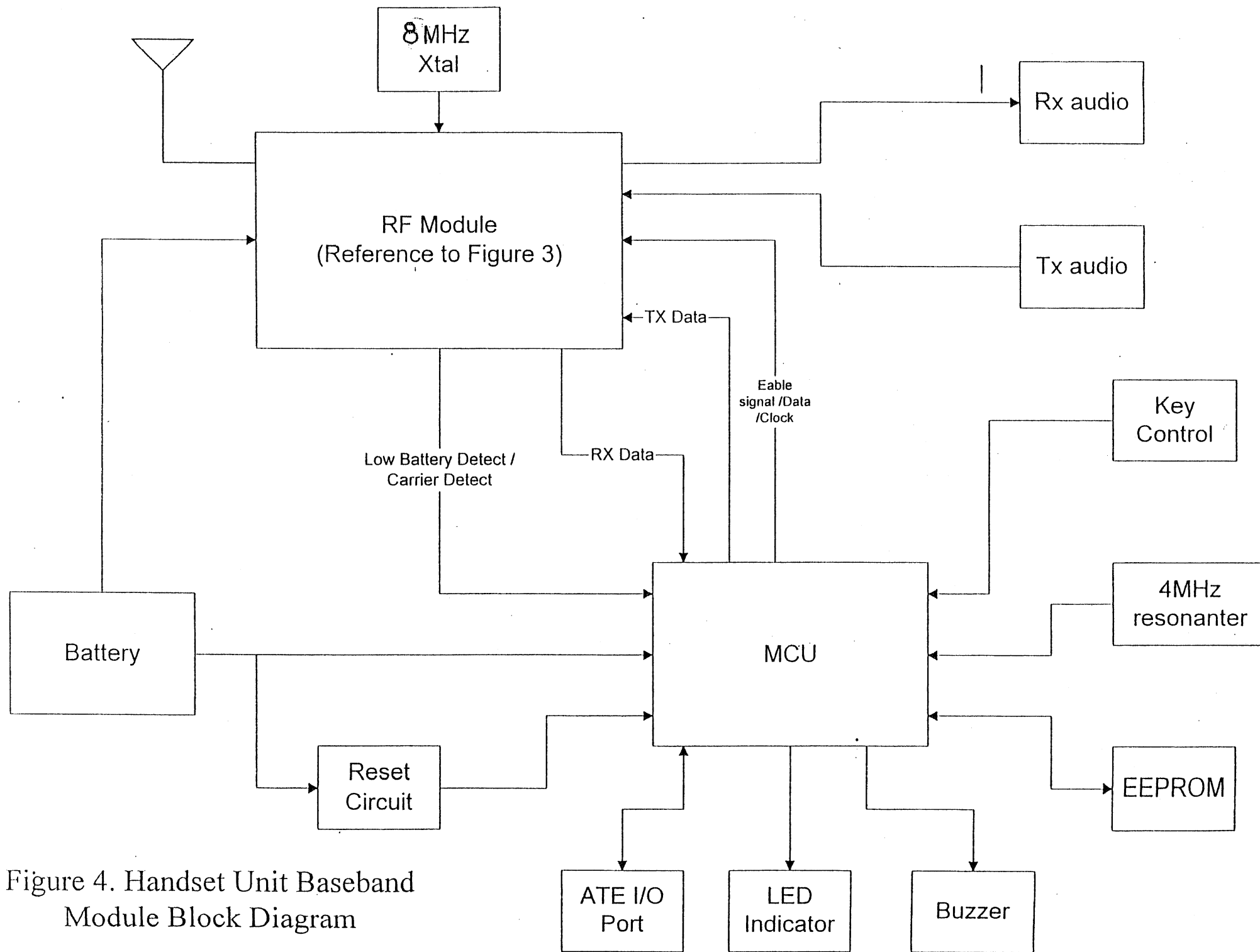

Figure 4. Handset Unit Baseband Module Block Diagram

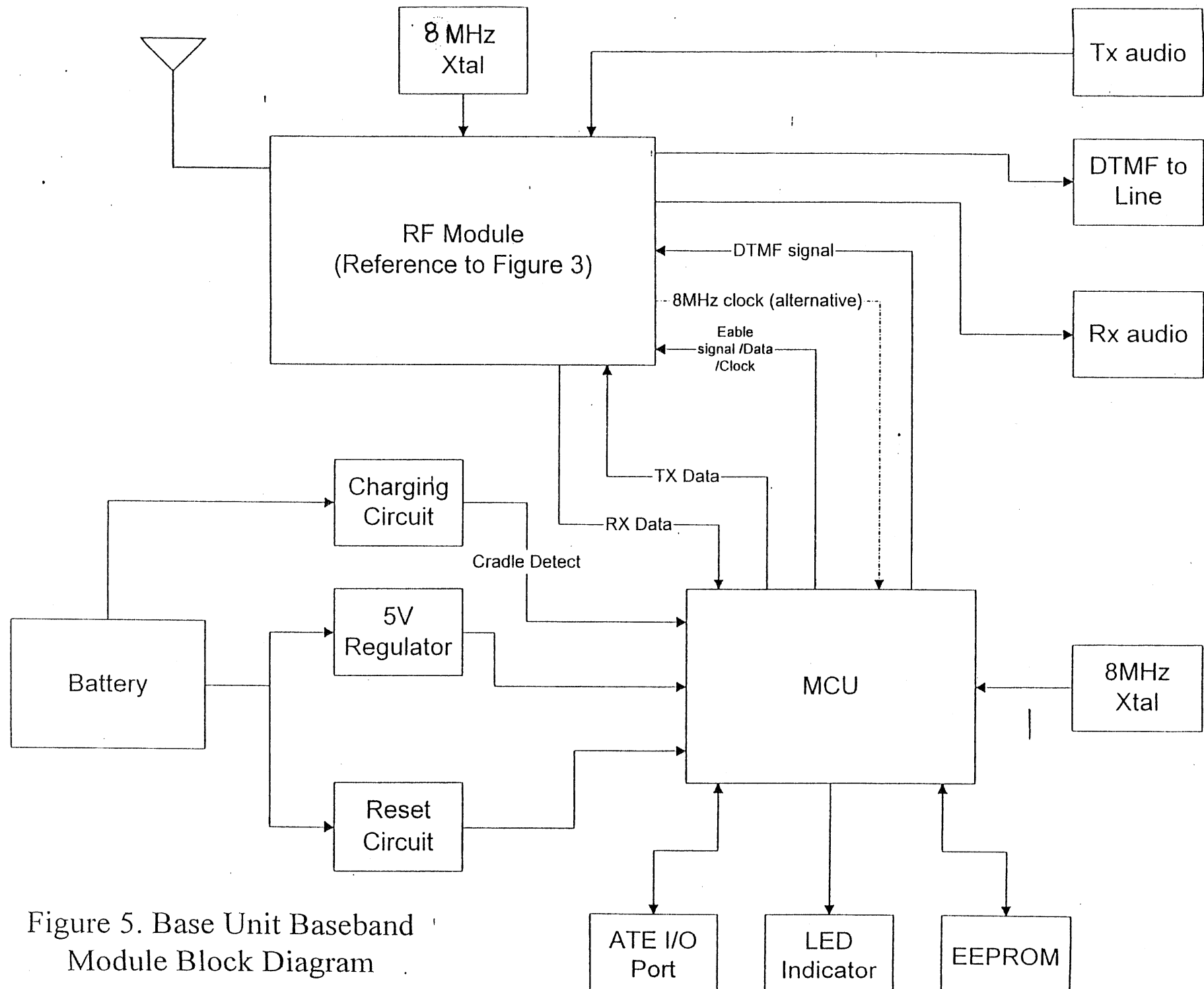

Figure 5. Base Unit Baseband Module Block Diagram