

## TEST REPORT

**Report No.: 24081166HKG-004R1**

VTech Telecommunications Ltd.

Application For Original Grant of 47 CFR Part 15 Certification

New Family of RSS-210 Issue 11 Certification

Thermostat Controller

**FCC ID: EW780-T118-01**

**IC: 1135B-80T11801**

This report contains the data of BLE portion only

This report supersedes previous report with report number 24081166HKG-004 dated March 03, 2025

**Prepared and Checked by:**

**Approved by:**

Signed on File

Leung Chun Ning, Peter  
Engineer

Wong Cheuk Ho, Herbert  
Assistant Manager  
Date: June 04, 2025

Intertek's standard Terms and Conditions can be obtained at our website <http://www.intertek.com/terms/>.

The test report only allows to be revised within the retention period unless further standard or the requirement was noticed.

This report is for the exclusive use of Intertek's Client and is provided pursuant to the agreement between Intertek and its Client. Intertek's responsibility and liability are limited to the terms and conditions of the agreement. Intertek assumes no liability to any party, other than to the Client in accordance with the agreement, for any loss, expense or damage occasioned by the use of this report. Only the Client is authorized to permit copying or distribution of this report and then only in its entirety. Any use of the Intertek name or one of its marks for the sale or advertisement of the tested material, product or service must first be approved in writing by Intertek. The observations and test results in this report are relevant only to the sample tested. This report by itself does not imply that the material, product, or service is or has ever been under an Intertek certification program.

© 2017 Intertek

## TEST REPORT

### GENERAL INFORMATION

<b>Grantee:</b>	VTech Telecommunications Ltd.
<b>Grantee Address:</b>	23/F., Tai Ping Industrial Centre, Block 1, 57 Ting Kok Road, Tai Po, Hong Kong.
<b>Manufacturer:</b>	VTech (Dongguan) Telecommunications Limited
<b>Manufacturer Address:</b>	VTech Science Park, Xia Ling Bei Management Zone, Liaobu, Dongguan, Guangdong, China.
<b>FCC Specification Standard:</b>	FCC Part 15, October 1, 2023 Edition
<b>FCC ID:</b>	EW780-T118-01
<b>FCC Model(s):</b>	W992WZ82, SW992WZ50, SW991WZ50
<b>IC Specification Standard:</b>	RSS-210 Issue 11, June 2024 RSS-Gen Issue 5 Amendment 2, February 2021
<b>IC:</b>	1135B-80T11801
<b>HVIN:</b>	35-400574C
<b>PMN:</b>	W992WZ82, SW992WZ50, SW991WZ50
<b>Type of EUT:</b>	Transceiver
<b>Description of EUT:</b>	Thermostat Controller
<b>Brand Name:</b>	VTech, Seasons
<b>Sample Receipt Date:</b>	February 12, 2025
<b>Date of Test:</b>	February 12, 2025 to February 24, 2025
<b>Report Date:</b>	March 03, 2025
<b>Environmental Conditions:</b>	Temperature: +10 to 40°C Relative Humidity: 10 to 90%
<b>Conclusion:</b>	Test was conducted by client submitted sample. The submitted sample as received complied with the 47 CFR Part 15 / RSS-210 Issue 11 Certification.  This report contains the data of BLE portion only

### AMENDMENT HISTORY

Report No.	Issue Date	Content
24081166HKG-004	March 03, 2025	Original Report
24081166HKG-004R1	June 04, 2025	Revised Model Differences

**TEST REPORT**

**SUMMARY OF TEST RESULT**

Test Items	FCC Part 15 Section	RSS-210 / RSS-Gen <sup>#</sup>	Results
Transmitter Power Line Conducted Emissions	15.207	8.8 <sup>#</sup>	Complied
Radiated Emission	15.249, 15.209	B.10 / 8.9 <sup>#</sup>	Complied
Radiated Emission on the Bandedge			Complied
Radiated Emission in Restricted Bands	15.205	8.10 <sup>#</sup>	Complied

For all technical data can be referred to Annex B – Report cover sheet.  
For electronic filing, the Annex B – Report cover sheet is saved with filename: Annex B.pdf.

The equipment under test is found to be complying with the following standards:

- FCC Part 15, October 1, 2023 Edition
- RSS-210 Issue 11, June 2024
- RSS-Gen Issue 5 Amendment 2, February 2021

Note: 1. The EUT uses a permanently attached antenna which, in accordance to section 15.203, is considered sufficient to comply with the pervisions of this section.  
2. Pursuant to FCC Part 15 Section 15.215(c), the 20dB bandwidth of the emission was contained within the frequency band designated (mentioned as above) which the EUT operated. The effects, if any, from frequency sweeping, frequency hopping, other modulation techniques and frequency stability over expected variations in temperature and supply voltage were considered.

**TEST REPORT**

**TABLE OF CONTENTS**

**1.0 GENERAL DESCRIPTION..... 5**

1.1 Product Description .....5

1.2 Related Submittal(s) Grants.....5

1.3 Test Methodology .....5

1.4 Test Facility .....5

**2.0 SYSTEM TEST CONFIGURATION..... 6**

2.1 Justification .....6

2.2 EUT Exercising Software .....7

2.3 Details of EUT and Description of Accessories .....8

2.4 Measurement Uncertainty .....8

**3.0 EMISSION RESULTS..... 9**

3.1 Field Strength Calculation.....9

3.2 Radiated Emission Configuration Photograph.....10

3.3 Radiated Emission Data .....10

3.4 Conducted Emission Configuration Photograph .....10

3.5 Conducted Emission Data .....10

**4.0 EQUIPMENT PHOTOGRAPHS..... 21**

**5.0 PRODUCT LABELLING ..... 21**

**6.0 TECHNICAL SPECIFICATIONS ..... 21**

**7.0 INSTRUCTION MANUAL ..... 21**

**8.0 MISCELLANEOUS INFORMATION ..... 22**

8.1 Radiated Emission on the Bandedge .....22

8.2 Discussion of Pulse Desensitization .....27

8.3 Calculation of Average Factor.....27

8.4 Emissions Test Procedures.....28

8.5 Occupied Bandwidth.....31

**9.0 CONFIDENTIALITY REQUEST..... 33**

**10.0 EQUIPMENT LIST ..... 33**

## TEST REPORT

### 1.0 GENERAL DESCRIPTION

#### 1.1 Product Description

The W992WZ82 (35-400574C) is a Thermostat Controller.

The Equipment Under Test (EUT) contains Wi-Fi, Bluetooth BLE and Zigbee features.

For BLE Mode, it operates at frequency range of 2402.000 MHz to 2480.000 MHz with 40 channels, the channels are separated with 2MHz spacing.

The EUT is powered by 24VAC.

Models	Description
W992WZ82	Fully popularize
SW992WZ50	Removed 3 relays and digital/analog control terminals at Thermostat Controller; Removed light sensor at Thermostat
SW991WZ50	Removed 3 relays and digital/analog control terminals at Thermostat Controller; Removed buzzer; light sensor, PIR sensor, change touch buttons to hard button (on board) at Thermostat

The representative model(s) W992WZ82 was selected to test.

The antenna(s) used in the EUT is integral, and the test sample is a prototype.  
Peak Antenna Gain: 0dBi

Antenna Type: Internal, Integral

For electronic filing, the brief circuit description is saved with filename: Descri.pdf.

#### 1.2 Related Submittal(s) Grants

This is a single application for certification of a transceiver (BLE Portion).

#### 1.3 Test Methodology

Both AC mains line-conducted and radiated emission measurements were performed according to the procedures in ANSI C63.10 (2013). All radiated measurements were performed in an 3m Chamber. Preliminary scans were performed in the 3m Chamber only to determine worst case modes. All radiated tests were performed at an antenna to EUT distance of 3 meters, unless stated otherwise in the “**Justification Section**” of this Application.

#### 1.4 Test Facility

The 3m Chamber and conducted measurement facility used to collect the radiated data is located at Workshop No. 3, G/F., World-Wide Industrial Centre, 43-47 Shan Mei Street, Fo Tan, Sha Tin, N.T., Hong Kong SAR, China. This test facility and site measurement data have been placed on file with the FCC and IC No. 2042H, CABID is “HKAP01”.

## TEST REPORT

### 2.0 SYSTEM TEST CONFIGURATION

#### 2.1 Justification

For radiated emissions testing, the equipment under test (EUT) was setup to transmit / receive continuously to simplify the measurement methodology. Care was taken to ensure proper power supply voltages during testing. During testing, all cables (if any) were manipulated to produce worst case emissions.

The EUT was powered by 24VAC during test.

For the measurements, the EUT was attached to a plastic stand if necessary and placed on the wooden turntable at 0.8m height from the ground plane for emission testing at or below 1GHz and 1.5m for emission measurements above 1GHz. If the EUT attached to peripherals, they were connected and operational (as typical as possible).

The signal was maximized through rotation and placement in the three orthogonal axes. The antenna height and polarization were varied during the search for maximum signal level. The antenna height was varied from 1 to 4 meters. Radiated emissions were taken at three meters unless the signal level was too low for measurement at that distance. If necessary, a pre-amplifier was used and/or the test was conducted at a closer distance.

For any intentional radiator powered by AC power line, measurements of the radiated signal level of the fundamental frequency component of the emission was performed with the supply voltage varied between 85% and 115% of the nominal rated supply voltage.

Radiated emission measurement for transmitter were performed from the lowest radio frequency signal generated in the device which is greater than 9 kHz to the tenth harmonic of the highest fundamental frequency or to 40 GHz, whichever is lower.

Emission that are directly caused by digital circuits in the transmit path and transmitter portion were measured, and the limit are according to FCC Part 15 Section 15.209 / RSS-247 2.5. Digital circuitries used to control additional functions other than the operation of the transmitter are subject to FCC Part 15 Section 15.109 / RSS-247 Section 5.5 Limits.

## TEST REPORT

### 2.1 Justification (Cont'd)

Detector function for radiated emissions was in peak mode. Average readings, when required, were taken by measuring the duty cycle of the equipment under test and subtracting the corresponding amount in dB from the measured peak readings. A detailed description for the calculation of the average factor can be found in section 4.8.3.

Determination of pulse desensitization was made according to Hewlett Packard Application Note 150-2, Spectrum Analysis... Pulsed RF. The effective period (Teff) was referred to Exhibit 4.8.3. With the resolution bandwidth 1MHz and spectrum analyzer IF bandwidth 3dB, the pulse desensitization factor was 0dB.

For AC power line-conducted emission test, the EUT along with its peripherals were placed on a 1.0m(W)x1.5m(L) and 0.8m in height wooden table and the EUT was adjusted to maintain a 0.4 meter space from a vertical reference plane. The EUT was connected to power mains through a line impedance stabilization network (LISN), which provided 50ohm coupling impedance for measuring instrument. The LISN housing, measuring instrument case, reference ground plane, and vertical ground plane were bounded together. The excess power cable between the EUT and the LISN was bundled.

All connecting cables of EUT and peripherals were manipulated to find the maximum emission.

All relevant operation modes have been tested, and the worst-case data is included in this report.

All data rates were tested under normal mode of WiFi. Only the worst-case data is shown in the report for DSSS and OFDM.

For simultaneous transmission, both Wi-Fi, BLE and Zigbee portions are also switched on when taking radiated emission for determining worst-case spurious emission.

### 2.2 EUT Exercising Software

The EUT exercise program (RTLBTAPP v5.2.2.40) used during radiated testing was designed to exercise the various system components in a manner similar to a typical use.

## TEST REPORT

### 2.3 Details of EUT and Description of Accessories

Description	Remark
24V AC-AC Transformer (Input: 220VAC 50Hz; Output: 24VAC 2A)	Provided by Applicant

### 2.4 Measurement Uncertainty

Decision Rule for compliance: For FCC/IC standard, the measured value must be within the limits of applicable standard without accounting for the measurement uncertainty. For EN/IEC/HKTA/HKTC standard, conformity rules will be used as per standard directly excepted EN/IEC 61000-3-2, EN/IEC 61000-3-3, HKTA1004, HKCA1008, HKTA1019, HKTA1020, HKTA1041 and HKTA1044.

Uncertainty and Compliance - Unless the standard specifically states that measured values are to be extended by the measurement uncertainty in determining compliance, all compliance determinations are based on the actual measured value.

## TEST REPORT

### 3.0 EMISSION RESULTS

Data is included of the worst case configuration (the configuration which resulted in the highest emission levels). A sample calculation, configuration photographs and data tables of the emissions are included.

#### 3.1 Field Strength Calculation

The field strength is calculated by adding the Antenna Factor and Cable Factor, and subtracting the Amplifier Gain (if any), Average Factor (optional) from the measured reading.

The basic equation with a sample calculation is as follows:

$$FS = RA + AF + CF - AG - AV$$

where FS = Field Strength in dB $\mu$ V/m  
 RA = Receiver Amplitude (including preamplifier) in dB $\mu$ V  
 AF = Antenna Factor in dB  
 CF = Cable Attenuation Factor in dB  
 AG = Amplifier Gain in dB  
 AV = Average Factor in dB

In the following table(s), the reading shown on the data table reflects the preamplifier gain.

An example for the calculations in the following table is as follows:

$$FS = RR + LF$$

where FS = Field Strength in dB $\mu$ V/m  
 RR = RA - AG - AV in dB $\mu$ V  
 LF = CF + AF in dB

Assume a receiver reading of 52.0 dB $\mu$ V is obtained. The antenna factor of 7.4 dB and cable factor of 1.6 dB are added. The amplifier gain of 29.0 dB and average factor of 5.0 dB are subtracted, giving a field strength of 27.0 dB $\mu$ V/m. This value in dB $\mu$ V/m was converted to its corresponding level in  $\mu$ V/m.

RA	=	52.0 dB $\mu$ V/m	
AF	=	7.4 dB	RR = 18.0 dB $\mu$ V
CF	=	1.6 dB	LF = 9.0 dB
AG	=	29.0 dB	
AV	=	5.0 dB	
FS	=	RR + LF	
FS	=	18.0 + 9.0 = 27.0 dB $\mu$ V/m	

Level in  $\mu$ V/m = Common Antilogarithm [(27.0 dB $\mu$ V/m)/20] = 22.4  $\mu$ V/m

## TEST REPORT

### 3.2 Radiated Emission Configuration Photograph

The worst case in radiated emission was found at 2400 MHz

For electronic filing, the worst case radiated emission configuration photographs are saved with filename: Setup Photos.pdf.

### 3.3 Radiated Emission Data

The data on the following page lists the significant emission frequencies, the limit and the margin of compliance. Numbers with a minus sign are below the limit.

Judgment: Passed by 0.7 dB

### 3.4 Conducted Emission Configuration Photograph

For electronic filing, the worst-case line-conducted configuration photographs are saved with filename: Setup Photos.pdf.

### 3.5 Conducted Emission Data

The data on the following page lists the significant emission frequencies, the limit and the margin of compliance. Numbers with a minus sign are below the limit.

Judgment: Pass by over 20 dB

**TEST REPORT**

**CONDUCTED EMISSION**

Model: W992WZ82  
Date of Test: 24 February, 2025  
Worst-Case Operating Mode: 2.4GHz Wi-Fi, BLE and Zigbee Operating

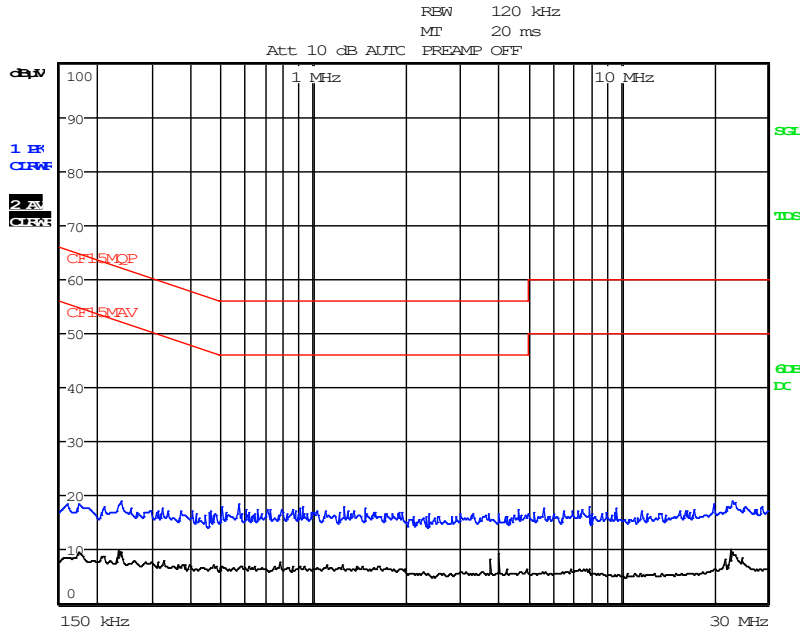

Note: Measurement Uncertainty is  $\pm 4.2$ dB at a level of confidence of 95%.

**TEST REPORT**

**CONDUCTED EMISSION**

Model: W992WZ82  
Date of Test: 24 February, 2025  
Worst-Case Operating Mode: 5GHz Wi-Fi, BLE and Zigbee Operating

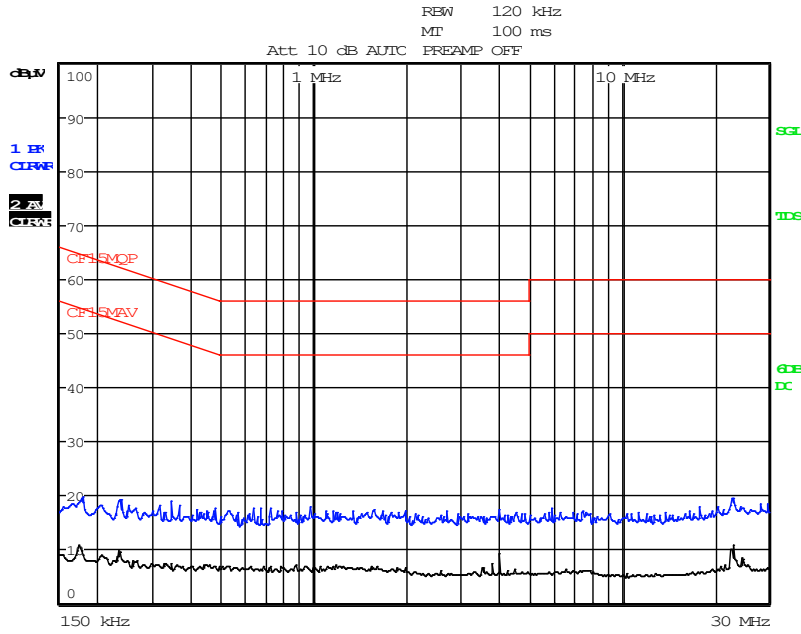

Note: Measurement Uncertainty is  $\pm 4.2$ dB at a level of confidence of 95%.

**TEST REPORT**

**RADIATED EMISSIONS**

Model: W992WZ82  
Date of Test: February 12, 2025  
Worst-Case Operating Mode: Transmitting (BLE 1Mbps)

Table 1

Pursuant to FCC Part 15 Section 15.249 / RSS-210 B10.0 Requirement

Lowest Channel

Polari- zation	Frequency (MHz)	Reading (dBµV)	Pre-Amp Gain (dB)	Antenna Factor (dB)	Net at 3m - Average (dBµV/m)	Average Limit at 3m (dBµV/m)	Margin (dB)
V	2402.000	92.8	33	29.4	89.2	94.0	-4.8
H	4804.000	31.2	33	34.9	33.1	54.0	-20.9
V	7206.000	33.7	33	37.9	38.6	54.0	-15.4
V	9608.000	34.4	33	40.4	41.8	54.0	-12.2
H	12010.000	37.7	33	40.5	45.2	54.0	-8.8
H	14412.000	38.4	33	40.0	45.4	54.0	-8.6

Polari- zation	Frequency (MHz)	Reading (dBµV)	Pre-Amp Gain (dB)	Antenna Factor (dB)	Net at 3m - Peak (dBµV/m)	Peak Limit at 3m (dBµV/m)	Margin (dB)
V	2402.000	99.0	33	29.4	95.4	114.0	-18.6
H	4804.000	44.6	33	34.9	46.5	74.0	-27.5
V	7206.000	46.5	33	37.9	51.4	74.0	-22.6
V	9608.000	48.2	33	40.4	55.6	74.0	-18.4
H	12010.000	51.3	33	40.5	58.8	74.0	-15.2
H	14412.000	51.9	33	40.0	58.9	74.0	-15.1

- Notes: 1. Peak Detector Data unless otherwise stated.  
2. Average detector is applied according to ANSI C63.10.  
3. All measurements were made at 3 meters.  
4. Negative value in the margin column shows emission below limit.  
5. Horn antenna is used for the emission over 1000MHz.  
6. Emissions within the restricted band meets the requirement of FCC Part 15 Section 15.205 / RSS-Gen Section 8.10.  
7. Measurement Uncertainty is ±5.3dB at a level of confidence of 95%.

**TEST REPORT**

**RADIATED EMISSIONS**

Model: W992WZ82  
Date of Test: February 12, 2025  
Worst-Case Operating Mode: Transmitting (BLE 1Mbps)

Table 2

Pursuant to FCC Part 15 Section 15.249 / RSS-210 B10.0 Requirement

Middle Channel

Polarization	Frequency (MHz)	Reading (dBµV)	Pre-Amp Gain (dB)	Antenna Factor (dB)	Net at 3m - Average (dBµV/m)	Average Limit at 3m (dBµV/m)	Margin (dB)
H	2440.000	90.3	33	29.4	86.7	94.0	-7.3
V	4880.000	31.4	33	34.9	33.3	54.0	-20.7
V	7320.000	33.1	33	37.9	38.0	54.0	-16.0
H	9760.000	35.4	33	40.4	42.8	54.0	-11.2
H	12200.000	38.6	33	40.5	46.1	54.0	-7.9
V	14640.000	39.1	33	38.4	44.5	54.0	-9.5

Polarization	Frequency (MHz)	Reading (dBµV)	Pre-Amp Gain (dB)	Antenna Factor (dB)	Net at 3m - Peak (dBµV/m)	Peak Limit at 3m (dBµV/m)	Margin (dB)
H	2440.000	96.3	33	29.4	92.7	114.0	-21.3
V	4880.000	44.2	33	34.9	46.1	74.0	-27.9
V	7320.000	46.2	33	37.9	51.1	74.0	-22.9
H	9760.000	48.7	33	40.4	56.1	74.0	-17.9
H	12200.000	52.0	33	40.5	59.5	74.0	-14.5
V	14640.000	52.3	33	38.4	57.7	74.0	-16.3

- Notes: 1. Peak Detector Data unless otherwise stated.  
 2. Average detector is applied according to ANSI C63.10.  
 3. All measurements were made at 3 meters.  
 4. Negative value in the margin column shows emission below limit.  
 5. Horn antenna is used for the emission over 1000MHz.  
 6. Emissions within the restricted band meets the requirement of FCC Part 15 Section 15.205 / RSS-Gen Section 8.10.  
 7. Measurement Uncertainty is ±5.3dB at a level of confidence of 95%.

**TEST REPORT**

**RADIATED EMISSIONS**

Model: W992WZ82  
Date of Test: February 12, 2025  
Worst-Case Operating Mode: Transmitting (BLE 1Mbps)

Table 3

Pursuant to FCC Part 15 Section 15.249 / RSS-210 B10.0 Requirement

Highest Channel

Polari- zation	Frequency (MHz)	Reading (dBµV)	Pre-Amp Gain (dB)	Antenna Factor (dB)	Net at 3m - Average (dBµV/m)	Average Limit at 3m (dBµV/m)	Margin (dB)
V	2480.000	93.5	33	29.4	89.9	94.0	-4.1
H	4960.000	31.5	33	34.9	33.4	54.0	-20.6
V	7440.000	32.5	33	37.9	37.4	54.0	-16.6
V	9920.000	34.5	33	40.4	41.9	54.0	-12.1
V	12400.000	40.1	33	40.5	47.6	54.0	-6.4
H	14880.000	38.4	33	38.4	43.8	54.0	-10.2

Polari- zation	Frequency (MHz)	Reading (dBµV)	Pre-Amp Gain (dB)	Antenna Factor (dB)	Net at 3m - Peak (dBµV/m)	Peak Limit at 3m (dBµV/m)	Margin (dB)
V	2480.000	99.6	33	29.4	96.0	114.0	-18.0
H	4960.000	44.6	33	34.9	46.5	74.0	-27.5
V	7440.000	45.9	33	37.9	50.8	74.0	-23.2
V	9920.000	47.7	33	40.4	55.1	74.0	-18.9
V	12400.000	53.4	33	40.5	60.9	74.0	-13.1
H	14880.000	52.2	33	38.4	57.6	74.0	-16.4

- Notes: 1. Peak Detector Data unless otherwise stated.  
 2. Average detector is applied according to ANSI C63.10.  
 3. All measurements were made at 3 meters.  
 4. Negative value in the margin column shows emission below limit.  
 5. Horn antenna is used for the emission over 1000MHz.  
 6. Emissions within the restricted band meets the requirement of FCC Part 15 Section 15.205 / RSS-Gen Section 8.10.  
 7. Measurement Uncertainty is ±5.3dB at a level of confidence of 95%.

**TEST REPORT**

**RADIATED EMISSIONS**

Model: W992WZ82  
Date of Test: February 12, 2025  
Worst-Case Operating Mode: Transmitting (BLE 2Mbps)

Table 4

Pursuant to FCC Part 15 Section 15.249 / RSS-210 B10.0 Requirement

Lowest Channel

Polarization	Frequency (MHz)	Reading (dBµV)	Pre-Amp Gain (dB)	Antenna Factor (dB)	Net at 3m - Average (dBµV/m)	Average Limit at 3m (dBµV/m)	Margin (dB)
V	2402.000	89.6	33	29.4	86.0	94.0	-8.0
H	4804.000	31.3	33	34.9	33.2	54.0	-20.8
V	7206.000	32.6	33	37.9	37.5	54.0	-16.5
H	9608.000	33.5	33	40.4	40.9	54.0	-13.1
H	12010.000	37.5	33	40.5	45.0	54.0	-9.0
H	14412.000	38.2	33	40.0	45.2	54.0	-8.8

Polarization	Frequency (MHz)	Reading (dBµV)	Pre-Amp Gain (dB)	Antenna Factor (dB)	Net at 3m - Peak (dBµV/m)	Peak Limit at 3m (dBµV/m)	Margin (dB)
V	2402.000	99.2	33	29.4	95.6	114.0	-18.4
H	4804.000	44.6	33	34.9	46.5	74.0	-27.5
V	7206.000	46.6	33	37.9	51.5	74.0	-22.5
H	9608.000	46.8	33	40.4	54.2	74.0	-19.8
H	12010.000	51.6	33	40.5	59.1	74.0	-14.9
H	14412.000	52.0	33	40.0	59.0	74.0	-15.0

- Notes:
1. Peak Detector Data unless otherwise stated.
  2. Average detector is applied according to ANSI C63.10.
  3. All measurements were made at 3 meters.
  4. Negative value in the margin column shows emission below limit.
  5. Horn antenna is used for the emission over 1000MHz.
  6. Emissions within the restricted band meets the requirement of FCC Part 15 Section 15.205 / RSS-Gen Section 8.10.
  7. Measurement Uncertainty is ±5.3dB at a level of confidence of 95%.

**TEST REPORT**

**RADIATED EMISSIONS**

Model: W992WZ82  
Date of Test: February 12, 2025  
Worst-Case Operating Mode: Transmitting (BLE 2Mbps)

Table 5

Pursuant to FCC Part 15 Section 15.249 / RSS-210 B10.0 Requirement

Middle Channel

Polarization	Frequency (MHz)	Reading (dBμV)	Pre-Amp Gain (dB)	Antenna Factor (dB)	Net at 3m - Average (dBμV/m)	Average Limit at 3m (dBμV/m)	Margin (dB)
V	2440.000	88.0	33	29.4	84.4	94.0	-9.6
V	4880.000	30.2	33	34.9	32.1	54.0	-21.9
H	7320.000	32.2	33	37.9	37.1	54.0	-16.9
H	9760.000	34.5	33	40.4	41.9	54.0	-12.1
V	12200.000	38.4	33	40.5	45.9	54.0	-8.1
V	14640.000	39.0	33	38.4	44.4	54.0	-9.6

Polarization	Frequency (MHz)	Reading (dBμV)	Pre-Amp Gain (dB)	Antenna Factor (dB)	Net at 3m - Peak (dBμV/m)	Peak Limit at 3m (dBμV/m)	Margin (dB)
V	2440.000	95.8	33	29.4	92.2	114.0	-21.8
V	4880.000	43.6	33	34.9	45.5	74.0	-28.5
H	7320.000	46.3	33	37.9	51.2	74.0	-22.8
H	9760.000	47.8	33	40.4	55.2	74.0	-18.8
V	12200.000	52.0	33	40.5	59.5	74.0	-14.5
V	14640.000	52.4	33	38.4	57.8	74.0	-16.2

- Notes:
1. Peak Detector Data unless otherwise stated.
  2. Average detector is applied according to ANSI C63.10.
  3. All measurements were made at 3 meters.
  4. Negative value in the margin column shows emission below limit.
  5. Horn antenna is used for the emission over 1000MHz.
  6. Emissions within the restricted band meets the requirement of FCC Part 15 Section 15.205 / RSS-Gen Section 8.10.
  7. Measurement Uncertainty is ±5.3dB at a level of confidence of 95%.

**TEST REPORT**

**RADIATED EMISSIONS**

Model: W992WZ82  
Date of Test: February 12, 2025  
Worst-Case Operating Mode: Transmitting (BLE 2Mbps)

Table 6

Pursuant to FCC Part 15 Section 15.249 / RSS-210 B10.0 Requirement

Highest Channel

Polarization	Frequency (MHz)	Reading (dBµV)	Pre-Amp Gain (dB)	Antenna Factor (dB)	Net at 3m - Average (dBµV/m)	Average Limit at 3m (dBµV/m)	Margin (dB)
V	2480.000	91.9	33	29.4	88.3	94.0	-5.7
H	4960.000	31.0	33	34.9	32.9	54.0	-21.1
V	7440.000	32.1	33	37.9	37.0	54.0	-17.0
V	9920.000	35.0	33	40.4	42.4	54.0	-11.6
H	12400.000	40.0	33	40.5	47.5	54.0	-6.5
V	14880.000	38.4	33	38.4	43.8	54.0	-10.2

Polarization	Frequency (MHz)	Reading (dBµV)	Pre-Amp Gain (dB)	Antenna Factor (dB)	Net at 3m - Peak (dBµV/m)	Peak Limit at 3m (dBµV/m)	Margin (dB)
V	2480.000	99.5	33	29.4	95.9	114.0	-18.1
H	4960.000	44.1	33	34.9	46.0	74.0	-28.0
V	7440.000	45.2	33	37.9	50.1	74.0	-23.9
V	9920.000	48.3	33	40.4	55.7	74.0	-18.3
H	12400.000	53.4	33	40.5	60.9	74.0	-13.1
V	14880.000	51.9	33	38.4	57.3	74.0	-16.7

- Notes: 1. Peak Detector Data unless otherwise stated.  
 2. Average detector is applied according to ANSI C63.10.  
 3. All measurements were made at 3 meters.  
 4. Negative value in the margin column shows emission below limit.  
 5. Horn antenna is used for the emission over 1000MHz.  
 6. Emissions within the restricted band meets the requirement of FCC Part 15 Section 15.205 / RSS-Gen Section 8.10.  
 7. Measurement Uncertainty is ±5.3dB at a level of confidence of 95%.

**TEST REPORT**

**RADIATED EMISSIONS**

Model: W992WZ82  
Date of Test: February 24, 2025  
Worst-Case Operating Mode: 2.4GHz Wi-Fi, BLE and Zigbee Operating

Table 7

Pursuant to FCC Part 15 Section 15.209 / RSS-GEN 8.9 Requirement

Polarization	Frequency (MHz)	Reading (dBμV)	Pre-amp (dB)	Antenna Factor (dB)	Net at 3m (dBμV/m)	Limit at 3m (dBμV/m)	Margin (dB)
V	201.084	29.1	16	16.0	29.1	43.5	-14.4
V	399.934	19.3	16	25.0	28.3	46.0	-17.7
V	609.818	19.8	16	29.0	32.8	46.0	-13.2
V	655.044	18.9	16	29.0	31.9	46.0	-14.1
V	894.513	19.5	16	32.0	35.5	46.0	-10.5
V	960.109	19.6	16	33.0	36.6	54.0	-17.4

- Notes:
1. Peak Detector Data unless otherwise stated.
  2. All measurements were made at 3 meters.
  3. Negative value in the margin column shows emission below limit.
  4. Horn antenna is used for the emission over 1000MHz.
  5. Emissions within the restricted band meets the requirement of FCC Part 15 Section 15.205 / RSS-Gen Section 8.10.
  6. Measurement Uncertainty is ±5.3dB at a level of confidence of 95%.

**TEST REPORT**

**RADIATED EMISSIONS**

Model: W992WZ82  
Date of Test: February 24, 2025  
Worst-Case Operating Mode: 5GHz Wi-Fi, BLE and Zigbee Operating

Table 8

Pursuant to FCC Part 15 Section 15.209 / RSS-GEN 8.9 Requirement

Polarization	Frequency (MHz)	Reading (dBμV)	Pre-amp (dB)	Antenna Factor (dB)	Net at 3m (dBμV/m)	Limit at 3m (dBμV/m)	Margin (dB)
V	79.713	34.5	16	6.0	24.5	40.0	-15.5
V	207.510	24.5	16	17.0	25.5	43.5	-18.0
H	374.956	19.4	16	24.0	27.4	46.0	-18.6
V	450.010	19.7	16	26.0	29.7	46.0	-16.3
V	624.974	16.9	16	29.0	29.9	46.0	-16.1
V	960.230	26.2	16	33.0	43.2	54.0	-10.8

- Notes:
1. Peak Detector Data unless otherwise stated.
  2. All measurements were made at 3 meters.
  3. Negative value in the margin column shows emission below limit.
  4. Horn antenna is used for the emission over 1000MHz.
  5. Emissions within the restricted band meets the requirement of FCC Part 15 Section 15.205 / RSS-Gen Section 8.10.
  6. Measurement Uncertainty is ±5.3dB at a level of confidence of 95%.

## TEST REPORT

### 4.0 EQUIPMENT PHOTOGRAPHS

For electronic filing, the photographs are saved with filename: External Photos.pdf and Internal Photos.pdf.

### 5.0 PRODUCT LABELLING

For electronics filing, the FCC ID label artwork and the label location are saved with filename: Label.pdf.

### 6.0 TECHNICAL SPECIFICATIONS

For electronic filing, the block diagram and schematic of the tested EUT are saved with filename: Block.pdf and Circuit.pdf respectively.

### 7.0 INSTRUCTION MANUAL

For electronic filing, a preliminary copy of the Instruction Manual is saved with filename: Manual.pdf.

This manual will be provided to the end-user with each unit sold/leased in the United States and Canada.

## TEST REPORT

### 8.0 MISCELLANEOUS INFORMATION

The miscellaneous information includes details of the test procedure and measured bandwidth / calculation of factor such as pulse desensitization and averaging factor (calculation and timing diagram).

#### 8.1 Radiated Emission on the Bandedge

From the following plots, they show that the fundamental emissions are confined in the specified band (2400MHz to 2483.5MHz). In case of the fundamental emissions are within two standard bandwidths from the bandedge, the delta measurement technique is used for determining bandedge compliance. Standard bandwidth is the bandwidth specified by ANSI C63.10 (2013) for frequency being measured.

Emissions radiated outside of the specified frequency bands, except harmonics, are attenuated by 50dB below the level of the fundamental or to the general radiated emissions limits in Section 15.209 / RSS-Gen 8.9, whichever is the lesser attenuation, which meet the requirement of Part 15.249(d) / RSS-210 B.10.

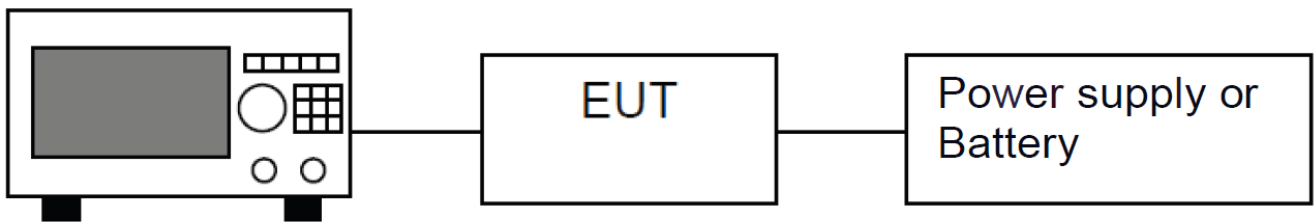

Spectrum Analyzer

Block diagram of Test setup

**TEST REPORT**

**PEAK MEASUREMENT (BLE 1Mbps)**

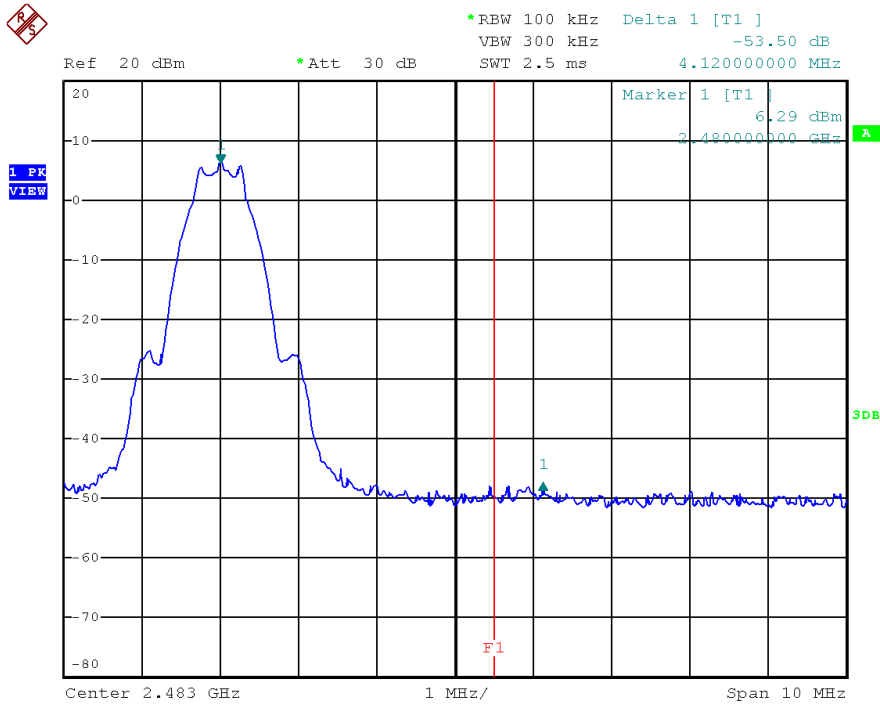
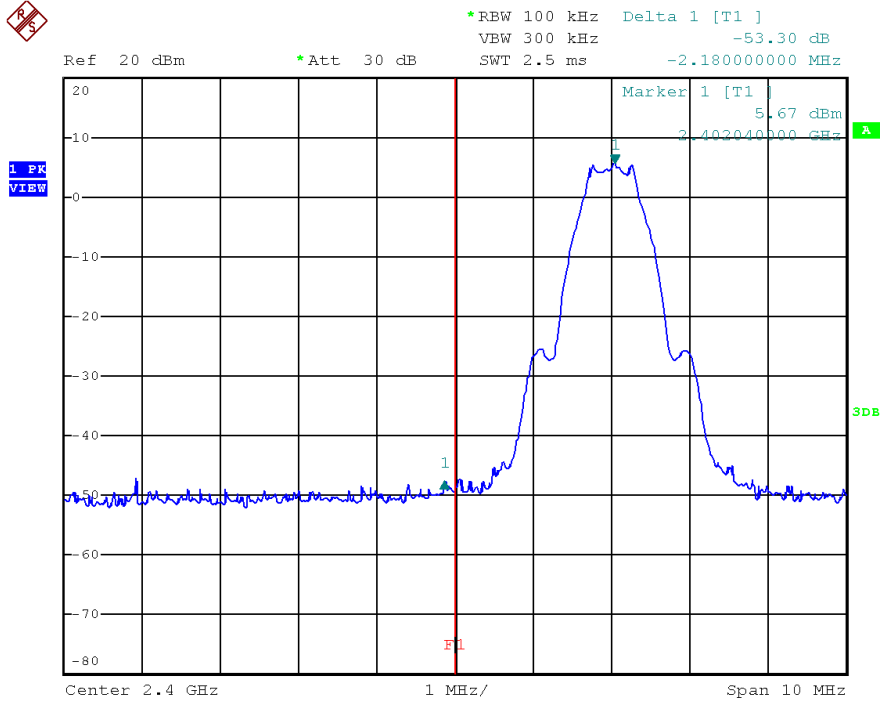

## TEST REPORT

### PEAK MEASUREMENT (BLE 1Mbps)

Bandedge compliance is determined by applying marker-delta method, i.e. (Bandedge Plot).

Lower Bandedge

Peak Resultant Field Strength = Fundamental Emissions (Peak Value) – delta from the plot

$$\begin{aligned} &= 95.4 \text{ dB}\mu\text{V/m} - 53.3 \text{ dB} \\ &= 42.1 \text{ dB}\mu\text{V/m} \end{aligned}$$

Average Resultant Field Strength = Fundamental Emissions (Average Value) – delta from the plot

$$\begin{aligned} &= 89.2 \text{ dB}\mu\text{V/m} - 53.3 \text{ dB} \\ &= 35.9 \text{ dB}\mu\text{V/m} \end{aligned}$$

Upper Bandedge

Peak Resultant Field Strength = Fundamental Emissions (Peak Value) – delta from the plot

$$\begin{aligned} &= 96.0 \text{ dB}\mu\text{V/m} - 53.5 \text{ dB} \\ &= 42.5 \text{ dB}\mu\text{V/m} \end{aligned}$$

Average Resultant Field Strength = Fundamental Emissions (Average Value) – delta from the plot

$$\begin{aligned} &= 89.9 \text{ dB}\mu\text{V/m} - 53.5 \text{ dB} \\ &= 36.4 \text{ dB}\mu\text{V/m} \end{aligned}$$

The resultant field strength meets the general radiated emission limit in Section 15.209, which does not exceed 74 dB $\mu$ V/m (Peak Limit) and 54 dB $\mu$ V/m (Average Limit).

**TEST REPORT**

**PEAK MEASUREMENT (BLE 2Mbps)**

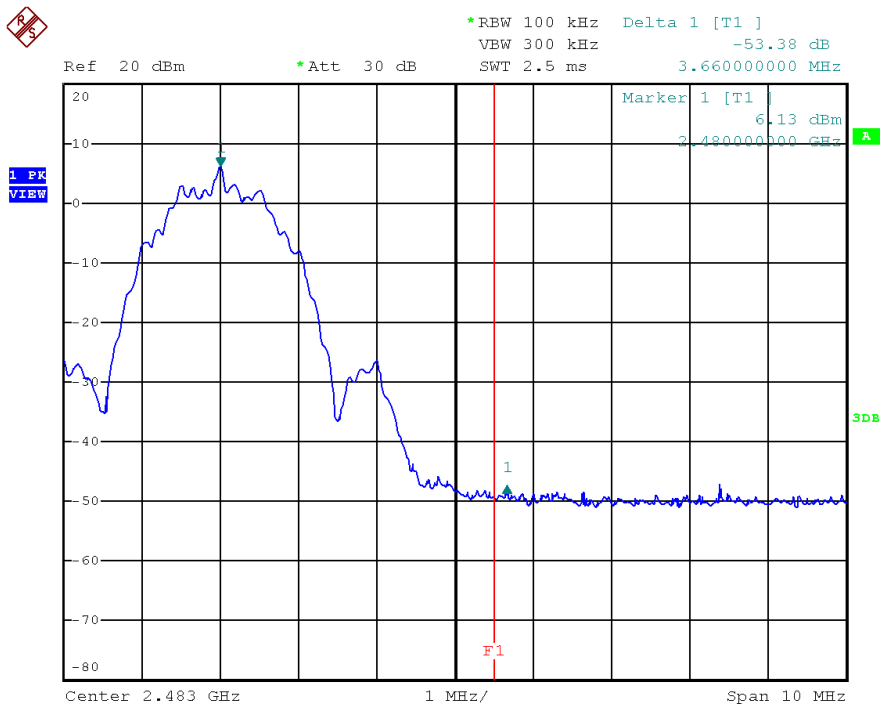
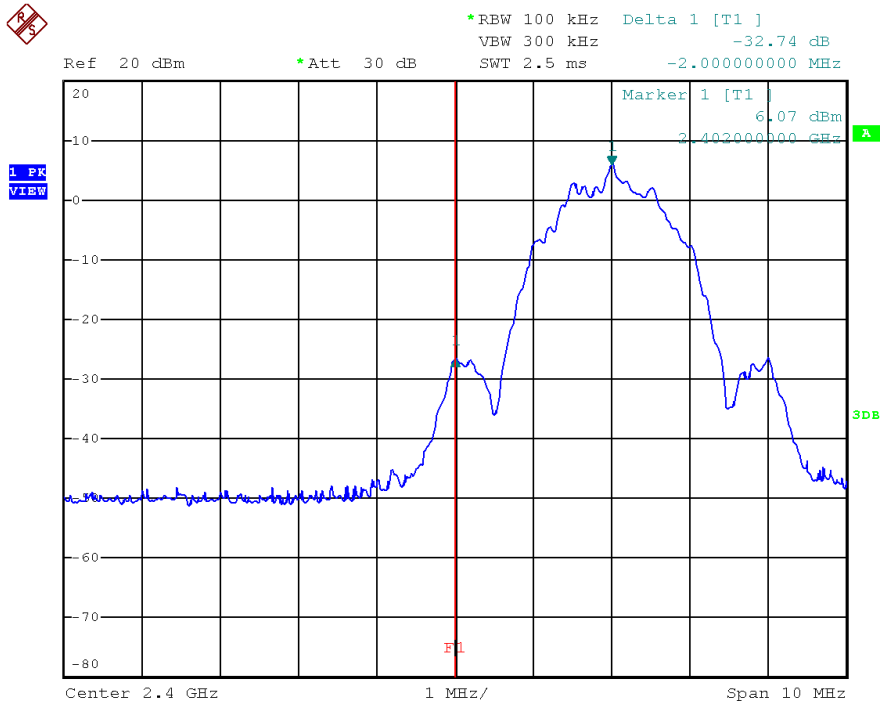

## TEST REPORT

### PEAK MEASUREMENT (BLE 2Mbps)

Bandedge compliance is determined by applying marker-delta method, i.e. (Bandedge Plot).

Lower Bandedge

Peak Resultant Field Strength = Fundamental Emissions (Peak Value) – delta from the plot

$$\begin{aligned} &= 95.6 \text{ dB}\mu\text{V/m} - 32.7 \text{ dB} \\ &= 62.9 \text{ dB}\mu\text{V/m} \end{aligned}$$

Average Resultant Field Strength = Fundamental Emissions (Average Value) – delta from the plot

$$\begin{aligned} &= 86.0 \text{ dB}\mu\text{V/m} - 32.7 \text{ dB} \\ &= 53.3 \text{ dB}\mu\text{V/m} \end{aligned}$$

Upper Bandedge

Peak Resultant Field Strength = Fundamental Emissions (Peak Value) – delta from the plot

$$\begin{aligned} &= 95.9 \text{ dB}\mu\text{V/m} - 53.4 \text{ dB} \\ &= 42.5 \text{ dB}\mu\text{V/m} \end{aligned}$$

Average Resultant Field Strength = Fundamental Emissions (Average Value) – delta from the plot

$$\begin{aligned} &= 88.3 \text{ dB}\mu\text{V/m} - 53.4 \text{ dB} \\ &= 34.9 \text{ dB}\mu\text{V/m} \end{aligned}$$

The resultant field strength meets the general radiated emission limit in Section 15.209, which does not exceed 74 dB $\mu$ V/m (Peak Limit) and 54 dB $\mu$ V/m (Average Limit).

## TEST REPORT

### 8.2 Discussion of Pulse Desensitization

Pulse desensitivity is not applicable for this device. The effective period ( $T_{eff}$ ) is approximately  $625\mu s$  for a digital "1" bit which illustrated on technical specification, with a resolution bandwidth (3dB) of 3MHz, so the pulse desensitivity factor is 0dB.

### 8.3 Calculation of Average Factor

Not Applicable

## TEST REPORT

### 8.4 Emissions Test Procedures

The following is a description of the test procedure used by Intertek Testing Services Hong Kong Ltd. in the measurements of transmitter operating under the Part 15, Subpart C rules.

The transmitting equipment under test (EUT) is placed on a wooden turntable which is four feet in diameter and approximately 0.8m in height above the ground plane for emission measurement at or below 1GHz and 1.5m in height above the ground plane for emission measurement above 1GHz. During the radiated emissions test, the turntable is rotated and any cables leaving the EUT are manipulated to find the configuration resulting in maximum emissions. The EUT is adjusted through all three orthogonal axis to obtain maximum emission levels. The antenna height and polarization are also varied during the testing to search for maximum signal levels. The height of the antenna is varied from one to four meters.

Detector function for radiated emissions is in peak mode. Average readings, when required, are taken by measuring the duty cycle of the equipment under test and subtracting the corresponding amount in dB from the measured peak readings. A detailed description for the calculation of the average factor can be found in Exhibit 8.3.

The frequency range scanned is from the lowest radio frequency signal generated in the device which is greater than 9 kHz to the tenth harmonic of the highest fundamental frequency or 40 GHz, whichever is lower.

The EUT is warmed up for 15 minutes prior to the test.

AC power to the unit is varied from 85% to 115% nominal and variation in the fundamental emission field strength is recorded. If battery powered, a new, fully charged battery is used.

Conducted measurements were made as described in ANSI C63.10 (2013).

The IF bandwidth used for measurement of radiated signal strength was 100 kHz or greater when frequency is below 1000 MHz. Where pulsed transmissions of short enough pulse duration warrant, a greater bandwidth is selected according to the recommendations of Hewlett Packard Application Note 150-2. A discussion of whether pulse desensitivity is applicable to this unit is included in this report (See Exhibit 8.1). Above 1000 MHz, a resolution bandwidth of 3 MHz is used.

Transmitter measurements are normally conducted at a measurement distance of three meters. However, to assure low enough noise floor in the forbidden bands and above 1 GHz, signals are acquired at a distance of one meter or less. All measurements are extrapolated to three meters using inverse scaling, unless otherwise reported. Measurements taken at a closer distance are so marked.

**TEST REPORT**

8.4.1 Radiated Emission Test Setup

The figure below shows the test setup, which is utilized to make these measurements.

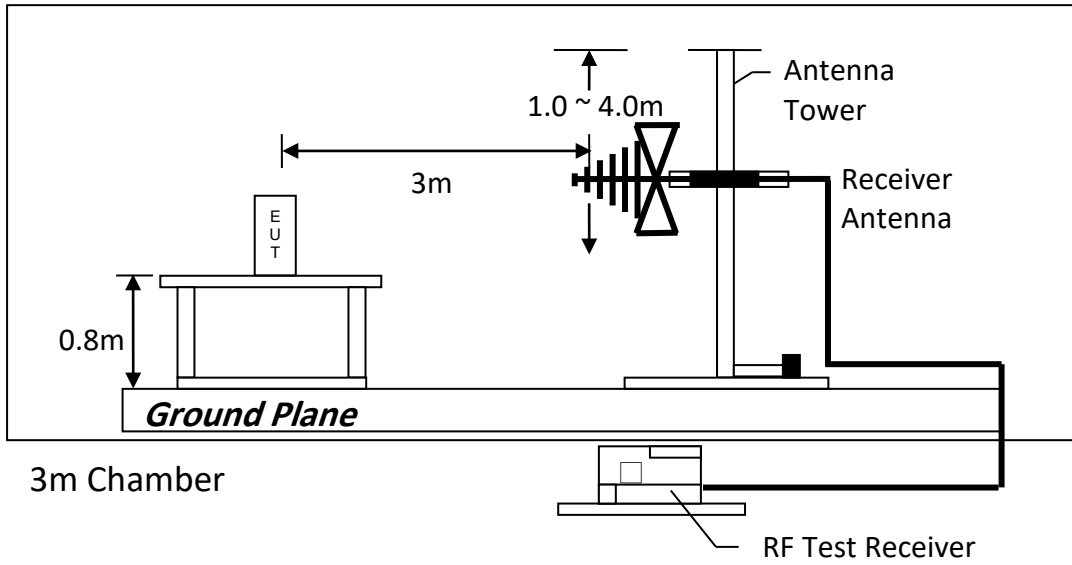

Test setup of radiated emissions up to 1GHz

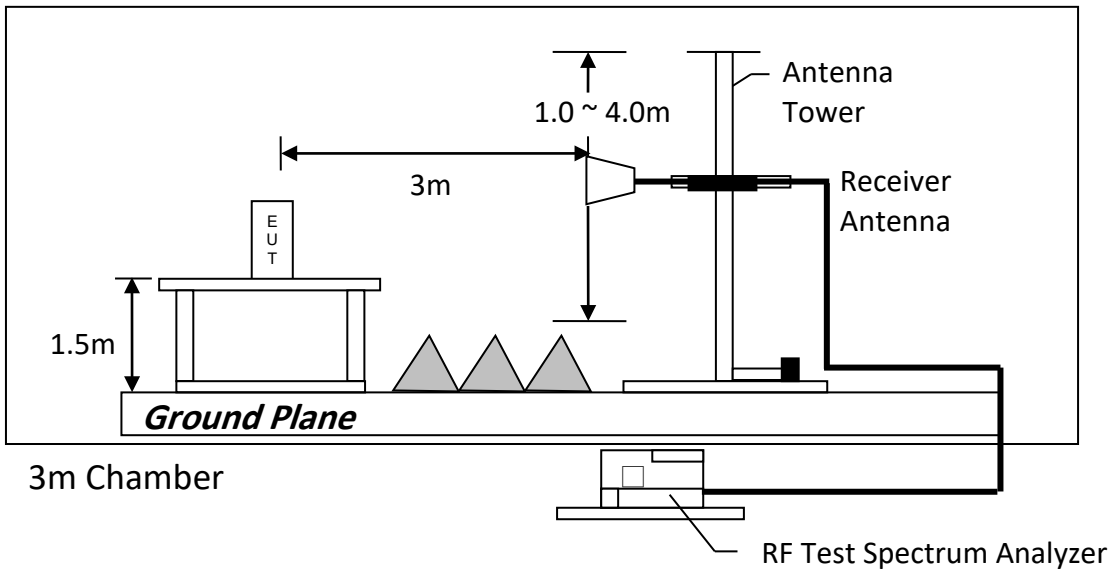

Test setup of radiated emissions above 1GHz

## TEST REPORT

### 8.4.2 Conducted Emission Test Procedures

For tabletop equipment, the EUT along with its peripherals were placed on a 1.0m(W)×1.5m(L) and 0.8m in height wooden table. For floor-standing equipment, the EUT and all cables were insulated, if required, from the ground plane by up to 12 mm of insulating material. The EUT was adjusted to maintain a 0.4 meter space from a vertical reference plane. The EUT was connected to power mains through a line impedance stabilization network (LISN), which provided 50 ohm coupling impedance for measuring instrument and the chassis ground was bounded to the horizontal ground plane of shielded room. The excess power cable between the EUT and the LISN was bundled.

All connecting cables of EUT and peripherals were moved to find the maximum emission.

### 8.4.3 Conducted Emission Test Setup

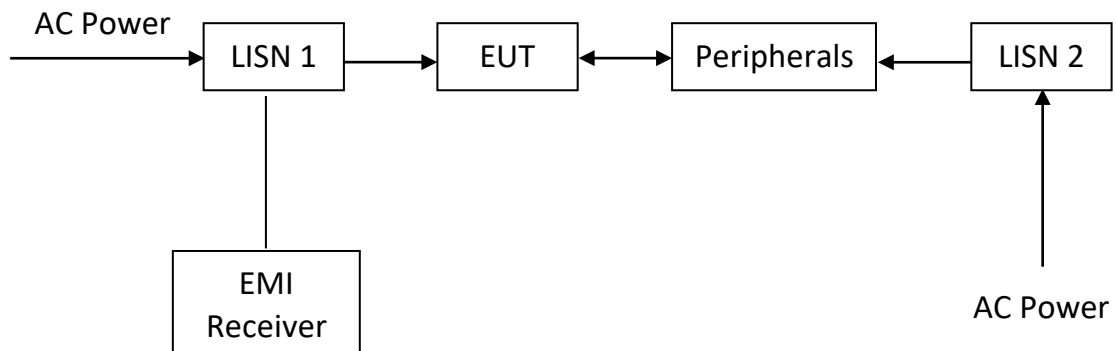

**TEST REPORT**

8.5 Occupied Bandwidth

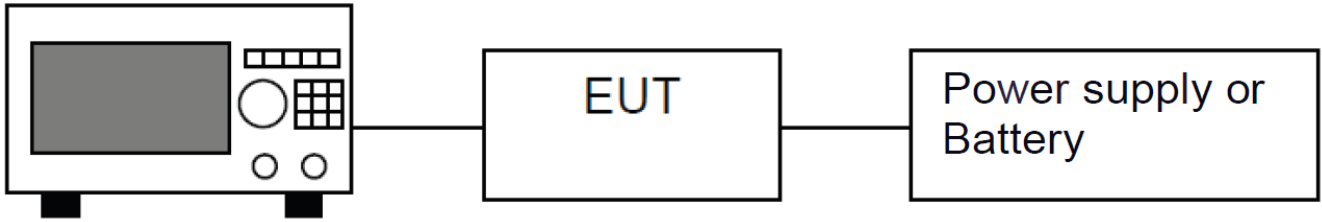

**Spectrum Analyzer**

Block diagram of Test setup

Occupied Bandwidth Results: (BLE 1Mbps)

Bluetooth (MHz)	Occupied Bandwidth (kHz)
Low Channel: 2402	1032
Middle Channel: 2440	1032
High Channel: 2480	1032

The worst case is shown as below:

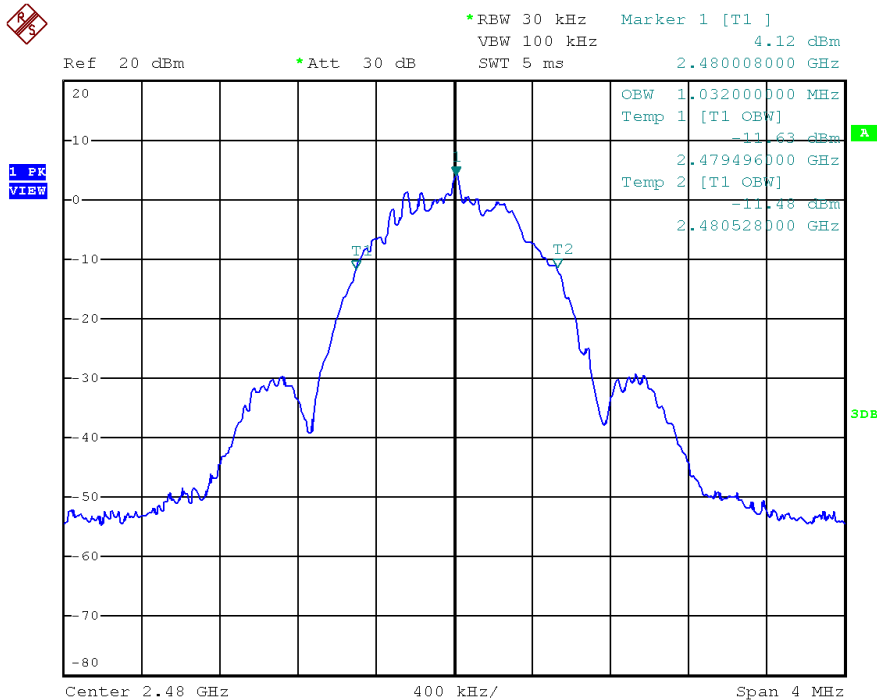

**TEST REPORT**

Occupied Bandwidth Results: (BLE 2Mbps)

Bluetooth (MHz)	Occupied Bandwidth (kHz)
Low Channel: 2402	2064
Middle Channel: 2440	2064
High Channel: 2480	2064

The worst case is shown as below:

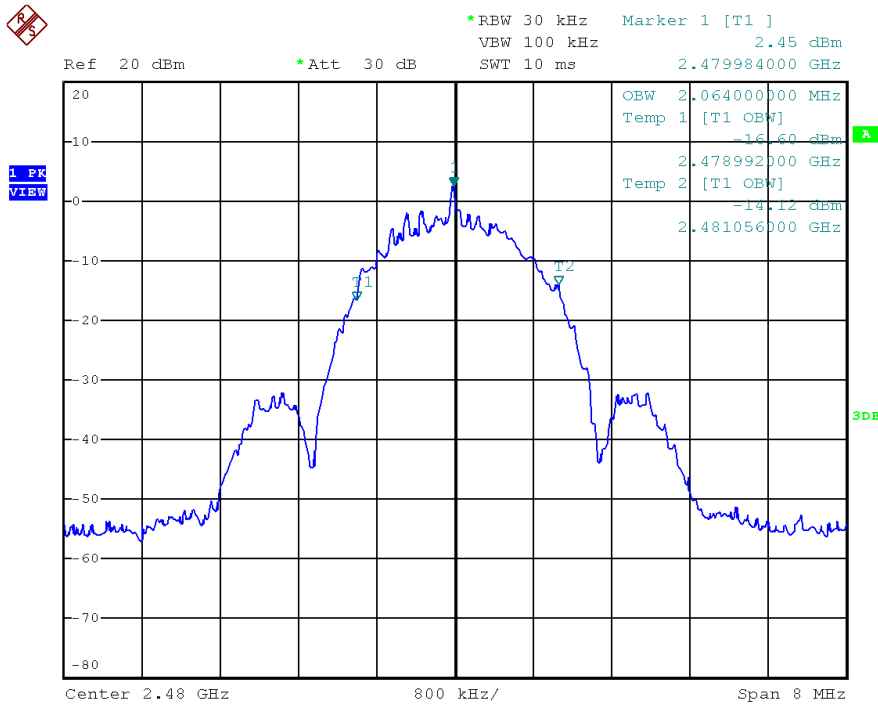

## TEST REPORT

### 9.0 CONFIDENTIALITY REQUEST

For electronic filing, a preliminary copy of the confidentiality request is saved with filename: Request.pdf.

### 10.0 EQUIPMENT LIST

1) Radiated Emissions Test

Equipment	EMI Test Receiver (9kHz to 26.5GHz)	Biconical Antenna (30MHz to 300MHz)	Log Periodic Antenna
Registration No.	EW-3156	EW-3242	EW-3243
Manufacturer	ROHDESCHWARZ	EMCO	EMCO
Model No.	ESR26	3110C	3148B
Calibration Date	January 31, 2024	July 30, 2024	July 30, 2024
Calibration Due Date	May 01, 2025	July 30, 2026	July 30, 2026

Equipment	Double Ridged Guide Antenna (1GHz - 18GHz)	Active Loop Antenna (H-field) (9kHz to 30MHz)	RF Pre-amplifier (9kHz to 6000MHz)
Registration No.	EW-0194	EW-3326	EW-3006b
Manufacturer	EMCO	EMCO	SCHWARZBECK
Model No.	3115	6502	BBV9718
Calibration Date	May 10, 2023	January 05, 2024	October 20, 2023
Calibration Due Date	May 10, 2025	July 05, 2025	April 20, 2025

Equipment	2.4GHz Notch Filter	14m Double Shield RF Cable (9kHz - 6GHz)	RF Cable 14m (1GHz to 26.5GHz)
Registration No.	EW-3435	EW-2376	EW-2781
Manufacturer	MICROWAVE	RADIALL	GREATBILLION
Model No.	N0324413	n m/br56/bnc m 14m	SMA m/SHF5MPU /SMA m ra14m,26G
Calibration Date	October 09, 2024	October 09, 2024	January 16, 2024
Calibration Due Date	October 09, 2025	October 09, 2025	April 16, 2025

Equipment	12 metre RF Cable (1-40)GHz	Pyramidal Horn Antenna
Registration No.	EW-2774	EW-0905
Manufacturer	GREATBILLION	EMCO
Model No.	SMA m-m ra 12m 40G outdoor	3160-09
Calibration Date	January 16, 2024	December 15, 2023
Calibration Due Date	April 16, 2025	June 15, 2025

**TEST REPORT**

2) Conducted Emissions Test

Equipment	RF Cable 240cm (RG142) (9kHz to 30MHz)	Artificial Mains Network	EMI Test Receiver (9kHz to 3GHz)
Registration No.	EW-2454	EW-3360	EW-3095
Manufacturer	RADIALL	ROHDESCHWARZ	ROHDESCHWARZ
Model No.	Bnc m st / 142 / bnc mra 240cm	ENV-216	ESCI
Calibration Date	June 20, 2024	April 07, 2024	January 18, 2024
Calibration Due Date	June 20, 2025	April 07, 2025	April 18, 2025

3) Bandedge & Bandwidth Measurement

Equipment	EMI Test Receiver (9kHz to 3GHz)
Registration No.	EW-3095
Manufacturer	ROHDESCHWARZ
Model No.	ESCI
Calibration Date	January 18, 2024
Calibration Due Date	April 18, 2025

4) Control Software for Radiated Emission

Software Information	
Software Name	EMC32
Manufacturer	ROHDESCHWARZ
Software version	10.50.40

**END OF TEST REPORT**