

UNIT LABEL

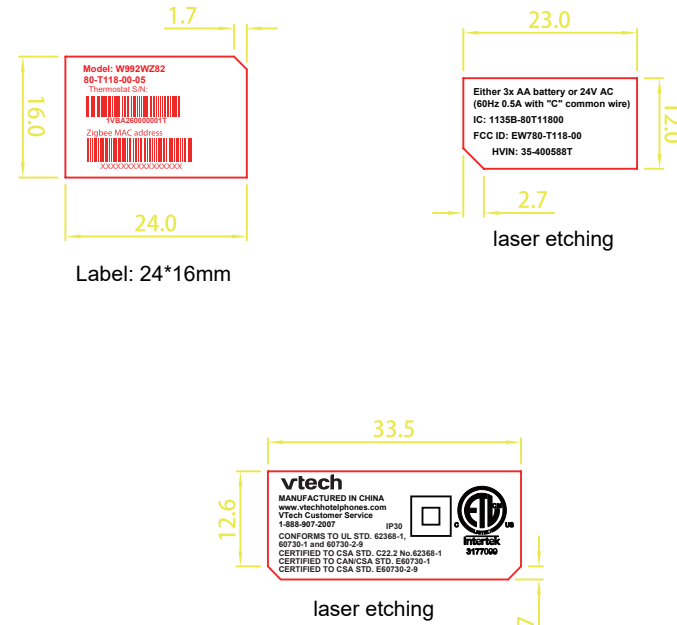

BOX LABEL

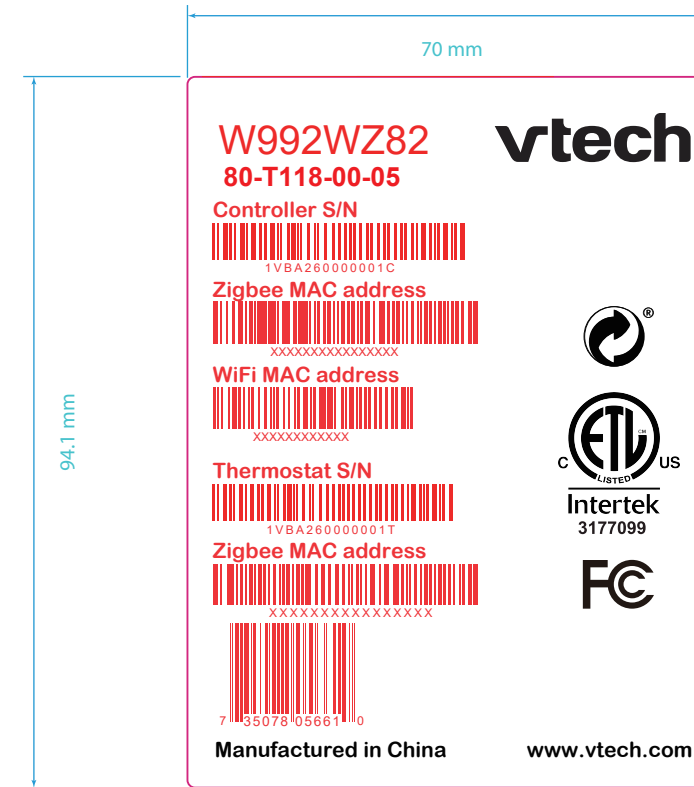

Label 1 size: 94.1*70mm

⚠ WARNING

- **INGESTION HAZARD:** This product contains a button cell or coin battery. **DEATH** or serious injury can occur if ingested.
- A swallowed button cell or coin battery can cause **Internal Chemical Burns** in as little as **2 hours**.
- **KEEP** new and used batteries **OUT OF REACH of CHILDREN**
- **Seek immediate medical attention** if a battery is suspected to be swallowed or inserted inside any part of the body. The product contains **Non-replaceable batteries**.
- Compatible battery type CR1220. Nominal battery voltage 3V.

Label 2 size: 70 x 70 mm

CTN LABEL 92-005428-000-100



Label: 75*65mm

W992WZ82	
1VB A26 0000001 T	Thermostat
	Serial number
	Date code
	Product code
1VB A26 0000001 C	Controller
	Serial number
	Date code
	Product code
Serial number -> Continued number on all POs	
For example, 0000001, 0000002, 0000003,..... 0003000(for current order);	
Next PO start from 0003001, 0003002,.....NNNNNN;	
A39 = Date code	
A = 2024, B = 2025, C = 2026, ...; 26 = production week, 生产周数	

UNITS LABEL

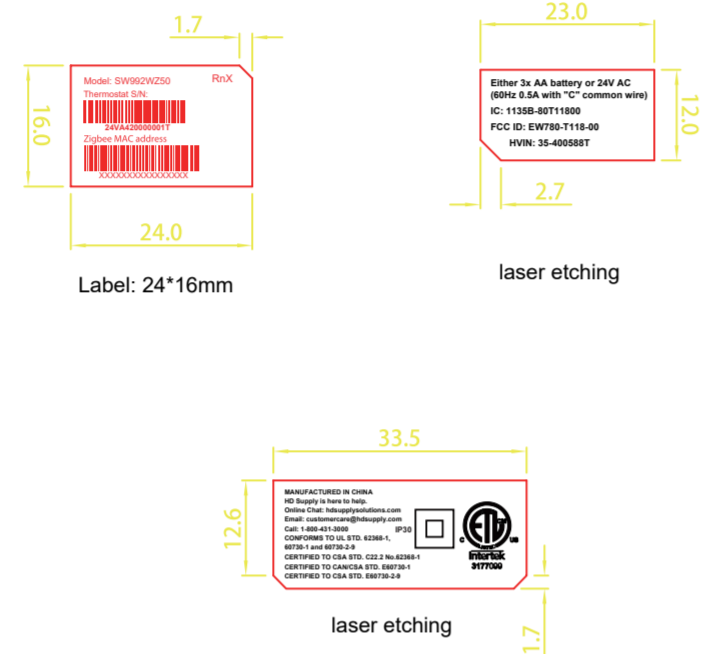
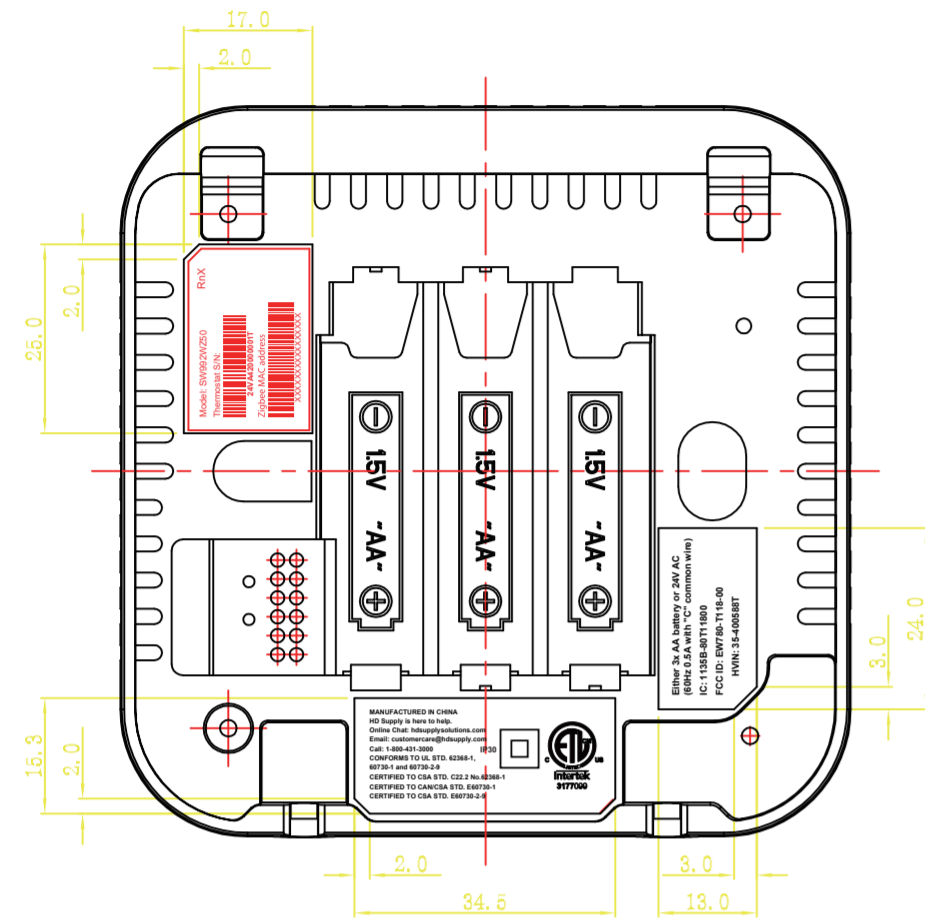

BOX LABEL

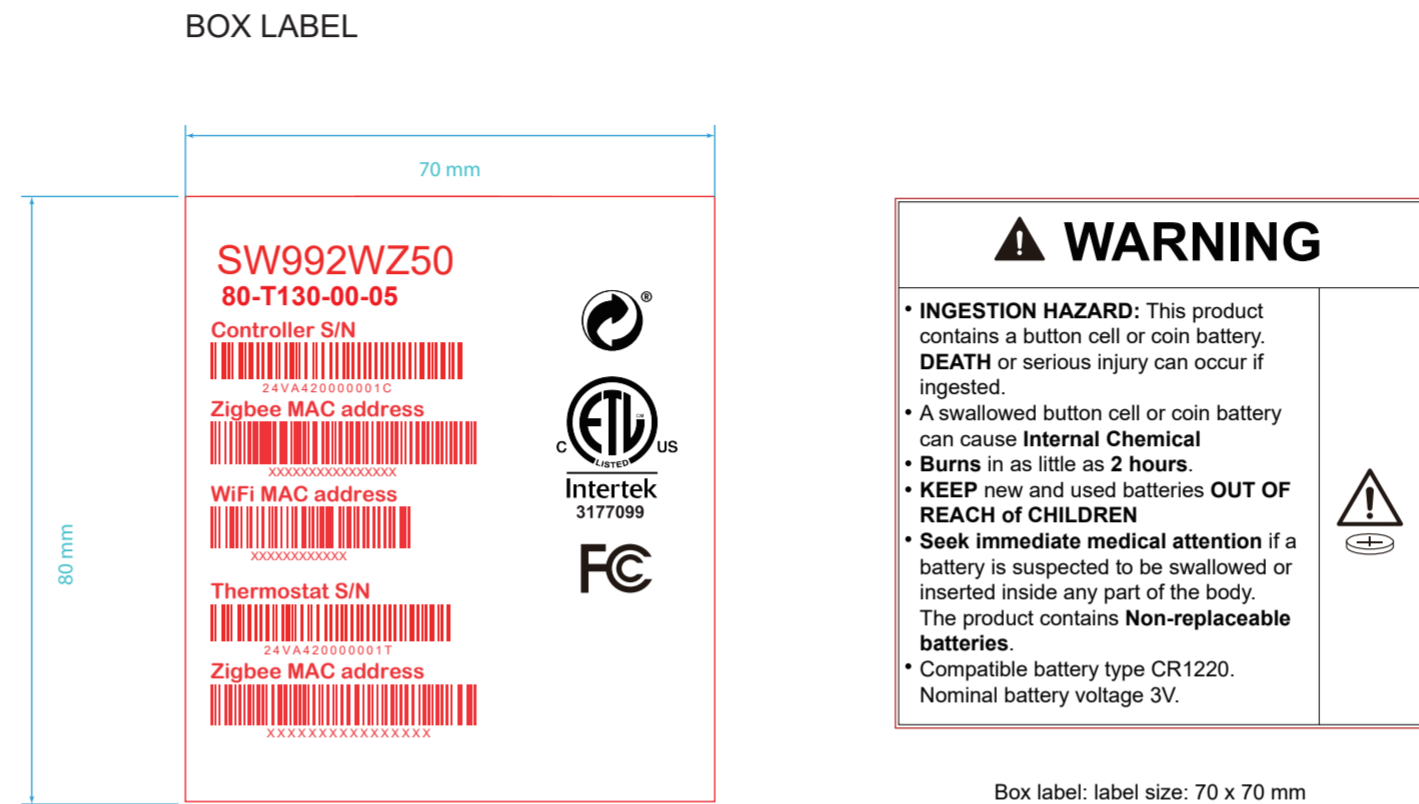

Box label: label size: 80 x 70 mm

Box label: label size: 70 x 70 mm



Label size: 110 x 70 mm

HD-SW992WZ50

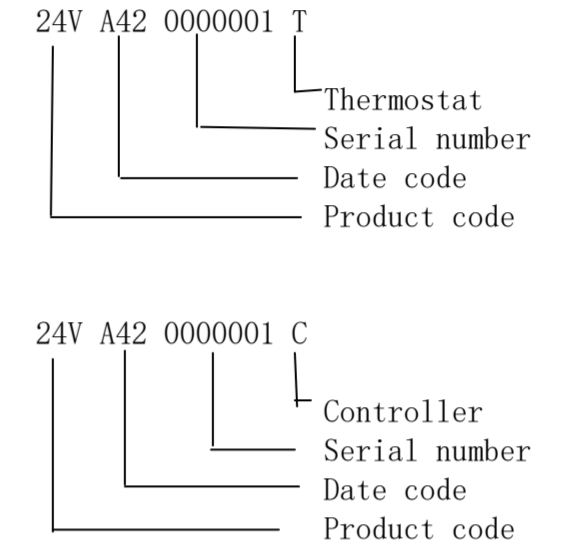

Serial number -> Continued number on all POs
For example, 0000001, 0000002, 0000003..... 0003000(for current order);

Next PO start from 0003001, 0003002.....NNNNNNN;

A39 = Date code
A = 2024, B = 2025, C = 2026, ...; 26 = production week, 生产周数

UNITS LABEL

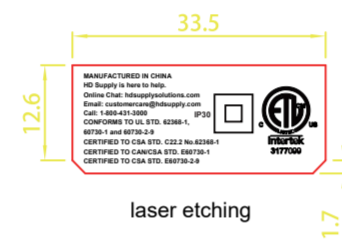
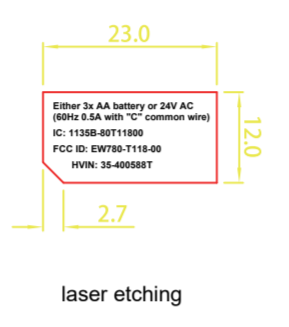
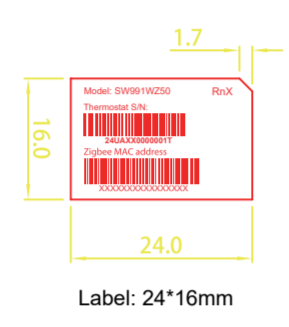
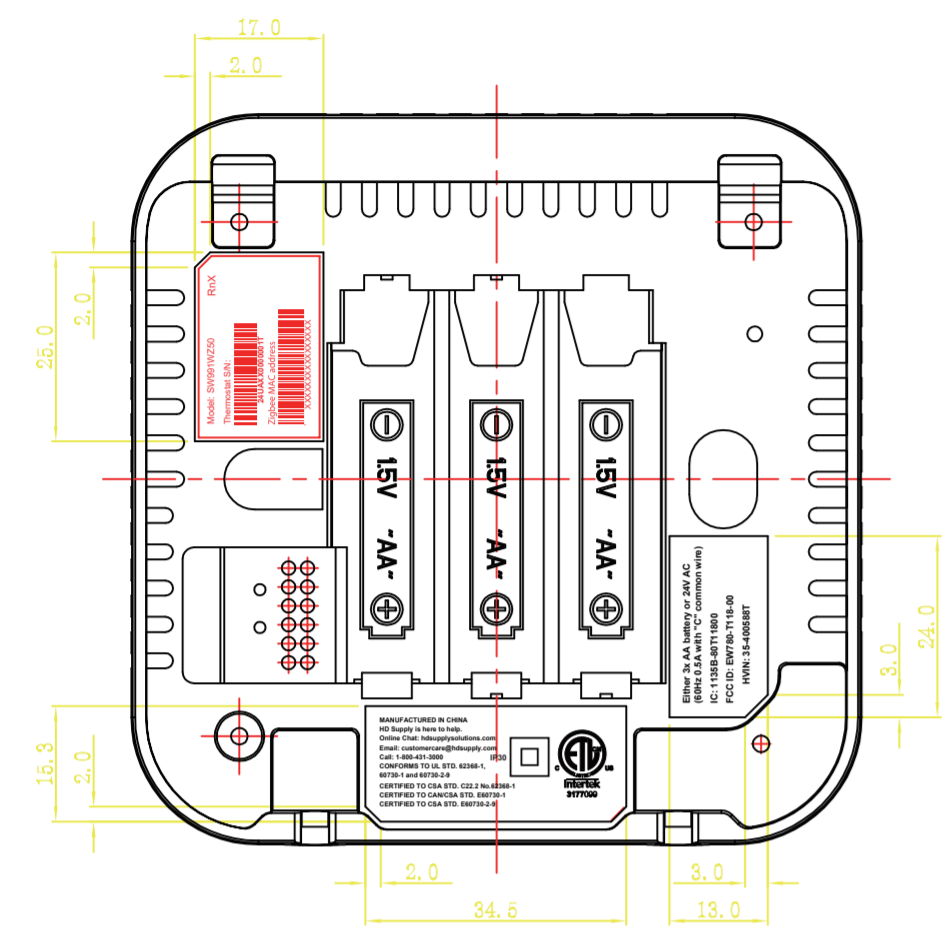

BOX LABEL

BOX LABEL

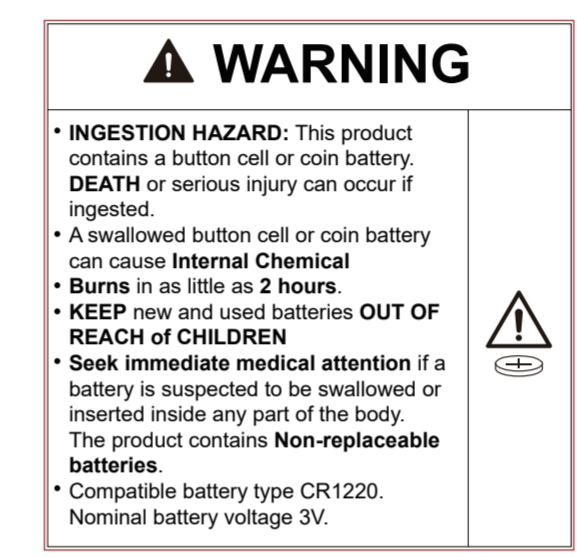
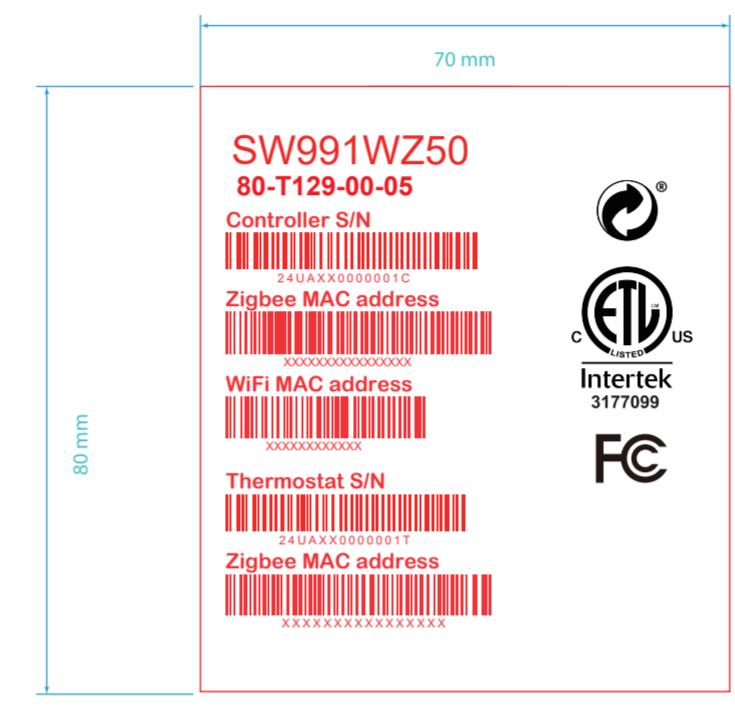

Box label: label size: 80 x 70 mm

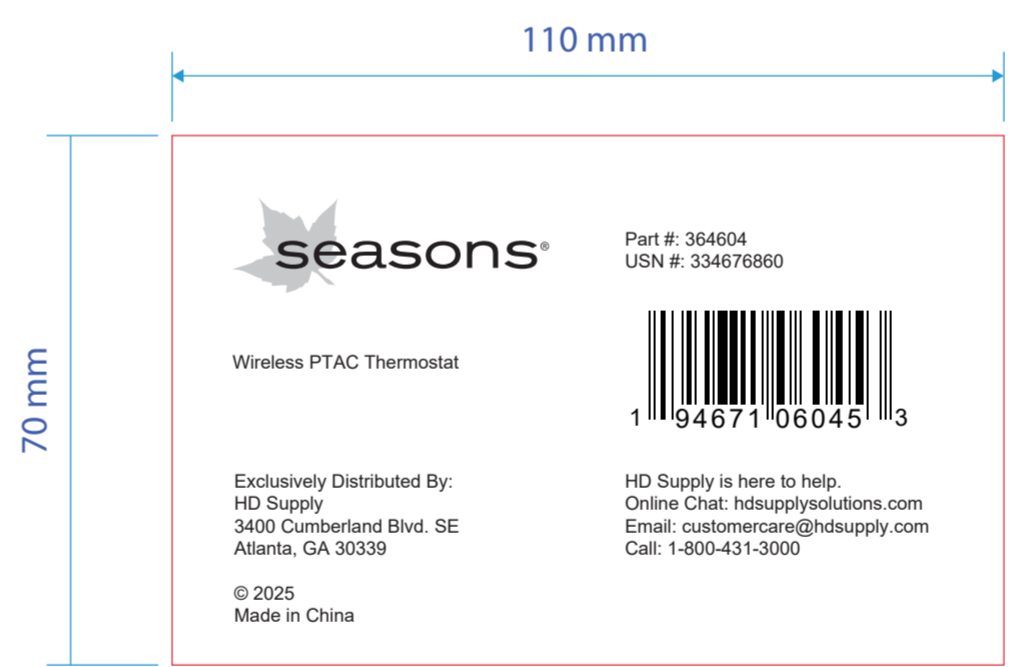

BOX label location

HD-SW991WZ50

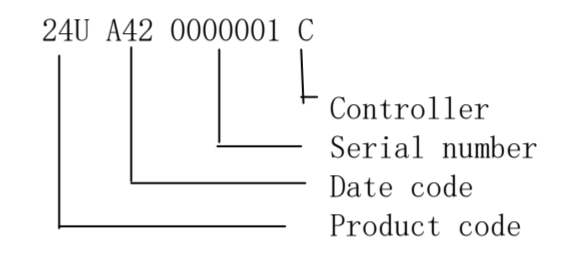
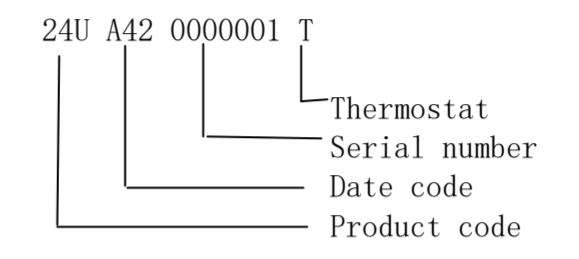

Serial number -> Continued number on all POs
 For example, 0000001, 0000002, 0000003..... 0003000(for current order);

Next PO start from 0003001, 0003002..... NNNNNNN;

A39 = Date code
 A = 2024, B = 2025, C = 2026, ...; 26 = production week, 生产周数