

# TEST REPORT

Applicant Name: FCC: VTech Telecommunications Ltd  
IC: VTECH TELECOMMUNICATIONS LIMITED  
Address: FCC: 23/F Tai Ping Ind Center Block 1 57 Ting Kok Rd Tai Po NT,  
Hong Kong  
IC: BL.1 23/F Tai Ping Industr Ctr. 57 Ting Kok Road Tai Po, NT  
Hongkong  
Report Number: 2501R29557E-RFD  
FCC ID: EW780-S259-00  
IC: 1135B-80S25900

## Test Standard (s)

FCC PART 15.247; RSS-GEN ISSUE 5, FEBRUARY 2021 AMENDMENT 2;  
RSS-247 ISSUE 3, AUGUST 2023

## Sample Description

Product Type: SIP Phone corded  
Model No.: D810WB  
Multiple Model(s) No.: N/A  
Trade Mark: SNOM  
Date Received: 2025-03-04  
Issue Date: 2025-05-22

Test Result:	Pass <sup>▲</sup>
--------------	-------------------

▲ In the configuration tested, the EUT complied with the standards above.

## Prepared and Checked By:

*Ekko Wu*

Ekko Wu  
RF Engineer

## Approved By:

*Nancy Wang*

Nancy Wang  
RF Supervisor

Note: The information marked # is provided by the applicant, the laboratory is not responsible for its authenticity and this information can affect the validity of the result in the test report. Customer model name, addresses, names, trademarks etc. are included.

This report cannot be reproduced except in full, without prior written approval of the Company. Unless otherwise stated the results shown in this test report refer only to the sample(s) tested. This report is valid only with a valid digital signature. The digital signature may be available only under the Adobe software above version 7.0.

This report must not be used by the customer to claim product certification, approval, or endorsement by NVLAP or any agency of the U.S. Government.

This report may contain data that are not covered by the NVLAP accreditation and are marked with an asterisk "▼".

## Bay Area Compliance Laboratories Corp. (Shenzhen)

5F(B-West), 6F, 7F, the 3rd Phase of Wan Li Industrial Building D, Shihua Rd, FuTian Free Trade Zone, Shenzhen, China  
Tel: +86-755-33320018 Fax: +86-755-33320008 www.baclcorp.com.cn

## TABLE OF CONTENTS

<b>DOCUMENT REVISION HISTORY .....</b>	<b>3</b>
<b>GENERAL INFORMATION.....</b>	<b>4</b>
PRODUCT DESCRIPTION FOR EQUIPMENT UNDER TEST (EUT) .....	4
OBJECTIVE .....	4
TEST METHODOLOGY .....	4
MEASUREMENT UNCERTAINTY .....	5
TEST FACILITY .....	5
<b>SYSTEM TEST CONFIGURATION.....</b>	<b>6</b>
<b>SUMMARY OF TEST RESULTS .....</b>	<b>9</b>
<b>TEST EQUIPMENT LIST .....</b>	<b>10</b>
<b>REQUIREMENTS AND TEST PROCEDURES .....</b>	<b>12</b>
AC LINE CONDUCTED EMISSIONS.....	12
UNWANTED EMISSION FREQUENCIES AND RESTRICTED BANDS .....	15
99% OCCUPIED BANDWIDTH & 6 dB EMISSION BANDWIDTH.....	18
PEAK OUTPUT POWER MEASUREMENT .....	21
100 kHz BANDWIDTH OF FREQUENCY BAND EDGE.....	22
POWER SPECTRAL DENSITY .....	23
DUTY CYCLE .....	24
<b>ANTENNA REQUIREMENT .....</b>	<b>25</b>
<b>TEST DATA AND RESULTS.....</b>	<b>26</b>
AC LINE CONDUCTED EMISSIONS.....	26
UNWANTED EMISSION FREQUENCIES AND RESTRICTED BANDS .....	29
6dB EMISSION BANDWIDTH.....	49
99% OCCUPIED BANDWIDTH .....	51
MAXIMUM CONDUCTED OUTPUT POWER .....	53
POWER SPECTRAL DENSITY .....	55
100 kHz BANDWIDTH OF FREQUENCY BAND EDGE.....	57
DUTY CYCLE .....	59
<b>RF EXPOSURE EVALUATION .....</b>	<b>61</b>
<b>EUT PHOTOGRAPHS.....</b>	<b>64</b>
<b>TEST SETUP PHOTOGRAPHS .....</b>	<b>65</b>

## DOCUMENT REVISION HISTORY

Revision Number	Report Number	Description of Revision	Date of Revision
0	2501R29557E-RFD	Original Report	2025-05-22

## GENERAL INFORMATION

### Product Description for Equipment under Test (EUT)

<b>HVIN</b>	35-400546A
<b>FVIN</b>	V10.1.198.16
<b>Frequency Range</b>	2402~2480MHz
<b>Maximum Conducted Output Peak Power</b>	8.86dBm
<b>Modulation Technique</b>	GFSK
<b>Antenna Specification<sup>#</sup></b>	0dBi (provided by the applicant)
<b>Voltage Range</b>	DC 5V from adapter or DC 48V from PoE
<b>Sample serial number</b>	2Z6F-3 for Radiated Emissions and Conducted Emission Test 2Z6F-11 for RF Conducted Test (Assigned by BACL, Shenzhen)
<b>Sample/EUT Status</b>	Good condition
<b>Adapter Information</b>	Adapter 1 Model: NBS12E050200UV Input: AC 100-240V, 50/60Hz, 0.3A Output: DC 5.0V, 2.0A, 10.0W Adapter 2 Model: VT07EUS05200 Input: AC 100-240V, 50/60Hz, 0.5A Output: DC 5.0V, 2.0A, 10.0W
Note 1: For the AC line conducted emission test, the adapter 1 was chosen for the test according to the worst test data mode in the DSS report.	
Note 2: For the radiated emission below 1GHz, the PoE supply was chosen for the test according to the worst test data mode in the DSS report.	

### Objective

This test report is in accordance with Part 2-Subpart J, Part 15-Subparts A and C of the Federal Communication Commissions rules and RSS-247 Issue 3, August 2023, RSS-GEN Issue 5, Feb. 2021 Amendment 2 of the Innovation, Science and Economic Development Canada rules.

### Test Methodology

All measurements contained in this report were conducted with ANSI C63.10-2020, American National Standard of Procedures for Compliance Testing of Unlicensed Wireless Devices, RSS-GEN Issue 5, February 2021 Amendment 2 and RSS-247 Issue 3, August 2023.

And KDB 558074 D01 15.247 Meas Guidance v05r02.

All emissions measurement was performed at Bay Area Compliance Laboratories Corp. (Shenzhen). The radiated testing was performed at an antenna-to-EUT distance of 3 meters.

Each test item follows test standards and with no deviation.

**Measurement Uncertainty**

Parameter		Uncertainty
Occupied Channel Bandwidth		109.2kHz(k=2, 95% level of confidence)
RF output power, conducted		0.86dB(k=2, 95% level of confidence)
Power Spectral Density		0.90dB(k=2, 95% level of confidence)
AC Power Lines Conducted Emissions	9kHz~150 kHz	3.63dB(k=2, 95% level of confidence)
	150 kHz ~30MHz	3.66dB(k=2, 95% level of confidence)
Radiated Emissions	0.009MHz~30MHz	3.60dB(k=2, 95% level of confidence)
	30MHz~200MHz (Horizontal)	5.32dB(k=2, 95% level of confidence)
	30MHz~200MHz (Vertical)	5.43dB(k=2, 95% level of confidence)
	200MHz~1000MHz (Horizontal)	5.77dB(k=2, 95% level of confidence)
	200MHz~1000MHz (Vertical)	5.73dB(k=2, 95% level of confidence)
	1GHz - 6GHz	5.34dB(k=2, 95% level of confidence)
	6GHz - 18GHz	5.40dB(k=2, 95% level of confidence)
18GHz - 40GHz	5.64dB(k=2, 95% level of confidence)	
Temperature		±1°C
Humidity		±1%
Supply voltages		±0.4%

*Note: The extended uncertainty given in this report is obtained by combining the standard uncertainty times the coverage factor K with the 95% confidence interval. Otherwise required by the applicant or Product Regulations, Decision Rule in this report did not consider the uncertainty.*

**Test Facility**

The Test site used by Bay Area Compliance Laboratories Corp. (Shenzhen) to collect test data is located on the 5F(B-West) , 6F, 7F, the 3rd Phase of Wan Li Industrial Building D, Shihua Rd, FuTian Free Trade Zone, Shenzhen, China.

The lab has been recognized as the FCC accredited lab under the KDB 974614 D01 and is listed in the FCC Public Access Link (PAL) database, FCC Registration No. : 715558, the FCC Designation No. : CN5045.

The lab has been recognized by Innovation, Science and Economic Development Canada to test to Canadian radio equipment requirements, the CAB identifier: CN0023.

## SYSTEM TEST CONFIGURATION

### Description of Test Configuration

For BLE mode, 40 channels are provided to testing:

Channel	Frequency (MHz)	Channel	Frequency (MHz)
0	2402	20	2442
1	2404	21	2444
2	2406	22	2446
3	2408	23	2448
4	2410	24	2450
5	2412	25	2452
6	2414	26	2454
7	2416	27	2456
8	2418	28	2458
9	2420	29	2460
10	2422	30	2462
11	2424	31	2464
12	2426	32	2466
13	2428	33	2468
14	2430	34	2470
15	2432	35	2472
16	2434	36	2474
17	2436	37	2476
18	2438	38	2478
19	2440	39	2480

EUT was tested with Channel 0, 19 and 39.

### EUT Exercise Software

Exercise Software <sup>#</sup>	BlueTest3		
	Power Level <sup>#</sup>		
Mode	Low Channel	Middle Channel	High Channel
BLE 1M	6	6	6

### Special Accessories

No special accessory.

### Equipment Modifications

No modification was made to the EUT tested.

**Support Equipment List and Details**

Manufacturer	Description	Model	Serial Number
DELL	PC	Latitude E5430	37K4X AOO
HIKVISION	Router	DS-3WR03	10021642429
GOSPEL	PoE	G0720-480-050	200200019
Fanvil	IP Phone	J66	Unknown
SUOSHI	USB disk	Unknown	Unknown
Snom	earphone	A100D	100D4342013597

**External I/O Cable**

Cable Description	Length (m)	From Port	To
Un-shielded Un-detachable AC Cable	1.5	Receptacle	LISN/AC Mains
Un-shielded Un-detachable DC Cable	1.5	Adapter	EUT
Un-shielded Detachable Audio Cable	1.0	EUT	Earphone
Un-shielded Detachable RJ45 Cable	5.0	EUT	PC
Un-shielded Detachable RJ45 Cable	5.0	EUT	Router
Un-shielded Detachable RJ45 Cable	5.0	EUT	IP Phone
Un-shielded Detachable AC Cable	0.3	Receptacle	PoE
Un-shielded Detachable RJ45 Cable	1.0	PoE	EUT

**Block Diagram of Test Setup**

For Conducted Emissions:

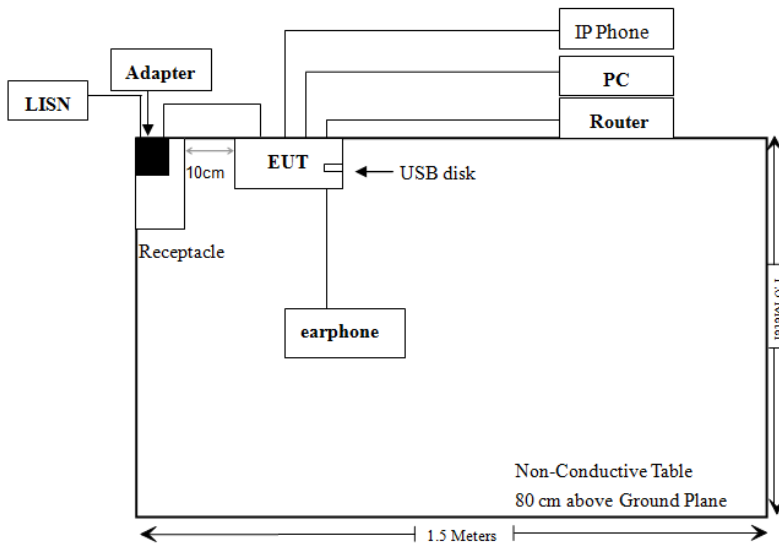

For Radiated Emissions below 1GHz:

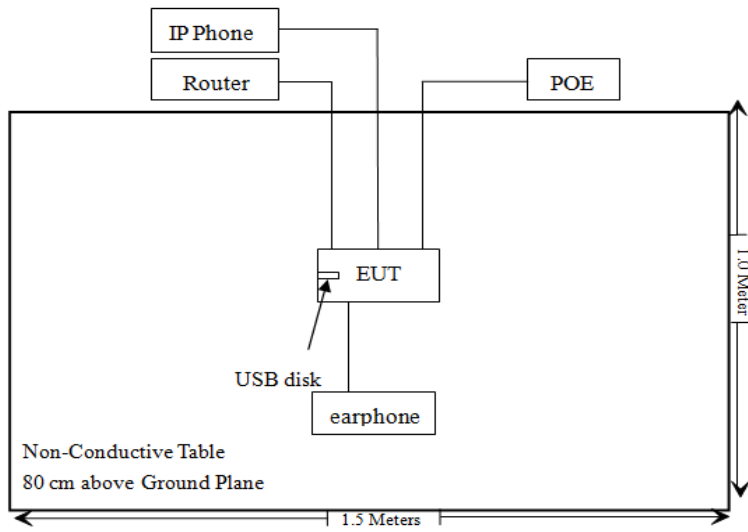

For Radiated Emissions Above 1GHz:

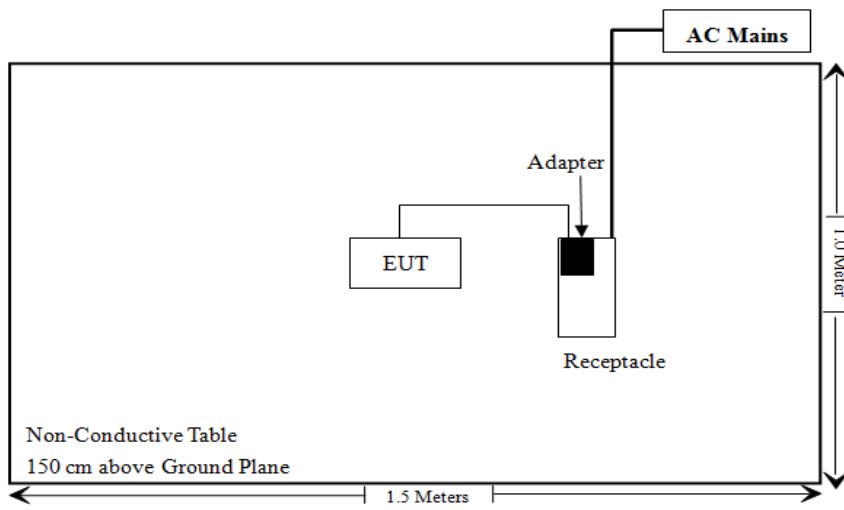

## SUMMARY OF TEST RESULTS

FCC Rules	RSS Rules	Description of Test	Result
§15.203	RSS-Gen §6.8	Antenna Requirement	Compliant
§15.207 (a)	RSS-Gen §8.8	AC Line Conducted Emissions	Compliant
§15.205, §15.209, §15.247(d)	RSS-GEN § 8.10 & RSS-247 § 5.5	Radiated Spurious Emission	Compliant
§15.247 (a)(2)	RSS- Gen§6.7 RSS-247 § 5.2 (a)	6dB Emission Bandwidth & 99% Occupied Bandwidth	Compliant
§15.247(b)(3)	RSS-247 § 5.4(d)	Maximum Conducted Output Power	Compliant
§15.247(d)	RSS-247 § 5.5	100 kHz Bandwidth of Frequency Band Edge	Compliant
§15.247(e)	RSS-247 § 5.2 (b)	Power Spectral Density	Compliant
C63.10 §11.6	C63.10 §11.6	Duty Cycle	/
§1.1307(b) (3), §2.1091	RSS-102 §6.6	MPE-Based Exemption & Field reference level exposure exemption limits	Compliant

**TEST EQUIPMENT LIST**

Manufacturer	Description	Model	Serial Number	Calibration Date	Calibration Due Date
<b>Conducted Emission Test</b>					
Rohde & Schwarz	EMI Test Receiver	ESCI	101120	2024/12/04	2025/12/03
Rohde & Schwarz	LISN	ENV216	101613	2024/12/04	2025/12/03
Unknown	CE Cable	Unknown	UF A210B-1-0720-504504	2024/05/21	2025/05/20
Rohde & Schwarz	Transient Limiter	ESH3Z2	DE25985	2024/05/21	2025/05/20
Audix	EMI Test software	E3	19821b(V9)	NCR	NCR
<b>Radiated Emission Test</b>					
Rohde & Schwarz	EMI Test Receiver	ESR3	102455	2024/12/04	2025/12/03
Sonoma instrument	Pre-amplifier	310N	186238	2024/05/21	2025/05/20
Sunol Sciences	Broadband Antenna	JB1	A040904-1	2023/07/20	2026/07/19
Unknown	Cable	XH500C	J-10M-A	2024/06/18	2025/06/17
Unknown	Cable	Chamber Cable 1	F-03-EM236	2024/06/18	2025/06/17
BACL	Active Loop Antenna	1313-1A	4031911	2024/05/14	2027/05/13
Unknown	Cable	PNG214	1354	2024/12/04	2025/12/03
Unknown	Cable	2Y194	0735	2024/12/04	2025/12/03
Audix	EMI Test software	E3	19821b(V9)	NCR	NCR
Rohde & Schwarz	Spectrum Analyzer	FSV40	101605	2025/03/26	2026/03/25
A.H.System	Preamplifier	PAM-0118P	489	2024/11/15	2025/11/14
Schwarzbeck	Horn Antenna	BBHA9120D(1201)	1143	2023/07/26	2026/07/25
Unknown	RF Cable	KMSE	0735	2024/12/06	2025/12/05
Unknown	RF Cable	UFA147	219661	2024/12/06	2025/12/05
JD	Filter Switch Unit	DT7220FSU	DS79906	2024/09/09	2025/09/08
JD	Multiplex Switch Test Control Set	DT7220SCU	DS79903	2024/09/09	2025/09/08
A.H.System	Pre-amplifier	PAM-1840VH	190	2024/06/18	2025/06/17
Electro-Mechanics Co	Horn Antenna	3116	9510-2270	2023/09/18	2026/09/17
UTIFLEX	RF Cable	NO. 13	232308-001	2024/12/18	2025/12/17
Audix	EMI Test software	E3	19821b(V9)	NCR	NCR

Manufacturer	Description	Model	Serial Number	Calibration Date	Calibration Due Date
<b>RF Conducted Test</b>					
Rohde & Schwarz	Spectrum Analyze	FSU26	200982	2024/09/20	2025/09/19
Unknown	10dB Attenuator	Unknown	F-03-EM190	2024/06/27	2025/06/26

\* **Statement of Traceability:** Bay Area Compliance Laboratories Corp. (Shenzhen) attests that all calibrations have been performed in accordance to requirements that traceable to National Primary Standards and International System of Units (SI).

## REQUIREMENTS AND TEST PROCEDURES

### AC Line Conducted Emissions

#### Applicable Standard

FCC§15.207 (a) & RSS-GEN §8.8

Unless stated otherwise in the applicable RSS, for radio apparatus that are designed to be connected to the public utility AC power network, the radio frequency voltage that is conducted back onto the AC power line on any frequency or frequencies within the range 150 kHz to 30 MHz shall not exceed the limits in table 4, as measured using a 50  $\mu$ H / 50  $\Omega$  line impedance stabilization network. This requirement applies for the radio frequency voltage measured between each power line and the ground terminal of each AC power-line mains cable of the EUT.

For an EUT that connects to the AC power lines indirectly, through another device, the requirement for compliance with the limits in table 4 shall apply at the terminals of the AC power-line mains cable of a representative support device, while it provides power to the EUT. The lower limit applies at the boundary between the frequency ranges. The device used to power the EUT shall be representative of typical applications.

Table 4 - AC Power Lines Conducted Emission Limits		
Frequency range (MHz)	Conducted limit (dB $\mu$ V)	
	Quasi-Peak	Average
0.15 – 0.5	66 to 56 <sup>1</sup>	56 to 46 <sup>1</sup>
0.5 – 5	56	46
5 – 30	60	50

**Note 1:** The level decreases linearly with the logarithm of the frequency.

For an EUT with a permanent or detachable antenna operating between 150 kHz and 30 MHz, the AC power-line conducted emissions must be measured using the following configurations:

(a) Perform the AC power-line conducted emissions test with the antenna connected to determine compliance with the limits of table 4 outside the transmitter's fundamental emission band.

(b) Retest with a dummy load instead of the antenna to determine compliance with the limits of table 4 within the transmitter's fundamental emission band. For a detachable antenna, remove the antenna and connect a suitable dummy load to the antenna connector. For a permanent antenna, remove the antenna and terminate the RF output with a dummy load or network that simulates the antenna in the fundamental frequency band.

**EUT Setup**

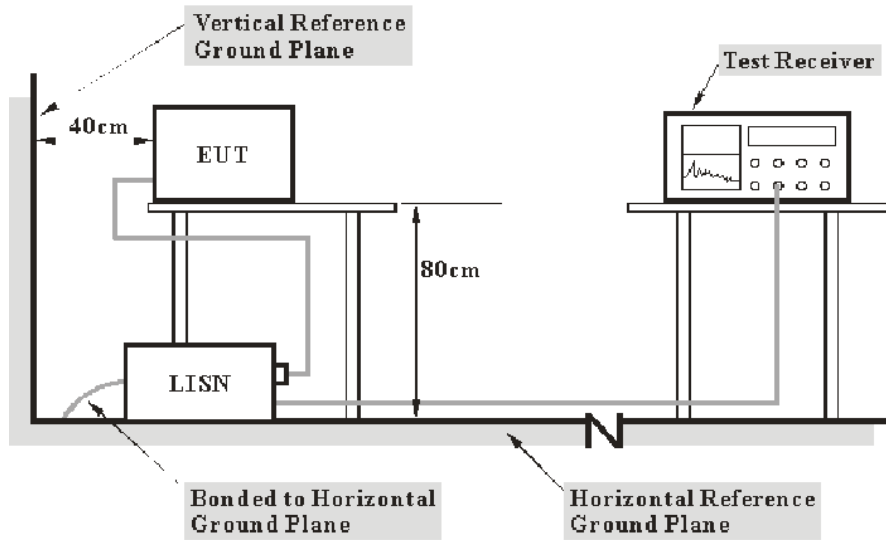

- Note: 1. Support units were connected to second LISN.  
 2. Both of LISNs (AMN) 80 cm from EUT and at the least 80 cm from other units and other metal planes support units.

The setup of EUT is according with per ANSI C63.10-2020 measurement procedure. The specification used was with the FCC Part 15.207 & RSS-247/RSS-Gen limits.

The spacing between the peripherals was 10 cm.

The external I/O cables were draped along the test table and formed a bundle 30 to 40 cm long in the middle.

**EMI Test Receiver Setup**

The EMI test receiver was set to investigate the spectrum from 150 kHz to 30 MHz.

During the conducted emission test, the EMI test receiver was set with the following configurations:

Frequency Range	RBW
150 kHz – 30 MHz	9 kHz

**Test Procedure**

Maximizing procedure was performed on the six (6) highest emissions of the EUT.

All final data was recorded in the Quasi-peak and average detection mode.

**Factor & Over Limit Calculation**

The factor is calculated by adding LISN VDF (Voltage Division Factor) and Cable Loss. The basic equation is as follows:

$$\text{Factor} = \text{LISN VDF} + \text{Cable Loss}$$

The “**Over limit**” column of the following data tables indicates the degree of compliance with the applicable limit. For example, an Over limit of -7 dB means the emission is 7 dB below the limit. The equation for calculation is as follows:

$$\begin{aligned}\text{Over Limit} &= \text{Level} - \text{Limit} \\ \text{Level} &= \text{Read Level} + \text{Factor}\end{aligned}$$

Note: The term "cable loss" refers to the combination of a cable and a 10dB transient limiter (attenuator).

### Unwanted Emission Frequencies and Restricted Bands

#### Applicable Standard

FCC §15.247 (d); §15.209; §15.205; RSS-247 §5.5, RSS-GEN §8.10.

#### EUT Setup

9 kHz-30MHz:

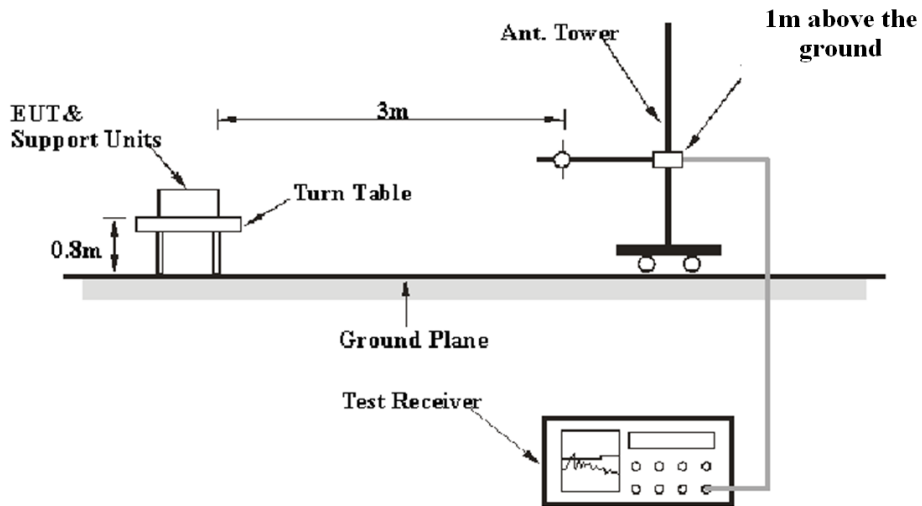

30MHz-1GHz:

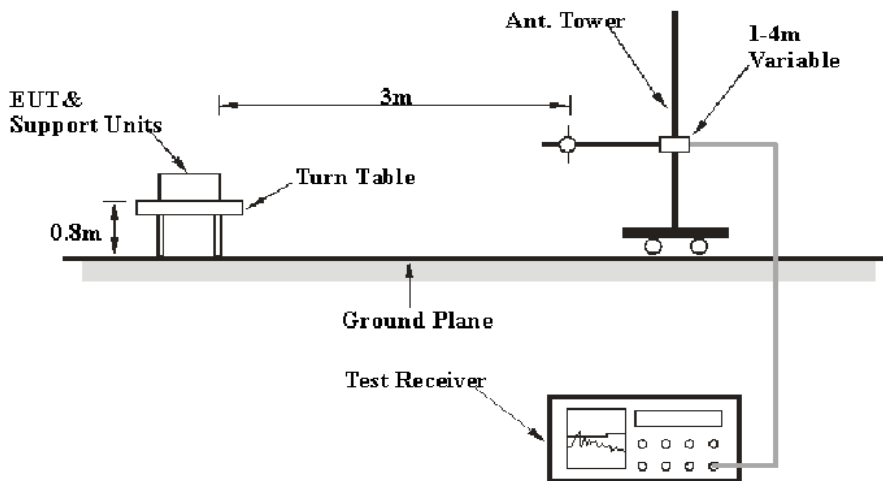

**Above 1GHz:**

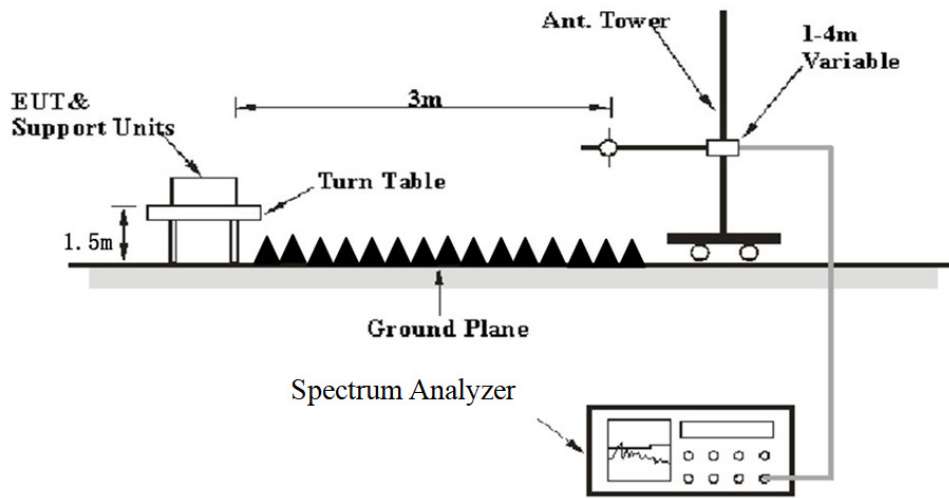

The radiated emission tests were performed in the 3meters test site, using the setup accordance with the ANSI C63.10-2020. The specification used was the FCC 15.205, FCC 15.209, FCC 15.247, RSS-Gen and RSS-247 limits.

The external I/O cables were draped along the test table and formed a bundle 30 to 40 cm long in the middle.

**EMI Test Receiver & Spectrum Analyzer Setup**

The system was investigated from 9 kHz to 25 GHz.

During the radiated emission test, the EMI test receiver & Spectrum Analyzer Setup were set with the following configurations:

9 kHz-1GHz:

Frequency Range	RBW	Video B/W	IF B/W	Measurement	Detector
9 kHz – 150 kHz	/	/	200 Hz	QP	QP
	300 Hz	1 kHz	/	PK	Peak
150 kHz – 30 MHz	/	/	9 kHz	QP	QP
	10 kHz	30 kHz	/	PK	Peak
30 MHz – 1000 MHz	/	/	120 kHz	QP	QP
	100 kHz	300 kHz	/	PK	Peak

1-25GHz:  
Pre-scan

Measurement	Duty cycle	RBW	Video B/W	Detector
PK	Any	1MHz	3 MHz	Peak
AV	>98%	1MHz	1 kHz	Peak
	<98%	1MHz	≥1/Ton	Peak

Final measurement for emission identified during pre-scan

Measurement	Duty cycle	RBW	Video B/W	Detector
PK	Any	1MHz	3 MHz	Peak
AV	>98%	1MHz	10 Hz	Peak
	<98%	1MHz	≥1/Ton	Peak

Note: Ton is minimum transmission duration

If the maximized peak measured value complies with under the QP/Average limit more than 6dB, then it is unnecessary to perform an QP/Average measurement.

**Test Procedure**

Maximizing procedure was performed on the highest emissions to ensure that the EUT complied with all installation combinations.

All final data was recorded in Quasi-peak detection mode except for the frequency bands 9–90 kHz, 110–490 kHz and above 1000 MHz, average detection modes for frequency bands 9–90 kHz and 110–490 kHz, peak and average detection modes for frequencies above 1 GHz.

For 9 kHz-30MHz, the report shall list the six emissions with the smallest margin relative to the limit, for each of the three antenna orientations (parallel, perpendicular, and ground-parallel) unless the margin is greater than 20 dB.

All emissions under the average limit and under the noise floor have not recorded in the report.

**Factor & Over Limit/Margin Calculation**

The Factor is calculated by adding the Antenna Factor and Cable Loss, and subtracting the Amplifier Gain. The basic equation is as follows:

$$\text{Factor} = \text{Antenna Factor} + \text{Cable Loss} - \text{Amplifier Gain}$$

The “**Over Limit/Margin**” column of the following data tables indicates the degree of compliance with the applicable limit. For example, an Over Limit/margin of -7dB means the emission is 7dB below the limit. The equation for calculation is as follows:

$$\text{Over Limit/Margin} = \text{Level} / \text{Corrected Amplitude} - \text{Limit}$$

$$\text{Level} / \text{Corrected Amplitude} = \text{Read Level} + \text{Factor}$$

## 99% Occupied Bandwidth & 6 dB Emission Bandwidth

### Standard Applicable

According to FCC §15.247(a) (2)

Systems using digital modulation techniques may operate in the 902–928 MHz, 2400–2483.5 MHz, and 5725–5850 MHz bands. The minimum 6 dB bandwidth shall be at least 500 kHz.

According to RSS-247 §5.2 a)

The minimum 6 dB bandwidth shall be 500 kHz.

According to RSS-Gen §6.7

The occupied bandwidth or the “99% emission bandwidth” is defined as the frequency range between two points, one above and the other below the carrier frequency, within which 99% of the total transmitted power of the fundamental transmitted emission is contained. The occupied bandwidth shall be reported for all equipment in addition to the specified bandwidth required in the applicable RSSs.

In some cases, the “x dB bandwidth” is required, which is defined as the frequency range between two points, one at the lowest frequency below and one at the highest frequency above the carrier frequency, at which the maximum power level of the transmitted emission is attenuated x dB below the maximum in-band power level of the modulated signal, where the two points are on the outskirts of the in-band emission.

The following conditions shall be observed for measuring the occupied bandwidth and x dB bandwidth:

- The transmitter shall be operated at its maximum carrier power measured under normal test conditions.
- The span of the spectrum analyzer shall be set large enough to capture all products of the modulation process, including the emission skirts, around the carrier frequency, but small enough to avoid having other emissions (e.g. on adjacent channels) within the span.
- The detector of the spectrum analyzer shall be set to “Sample”. However, a peak, or peak hold, may be used in place of the sampling detector since this usually produces a wider bandwidth than the actual bandwidth (worst-case measurement). Use of a peak hold (or “Max Hold”) may be necessary to determine the occupied / x dB bandwidth if the device is not transmitting continuously.
- The resolution bandwidth (RBW) shall be in the range of 1% to 5% of the actual occupied / x dB bandwidth and the video bandwidth (VBW) shall not be smaller than three times the RBW value. Video averaging is not permitted.

Note: It may be necessary to repeat the measurement a few times until the RBW and VBW are in compliance with the above requirement.

For the 99% emission bandwidth, the trace data points are recovered and directly summed in linear power level terms. The recovered amplitude data points, beginning at the lowest frequency, are placed in a running sum until 0.5% of the total is reached, and that frequency recorded. The process is repeated for the highest frequency data points (starting at the highest frequency, at the right side of the span, and going down in frequency). This frequency is then recorded. The difference between the two recorded frequencies is the occupied bandwidth (or the 99% emission bandwidth).

**Test Procedure**

Test Method: ANSI C63.10-2020 Clause 11.8.1 & Clause 6.9.3

The steps for the first option are as follows:

- a) Set RBW = shall be in the range of 1% to 5% of the OBW but not less than 100 kHz.
- b) Set the VBW  $\geq [3 \times \text{RBW}]$ .
- c) Detector = peak.
- d) Trace mode = max-hold.
- e) Sweep = No faster than coupled (auto) time.
- f) Allow the trace to stabilize.
- g) Measure the maximum width of the emission by placing two markers, one at the lowest frequency and the other at the highest frequency of the envelope of the spectral display, such that each marker is at or slightly below the “-6 dB down amplitude”. If a marker is below this “-6 dB down amplitude” value, then it shall be as close as possible to this value.

The occupied bandwidth is the frequency bandwidth such that, below its lower and above its upper frequency limits, the mean powers are each equal to 0.5% of the total mean power of the given emission. The following procedure shall be used for measuring 99% power bandwidth:

- a) The instrument center frequency is set to the nominal EUT channel center frequency. The frequency span for the spectrum analyzer shall be between 1.5 times and 5.0 times the OBW.
- b) The nominal IF filter bandwidth (3 dB RBW) shall be in the range of 1% to 5% of the OBW, and VBW shall be at least three times the RBW, unless otherwise specified by the applicable requirement.
- c) Set the reference level of the instrument as required, keeping the signal from exceeding the maximum input mixer level for linear operation. In general, the peak of the spectral envelope shall be more than  $[10 \log (\text{OBW}/\text{RBW})]$  below the reference level. Specific guidance is given in 4.1.6.2.
- d) Step a) through step c) might require iteration to adjust within the specified range.
- e) Video averaging is not permitted. Where practical, a sample detection and single sweep mode shall be used. Otherwise, peak detection and max-hold mode (until the trace stabilizes) shall be used.
- f) Use the 99% power bandwidth function of the instrument (if available) and report the measured bandwidth.
- g) If the instrument does not have a 99% power bandwidth function, then the trace data points are recovered and directly summed in linear power terms. The recovered amplitude data points, beginning at the lowest frequency, are placed in a running sum until 0.5% of the total is reached; that frequency is recorded as the lower frequency. The process is repeated until 99.5% of the total is reached; that frequency is recorded as the upper frequency. The 99% power bandwidth is the difference between these two frequencies.

h) The occupied bandwidth shall be reported by providing spectral plot(s) of the measuring instrument display; the plot axes and the scale units per division shall be clearly labeled. Tabular data may be reported in addition to the plot(s).

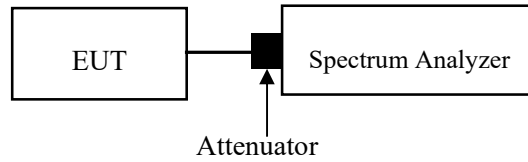

## Peak Output Power Measurement

### Applicable Standard

According to FCC §15.247(b) (3), for systems using digital modulation in the 902-928 MHz, 2400-2483.5 MHz, and 5725-5850 MHz bands: 1 Watt. As an alternative to a peak power measurement, compliance with the one Watt limit can be based on a measurement of the maximum conducted output power. Maximum Conducted Output Power is defined as the total transmit power delivered to all antennas and antenna elements averaged across all symbols in the signaling alphabet when the transmitter is operating at its maximum power control level. Power must be summed across all antennas and antenna elements. The average must not include any time intervals during which the transmitter is off or is transmitting at a reduced power level. If multiple modes of operation are possible (e.g., alternative modulation methods), the maximum conducted output power is the highest total transmit power occurring in any mode.

According to RSS-247§5.4 d) For DTSs employing digital modulation techniques operating in the bands 902-928 MHz and 2400-2483.5 MHz, the maximum peak conducted output power shall not exceed 1 W. Except as provided in Section 5.4(e), the e.i.r.p. shall not exceed 4 W.

As an alternative to a peak power measurement, compliance can be based on a measurement of the maximum conducted output power. The maximum conducted output power is the total transmit power delivered to all antennas and antenna elements, averaged across all symbols in the signalling alphabet when the transmitter is operating at its maximum power control level. Power must be summed across all antennas and antenna elements. The average must not include any time intervals during which the transmitter is off or transmitting at a reduced power level. If multiple modes of operation are implemented, the maximum conducted output power is the highest total transmit power occurring in any mode.

### Test Procedure

Test Method: ANSI C63.10-2020 Clause 11.9.1.1

The following procedure shall be used when an instrument with a resolution bandwidth that is greater than the DTS bandwidth is available to perform the measurement:

- a) Set the RBW  $\geq$  DTS bandwidth.
- b) Set VBW  $\geq$   $[3 \times \text{RBW}]$ .
- c) Set span  $\geq$   $[3 \times \text{RBW}]$ .
- d) Sweep time = No faster than coupled (auto) time.
- e) Detector = peak.
- f) Trace mode = max-hold.
- g) Allow trace to fully stabilize.
- h) Use peak marker function to determine the peak amplitude level.

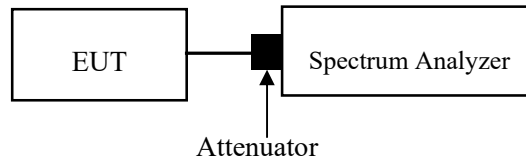

Note: A short RF cable with low cable loss connected to the EUT antenna port, which was provided by client or lab, the cable loss was added with offset into test equipment, the total offset consists of attenuator and/or RF cable loss

## 100 kHz Bandwidth of Frequency Band Edge

### Applicable Standard

In any 100 kHz bandwidth outside the frequency band in which the spread spectrum or digitally modulated intentional radiator is operating, the radio frequency power that is produced by the intentional radiator shall be at least 20 dB below that in the 100 kHz bandwidth within the band that contains the highest level of the desired power, based on either an RF conducted or a radiated measurement, provided the transmitter demonstrates compliance with the peak conducted power limits. If the transmitter complies with the conducted power limits based on the use of RMS averaging over a time interval, as permitted under paragraph (b)(3) of this section, the attenuation required under this paragraph shall be 30 dB instead of 20 dB. Attenuation below the general limits specified in §15.209(a) is not required. In addition, radiated emissions which fall in the restricted bands, as defined in §15.205(a), must also comply with the radiated emission limits specified in §15.209(a) (see §15.205(c)).

In any 100 kHz bandwidth outside the frequency band in which the spread spectrum or digitally modulated device is operating, the RF power that is produced shall be at least 20 dB below that in the 100 kHz bandwidth within the band that contains the highest level of the desired power, based on either an RF conducted or a radiated measurement, provided that the transmitter demonstrates compliance with the peak conducted power limits. If the transmitter complies with the conducted power limits based on the use of root-mean-square averaging over a time interval, as permitted under section 5.4(d), the attenuation required shall be 30 dB instead of 20 dB. Attenuation below the general field strength limits specified in RSS-Gen is not required

### Test Procedure

Test Method: ANSI C63.10-2020 Clause 11.11.3

Establish an emission level by using the following procedure:

- a) Set the center frequency and span to encompass frequency range to be measured. Note that the frequency range might need to be divided into multiple frequency ranges to retain frequency resolution.

NOTE—the number of points can also be increased for large spans to retain frequency resolution

- b) Set the RBW = 100 kHz.
- c) Set the VBW  $\geq [3 \times \text{RBW}]$ .
- d) Detector = peak.
- e) Sweep time = No faster than coupled (auto) time.
- f) Trace mode = max-hold.
- g) Allow trace to fully stabilize.
- h) Use the peak marker function to determine the maximum amplitude level.

Ensure that the amplitude of all unwanted emissions outside of the authorized frequency band (excluding restricted frequency bands) is attenuated by at least the minimum requirements specified in 11.11. Report the three highest emissions relative to the limit.

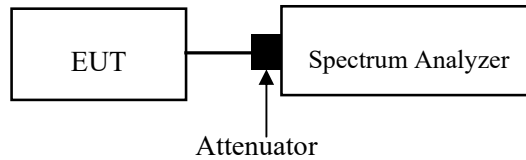

## Power Spectral Density

### Applicable Standard

According to FCC §15.247(e):

For digitally modulated systems, the power spectral density conducted from the intentional radiator to the antenna shall not be greater than 8 dBm in any 3 kHz band during any time interval of continuous transmission. This power spectral density shall be determined in accordance with the provisions of paragraph (b) of this section. The same method of determining the conducted output power shall be used to determine the power spectral density.

According to RSS-247 §5.2 b):

The transmitter power spectral density conducted from the transmitter to the antenna shall not be greater than 8 dBm in any 3 kHz band during any time interval of continuous transmission. This power spectral density shall be determined in accordance with the provisions of section 5.4(d), (i.e. the power spectral density shall be determined using the same method as is used to determine the conducted output power)

### Test Procedure

Test Method: ANSI C63.10-2020 Clause 11.10.2

The following procedure shall be used if maximum peak conducted output power was used to determine compliance, and it is optional if the maximum conducted (average) output power was used to determine compliance:

- a) Set analyzer center frequency to DTS channel center frequency.
- b) Set the span  $>1.5$  times the DTS bandwidth.
- c) Set the RBW to  $3 \text{ kHz} \leq \text{RBW} \leq 100 \text{ kHz}$ .
- d) Set the VBW  $\geq [3 \times \text{RBW}]$ .
- e) Detector = peak.
- f) Sweep time = No faster than coupled (auto) time.
- g) Trace mode = max-hold.
- h) Allow trace to fully stabilize.
- i) Use the peak marker function to determine the maximum amplitude level within the RBW.

j) If measured value exceeds requirement, then reduce RBW (but no less than 3 kHz) and repeat.

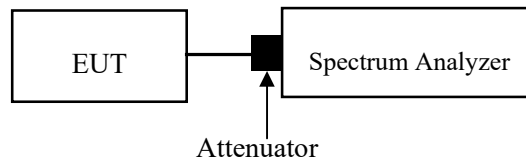

Note: A short RF cable with low cable loss connected to the EUT antenna port, which was provided by client or lab, the cable loss was added with offset into test equipment, the total offset consists of attenuator and/or RF cable loss

## Duty Cycle

### Test Procedure

According to ANSI C63.10-2020 Section 11.6

Measurements of duty cycle and transmission duration shall be performed using one of the following techniques:

- a) A diode detector and an oscilloscope that together have a sufficiently short response time to permit accurate measurements of the ON and OFF times of the transmitted signal.
- b) The zero-span mode on a spectrum analyzer or EMI receiver if the response time and spacing between bins on the sweep are sufficient to permit accurate measurements of the ON and OFF times of the transmitted signal:
  - 1) Set the center frequency of the instrument to the center frequency of the transmission.
  - 2) Set  $RBW \geq OBW$  if possible; otherwise, set RBW to the largest available value.
  - 3) Set  $VBW \geq RBW$ . Set detector = peak or average.
  - 4) The zero-span measurement method shall not be used unless both RBW and VBW are  $> 50/T$  and the number of sweep points across duration T exceeds 100. (For example, if VBW and/or RBW are limited to 3 MHz, then the zero-span method of measuring the duty cycle shall not be used if  $T \leq 16.7 \mu s$ .)

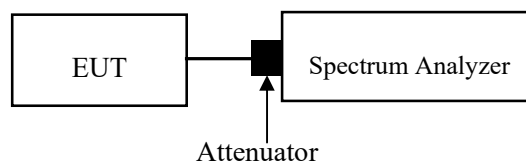

## ANTENNA REQUIREMENT

### Applicable Standard

According to FCC § 15.203, an intentional radiator shall be designed to ensure that no antenna other than that furnished by the responsible party shall be used with the device. The use of a permanently attached antenna or of an antenna that uses a unique coupling to the intentional radiator shall be considered sufficient to comply with the provisions of this Section. The manufacturer may design the unit so that a broken antenna can be replaced by the user, but the use of a standard antenna jack or electrical connector is prohibited.

According to FCC § 15.203, the applicant for equipment certification shall provide a list of all antenna types that may be used with the transmitter, where applicable (i.e. for transmitters with detachable antenna), indicating the maximum permissible antenna gain (in dBi) and the required impedance for each antenna. The test report shall demonstrate the compliance of the transmitter with the limit for maximum equivalent isotropically radiated power (e.i.r.p.) specified in the applicable RSS, when the transmitter is equipped with any antenna type, selected from this list.

For expediting the testing, measurements may be performed using only the antenna with highest gain of each combination of transmitter and antenna type, with the transmitter output power set at the maximum level. However, the transmitter shall comply with the applicable requirements under all operational conditions and when in combination with any type of antenna from the list provided in the test report (and in the notice to be included in the user manual, provided below).

When measurements at the antenna port are used to determine the RF output power, the effective gain of the device's antenna shall be stated, based on a measurement or on data from the antenna's manufacturer.

The test report shall state the RF power, output power setting and spurious emission measurements with each antenna type that is used with the transmitter being tested.

For licence-exempt equipment with detachable antennas, the user manual shall also contain the following notice in a conspicuous location:

This radio transmitter [enter the device's ISED certification number] has been approved by Innovation, Science and Economic Development Canada to operate with the antenna types listed below, with the maximum permissible gain indicated. Antenna types not included in this list that have a gain greater than the maximum gain indicated for any type listed are strictly prohibited for use with this device. Immediately following the above notice, the manufacturer shall provide a list of all antenna types which can be used with the transmitter, indicating the maximum permissible antenna gain (in dBi) and the required impedance for each antenna type.

### Antenna Connector Construction

The EUT has one internal antenna arrangement, which was permanently attached, the antenna gain<sup>#</sup> is 0dBi, fulfill the requirement of this section. Please refer to the EUT photos.

Antenna Type	Antenna Gain <sup>#</sup>	Impedance	Frequency Range
Monopole	0dBi	50Ω	2.4~2.5GHz

**Result: Compliant**

**TEST DATA AND RESULTS****AC Line Conducted Emissions****Environmental Conditions**

<b>Temperature (°C)</b>	22.5	<b>Relative Humidity (%)</b>	39
<b>ATM Pressure (kPa)</b>	101.9	<b>Test engineer</b>	Macy Shi
<b>Test date</b>	2025/03/19		
<b>EUT operation mode</b>	Transmitting(Maximum output power mode, Low Channel)		

AC120V 60 Hz, Line

Date: 2025-03-19

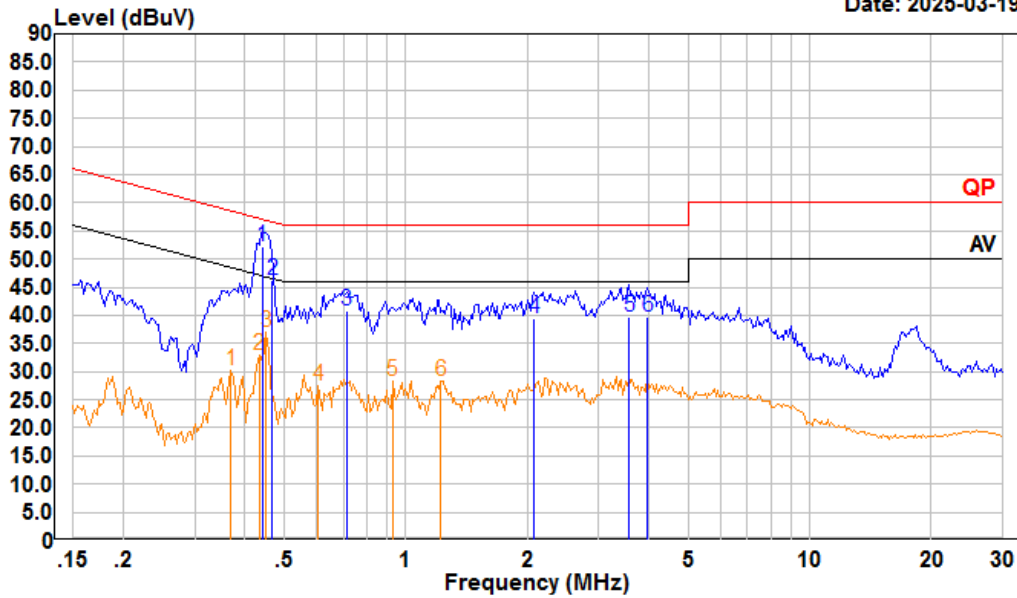

Trace: 1  
 Condition: Line  
 Project : 2501R29557E-RF  
 tester : Macy.shi Note:Transmitting  
 Setting : RBW:9kHz

	Read Freq	Read Level	LISN Level	LISN Factor	Cable Loss	Limit Line	Over Limit	Remark
	MHz	dBuV	dBuV	dB	dB	dBuV	dB	
1	0.442	31.49	52.14	10.53	10.12	57.02	-4.88	QP
2	0.466	25.59	46.24	10.52	10.13	56.58	-10.34	QP
3	0.712	19.69	40.73	10.89	10.15	56.00	-15.27	QP
4	2.077	18.20	39.48	11.09	10.19	56.00	-16.52	QP
5	3.565	18.50	39.63	10.93	10.20	56.00	-16.37	QP
6	3.964	18.70	39.81	10.90	10.21	56.00	-16.19	QP
	Read Freq	Read Level	LISN Level	LISN Factor	Cable Loss	Limit Line	Over Limit	Remark
	MHz	dBuV	dBuV	dB	dB	dBuV	dB	
1	0.369	9.46	30.14	10.57	10.11	48.52	-18.38	Average
2	0.433	12.35	32.99	10.53	10.11	47.20	-14.21	Average
3	0.452	16.45	37.09	10.52	10.12	46.85	-9.76	Average
4	0.608	6.65	27.50	10.73	10.12	46.00	-18.50	Average
5	0.928	7.45	28.21	10.66	10.10	46.00	-17.79	Average
6	1.223	7.39	28.28	10.75	10.14	46.00	-17.72	Average

AC120V 60 Hz, Neutral

Date: 2025-03-19

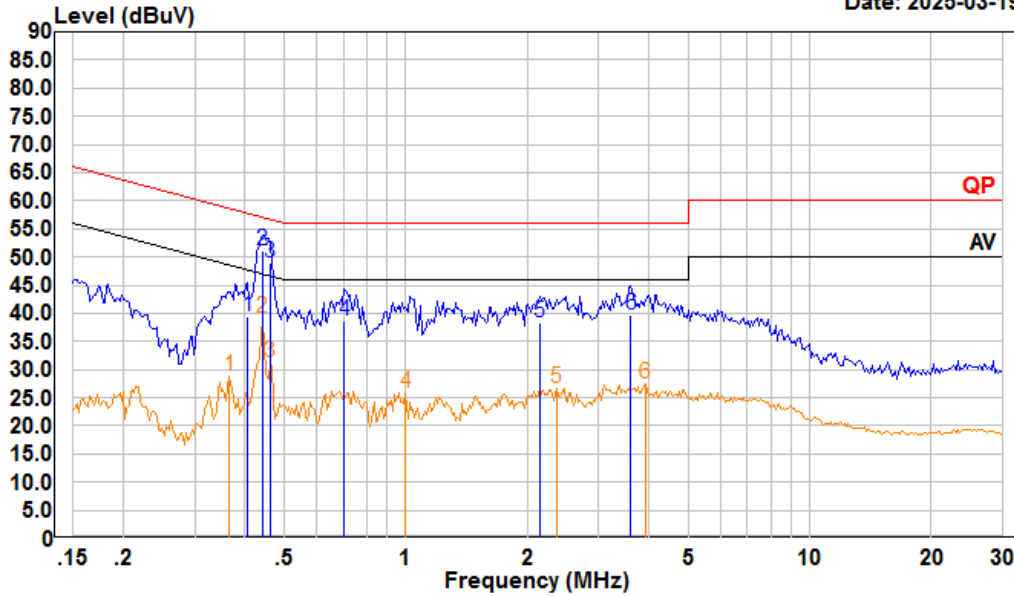

Trace: 1

Condition: Neutral

Project : 2501R29557E-RF

tester : Macy.shi Note:Transmitting

Setting : RBW:9kHz

	Read Freq	Read Level	LISN Level	LISN Factor	Cable Loss	Limit Line	Over Limit	Remark
	MHz	dBuV	dBuV	dB	dB	dBuV	dB	
1	0.406	18.80	39.47	10.57	10.10	57.73	-18.26	QP
2	0.442	30.40	51.06	10.54	10.12	57.02	-5.96	QP
3	0.461	28.30	48.95	10.53	10.12	56.67	-7.72	QP
4	0.705	17.80	38.55	10.60	10.15	56.00	-17.45	QP
5	2.144	17.30	38.21	10.73	10.18	56.00	-17.79	QP
6	3.603	18.60	39.75	10.95	10.20	56.00	-16.25	QP
	Read Freq	Read Level	LISN Level	LISN Factor	Cable Loss	Limit Line	Over Limit	Remark
	MHz	dBuV	dBuV	dB	dB	dBuV	dB	
1	0.365	8.09	28.80	10.60	10.11	48.61	-19.81	Average
2	0.442	18.48	39.14	10.54	10.12	47.02	-7.88	Average
3	0.461	10.66	31.31	10.53	10.12	46.67	-15.36	Average
4	1.000	4.90	25.81	10.80	10.11	46.00	-20.19	Average
5	2.358	5.83	26.78	10.77	10.18	46.00	-19.22	Average
6	3.922	6.38	27.58	10.99	10.21	46.00	-18.42	Average

**Unwanted Emission Frequencies and Restricted Bands**

**Environmental Conditions**

<b>Temperature (°C)</b>	23.8~24.5	<b>Relative Humidity (%)</b>	43~50.2
<b>ATM Pressure (kPa):</b>	101.4~101.2	<b>Test engineer:</b>	Anson Su & Zenos Qiao
<b>Test date:</b>	2025/03/29~2025/04/12		
<b>EUT operation mode:</b>	Below 1GHz: Transmitting(Maximum output power mode, Low Channel) Above 1GHz: Transmitting		
<b>Note:</b>	<ol style="list-style-type: none"> <li>1. For the radiated spurious emission below 30MHz, only the worst case (parallel) was recorded.</li> <li>2. For the radiated spurious emission below 1GHz, When the test result of peak was less than the limit of QP/Average more than 6dB, just peak value were recorded.</li> <li>3. After pre-scan in the X, Y and Z axes of orientation, the worst case X-axis of orientation were recorded.</li> </ol>		

**Below 1GHz:**

9kHz-150kHz

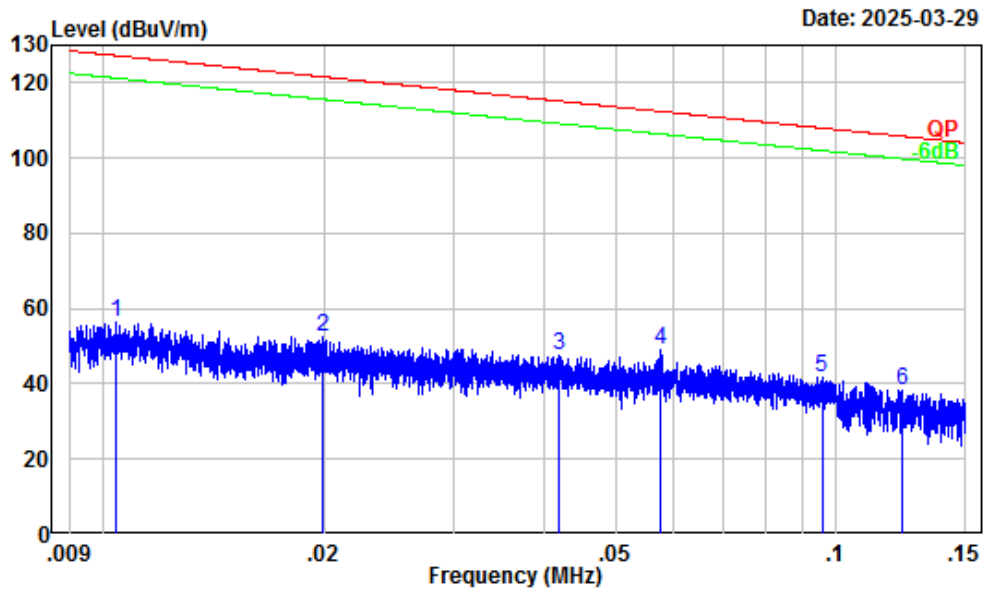

Site : Chamber A  
 Condition : 3m  
 Project Number : 2501R29557E-RF  
 Test Mode : BLE Transmitting  
 Detector: Peak RBW/VBW: 0.3/1kHz  
 Tester : Anson Su

	Freq	Factor	Read Level	Limit Level	Limit Line	Over Limit	Remark
	MHz	dB/m	dBuV	dBuV/m	dBuV/m	dB	
1	0.01	32.22	24.36	56.58	127.25	-70.67	Peak
2	0.02	30.41	22.02	52.43	121.60	-69.17	Peak
3	0.04	27.26	20.45	47.71	115.17	-67.46	Peak
4	0.06	25.66	23.16	48.82	112.42	-63.60	Peak
5	0.10	22.31	19.24	41.55	108.00	-66.45	Peak
6	0.12	20.64	17.59	38.23	105.80	-67.57	Peak

150kHz-30MHz

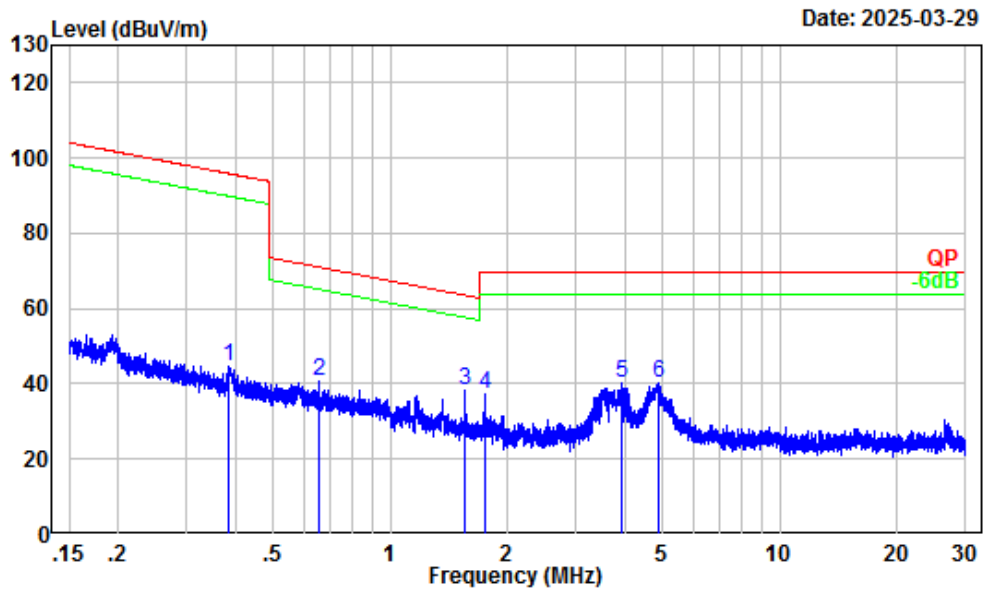

Site : Chamber A  
 Condition : 3m  
 Project Number : 2501R29557E-RF  
 Test Mode : BLE Transmitting  
 Detector: Peak RBW/VBW: 10/30kHz  
 Tester : Anson Su

	Freq	Factor	Read Level	Level	Limit Line	Over Limit	Remark
	MHz	dB/m	dBuV	dBuV/m	dBuV/m	dB	
1	0.39	8.56	36.32	44.88	95.86	-50.98	Peak
2	0.66	4.44	36.04	40.48	71.18	-30.70	Peak
3	1.55	-0.35	38.74	38.39	63.56	-25.17	Peak
4	1.75	-0.90	38.21	37.31	69.54	-32.23	Peak
5	3.93	-2.66	42.89	40.23	69.54	-29.31	Peak
6	4.87	-2.79	43.13	40.34	69.54	-29.20	Peak

30MHz-1GHz\_Horizontal

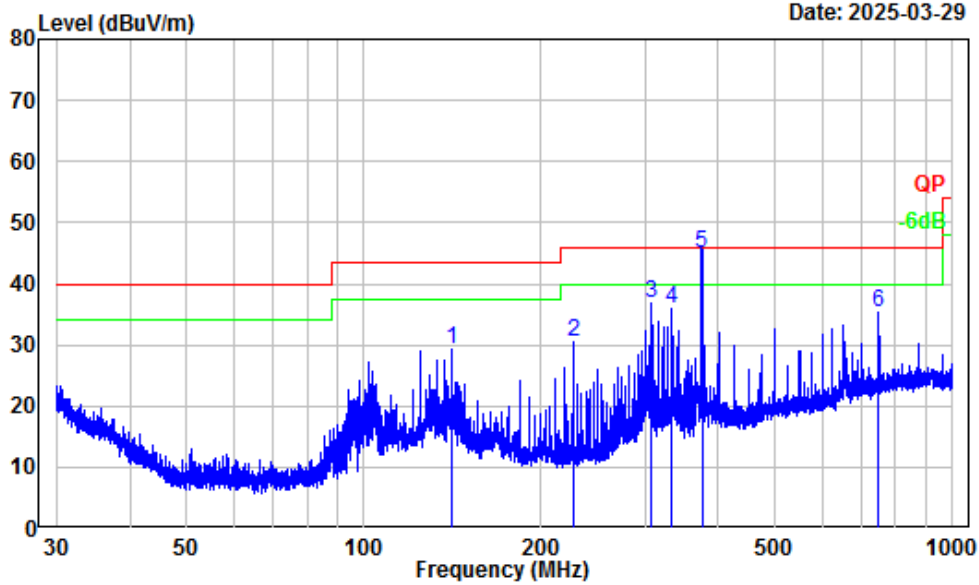

Site : Chamber A  
 Condition : 3m Horizontal  
 Project Number : 2501R29557E-RF  
 Test Mode : BLE Transmitting  
 Detector: Peak RBW/VBW: 100/300kHz  
 Tester : Anson Su

	Freq	Factor	Read Level	Level	Limit Line	Over Limit	Remark
	MHz	dB/m	dBuV	dBuV/m	dBuV/m	dB	
1	140.65	-11.89	41.12	29.23	43.50	-14.27	Peak
2	226.60	-14.01	44.37	30.36	46.00	-15.64	Peak
3	308.64	-11.06	48.03	36.97	46.00	-9.03	Peak
4	332.08	-10.61	46.67	36.06	46.00	-9.94	Peak
5	375.12	-9.28	54.20	44.92	46.00	-1.08	QP
6	750.11	-2.88	38.31	35.43	46.00	-10.57	Peak

30MHz-1GHz\_Vertical

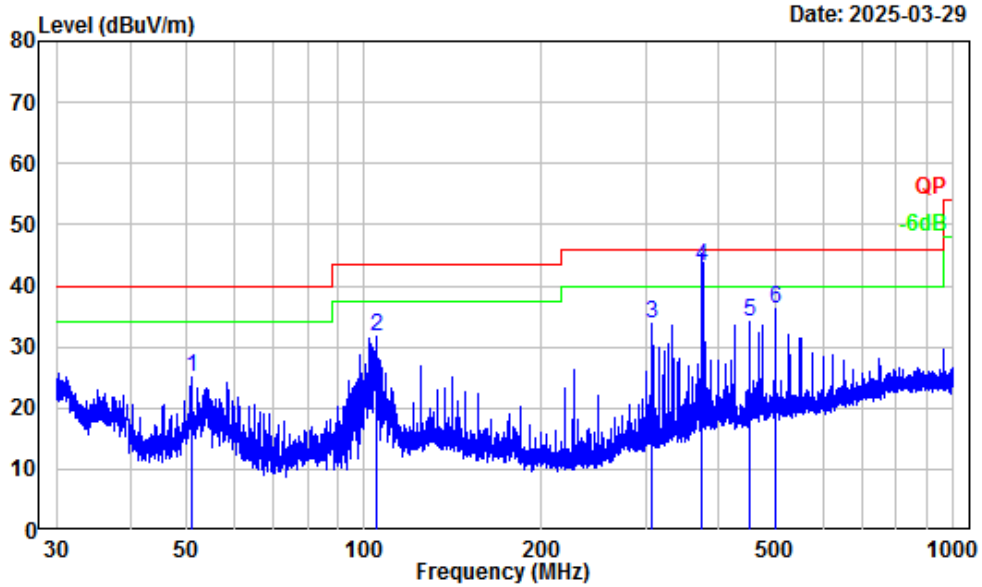

Site : Chamber A  
 Condition : 3m Vertical  
 Project Number : 2501R29557E-RF  
 Test Mode : BLE Transmitting  
 Detector: Peak RBW/VBW: 100/300kHz  
 Tester : Anson Su

	Freq	Factor	Read Level	Level	Limit Line	Over Limit	Remark
	MHz	dB/m	dBuV	dBuV/m	dBuV/m	dB	
1	50.79	-18.07	43.18	25.11	40.00	-14.89	Peak
2	104.72	-14.50	46.16	31.66	43.50	-11.84	Peak
3	308.64	-11.06	44.99	33.93	46.00	-12.07	Peak
4	374.95	-9.29	52.60	43.31	46.00	-2.69	QP
5	450.15	-7.53	41.56	34.03	46.00	-11.97	Peak
6	500.08	-5.76	41.96	36.20	46.00	-9.80	Peak

**Above 1GHz: (Adapter 1 was tested)**

Frequency (MHz)	Reading (dBµV)	PK/Ave	Polar (H/V)	Factor (dB/m)	Corrected Amplitude (dBµV/m)	Limit (dBµV/m)	Margin (dB)
<b>BLE 1M</b>							
Low Channel							
4804	55.38	PK	H	-7.79	47.59	74	-26.41
4804	47.57	AV	H	-7.79	39.78	54	-14.22
4804	54.49	PK	V	-7.79	46.7	74	-27.3
4804	47.15	AV	V	-7.79	39.36	54	-14.64
Middle Channel							
4880	58.12	PK	H	-7.59	50.53	74	-23.47
4880	51.48	AV	H	-7.59	43.89	54	-10.11
4880	57.24	PK	V	-7.59	49.65	74	-24.35
4880	51.03	AV	V	-7.59	43.44	54	-10.56
High Channel							
4960	59.63	PK	H	-7.56	52.07	74	-21.93
4960	52.81	AV	H	-7.56	45.25	54	-8.75
4960	58.72	PK	V	-7.56	51.16	74	-22.84
4960	52.36	AV	V	-7.56	44.8	54	-9.2

Note:

Corrected Factor = Antenna factor (RX) + Cable Loss – Amplifier Factor

Corrected Amplitude = Corrected Factor + Reading

Margin = Corrected. Amplitude - Limit

The other spurious emission which is in the noise floor level was not recorded.

Test plots

Left Band edge\_Horizontal\_Peak

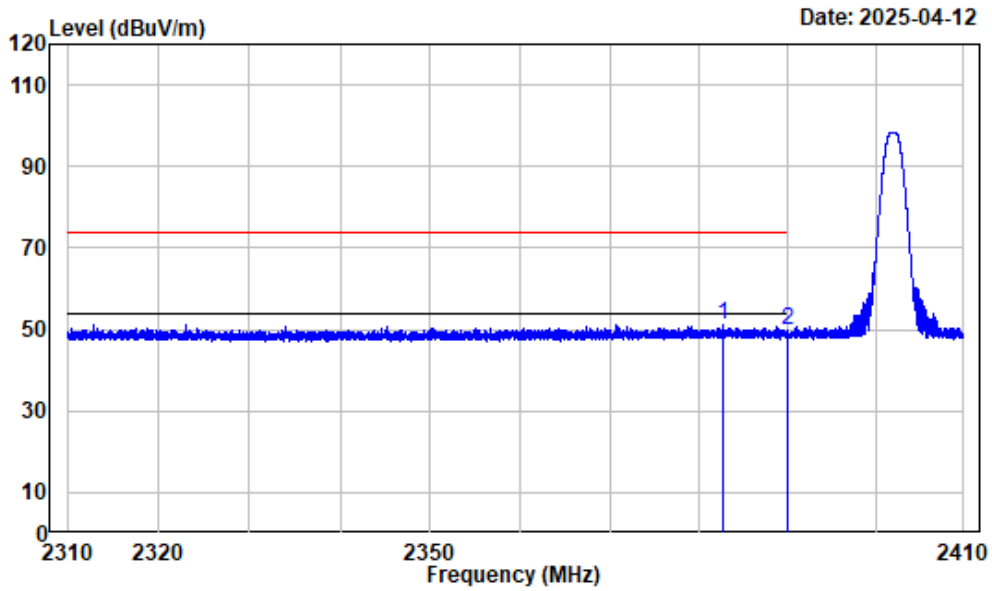

Condition : Horizontal  
 Project No. : 2501R29557E-RF  
 Tester : Zenos Qiao  
 Spectrum setting: Peak reading:RBW:1MHz VBW:3MHz Detector:Peak  
 Note : BLE1M-2402

	Freq	Factor	Read Level	Level	Limit	Over	Remark
	MHz	dB/m	dBuV	dBuV/m	dBuV/m	dB	
1	2382.834	-10.98	62.26	51.28	74.00	-22.72	Peak
2	2390.000	-10.98	60.89	49.91	74.00	-24.09	Peak

Left Band edge\_Veritical\_Peak

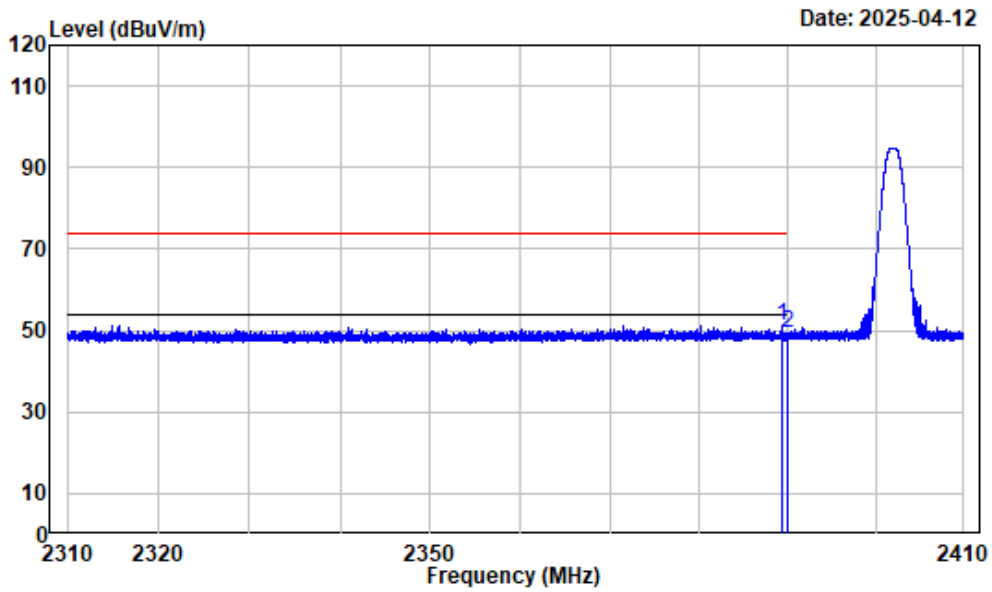

Condition : Vertical  
 Project No. : 2501R29557E-RF  
 Tester : Zenos Qiao  
 Spectrum setting: Peak reading:RBW:1MHz VBW:3MHz Detector:Peak  
 Note : BLE1M-2402

	Freq	Factor	Read Level	Level	Limit Line	Over Limit	Remark
	MHz	dB/m	dBuV	dBuV/m	dBuV/m	dB	
1	2389.410	-10.98	62.22	51.24	74.00	-22.76	Peak
2	2390.000	-10.98	60.13	49.15	74.00	-24.85	Peak

Right Band edge\_Horizontal\_Peak

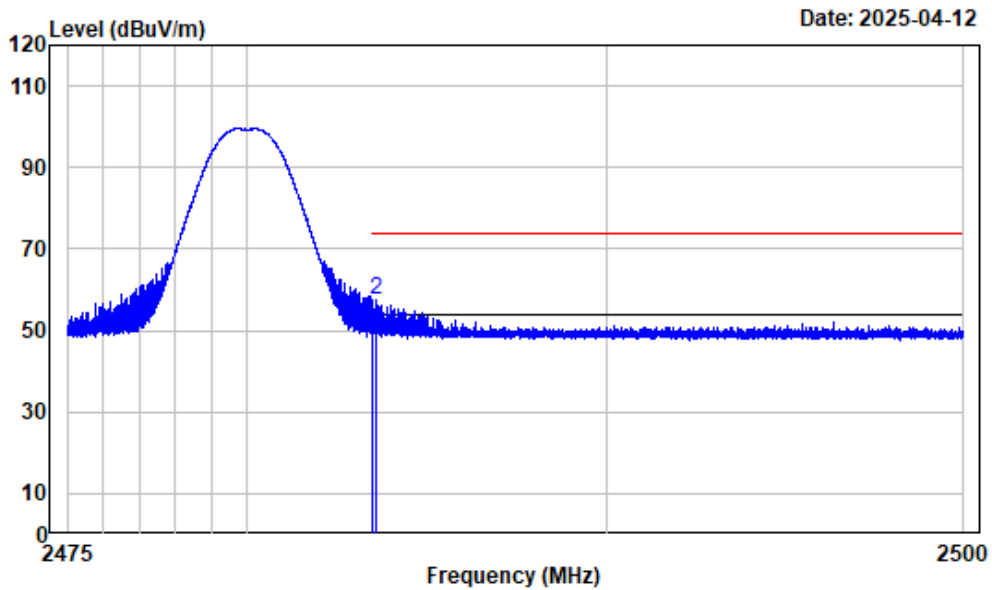

Condition : Horizontal  
 Project No. : 2501R29557E-RF  
 Tester : Zenos Qiao  
 Spectrum setting: Peak reading:RBW:1MHz VBW:3MHz Detector:Peak  
 Note : BLE1M-2480

	Freq	Factor	Read		Limit	Over	Remark
			Level	Level	Line	Limit	
	MHz	dB/m	dBuV	dBuV/m	dBuV/m	dB	
1	2483.500	-10.97	60.70	49.73	74.00	-24.27	Peak
2	2483.570	-10.97	68.44	57.47	74.00	-16.53	Peak

Right Band edge\_Horizontal\_Average

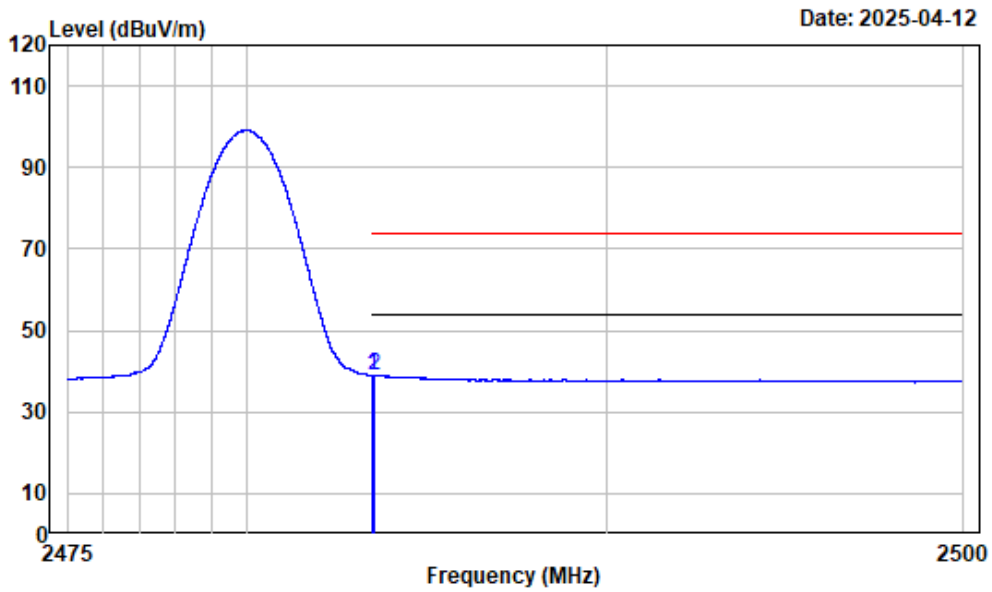

Condition : Horizontal  
 Project No. : 2501R29557E-RF  
 Tester : Zenos Qiao  
 Spectrum setting: Average reading:RBW:1MHz VBW:500Hz Detector:Peak  
 Note : BLE1M-2480

	Freq	Factor	Read Level	Level	Limit Line	Over Limit	Remark
	MHz	dB/m	dBuV	dBuV/m	dBuV/m	dB	
1	2483.500	-10.97	50.07	39.10	54.00	-14.90	Average
2	2483.526	-10.97	50.12	39.15	54.00	-14.85	Average

Right Band edge\_Vertical\_Peak

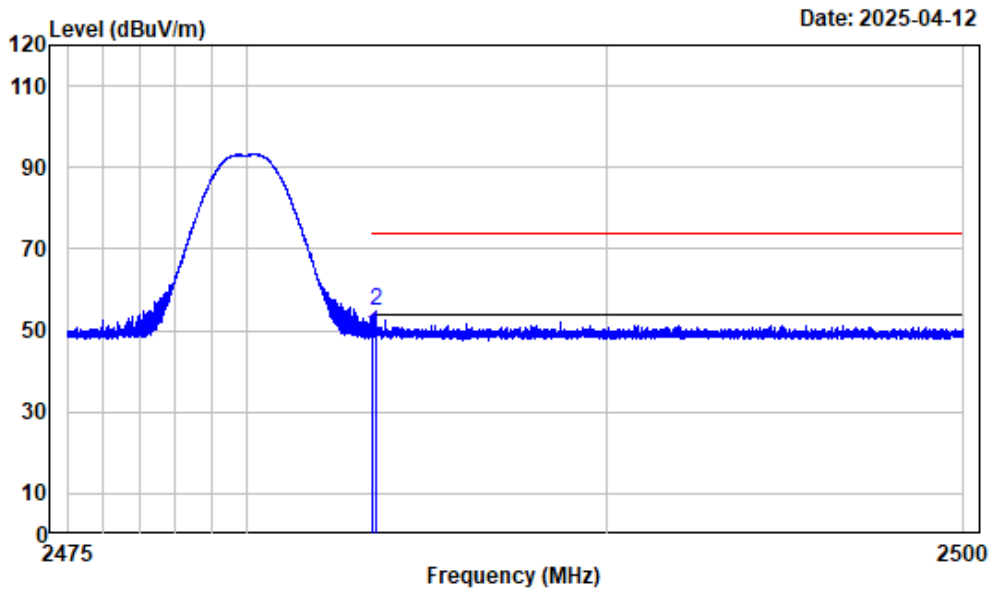

Condition : Vertical  
 Project No. : 2501R29557E-RF  
 Tester : Zenos Qiao  
 Spectrum setting: Peak reading:RBW:1MHz VBW:3MHz Detector:Peak  
 Note : BLE1M-2480

	Freq	Factor	Read Level	Level	Limit Line	Over Limit	Remark
	MHz	dB/m	dBuV	dBuV/m	dBuV/m	dB	
1	2483.500	-10.97	59.68	48.71	74.00	-25.29	Peak
2	2483.563	-10.97	65.59	54.62	74.00	-19.38	Peak

Right Band edge\_Vertical\_Average

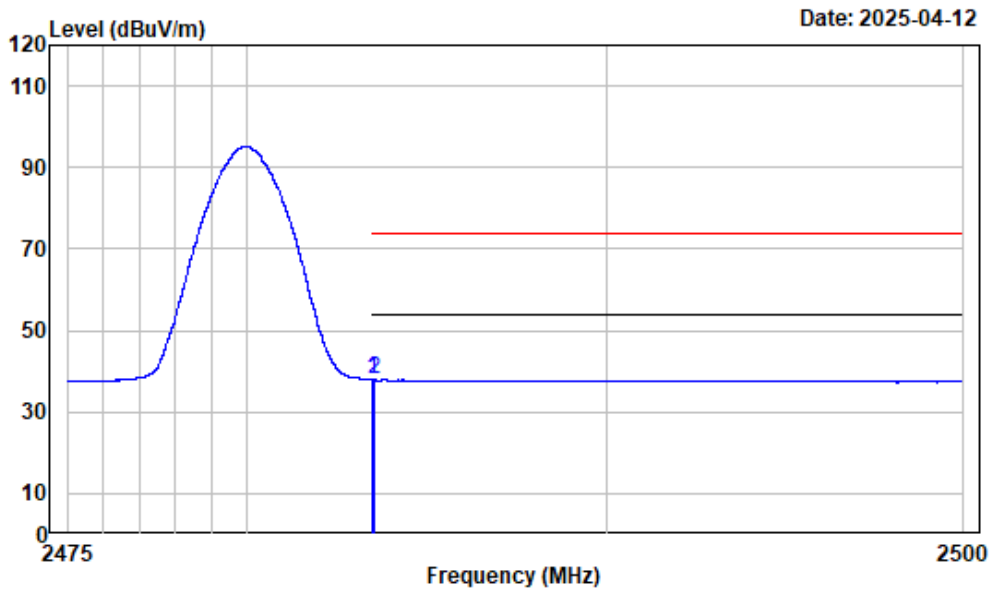

Condition : Vertical  
 Project No. : 2501R29557E-RF  
 Tester : Zenos Qiao  
 Spectrum setting: Average reading:RBW:1MHz VBW:500Hz Detector:Peak  
 Note : BLE1M-2480

	Freq	Factor	Read		Limit	Over	Remark
			Level	Level			
	MHz	dB/m	dBuV	dBuV/m	dBuV/m	dB	
1	2483.500	-10.97	48.98	38.01	54.00	-15.99	Average
2	2483.519	-10.97	49.19	38.22	54.00	-15.78	Average

Listed with the worst harmonic margin test plot

1-4GHz\_Horizontal

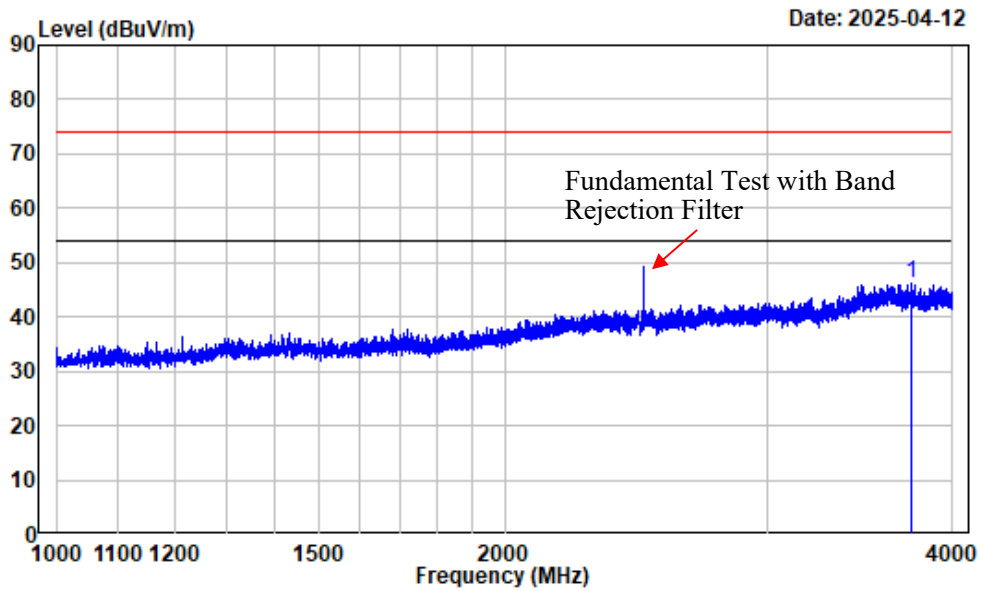

Condition : Horizontal  
 Project No. : 2501R29557E-RF  
 Tester : Zenos Qiao  
 Spectrum setting: Peak reading:RBW:1MHz VBW:3MHz Detector:Peak  
 Note : BLE1M-2480

	Freq	Factor	Read Level	Level	Limit Line	Over Limit	Remark
	MHz	dB/m	dBuV	dBuV/m	dBuV/m	dB	
1	3758.470	-9.64	55.79	46.15	74.00	-27.85	Peak

1-4GHz\_Vertical

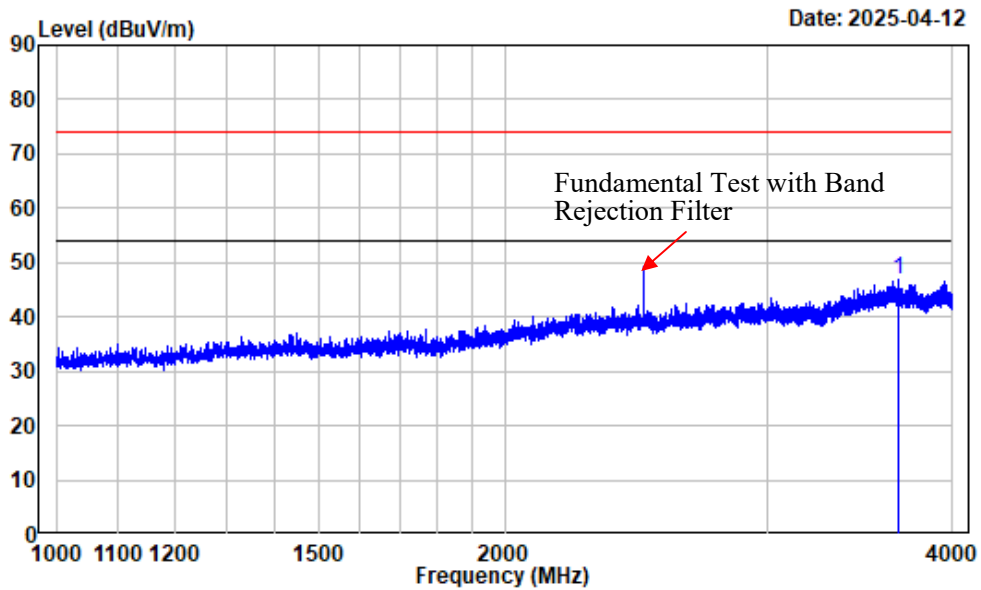

Condition : Vertical  
 Project No. : 2501R29557E-RF  
 Tester : Zenos Qiao  
 Spectrum setting: Peak reading:RBW:1MHz VBW:3MHz Detector:Peak  
 Note : BLE1M-2480

1	Read		Limit		Over Limit	Remark
	Freq	Factor	Level	Level		
	MHz	dB/m	dBuV	dBuV/m	dBuV/m	dB
1	3682.710	-9.59	56.61	47.02	74.00	-26.98 Peak

4-18GHz\_Horizontal\_Peak

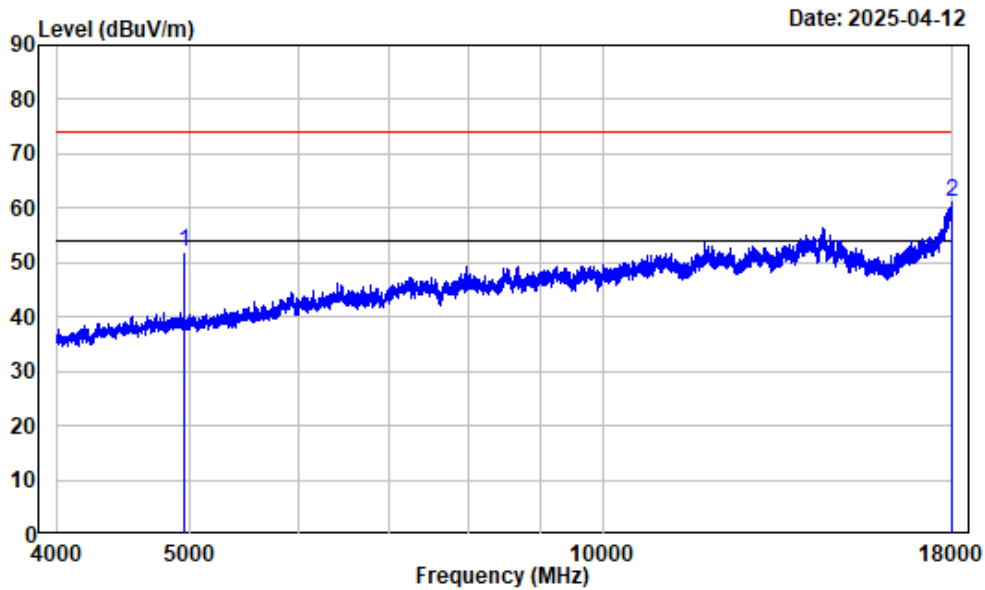

Condition : Horizontal  
 Project No. : 2501R29557E-RF  
 Tester : Zenos Qiao  
 Spectrum setting: Peak reading:RBW:1MHz VBW:3MHz Detector:Peak  
 Note : BLE1M-2480

	Freq	Factor	Read		Limit	Over	Remark
			Level	Level	Line	Limit	
	MHz	dB/m	dBuV	dBuV/m	dBuV/m	dB	
1	4960.000	-7.56	59.63	52.07	74.00	-21.93	Peak
2	17980.250	13.09	48.19	61.28	74.00	-12.72	Peak

4-18GHz\_Horizontal\_Average

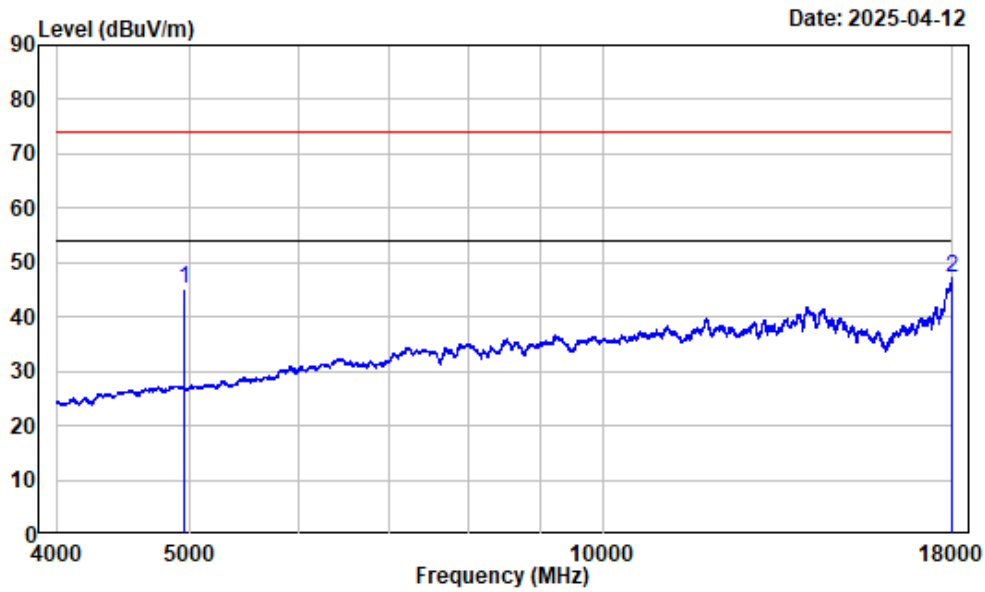

Condition : Horizontal  
 Project No. : 2501R29557E-RF  
 Tester : Zenos Qiao  
 Spectrum setting: Average reading:RBW:1MHz VBW:1kHz Detector:Peak  
 Note : BLE1M-2480

	Freq	Factor	Read		Limit	Over	Remark
			Level	Level			
	MHz	dB/m	dBuV	dBuV/m	dBuV/m	dB	
1	4960.000	-7.56	52.81	45.25	54.00	-8.75	Average
2	17996.500	13.19	34.07	47.26	54.00	-6.74	Average

4-18GHz\_Vertical\_Peak

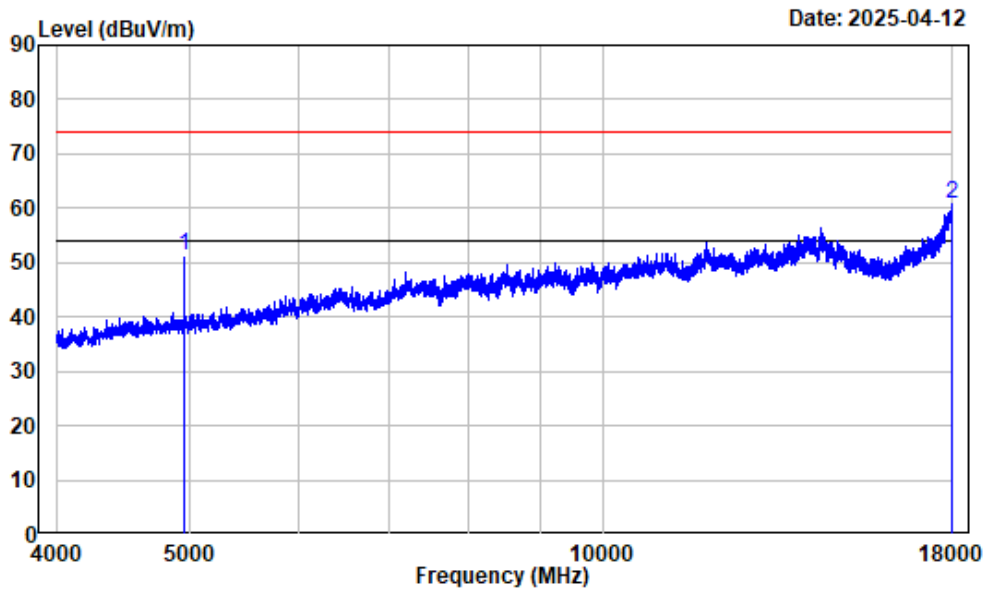

Condition : Vertical  
 Project No. : 2501R29557E-RF  
 Tester : Zenos Qiao  
 Spectrum setting: Peak reading:RBW:1MHz VBW:3MHz Detector:Peak  
 Note : BLE1M-2480

	Freq	Factor	Read Level	Level	Limit Line	Over Limit	Remark
	MHz	dB/m	dBuV	dBuV/m	dBuV/m	dB	
1	4960.000	-7.56	58.72	51.16	74.00	-22.84	Peak
2	17979.000	13.09	47.80	60.89	74.00	-13.11	Peak

4-18GHz\_Vertical\_Average

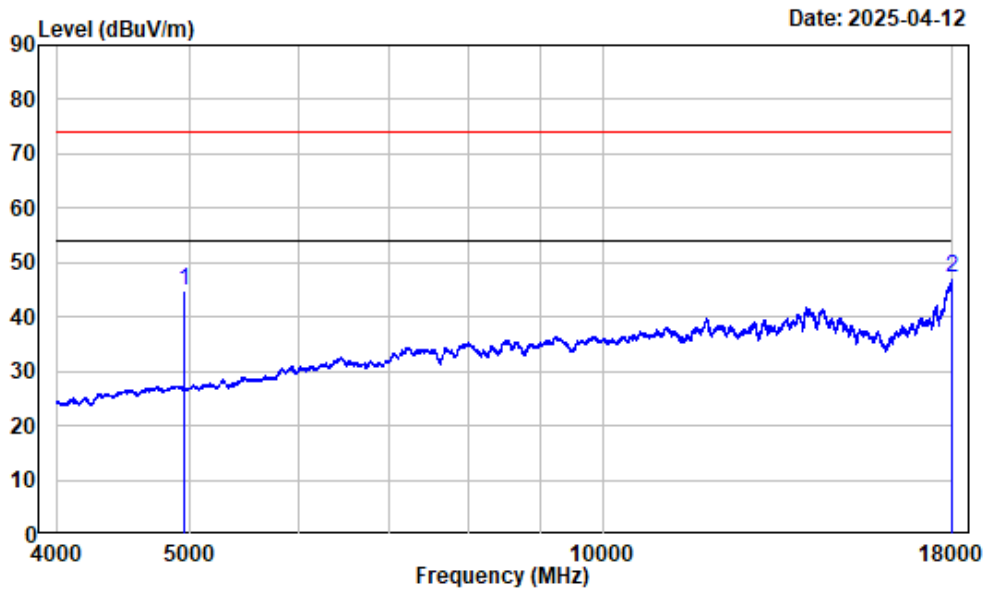

Condition : Vertical  
 Project No. : 2501R29557E-RF  
 Tester : Zenos Qiao  
 Spectrum setting: Average reading:RBW:1MHz VBW:1kHz Detector:Peak  
 Note : BLE1M-2480

	Freq	Factor	Read		Limit	Over	Remark
			Level	Level			
	MHz	dB/m	dBuV	dBuV/m	dBuV/m	dB	
1	4960.000	-7.56	52.36	44.80	54.00	-9.20	Average
2	17998.630	13.20	33.93	47.13	54.00	-6.87	Average

18-25GHz\_Horizontal

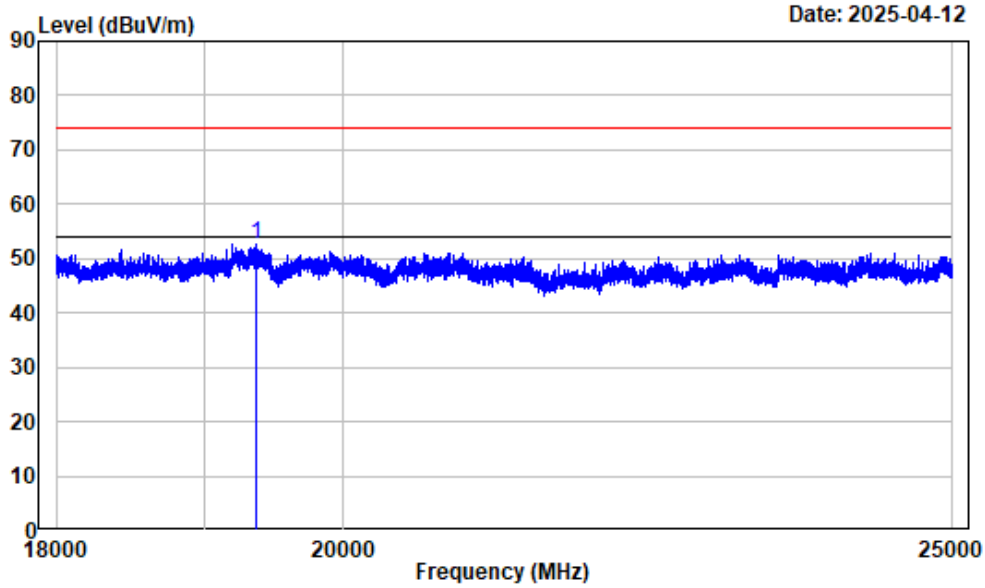

Condition : Horizontal  
 Project No. : 2501R29557E-RF  
 Tester : Zenos Qiao  
 Spectrum setting: Peak reading:RBW:1MHz VBW:3MHz Detector:Peak  
 Note : BLE1M-2480

Freq	Factor	Read		Limit	Over	Remark
		Level	Level	Line	Limit	
MHz	dB/m	dBuV	dBuV/m	dBuV/m	dB	
1 19367.800	15.44	37.11	52.55	74.00	-21.45	peak

18-25GHz\_Vertical

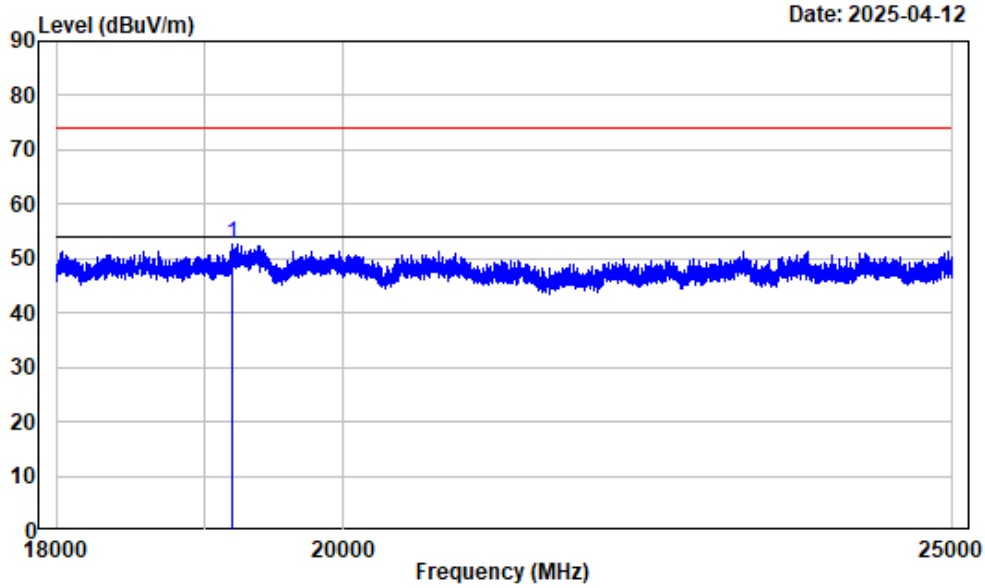

Condition : Vertical  
 Project No. : 2501R29557E-RF  
 Tester : Zenos Qiao  
 Spectrum setting: Peak reading:RBW:1MHz VBW:3MHz Detector:Peak  
 Note : BLE1M-2480

1	Freq	Factor	Read		Limit	Over	Remark
			Level	Level			
	MHz	dB/m	dBuV	dBuV/m	dBuV/m	dB	
	19199.780	15.40	37.19	52.59	74.00	-21.41	peak

**6dB Emission Bandwidth**

**Test Information:**

<b>Sample No.:</b>	2Z6F-11	<b>Test Date:</b>	2025/03/17
<b>Test Site:</b>	RF	<b>Test Mode:</b>	Transmitting
<b>Tester:</b>	Brian Li	<b>Test Result:</b>	Pass

**Environmental Conditions:**

<b>Temperature:</b> (°C)	23	<b>Relative Humidity:</b> (%)	35	<b>ATM Pressure:</b> (kPa)	101
-----------------------------	----	----------------------------------	----	-------------------------------	-----

**Test Data:**

**BLE 1M**

<b>Channel</b>	<b>Result (MHz)</b>	<b>Limit (MHz)</b>	<b>Verdict</b>
Low Channel	0.710	≥0.5	Pass
Middle Channel	0.715	≥0.5	Pass
High Channel	0.710	≥0.5	Pass

BLE 1M

BLE\_1M\_Low\_Channel

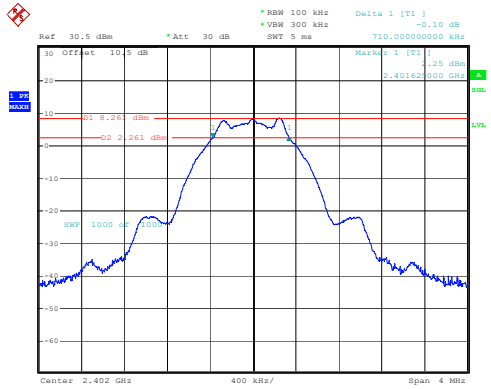

ProjectNo.:2501R29557E-RF Tester:Brian Li  
Date: 17.MAR.2025 13:45:19

BLE\_1M\_Middle\_Channel

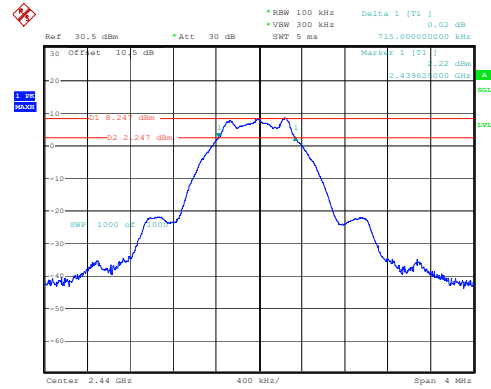

ProjectNo.:2501R29557E-RF Tester:Brian Li  
Date: 17.MAR.2025 13:47:11

BLE\_1M\_High\_Channel

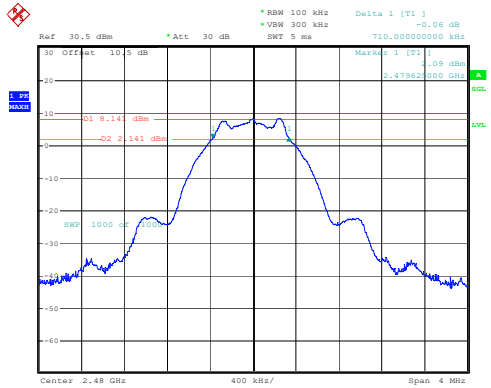

ProjectNo.:2501R29557E-RF Tester:Brian Li  
Date: 17.MAR.2025 13:49:59

**99% Occupied Bandwidth**

**Test Information:**

<b>Sample No.:</b>	2Z6F-11	<b>Test Date:</b>	2025/03/17
<b>Test Site:</b>	RF	<b>Test Mode:</b>	Transmitting
<b>Tester:</b>	Brian Li	<b>Test Result:</b>	N/A

**Environmental Conditions:**

<b>Temperature:</b> (°C)	23	<b>Relative Humidity:</b> (%)	35	<b>ATM Pressure:</b> (kPa)	101
-----------------------------	----	----------------------------------	----	-------------------------------	-----

**Test Data:**

**BLE 1M**

<b>Channel</b>	<b>99% OBW (MHz)</b>
Low Channel	1.045
Middle Channel	1.040
High Channel	1.035

BLE 1M

BLE\_1M\_Low\_Channel

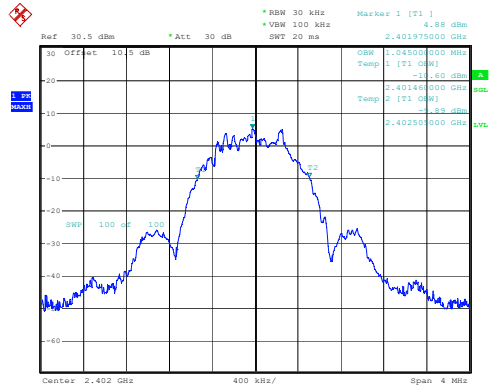

ProjectNo.:2501R29557E-RF Tester:Brian Li  
Date: 17.MAR.2025 13:45:27

BLE\_1M\_Middle\_Channel

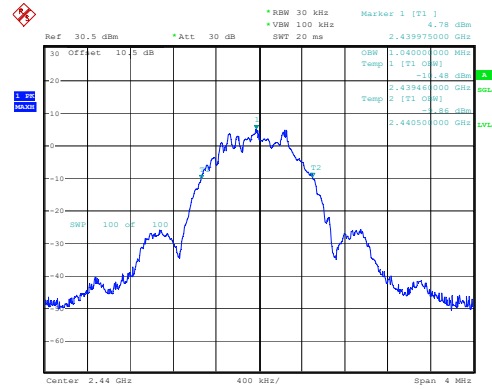

ProjectNo.:2501R29557E-RF Tester:Brian Li  
Date: 17.MAR.2025 13:47:19

BLE\_1M\_High\_Channel

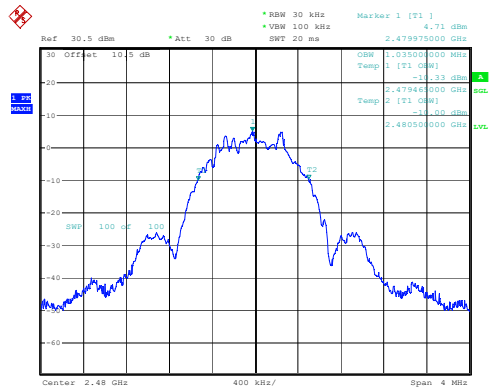

ProjectNo.:2501R29557E-RF Tester:Brian Li  
Date: 17.MAR.2025 13:50:09

**Maximum Conducted Output Power**

**Test Information:**

<b>Sample No.:</b>	2Z6F-11	<b>Test Date:</b>	2025/03/17
<b>Test Site:</b>	RF	<b>Test Mode:</b>	Transmitting
<b>Tester:</b>	Brian Li	<b>Test Result:</b>	Pass

**Environmental Conditions:**

<b>Temperature:</b> (°C)	23	<b>Relative Humidity:</b> (%)	35	<b>ATM Pressure:</b> (kPa)	101
-----------------------------	----	----------------------------------	----	-------------------------------	-----

**Test Data:**

**BLE 1M**

Channel	Peak Output Power (dBm)	Limit (dBm)	Verdict
Low Channel	<b>8.86</b>	30.00	Pass
Middle Channel	8.81	30.00	Pass
High Channel	8.69	30.00	Pass

Note: The antenna gain is 0dBi, the maximum EIRP is 8.86dBm+0dBi=8.86dBm less than the 36dBm. So the EUT meets the ISEDC EIRP limit.

**BLE 1M**

BLE\_1M\_Low\_Channel

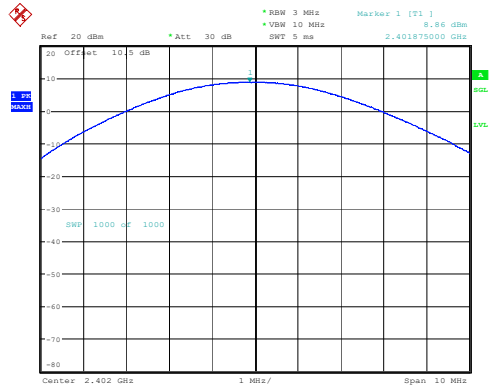

ProjectNo.:2501R29557E-RF Tester:Brian Li  
Date: 17.MAR.2025 13:46:09

BLE\_1M\_Middle\_Channel

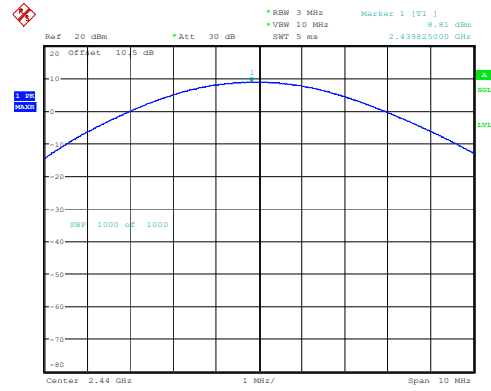

ProjectNo.:2501R29557E-RF Tester:Brian Li  
Date: 17.MAR.2025 13:47:50

BLE\_1M\_High\_Channel

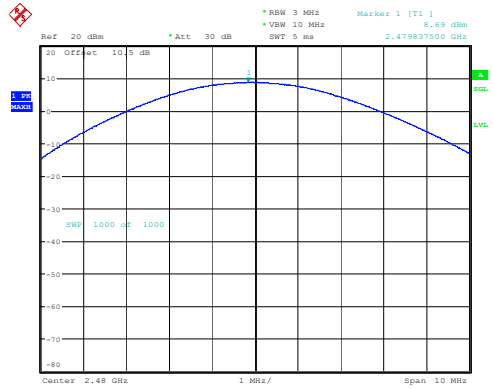

ProjectNo.:2501R29557E-RF Tester:Brian Li  
Date: 17.MAR.2025 13:50:29

**Power Spectral Density**

**Test Information:**

<b>Sample No.:</b>	2Z6F-11	<b>Test Date:</b>	2025/03/17
<b>Test Site:</b>	RF	<b>Test Mode:</b>	Transmitting
<b>Tester:</b>	Brian Li	<b>Test Result:</b>	Pass

**Environmental Conditions:**

<b>Temperature:</b> (°C)	23	<b>Relative Humidity:</b> (%)	35	<b>ATM Pressure:</b> (kPa)	101
-----------------------------	----	----------------------------------	----	-------------------------------	-----

**Test Data:**

**BLE 1M**

Channel	Result (dBm/3kHz)	Limit (dBm/3kHz)	Verdict
Low Channel	-7.67	8	Pass
Middle Channel	-7.62	8	Pass
High Channel	-7.76	8	Pass

BLE 1M

BLE\_1M\_Low\_Channel

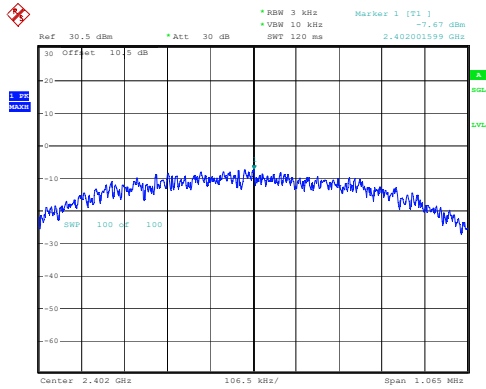

ProjectNo.:2501R29557E-RF Tester:Brian Li  
Date: 17.MAR.2025 13:46:28

BLE\_1M\_Middle\_Channel

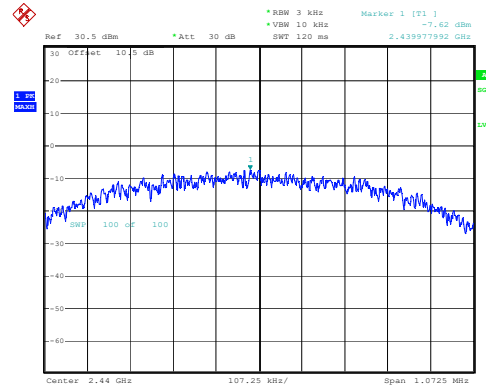

ProjectNo.:2501R29557E-RF Tester:Brian Li  
Date: 17.MAR.2025 13:48:08

BLE\_1M\_High\_Channel

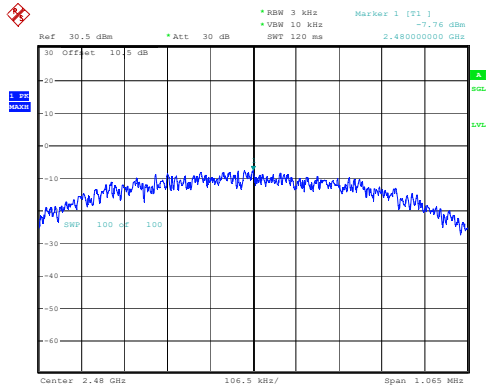

ProjectNo.:2501R29557E-RF Tester:Brian Li  
Date: 17.MAR.2025 13:50:47

**100 kHz Bandwidth of Frequency Band Edge**

**Test Information:**

<b>Sample No.:</b>	2Z6F-11	<b>Test Date:</b>	2025/03/17
<b>Test Site:</b>	RF	<b>Test Mode:</b>	Transmitting
<b>Tester:</b>	Brian Li	<b>Test Result:</b>	Pass

**Environmental Conditions:**

<b>Temperature:</b> (°C)	23	<b>Relative Humidity:</b> (%)	35	<b>ATM Pressure:</b> (kPa)	101
-----------------------------	----	----------------------------------	----	-------------------------------	-----

BLE 1M

BLE\_1M\_Low\_Channel

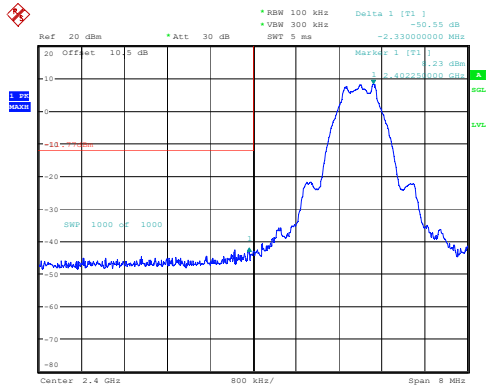

ProjectNo.:2501R29557E-RF Tester:Brian Li  
Date: 17.MAR.2025 13:44:53

BLE\_1M\_High\_Channel

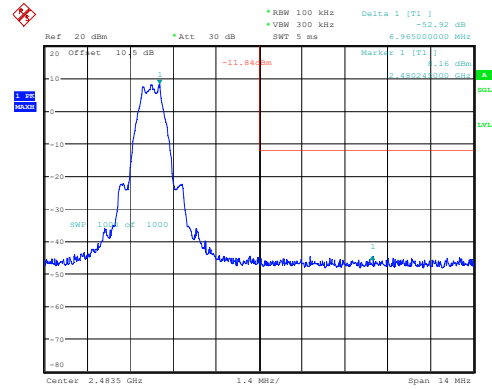

ProjectNo.:2501R29557E-RF Tester:Brian Li  
Date: 17.MAR.2025 13:49:21

**Duty Cycle**

**Test Information:**

<b>Sample No.:</b>	2Z6F-11	<b>Test Date:</b>	2025/04/28
<b>Test Site:</b>	RF	<b>Test Mode:</b>	Transmitting
<b>Tester:</b>	Brian Li	<b>Test Result:</b>	N/A

**Environmental Conditions:**

<b>Temperature:</b> (°C)	23	<b>Relative Humidity:</b> (%)	35	<b>ATM Pressure:</b> (kPa)	101
-----------------------------	----	----------------------------------	----	-------------------------------	-----

**Test Data:**

**BLE 1M**

Channel	Ton (ms)	Ton+Toff (ms)	Duty Cycle (%)	Duty Cycle Factor(dB)	1/Ton (Hz)	VBW Setting (kHz)
Middle Channel	<b>2.149</b>	2.510	85.62	0.67	465	0.500

**BLE 1M**

**BLE\_1M\_Middle\_Channel**

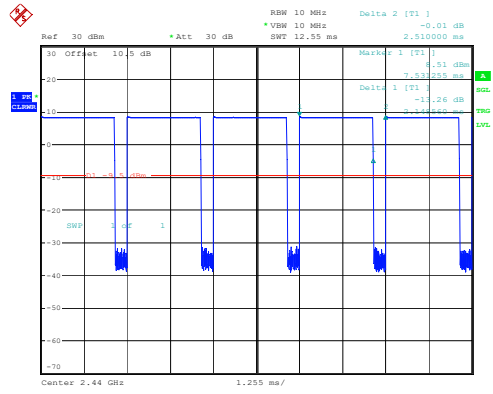

ProjectNo.:2501R29557E-RF Tester:Brian Li  
Date: 28.APR.2025 11:47:51

## RF EXPOSURE EVALUATION

### MPE-Based Exemption

#### Applicable Standard

According to subpart 2.1091 systems operating under the provisions of this section shall be operated in a manner that ensures the public is not exposed to RF energy level in excess of the communication guidelines.

According to KDB 447498 D04 v01 Interim General RF Exposure Guidance

#### MPE-Based Exemption:

General frequency and separation-distance dependent MPE-based effective radiated power(ERP) thresholds are in Table B.1 [Table 1 of § 1.1307(b)(3)(i)(C)] to support an exemption from further evaluation from 300 kHz through 100 GHz.

Table 1 to § 1.1307(b)(3)(i)(C) - Single RF Sources Subject to Routine Environmental Evaluation

RF Source frequency (MHz)	Threshold ERP (watts)
0.3-1.34	1,920 R <sup>2</sup> .
1.34-30	3,450 R <sup>2</sup> /f <sup>2</sup> .
30-300	3.83 R <sup>2</sup> .
300-1,500	0.0128 R <sup>2</sup> f.
1,500-100,000	19.2R <sup>2</sup> .

R is the minimum separation distance in meters

f = frequency in MHz

For multiple RF sources: Multiple RF sources are exempt if:

in the case of fixed RF sources operating in the same time-averaging period, or of multiple mobile or portable RF sources within a device operating in the same time averaging period, if the sum of the fractional contributions to the applicable thresholds is less than or equal to 1 as indicated in the following equation:

$$\sum_{i=1}^a \frac{P_i}{P_{th,i}} + \sum_{j=1}^b \frac{ERP_j}{ERP_{th,j}} + \sum_{k=1}^c \frac{Evaluated_k}{Exposure Limit_k} \leq 1$$

Mode	Frequency (MHz)	Tune up conducted power <sup>#</sup> (dBm)	Antenna Gain <sup>#</sup>		ERP		Evaluation Distance (m)	ERP Limit (mW)
			(dBi)	(dBd)	(dBm)	(mW)		
Bluetooth	2402-2480	6.0	0	-2.15	3.85	2.43	0.2	768
BLE	2402-2480	9.0	0	-2.15	6.85	4.84	0.2	768
2.4G Wi-Fi	2412-2462	20.0	0	-2.15	17.85	60.95	0.2	768
5.2G Wi-Fi	5180-5240	10.0	0	-2.15	7.85	6.10	0.2	768
5.3G Wi-Fi	5260-5320	11.0	0	-2.15	8.85	7.67	0.2	768
5.6G Wi-Fi	5500-5720	12.0	0	-2.15	9.85	9.66	0.2	768
5.8G Wi-Fi	5745-5825	11.0	0	-2.15	8.85	7.67	0.2	768

- Note: 1. The tune up conducted power and antenna gain was declared by the applicant.  
 2. 0dBd=2.15dBi  
 3. The Bluetooth, 2.4G Wi-Fi and 5G Wi-Fi can't transmit at the same time.

To maintain compliance with the FCC's RF exposure guidelines, place the equipment at least 20cm from nearby persons.

**Result: Compliant**

**Field reference level exposure exemption limits**

**Applicable Standard**

According to RSS-102 Issue 6§6.6:

Field reference level (FRL) exposure evaluation is required if the separation distance between the user and/or bystander and the device’s radiating element is greater than 20 cm (i.e. mobile devices), except when the device operates as follows:

- below 20 MHz and the source-based, time-averaged maximum EIRP of the device is equal to or less than 1 W (adjusted for tune-up tolerance)
- at or above 20 MHz and below 48 MHz and the source-based, time-averaged maximum EIRP of the device is equal to or less than  $4.49/f^{0.5}$  W (adjusted for tune-up tolerance), where  $f$  is in MHz
- at or above 48 MHz and below 300 MHz and the source-based, time-averaged maximum EIRP of the device is equal to or less than 0.6 W (adjusted for tune-up tolerance)
- at or above 300 MHz and below 6 GHz and the source-based, time-averaged maximum EIRP of the device is equal to or less than  $1.31 \times 10^{-2} f^{0.6834}$  W (adjusted for tune-up tolerance), where  $f$  is in MHz
- at or above 6 GHz and the source-based, time-averaged maximum EIRP of the device is equal to or less than 5 W (adjusted for tune-up tolerance) In these cases, the information contained in the RF exposure technical brief may be limited to information that demonstrates how the EIRP was derived.

**Test Result:**

For worst case:

Mode	Frequency (MHz)	Antenna Gain# (dBi)	Tune up output power# (dBm)	EIRP (dBm)	EIRP (W)	Evaluation Distance (m)	Limit (W)
Bluetooth	2402-2480	0	6.0	6.0	0.004	0.2	2.68
BLE	2402-2480	0	9.0	9.0	0.008	0.2	2.68
2.4G Wi-Fi	2412-2462	0	20.0	20.0	0.100	0.2	2.68
5G Wi-Fi	5180-5240	0	10.0	10.0	0.010	0.2	4.53
	5260-5320	0	11.0	11.0	0.013	0.2	4.57
	5500-5580 & 5660-5720	0	12.0	12.0	0.016	0.2	4.71
	5745-5825	0	11.0	11.0	0.013	0.2	4.86

Note:

- 1) The tune up conducted power and antenna gain was declared by the applicant.
- 2) The Bluetooth, 2.4G Wi-Fi and 5G Wi-Fi can’t transmit at the same time.

**Result: Compliant**

To maintain compliance with the RF exposure guidelines, place the equipment at least 20cm from nearby persons.

---

## **EUT PHOTOGRAPHS**

---

Please refer to the attachment 2501R29557E-RF External photo and 2501R29557E-RF Internal photo.

## **TEST SETUP PHOTOGRAPHS**

---

Please refer to the attachment 2501R29557E-RFB Test Setup photo.

**\*\*\*\*\* END OF REPORT \*\*\*\*\***