

Specific Absorption Rate (SAR) Evaluation Report

For

2.4GHz Frequency Hopping Spread Spectrum Baby Monitor – Parent Unit

Model Number: VM311 PU

Brand Name: vtech

FCC ID: EW780-9321-01

Test Report: 13120508HKG-001

Date of Report: 30 December, 2013

Prepared for

*VTech Telecommunications Ltd.
23/F, Tai Ping Industrial Centre, Block 1,
57 Ting Kok Road, Tai Po, Hong Kong.*



Testing Laboratory
2349

Prepared and Checked by:

Approved by:

Chan Chun Foo, Bike
Senior Lead Engineer
Date: 30 December, 2013

Nip Ming Fung, Melvin
Assistant Manager
Date: 30 December, 2013

- The test report only allows to be revised within the retention period unless further standard or the requirement was noticed.
- This report is for the exclusive use of Intertek's Client and is provided pursuant to the agreement between Intertek and its Client. Intertek's responsibility and liability are limited to the terms and conditions of the agreement. Intertek assumes no liability to any party, other than to the Client in accordance with the agreement, for any loss, expense or damage occasioned by the use of this report. Only the Client is authorized to permit copying or distribution of this report and then only in its entirety. Any use of the Intertek name or one of its marks for the sale or advertisement of the tested material, product or service must first be approved in writing by Intertek. The observations and test results in this report are relevant only to the sample tested. This report by itself does not imply that the material, product, or service is or has ever been under an Intertek certification program.

Intertek Testing Services Hong Kong Ltd.

2/F., Garment Centre, 576 Castle Peak Road, Kowloon, Hong Kong.
Tel: (852) 2173 8888 Fax: (852) 2785 5487 Website: www.hk.intertek-etlsemko.com

Table of Contents

| | |
|---|----|
| 1 Test Result Summary..... | 3 |
| 2 General Information..... | 4 |
| 3 Measurement System Description and Procedure | 6 |
| 4 Tissue Verificaiton | 14 |
| 5 SAR Measurement System Verification | 16 |
| 6 SAR Evaluation | 18 |
| 7 Test Insturments..... | 24 |
| 8 Measurement Uncertainty | 25 |
| 9 E-Field Probe and 1900 Dipole Antenna Calibration | 25 |
| 10 References..... | 25 |
| APPENDIX A – System Verification Data..... | 26 |
| APPENDIX B – SAR Evaluation Data | 28 |
| APPENDIX C – E-Field Probe and Dipole Antenna Calibration | 69 |
| APPENDIX D – SAR Tissue Specification | 81 |
| APPENDIX E – SAR System Validation..... | 82 |

1. Test Result Summary

| | | |
|--------------------------|---|---|
| Applicant | : | VTech Telecommunications Ltd. |
| Applicant Address | : | 23/F, Tai Ping Industrial Centre, Block 1, 57 Ting Kok Road, Tai Po, Hong Kong |
| Model | : | VM311 PU |
| Brand Name | : | vtech |
| EUT Description | : | 2.4GHz Frequency Hopping Spread Spectrum Baby Monitor – Parent Unit |
| Exposure Category | : | General Population/Uncontrolled Exposure |
| Test Device | : | Production Unit |
| Date of Sample Received | : | 9 December, 2013 |
| Date of Test | : | 12 December, 2013 to 13 December, 2013 |
| Date of Report | : | 30 December, 2013 |
| Place of Testing | : | Intertek Testing Services Hong Kong 5/F, Garment Centre, 576 Castle Peak Road, Kowloon, Hong Kong |
| Environmental Conditions | : | Temperature: +20 to 25°C Humidity 30 to 70% |
| Test Specification | : | ANSI/IEEE C95.1: 1992 IEEE Std 1528: 2003 IEEE Std 1528a: 2005 FCC KDB Publication 447498 D01 v05r01 FCC KDB Publication 865664 D01 v01r02 FCC KDB Publication 865664 D02 v01r01 |

The maximum spatial peak SAR value for the sample device averaged over 1g was found to be:

| Band | Operating Mode | TX Frequency (MHz) | Highest Reported SAR | |
|--------|--------------------|--------------------|----------------------|------------|
| | | | 1 g In-Front-of face | 1g Body |
| 2.4GHz | Voice Transmission | 2407.5 – 2475.0MHz | 0.207 W/kg | 0.253 W/kg |

This wireless portable device has been shown to be capable of compliance for localized specific absorption rate (SAR) for uncontrolled environment / general population exposure limits specified in ANSI/IEEE C95.1.

2. General Information

2.1. Description of Equipment under test (EUT)

| | |
|-----------------------------------|--|
| EUT Description | : 2.4GHz Frequency Hopping Spread Spectrum Baby Monitor – Parent Unit |
| Model | : VM311 PU |
| Brand Name | : vtech |
| FCC ID | : EW780-9321-01 |
| Serial Number | : N/A |
| Manufacturer | : VTech (Dongguan) Telecommunications Limited. |
| Manufacturer Address | : VTech Science Park, Xia Ling Bei Management Zone, Liaobu, Dongguan, Guangdong, China. |
| Device dimension (L x W) | : 123 (mm) x 60 (mm) |
| Device thickness | : 26 (mm) |
| Operating Configuration(s) / mode | : In-Front-of the Face (Voice Transmission) : Body (Voice Transmission) |
| RF Exposure Condition(s) | : Face and Body |
| Device Category | : Portable Device |
| Tx Frequency | : 2407.5 MHz – 2475 MHz |
| Duty Cycle | : 17.9% |
| Battery Type | : 1 x 3.6V 750mAh Ni-MH rechargeable battery pack : - Model: CR BT185645 / BT285645 : - Model: GP BT185645 / BT285645 : - Model: GY BT185645 / BT285645 |
| Body-worn Accessories | : N/A |

Nominal and Maximum Output Power Specifications

The EUT operates using the following maximum and nominal output power specifications. SAR values were scaled to the maximum allowed power to determine compliance per KDB Publication 447498.

| Band | Operating Mode | TX Frequency (MHz) | Output Power | |
|--------|--------------------|--------------------|---------------|---------------|
| | | | Nominal (dBm) | Maximum (dBm) |
| 2.4GHz | Voice Transmission | 2407.5 – 2475.0 | +18 dBm | +20 dBm |

EUT Antenna Locations

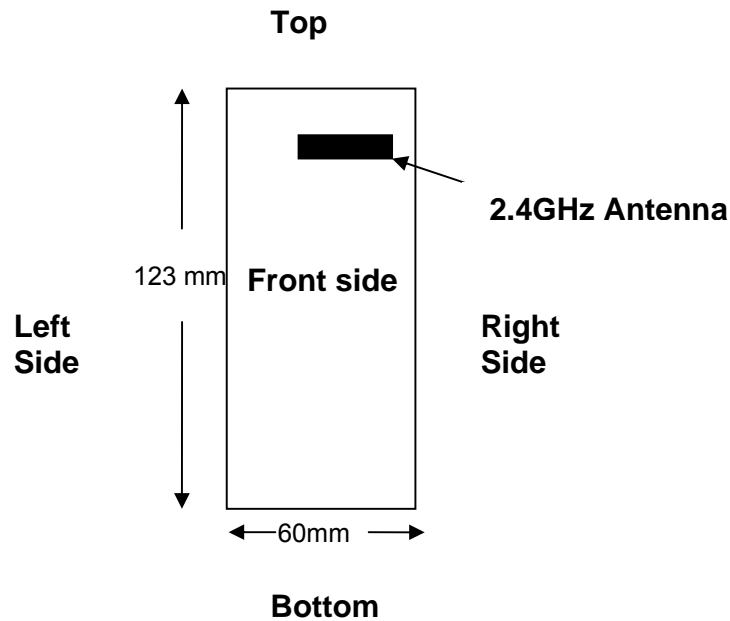

| | |
|------------------|--------------------|
| Antenna Type | : Fixed Type |
| Antenna Location | : Intregal Antenna |
| Antenna Gain | : 0 dBi |

Details of antenna specification are shown in separate antenna dimension document.

3. Measurement System Description and procedure

Robot system specification

The SAR measurement system being used is the IndexSAR SARA2 system, which consists of a Mitsubishi RV-E2 6-axis robot arm and controller, IndexSAR probe, amplifier and the phantom with Head or Box Shape. The robot is used to articulate the probe to programmed positions inside the phantom head to obtain the SAR readings from the DUT.

The system is controlled remotely from a PC, which contains the software to control the robot and data acquisition equipment. The software also displays the data obtained from test scans.

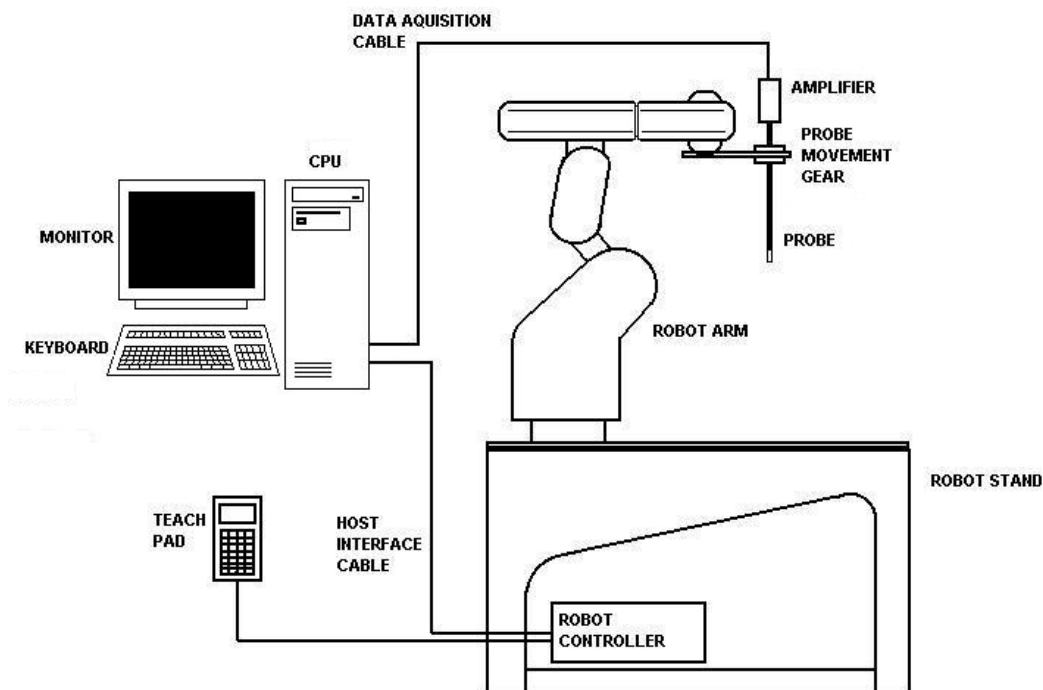

Figure 1: Schematic diagram of the SAR measurement system

The position and digitized shape of the phantom heads are made available to the software for accurate positioning of the probe and reduction of set-up time.

The SAM phantom heads are individually digitized using a Mitutoyo CMM machine to a precision of 0.02mm. The data is then converted into a shape format for the software, providing an accurate description of the phantom shell.

IndexSar isotropic immersible SAR probe

The probe contains three orthogonal dipole sensors arranged on a triangular prism core, protected against static charges by PEEK cylindrical enclosure material.

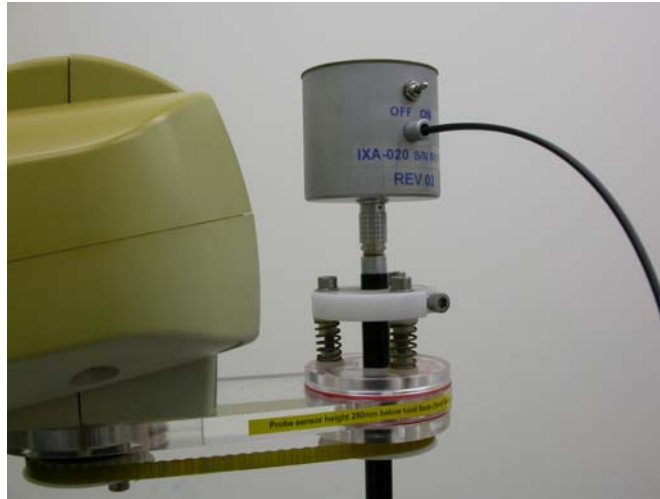

This amplifier has a time constant of approx. 50µs, which is much faster than the SAR probe response time. The overall system time constant is therefore that of the probe (<1ms) and reading sets for all three channels (simultaneously) are returned every 2ms to the PC. The conversion period is approx. 1 µs at the start of each 2ms period. This enables the probe to follow pulse modulated signals of periods >>2ms. The PC software applies the linearisation procedure separately to each reading, so no linearisation corrections for the averaging of modulated signals are needed in this case. It is important to ensure that the probe reading frequency and the pulse period are not synchronised and the behaviour with pulses of short duration in comparison with the measurement interval need additional consideration.

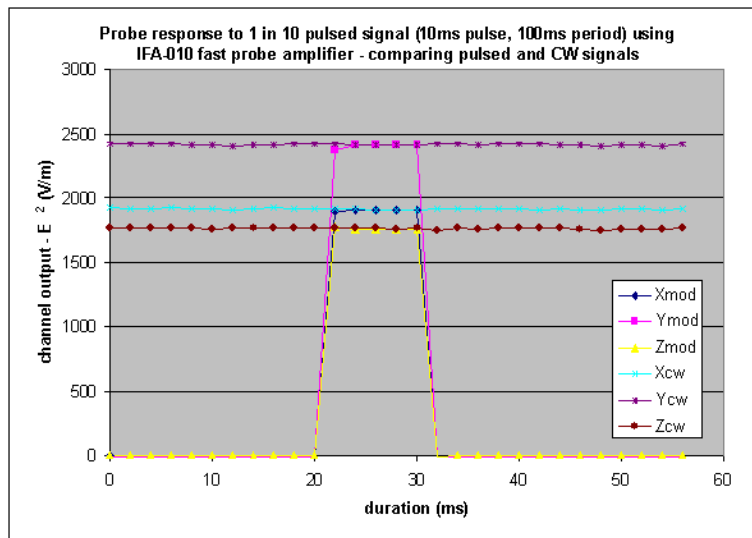

In operation, the system first does an area (2D) scan at a fixed depth within the liquid from the inside wall of the phantom scanning area is greater than the projection of EUT and antenna.

Area Scan Parameters extracted from KDB 865664 D01 v01

| | ≤ 3 GHz | > 3 GHz |
|--|---|--|
| Maximum distance from closest measurement point (geometric center of probe sensors) to phantom surface | 5 ± 1 mm | $\frac{1}{2} \cdot \delta \cdot \ln(2) \pm 0.5$ mm |
| Maximum probe angle from probe axis to phantom surface normal at the measurement location | 30° ± 1° | 20° ± 1° |
| Maximum area scan spatial resolution: Δx_{Area} , Δy_{Area} | ≤ 2 GHz: ≤ 15 mm 2 – 3 GHz: ≤ 12 mm | 3 – 4 GHz: ≤ 12 mm 4 – 6 GHz: ≤ 10 mm |
| | When the x or y dimension of the test device, in the measurement plane orientation, is smaller than the above, the measurement resolution must be ≤ the corresponding x or y dimension of the test device with at least one measurement point on the test device. | |

When the maximum SAR point has been found, the system will then carry out a 3D scan centred at that point to determine volume averaged SAR level. The first 2 measurements points in a direction perpendicular to the surface of the phantom during the zoom scan and closest to the phantom surface, were only 3.5mm and the probe is kept at greater than half a diameter from the surface.

Zoom Scan Parameters extracted from KDB 865664 D01 v01

| Maximum zoom scan spatial resolution: Δx_{Zoom} , Δy_{Zoom} | | ≤ 2 GHz: ≤ 8 mm 2 – 3 GHz: ≤ 5 mm* | 3 – 4 GHz: ≤ 5 mm* 4 – 6 GHz: ≤ 4 mm* |
|--|------------------------------------|--|---|
| Maximum zoom scan spatial resolution, normal to phantom surface | uniform grid: $\Delta z_{Zoom}(n)$ | ≤ 5 mm | 3 – 4 GHz: ≤ 4 mm 4 – 5 GHz: ≤ 3 mm 5 – 6 GHz: ≤ 2 mm |
| | graded grid | $\Delta z_{Zoom}(1)$: between 1 st two points closest to phantom surface | ≤ 4 mm 3 – 4 GHz: ≤ 3 mm 4 – 5 GHz: ≤ 2.5 mm 5 – 6 GHz: ≤ 2 mm |
| | | $\Delta z_{Zoom}(n>1)$: between subsequent points | ≤ 1.5 · $\Delta z_{Zoom}(n-1)$ |
| Minimum zoom scan volume | x, y, z | ≥ 30 mm | 3 – 4 GHz: ≥ 28 mm 4 – 5 GHz: ≥ 25 mm 5 – 6 GHz: ≥ 22 mm |
| Note: δ is the penetration depth of a plane-wave at normal incidence to the tissue medium; see draft standard IEEE P1528-2011 for details. * When zoom scan is required and the <i>reported</i> SAR from the area scan based <i>1-g SAR estimation</i> procedures of KDB 447498 is ≤ 1.4 W/kg, ≤ 8 mm, ≤ 7 mm and ≤ 5 mm zoom scan resolution may be applied, respectively, for 2 GHz to 3 GHz, 3 GHz to 4 GHz and 4 GHz to 6 GHz. | | | |

a. SARA2 interpolation and extrapolation schemes

SARA2 software contains support for both 2D cubic B-spline interpolation as well as 3D cubic B-spline interpolation. Additionally, for extrapolation purposes, a general n-th order polynomial fitting routine is implemented following a singular value decomposition algorithm. A 4th order polynomial fit is used by default for data extrapolation, but a linear-logarithmic fitting function can be selected as an option. The polynomial fitting procedures have been tested by comparing the fitting coefficients generated by the SARA2 procedures with those obtained using the polynomial fit functions of Microsoft Excel when applied to the same test input data.

b. Interpolation of 2D area scan

The 2D cubic B-spline interpolation is used after the initial area scan at fixed distance from the phantom shell wall. The initial scan data are collected with approx. 10mm spatial resolution and spline interpolation is used to find the location of the local maximum to within a 1mm resolution for positioning the subsequent 3D scanning.

c. Extrapolation of 3D scan

For the 3D scan, data are collected on a spatially regular 3D grid having (by default) 6.4 mm steps in the lateral dimensions and 3.5 mm steps in the depth direction (away from the source). SARA2 enables full control over the selection of alternative steps in all directions.

The digitised shape of the head is available to the SARA2 software, which decides which points in the 3D array are sufficiently well within the shell wall to be “visited” by the SAR probe. After the data collection, the data are extrapolated in the depth direction to assign values to points in the 3D array closer to the shell wall. A notional extrapolation value is also assigned to the first point outside the shell wall so that subsequent interpolation schemes will be applicable right up to the shell wall boundary.

d. Interpolation of 3D scan and volume averaging

The procedure used for defining the shape of the volumes used for SAR averaging in the SARA2 software follow the method of adapting the surface of the “cube” to conform with the curved inner surface of the phantom.

For each row of data in the depth direction, the data are extrapolated and interpolated to less than 1 mm spacing and average values are calculated from the phantom surface for the row of data over distances corresponding to the requisite depth for 1g and 10g cubes. This results in two 2D arrays of data, which are then cubic B-spline interpolated to sub mm lateral resolution. A search routine then moves an averaging square around through the 2D array and records the maximum value of corresponding 1g and 10g volume averages.

3.1. Device test positions relative to the head

This practice specifies two handset test positions against the head phantom—the “cheek” position and the “tilt” position. These two test positions are defined in the following subclauses. The handset should be tested in both positions on left and right sides of the SAM phantom. If handset construction is such that the handset positioning procedures described below to represent normal use conditions cannot be used, e.g., some asymmetric handsets, alternative alignment procedures should be adapted with all details provided in the test report. These alternative procedures should replicate intended use conditions as closely as possible according to the intent of the procedures described in this subclause.

Definition of the cheek position

The cheek position is established as follows:

1. Ready the handset for talk operation, if necessary. For example, for handsets with a cover piece (flip cover), open the cover. If the handset can transmit with the cover closed, both configurations must be tested.
2. Define two imaginary lines on the handset—the vertical centerline and the horizontal line. The vertical centerline passes through two points on the front side of the handset—the midpoint of the width w_t of the handset at the level of the acoustic output (point A in below figure), and the midpoint of the width w_b of the bottom of the handset (point B). The horizontal line is perpendicular to the vertical centerline and passes through the center of the acoustic output (see below left figure). The two lines intersect at point A. Note that for many handsets, point A coincides with the center of the acoustic output; however, the acoustic output may be located elsewhere on the horizontal line. Also note that the vertical centerline is not necessarily parallel to the front face of the handset (see right figure), especially for clamshell handsets, handsets with flip covers, and other irregularly-shaped handsets.
3. Position the handset close to the surface of the phantom such that point A is on the (virtual) extension of the line passing through points RE and LE on the phantom (see the figure as next page), such that the plane defined by the vertical centerline and the horizontal line of the handset is approximately parallel to the sagittal plane of the phantom.
4. Translate the handset towards the phantom along the line passing through RE and LE until handset point A touches the pinna at the ERP.

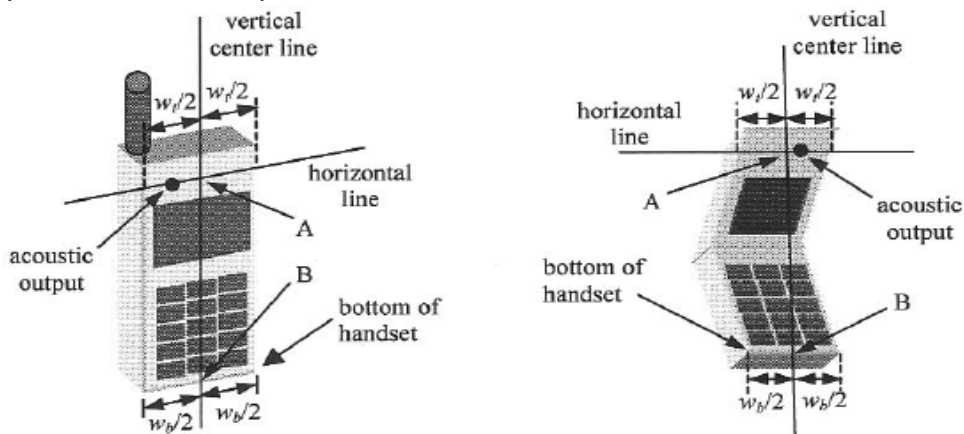

Intertek Testing Services Hong Kong Ltd.

2/F., Garment Centre, 576 Castle Peak Road, Kowloon, Hong Kong.
Tel: (852) 2173 8888 Fax: (852) 2785 5487 Website: www.hk.intertek-etlsemko.com

5. While maintaining the handset in this plane, rotate it around the LE-RE line until the vertical centerline is in the plane normal to the plane containing B-M and N-F lines, i.e., the Reference Plane.
6. Rotate the handset around the vertical centerline until the handset (horizontal line) is parallel to the N-F line.
7. While maintaining the vertical centerline in the Reference Plane, keeping point A on the line passing through RE and LE, and maintaining the handset contact with the pinna, rotate the handset about the N-F line until any point on the handset is in contact with a phantom point below the pinna on the cheek.

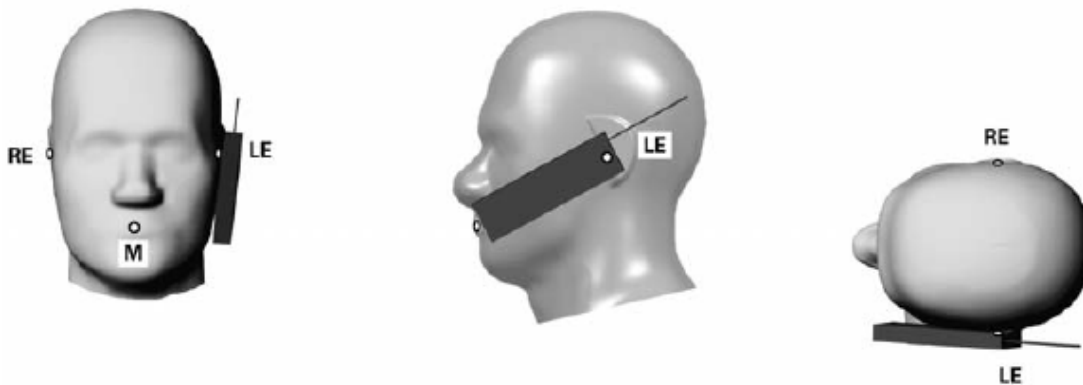

Definition of the tilt position

The tilt position is established as follows:

1. Repeat steps to place the device in the cheek position.
2. While maintaining the orientation of the handset, move the handset away from the pinna along the line passing through RE and LE far enough to allow a rotation of the handset away from the cheek by 15°.
3. Rotate the handset around the horizontal line by 15°.
4. While maintaining the orientation of the handset, move the handset towards the phantom on the line passing through RE and LE until any part of the handset touches the ear. The tilt position is obtained when the contact point is on the pinna. See the figure as below. If contact occurs at any location other than the pinna, e.g., the antenna at the back of the phantom head, the angle of the handset should be reduced.
5. In this case, the tilt position is obtained if any point on the handset is in contact with the pinna and a second point on the handset is in contact with the phantom, e.g., the antenna with the back of the head.

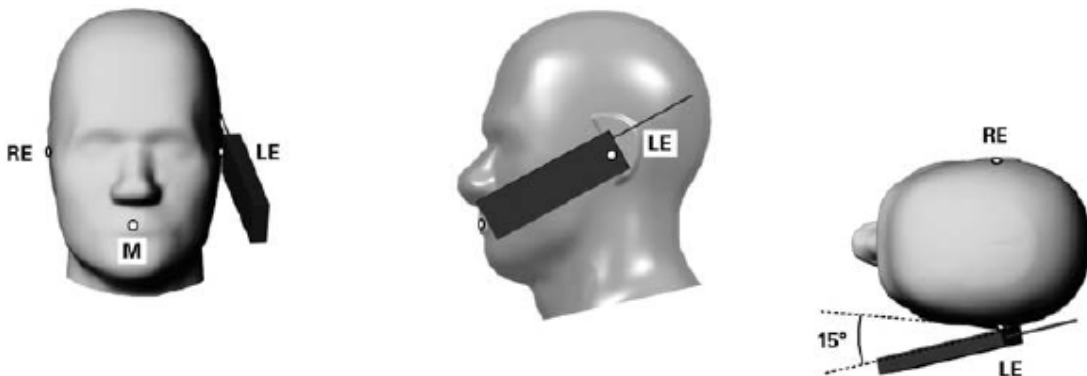

3.2 Device test positions relative to body-worn accessory

Body-worn operating configurations are tested with the belt-clips and holsters attached to the device and positioned against a flat phantom in a normal use configuration. The body-worn accessory procedures in FCC KDB Publication 447498 should be used to test for body-worn accessory SAR compliance, without a headset connected to it.

SAR evaluation is required for body-worn accessories supplied with the host device. The test configurations must be conservative for supporting the body-worn accessory use conditions expected by users. Body-worn accessories that do not contain metallic or conductive components may be tested according to worst-case exposure configurations, typically according to the smallest test separation distance required for the group of body-worn accessories with similar operating and exposure characteristics. All body-worn accessories containing metallic components, either supplied with the product or available as an option from the device manufacturer, must be tested in conjunction with the host device to demonstrate compliance

Body-worn accessories may not always be supplied or available as options for some devices intended to be authorized for body-worn use. In this case, a test configuration with a separation distance between the back of the device and the flat phantom is used. Test position spacing was documented. Transmitters that are designed to operate in front of a person's face, as in push-to-talk configurations, are tested for SAR compliance with the front of the device positioned to face the flat phantom in head fluid.

4. Tissue Verification

The head tissue parameter should be used to test operating frequency band of transmitters. When a transmission band overlaps with one of the target frequencies, the tissue dielectric parameters of the tissue medium at the middle of a device transmission band should be within $\pm 5\%$ of the parameters specified at that target frequency.

Brain Tissue Simulating Liquid Recipes

| Brain Ingredients Frequency (2450 MHz) | |
|--|---------|
| Tween20 | 44.67 % |
| De-ionised Water | 55.11 % |
| Acticide SPX | 0.22 % |

The dielectric parameters were verified prior to assessment using the AGILENTTECH 85033D calibration kit and the AGILENTTECH E5071B network Analyzer. The dielectric parameters were:

| Freq. (MHz) | Temp. (°C) | ϵ_r / Relative Permittivity | | | σ / Conductivity | | | ρ^{**} (kg/m ³) |
|-------------|------------|--------------------------------------|---------|------------------------|-------------------------|---------|------------------------|----------------------------------|
| | | measured | Target* | Δ ($\pm 5\%$) | measured | Target* | Δ ($\pm 5\%$) | |
| 2440 | 23.0 | 37.97 | 39.22 | -3.19% | 1.81 | 1.79 | 1.11% | 1000 |
| 2450 | 23.0 | 37.93 | 39.20 | -3.24% | 1.82 | 1.80 | 1.11% | 1000 |

* Target values refer to KDB 865664

** Worst-case assumption

Note:

1. Date of tissue verification measurement: 12 December, 2013
2. Ambient temperature: 23.0 deg C
3. The temperature condition is within +/- 2 deg. C during the SAR measurements.

Details of SAR Tissue specifications are shown in the Appendix D.

Body Tissue Simulating Liquid Recipes

| Body Ingredients Frequency (2450 MHz) | |
|---------------------------------------|---------|
| Tween20 | 28.79 % |
| De-ionised Water | 70.68 % |
| Acticide SPX | 0.28 % |
| Salt | 0.25 |

The dielectric parameters were verified prior to assessment using the AGILENTTECH 85033D calibration kit and the AGILENTTECH E5071B network Analyzer. The dielectric parameters were:

| Freq. (MHz) | Temp. (°C) | ϵ_r / Relative Permittivity | | | σ / Conductivity | | | ρ^{**} (kg/m ³) |
|-------------|------------|--------------------------------------|---------|------------------------|-------------------------|---------|------------------------|----------------------------------|
| | | measured | Target* | Δ ($\pm 5\%$) | measured | Target* | Δ ($\pm 5\%$) | |
| 2440 | 23.0 | 51.41 | 52.71 | -2.47% | 2.01 | 1.94 | 3.61% | 1000 |
| 2450 | 23.0 | 51.35 | 52.70 | -2.56% | 2.02 | 1.95 | 3.59% | 1000 |

* Target values refer to KDB 865664

** Worst-case assumption

Note:

1. Date of tissue verification measurement: 13 December, 2013
2. Ambient temperature: 23.0 deg C
3. The temperature condition is within +/- 2 deg. C during the SAR measurements.

Details of SAR Tissue specifications are shown in the Appendix D.

5. SAR measurement system verification

Routine record keeping procedures should be established for tracking the calibration and performance of SAR measurement system. When SAR measurements are performed, the entire measurement system should be checked daily within the device transmitting frequency ranges to verify system accuracy. A flat phantom irradiated by a half-wavelength dipole is typically used to verify the measurement accuracy of a system. According to KDB 865664, at 300MHz to 6GHz, measurements must be within ± 100 MHz of the probe calibration point frequency or the valid frequency range supported by the probe calibration, whichever is less. The measured one-gram SAR should be within 10% of the expected target values specified for the specific phantom and RF source used in the system verification measurement.

Procedures

The SAR evaluation was performed with the following procedures:

1. The SAR distribution was measured at the exposed side of the bottom of the box phantom and was measured at a distance of 15 mm for 300 ~ 1000 MHz and 10 mm for 1000 ~ 3000 MHz from the inner surface of the shell. The feed power was 1/5W.
2. The depth of tissue-equivalent liquid in a phantom must be $\geq 15.0\text{cm} \pm 0.5\text{cm}$ for SAR measurement $\leq 3000\text{MHz}$.
3. The dimension for this cube is 32 mm x 32 mm x 30 mm was assessed by measuring 5 x 5 x 7 points for 300 ~ 2000 MHz and 30 mm x 30 mm x 30 mm was assessed by measuring 7 x 7 x 7 points for 2000 ~ 3000 MHz. On the basis of this data set, the spatial peak SAR value was evaluated with the following procedure:
 - i. The data at the surface were extrapolated, since the center of the dipoles is 2.7 mm away from the tip of the probe and the distance between the surface and the lowest measurement point is 5 mm. The extrapolation was based on a least square algorithm. A polynomial of the fourth order was calculated through the points in Z-axes. This polynomial was then used to evaluate the points between the surface and the probe tip.
 - ii. The maximum interpolated value was searched with a straightforward algorithm. Around this maximum, the SAR values averaged over the spatial volumes (1g or 10g) were computed using the 3-D spline interpolation algorithm. The 3-D spline is composed of three one-dimensional splines with the "Not a knot" condition (in x, y and z directions). The volume was integrated with the trapezoidal algorithm. 1000 points (10 x 10 x 10) were interpolated to calculate the average.
 - iii. All neighboring volumes were evaluated until no neighboring volume with a higher average value was found.
4. Re-measurements of the SAR value at the same location as in step a. above. If the value changed by more than 5 %, the evaluation was repeated.
5. The test scan procedure for system verification also applies to the general scan procedure except for the set-up position. For general scan, the EUT was placed at the side of phantom. For Verification scan, the dipole antenna was placed at the bottom of phantom.

System Verification results

| System Verification (2450MHz) | | | | | | | | |
|-------------------------------|-------------|-------------|---------------|------------|---------------------------------|-----------------------------------|-------------------------------------|------------------|
| Date | Freq. (MHz) | Liquid Type | System Diople | Serial No. | Target SAR _{1g} (W/kg) | Measured SAR _{1g} (W/kg) | Normalized SAR _{1g} (W/kg) | Deviation (±10%) |
| 12 Dec 2013 | 2450 | Head | Type IXD-245 | 0048 | 49.24* | 9.77 | 48.85 | -0.79% |

* the target was quoted from 2450 dipole antenna calibration report

* Input power level = 23dBm (0.2W)

2450 Head SAR_{1g} ambient measured value: 0.001 (W/kg)

Details of System Verification plot is shown in the Appendix A - plot 1.

| System Verification (2450MHz) | | | | | | | | |
|-------------------------------|-------------|-------------|---------------|------------|---------------------------------|-----------------------------------|-------------------------------------|------------------|
| Date | Freq. (MHz) | Liquid Type | System Diople | Serial No. | Target SAR _{1g} (W/kg) | Measured SAR _{1g} (W/kg) | Normalized SAR _{1g} (W/kg) | Deviation (±10%) |
| 13 Dec 2013 | 2450 | Body | Type IXD-245 | 0048 | 43.9* | 9.14 | 45.70 | 4.10% |

* the target was quoted from 2450 dipole antenna calibration report

* Input power level = 23dBm (0.2W)

2450 Body SAR_{1g} ambient measured value: 0.001 (W/kg)

Details of System Verification plot is shown in the Appendix A - plot 2.

6. SAR Evaluation

6.1. RF Output Power Measurements

| Frequency | Channel | Duty Cycle | Measured Conducted Power (Peak) | Measured Conducted Power (Time average) |
|-----------|-------------|------------|---------------------------------|---|
| 2.4 GHz | Low – 0 | 17.9% | 19.54 dBm | 12.07 dBm |
| | Middle – 10 | | 19.05 dBm | 11.58 dBm |
| | High - 20 | | 19.18 dBm | 11.71 dBm |

Note:

1. Time Average power (dBm) = Peak power (dBm) + Time Average factor.
2. Time Average factor = $10 \cdot \log(\text{duty cycle}) = -7.47\text{dB}$
3. Fully charged battery was used for each measurement.
4. Per KDB 447498, when antenna port was not available on the device to support conducted power measurement and test software was used to establish transmitter power levels, the power level was verified separately according to design and component specifications and product development information specified by the manufacturer.
5. There was no power reduction used for any band/mode implemented in this device

6.2. Exposure Conditions

Head Exposure Conditions

| Test Configurations | Operation Mode | SAR Required | Note |
|---------------------|----------------|--------------|------|
| N/A | N/A | N/A | N/A |

Note:

- Next to ear operation was not supported for this device.

In-Front-of the Face Exposure Conditions

| Test Configurations | Distance to phantom | Operation Mode | SAR Required | Note |
|---------------------|---------------------|----------------|--------------|--|
| Front | 0mm | Voice | Yes | 3.6V 750mAh CR Ni-MH battery installed |
| Front | 0mm | Voice | Yes | 3.6V 750mAh GP Ni-MH battery installed |
| Front | 0mm | Voice | Yes | 3.6V 750mAh GY Ni-MH battery installed |

Note:

- Highest reported SAR test configuration was repeated for additional supported batteries.

Body Exposure Conditions

| Test Configurations | Distance to phantom | Operation Mode | SAR Required | Note |
|---------------------|---------------------|----------------|--------------|--|
| Front | 0mm | Voice | Yes | 3.6V 750mAh CR Ni-MH battery installed |
| Back | 0mm | Voice | Yes | 3.6V 750mAh CR Ni-MH battery installed |
| Back | 0mm | Voice | Yes | 3.6V 750mAh GP Ni-MH battery installed |
| Back | 0mm | Voice | Yes | 3.6V 750mAh GY Ni-MH battery installed |

Note:

- Highest reported SAR test configuration was repeated for additional supported batteries.

6.3. General Device Setup

The device was first charged over a duration defined by the applicant to make sure the installed batteries were fully charged when rechargeable batteries were applied.

The device was then placed into test mode to simulate the worst case data transmission configuration through the middle channel, where the operating parameters established in this test mode is identical to those programmed in production units, including output power levels, amplifier gain settings and other RF performance tuning parameters. The test frequency is corresponded to actual channel frequencies defined for domestic use.

During testing, the device was evaluated with a fully charged rechargeable, and was configured to operate at maximum output power. A receive antenna and a spectrum analyzer were placed with a distance > 50cm away from the device to monitor the transmission states.

In order to verify that the device was tested throughout the SAR test at maximum output power, the SAR measurement system measures a “point SAR” at an arbitrary reference point at the start and end of the 1 gram SAR evaluation, to assess for any power drifts during the evaluation. If the power drift deviated by more than 5%, the SAR test and drift measurements were repeated.

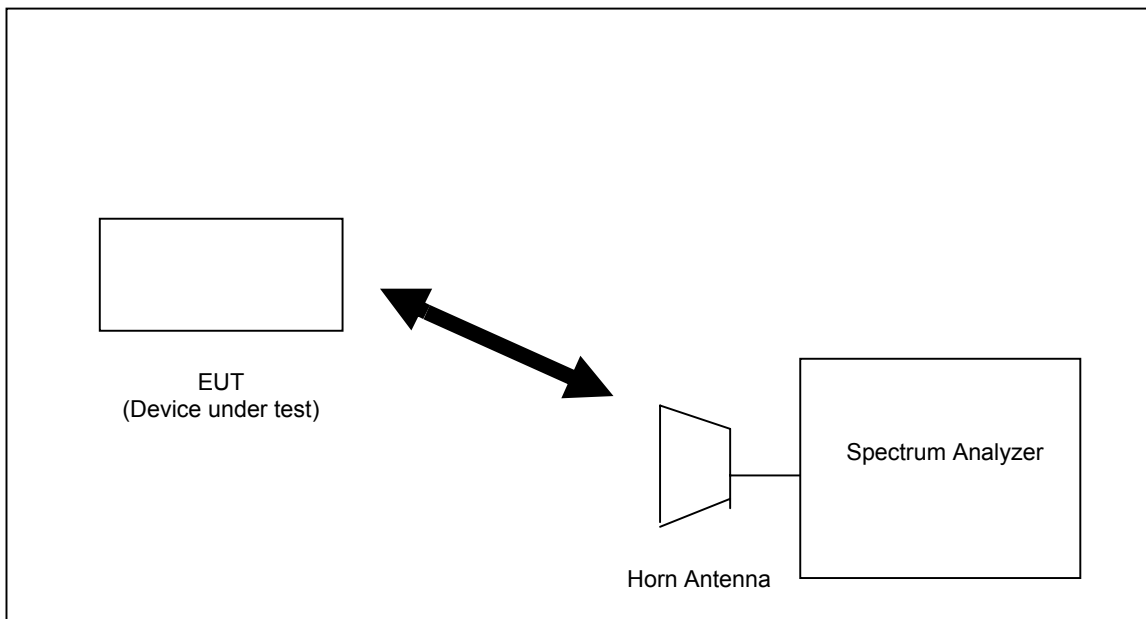

SAR Test Device Set Up block diagram

6.4. Test Result

The results on the following page(s) were obtained when the device was tested in the condition described in this report. Detailed measurement data and plots, which reveal information about the location of the maximum SAR with respect to the device, are reported in Appendix B.

In-Front-of the Face SAR

| Measurement Result | | | | | | | | | | |
|--------------------|-------------|----------------|----------------|---------------|-----------------------------|----------------------|-----------------------------------|----------------|-----------------------------------|------|
| Channel | Freq. (MHz) | Battery | Operation Mode | Test Position | Maximum Allowed Power (dBm) | Measured Power (dBm) | Measured SAR _{1g} (W/kg) | Scaling factor | Reported SAR _{1g} (W/kg) | Plot |
| 10 | 2441.25 | 3.6V 750mAh CR | Voice | Front | 20 | 19.05 | 0.167 | 1.24 | 0.207 | 1 |
| 10 | 2441.25 | 3.6V 750mAh GP | Voice | Front | 20 | 19.05 | 0.162 | 1.24 | 0.201 | 2 |
| 10 | 2441.25 | 3.6V 750mAh GY | Voice | Front | 20 | 19.05 | 0.165 | 1.24 | 0.205 | 3 |

Note:

1. Fully charged batteries were used at the beginning of the SAR measurements.
2. There was no power reduction used for any band/mode implemented in this device.
3. There was no proximity sensor installed in this device.
4. Device was tested with a separation distance of 0mm touching the phantom.
5. Per KDB 447498, the tested device was within the specified tune-up tolerances range, but not more than 2dB lower than the maximum tune-up tolerance limit and the reported SAR results were scaled to the maximum allowed power with the scaling factor $10^{[(Maximum\ power - measured\ power) / 10]}$.
6. Per KDB 447498, when the maximum output power variation across the required test channels was < 0.5dB, measurement on middle channel was required.
7. Per KDB 447498, if the reported 1g SAR value was ≤ 0.8 W/kg and the transmission band was ≤ 100 MHz, SAR testing was not required for the other test channels in the band.
8. Per KDB 865664, repeated measurement was not required when the original highest measured 1g SAR was < 0.8W/kg.

Body SAR

| Measurement Result | | | | | | | | | | |
|--------------------|-------------|----------------|----------------|---------------|-----------------------------|----------------------|-----------------------------------|----------------|-----------------------------------|------|
| Channel | Freq. (MHz) | Battery | Operation Mode | Test Position | Maximum Allowed Power (dBm) | Measured Power (dBm) | Measured SAR _{1g} (W/kg) | Scaling factor | Reported SAR _{1g} (W/kg) | Plot |
| 10 | 2441.25 | 3.6V 750mAh CR | Voice | Front | 20 | 19.05 | 0.148 | 1.24 | 0.184 | 4 |
| 10 | 2441.25 | 3.6V 750mAh CR | Voice | Back | 20 | 19.05 | 0.204 | 1.24 | 0.253 | 5 |
| 10 | 2441.25 | 3.6V 750mAh GP | Voice | Back | 20 | 19.05 | 0.190 | 1.24 | 0.236 | 6 |
| 10 | 2441.25 | 3.6V 750mAh GY | Voice | Back | 20 | 19.05 | 0.181 | 1.24 | 0.224 | 7 |

Note:

1. Fully charged batteries were used at the beginning of the SAR measurements.
2. There was no power reduction used for any band/mode implemented in this device.
3. There was no proximity sensor installed in this device.
4. Device was tested with a separation distance of 0mm touching the phantom.
5. Per KDB 447498, the tested device was within the specified tune-up tolerances range, but not more than 2dB lower than the maximum tune-up tolerance limit and the reported SAR results were scaled to the maximum allowed power with the scaling factor $10^{[(Maximum\ power - measured\ power) / 10]}$.
6. Per KDB 447498, when the maximum output power variation across the required test channels was < 0.5dB, measurement on middle channel was required.
7. Per KDB 447498, if the reported 1g SAR value was $\leq 0.8\ W/kg$ and the transmission band was $\leq 100MHz$, SAR testing was not required for the other test channels in the band.
8. Per KDB 865664, repeated measurement was not required when the original highest measured 1g SAR was < 0.8W/kg.

6.5 SAR Limits

The following FCC limits (Std. C95.1-1992) for SAR apply to devices operate in General Population/Uncontrolled Exposure and Controlled environment:

General Population / Uncontrolled Environments:

Defined as location where there is the exposure of individuals who have no knowledge or control of their exposure.

| EXPOSURE (General Population/Uncontrolled Exposure environment) | SAR (W/kg) |
|--|---------------|
| Spatial Peak SAR (Head)* | 1.60 |
| Spatial Peak SAR (Partial Body)* | 1.60 |
| Spatial Peak SAR (Whole Body)* | 0.08 |
| Spatial Peak SAR (Hands / Wrists / Feet / Ankles)** | 4.00 |

Occupational / Controlled Environments:

Defined as location where there is the exposure that may be incurred by persons who are aware of the potential for exposure, (i.e. as a result of employment or occupation)

| EXPOSURE (Occupational/Controlled Exposure environment) | SAR (W/kg) |
|--|---------------|
| Spatial Peak SAR (Head)* | 8.00 |
| Spatial Peak SAR (Partial Body)* | 8.00 |
| Spatial Peak SAR (Whole Body)* | 0.40 |
| Spatial Peak SAR (Hands / Wrists / Feet / Ankles)** | 20.00 |

Notes:

* The Spatial Peak value of the SAR averaged over any 1 gram of tissue. (defined as a tissue volume in the shape of a cube) and over the appropriate averaging time

** The Spatial Peak value of the SAR averaged over any 10 gram of tissue. (defined as a tissue volume in the shape of a cube) and over the appropriate averaging time

7. Test Instruments

Instruments List

The Specific Absorption Rate (SAR) tests were performed with the INDEXSAR SARA2 SYSTEM.
The following major equipment/components were used for the SAR evaluations:

| SAR Measurement System | | | | |
|---|--|-------------------|-------------------|-------------------|
| EQUIPMENT | SPECIFICATIONS | Intertek ID No. | Last Cal. | Due Date |
| Balanced Validation Dipole Antenna | 2450MHz | EW-2900-04 | 09/03/2012 | 09/03/2015 |
| Controller | Mitsubishi CR-E116 | EW-2902-04 | N/A | |
| Robot | Mitsubishi RV-E2 | EW-2902-05 | N/A | |
| | Repeatability: ± 0.04 mm; Number of Axes: 6 | | | |
| E-Field Probe | IXP-050 | EW-2900-01 | 16/02/2013 | 16/02/2015 |
| | Frequency Range: 450 MHz – 3000 MHz Probe outer diameter: 5.2 mm; Length: 350 mm; Distance between the probe tip and the dipole center: 2.7 mm | | | |
| Data Acquisition | SARA2 | N/A | N/A | |
| | Processor: Pentium 4; Clock speed: 1.5GHz; OS: Windows XP; I/O: two RS232; Software: SARA2 ver. 2.54 VPM | | | |
| Phantom | Upright Head Specific Anthropomorphic Mannequin (SAM) phantom, 2mm wall thickness box phantom | N/A | N/A | |
| | The head and body phantom shell should be made of low-loss dielectric material with dielectric constant and loss tangent less than 5.0 and 0.05 respectively. The shell thickness for all regions coupled to the test device and its antenna should be within 2.0 ± 0.2 mm. The phantom should be filled with the required head or body equivalent tissue medium to a depth of 15.0 ± 0.5 cm. Body capacity: 168 x 395 x 174 (W x L x D) mm ³ . | | | |
| Device holder | Material: clear Perspex | N/A | N/A | |
| | Dielectric constant: less than 2.85 Loss Tangent of the device holder: less than 0.05 | | | |
| Simulated Tissue for Head | Mixture | N/A | 12/12/2013 | |
| | Please see section 4.0 for details | | | |
| Simulated Tissue for Body | Mixture | N/A | 13/12/2013 | |
| | Please see section 4.0 for details | | | |
| RF Power Meter | AGILENTTECH N1911A | EW-2270b | 26/01/2013 | 26/01/2014 |
| | Frequency Range: 50 MHz to 18 GHz, -35~+20dBm | | | |
| Vector Network Analyzer | AGILENTTECH E5071B | EW-9001 | 30/01/2013 | 30/01/2014 |
| | 9kHz to 8.5GHz | | | |
| Signal Generator | AGILENTTECH E4421B | EW-1244 | 17/06/2013 | 17/06/2014 |
| | 250kHz to 3GHz | | | |

Note: The above equipments are within the valid calibration period

8. Measurement Uncertainty

Per FCC KDB 865884, the extensive SAR measurement uncertainty analysis was not required when the highest measured SAR was $< 1.5\text{W/kg}$ for all frequency band.

9. E-Field Probe and Dipole Antenna Calibration

Probe calibration factors and dipole antenna calibration are included in Appendix C.

10. References

- [1] IEEE Recommended Practice for Determining the Peak Spatial-Average Specific Absorption Rate (SAR) in the Human Head from Wireless Communications Devices: Measurement Techniques”, IEEE Std 1528TM-2003
- [2] IEEE Recommended Practice for Determining the Peak Spatial-Average Specific Absorption Rate (SAR) in the Human Head from Wireless Communications Devices: Measurement Techniques - Amendment 1: CAD File for Human Head Model (SAM Phantom) , IEEE Std 1528aTM-2005
- [3] FCC KDB Publication 865664 D01 SAR measurement 100MHz to 6GHz v01r02
- [4] FCC KDB Publication 865664 D02 SAR Reporting v01r01
- [5] FCC KDB Publication 447498 D01 General RF Exposure Guidance v05r01

APPENDIX A – System Verification Data

Plot #1

| | | | |
|------------------------|-------------------------|--------------------------|-----------------------|
| Date / Time: | 12/12/2013 09:56:51 AM | Position: | Bottom of Box Phantom |
| Filename: | 2450H_VAL_12_12_2013.tx | Phantom: | HeadBox1-val.csv |
| Device Tested: | 2450_Val | Test Channel: | N/A |
| Antenna: | 2450MHz Dipole | Test Frequency: | 2450MHz |
| Shape File: | none.csv | Power Level: | 23dBm |
| Operation Mode: | N/A | Modn. Duty Cycle: | N/A |

| Probe: | 0136 | | | | | | | | | | | | | | | | |
|-----------------------|---|------|------|-----|---|------------|-----|-----|-----|------------|----|----|----|------------|------|------|------|
| Cal File: | SN0136_2450_HEAD | | | | | | | | | | | | | | | | |
| Cal Factors: | <table border="1"> <thead> <tr> <th></th> <th>X</th> <th>Y</th> <th>Z</th> </tr> </thead> <tbody> <tr> <td>Air</td> <td>459</td> <td>362</td> <td>378</td> </tr> <tr> <td>DCP</td> <td>20</td> <td>20</td> <td>20</td> </tr> <tr> <td>Lin</td> <td>.424</td> <td>.424</td> <td>.424</td> </tr> </tbody> </table> | | X | Y | Z | Air | 459 | 362 | 378 | DCP | 20 | 20 | 20 | Lin | .424 | .424 | .424 |
| | | X | Y | Z | | | | | | | | | | | | | |
| | Air | 459 | 362 | 378 | | | | | | | | | | | | | |
| | DCP | 20 | 20 | 20 | | | | | | | | | | | | | |
| Lin | .424 | .424 | .424 | | | | | | | | | | | | | | |
| Extrapolation: | Poly 4 | | | | | | | | | | | | | | | | |

| | |
|-------------------------------|---------------|
| Liquid Depth: | 15.5 cm |
| Liquid Type: | 2450 MHz Head |
| Conductivity: | 1.82 |
| Relative Permittivity: | 37.93 |
| Liquid Temp (Before): | 22.5 |
| Liquid Temp (After): | 22.5 |
| Ambient Temp: | 23.0 |
| Ambient RH (%): | 53 % |
| Density (kg/m3): | 1000 |

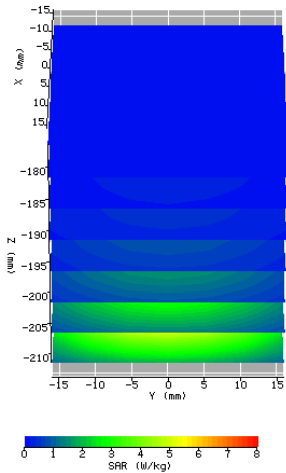

ZOOM SCAN RESULTS:

| | | |
|-------------------------|-------------------|-----------------|
| Spot SAR (W/kg): | Start Scan | End Scan |
| | 0.740 | 0.733 |

Change during Scan (%) -0.94%

Max E-field (V/m): 73.38

| | | |
|-----------------------|-----------|------------|
| Max SAR (W/kg) | 1g | 10g |
| | 9.765 | 4.573 |

Max Spot SAR (W/kg): 9.8

| | | | |
|------------------------------|----------|----------|----------|
| Location of Max (mm): | X | Y | Z |
| | 0.0 | 0.0 | -219.4 |

Measurement Resolution (7x7x7):
dx = 5mm, dy = 5mm, dz = 5mm

Normalized to an input power of 1W and averaged over 10g of tissue –
Max SAR =48.85 W/kg

Plot #2

| | | | |
|------------------------|--------------------------|--------------------------|-----------------------|
| Date / Time: | 13/12/2013 10:14:42 AM | Position: | Bottom of Box Phantom |
| Filename: | 2450B_VAL_13_12_2013.txt | Phantom: | HeadBox1-val.csv |
| Device Tested: | 2450_Val | Test Channel: | N/A |
| Antenna: | 2450MHz Dipole | Test Frequency: | 2450MHz |
| Shape File: | none.csv | Power Level: | 23dBm |
| Operation Mode: | N/A | Modn. Duty Cycle: | N/A |

| Probe: | 0136 | | | | | | | | | | | | | | | | |
|-----------------------|---|------|------|-----|---|------------|-----|-----|-----|------------|----|----|----|------------|------|------|------|
| Cal File: | SN0136_2450_BODY | | | | | | | | | | | | | | | | |
| Cal Factors: | <table border="1"> <thead> <tr> <th></th> <th>X</th> <th>Y</th> <th>Z</th> </tr> </thead> <tbody> <tr> <td>Air</td> <td>459</td> <td>362</td> <td>378</td> </tr> <tr> <td>DCP</td> <td>20</td> <td>20</td> <td>20</td> </tr> <tr> <td>Lin</td> <td>.478</td> <td>.478</td> <td>.478</td> </tr> </tbody> </table> | | X | Y | Z | Air | 459 | 362 | 378 | DCP | 20 | 20 | 20 | Lin | .478 | .478 | .478 |
| | | X | Y | Z | | | | | | | | | | | | | |
| | Air | 459 | 362 | 378 | | | | | | | | | | | | | |
| | DCP | 20 | 20 | 20 | | | | | | | | | | | | | |
| Lin | .478 | .478 | .478 | | | | | | | | | | | | | | |
| Extrapolation: | Poly 4 | | | | | | | | | | | | | | | | |

| | |
|-------------------------------|---------------|
| Liquid Depth: | 15.5 cm |
| Liquid Type: | 2450 MHz Head |
| Conductivity: | 2.02 |
| Relative Permittivity: | 51.35 |
| Liquid Temp (Before): | 23.0 |
| Liquid Temp (After): | 23.0 |
| Ambient Temp: | 23.0 |
| Ambient RH (%): | 51 % |
| Density (kg/m3): | 1000 |

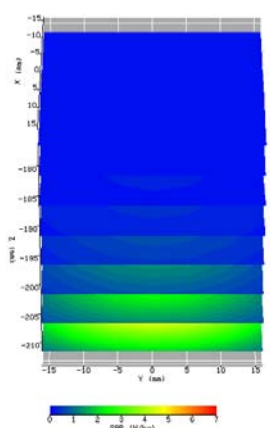

ZOOM SCAN RESULTS:

| | | |
|-------------------------|-------------------|-----------------|
| Spot SAR (W/kg): | Start Scan | End Scan |
| | 0.581 | 0.572 |

Change during Scan (%): -1.62%

Max E-field (V/m): 66.67

| | | |
|-----------------------|-----------|------------|
| Max SAR (W/kg) | 1g | 10g |
| | 9.139 | 4.284 |

Max Spot SAR (W/kg): 9.2

| | | | |
|------------------------------|----------|----------|----------|
| Location of Max (mm): | X | Y | Z |
| | 0.0 | 0.0 | -219.4 |

Measurement Resolution (7x7x7):
dx = 5mm, dy = 5mm, dz = 5mm

Normalized to an input power of 1W and averaged over 10g of tissue –
Max SAR = 45.7W/kg

APPENDIX B – SAR Evaluation Data
Plot #1

| | | | |
|------------------------|--|--------------------------|-----------------------|
| Date / Time: | 12/12/2013 02:43:18 PM | Position: | Front, 0mm separation |
| Filename: | VM311_2450H_Front_M_CR_12_12_2013.txt | Phantom: | HeadBox2-test.csv |
| Device Tested: | VM311 PU | Test Channel: | Middle |
| Antenna: | Integral Antenna | Test Frequency: | 2441.25 MHz |
| Battery used: | 3.6V 750mAH Ni-MH CR BT185645 / BT285645 | Power Level: | 19.05 dBm |
| Operation Mode: | Voice call | Modn. Dutv Cvcle: | 17.9% |

| Probe: | 0136 | | | | | | | | | | | | | | | | |
|-----------------------|---|------|------|-----|---|------------|-----|-----|-----|------------|----|----|----|------------|------|------|------|
| Cal File: | SN0136_2450_HEAD | | | | | | | | | | | | | | | | |
| Cal Factors: | <table border="1"> <thead> <tr> <th></th> <th>X</th> <th>Y</th> <th>Z</th> </tr> </thead> <tbody> <tr> <td>Air</td> <td>459</td> <td>362</td> <td>378</td> </tr> <tr> <td>DCP</td> <td>20</td> <td>20</td> <td>20</td> </tr> <tr> <td>Lin</td> <td>.424</td> <td>.424</td> <td>.424</td> </tr> </tbody> </table> | | X | Y | Z | Air | 459 | 362 | 378 | DCP | 20 | 20 | 20 | Lin | .424 | .424 | .424 |
| | | X | Y | Z | | | | | | | | | | | | | |
| | Air | 459 | 362 | 378 | | | | | | | | | | | | | |
| | DCP | 20 | 20 | 20 | | | | | | | | | | | | | |
| Lin | .424 | .424 | .424 | | | | | | | | | | | | | | |
| Extrapolation: | Poly 4 | | | | | | | | | | | | | | | | |

| | |
|-------------------------------|---------------|
| Liquid Depth: | 15.5 cm |
| Liquid Type: | 2450 MHz Head |
| Conductivity: | 1.81 |
| Relative Permittivity: | 37.97 |
| Liquid Temp (Before): | 22.5 deg |
| Liquid Temp (After): | 22.8 deg |
| Ambient Temp: | 23.0 deg |
| Ambient RH (%): | 55 |

AREA SCAN:

| | Min | Max |
|---------------------|--------|--------|
| Scan Extent: | | |
| Y | -60.0 | 60.0 |
| Z | -160.0 | -100.0 |

Measurement Resolution (13x7):
dy = 10mm, dz = 10mm,

ZOOM SCAN RESULTS:

| | Start Scan | End Scan | |
|-------------------------------|------------|------------|----------|
| Spot SAR (W/kg): | 0.019 | 0.019 | |
| Change during Scan (%) | 0.73% | | |
| Max E-field(V/m): | 9.76 | | |
| Max SAR (W/kg) | 1g | 10g | |
| | 0.167 | 0.090 | |
| Max Spot SAR (W/kg): | 0.17 | | |
| Location of Max (mm): | X | Y | Z |
| | 78.1 | -52.9 | -128.3 |

Measurement Resolution (7x7x7):
dx = 5mm, dy = 5mm, dz = 5mm

Plot #2

| | | | |
|------------------------|--|--------------------------|-----------------------|
| Date / Time: | 12/12/2013 03:52:11 PM | Position: | Front, 0mm separation |
| Filename: | VM311_2450H_Front_M_GP_12_12_2013.txt | Phantom: | HeadBox2-test.csv |
| Device Tested: | VM311 PU | Test Channel: | Middle |
| Antenna: | Integral Antenna | Test Frequency: | 2441.25 MHz |
| Battery used: | 3.6V 750mAH Ni-MH GP BT185645 / BT285645 | Power Level: | 19.05 dBm |
| Operation Mode: | Voice call | Modn. Dutv Cvcle: | 17.9% |

| Probe: | 0136 | | | | | | | | | | | | | | | | |
|-----------------------|---|------|------|-----|---|------------|-----|-----|-----|------------|----|----|----|------------|------|------|------|
| Cal File: | SN0136_2450_HEAD | | | | | | | | | | | | | | | | |
| Cal Factors: | <table border="1"> <thead> <tr> <th></th> <th>X</th> <th>Y</th> <th>Z</th> </tr> </thead> <tbody> <tr> <td>Air</td> <td>459</td> <td>362</td> <td>378</td> </tr> <tr> <td>DCP</td> <td>20</td> <td>20</td> <td>20</td> </tr> <tr> <td>Lin</td> <td>.424</td> <td>.424</td> <td>.424</td> </tr> </tbody> </table> | | X | Y | Z | Air | 459 | 362 | 378 | DCP | 20 | 20 | 20 | Lin | .424 | .424 | .424 |
| | | X | Y | Z | | | | | | | | | | | | | |
| | Air | 459 | 362 | 378 | | | | | | | | | | | | | |
| | DCP | 20 | 20 | 20 | | | | | | | | | | | | | |
| Lin | .424 | .424 | .424 | | | | | | | | | | | | | | |
| Extrapolation: | Poly 4 | | | | | | | | | | | | | | | | |

| | |
|-------------------------------|---------------|
| Liquid Depth: | 15.5 cm |
| Liquid Type: | 2450 MHz Head |
| Conductivity: | 1.81 |
| Relative Permittivity: | 37.97 |
| Liquid Temp (Before): | 22.5 deg |
| Liquid Temp (After): | 22.8 deg |
| Ambient Temp: | 23.0 deg |
| Ambient RH (%): | 55 |

AREA SCAN:

| | Min | Max |
|---------------------|--------|--------|
| Scan Extent: | | |
| Y | -60.0 | 60.0 |
| Z | -160.0 | -100.0 |

Measurement Resolution (13x7):
dy = 10mm, dz = 10mm,

ZOOM SCAN RESULTS:

| | | | |
|-------------------------------|-------------------|-----------------|----------|
| Spot SAR (W/kg): | Start Scan | End Scan | |
| | 0.020 | 0.019 | |
| Change during Scan (%) | -3.40% | | |
| Max E-field(V/m): | 9.58 | | |
| Max SAR (W/kg) | 1g | 10g | |
| | 0.162 | 0.086 | |
| Max Spot SAR (W/kg): | 0.17 | | |
| Location of Max (mm): | X | Y | Z |
| | 78.1 | -49.2 | -130.2 |
| | | | |

Measurement Resolution (7x7x7):
dx = 5mm, dy = 5mm, dz = 5mm

Plot #3

| | | | |
|------------------------|--|--------------------------|-----------------------|
| Date / Time: | 12/12/2013 05:13:44 PM | Position: | Front, 0mm separation |
| Filename: | VM311_2450H_Front_M_GY_12_12_2013.txt | Phantom: | HeadBox2-test.csv |
| Device Tested: | VM311 PU | Test Channel: | Middle |
| Antenna: | Integral Antenna | Test Frequency: | 2441.25 MHz |
| Battery used: | 3.6V 750mAh Ni-MH GY BT185645 / BT285645 | Power Level: | 19.05 dBm |
| Operation Mode: | Voice call | Modn. Dutv Cvcle: | 17.9% |

| Probe: | 0136 | | | | | | | | | | | | | | | | |
|-----------------------|---|------|------|-----|---|------------|-----|-----|-----|------------|----|----|----|------------|------|------|------|
| Cal File: | SN0136_2450_HEAD | | | | | | | | | | | | | | | | |
| Cal Factors: | <table border="1"> <tr> <th></th> <th>X</th> <th>Y</th> <th>Z</th> </tr> <tr> <td>Air</td> <td>459</td> <td>362</td> <td>378</td> </tr> <tr> <td>DCP</td> <td>20</td> <td>20</td> <td>20</td> </tr> <tr> <td>Lin</td> <td>.424</td> <td>.424</td> <td>.424</td> </tr> </table> | | X | Y | Z | Air | 459 | 362 | 378 | DCP | 20 | 20 | 20 | Lin | .424 | .424 | .424 |
| | | X | Y | Z | | | | | | | | | | | | | |
| | Air | 459 | 362 | 378 | | | | | | | | | | | | | |
| | DCP | 20 | 20 | 20 | | | | | | | | | | | | | |
| Lin | .424 | .424 | .424 | | | | | | | | | | | | | | |
| Extrapolation: | Poly 4 | | | | | | | | | | | | | | | | |

| | |
|-------------------------------|---------------|
| Liquid Depth: | 15.5 cm |
| Liquid Type: | 2450 MHz Head |
| Conductivity: | 1.81 |
| Relative Permittivity: | 37.97 |
| Liquid Temp (Before): | 22.8 deg |
| Liquid Temp (After): | 22.8 deg |
| Ambient Temp: | 23.0 deg |
| Ambient RH (%): | 55 |

AREA SCAN:

| | Min | Max |
|---------------------|--------|--------|
| Scan Extent: | | |
| Y | -60.0 | 60.0 |
| Z | -160.0 | -100.0 |

Measurement Resolution (13x7):
dy = 10mm, dz = 10mm,

ZOOM SCAN RESULTS:

| | | |
|--------------------------------|-------------------|-----------------|
| Spot SAR (W/kg): | Start Scan | End Scan |
| | 0.020 | 0.021 |
| Change during Scan (%): | 3.36 % | |
| Max E-field(V/m): | 9.64 | |
| Max SAR (W/kg) | 1g | 10g |
| | 0.165 | 0.088 |
| Max Spot SAR (W/kg): | 0.17 | |
| Location of Max (mm): | X | Y |
| | 78.1 | -50.2 |
| | | Z |
| | | -129.3 |

Measurement Resolution (7x7x7):
dx = 5mm, dy = 5mm, dz = 5mm

Plot #4

| | | | |
|------------------------|--|--------------------------|-----------------------|
| Date / Time: | 13/12/2013 11:32:41 AM | Position: | Front, 0mm separation |
| Filename: | VM311_2450B_Front_M_CR_13_12_2013.txt | Phantom: | HeadBox2-test.csv |
| Device Tested: | VM311 PU | Test Channel: | Middle |
| Antenna: | Integral Antenna | Test Frequency: | 2441.25 MHz |
| Battery used: | 3.6V 750mAh Ni-MH CR BT185645 / BT285645 | Power Level: | 19.05 dBm |
| Operation Mode: | Voice call | Modn. Dutv Cvcle: | 17.9% |

| Probe: | 0136 | | | | | | | | | | | | | | | | |
|-----------------------|--|------|------|-----|---|-----|-----|-----|-----|-----|----|----|----|-----|------|------|------|
| Cal File: | SN0136_2450_BODY | | | | | | | | | | | | | | | | |
| Cal Factors: | <table border="1"> <thead> <tr> <th></th> <th>X</th> <th>Y</th> <th>Z</th> </tr> </thead> <tbody> <tr> <td>Air</td> <td>459</td> <td>362</td> <td>378</td> </tr> <tr> <td>DCP</td> <td>20</td> <td>20</td> <td>20</td> </tr> <tr> <td>Lin</td> <td>.478</td> <td>.478</td> <td>.478</td> </tr> </tbody> </table> | | X | Y | Z | Air | 459 | 362 | 378 | DCP | 20 | 20 | 20 | Lin | .478 | .478 | .478 |
| | | X | Y | Z | | | | | | | | | | | | | |
| | Air | 459 | 362 | 378 | | | | | | | | | | | | | |
| | DCP | 20 | 20 | 20 | | | | | | | | | | | | | |
| Lin | .478 | .478 | .478 | | | | | | | | | | | | | | |
| Extrapolation: | Poly 4 | | | | | | | | | | | | | | | | |

| | |
|-------------------------------|---------------|
| Liquid Depth: | 15.5 cm |
| Liquid Type: | 2450 MHz Body |
| Conductivity: | 2.01 |
| Relative Permittivity: | 51.41 |
| Liquid Temp (Before): | 23.0 deg |
| Liquid Temp (After): | 23.0 deg |
| Ambient Temp: | 23.5 deg |
| Ambient RH (%): | 58 |

AREA SCAN:

| | | |
|---------------------|------------|------------|
| | Min | Max |
| Scan Extent: | | |
| Y | -60.0 | 60.0 |
| Z | -160.0 | -100.0 |

Measurement Resolution (13x7):
dy = 10mm, dz = 10mm,

ZOOM SCAN RESULTS:

| | | |
|-------------------------------|-------------------|-----------------|
| Spot SAR (W/kg): | Start Scan | End Scan |
| | 0.021 | 0.020 |
| Change during Scan (%) | -3.98 | |
| Max E-field(V/m): | 8.63 | |
| Max SAR (W/kg) | 1g | 10g |
| | 0.148 | 0.077 |
| Max Spot SAR (W/kg): | 0.15 | |
| Location of Max (mm): | X | Y |
| | 78.1 | -46.5 |
| | | Z |
| | | -132.1 |

Measurement Resolution (7x7x7):
dx = 5mm, dy = 5mm, dz = 5mm

Plot #5

| | | | |
|------------------------|--|--------------------------|----------------------|
| Date / Time: | 13/12/2013 02:45:21 PM | Position: | Back, 0mm separation |
| Filename: | VM311_2450B_Back_M_CR_13_12_2013.txt | Phantom: | HeadBox2-test.csv |
| Device Tested: | VM311 PU | Test Channel: | Middle |
| Antenna: | Integral Antenna | Test Frequency: | 2441.25 MHz |
| Battery used: | 3.6V 750mAh Ni-MH CR BT185645 / BT285645 | Power Level: | 19.05 dBm |
| Operation Mode: | Voice call | Modn. Dutv Cvcle: | 17.9% |

| Probe: | 0136 | | | | | | | | | | | | | | | | |
|-----------------------|---|------|------|-----|---|------------|-----|-----|-----|------------|----|----|----|------------|------|------|------|
| Cal File: | SN0136_2450_BODY | | | | | | | | | | | | | | | | |
| Cal Factors: | <table border="1"> <thead> <tr> <th></th> <th>X</th> <th>Y</th> <th>Z</th> </tr> </thead> <tbody> <tr> <td>Air</td> <td>459</td> <td>362</td> <td>378</td> </tr> <tr> <td>DCP</td> <td>20</td> <td>20</td> <td>20</td> </tr> <tr> <td>Lin</td> <td>.478</td> <td>.478</td> <td>.478</td> </tr> </tbody> </table> | | X | Y | Z | Air | 459 | 362 | 378 | DCP | 20 | 20 | 20 | Lin | .478 | .478 | .478 |
| | | X | Y | Z | | | | | | | | | | | | | |
| | Air | 459 | 362 | 378 | | | | | | | | | | | | | |
| | DCP | 20 | 20 | 20 | | | | | | | | | | | | | |
| Lin | .478 | .478 | .478 | | | | | | | | | | | | | | |
| Extrapolation: | Poly 4 | | | | | | | | | | | | | | | | |

| | |
|-------------------------------|---------------|
| Liquid Depth: | 15.5 cm |
| Liquid Type: | 2450 MHz Body |
| Conductivity: | 2.01 |
| Relative Permittivity: | 51.41 |
| Liquid Temp (Before): | 23.0 deg |
| Liquid Temp (After): | 23.0 deg |
| Ambient Temp: | 23.5 deg |
| Ambient RH (%): | 58 |

AREA SCAN:

| | | |
|---------------------|------------|------------|
| | Min | Max |
| Scan Extent: | | |
| Y | -60.0 | 60.0 |
| Z | -160.0 | -100.0 |

Measurement Resolution (13x7):
dy = 10mm, dz = 10mm,

ZOOM SCAN RESULTS:

| | | |
|-------------------------------|-------------------|-----------------|
| Spot SAR (W/kg): | Start Scan | End Scan |
| | 0.032 | 0.031 |
| Change during Scan (%) | -3.13% | |
| Max E-field(V/m): | 10.35 | |
| Max SAR (W/kg) | 1g | 10g |
| | 0.204 | 0.111 |
| Max Spot SAR (W/kg): | 0.22 | |
| Location of Max (mm): | X | Y |
| | 78.1 | -56.6 |
| | Z | -136.7 |

Measurement Resolution (7x7x7):
dx = 5mm, dy = 5mm, dz = 5mm

Plot #6

| | | | |
|------------------------|--|--------------------------|----------------------|
| Date / Time: | 13/12/2013 03:52:57 PM | Position: | Back, 0mm separation |
| Filename: | VM311_2450B_Back_M_GP_13_12_2013.txt | Phantom: | HeadBox2-test.csv |
| Device Tested: | VM311 PU | Test Channel: | Middle |
| Antenna: | Integral Antenna | Test Frequency: | 2441.25 MHz |
| Battery used: | 3.6V 750mAh Ni-MH GP BT185645 / BT285645 | Power Level: | 19.05 dBm |
| Operation Mode: | Voice call | Modn. Dutv Cvcle: | 17.9% |

| Probe: | 0136 | | | | | | | | | | | | | | | | |
|-----------------------|--|------|------|-----|---|-----|-----|-----|-----|-----|----|----|----|-----|------|------|------|
| Cal File: | SN0136_2450_BODY | | | | | | | | | | | | | | | | |
| Cal Factors: | <table border="1"> <thead> <tr> <th></th> <th>X</th> <th>Y</th> <th>Z</th> </tr> </thead> <tbody> <tr> <td>Air</td> <td>459</td> <td>362</td> <td>378</td> </tr> <tr> <td>DCP</td> <td>20</td> <td>20</td> <td>20</td> </tr> <tr> <td>Lin</td> <td>.478</td> <td>.478</td> <td>.478</td> </tr> </tbody> </table> | | X | Y | Z | Air | 459 | 362 | 378 | DCP | 20 | 20 | 20 | Lin | .478 | .478 | .478 |
| | | X | Y | Z | | | | | | | | | | | | | |
| | Air | 459 | 362 | 378 | | | | | | | | | | | | | |
| | DCP | 20 | 20 | 20 | | | | | | | | | | | | | |
| Lin | .478 | .478 | .478 | | | | | | | | | | | | | | |
| Extrapolation: | Poly 4 | | | | | | | | | | | | | | | | |

| | |
|-------------------------------|---------------|
| Liquid Depth: | 15.5 cm |
| Liquid Type: | 2450 MHz Body |
| Conductivity: | 2.01 |
| Relative Permittivity: | 51.41 |
| Liquid Temp (Before): | 23.0 deg |
| Liquid Temp (After): | 23.0 deg |
| Ambient Temp: | 23.5 deg |
| Ambient RH (%): | 58 |

AREA SCAN:

| | | |
|---------------------|------------|------------|
| | Min | Max |
| Scan Extent: | | |
| Y | -60.0 | 60.0 |
| Z | -160.0 | -100.0 |

Measurement Resolution (13x7):
dy = 10mm, dz = 10mm,

ZOOM SCAN RESULTS:

| | | |
|-------------------------------|-------------------|-----------------|
| Spot SAR (W/kg): | Start Scan | End Scan |
| | 0.029 | 0.028 |
| Change during Scan (%) | -3.45% | |
| Max E-field(V/m): | 9.94 | |
| Max SAR (W/kg) | 1g | 10g |
| | 0.190 | 0.104 |
| Max Spot SAR (W/kg): | 0.20 | |
| Location of Max (mm): | X | Y |
| | 78.1 | -55.7 |
| | Z | -134.9 |

Measurement Resolution (7x7x7):
dx = 5mm, dy = 5mm, dz = 5mm

Plot #7

| | | | |
|------------------------|--|--------------------------|----------------------|
| Date / Time: | 13/12/2013 05:05:44 PM | Position: | Back, 0mm separation |
| Filename: | VM311_2450B_Back_M_GY_13_12_2013.txt | Phantom: | HeadBox2-test.csv |
| Device Tested: | VM311 PU | Test Channel: | Middle |
| Antenna: | Integral Antenna | Test Frequency: | 2441.25 MHz |
| Battery used: | 3.6V 750mAh Ni-MH GY BT185645 / BT285645 | Power Level: | 19.05 dBm |
| Operation Mode: | Voice call | Modn. Dutv Cvcle: | 17.9% |

| | | | | | | | | | | | | | | | | | |
|-----------------------|--|----------|----------|----------|----------|------------|-----|-----|-----|------------|----|----|----|------------|------|------|------|
| Probe: | 0136 | | | | | | | | | | | | | | | | |
| Cal File: | SN0136_2450_BODY | | | | | | | | | | | | | | | | |
| Cal Factors: | <table border="1"> <tr> <td></td> <td>X</td> <td>Y</td> <td>Z</td> </tr> <tr> <td>Air</td> <td>459</td> <td>362</td> <td>378</td> </tr> <tr> <td>DCP</td> <td>20</td> <td>20</td> <td>20</td> </tr> <tr> <td>Lin</td> <td>.478</td> <td>.478</td> <td>.478</td> </tr> </table> | | X | Y | Z | Air | 459 | 362 | 378 | DCP | 20 | 20 | 20 | Lin | .478 | .478 | .478 |
| | | X | Y | Z | | | | | | | | | | | | | |
| | Air | 459 | 362 | 378 | | | | | | | | | | | | | |
| | DCP | 20 | 20 | 20 | | | | | | | | | | | | | |
| Lin | .478 | .478 | .478 | | | | | | | | | | | | | | |
| Extrapolation: | Poly 4 | | | | | | | | | | | | | | | | |

| | |
|-------------------------------|---------------|
| Liquid Depth: | 15.5 cm |
| Liquid Type: | 2450 MHz Body |
| Conductivity: | 2.01 |
| Relative Permittivity: | 51.41 |
| Liquid Temp (Before): | 23.0 deg |
| Liquid Temp (After): | 23.0 deg |
| Ambient Temp: | 23.5 deg |
| Ambient RH (%): | 58 |

AREA SCAN:

| | | |
|---------------------|------------|------------|
| | Min | Max |
| Scan Extent: | | |
| Y | -60.0 | 60.0 |
| Z | -160.0 | -100.0 |

Measurement Resolution (13x7):
dy = 10mm, dz = 10mm,

ZOOM SCAN RESULTS:

| | | | |
|-------------------------------|-------------------|-----------------|----------|
| Spot SAR (W/kg): | Start Scan | End Scan | |
| | 0.027 | 0.027 | |
| Change during Scan (%) | -0.40% | | |
| Max E-field(V/m): | 9.59 | | |
| Max SAR (W/kg) | 1g | 10g | |
| | 0.181 | 0.101 | |
| Max Spot SAR (W/kg): | 0.19 | | |
| Location of Max (mm): | X | Y | Z |
| | 78.1 | -56.6 | -135.8 |

Measurement Resolution (7x7x7):
dx = 5mm, dy = 5mm, dz = 5mm



Valued Quality. Delivered.

Report No.: 13120508HKG-001
Page 35 of 82

APPENDIX C – E-Field Probe and Dipole Antenna Calibration



IMMERSIBLE SAR PROBE

CALIBRATION REPORT

Part Number: IXP – 050

S/N 0136

February 2013

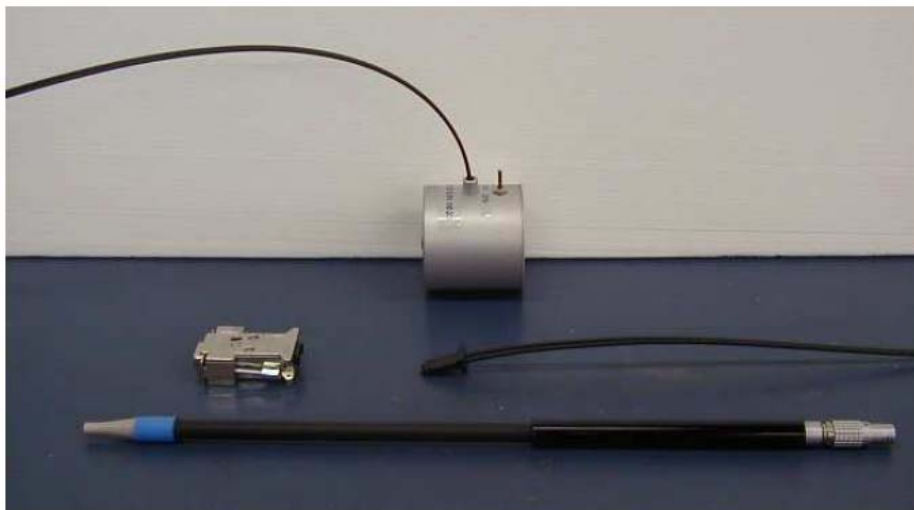

Indexsar Limited
Oakfield House
Cudworth Lane
Newdigate
Surrey RH5 5BG
Tel: +44 (0) 1306 632 870
Fax: +44 (0) 1306 631 834
e-mail: enquiries@indexsar.com

Reproduction of this report is authorized by Indexsar Ltd provided the report is reproduced in its entirety



Indexsar Limited
Oakfield House
Cudworth Lane
Newdigate
Surrey RH5 5BG
Tel: +44 (0) 1306 632 870
Fax: +44 (0) 1306 631 834
e-mail: enquiries@indexsar.com

Calibration Certificate 1302/0136
Date of Issue: 16th February 2013
Immersible SAR Probe

| | |
|---------------------------|--|
| Type: | IXP-050 |
| Manufacturer: | IndexSAR, UK |
| Serial Number: | 0136 |
| Place of Calibration: | IndexSAR, UK |
| Date of Receipt of Probe: | 8 th January 2013 |
| Calibration Dates: | 8 th January – 15 th February 2013 |
| Customer: | Intertek Testing Services |

IndexSAR Ltd hereby declares that the IXP-050 Probe named above has been calibrated for conformity to the current versions of IEEE 1528, IEC 62209-1, IEC 62209-2, and FCC OET65 standards using the methods described in this calibration document. Where applicable, the standards used in the calibration process are traceable to the UK's National Physical Laboratory.

Calibrated by:  Technical Manager

Approved by:  Director

Please keep this certificate with the calibration document. When the probe is sent for a calibration check, please include the calibration document.

INTRODUCTION

This Report presents measured calibration data for a particular Indexsar SAR probe (S/N 0136) only and describes the procedures used for characterisation and calibration.

Indexsar probes are characterised using procedures that, where applicable, follow the recommendations of IEC 62209-1 [Ref 1], IEEE 1528 [Ref 2], IEC 62209-2 [Ref 3] and FCC OET65 [Ref 4] standards. The procedures incorporate techniques for probe linearisation, isotropy assessment and determination of liquid factors (conversion factors). Calibrations are determined by comparing probe readings with analytical computations in canonical test geometries (waveguides) using normalised power inputs.

Each step of the calibration procedure and the equipment used is described in the sections below.

CALIBRATION PROCEDURE

1. Objectives

The calibration process comprises four stages

- 1) Determination of the channel sensitivity factors which optimise the probe's overall rotational isotropy in 900MHz brain fluid
- 2) Determination of the channel sensitivity factors and angular offset of the X channel which together optimise the probe's spherical isotropy in 900MHz brain fluid
- 3) Numerical combination of the two sets of channel sensitivity factors to give both acceptable rotational isotropy and acceptable spherical isotropy values
- 4) Since isotropy and channel sensitivity factors are frequency independent, at each frequency of interest, application of these channel sensitivity factors to model the exponential decay of SAR in a waveguide fluid cell, and hence derive the liquid conversion factors at that frequency

2. Probe output

The probe channel output signals are linearised in the manner set out in Refs [1] and [2]. The following equation is utilized for each channel:

$$U_{lin} = U_{o/p} + U_{o/p}^2 / DCP \quad (1)$$

where U_{lin} is the linearised signal, $U_{o/p}$ is the raw output signal in mV and DCP is the diode compression potential in similar voltage units.

DCP is determined from fitting equation (1) to measurements of U_{lin} versus source feed power over the full dynamic range of the probe. The DCP is a characteristic of the Schottky diodes used as the sensors. For the IXP-050 probes with CW signals the DCP values are typically 100mV (or 20 in the voltage units used by Indexsar software, which are $V*200$).

For this value of DCP, the typical linearity response of IXP-050 probes to CW and to GSM modulation is shown in Figure 8, along with departures of this same dataset from linearity.

In turn, measurements of E-field are determined using the following equation (where output voltages are also in units of V*200):

$$E_{liq}^2 \text{ (V/m)} = U_{linx} * \text{Air Factor}_x * \text{Liq Factor}_x + U_{liny} * \text{Air Factor}_y * \text{Liq Factor}_y + U_{linz} * \text{Air Factor}_z * \text{Liq Factor}_z \quad (3)$$

Here, "Air Factor" represents each channel's sensitivity, while "Liq Factor" represents the enhancement in signal level when the probe is immersed in tissue-simulant liquids at each frequency of interest.

3. Selecting channel sensitivity factors to optimise isotropic response

After manufacture, the first stage of the calibration process is to balance the three channels' Air Factor values, thereby optimising the probe's overall axial response ("rotational isotropy").

To do this, a 900MHz waveguide containing head-fluid simulant is selected. Like all waveguides used during probe calibration, this particular waveguide contains two distinct sections: an air-filled launcher section, and a liquid cell section, separated by a dielectric matching window designed to minimise reflections at the air-liquid interface.

The waveguide stands in an upright position and the liquid cell section is filled with 900MHz brain fluid to within 10 mm of the open end. The depth of liquid ensures there is negligible radiation from the waveguide open top and that the probe calibration is not influenced by reflections from nearby objects.

During the measurement, a TE₀₁ mode is launched into the waveguide by means of an N-type-to-waveguide adapter. The probe is then lowered vertically into the liquid until the tip is exactly 10mm above the centre of the dielectric window. This particular separation ensures that the probe is operating in a part of the waveguide where boundary corrections are not necessary.

Care must also be taken that the probe tip is centred while rotating.

The exact power applied to the input of the waveguide during this stage of the probe calibration is immaterial since only relative values are of interest while the probe rotates. However, the power must be sufficiently above the noise floor and free from drift.

The dedicated Indexsar calibration software rotates the probe in 10 degree steps about its axis, and at each position, an Indexsar 'Fast' amplifier samples the probe channels 500 times per second for 0.4 s. The raw U_{o/p} data from each sample are packed into 10 bytes and transmitted back to the PC

controller via an optical cable. U_{linx} , U_{liny} and U_{linz} are derived from the raw U_{op} values and written to an Excel template.

Once data have been collected from a full probe rotation, the Air Factors are adjusted using a special Excel Solver routine to equalise the output from each channel and hence minimise the rotational isotropy. This automated approach to optimisation removes the effect of human bias.

Figure 5 represents the output from each diode sensor as a function of probe rotation angle.

4. Measurement of Spherical Isotropy

The setup for measuring the probe's spherical isotropy is shown in Figure 2.

A box phantom containing 900MHz head fluid is irradiated by a vertically-polarised, tuned dipole, mounted to the side of the phantom on the robot's seventh axis. During calibration, the spherical response is generated by rotating the probe about its axis in 20 degree steps and changing the dipole polarisation in 10 degree steps.

By using the VPM technique discussed below, an allowance can also be made for the effect of E-field gradient across the probe's spatial extent. This permits values for the probe's effective tip radius and X-channel angular offset to be modelled until the overall spherical isotropy figure is optimised.

The dipole is connected to a signal generator and amplifier via a directional coupler and power meter. As with the determination of rotational isotropy, the absolute power level is not important as long as it is stable.

The probe is positioned within the fluid so that its sensors are at the same vertical height as the centre of the source dipole. The line joining probe to dipole should be perpendicular to the phantom wall, while the horizontal separation between the two should be small enough for VPM corrections to be applicable, without encroaching near the boundary layer of the phantom wall. VPM corrections require a knowledge of the fluid skin depth. This is measured during the calibration by recording the E-field strength while systematically moving the probe away from the dipole in 2mm steps over a 20mm range.

The directionality of the orthogonally-arranged sensors can be checked by analysing the data using dedicated Indexsar software, which displays the data in 3D format, a representative image of which is shown in Figure 3. The left-hand side of this diagram shows the individual channel outputs after linearisation (see above). The program uses these data to balance the channel outputs and then applies an optimisation process, which makes fine adjustments to the channel factors for optimum isotropic response.

5. Determination of Conversion ("Liquid") Factors at each frequency of interest

A lookup table of conversion factors for a probe allows a SAR value to be derived at the measured frequencies, and for either brain or body fluid-simulant.

The method by which the conversion factors are assessed is based on the comparison between measured and analytical rates of decay of SAR with height above a dielectric window. This way, not only can the conversion factors for that frequency/fluid combination be determined, but an allowance can also be made for the scale and range of boundary layer effects.

The theoretical relationship between the SAR at the cross-sectional centre of the lossy waveguide as a function of the longitudinal distance (z) from the dielectric separator is given by Equation 4:

$$SAR(z) = \frac{4(P_f - P_b)}{\rho ab \delta} e^{-2z/\delta} \quad (4)$$

Here, the density ρ is conventionally assumed to be 1000 kg/m^3 , ab is the cross-sectional area of the waveguide, and P_f and P_b are the forward and reflected power inside the lossless section of the waveguide, respectively. The penetration depth δ (which is the reciprocal of the waveguide-mode attenuation coefficient) is a property of the lossy liquid and is given by Equation (5).

$$\delta = \left[\text{Re} \left\{ \sqrt{(\pi / a)^2 + j\omega\mu_o (\sigma + j\omega\epsilon_o\epsilon_r)} \right\} \right]^{-1} \quad (5)$$

where σ is the conductivity of the tissue-simulant liquid in S/m, ϵ_r is its relative permittivity, and ω is the radial frequency (rad/s). Values for σ and ϵ_r are obtained prior to each waveguide test using an Indexsar DiLine measurement kit, which uses the TEM method as recommended in [2]. σ and ϵ_r are both temperature- and fluid-dependent, so are best measured using a sample of the tissue-simulant fluid immediately prior to the actual calibration.

Wherever possible, all DiLine and calibration measurements should be made in the open laboratory at $22 \pm 2.0^\circ\text{C}$; if this is not possible, the values of σ and ϵ_r should reflect the actual temperature. Values employed for calibration are listed in the tables below.

By ensuring the liquid height in the waveguide is at least three penetration depths, reflections at the upper surface of the liquid are negligible. The power absorbed in the liquid is therefore determined solely from the waveguide forward and reflected power.

Different waveguides are used for 835/900MHz, 1800/1900MHz, 2100/2450/2600MHz and 5200/5800MHz measurements. Table A.1 of [1] can be used for designing calibration waveguides with a return loss greater than 20 dB at the most important frequencies used for personal wireless communications, and better than 15dB for frequencies greater than 5GHz. Values for the penetration depth for these specific fixtures and tissue-simulating mixtures are also listed in Table A.1.

According to [1], this calibration technique provides excellent accuracy, with standard uncertainty of less than 3.6% depending on the frequency and medium. The calibration itself is reduced to power measurements traceable to a standard calibration procedure. The practical limitation to the frequency band of 800 to 5800 MHz because of the waveguide size is not severe in the context of compliance testing.

During calibration, the probe is lowered carefully until it is just touching the cross-sectional centre of the dielectric window. 200 samples are then taken and written to an Excel template file before moving the probe vertically upwards. This cycle is repeated 150 times. The vertical separation between readings is determined from practical considerations of the expected SAR decay rate, and range from 0.2mm steps at low frequency, through 0.1mm at 2450MHz, down to 0.05mm at 5GHz.

Once the data collection is complete, a Solver routine is run which optimises the measured-theoretical fit by varying the conversion factor, and the boundary correction size and range.

For 450 MHz calibrations, a slightly different technique must be used — the equatorial response of the probe-under-test is compared with the equivalent response of a probe whose 450MHz characteristics have already been determined by NPL. The conversion factor of the probe-under-test can then be deduced.

VPM (Virtual Probe Miniaturisation)

SAR probes with 3 diode-sensors in an orthogonal arrangement are designed to display an isotropic response when exposed to a uniform field. However, the probes are ordinarily used for measurements in non-uniform fields and isotropy is not assured when the field gradients are significant compared to the dimensions of the tip containing the three orthogonally-arranged dipole sensors.

It becomes increasingly important to assess the effects of field gradients on SAR probe readings when higher frequencies are being used. For Indexsar IXP-050 probes, which are of 5mm tip diameter, field gradient effects are minor at GSM frequencies, but are major above 5GHz. Smaller probes are less affected by field gradients and so probes, which are significantly less than 5mm diameter, would be better for applications above 5GHz.

The IndexSAR report IXS0223 [Ref 5] describes theoretical and experimental studies to evaluate the issues associated with the use of probes at arbitrary angles to surfaces and field directions. Based upon these studies, the procedures and uncertainty analyses referred to in P1528 are addressed for the full range of probe presentation angles.

In addition, generalized procedures for correcting for the finite size of immersible SAR probes are developed. Use of these procedures enables application of schemes for virtual probe miniaturization (VPM) – allowing probes of a specific size to be used where physically-smaller probes would otherwise be required.

Given the typical dimensions of 3-channel SAR probes presently available, use of the VPM technique extends the satisfactory measurement range to higher frequencies.

CALIBRATION FACTORS MEASURED FOR PROBE S/N 0136

The probe was calibrated at 450, 835, 900, 1800, 1900, 2100, 2450 and 2600 MHz in liquid samples representing brain and body liquid at these frequencies.

The calibration was for CW signals only, and the axis of the probe was parallel to the direction of propagation of the incident field i.e. end-on to the incident radiation. The axial isotropy of the probe was measured by rotating the probe about its axis in 10 degree steps through 360 degrees in this orientation.

The reference point for the calibration is in the centre of the probe's cross-section at a distance of 2.7 mm from the probe tip in the direction of the probe amplifier. A value of 2.7 mm should be used for the tip to sensor offset distance in the software. The distance of 2.7mm for assembled probes has been confirmed by taking X-ray images of the probe tips (see Figure 9).

It is important that the diode compression point and air factors used in the software are the same as those quoted in the results tables, as these are used to convert the diode output voltages to a SAR value.

CALIBRATION EQUIPMENT

The table on page 20 indicates the calibration status of all test equipment used during probe calibration.

MEASUREMENT UNCERTAINTIES

A complete measurement uncertainty analysis for the SARA-C measurement system has been published in Reference [6]. Table 17 from that document is re-created below, and lists the uncertainty factors associated just with the calibration of probes.

| Source of uncertainty | Uncertainty value \pm % | Probability distribution | Divisor | c_i | Standard uncertainty $u_i \pm$ % | v_i or v_{eff} |
|--------------------------------------|---------------------------|--------------------------|---------|-------|----------------------------------|--------------------|
| Forward power | 3.92 | N | 1.00 | 1 | 3.92 | ∞ |
| Reflected power | 4.09 | N | 1.00 | 1 | 4.09 | ∞ |
| Liquid conductivity | 1.308 | N | 1.00 | 1 | 1.31 | ∞ |
| Liquid permittivity | 1.271 | N | 1.00 | 1 | 1.27 | ∞ |
| Field homogeneity | 3.0 | R | 1.73 | 1 | 1.73 | ∞ |
| Probe positioning | 0.22 | R | 1.73 | 1 | 0.13 | ∞ |
| Field probe linearity | 0.2 | R | 1.73 | 1 | 0.12 | ∞ |
| Combined standard uncertainty | | RSS | | | 6.20 | |

At the 95% confidence level, therefore, the expanded uncertainty is $\pm 12.4\%$

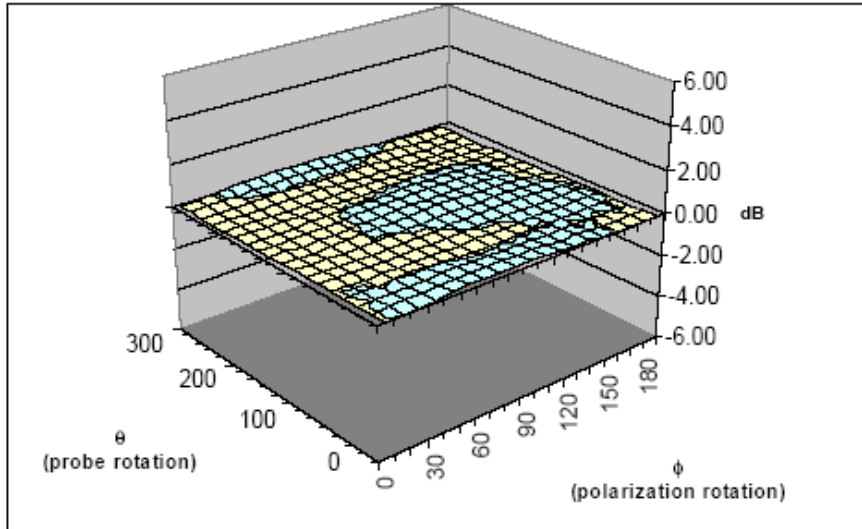

Surface Isotropy diagram of IXP-050 Probe S/N 0136 at 900MHz after VPM (rotational isotropy axial +/-0.10dB, spherical isotropy +/-0.28dB). (NB Spherical Isotropy is frequency independent)

Probe tip radius 1.25
X Ch. Angle to red dot -12.9

| Frequency | Head | | Body | |
|-----------|-------------------|--------------------|-------------------|--------------------|
| | Bdy. Corr. - f(0) | Bdy. Corr. - d(mm) | Bdy. Corr. - f(0) | Bdy. Corr. - d(mm) |
| 450 | 0.0 | 1.0 | 0.0 | 1.0 |
| 835 | 1.32 | 1.13 | 0.50 | 1.94 |
| 900 | 0.54 | 1.68 | 1.05 | 1.28 |
| 1800 | 0.50 | 1.99 | 0.48 | 2.50 |
| 1900 | 0.54 | 1.91 | 0.48 | 2.51 |
| 2100 | 0.54 | 2.12 | 0.60 | 2.07 |
| 2450 | 0.88 | 1.53 | 0.84 | 1.68 |
| 2600 | 0.99 | 1.39 | 0.93 | 1.59 |

SUMMARY OF CALIBRATION FACTORS FOR PROBE IXP-050 S/N 0136

| | | |
|---------------------------------------|------|----------|
| Spherical isotropy measured at 900MHz | 0.28 | (+/-) dB |
|---------------------------------------|------|----------|

| | X | Y | Z | |
|-------------|-----|-----|-----|----------------|
| Air Factors | 459 | 362 | 378 | $(V*200)^2/mV$ |
| CW DCPs | 20 | 20 | 20 | $V*200$ |

NB Air Factors are frequency independent

| Freq (MHz)* | Axial Isotropy (+/- dB) | | SAR ConvF (liq/air) | | Notes |
|-------------|----------------------------|------|------------------------|-------|-------|
| | Head | Body | Head | Body | |
| | 450 | - | - | 0.267 | |
| 835 | - | - | 0.305 | 0.320 | 1,2 |
| 900 | 0.10 | - | 0.307 | 0.321 | 1,2,4 |
| 1800 | - | - | 0.372 | 0.398 | 1,2 |
| 1900 | - | - | 0.374 | 0.411 | 1,2 |
| 2100 | - | - | 0.409 | 0.438 | 1,2 |
| 2450 | - | - | 0.424 | 0.478 | 1,2 |
| 2600 | - | - | 0.431 | 0.496 | 1,2 |

The valid frequency of SARA2 are $\pm 50MHz$ ($F < 300MHz$) and $\pm 100MHz$ ($F > 300MHz$); while SARA-C are $\pm 100MHz$ ($F < 300MHz$) and $\pm 200MHz$ ($F > 300MHz$).

| Notes | |
|-------|---|
| 1) | Calibrations done at 22°C +/- 2°C |
| 2) | Waveguide calibration |
| 3) | Transfer calibration |
| 4) | Axial Isotropy is frequency independent |

PROBE SPECIFICATIONS

Indexsar probe 0136, along with its calibration, is compared with BSEN 62209-1 and IEEE standards recommendations (Refs [1] and [2]) in the Tables below. A listing of relevant specifications is contained in the tables below:

| Dimensions | S/N 0136 | BSEN [1] | IEEE [2] |
|--|----------|----------|----------|
| Overall length (mm) | 350 | | |
| Tip length (mm) | 10 | | |
| Body diameter (mm) | 12 | | |
| Tip diameter (mm) | 5.2 | 8 | 8 |
| Distance from probe tip to dipole centers (mm) | 2.7 | | |

| Typical Dynamic range | S/N 0136 | BSEN [1] | IEEE [2] |
|---|----------|----------|----------|
| Minimum (W/kg) | 0.01 | <0.02 | 0.01 |
| Maximum (W/kg) N.B. only measured to > 100 W/kg on representative probes | >100 | >100 | 100 |

| Isotropy (measured at 900MHz) | S/N 0136 | BSEN [1] | IEEE [2] |
|---|----------|----------|----------|
| Axial rotation with probe normal to source (+/- dB) | 0.10 | 0.5 | 0.25 |
| Spherical isotropy covering all orientations to source (+/- dB) | 0.28 | 1.0 | 0.50 |

NB Isotropy is frequency independent

| | |
|----------------------------|--|
| Construction | Each probe contains three orthogonal dipole sensors arranged on a triangular prism core, protected against static charges by built-in shielding, and covered at the tip by PEEK cylindrical enclosure material. No adhesives are used in the immersed section. Outer case materials are PEEK and heat-shrink sleeving. |
| Chemical resistance | Tested to be resistant to TWEEN20 and sugar/salt-based simulant liquids but probes should be removed, cleaned and dried when not in use. NOT recommended for use with glycol or soluble oil-based liquids. |

REFERENCES

References are either specific (identified by date of publication, edition number, version number, etc.) or non-specific.

For a specific reference, subsequent revisions do not apply.

For a non-specific reference, the latest version applies.

- [1] IEC 62209-1.
Human exposure to radio frequency fields from hand-held and body-mounted wireless communication devices — Human models, instrumentation, and procedures — Part 1: Procedure to determine the specific absorption rate (SAR) for hand-held devices used in close proximity to the ear (frequency range of 300 MHz to 3 GHz)
- [2] IEEE 1528
Recommended Practice for Determining the Peak Spatial-Average Specific Absorption Rate (SAR) in the Human Head from Wireless Communications Devices: Measurement Techniques
- [3] IEC 62209-2
Human exposure to radio frequency fields from hand-held and body-mounted wireless communication devices – Human models, Instrumentation, and procedures – Part 2: Procedure to determine the specific absorption rate (SAR) for wireless communication devices used in close proximity to the human body (frequency range of 30 MHz to 6 GHz)
- [4] FCC OET65
Evaluating Compliance with FCC Guidelines for Human Exposure to Radiofrequency Electromagnetic Fields
- [5] Indexsar Report IXS-0300, October 2007.
Measurement uncertainties for the SARA2 system assessed against the recommendations of BS EN 62209-1:2006
- [6] SARA-C SAR Testing System: Measurement Uncertainty, v1.0.3. October 2011.

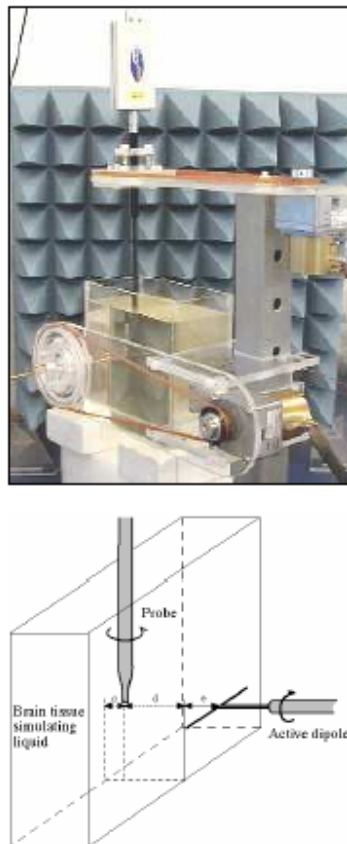

Figure 1. Spherical isotropy jig showing probe, dipole and box filled with simulated brain liquid (see Ref [2], Section A.5.2.1)

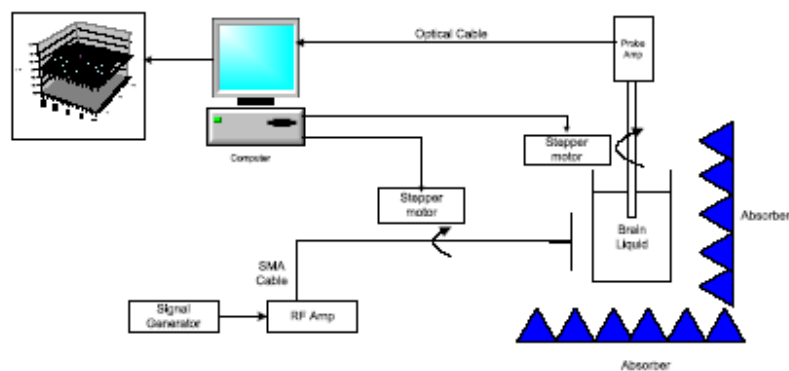

Figure 2. Schematic diagram of the test geometry used for isotropy determination

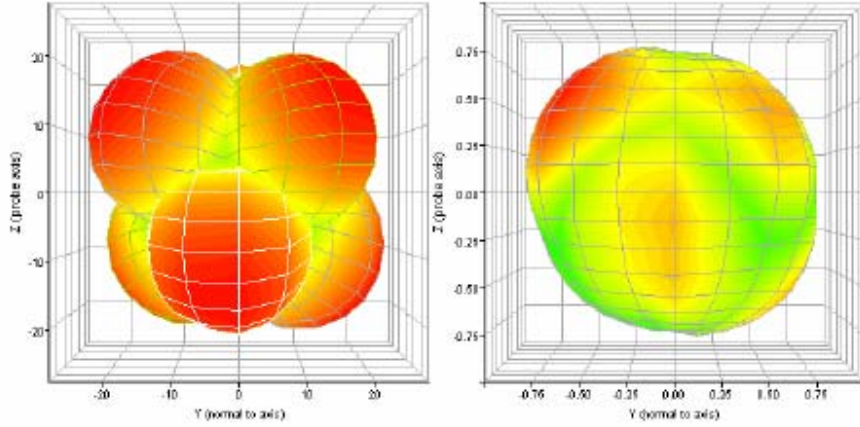

Figure 3. Graphical representation of a typical probe's response to fields applied from each direction. The diagram on the left shows the individual response characteristics of each of the three channels and the diagram on the right shows the resultant probe sensitivity in each direction. The colour range in the figure images the lowest values as blue and the maximum values as red. For probe S/N 0136, this range is (+/-) 0.28.

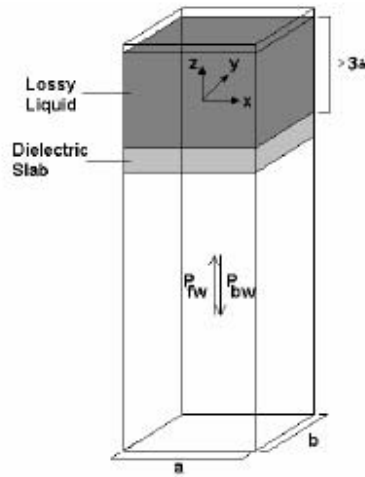

Figure 4. Geometry used for waveguide calibration (after Ref [2]. Section A.3.2.2)

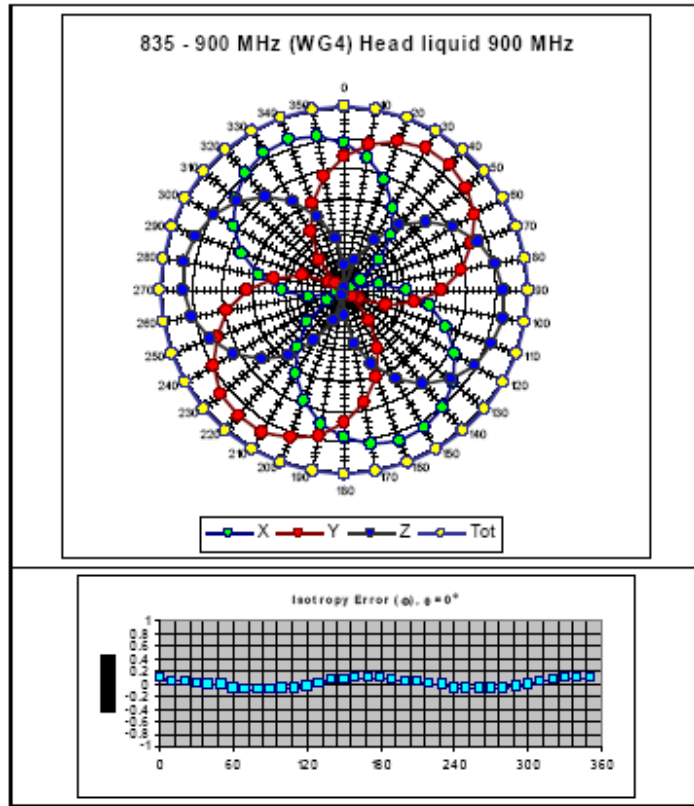

Figure 5. The rotational isotropy of probe S/N 0136 obtained by rotating the probe in a liquid-filled waveguide at 900 MHz. (NB Axial Isotropy is frequency independent)

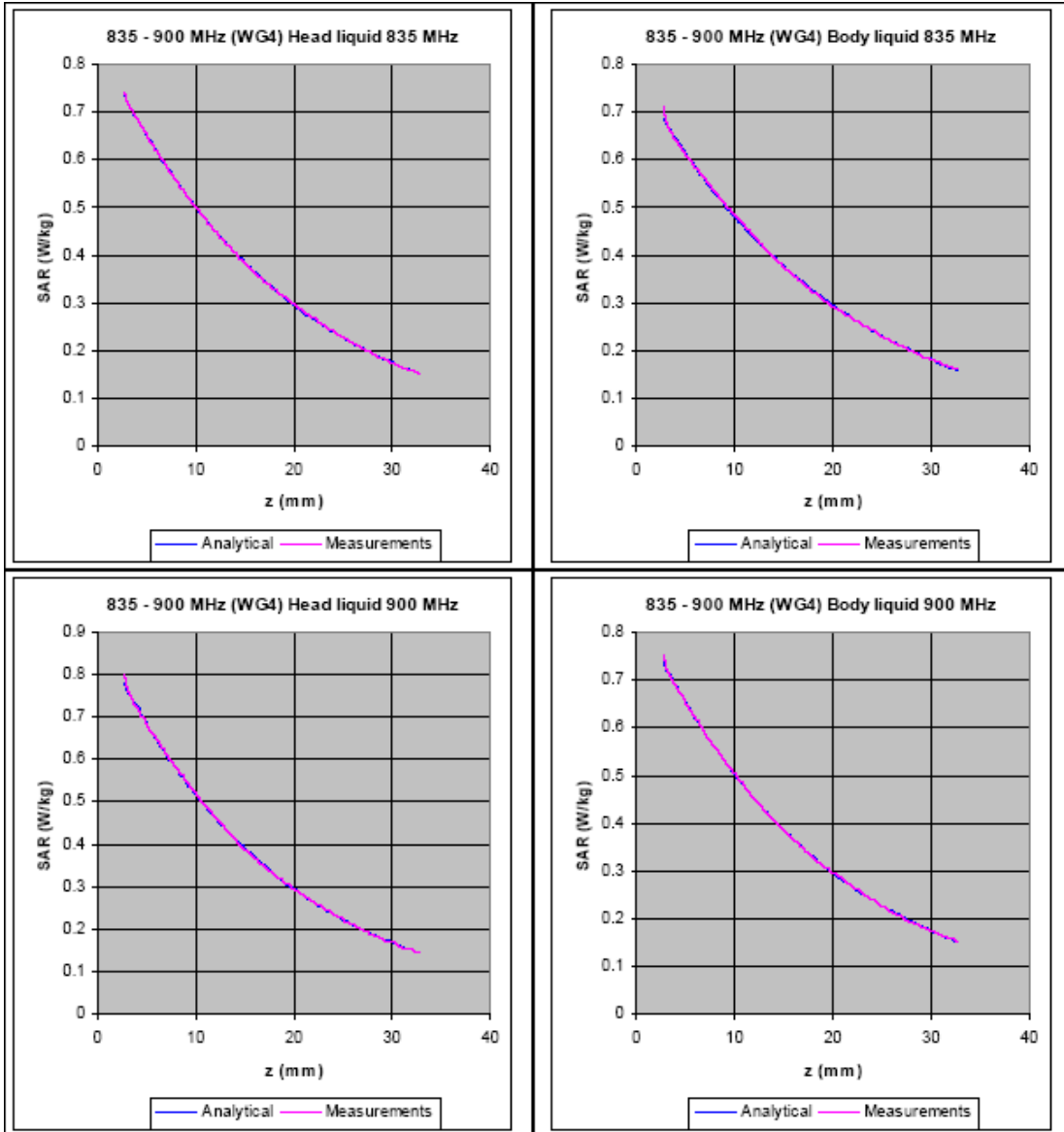
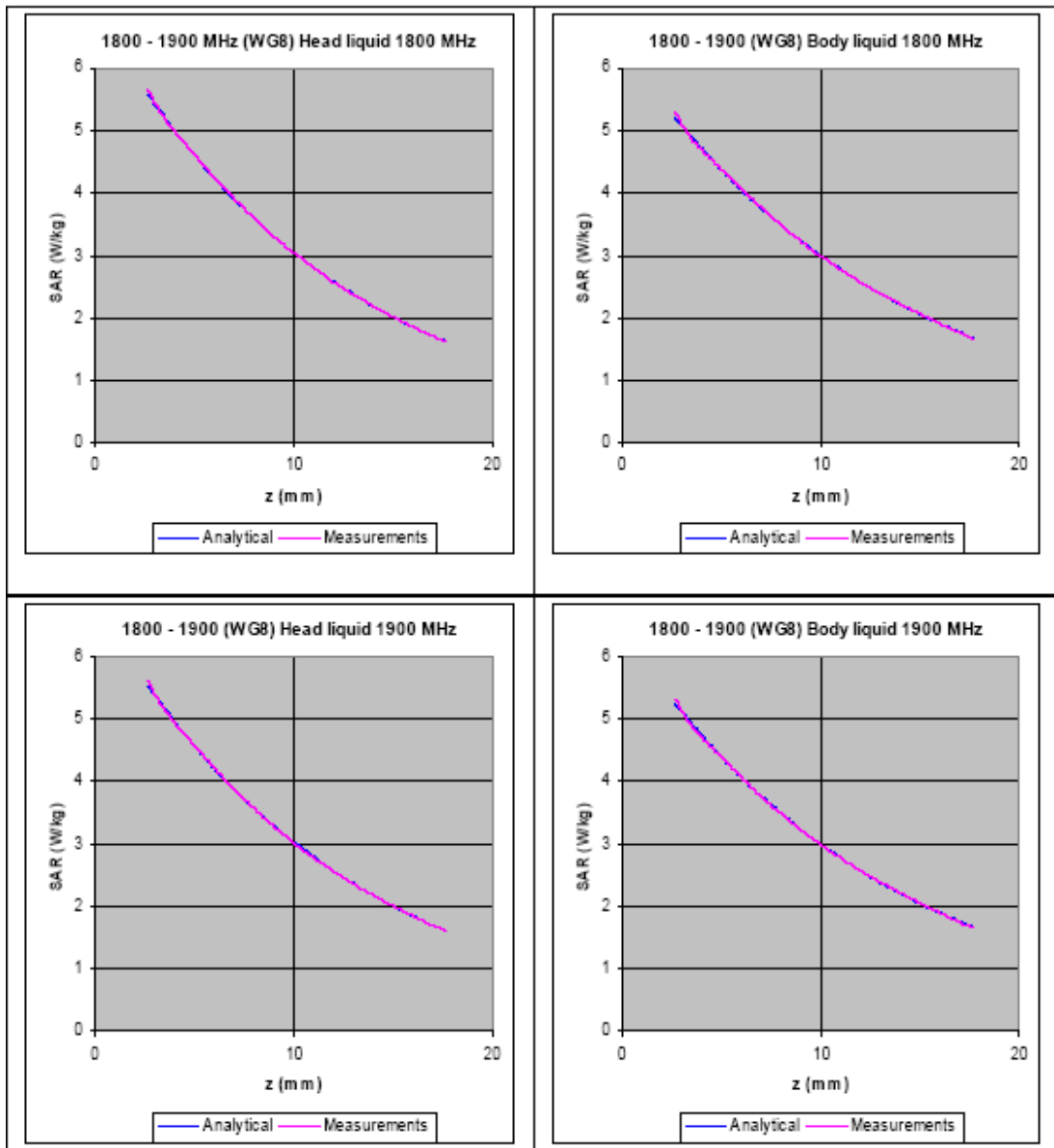
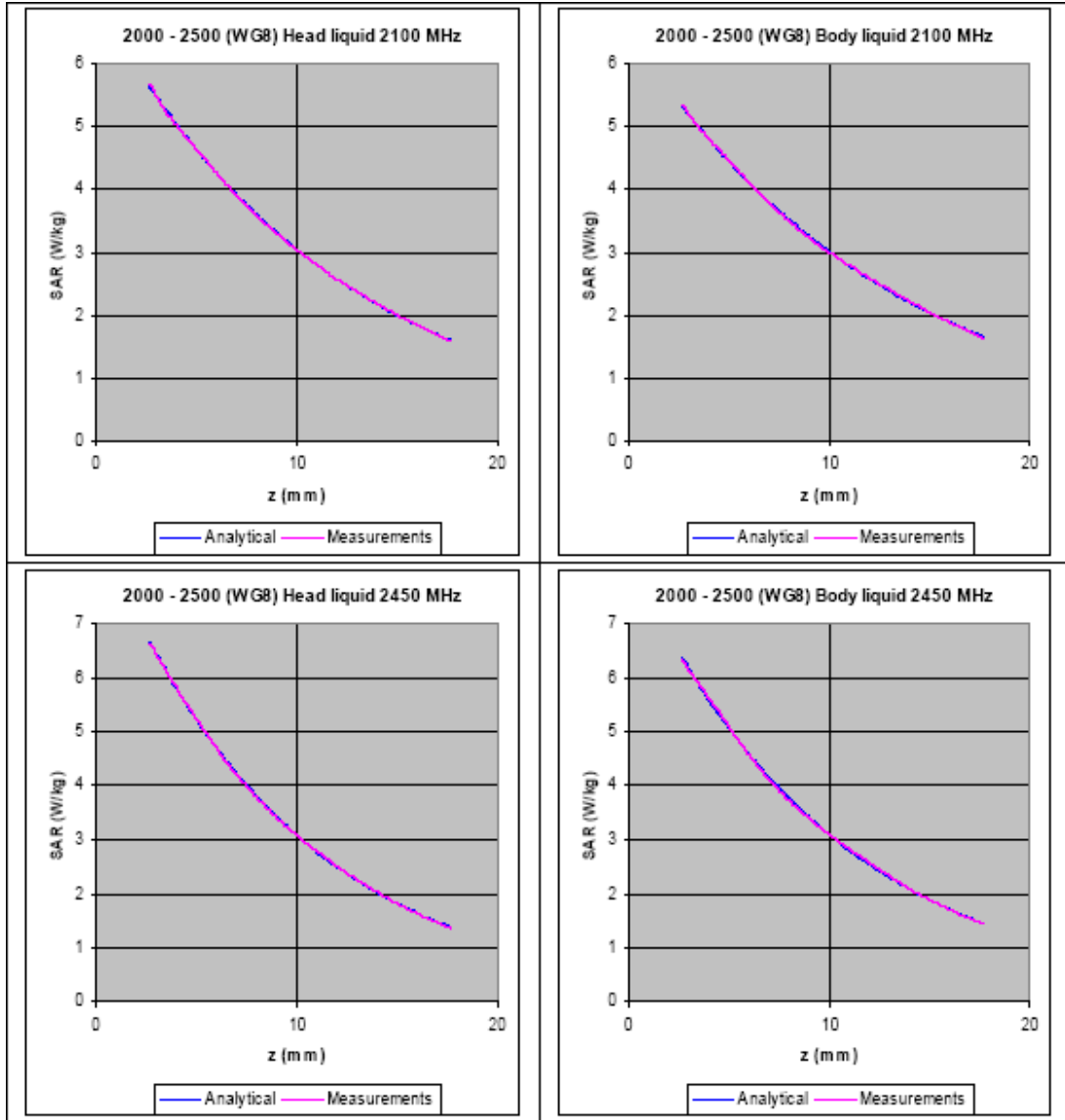

Figure 6. The measured SAR decay function along the centreline of the WG4 waveguide with conversion factors adjusted to fit to the theoretical function for the particular dimension, frequency, power and liquid properties employed.





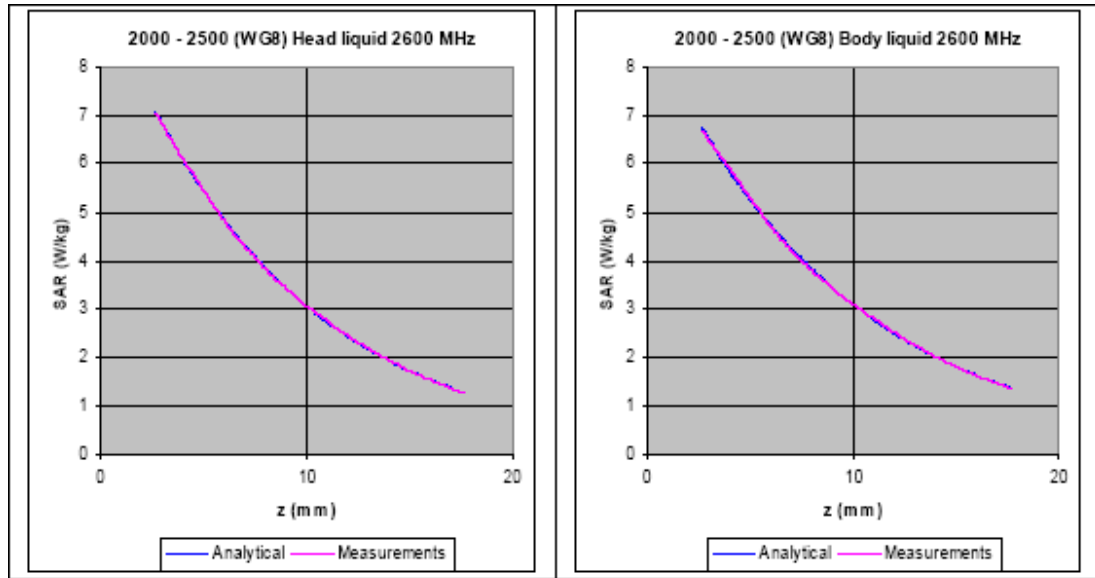

Figure 7. The measured SAR decay function along the centreline of the R22 waveguide with conversion factors adjusted to fit to the theoretical function for the particular dimension, frequency, power and liquid properties employed.

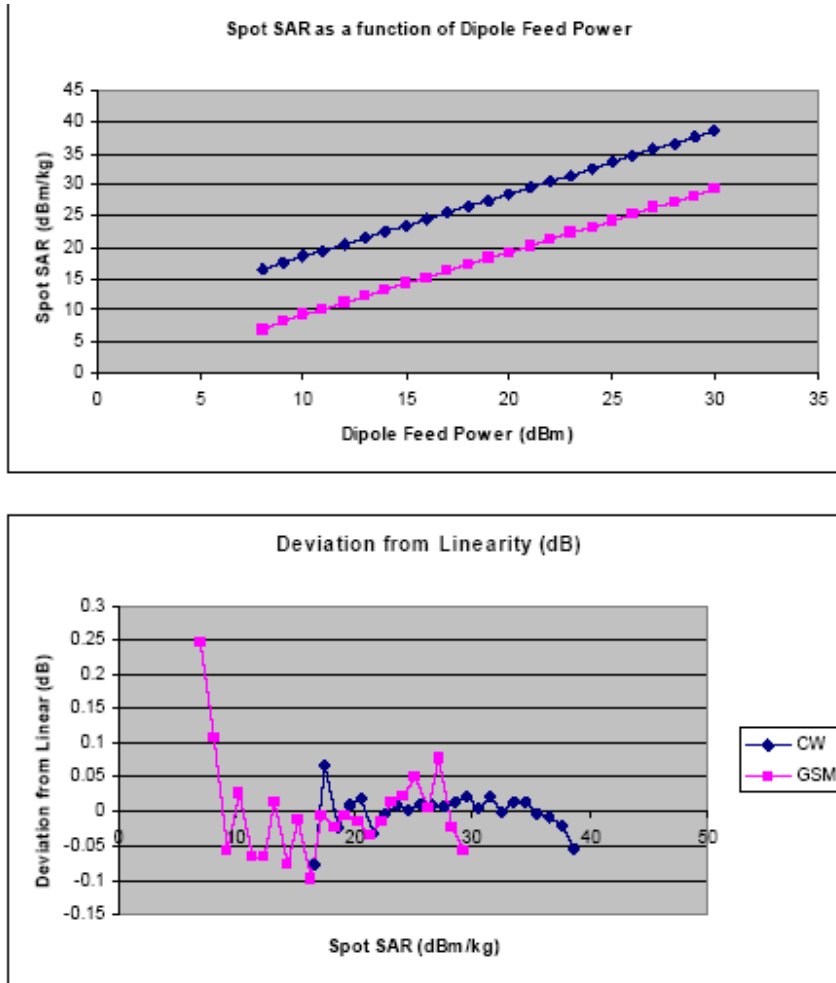

Figure 8: The typical linearity response of IXP-050 probes to both CW (blue) and GSM (pink) modulation in close proximity to a source dipole. The top diagram shows the SAR reading as a function of dipole feed power, with GSM modulation being approx a factor of 8 (ie 9dB) lower than CW. The lower diagram shows the departure from linearity of the same two datasets.

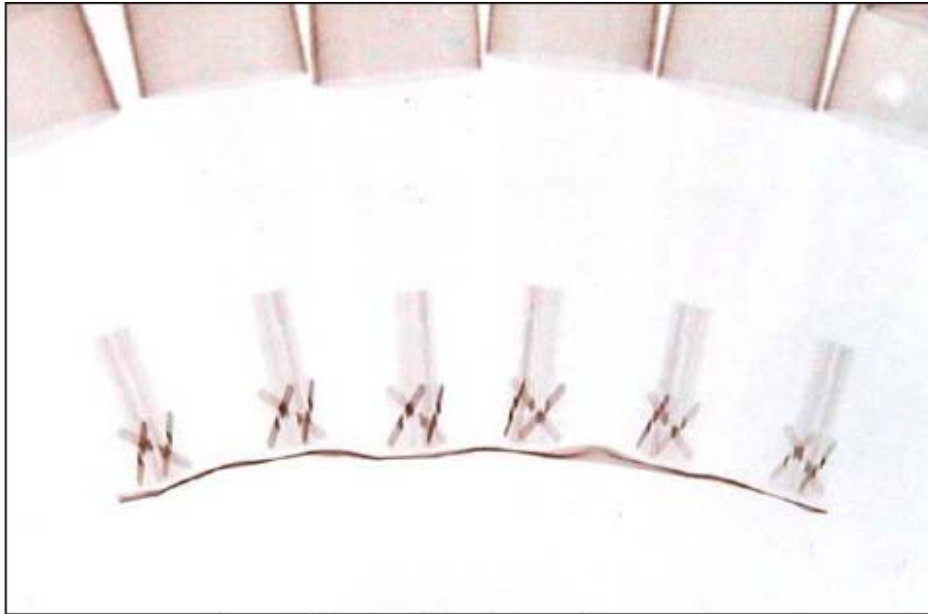

Figure 9: X-ray positive image of 5mm probes

Table indicating the dielectric parameters of the liquids used for calibrations at each frequency

| Frequency (MHz) | Fluid Type | Measured | | Target | | % Deviation | | Verdict | |
|-----------------|------------|-----------------------|--------------------|-----------------------|--------------------|-----------------------|--------------|-----------------------|--------------|
| | | Relative Permittivity | Conductivity (S/m) | Relative Permittivity | Conductivity (S/m) | Relative Permittivity | Conductivity | Relative Permittivity | Conductivity |
| 450 | Head | 43.92 | 0.878 | 43.5 | 0.87 | 1.0 | 0.9 | Pass | Pass |
| 835 | | 42.25 | 0.900 | 41.5 | 0.90 | 1.8 | 0.0 | Pass | Pass |
| 900 | | 41.45 | 0.962 | 41.5 | 0.97 | -0.1 | -0.8 | Pass | Pass |
| 1800 | | 39.87 | 1.408 | 40.0 | 1.40 | -0.3 | 0.6 | Pass | Pass |
| 1900 | | 39.60 | 1.400 | 40.0 | 1.40 | -1.0 | 0.0 | Pass | Pass |
| 2100 | | 41.02 | 1.481 | 39.8 | 1.49 | 3.1 | -0.6 | Pass | Pass |
| 2450 | | 39.79 | 1.828 | 39.2 | 1.80 | 1.5 | 1.6 | Pass | Pass |
| 2600 | | 39.32 | 1.963 | 39.0 | 1.96 | 0.8 | 0.2 | Pass | Pass |
| 450 | Body | 56.94 | 0.927 | 56.7 | 0.94 | 0.4 | -1.4 | Pass | Pass |
| 835 | | 55.15 | 0.958 | 55.2 | 0.97 | -0.1 | -1.2 | Pass | Pass |
| 900 | | 54.54 | 1.023 | 55 | 1.05 | -0.8 | -2.6 | Pass | Pass |
| 1800 | | 53.11 | 1.526 | 53.3 | 1.52 | -0.4 | 0.4 | Pass | Pass |
| 1900 | | 52.85 | 1.533 | 53.3 | 1.52 | -0.8 | 0.9 | Pass | Pass |
| 2100 | | 53.94 | 1.574 | 53.2 | 1.62 | 1.4 | -2.8 | Pass | Pass |
| 2450 | | 52.91 | 1.964 | 52.7 | 1.95 | 0.4 | 0.7 | Pass | Pass |
| 2600 | | 52.45 | 2.112 | 52.5 | 2.16 | -0.1 | -2.2 | Pass | Pass |

Table of test equipment calibration status

| Instrument description | Supplier / Manufacturer | Model | Serial No. | Last calibration date | Calibration due date |
|---------------------------------|-------------------------|--|------------|--|----------------------|
| Power sensor | Rohde & Schwarz | NRP-Z23 | 100063 | 09/08/2012 | 09/08/2014 |
| Dielectric property measurement | Indexsar | DiLine (sensor lengths: 160mm, 80mm and 60mm) | N/A | (absolute) – checked against NPL values using reference liquids | N/A |
| Vector network analyser | Anritsu | MS6423B | 003102 | 17/01/2013 | 17/01/2014 |
| SMA autocalibration module | Anritsu | 36581KKF/1 | 001902 | 17/01/2013 | 17/01/2014 |



Report No. SN0048_1203
12th March 2012

INDEXSAR
2450 MHz Validation Dipole
Type IXD-245 S/N 0048

Performance measurements

Dr Tony Brinklow

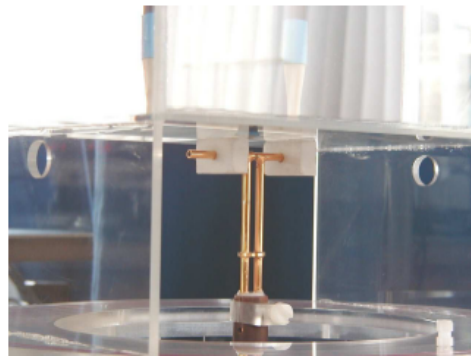

**Indexsar, Oakfield House, Cudworth Lane,
Newdigate, Surrey RH5 5BG. UK.**
Tel: +44 (0) 1306 632 870 Fax: +44 (0) 1306 631 834
E-mail: enquiries@indexsar.com

1. Measurement Conditions

Measurements were performed using a box-shaped phantom made of PMMA with dimensions designed to meet the accuracy criteria for reasonably-sized phantoms that do not have liquid capacities substantially in excess of the volume of liquid required to fill the Indexsar upright SAM phantoms used for SAR testing of handsets against the ear. The wall thickness was 2mm.

An Anritsu MS4623B vector network analyser was used for the return loss measurements. The dipole was placed in a special holder made of low-permittivity, low-loss materials. This holder enables the dipole to be positioned accurately in the centre of the wall of the Indexsar box-phantom used for flat-surface testing and validation checks.

The validation dipoles are supplied with special spacers made from a low-permittivity, low-loss foam material. These spacers are fitted to the dipole arms to ensure that, when the dipole is offered up to the phantom surface, the spacing between the dipole and the liquid surface is accurately aligned according to the guidance in the relevant standards documentation [1]. The spacers are rectangular with a central hole equal to the dipole arm diameter and dimensioned so that the longer side can be used to ensure a spacing of 15mm from the liquid in the phantom (for tests at 1000MHz and below) and the shorter side can be used for tests at 1000MHz and above to ensure a spacing of 10mm from the liquid in the phantom. The spacers are made on a CNC milling machine with an accuracy of 1/40th mm but they may suffer wear and tear and need to be replaced periodically. The material used is Rohacell, which has a relative permittivity of approx. 1.05 and a negligible loss tangent.

The apparatus supplied by Indexsar for dipole validation tests thus includes:

Balanced dipoles for each frequency required are dimensioned according to the guidelines given in IEEE 1528 [1]. The dipoles are made from semi-rigid 50 Ohm co-ax, which is joined by soldering and is gold-plated subsequently. The constructed dipoles are easily deformed, if mis-handled, and periodic checks need to be made of their symmetry.

Rohacell foam spacers designed for presenting the dipoles to 2mm thick PMMA box phantoms. These components also suffer wear and tear and should be replaced when the central hole is a loose-fit on the dipole arms or if the edges are too worn to ensure accurate alignment. The standard spacers are dimensioned for use with 2mm wall thickness (additional spacers are available for 4mm wall thickness).

2. Dipole impedance and return loss

The dipoles are designed to have low return loss ONLY when presented against a lossy-phantom at the specified distance. A Vector Network Analyser (VNA) was used to perform a return loss measurement on the specific dipole when in the measurement-location against the box phantom. The distance was as specified in the standard i.e. 10mm from the liquid (for 2450MHz). The Indexsar foam spacers (described above) were used to ensure this condition during measurement.

The impedance was measured at the SMA-connector with the network analyser. The following parameters were measured against Head fluid:

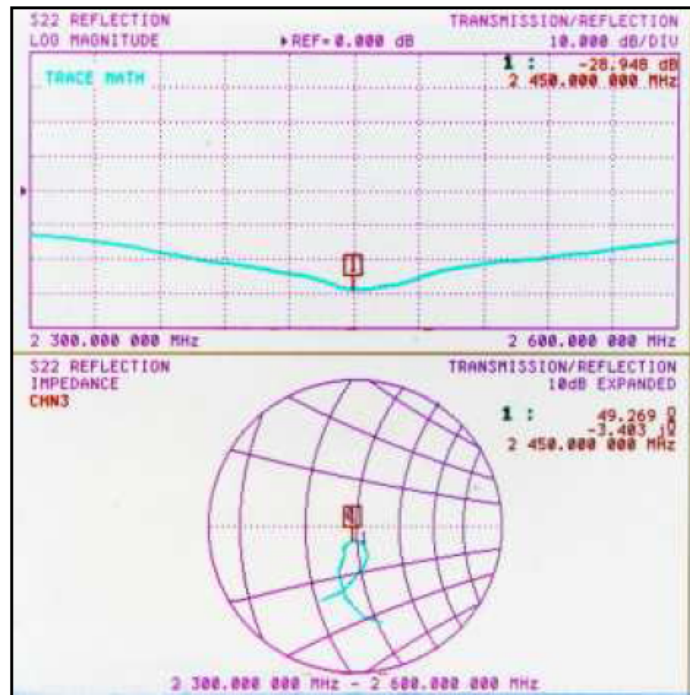

Dipole impedance at 2450 MHz $Re\{Z\} = 49.3 \Omega$
 $Im\{Z\} = -3.4 \Omega$

Return loss at 2450MHz **-28.9dB**

The measurements were also repeated against 2450 Body fluid:

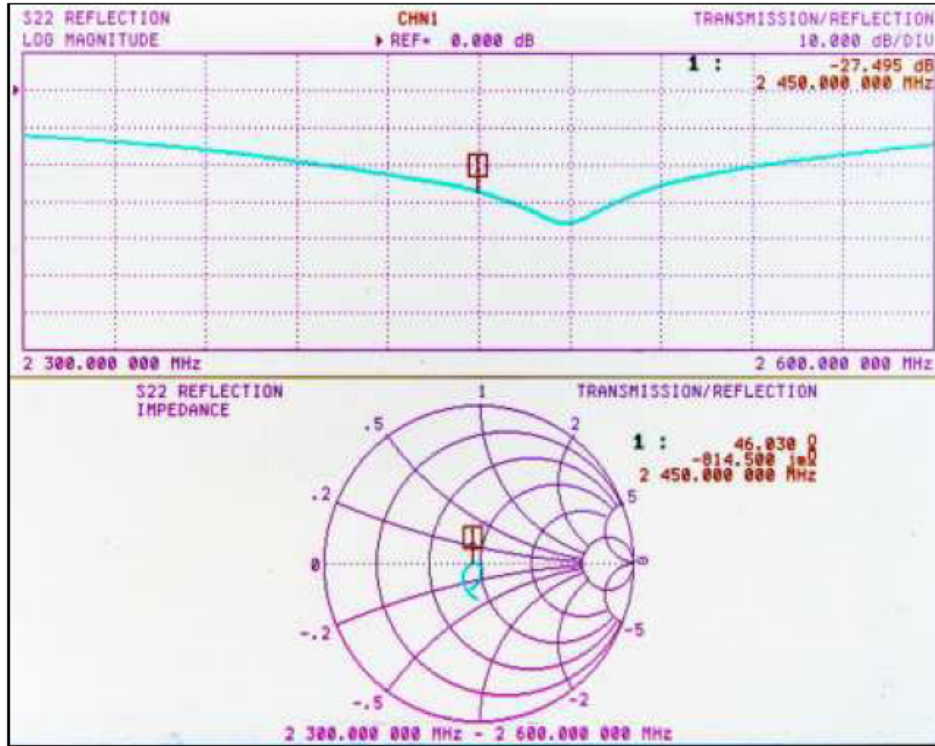

Dipole impedance at 2450 MHz $\text{Re}\{Z\} = 46.0 \Omega$
 $\text{Im}\{Z\} = -0.8 \Omega$

Return loss at 2450MHz **-27.5 dB**

3. SAR Validation Measurement in Brain Fluid

SAR validation checks have been performed using the 2450MHz dipole and the box-phantom located on the SARA-C phantom support base on the SARA-C robot system. Tests were then conducted at a feed power level of approx. 0.25W. The actual power level was recorded and used to normalise the results obtained to the standard input power conditions of 1W (forward power). The ambient temperature was 21°C +/- 1°C and the relative humidity was around 35% during the measurements.

The phantom was filled with a 2450MHz brain liquid using a recipe from [1], which has the following electrical parameters (measured using an Indexsar DiLine kit) at 2450MHz at the measurement temperature:

Relative Permittivity **38.0**
Conductivity **1.79 S/m**

The SARA-C software version v6.07.10 was used with Indexsar IXP_050 probe Serial Number 0221 previously calibrated using waveguides.

The 3D measurement made using the dipole at the bottom of the phantom box is shown below:

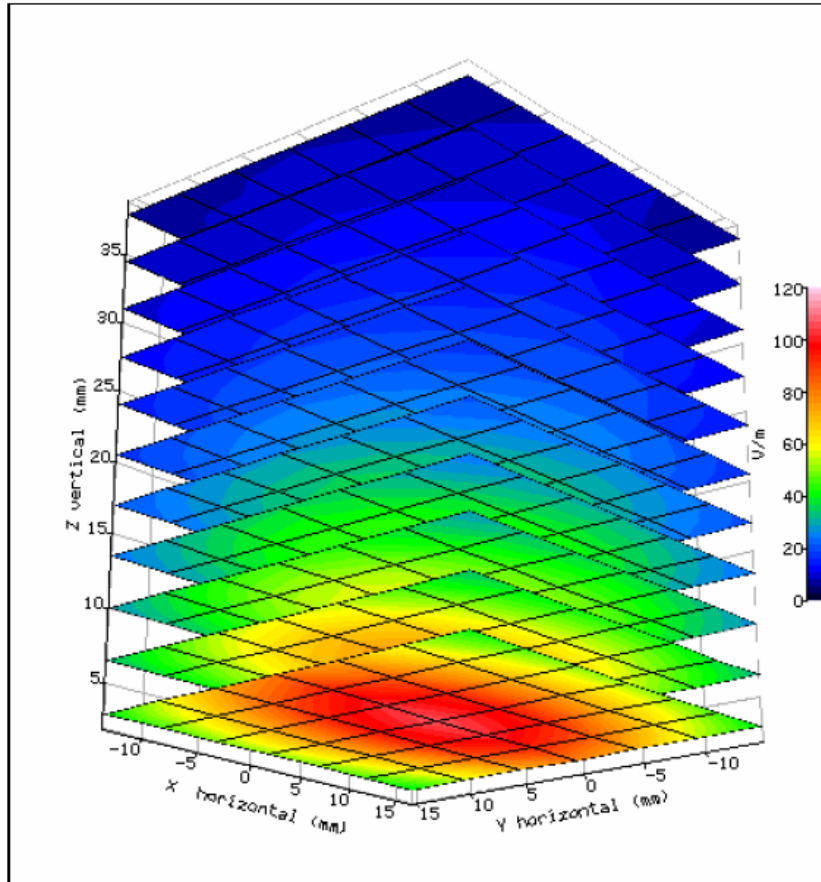

SAR measurement standard 62209-1 [ref 2] tabulates the volume-averaged 1g and 10g SAR values over a range of frequencies up to 3000MHz. The following values are listed for 2450MHz:

| | SAR values (W/kg) (Normalised to 1W feed power) |
|---------|--|
| 1g SAR | 52.4 |
| 10g SAR | 24.0 |

The validation results, also normalised to an input power of 1W (forward power) were:

| | Measured SAR values (W/kg) (Normalised to 1W feed power) | % Deviation from Standard |
|---------|---|---------------------------|
| 1g SAR | 49.24 | -6.0% |
| 10g SAR | 23.22 | -3.3% |

4. SAR Measurement in Body Fluid

SAR validation checks are only defined in the standard against brain simulant fluid. Nonetheless, it is possible to measure the effective volume-averaged SAR values against body fluid, simply to provide a reference value.

The ambient temperature was 22°C +/- 1°C and the relative humidity was around 32% during the measurements.

The phantom was filled with a 2450MHz body liquid using a recipe from [1], which has the following electrical parameters (measured using an Indexsar DiLine kit) at 2450MHz at the measurement temperature:

Relative Permittivity **53.24**
Conductivity **1.97 S/m**

The SARA-C software version v6.07.10 was used with Indexsar IXP_050 probe Serial Number 0227 previously calibrated by NPL using waveguides.

The 3D measurement made using the dipole at the bottom of the phantom box is shown below:

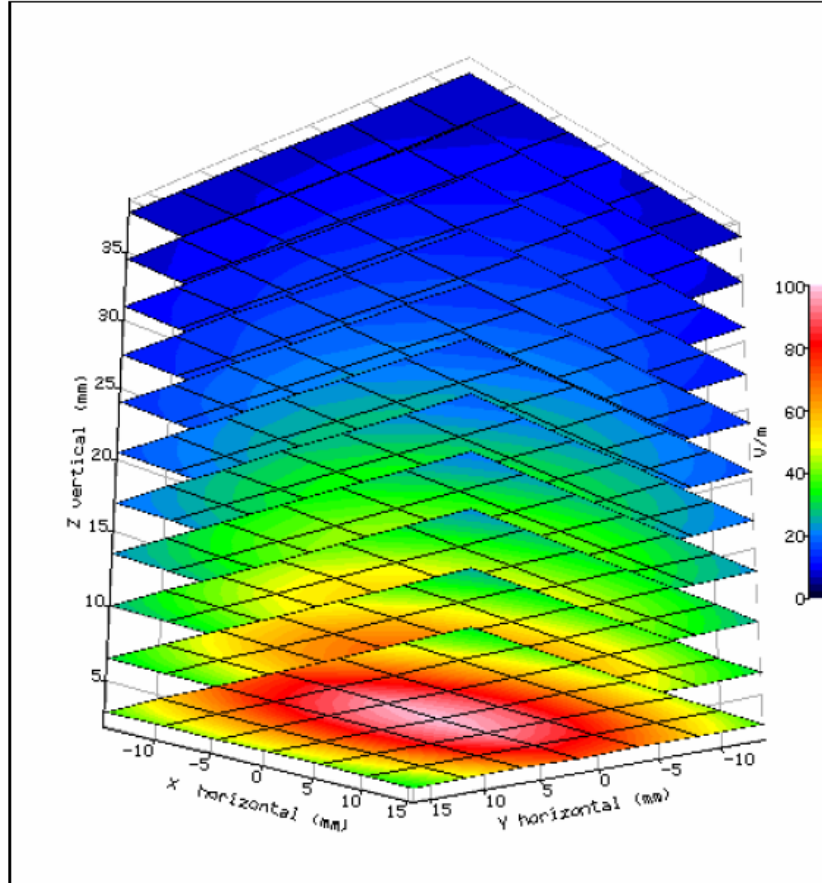

The validation results, also normalised to an input power of 1W (forward power) were:

| | Measured SAR values (W/kg) (Normalised to 1W feed power) | % Deviation from Standard |
|---------|---|---------------------------|
| 1g SAR | 43.9 | N/A |
| 10g SAR | 21.2 | N/A |

5. Dipole handling

The dipoles are made from standard, copper-sheathed coaxial cable. In assembly, the sections are joined using ordinary soft-soldering. This is necessary to avoid excessive heat input in manufacture, which would destroy the polythene dielectric used for the cable. The consequence of the construction material and the assembly technique is that the dipoles are fragile and can be deformed by

rough handling. Conversely, they can be straightened quite easily as described in this report.

If a dipole is suspected of being deformed, a normal workshop lathe can be used as an alignment jig to restore the symmetry. To do this, the dipole is first placed in the headstock of the lathe (centred on the plastic or brass spacers) and the headstock is rotated by hand (do NOT use the motor). A marker (lathe tool or similar) is brought up close to the end of one dipole arm and then the headstock is rotated by 0.5 rev. to check the opposing arm. If they are not balanced, judicious deformation of the arms can be used to restore the symmetry.

If a dipole has a failed solder joint, the dipole can be fixed down in such a way that the arms are co-linear and the joint re-soldered with a reasonably-powerful electrical soldering iron. Do not use gas soldering irons. After such a repair, electrical tests must be performed as described below.

Please note that, because of their construction, the dipoles are short-circuited for DC signals.

6. Tuning the dipole

The dipole dimensions are based on calculations that assumed specific liquid dielectric properties. If the liquid dielectric properties are somewhat different, the dipole tuning will also vary. A pragmatic way of accounting for variations in liquid properties is to 'tune' the dipole (by applying minor variations to its effective length). For this purpose, Indexsar can supply short brass tube lengths to extend the length of the dipole and thus 'tune' the dipole. It cannot be made shorter without removing a bit from the arm. An alternative way to tune the dipole is to use copper shielding tape to extend the effective length of the dipole. Do both arms equally.

It should be possible to tune a dipole as described, whilst in place in the measurement position as long as the user has access to a VNA for determining the return loss.

7. References

[1] IEEE Std 1528-2003. IEEE recommended practice for determining the peak spatial-average specific absorption rate (SAR) in the human body due to wireless communications devices: Measurement Techniques – Description.

[2] BS EN 62209-1:2006 Human exposure to radio frequency fields from hand-held and body-mounted wireless communication devices — Human models, instrumentation, and procedures — Part 1: Procedure to determine the specific absorption rate (SAR) for hand-held devices used in close proximity to the ear (frequency range of 300 MHz to 3 GHz)

INDEXSAR
2450MHz Validation Dipole
Type IXD-245 S/N 0048

Performance Verification Report

Date of Report: 08 Mar, 2013
Date of test: 06 Mar, 2013 to 07 Mar, 2013

Total No of Pages Contained in this Report: 13

1.0 Introduction

According to KDB 865664 SAR measurement 100MHz to 6GHz v01, it is necessary to re-calibrate reference dipoles at regular intervals to confirm the electrical specifications and SAR targets. A dipole must be calibrated using a fully validated SAR system according to the tissue dielectric parameters and SAR probe calibration frequency required for device testing. It is generally unacceptable to calibrate a dipole using the SAR system that has been validated by the same dipole; therefore, dipoles should be returned to the SAR system manufacturer or its designated calibration facilities for re-calibration. However, instead of the typical annual calibration recommended by measurement standards, longer calibration intervals of up to three years may be considered when it is demonstrated that the SAR target, impedance and return loss of a dipole have remain stable according to the following requirements.

1. The test laboratory must ensure that the required supporting information and documentation are included in the SAR report to qualify for the three-year extended calibration interval; otherwise, the IEEE Std 1528-2003 recommended annual calibration applies.
2. Immediate re-calibration is required for the following conditions.
 - a. After a dipole is damaged and properly repaired to meet required specifications.
 - b. When the measured SAR deviates from the calibrated SAR value by more than 10% due to changes in physical, mechanical, electrical or other relevant dipole conditions; i.e., the error is not introduced by incorrect measurement procedures or other issues relating to the SAR measurement system.
 - c. When the most recent return-loss result, measured at least annually, deviates by more than 20% from the previous measurement (i.e. value in dB x 0.2) or not meeting the required 20 dB minimum return-loss requirement.
 - d. When the most recent measurement of the real or imaginary parts of the impedance, measured at least annually, deviates by more than 5 Ω from the previous measurement.

And the purpose of this dipole validation report is to demonstrate the SAR target, impedance and return loss of the dipole are still remain stable with reference to the annual calibration data.

2.0 Measurement Conditions

Measurements were performed using a box-shaped phantom made of PMMA with dimensions designed to meet the accuracy criteria for reasonably-sized phantoms that do not have liquid capacities substantially in excess of the volume of liquid required to fill the Indexsar upright SAM phantoms used for SAR testing of handsets against the ear. The wall thickness was 2mm.

An Agilent E5071B vector network analyzer was used for the return loss measurements. The dipole was placed in a special holder made of low permittivity, low-loss materials. This holder enables the dipole to be positioned accurately in the centre of the wall of the Indexsar box-phantom used for flat surface testing and verification checks.

2.1 Instruments List

The Specific Absorption Rate (SAR) tests were performed with the INDEXSAR SARA2 SYSTEM.

The following major equipment/components were used for the SAR evaluations:

| SAR Measurement System | | | | |
|------------------------------------|---|-----------------|--------------|-------------|
| EQUIPMENT | SPECIFICATIONS | Intertek ID No. | Last Cal. | Due Date |
| Balanced Validation Dipole Antenna | 2450MHz | EW-2900-05 | 12,Mar 2012 | 12,Mar 2015 |
| Controller | Mitsubishi CR-E116 | EW-2902-04 | N/A | |
| Robot | Mitsubishi RV-E2 | EW-2902-05 | N/A | |
| | Repeatability: ± 0.04 mm; Number of Axes: 6 | | | |
| E-Field Probe | IXP-050 | EW-2900-01 | 16,Feb 2013 | 16,Feb 2015 |
| | Frequency Range: 450 MHz – 3000 MHz Probe outer diameter: 5.2 mm; Length: 350 mm; Distance between the probe tip and the dipole center: 2.7 mm | | | |
| Data Acquisition | SARA2 | N/A | N/A | |
| | Processor: Pentium 4; Clock speed: 1.5GHz; OS: Windows XP; I/O: two RS232; Software: SARA2 ver. 2.54 VPM | | | |
| Phantom | 2mm wall thickness box phantom | N/A | N/A | |
| | The body phantom shell should be made of low-loss dielectric material with dielectric constant and loss tangent less than 5.0 and 0.05 respectively. The shell thickness for all regions coupled to the test device and its antenna should be within 2.0 ± 0.2 mm. The phantom should be filled with the required head or body equivalent tissue medium to a depth of 15.0 ± 0.5 cm. Body capacity: $168 \times 395 \times 174$ (W x L x D) mm ³ . | | | |
| Simulated Tissue | Mixture | N/A | 06, Mar 2013 | |
| | Please see section 2.2 for details | | | |
| Vector Analyzer | Network AGILENTTECH E5071B | EW-9001 | 30,Jan 2013 | 30,Jan 2014 |
| | 9kHz to 8.5GHz | | | |

Note: The above equipments are within the valid calibration period

2.2 Tissue Simulating Liquid

The brain and body tissue parameters should be used to test operating frequency band of transmitters. When a transmission band overlaps with one of the target frequencies, the tissue dielectric parameters of the tissue medium at the middle of a device transmission band should be within $\pm 5\%$ of the parameters specified at that target frequency.

2.2.1 Brain Tissue Simulating Liquid Recipes

| Brain Ingredients Frequency (2450 MHz) | |
|--|--------|
| Tween20 | 44.67% |
| De-ionised Water | 55.11% |
| Acticide SPX | 0.22% |

The dielectric parameters were verified prior to assessment using the AGILENTTECH 85033D calibration kit and the AGILENTTECH E5071B network Analyzer. The dielectric parameters were:

| Freq. (MHz) | Temp. (°C) | ϵ_r / Relative Permittivity | | | σ / Conductivity | | | ρ^{**} (kg/m ³) |
|-------------|------------|--------------------------------------|---------|------------------------|-------------------------|---------|------------------------|----------------------------------|
| | | measured | Target* | Δ ($\pm 5\%$) | measured | Target* | Δ ($\pm 5\%$) | |
| 2450 | 22.0 | 39.157 | 39.20 | -0.11% | 1.755 | 1.80 | -2.6% | 1000 |

* Target values refer to KDB 865664

** Worst-case assumption

Note:

1. Date of tissue verification measurement: 06-Mar-2013
2. Ambient temperature: 23.0 deg C
3. The temperature condition is within +/- 2 deg. C during the SAR measurements.

2.2.2 Body Tissue Simulating Liquid Recipes

| Body Ingredients Frequency (2450 MHz) | |
|---------------------------------------|--------|
| Tween20 | 28.79% |
| De-ionised Water | 70.68% |
| Acticide SPX | 0.28% |
| Salt | 0.25% |

The dielectric parameters were verified prior to assessment using the AGILENTTECH 85033D calibration kit and the AGILENTTECH E5071B network Analyzer. The dielectric parameters were:

| Freq. (MHz) | Temp. (°C) | ϵ_r / Relative Permittivity | | | σ / Conductivity | | | ρ^{**} (kg/m ³) |
|-------------|------------|--------------------------------------|---------|------------------------|-------------------------|---------|------------------------|----------------------------------|
| | | measured | Target* | Δ ($\pm 5\%$) | measured | Target* | Δ ($\pm 5\%$) | |
| 2450 | 22.5 | 51.6 | 52.7 | -2.1% | 1.98 | 1.95 | -1.34% | 1000 |

* Target values refer to KDB 865664

** Worst-case assumption

Note:

1. Date of tissue verification measurement: 06-Mar-2013
2. Ambient temperature: 23.0 deg C
3. The temperature condition is within +/- 2 deg. C during the SAR measurements.

3.0 Dipole impedance and return loss

The dipoles are designed to have low return loss ONLY when presented against a lossy-phantom at the specified distance. A Vector Network Analyzer (VNA) was used to perform a return loss measurement on the specific dipole when in the measurement-location against the box phantom. The distance was as specified in the standard i.e. 10mm from the liquid (for 2450MHz). The Indexsar foam spacers (described above) were used to ensure this condition during measurement.

The impedance was measured at the SMA-connector with the network analyzer.

The following parameters were measured against Head fluid:

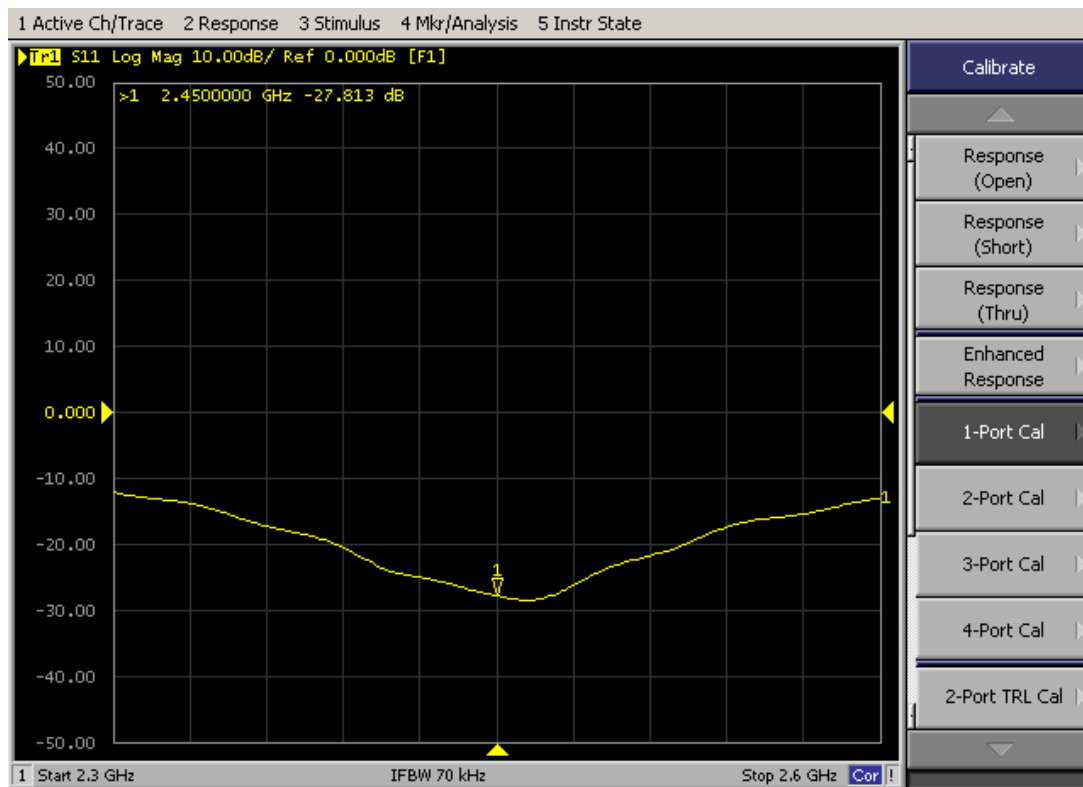

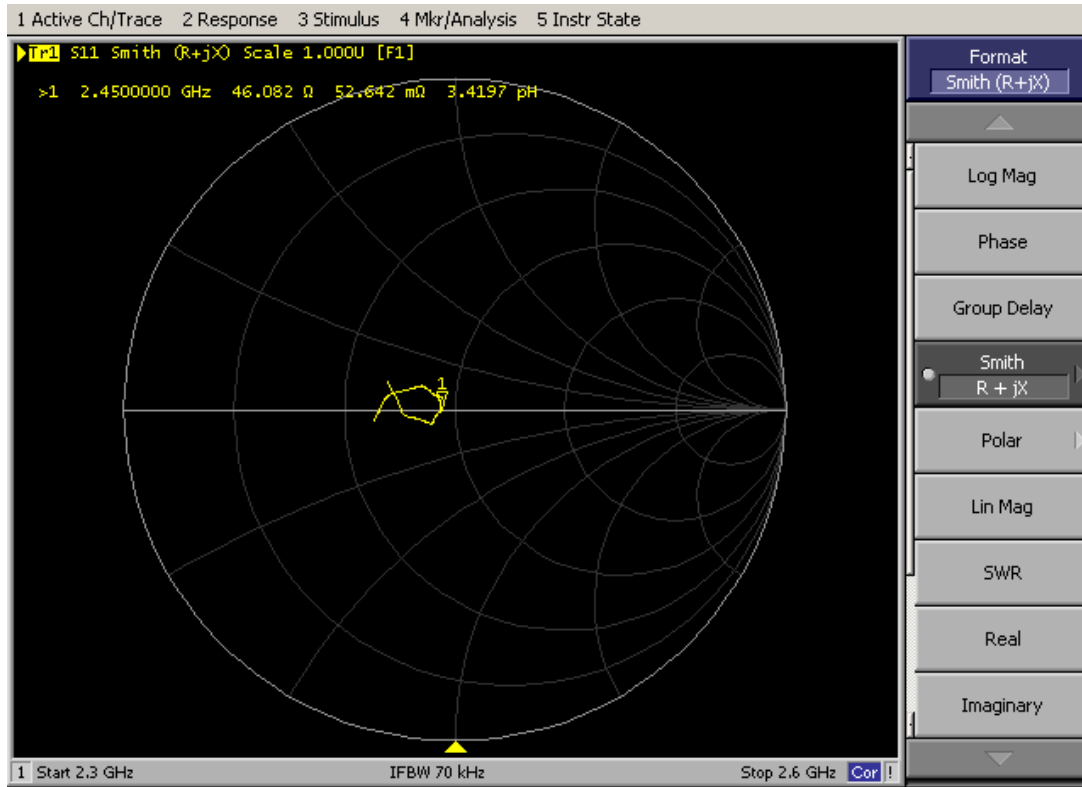

Test Summary

| Freq. (MHz) | Temp. (°C) | Dipole impedance Re{Z} | | | Dipole impedance Im{Z} | | |
|-------------|------------|------------------------|---------------|----------------------------|------------------------|---------------|----------------------------|
| | | measured | Target* | Δ ($\pm 5\Omega$) | measured | Target* | Δ ($\pm 5\Omega$) |
| 2450 | 22.6 | 46.1 Ω | 49.3 Ω | -3.2 Ω | 0.1 Ω | -3.4 Ω | +3.5 Ω |

| Freq. (MHz) | Temp. (°C) | Return loss | | |
|-------------|------------|-------------|----------|-------------------------|
| | | measured | Target* | Δ ($\pm 20\%$) |
| 2450 | 22.6 | -27.8dB | -28.9 dB | +8.7% |

* the target was quoted from 2450 dipole antenna calibration report

The following parameters were measured against Body fluid:

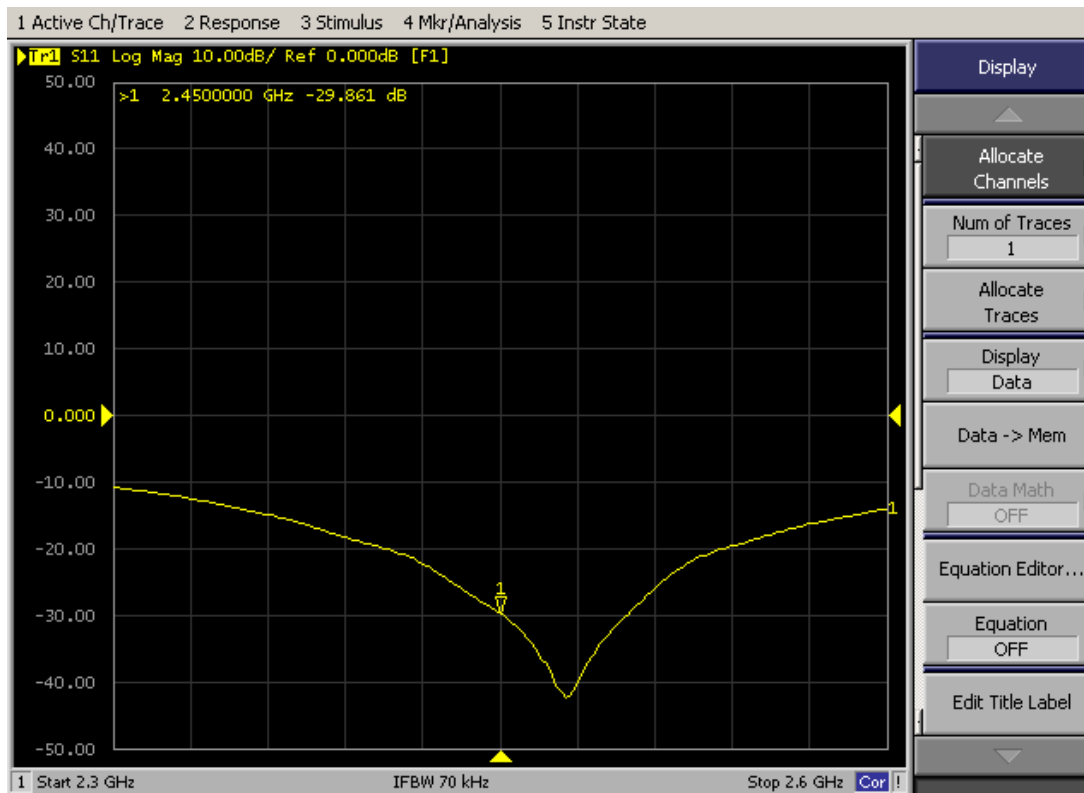

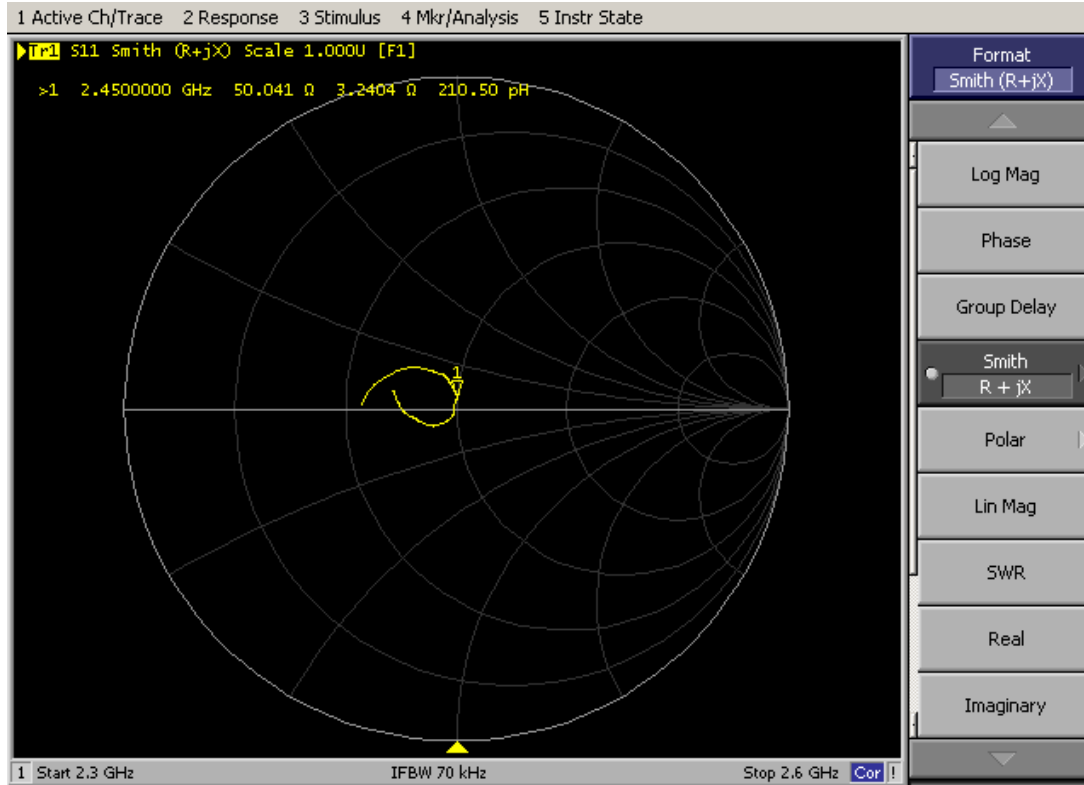

Test Summary

| Freq. (MHz) | Temp. (°C) | Dipole impedance Re{Z} | | | Dipole impedance Im{Z} | | |
|-------------|------------|------------------------|---------|---------|------------------------|---------|---------|
| | | measured | Target* | Δ (±5Ω) | measured | Target* | Δ (±5Ω) |
| 2450 | 22.3 | 50.0 Ω | 46.0 Ω | +4.0 Ω | 3.2 | -0.8 Ω | +4 Ω |

| Freq. (MHz) | Temp. (°C) | Return loss | | |
|-------------|------------|-------------|----------|----------|
| | | measured | Target* | Δ (±20%) |
| 2450 | 22.3 | -29.9dB | -27.5 dB | -8.7 % |

* the target was quoted from 2450 dipole antenna calibration report

4.0 SAR Verification Measurement

Routine record keeping procedures should be established for tracking the calibration and performance of SAR measurement system. When SAR measurements are performed, the entire measurement system should be checked daily within the device transmitting frequency ranges to verify system accuracy. A flat phantom irradiated by a half-wavelength dipole is typically used to verify the measurement accuracy of a system. According to KDB 865664, at 300MHz to 6GHz, measurements must be within ± 100 MHz of the probe calibration point frequency or the valid frequency range supported by the probe calibration, whichever is less. The measured one-gram SAR should be within 10% of the expected target values specified for the specific phantom and RF source used in the system verification measurement.

Procedures

The SAR evaluation was performed with the following procedures:

- a. The SAR distribution was measured at the exposed side of the bottom of the box phantom and was measured at a distance of 15 mm for 300 ~ 1000 MHz and 10 mm for 1000 ~ 3000 MHz from the inner surface of the shell. The feed power was 1/5W.
- b. The depth of tissue-equivalent liquid in a phantom must be $\geq 15.0\text{cm} \pm 0.5\text{cm}$ for SAR measurement $\leq 3000\text{MHz}$.
- c. The dimension for this cube is 32 mm x 32 mm x 30 mm was assessed by measuring 5 x 5 x 7 points for 300 ~ 2000 MHz and 30 mm x 30 mm x 30 mm was assessed by measuring 7 x 7 x 7 points for 2000 ~ 3000 MHz. On the basis of this data set, the spatial peak SAR value was evaluated with the following procedure:
 - i) The data at the surface were extrapolated, since the center of the dipoles is 2.7 mm away from the tip of the probe and the distance between the surface and the lowest measurement point is 5 mm. The extrapolation was based on a least square algorithm. A polynomial of the fourth order was calculated through the points in Z-axes. This polynomial was then used to evaluate the points between the surface and the probe tip.
 - ii) The maximum interpolated value was searched with a straightforward algorithm. Around this maximum, the SAR values averaged over the spatial volumes (1g or 10g) were computed using the 3-D spline interpolation algorithm. The 3-D spline is composed of three one-dimensional splines with the "Not a knot" condition (in x, y and z directions). The volume was integrated with the trapezoidal algorithm. 1000 points (10 x 10 x 10) were interpolated to calculate the average.
 - iii) All neighboring volumes were evaluated until no neighboring volume with a higher average value was found.
- d. Re-measurements of the SAR value at the same location as in step a. above. If the value changed by more than 5 %, the evaluation was repeated.
- e. The test scan procedure for system verification also applies to the general scan procedure except for the set-up position. For general scan, the EUT was placed at the side of phantom. For Verification scan, the dipole antenna was placed at the bottom of phantom.

4.1 System Verification results

| System Verification (2450MHz) | | | | | | | | |
|-------------------------------|-------------|-------------|---------------|------------|---------------------------------|-----------------------------------|-------------------------------------|------------------|
| Date | Freq. (MHz) | Liquid Type | System Diople | Serial No. | Target SAR _{1g} (W/kg) | Measured SAR _{1g} (W/kg) | Normalized SAR _{1g} (W/kg) | Deviation (±10%) |
| 7 Mar 2013 | 2450 | Brain | Type IXD-245 | 0048 | 49.24* | 9.383 | 46.92 | -4.71% |

| System Verification (2450MHz) | | | | | | | | |
|-------------------------------|-------------|-------------|---------------|------------|---------------------------------|-----------------------------------|-------------------------------------|------------------|
| Date | Freq. (MHz) | Liquid Type | System Diople | Serial No. | Target SAR _{1g} (W/kg) | Measured SAR _{1g} (W/kg) | Normalized SAR _{1g} (W/kg) | Deviation (±10%) |
| 7 Mar 2013 | 2450 | Body | Type IXD-245 | 0048 | 43.90* | 9.314 | 46.57 | 6.08% |

* the target was quoted from 2450 dipole antenna calibration report

* Input power level = 23dBm (0.2W)

2450 Head SAR_{1g} ambient measured value: 0.001 (W/kg)

2450 Body SAR_{1g} ambient measured value: 0.001 (W/kg)

Details of System Verification plot is shown in plot 1 and 2.

Plot 1: System Verification (2450MHz) for Brain tissue liquid

| | | | |
|------------------------|----------------------------|--------------------------|-----------------------|
| Date / Time: | 07/03/2013 4:48:08 PM | Position: | bottom of box phantom |
| Filename: | 2450_head_val_7_3_2013.txt | Phantom: | HeadBox1-val.csv |
| Device Tested: | 2450_Val | Test Channel: | N/A |
| Antenna: | 2450MHz Dipole | Test Frequency: | 2450MHz |
| Shape File: | none.csv | Power Level: | 23dBm |
| Operation Mode: | N/A | Modn. Duty Cycle: | N/A |

| Probe: | 0136 | | | | | | | | | | | | | | | | | | | | |
|-----------------------|---|------|------|-----|---|------------|-----|-----|-----|------------|----|----|----|------------|------|------|------|--|---|---|---|
| Cal File: | SN0136_2450_HEAD | | | | | | | | | | | | | | | | | | | | |
| Cal Factors: | <table border="1"> <thead> <tr> <th></th> <th>X</th> <th>Y</th> <th>Z</th> </tr> </thead> <tbody> <tr> <td>Air</td> <td>459</td> <td>362</td> <td>378</td> </tr> <tr> <td>DCP</td> <td>20</td> <td>20</td> <td>20</td> </tr> <tr> <td>Lin</td> <td>0.42</td> <td>0.42</td> <td>0.42</td> </tr> <tr> <td></td> <td>4</td> <td>4</td> <td>4</td> </tr> </tbody> </table> | | X | Y | Z | Air | 459 | 362 | 378 | DCP | 20 | 20 | 20 | Lin | 0.42 | 0.42 | 0.42 | | 4 | 4 | 4 |
| | | X | Y | Z | | | | | | | | | | | | | | | | | |
| | Air | 459 | 362 | 378 | | | | | | | | | | | | | | | | | |
| | DCP | 20 | 20 | 20 | | | | | | | | | | | | | | | | | |
| Lin | 0.42 | 0.42 | 0.42 | | | | | | | | | | | | | | | | | | |
| | 4 | 4 | 4 | | | | | | | | | | | | | | | | | | |
| Extrapolation: | Poly 4 | | | | | | | | | | | | | | | | | | | | |

| | |
|-------------------------------|---------------|
| Liquid Depth: | 15.5 cm |
| Liquid Type: | 2450 MHz Head |
| Conductivity: | 1.755 |
| Relative Permittivity: | 39.157 |
| Liquid Temp (Before): | 22.0 deg |
| Liquid Temp (After): | 22.2 deg |
| Ambient Temp: | 22.4deg |
| Ambient RH (%): | 58 |
| Density (kg/m3): | 1000 |

ZOOM SCAN RESULTS:

| | | |
|-------------------------|-------------------|-----------------|
| Spot SAR (W/kg): | Start Scan | End Scan |
| | 0.766 | 0.756 |

Change during Scan (%): -1.27%

Max E-field (V/m): 73.66

| | | |
|-----------------------|-----------|------------|
| Max SAR (W/kg) | 1g | 10g |
| | 9.383 | 4.501 |

Max Spot SAR (W/kg): 9.523

| | | | |
|------------------------------|----------|----------|----------|
| Location of Max (mm): | X | Y | Z |
| | 0.0 | 0.0 | -219.5 |

Measurement Resolution (7x7x7):
dx = 5mm, dy = 5mm, dz = 5mm

Normalized to an input power of 1W and averaged over 1cm3 (1g) of tissue –
Max SAR = 46.915 W/kg

Plot 2: System Verification (2450MHz) for Body tissue liquid

| | | | |
|------------------------|------------------------------|--------------------------|-----------------------|
| Date / Time: | 07/03/2013 6:18:25 PM | Position: | bottom of box phantom |
| Filename: | 2450_body_val_7_3_2013_2.txt | Phantom: | HeadBox1-val.csv |
| Device Tested: | 2450_Val | Test Channel: | N/A |
| Antenna: | 2450MHz Dipole | Test Frequency: | 2450MHz |
| Shape File: | none.csv | Power Level: | 23dBm |
| Operation Mode: | N/A | Modn. Duty Cycle: | N/A |

| Probe: | 0136 | | | | | | | | | | | | | | | | |
|-----------------------|---|------|------|-----|---|------------|-----|-----|-----|------------|----|----|----|------------|------|------|------|
| Cal File: | SN0136_2450_BODY | | | | | | | | | | | | | | | | |
| Cal Factors: | <table border="1"> <thead> <tr> <th></th> <th>X</th> <th>Y</th> <th>Z</th> </tr> </thead> <tbody> <tr> <td>Air</td> <td>459</td> <td>362</td> <td>378</td> </tr> <tr> <td>DCP</td> <td>20</td> <td>20</td> <td>20</td> </tr> <tr> <td>Lin</td> <td>.478</td> <td>.478</td> <td>.478</td> </tr> </tbody> </table> | | X | Y | Z | Air | 459 | 362 | 378 | DCP | 20 | 20 | 20 | Lin | .478 | .478 | .478 |
| | | X | Y | Z | | | | | | | | | | | | | |
| | Air | 459 | 362 | 378 | | | | | | | | | | | | | |
| | DCP | 20 | 20 | 20 | | | | | | | | | | | | | |
| Lin | .478 | .478 | .478 | | | | | | | | | | | | | | |
| Extrapolation: | Poly 4 | | | | | | | | | | | | | | | | |

| | |
|-------------------------------|---------------|
| Liquid Depth: | 15.5 cm |
| Liquid Type: | 2450 MHz Body |
| Conductivity: | 1.98 |
| Relative Permittivity: | 51.6 |
| Liquid Temp (Before): | 22.6 deg |
| Liquid Temp (After): | 22.7 deg |
| Ambient Temp: | 22.0deg |
| Ambient RH (%): | 62 |
| Density (kg/m3): | 1000 |

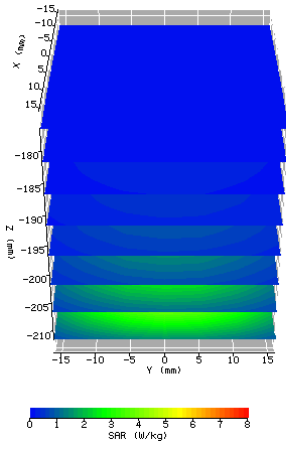

ZOOM SCAN RESULTS:

| | | |
|-------------------------|-------------------|-----------------|
| Spot SAR (W/kg): | Start Scan | End Scan |
| | 0.846 | 0.856 |

Change during Scan (%): 1.13%

Max E-field (V/m): 69.35

| | | |
|-----------------------|-----------|------------|
| Max SAR (W/kg) | 1g | 10g |
| | 9.314 | 4.453 |

Max Spot SAR (W/kg): 9.522

| | | | |
|------------------------------|----------|----------|----------|
| Location of Max (mm): | X | Y | Z |
| | 0.0 | 0.0 | -219.8 |

Measurement Resolution (7x7x7):
dx = 5mm, dy = 5mm, dz = 5mm

Normalized to an input power of 1W and averaged over 1cm3 (1g) of tissue –
Max SAR = 46.57 W/kg

APPENDIX D – SAR Tissue Specification**2450MHz Brain Tissue Simulating Liquid Measurement Result**

| Freq (MHz) | Amp (dBm) | Phase (°) | Perm | Cond (S/m) |
|------------|-----------|-----------|--------|------------|
| 2400 | -34.035 | 174.971 | 38.114 | 1.762 |
| 2410 | -34.054 | 172.754 | 38.077 | 1.773 |
| 2420 | -34.162 | 170.5 | 38.04 | 1.784 |
| 2430 | -34.403 | 168.244 | 38.003 | 1.795 |
| 2440 | -34.75 | 165.647 | 37.966 | 1.806 |
| 2450 | -35.153 | 162.403 | 37.929 | 1.817 |
| 2460 | -35.549 | 158.382 | 37.893 | 1.828 |
| 2470 | -35.838 | 153.568 | 37.857 | 1.839 |
| 2480 | -35.993 | 148.814 | 37.821 | 1.85 |
| 2490 | -35.998 | 144.697 | 37.785 | 1.861 |
| 2500 | -35.891 | 141.228 | 37.75 | 1.873 |

2450MHz Body Tissue Simulating Liquid Measurement Result

| Freq (MHz) | Amp (dBm) | Phase (°) | Perm | Cond (S/m) |
|------------|-----------|-----------|--------|------------|
| 2400 | -34.114 | 5.347 | 51.527 | 1.969 |
| 2410 | -34.277 | 1.143 | 51.498 | 1.98 |
| 2420 | -34.45 | -2.708 | 51.439 | 1.992 |
| 2430 | -34.598 | -6.98 | 51.417 | 2.003 |
| 2440 | -34.737 | -11.374 | 51.406 | 2.013 |
| 2450 | -34.858 | -15.159 | 51.347 | 2.021 |
| 2460 | -35.044 | -19.595 | 51.337 | 2.034 |
| 2470 | -35.249 | -23.957 | 51.321 | 2.049 |
| 2480 | -35.409 | -28.156 | 51.294 | 2.06 |
| 2490 | -35.595 | -32.147 | 51.249 | 2.073 |
| 2500 | -35.753 | -36.501 | 51.236 | 2.085 |

APPENDIX E – SAR System Validation

Per KDB 865664, SAR system validation status should be documented to confirm measurement accuracy. SAR measurement systems are validated according to procedures in KDB 865664. The validation status is documented according to the validation date(s), measurement frequencies, SAR probe and tissue dielectric parameters. When multiple SAR system is used, the validation status of each SAR system is needed to be documented separately according to the associated system components.

A tabulated summary of the system validation status including the validation date(s), measurement frequencies, SAR probe and tissue dielectric parameters are shown as below.

| Date | Probe S/N | Tested Freq. (MHz) | Tissue Type | Cond. | Perm | CW Validation | | | Mod. Validation | | |
|------------|-----------|--------------------|-------------|-------|------|---------------|-----------------|----------------|-----------------|-------------|-----------------------------|
| | | | | | | Sensitivity | Probe Linearity | Probe Isotropy | Mod. Type | Duty Factor | Peak to average power ratio |
| 06/03/2013 | 0136 | 1900 | Head | 39.62 | 1.43 | PASS | PASS | PASS | GFSK | PASS | N/A |
| 06/03/2013 | 0136 | 1900 | Body | 53.68 | 1.59 | PASS | PASS | PASS | GFSK | PASS | N/A |
| 13/03/2013 | 0136 | 2450 | Head | 39.16 | 1.75 | PASS | PASS | PASS | OFDM | N/A | PASS |
| 13/03/2013 | 0136 | 2450 | Body | 51.61 | 1.97 | PASS | PASS | PASS | OFDM | N/A | PASS |
| 22/03/2013 | 0136 | 900 | Head | 41.12 | 0.95 | PASS | PASS | PASS | GMSK | PASS | N/A |
| 20/05/2013 | 0136 | 450 | Head | 44.31 | 0.87 | PASS | PASS | PASS | FM | PASS | N/A |
| 20/05/2013 | 0136 | 450 | Body | 58.50 | 0.97 | PASS | PASS | PASS | FM | PASS | N/A |
| 10/12/2013 | 0136 | 2450 | Head | 38.70 | 1.82 | PASS | PASS | PASS | FHSS | PASS | N/A |
| 10/12/2013 | 0136 | 2450 | Body | 51.35 | 2.02 | PASS | PASS | PASS | FHSS | PASS | N/A |