

A Test Lab Techno Corp.

Changan Lab : No. 140 -1, Changan Street, Bade City, Taoyuan County, Taiwan R.O.C.

Tel : 886-3-271-0188 / Fax : 886-3-271-0190

SAR EVALUATION REPORT



Test Report No.	:	1302FS11-05
Applicant	:	VTech Telecommunications Ltd.
EUT Type	:	1.9GHz DECT 6.0 Cordless Phone
FCC ID	:	EW780-9103-00
Trade Name	:	at&t
Model Number	:	CLP99283
Dates of Receive	:	Feb. 01, 2013
Dates of Test	:	Feb. 01, 2013
Date of Issued	:	Mar. 05, 2013
Test Environment	:	Ambient Temperature : $22 \pm 2^{\circ} \text{C}$ Relative Humidity : 40 - 70 %
Test Specification	:	Standard C95.1-1992 IEEE Std. 1528-2003 IEEE Std. 1528a-2005 2.1093;FCC/OET Bulletin 65 Supplement C [July 2001]
Max. SAR	:	0.060 W/kg UPCS Head SAR
Test Lab Location	:	Chang-an Lab



1. The test operations have to be performed with cautious behavior, the test results are as attached.
2. The test results are under chamber environment of A Test Lab Techno Corp. A Test Lab Techno Corp. does not assume responsibility for any conclusions and generalizations drawn from the test results with regard to other specimens or samples.
3. The measurement report has to be written approval of A Test Lab Techno Corp. It may only be reproduced or published in full. This report shall not be reproduced except in full, without the written approval of A Test Lab Techno Corp. The test results in the report only apply to the tested sample.

Approved By : Yung-Tan Tsai Tested By : Bill Hu
(Yung Tan Tsai) (Bill Hu)



Contents

1. Description of Equipment under Test (EUT)	3
2. Introduction.....	4
3. SAR Definition	4
4. SAR Measurement Setup	5
5. System Components	6
5.1 DASY5 E-Field Probe System.....	6
5.2 Data Acquisition Electronic (DAE) System.....	9
5.3 Robot.....	9
5.4 Measurement Server	9
5.5 Device Holder for Transmitters	10
5.6 Phantom - SAM v4.0	10
5.7 Data Storage and Evaluation.....	11
6. Test Equipment List	14
7. Tissue Simulating Liquids	15
7.1 Ingredients.....	16
7.2 Recipes	16
7.3 Liquid Depth	17
8. Measurement Process.....	18
8.1 Device and Test Conditions	18
8.2 Conducted power	18
8.3 SAR Testing with RF Transmitters	19
8.4 Verification and Validation.....	21
8.5 Dosimetric Assessment Setup.....	23
8.6 Spatial Peak SAR Evaluation.....	25
9. Measurement Uncertainty.....	26
10. SAR Test Results Summary	29
10.1 Head SAR.....	29
10.2 Std. C95.1-1992 RF Exposure Limit	30
11. Conclusion.....	31
12. SAR Measurement Guidance.....	31
13. References	31
Appendix A - System Performance Check	32
Appendix B - SAR Measurement Data	33
Appendix C - Calibration.....	37



1. **Description of Equipment under Test (EUT)**

Applicant	VTech Telecommunications Ltd.
Applicant Address	23/F, Tai Ping Industrial Centre, Block 1, 57 Ting Kok Road, Tai Po, Hong Kong
Manufacturer	VTech (Dongguan) Telecommunications Limited
Manufacturer Address	VTech Science Park, Xia Ling Bei Management Zone, Liaobu, Dongguan, Guangdong, China
EUT Type	1.9GHz DECT 6.0 Cordless Phone
FCC ID	EW780-9103-00
Trade Name	at&t
Model Number	CLP99283
Battery Type	Ni-MH battery (2.4V, 400mAh)
Test Device	Production Unit
Tx Frequency	1921.536 -1928.448 MHz (UPCS)
Max. RF Conducted Power (Time-Average)	0.004 W (6.17 dBm) UPCS
Max. SAR Measurement	0.060 W/kg UPCS Head SAR
Antenna Type	Fixed Type
Antenna Gain	0dBi
Device Category	Portable
RF Exposure Environment	General Population / Uncontrolled
Battery Option	Standard
Application Type	Certification

This wireless portable device has been shown to be capable of compliance for localized specific absorption rate (SAR) for uncontrolled environment / general population exposure limits specified in Standard C95.1-1992 and had been tested in accordance with the measurement procedures specified in IEEE Std. 1528-2003 and IEEE Std. 1528a-2005.



2. Introduction

The A Test Lab Techno Corp. has performed measurements of the maximum potential exposure to the user of **VTech Telecommunications Ltd. Trade Name : at&t Model(s) : CLP99283**. The test procedures, as described in American National Standards, Institute C95.1 - 1992 [1] , FCC/OET Bulletin 65 Supplement C [July 2001] were employed and they specify the maximum exposure limit of 1.6mW/g as averaged over any 1 gram of tissue for portable devices being used within 20cm between user and EUT in the uncontrolled environment. A description of the product and operating configuration, detailed summary of the test results, methodology and procedures used in the equipment used are included within this test report.

3. SAR Definition

Specific Absorption Rate (SAR) is defined as the time derivative (rate) of the incremental energy (dw) absorbed by (dissipated in) an incremental mass (dm) contained in a volume element (dv) of a given density (ρ). It is also defined as the rate of RF energy absorption per unit mass at a point in an absorbing body (see Figure 2).

$$\text{SAR} = \frac{d}{dt} \left(\frac{dw}{dm} \right) = \frac{d}{dt} \left(\frac{dw}{\rho dv} \right)$$

Figure 2. SAR Mathematical Equation

SAR is expressed in units of Watts per kilogram (W/kg)

$$\text{SAR} = \frac{\sigma E^2}{\rho}$$

Where :

σ = conductivity of the tissue (S/m)

ρ = mass density of the tissue (kg/m³)

E = RMS electric field strength (V/m)

* **Note :**

The primary factors that control rate of energy absorption were found to be the wavelength of the incident field in relations to the dimensions and geometry of the irradiated organism, the orientation of the organism in relation to the polarity of field vectors, the presence of reflecting surfaces, and whether conductive contact is made by the organism with a ground plane [2]

4. SAR Measurement Setup

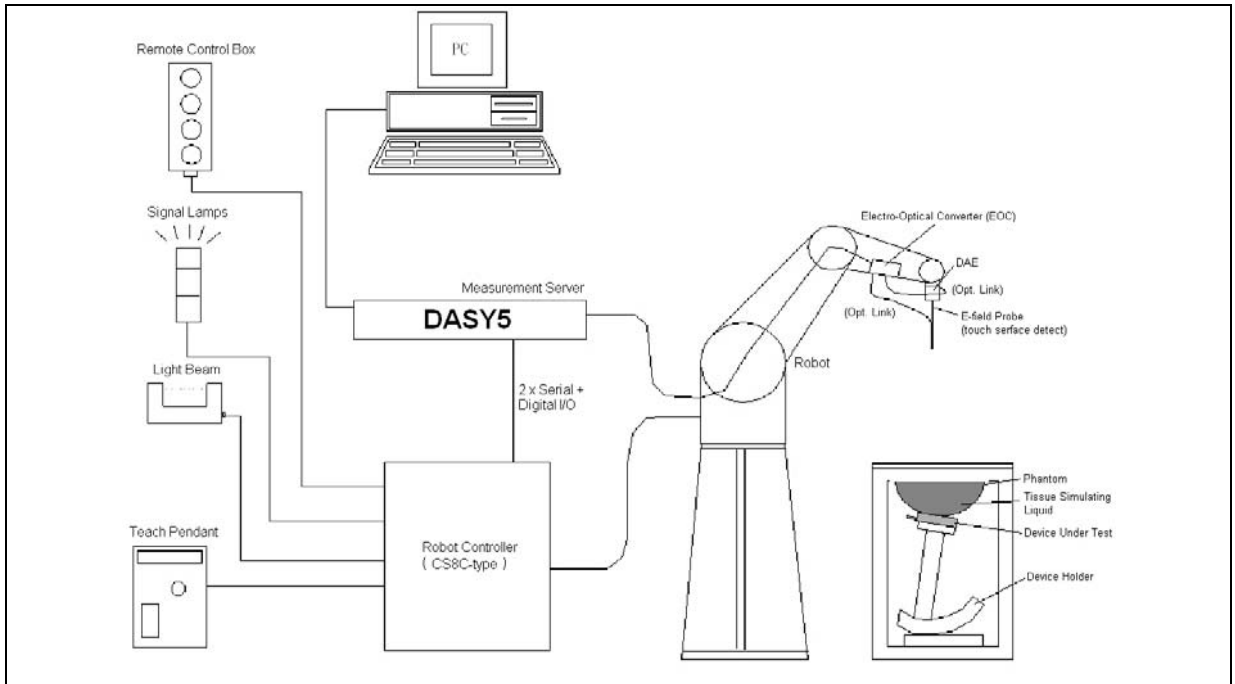

The DASY5 system for performing compliance tests consists of the following items:

1. A standard high precision 6-axis robot (Stäubli TX family) with controller, teach pendant and software. An arm extension for accommodating the data acquisition electronics (DAE).
2. A dosimetric probe, i.e., an isotropic E-field probe optimized and calibrated for usage in tissue simulating liquid. The probe is equipped with an optical surface detector system.
3. A data acquisition electronics (DAE) which performs the signal amplification, signal multiplexing, AD-conversion, offset measurements, mechanical surface detection, collision detection, etc. The unit is battery powered with standard or rechargeable batteries. The signal is optically transmitted to the EOC.
4. The function of the measurement server is to perform the time critical tasks such as signal filtering, control of the robot operation and fast movement interrupts.
5. A probe alignment unit which improves the (absolute) accuracy of the probe positioning.
6. A computer operating Windows 2000 or Windows XP.
7. DASY5 software.
8. Remote controls with teach pendant and additional circuitry for robot safety such as warning lamps, etc.
9. The SAM twin phantom enabling testing left-hand and right-hand usage.
10. The device holder for handheld mobile phones.
11. Tissue simulating liquid mixed according to the given recipes.
12. Validation dipole kits allowing validating the proper functioning of the system.



5. System Components

5.1 DASY5 E-Field Probe System

The SAR measurements were conducted with the dosimetric probe EX3DV3 (manufactured by SPEAG), designed in the classical triangular configuration (3) and optimized for dosimetric evaluation. The probe is constructed using the thick film technique; with printed resistive lines on ceramic substrates. The probe is equipped with an optical multi-fiber line ending at the front of the probe tip. It is connected to the EOC box on the robot arm and provides an automatic detection of the phantom surface. Half of the fibers are connected to a pulsed infrared transmitter, the other half to a synchronized receiver. As the probe approaches the surface, the reflection from the surface produces a coupling from the transmitting to the receiving fibers. This reflection increases first during the approach, reaches maximum and then decreases. If the probe is flatly touching the surface, the coupling is zero. The distance of the coupling maximum to the surface is independent of the surface reflectivity and largely independent of the surface to probe angle. The DASY5 software reads the reflection during a software approach and looks for the maximum using a 2nd order fitting. The approach is stopped when reaching the maximum.

5.1.1 E-Field Probe Specification

Construction	<p>Symmetrical design with triangular core</p> <p>Built-in optical fiber for surface detection System</p> <p>Built-in shielding against static charges</p> <p>PEEK enclosure material (resistant to organic solvents, e.q., glycol)</p>
Calibration	<p>In air from 10 MHz to 6 GHz</p> <p>In brain and muscle simulating tissue at frequencies of 1900MHz (accuracy $\pm 8\%$)</p> <p>Calibration for other liquids and frequencies upon request</p>
Frequency	± 0.2 dB (30 MHz to 6 GHz) for EX3DV3
Directivity	<p>± 0.3 dB in brain tissue (rotation around probe axis)</p> <p>± 0.5 dB in brain tissue (rotation normal probe axis)</p>
Dynamic Range	10 μ W/g to > 100mW/g; Linearity: ± 0.2 dB
Dimensions	<p>Overall length: 337mm</p> <p>Tip length: 20mm</p> <p>Body diameter: 12mm</p> <p>Tip diameter: 2.5mm for EX3DV3</p> <p>Distance from probe tip to dipole centers: 1.0mm for EX3DV3</p>
Application	<p>General dosimetry up to 6GHz</p> <p>Compliance tests of mobile phones</p> <p>Fast automatic scanning in arbitrary phantoms</p>

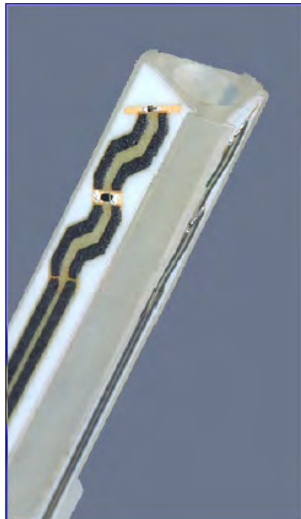

Figure 3. E-field Probe



Figure 4. Probe setup on robot



5.1.2 E-Field Probe Calibration

Dosimetric Assessment Procedure

Each E-Probe/Probe Amplifier combination has unique calibration parameters. A TEM cell calibration procedure is conducted to determine the proper amplifier settings to enter in the probe parameters. The amplifier settings are determined for a given frequency by subjecting the probe to a known E-field density (1 mW/cm²) using an RF Signal generator, TEM cell, and RF Power Meter.

Free Space Assessment

The free space E-field from amplified probe outputs is determined in a test chamber. This calibration can be performed in a TEM cell if the frequency is below 1 GHz and in a waveguide or other methodologies above 1 GHz for free space. For the free space calibration, the probe is placed in the volumetric center of the cavity and at the proper orientation with the field. The probe is rotated 360 degrees until the three channels show the maximum reading. The power density readings equates to 1 mW/cm².

Temperature Assessment

E-field temperature correlation calibration is performed in a flat phantom filled with the appropriate simulated head tissue. The E-field in the medium correlates with the temperature rise in the dielectric medium. For temperature correlation calibration a RF transparent thermistor-based temperature probe is used in conjunction with the E-field probe.

$$SAR = C \frac{\Delta T}{\Delta t}$$

Where :

Δt = Exposure time (30 seconds),

C = Heat capacity of tissue (head or body),

ΔT = Temperature increase due to RF exposure.

Or

$$SAR = \frac{|E|^2 \sigma}{\rho}$$

Where :

σ = Simulated tissue conductivity,

ρ = Tissue density (kg/m³).



5.2 Data Acquisition Electronic (DAE) System

Cell Controller

Processor : Intel Core(TM)2 CPU
Clock Speed : @ 1.86GHz
Operating System : Windows XP Professional

Data Converter

Features : Signal Amplifier, multiplexer, A/D converter, and control logic
Software : DASY5 v5.0 (Build 125) & SEMCAD X Version 13.4 Build 125
Connecting Lines : Optical downlink for data and status info
Optical uplink for commands and clock

5.3 Robot

Positioner : Stäubli Unimation Corp. Robot Model: TX90XL
Repeatability : ± 0.02 mm
No. of Axis : 6

5.4 Measurement Server

Processor : PC/104 with a 400MHz intel ULV Celeron
I/O-board : Link to DAE4 (or DAE3)
16-bit A/D converter for surface detection system
Digital I/O interface
Serial link to robot
Direct emergency stop output for robot

5.5 Device Holder for Transmitters

The DASY device holder is constructed of low-loss POM material having the following dielectric parameters: relative permittivity $\epsilon=3$ and loss tangent $\delta=0.02$. The amount of dielectric material has been reduced in the closest vicinity of the device, since measurements have suggested that the influence of the clamp on the test results could thus be lowered.

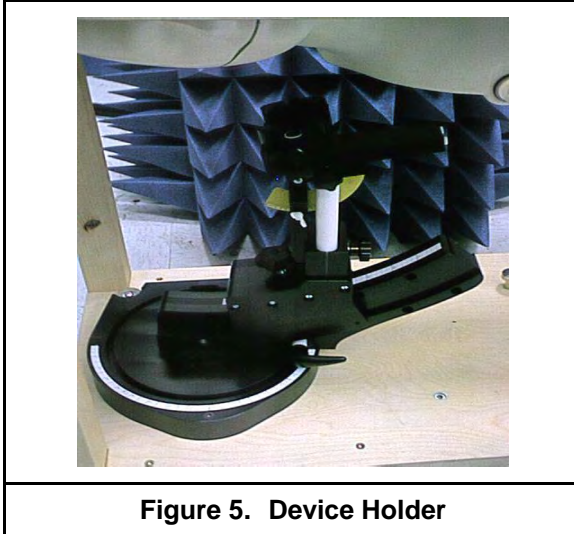

Figure 5. Device Holder

5.6 Phantom - SAM v4.0

The shell corresponds to the specifications of the Specific Anthropomorphic Mannequin (SAM) phantom defined in IEEE 1528 and IEC 62209. It enables the dosimetric evaluation of left and right hand phone usage as well as body mounted usage at the flat phantom region. A cover prevents evaporation of the liquid. Reference markings on the phantom allow the complete setup of all predefined phantom positions and measurement grids by manually teaching three points with the robot.

Shell Thickness	2 ±0.2 mm
Filling Volume	Approx. 25 liters
Dimensions	1000x500 mm (LxW)
Table 1. Specification of SAM v4.0	



Figure 6. SAM Twin Phantom



5.7 Data Storage and Evaluation

5.7.1 Data Storage

The DASY5 software stores the assessed data from the data acquisition electronics as raw data (in microvolt readings from the probe sensors), together with all the necessary software parameters for the data evaluation (probe calibration data, liquid parameters and device frequency and modulation data) in measurement files with the extension DA5. The post processing software evaluates the desired unit and format for output each time the data is visualized or exported. This allows verification of the complete software setup even after the measurement and allows correction of erroneous parameter settings. For example, if a measurement has been performed with an incorrect crest factor parameter in the device setup, the parameter can be corrected afterwards and the data can be reevaluated.

5.7.2 Data Evaluation

The DASY5 post processing software (SEMCAD) automatically executes the following procedures to calculate the field units from the microvolt readings at the probe connector. The parameters used in the evaluation are stored in the configuration modules of the software :

Probe parameters :	- Sensitivity	Normi, ai0, ai1, ai2
	- Conversion factor	ConvFi
	- Diode compression point	dcpi
Device parameters :	- Frequency	f
	- Crest factor	cf
Media parameters :	- Conductivity	σ
	- Density	ρ

These parameters must be set correctly in the software. They can be found in the component documents or they can be imported into the software from the configuration files issued for the DASY components. In the direct measuring mode of the multimeter option, the parameters of the actual system setup are used. In the scan visualization and export modes, the parameters stored in the corresponding document files are used.

The first step of the evaluation is a linearization of the filtered input signal to account for the compression characteristics of the detector diode. The compensation depends on the input signal, the diode type and the DC-transmission factor from the diode to the evaluation electronics. If the exciting field is pulsed, the crest factor of the signal must be known to correctly compensate for peak power. The formula for each channel can be given as :

$$V_i = U_i + U_i^2 \cdot \frac{cf}{dcp_i}$$

with V_i = compensated signal of channel i ($i = x, y, z$)

U_i = input signal of channel i ($i = x, y, z$)

cf = crest factor of exciting field (DASY parameter)

dcp_i = diode compression point (DASY parameter)

From the compensated input signals the primary field data for each channel can be evaluated :

E-field probes :

$$E_i = \sqrt{\frac{V_i}{Norm_i \cdot ConvF}}$$

H-field probes :

$$H_i = \sqrt{V_i} \cdot \frac{a_{i0} + a_{i1}f + a_{i2}f^2}{f}$$

with V_i = compensated signal of channel i ($i = x, y, z$)

$Norm_i$ = sensor sensitivity of channel i ($i = x, y, z$)

$\mu V/(V/m)^2$ for E-field Probes

$ConvF$ = sensitivity enhancement in solution

a_{ij} = sensor sensitivity factors for H-field probes

f = carrier frequency [GHz]

E_i = electric field strength of channel i in V/m

H_i = magnetic field strength of channel i in A/m

The RSS value of the field components gives the total field strength (Hermitian magnitude) :

$$E_{tot} = \sqrt{E_x^2 + E_y^2 + E_z^2}$$



The primary field data are used to calculate the derived field units.

$$SAR = E_{tot}^2 \cdot \frac{\sigma}{\rho \cdot 1000}$$

with **SAR** = local specific absorption rate in mW/g

E_{tot} = total field strength in V/m

σ = conductivity in [mho/m] or [Siemens/m]

ρ = equivalent tissue density in g/cm³

*** Note** : That the density is set to 1, to account for actual head tissue density rather than the density of the tissue simulating liquid.

The power flow density is calculated assuming the excitation field to be a free space field.

$$P_{pwe} = \frac{E_{tot}^2}{3770} \quad \text{or} \quad P_{pwe} = \frac{H_{tot}^2}{37.7}$$

with P_{pwe} = equivalent power density of a plane wave in mW/cm²

E_{tot} = total electric field strength in V/m

H_{tot} = total magnetic field strength in A/m



6. Test Equipment List

Manufacturer	Name of Equipment	Type/Model	Serial Number	Calibration	
				Last Cal.	Due Date
SPEAG	1950MHz System Validation Kit	D1950V3	1117	Feb. 23, 2012	Feb. 23, 2013
SPEAG	Dosimetric E-Field Probe	EX3DV3	3519	Feb. 21, 2012	Feb. 21, 2013
SPEAG	Data Acquisition Electronics	DAE4	541	Jul. 23, 2012	Jul. 23, 2013
SPEAG	Measurement Server	SE UMS 011 AA	1025	NCR	
SPEAG	Device Holder	N/A	N/A	NCR	
SPEAG	Phantom	SAM V4.0	TP-1150	NCR	
SPEAG	Robot	Staubli TX90XL	F07/564ZA1/C/01	NCR	
SPEAG	Software	DASY5 V5.0 Build 125	N/A	NCR	
SPEAG	Software	SEMCAD V13.4 Build 125	N/A	NCR	
Agilent	ENA Series Network Analyzer	E5071B	MY42402996	Jan. 09, 2013	Jan. 09, 2015
Agilent	Dielectric Probe Kit	85070C	US99360094	NCR	
R&S	Power Sensor	NRP-Z22	100179	May 16, 2012	May 16, 2013
Agilent	MXG Vector Signal Generator	N5182A	MY47420962	May 24, 2011	May 24, 2013
Agilent	Dual Directional Coupler	778D	50334	NCR	
Mini-Circuits	Power Amplifier	ZHL-42W-SMA	D111103#5	NCR	
Mini-Circuits	Power Amplifier	ZVE-8G-SMA	D042005 671800514	NCR	
Aisi	Attenuator	IEAT 3dB	N/A	NCR	

Table 2. Test Equipment List



7. Tissue Simulating Liquids

The mixture is calibrated to obtain proper dielectric constant (permittivity) and conductivity of the tissue. The dielectric parameters of the liquids were verified prior to the SAR evaluation using an 85070C Dielectric Probe Kit and an E5071B Network Analyzer.

IEEE SCC-34/SC-2 in 1528 recommended Tissue Dielectric Parameters

The head tissue dielectric parameters recommended by the IEEE SCC-34/SC-2 in 1528 have been incorporated in the following table. These head parameters are derived from planar layer models simulating the highest expected SAR for the dielectric properties and tissue thickness variations in human head. Other head and body tissue parameters that have not been specified in 1528 are derived from the tissue dielectric parameters computed from the 4-Cole-Cole equation and extrapolated according to the head parameter specified in 1528.

€ (MHz)	Head		Body	
	ϵ_r	σ (S/m)	ϵ_r	σ (S/m)
150	52.3	0.76	61.9	0.80
300	45.3	0.87	58.2	0.92
450	43.5	0.87	56.7	0.94
835	41.5	0.90	55.2	0.97
900	41.5	0.97	55.0	1.05
915	41.5	0.98	55.0	1.06
1450	40.5	1.20	54.0	1.30
1610	40.3	1.29	53.8	1.40
1800 - 2000	40.0	1.40	53.3	1.52
2450	39.2	1.80	52.7	1.95
3000	38.5	2.40	52.0	2.73
5800	35.3	5.27	48.2	6.00
(ϵ_r = relative permittivity, σ = conductivity and $\rho = 1000 \text{ kg/m}^3$)				

Table 3. Tissue dielectric parameters for head and body phantoms



7.1 Ingredients

The following ingredients are used:

- Water: deionized water (pure H₂O), resistivity $\geq 16 \text{ M } \Omega$ -as basis for the liquid
- Sugar: refined white sugar (typically 99.7 % sucrose, available as crystal sugar in food shops) to reduce relative permittivity
- Salt: pure NaCl -to increase conductivity
- Cellulose: Hydroxyethyl-cellulose, medium viscosity (75-125 mPa.s, 2% in water, 20°C), CAS # 54290 -to increase viscosity and to keep sugar in solution.
- Preservative: Preventol D-7 Bayer AG, D-51368 Leverkusen, CAS # 55965-84-9 -to prevent the spread of bacteria and molds
- DGBE: Diethylenglycol-monobuthyl ether (DGBE), Fluka Chemie GmbH, CAS # 112-34-5 -to reduce relative permittivity

7.2 Recipes

The following tables give the recipes for tissue simulating liquids to be used in different frequency bands.

Note: The goal dielectric parameters (at 22 °C) must be achieved within a tolerance of $\pm 5\%$ for ϵ and $\pm 5\%$ for σ .

Liquid type	HSL 1950-B	
	Weight (g)	Weight (%)
Water	554.12	55.41
DGBE	445.08	44.51
Salt	0.80	0.08
Total amount	1,000.00	100.00
Goal dielectric parameters		
Frequency [MHz]	1800-2000	
Relative Permittivity	40.0	
Conductivity [S/m]	1.40	

7.3 Liquid Depth

The liquid level was during measurement 15cm \pm 0.5cm.

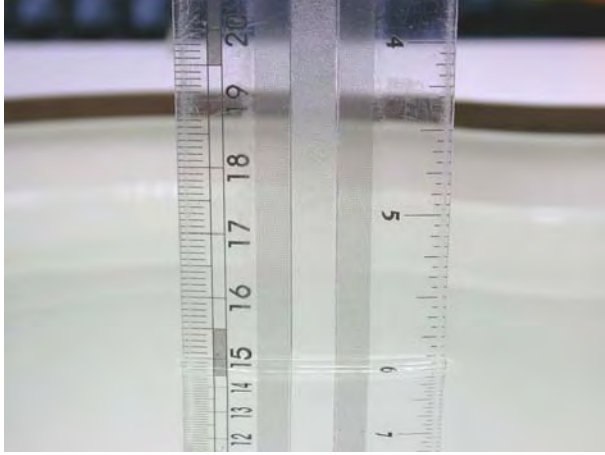

Figure 7. Head Position



8. Measurement Process

8.1 Device and Test Conditions

The Test Device was provided by **VTech Telecommunications Ltd.** for this evaluation. The spatial peak SAR values were assessed for the middle channels defined by UPCS (Ch2 = 1924.992MHz) systems. The antenna(s), battery and accessories shall be those specified by the manufacturer. The battery shall be fully charged before each measurement and there shall be no external connections.

Usage	Operates with normal mode by client
Distance between antenna axis at the joint and the liquid surface:	For head, EUT left head, right head, to phantom 0mm separation.
Simulating human Head/Body	Head
EUT Battery	Fully-charged with Ni-MH battery.

8.2 Conducted power

Frequency Band	Channel	Frequency (MHz)	Before SAR Test		After SAR Test		Duty Cycle	Tune-up Power (dBm)					
			Time-Avg.	Peak	Time-Avg.	Peak		Time-Avg.			Peak		
			(dBm)	(dBm)	(dBm)	(dBm)		Min	Nominal	Max	Min	Nominal	Max
DECT 1.9GHZ	Low - 4	1921.536	6.17	19.97	6.14	19.94	1/24	2.2	6.2	7.2	16	20	21
	Middle - 2	1924.992	5.97	19.77	5.92	19.72							
	High - 0	1928.448	5.77	19.57	5.72	19.52							

Note: 1. Time Average power(dBm)=Peak power(dBm)+Time Average factor.

Time Average factor= $10 \cdot \log(1/24) = -13.8\text{dB}$.

2. DECT has a TDD/TDMA frame structure with a complete frame of 10ms duration with 24 time slots. And under these 24 time slots, the first 12 slots are allocated for the transmission from base station to handsets, and the other 12 slots are for the transmission from handsets to base station. During a call, a handset is only using one of 24 time slots to transmit, which gives a duty cycle of 1/24 (= 4.17%).
3. To establish the maximum output power:
 - 3a. EUT is using fully charged battery.
 - 3b. The power saving function of EUT is disabled
 - 3c. Under normal mode, EUT establish a call in middle channel with base unit and telephone simulator.

8.3 SAR Testing with RF Transmitters

8.3.1 EUT Antenna Locations

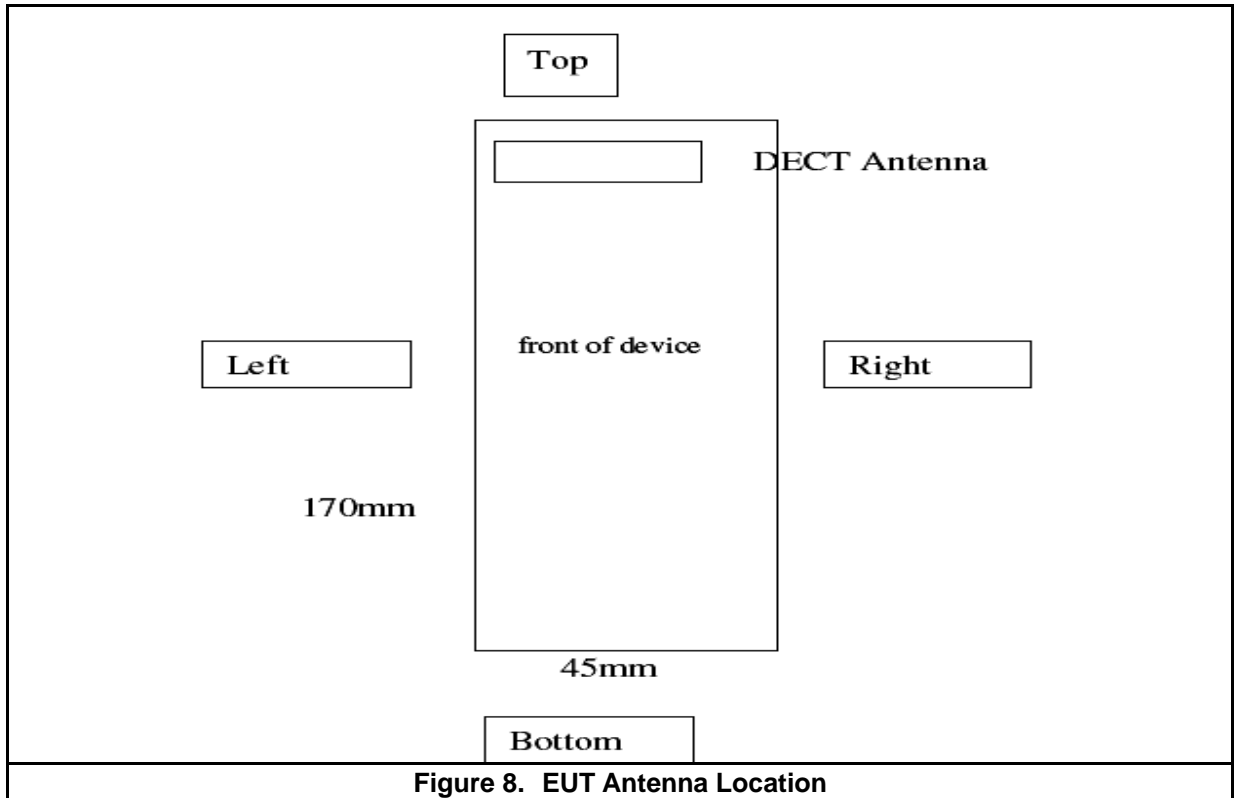

Figure 8. EUT Antenna Location

Note: specific antenna dimensions are shown in antenna dimension document.

8.3.2 SAR Test Device Setup

1. Install the battery into handset (EUT) and place in the telephone base or charger to continuously charge the battery over 16 hours to make sure the battery is fully charged.
2. Plug one end of power adapter into power jack of base unit and another end to a power supply. Also, plug the telephone line cord from the telephone line simulator into base unit.
3. Wait for a while for base unit powering up and automatic registration of handset with base unit.
4. To make sure the power is maximum output power, the power saving function of EUT is disabled.
5. Press "Talk" button of EUT to call other phone.
6. Use the spectrum to check if the transmission falls in middle channel. If not, repeat step 5 until transmission fixes in middle channel.
7. Then Execute SAR test.
8. During SAR test, spectrum is used to monitor if the transmission channel keeps in middle channel.
9. Once the channel changes, stop SAR test and repeat steps 5-8.

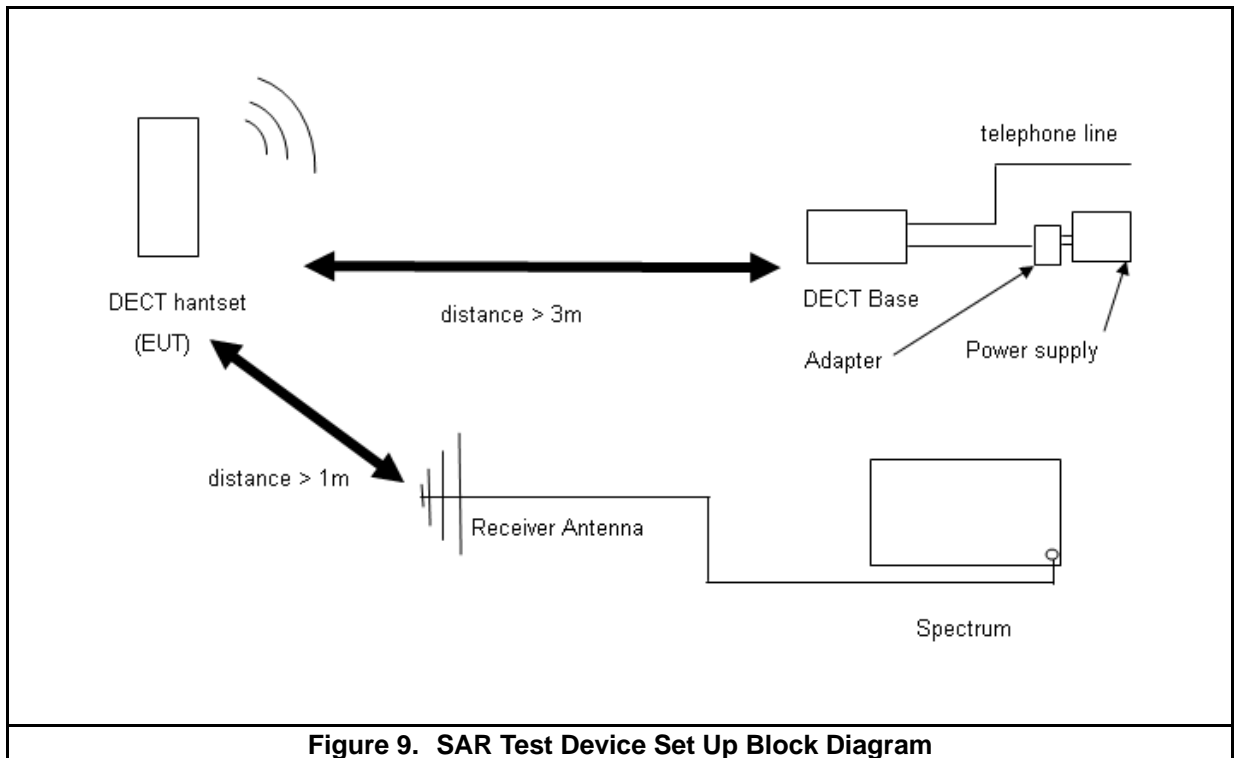

Figure 9. SAR Test Device Set Up Block Diagram

8.4 Verification and Validation

8.4.1 Symmetric Dipoles for System Verification

Construction	Symmetrical dipole with 1/4 balun enables measurement of feed point impedance with NWA matched for use near flat phantoms filled with head simulating solutions Includes distance holder and tripod adaptor Calibration Calibrated SAR value for specified position and input power at the flat phantom in head simulating solutions.
Frequency	1950 MHz
Return Loss	> 20 dB at specified verification position
Power Capability	> 100 W (f < 1GHz); > 40 W (f > 1GHz)
Options	Dipoles for other frequencies or solutions and other calibration conditions are available upon request
Dimensions	D1950V3 : dipole length 67.5 mm; overall height 300 mm

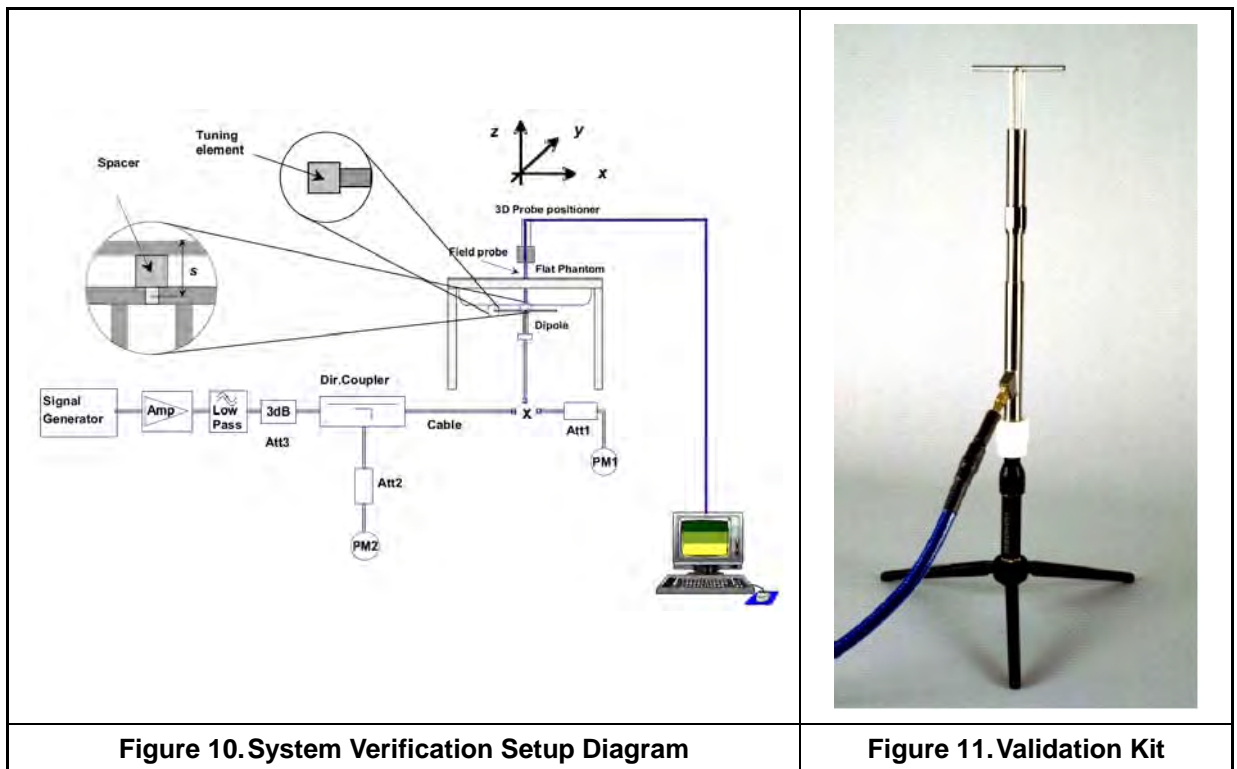

Figure 10. System Verification Setup Diagram

Figure 11. Validation Kit



8.4.2 Liquid Parameters

Liquid Verify								
Ambient Temperature : 22 ± 2 °C ; Relative Humidity : 40 -70%								
Liquid Type	Frequency	Temp (°C)	Parameters	Target Value	Measured Value	Deviation (%)	Limit (%)	Measured Date
1950MHz Head	1920MHz	22.0	ϵ_r	40.00	39.73	-0.68	± 5 %	Feb. 01, 2013
			σ	1.400	1.416	1.14	± 5 %	
	1950MHz	22.0	ϵ_r	40.00	39.64	-0.90	± 5 %	
			σ	1.400	1.444	3.14	± 5 %	
	1978MHz	22.0	ϵ_r	40.00	39.57	-1.08	± 5 %	
			σ	1.400	1.469	4.93	± 5 %	

Table 4. Measured Tissue dielectric parameters for head phantoms

8.4.3 Verification

Prior to the assessment, the system validation kit was used to test whether the system was operating within its specifications of ± 7%. The verification was performed as below.

Mixture Type	Freq. (MHz)	Power	SAR _{1g} (mW/g)	SAR _{10g} (mW/g)	Drift (dB)	Difference percentage		Probe Model / Serial No.	Dipole Model / Serial No.	1W Target		Date
						1g	10g			SAR _{1g} [mW/g]	SAR _{10g} [mW/g]	
Head	1950	250mW	10.40	5.26	-0.005	1.5%	-1.7%	EX3DV3 SN: 3519	D1950V3 SN: 1117	41.00	21.40	Feb. 01, 2013
		Normalize to 1 Watt	41.60	21.04								

Table 5. System Verification Results

Detail results see Appendix A.



8.4.4 Validation

Per FCC KDB 865664 D02v01, SAR system validation status should be documented to confirm measurement accuracy. The SAR systems (including SAR probes, system components and software versions) used for this device were validated against its performance specifications prior to the SAR measurements. Reference dipoles were used with the required tissue- equivalent media for system validation, according to the procedures outlined in IEEE 1528-2003 and FCC KDB 865664 D01v01. Since SAR probe calibrations are frequency dependent, each probe calibration point was validated at a frequency within the valid frequency range of the probe calibration point, using the system that normally operates with the probe for routine SAR measurements and according to the required tissue-equivalent media.

A tabulated summary of the system validation status including the validation date(s), measurement frequencies, SAR probes and tissue dielectric parameters has been included.

Freq. (MHz)	Probe SN.	Probe Type	Probe Cal. Point (MHz)	Head / Body	Cond. ϵ_r	Perm. σ	CW Validation			Mod. Validation			Date
							Sensitivity	Probe Linearity	Probe Isotropy	Mod. Type	Duty Factor	Par	
1950	3519	EX3DV3	1950	Head	39.64	1.444	Pass	Pass	Pass	TDMA	Pass	N/A	Feb. 01, 2013

Table 6. SAR System Validation Summary

8.5 Dosimetric Assessment Setup

8.5.1 Body - Worn Configuration

Evaluated Body-worn test is not required because the device can not use with headset and belt-clip.



8.5.2 Measurement Procedures

The evaluation was performed with the following procedures :

- Surface Check : A surface checks job gathers data used with optical surface detection. It determines the distance from the phantom surface where the reflection from the optical detector has its peak. Any following measurement jobs using optical surface detection will then rely on this value. The surface check performs its search a specified number of times, so that the repeatability can be verified. The probe tip distance is 1.3mm to phantom inner surface during scans.
- Reference : The reference job measures the field at a specified reference position, at 2 mm from the selected section's grid reference point.
- Area Scan : The area scan is used as a fast scan in two dimensions to find the area of high field values, before doing a finer measurement around the hot spot. The sophisticated interpolation routines can find the maximum locations even in relatively coarse grids. When an area scan has measured all reachable points, it computes the field maxima found in the scanned area, within a range of the global maximum. Any following zoom scan within the same procedure will then perform fine scans around these maxima. The area covered the entire dimension of the EUT and the horizontal grid spacing was 15 mm × 15 mm.
- Zoom Scan : Zoom scans are used to assess the highest averaged SAR for cubic averaging volumes with 1 g and 10 g of simulated tissue. The zoom scan measures several points in a cube(Please see 8.4 section) whose base faces are centered around the maxima returned from a preceding area scan within the same procedure.
- Drift : The drift job measures the field at the same location as the most recent reference job within the same procedure, with the same settings. The drift measurement gives the field difference in dB from the last reference measurement. Several drift measurements are possible for each reference measurement. This allows monitoring of the power drift of the device in the batch process. If the value changed by more than 5%, the evaluation was repeated.



8.6 Spatial Peak SAR Evaluation

The DASY5 software includes all numerical procedures necessary to evaluate the spatial peak SAR values. Based on the Draft: SCC-34, SC-2, WG-2 - Computational Dosimetry, IEEE P1529/D0.0 (Draft Recommended Practice for Determining the Spatial-Peak Specific Absorption Rate (SAR) Associated with the Use of Wireless Handsets - Computational Techniques), a new algorithm has been implemented. The spatial-peak SAR can be computed over any required mass.

The measured volume must include the 1g and 10g cubes with the highest averaged SAR values. For that purpose, the center of the measured volume is aligned to the interpolated peak SAR value of a previously performed area scan. If the 10g cube or both cubes are not entirely inside the measured volumes, the system issues a warning regarding the evaluated spatial peak values within the Postprocessing engine (SEMCAD). This means that if the measured volume is shifted, higher values might be possible. To get the correct values you can use a finer measurement grid for the area scan. In complicated field distributions, a large grid spacing for the area scan might miss some details and give an incorrectly interpolated peak location.

The base for the evaluation is a "cube" measurement in a volume of listing as below:

Grid Type	Frequency		Step size (mm)			X*Y*Z (Point)	Cube size			Step size		
			X	Y	Z		X	Y	Z	X	Y	Z
uniform grid	≤ 3GHz	≤ 2GHz	≤ 8	≤ 8	≤ 5	5*5*7	32	32	30	8	8	5
		2G - 3G	≤ 5	≤ 5	≤ 5	7*7*7	30	30	30	5	5	5
	3 - 6GHz	3 - 4GHz	≤ 5	≤ 5	≤ 4	7*7*8	30	30	28	5	5	4
		4 - 5GHz	≤ 4	≤ 4	≤ 3	8*8*10	28	28	27	4	4	3
		5 - 6GHz	≤ 4	≤ 4	≤ 2	8*8*12	28	28	22	4	4	2

(Refer KDB Publication 865664 D01v01)

The entire evaluation of the spatial peak values is performed within the Postprocessing engine (SEMCAD). The system always gives the maximum values for the 1g and 10g cubes. The algorithm to find the cube with highest averaged SAR is divided into three stages:

Interpolation and Extrapolation

The probe is calibrated at the center of the dipole sensors which is located 1 to 2.7mm away from the probe tip. During measurements, the probe stops shortly above the phantom surface, depending on the probe and the surface detecting system. Both distances are included as parameters in the probe configuration file. The software always knows exactly how far away the measured point is from the surface. As the probe cannot directly measure at the surface, the values between the deepest measured point and the surface must be extrapolated.

In DASY5, the choice of the coordinate system defining the location of the measurement points has no influence on the uncertainty of the interpolation, Maxima Search and SAR extrapolation routines. The interpolation, Maxima Search and extrapolation routines are all based on the modified Quadratic Shepard's method [7].



9. **Measurement Uncertainty**

Measurement uncertainties in SAR measurements are difficult to quantify due to several variables including biological, physiological, and environmental. However, we estimate the measurement uncertainties in SAR to be less than $\pm 19.62\%$ [8] .

According to Std. C95.3 [9], the overall uncertainties are difficult to assess and will vary with the type of meter and usage situation. However, accuracy's of ± 1 to 3 dB can be expected in practice, with greater uncertainties in near-field situations and at higher frequencies (shorter wavelengths), or areas where large reflecting objects are present. Under optimum measurement conditions, SAR measurement uncertainties of at least ± 2 dB can be expected.

According to CENELEC [10] , typical worst-case uncertainty of field measurements is ± 5 dB. For well-defined modulation characteristics the uncertainty can be reduced to ± 3 dB.



Uncertainty Component	Uncertainty Value	Probability Distribution	Divisor	C_i (1g)	C_i (10g)	Standard Uncertainty $\pm 1\%$ (1-g)	Standard Uncertainty $\pm 1\%$ (10-g)	v_i or V_{eff}
Measurement System								
Probe Calibration (k=1)	$\pm 5.05\%$	Normal	1	1	1	$\pm 5.05\%$	$\pm 5.05\%$	∞
Probe Isotropy	$\pm 7.6\%$	Rectangular	$\sqrt{3}$	0.7	0.7	$\pm 3.1\%$	$\pm 3.1\%$	∞
Boundary Effect	$\pm 1.0\%$	Rectangular	$\sqrt{3}$	1	1	$\pm 0.6\%$	$\pm 0.6\%$	∞
Linearity	$\pm 4.7\%$	Rectangular	$\sqrt{3}$	1	1	$\pm 2.7\%$	$\pm 2.7\%$	∞
System Detection Limit	$\pm 1.0\%$	Rectangular	$\sqrt{3}$	1	1	$\pm 0.58\%$	$\pm 0.58\%$	∞
Readout Electronics	$\pm 0.3\%$	Normal	1	1	1	$\pm 0.3\%$	$\pm 0.3\%$	∞
Response Time	$\pm 0.8\%$	Rectangular	$\sqrt{3}$	1	1	$\pm 0.5\%$	$\pm 0.5\%$	∞
Integration Time	$\pm 2.6\%$	Rectangular	$\sqrt{3}$	1	1	$\pm 1.5\%$	$\pm 1.5\%$	∞
RF Ambient Conditions	$\pm 0\%$	Rectangular	$\sqrt{3}$	1	1	$\pm 0\%$	$\pm 0\%$	∞
RF Ambient Reflections	$\pm 0\%$	Rectangular	$\sqrt{3}$	1	1	$\pm 0\%$	$\pm 0\%$	∞
Probe Positioner Mechanical Tolerance	$\pm 0.4\%$	Rectangular	$\sqrt{3}$	1	1	$\pm 0.2\%$	$\pm 0.2\%$	∞
Probe Positioning with respect to Phantom Shell	$\pm 2.9\%$	Rectangular	$\sqrt{3}$	1	1	$\pm 1.7\%$	$\pm 1.7\%$	∞
Extrapolation, interpolation and integration Algorithms for Max. SAR	$\pm 1.0\%$	Rectangular	$\sqrt{3}$	1	1	$\pm 0.6\%$	$\pm 0.6\%$	∞
Test sample Related								
Test sample Positioning	$\pm 3.6\%$	Normal	1	1	1	$\pm 3.6\%$	$\pm 3.6\%$	89
Device Holder Uncertainty	$\pm 3.5\%$	Normal	1	1	1	$\pm 3.5\%$	$\pm 3.5\%$	5
Output Power Variation - SAR drift measurement	$\pm 5.0\%$	Rectangular	$\sqrt{3}$	1	1	$\pm 2.9\%$	$\pm 2.9\%$	∞
Phantom and Tissue Parameters								
Phantom Uncertainty (shape and thickness tolerances)	$\pm 4.0\%$	Rectangular	$\sqrt{3}$	1	1	$\pm 2.3\%$	$\pm 2.3\%$	∞
Liquid Conductivity - deviation from target values	$\pm 5.0\%$	Rectangular	$\sqrt{3}$	0.64	0.43	$\pm 1.8\%$	$\pm 1.2\%$	∞
Liquid Conductivity - measurement uncertainty	$\pm 1.93\%$	Normal	1	0.64	0.43	$\pm 1.24\%$	$\pm 0.83\%$	69
Liquid Permittivity - deviation from target values	± 5.0	Rectangular	$\sqrt{3}$	0.6	0.49	$\pm 1.7\%$	$\pm 1.4\%$	∞
Liquid Permittivity - measurement uncertainty	$\pm 1.4\%$	Normal	1	0.6	0.49	$\pm 0.84\%$	$\pm 0.69\%$	69
Combined standard uncertainty		RSS				$\pm 9.81\%$	$\pm 9.62\%$	313
Expanded uncertainty (95% CONFIDENCE LEVEL)		k=2				$\pm 19.62\%$	$\pm 19.24\%$	

Table 7. System uncertainty: 300MHz -3000MHz



Uncertainty Component	Uncertainty Value	Probability Distribution	Divisor	c_i (1g)	c_i (10g)	Standard Uncertainty $\pm 1\%$ (1-g)	Standard Uncertainty $\pm 1\%$ (10-g)	v_i or V_{eff}
Measurement System								
Probe Calibration	$\pm 6.55\%$	Normal	1	1	1	$\pm 6.55\%$	$\pm 6.55\%$	∞
Axial Isotropy	$\pm 4.7\%$	Rectangular	$\sqrt{3}$	1	1	$\pm 2.7\%$	$\pm 2.7\%$	∞
Hemispherical Isotropy	$\pm 9.6\%$	Rectangular	$\sqrt{3}$	0	0	$\pm 0\%$	$\pm 0\%$	∞
Boundary Effects	$\pm 1.0\%$	Rectangular	$\sqrt{3}$	1	1	$\pm 0.6\%$	$\pm 0.6\%$	∞
Linearity	$\pm 4.7\%$	Rectangular	$\sqrt{3}$	1	1	$\pm 2.7\%$	$\pm 2.7\%$	∞
System Detection Limits	$\pm 1.0\%$	Rectangular	$\sqrt{3}$	1	1	$\pm 0.6\%$	$\pm 0.6\%$	∞
Modulation Response	$\pm 0\%$	Rectangular	$\sqrt{3}$	1	1	$\pm 0\%$	$\pm 0\%$	∞
Readout Electronics	$\pm 0.3\%$	Normal	1	1	1	$\pm 0.3\%$	$\pm 0.3\%$	∞
Response Time	$\pm 0\%$	Rectangular	$\sqrt{3}$	1	1	$\pm 0\%$	$\pm 0\%$	∞
Integration Time	$\pm 0\%$	Rectangular	$\sqrt{3}$	1	1	$\pm 0\%$	$\pm 0\%$	∞
RF Ambient Noise	$\pm 1.0\%$	Rectangular	$\sqrt{3}$	1	1	$\pm 0.6\%$	$\pm 0.6\%$	∞
RF Ambient Reflections	$\pm 1.0\%$	Rectangular	$\sqrt{3}$	1	1	$\pm 0.6\%$	$\pm 0.6\%$	∞
Probe Positioner	$\pm 0.8\%$	Rectangular	$\sqrt{3}$	1	1	$\pm 0.5\%$	$\pm 0.5\%$	∞
Probe Positioning	$\pm 6.7\%$	Rectangular	$\sqrt{3}$	1	1	$\pm 3.9\%$	$\pm 3.9\%$	∞
Max. SAR Eval.	$\pm 2.0\%$	Rectangular	$\sqrt{3}$	1	1	$\pm 1.2\%$	$\pm 1.2\%$	∞
Dipole Related								
Deviation of exp. dipole	$\pm 5.5\%$	Rectangular	$\sqrt{3}$	1	1	$\pm 3.2\%$	$\pm 3.2\%$	∞
Dipole Axis to Liquid Dist.	$\pm 2.0\%$	Rectangular	$\sqrt{3}$	1	1	$\pm 1.2\%$	$\pm 1.2\%$	∞
Input power & SAR drift	$\pm 3.4\%$	Rectangular	$\sqrt{3}$	1	1	$\pm 2.0\%$	$\pm 2.0\%$	∞
Phantom and Setup								
Phantom Uncertainty	$\pm 4.0\%$	Rectangular	$\sqrt{3}$	1	1	$\pm 2.3\%$	$\pm 2.3\%$	∞
SAR correction	$\pm 1.9\%$	Rectangular	$\sqrt{3}$	1	0.84	$\pm 1.1\%$	$\pm 0.9\%$	∞
Liquid Conductivity (meas.)	$\pm 2.5\%$	Normal	1	0.78	0.71	$\pm 2.0\%$	$\pm 1.8\%$	∞
Liquid Permittivity (meas.)	$\pm 2.5\%$	Normal	1	0.26	0.26	$\pm 0.7\%$	$\pm 0.7\%$	∞
Temp. unc. -Conductivity	$\pm 1.7\%$	Rectangular	$\sqrt{3}$	0.78	0.71	$\pm 0.8\%$	$\pm 0.7\%$	∞
Temp. unc. -Permittivity	$\pm 0.3\%$	Rectangular	$\sqrt{3}$	0.23	0.26	$\pm 0.0\%$	$\pm 0.0\%$	∞
Combined standard uncertainty		RSS				$\pm 10.1\%$	$\pm 10.1\%$	
Expanded uncertainty		k=2				$\pm 20.2\%$	$\pm 20.1\%$	

Table 8. Uncertainty Budget for System Validation for the 0.3 -6 GHz range



10. SAR Test Results Summary

10.1 Head SAR

Measurement Results										
Band	Frequency		Battery	Phantom Position	SAR _{1g} (mW/g)	Power Drift (dB)	Time-Avg Power (dBm)	Time-Avg Tune-Up Power (dBm)	Reported SAR (mW/g)	Amb Temp (°C)
	CH	MHz								
UPCS	2	1924.992	Ni-MH	Right-Cheek	0.042	0.01400	5.97	7.20	0.060	22.0
	2	1924.992	Ni-MH	Right-Tilted	0.030	0.08700	5.97	7.20	0.040	22.0
	2	1924.992	Ni-MH	Left-Cheek	0.044	0.00238	5.97	7.20	0.060	22.0
	2	1924.992	Ni-MH	Left-Tilted	0.031	0.05100	5.97	7.20	0.040	22.0
Std. C95.1-1992 - Safety Limit Spatial Peak Uncontrolled Exposure/General Population						1.6 W/kg (mW/g) Averaged over 1 gram				

Detail results see Appendix B.

Note 1. This device support voice transmission only

2. The KDB 865664 D01V01 2.8.1 (1) Repeated measurement is not required when the original highest measured SAR is < 0.80 W/kg
3. Supplement C 01-01 and IEEE Std 1528-2003 require the middle channel to be tested first. When the maximum output power variation across the required test channels is > ½ dB, instead of the middle channel, the highest output power channel must be used. (The KDB 447498 D01V05 4.3.3 Note 22)
4. There is no power reduction used for any band/mode implemented in this device for SAR purposes.
5. Testing of other required channels within the operating mode of a frequency band is not required when the reported 1-g or 10-g SAR for the mid-band or highest output power channel is ≤ 0.8 W/kg or 2.0 W/kg, for 1-g or 10-g respectively, when the transmission band is ≤ 100 MHz, justification according to KDB 447498 D01V05 4.3.3.
6. Reported SAR : Original SAR value should be scaled when actual power less than max tune up power .
Factor of scaling SAR (reported SAR) is $10^{[(\text{max tune up time-average power in dBm} - \text{actual power time-average in dBm}) / 10]}$



10.2 Std. C95.1-1992 RF Exposure Limit

Human Exposure	Population Uncontrolled Exposure (W/kg) or (mW/g)	Occupational Controlled Exposure (W/kg) or (mW/g)
Spatial Peak SAR* (head)	1.60	8.00
Spatial Peak SAR** (Whole Body)	0.08	0.40
Spatial Peak SAR*** (Partial-Body)	1.60	8.00
Spatial Peak SAR**** (Hands / Feet / Ankle / Wrist)	4.00	20.00

Table 9. Safety Limits for Partial Body Exposure

Notes :

- * The Spatial Peak value of the SAR averaged over any 1 gram of tissue. (defined as a tissue volume in the shape of a cube) and over the appropriate averaging time.
- ** The Spatial Average value of the SAR averaged over the whole – body.
- *** The Spatial Average value of the SAR averaged over the partial – body.
- **** The Spatial Peak value of the SAR averaged over any 10 grams of tissue. (defined as a tissue volume in the shape of a cube) and over the appropriate averaging time.

Population / Uncontrolled Environments : are defined as locations where there is the exposure of individuals who have no knowledge or control of their exposure.

Occupational / Controlled Environments : are defined as locations where there is exposure that may be incurred by persons who are aware of the potential for exposure, (i.e. as a result of employment or occupation).



11. Conclusion

The SAR test values found for the portable mobile phone **VTech Telecommunications Ltd. Trade Name : at&t Model(s) : CLP99283** is below the maximum recommended level of 1.6 W/kg (mW/g).

12. SAR Measurement Guidance

- KDB 865664 D01 SAR measurement 100 MHz to 6 GHz v01
- KDB 447498 D01 General RF Exposure Guidance v05
- KDB 648474 D04 SAR Handsets Multi Xmitter and Ant v01

13. References

- [1] Std. C95.1-1992, "American National Standard safety levels with respect to human exposure to radio frequency electromagnetic fields, 300KHz to 100GHz", New York.
- [2] NCRP, National Council on Radiation Protection and Measurements, "Biological Effects and Exposure Criteria for Radio frequency Electromagnetic Fields", NCRP report NO. 86, 1986.
- [3] T. Schmid, O. Egger, and N. Kuster, "Automatic E-field scanning system for dosimetric assessments", IEEE Transactions on Microwave Theory and Techniques, vol. 44, pp, 105-113, Jan. 1996.
- [4] K. Poković, T. Schmid, and N. Kuster, "Robust setup for precise calibration of E-field probes in tissue simulating liquids at mobile communications frequency", in ICECOM'97, Dubrovnik, October 15-17, 1997, pp.120-124.
- [5] K. Poković, T. Schmid, and N. Kuster, "E-field probe with improved isotropy in brain simulating liquids", in Proceedings of the ELMAR, Zadar, Croatia, 23-25 June, 1996, pp.172-175.
- [6] N. Kuster, and Q. Balzano, "Energy absorption mechanism by biological bodies in the near field of dipole antennas above 300MHz", IEEE Transaction on Vehicular Technology, vol. 41, no. 1, Feb. 1992, pp. 17-23.
- [7] Robert J. Renka, "Multivariate Interpolation Of Large Sets Of Scattered Data", University of North Texas ACM Transactions on Mathematical Software, vol. 14, no. 2, June 1988 , pp. 139-148.
- [8] N. Kuster, R. Kastle, T. Schmid, *Dosimetric evaluation of mobile communications equipment with known precision*, IEEE Transaction on Communications, vol. E80-B, no. 5, May 1997, pp. 645-652.
- [9] Std. C95.3-1991, "IEEE Recommended Practice for the Measurement of Potentially Hazardous Electromagnetic Fields – RF and Microwave, New York: IEEE, Aug. 1992.
- [10] CENELEC CLC/SC111B, European Prestandard (prENV 50166-2), *Human Exposure to Electromagnetic Fields High-frequency: 10KHz-300GHz*, Jan. 1995.
- [11] IEEE Std 1528™-2003 - IEEE Recommended Practice for Determining the Peak Spatial-Average Specific Absorption Rate (SAR) in the Human Head From Wireless Communications Devices: Measurement Techniques
- [12] IEEE Std 1528a™-2005 (Amendment to IEEE Std 1528™-2003), IEEE Recommended Practice for Determining the Peak Spatial-Average Specific Absorption Rate (SAR) in the Human Head from Wireless Communications Devices: Measurement Techniques



Appendix A - System Performance Check

Test Laboratory: A Test Lab Techno Corp.

Date/Time: 2/1/2013 12:22:25 PM

System Performance Check at 1950MHz_20130201_Head

DUT: Dipole 1950 MHz; Type: D1950V3; Serial: D1950V3 - SN:1117

Communication System: CW; Frequency: 1950 MHz; Duty Cycle: 1:1

Medium parameters used: $f = 1950$ MHz; $\sigma = 1.444$ mho/m; $\epsilon_r = 39.64$; $\rho = 1000$ kg/m³

Phantom section: Flat Section

Measurement Standard: DASYS (IEEE/IEC)

DASY5 Configuration:

- Area Scan setting - Find Secondary Maximum Within: 2.0dB and with a peak SAR value greater than 0.5 W/Kg
- Probe: EX3DV3 - SN3519; ConvF(8.93, 8.93, 8.93); Calibrated: 2/21/2012
- Sensor-Surface: 2mm (Mechanical Surface Detection)
- Electronics: DAE4 Sn541; Calibrated: 7/23/2012
- Phantom: SAM with CRP; Type: SAM; Serial: TP-1150 and higher
- Measurement SW: DASYS, V5.0 Build 125; SEMCAD X Version 13.4 Build 125

System Performance Check at 1950MHz/Area Scan (61x61x1):

Measurement grid: $dx=15$ mm, $dy=15$ mm

Maximum value of SAR (interpolated) = 15.4 mW/g

System Performance Check at 1950MHz/Zoom Scan (7x7x7)/Cube 0:

Measurement grid: $dx=5$ mm, $dy=5$ mm, $dz=5$ mm

Reference Value = 103.9 V/m; Power Drift = -0.00497 dB

Peak SAR (extrapolated) = 19.8 W/kg

SAR(1 g) = 10.40 mW/g; SAR(10 g) = 5.26 mW/g

Maximum value of SAR (measured) = 15.2 mW/g

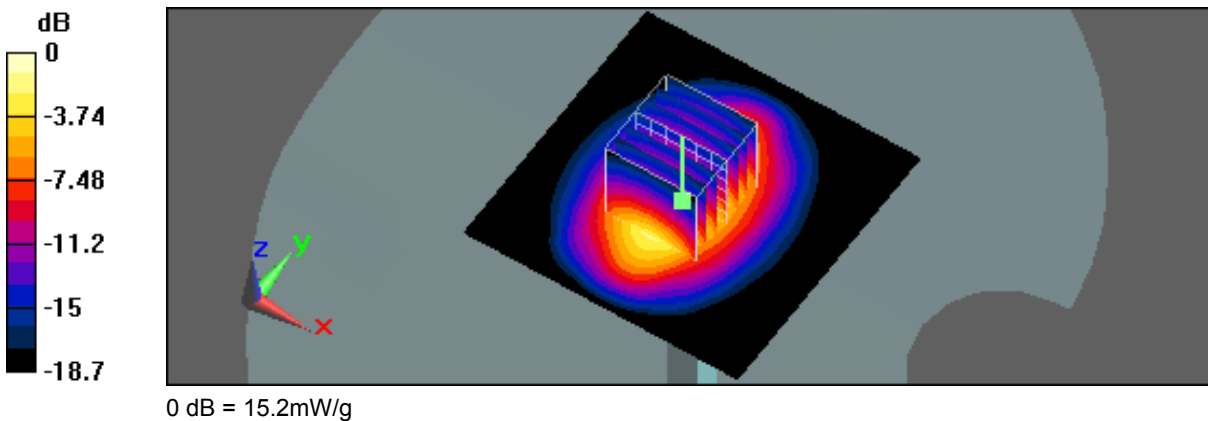



Appendix B - SAR Measurement Data

Test Laboratory: A Test Lab Techno Corp.

Date/Time: 2/1/2013 12:52:35 PM

#1_RC_DECT CH2

DUT: CLP99283; Type: 1.9GHz DECT 6.0 Cordless Phone; FCC ID: EW780-9103-00

Communication System: DECT; Frequency: 1924.992 MHz; Duty Cycle: 1:24

Medium parameters used: $f = 1924.992$ MHz; $\sigma = 1.42$ mho/m; $\epsilon_r = 39.7$; $\rho = 1000$ kg/m³

Phantom section: Right Section

Measurement Standard: DASYS (IEEE/IEC)

DASY5 Configuration:

- Area Scan setting - Find Secondary Maximum Within: 2.0dB and with a peak SAR value greater than 0.5 W/Kg
- Probe: EX3DV3 - SN3519; ConvF(8.93, 8.93, 8.93); Calibrated: 2/21/2012
- Sensor-Surface: 2mm (Mechanical Surface Detection)
- Electronics: DAE4 Sn541; Calibrated: 7/23/2012
- Phantom: SAM with CRP; Type: SAM; Serial: TP-1150 and higher
- Measurement SW: DASYS, V5.0 Build 125; SEMCAD X Version 13.4 Build 125

Right Cheek/Area Scan (61x141x1):

Measurement grid: dx=15mm, dy=15mm

Maximum value of SAR (interpolated) = 0.058 mW/g

Right Cheek/Zoom Scan (5x5x7)/Cube 0:

Measurement grid: dx=8mm, dy=8mm, dz=5mm

Reference Value = 5.52 V/m; Power Drift = 0.0140 dB

Peak SAR (extrapolated) = 0.068 W/kg

SAR(1 g) = 0.042 mW/g; SAR(10 g) = 0.025 mW/g

Maximum value of SAR (measured) = 0.055 mW/g

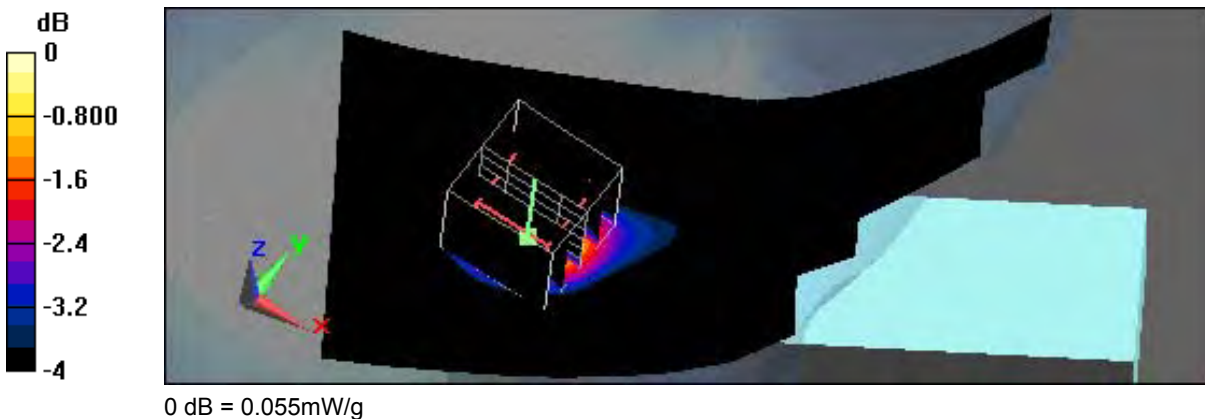



Test Laboratory: A Test Lab Techno Corp.

Date/Time: 2/1/2013 1:08:55 PM

#2_RT_DECT CH2

DUT: CLP99283; Type: 1.9GHz DECT 6.0 Cordless Phone; FCC ID: EW780-9103-00

Communication System: DECT; Frequency: 1924.992 MHz; Duty Cycle: 1:24

Medium parameters used: $f = 1924.992$ MHz; $\sigma = 1.42$ mho/m; $\epsilon_r = 39.7$; $\rho = 1000$ kg/m³

Phantom section: Right Section

Measurement Standard: DASYS (IEEE/IEC)

DASY5 Configuration:

- Area Scan setting - Find Secondary Maximum Within: 2.0dB and with a peak SAR value greater than 0.5 W/Kg
- Probe: EX3DV3 - SN3519; ConvF(8.93, 8.93, 8.93); Calibrated: 2/21/2012
- Sensor-Surface: 2mm (Mechanical Surface Detection)
- Electronics: DAE4 Sn541; Calibrated: 7/23/2012
- Phantom: SAM with CRP; Type: SAM; Serial: TP-1150 and higher
- Measurement SW: DASYS, V5.0 Build 125; SEMCAD X Version 13.4 Build 125

Right Tilted/Area Scan (61x141x1):

Measurement grid: dx=15mm, dy=15mm

Maximum value of SAR (interpolated) = 0.042 mW/g

Right Tilted/Zoom Scan (5x5x7)/Cube 0:

Measurement grid: dx=8mm, dy=8mm, dz=5mm

Reference Value = 5.12 V/m; Power Drift = 0.0870 dB

Peak SAR (extrapolated) = 0.048 W/kg

SAR(1 g) = 0.030 mW/g; SAR(10 g) = 0.018 mW/g

Maximum value of SAR (measured) = 0.039 mW/g

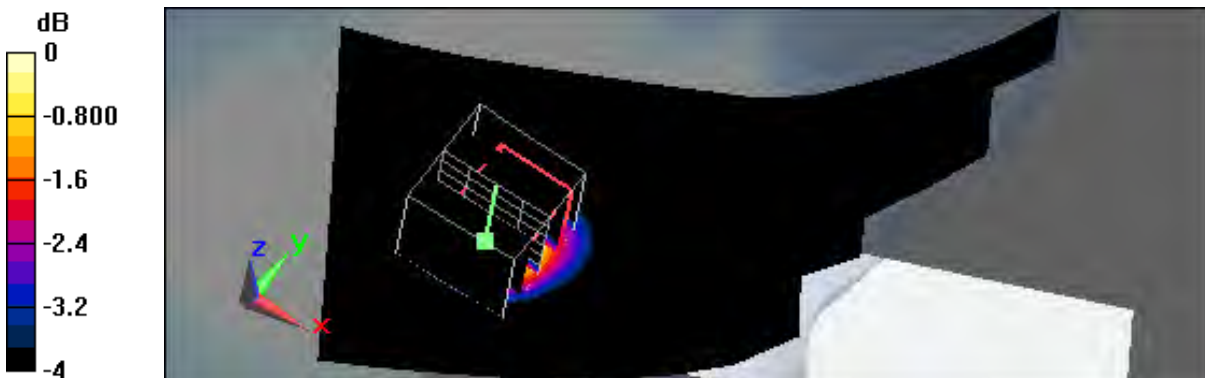

0 dB = 0.039mW/g



Test Laboratory: A Test Lab Techno Corp.

Date/Time: 2/1/2013 1:30:00 PM

#3_LC_DECT CH2

DUT: CLP99283; Type: 1.9GHz DECT 6.0 Cordless Phone; FCC ID: EW780-9103-00

Communication System: DECT; Frequency: 1924.992 MHz; Duty Cycle: 1:24

Medium parameters used: $f = 1924.992$ MHz; $\sigma = 1.42$ mho/m; $\epsilon_r = 39.7$; $\rho = 1000$ kg/m³

Phantom section: Left Section

Measurement Standard: DASYS (IEEE/IEC)

DASY5 Configuration:

- Area Scan setting - Find Secondary Maximum Within: 2.0dB and with a peak SAR value greater than 0.5 W/Kg
- Probe: EX3DV3 - SN3519; ConvF(8.93, 8.93, 8.93); Calibrated: 2/21/2012
- Sensor-Surface: 2mm (Mechanical Surface Detection)
- Electronics: DAE4 Sn541; Calibrated: 7/23/2012
- Phantom: SAM with CRP; Type: SAM; Serial: TP-1150 and higher
- Measurement SW: DASYS, V5.0 Build 125; SEMCAD X Version 13.4 Build 125

Left Cheek/Area Scan (61x141x1):

Measurement grid: dx=15mm, dy=15mm

Maximum value of SAR (interpolated) = 0.062 mW/g

Left Cheek/Zoom Scan (5x5x7)/Cube 0:

Measurement grid: dx=8mm, dy=8mm, dz=5mm

Reference Value = 5.74 V/m; Power Drift = 0.00238 dB

Peak SAR (extrapolated) = 0.071 W/kg

SAR(1 g) = 0.044 mW/g; SAR(10 g) = 0.025 mW/g

Maximum value of SAR (measured) = 0.058 mW/g

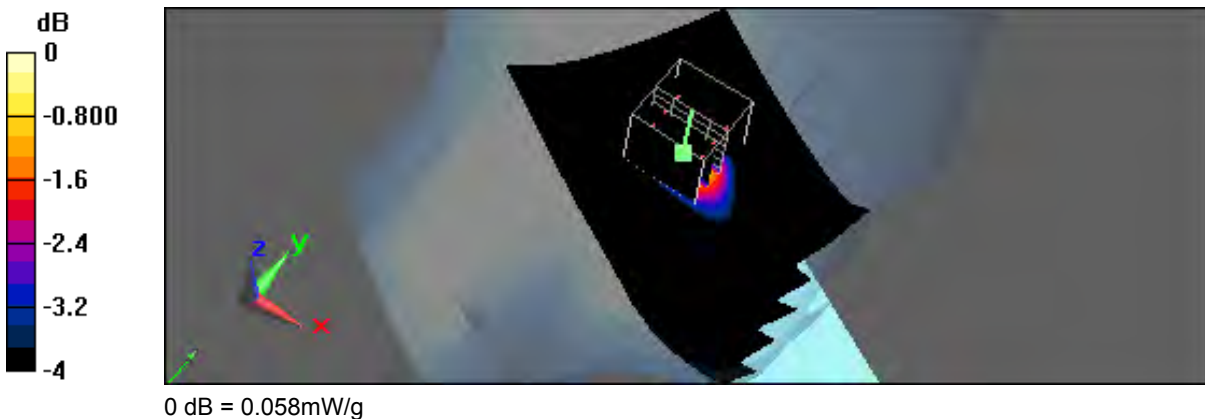



Test Laboratory: A Test Lab Techno Corp.

Date/Time: 2/1/2013 1:46:06 PM

#4_LT_DECT CH2

DUT: CLP99283; Type: 1.9GHz DECT 6.0 Cordless Phone; FCC ID: EW780-9103-00

Communication System: DECT; Frequency: 1924.992 MHz; Duty Cycle: 1:24

Medium parameters used: $f = 1924.992$ MHz; $\sigma = 1.42$ mho/m; $\epsilon_r = 39.7$; $\rho = 1000$ kg/m³

Phantom section: Left Section

Measurement Standard: DASYS (IEEE/IEC)

DASY5 Configuration:

- Area Scan setting - Find Secondary Maximum Within: 2.0dB and with a peak SAR value greater than 0.5 W/Kg
- Probe: EX3DV3 - SN3519; ConvF(8.93, 8.93, 8.93); Calibrated: 2/21/2012
- Sensor-Surface: 2mm (Mechanical Surface Detection)
- Electronics: DAE4 Sn541; Calibrated: 7/23/2012
- Phantom: SAM with CRP; Type: SAM; Serial: TP-1150 and higher
- Measurement SW: DASYS, V5.0 Build 125; SEMCAD X Version 13.4 Build 125

Left Tilted/Area Scan (61x141x1):

Measurement grid: dx=15mm, dy=15mm

Maximum value of SAR (interpolated) = 0.043 mW/g

Left Tilted/Zoom Scan (5x5x7)/Cube 0:

Measurement grid: dx=8mm, dy=8mm, dz=5mm

Reference Value = 5.2 V/m; Power Drift = 0.0510 dB

Peak SAR (extrapolated) = 0.050 W/kg

SAR(1 g) = 0.031 mW/g; SAR(10 g) = 0.018 mW/g

Maximum value of SAR (measured) = 0.040 mW/g

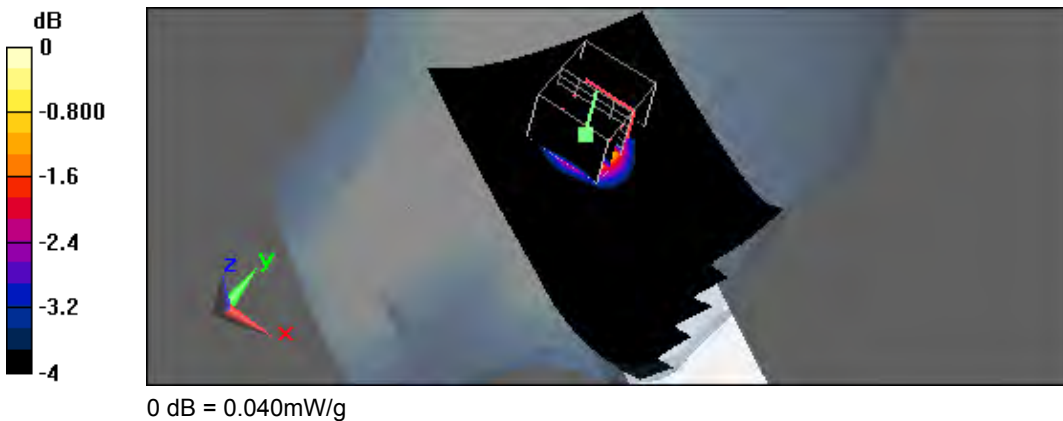



Appendix C - Calibration

All of the instruments Calibration information are listed below.

- Dipole _ D1950V3 SN:1117 Calibration No.D1950V3-1117_Feb12
- Probe _ EX3DV3 SN:3519 Calibration No.EX3-3519_ Feb12
- DAE _ DAE4 SN:541 Calibration No.DAE4-541_ Jul12

**Calibration Laboratory of
Schmid & Partner
Engineering AG**
Zeughausstrasse 43, 8004 Zurich, Switzerland



S Schweizerischer Kalibrierdienst
C Service suisse d'étalonnage
S Servizio svizzero di taratura
S Swiss Calibration Service

Accredited by the Swiss Accreditation Service (SAS)
The Swiss Accreditation Service is one of the signatories to the EA
Multilateral Agreement for the recognition of calibration certificates

Accreditation No.: **SCS 108**

Client **ATL (Auden)**

Certificate No: **D1950V3-1117_Feb12**

CALIBRATION CERTIFICATE

Object **D1950V3 - SN: 1117**

Calibration procedure(s) **QA CAL-05.v8
Calibration procedure for dipole validation kits above 700 MHz**

Calibration date: **February 23, 2012**

This calibration certificate documents the traceability to national standards, which realize the physical units of measurements (SI).
The measurements and the uncertainties with confidence probability are given on the following pages and are part of the certificate.

All calibrations have been conducted in the closed laboratory facility; environment temperature (22 ± 3)°C and humidity < 70%.

Calibration Equipment used (M&TE critical for calibration)

Primary Standards	ID #	Cal Date (Certificate No.)	Scheduled Calibration
Power meter EPM-442A	GB37480704	05-Oct-11 (No. 217-01451)	Oct-12
Power sensor HP 8481A	US37292783	05-Oct-11 (No. 217-01451)	Oct-12
Reference 20 dB Attenuator	SN: 5086 (20g)	29-Mar-11 (No. 217-01368)	Apr-12
Type-N mismatch combination	SN: 5047.2 / 06327	29-Mar-11 (No. 217-01371)	Apr-12
Reference Probe ES3DV3	SN: 3205	30-Dec-11 (No. ES3-3205_Dec11)	Dec-12
DAE4	SN: 601	04-Jul-11 (No. DAE4-601_Jul11)	Jul-12
Secondary Standards	ID #	Check Date (in house)	Scheduled Check
Power sensor HP 8481A	MY41092317	18-Oct-02 (in house check Oct-11)	In house check: Oct-13
RF generator R&S SMT-06	100005	04-Aug-99 (in house check Oct-11)	In house check: Oct-13
Network Analyzer HP 8753E	US37390585 S4206	18-Oct-01 (in house check Oct-11)	In house check: Oct-12

Calibrated by:	Name Israe El-Naouq	Function Laboratory Technician	Signature 
Approved by:	Name Katja Pokovic	Function Technical Manager	Signature 

Issued: February 23, 2012

This calibration certificate shall not be reproduced except in full without written approval of the laboratory.

**Calibration Laboratory of
Schmid & Partner
Engineering AG**
Zeughausstrasse 43, 8004 Zurich, Switzerland



S Schweizerischer Kalibrierdienst
C Service suisse d'étalonnage
S Servizio svizzero di taratura
S Swiss Calibration Service

Accredited by the Swiss Accreditation Service (SAS)

The Swiss Accreditation Service is one of the signatories to the EA
Multilateral Agreement for the recognition of calibration certificates

Accreditation No.: **SCS 108**

Glossary:

TSL	tissue simulating liquid
ConvF	sensitivity in TSL / NORM x,y,z
N/A	not applicable or not measured

Calibration is Performed According to the Following Standards:

- a) IEEE Std 1528-2003, "IEEE Recommended Practice for Determining the Peak Spatial-Averaged Specific Absorption Rate (SAR) in the Human Head from Wireless Communications Devices: Measurement Techniques", December 2003
- b) IEC 62209-1, "Procedure to measure the Specific Absorption Rate (SAR) for hand-held devices used in close proximity to the ear (frequency range of 300 MHz to 3 GHz)", February 2005
- c) Federal Communications Commission Office of Engineering & Technology (FCC OET), "Evaluating Compliance with FCC Guidelines for Human Exposure to Radiofrequency Electromagnetic Fields; Additional Information for Evaluating Compliance of Mobile and Portable Devices with FCC Limits for Human Exposure to Radiofrequency Emissions", Supplement C (Edition 01-01) to Bulletin 65

Additional Documentation:

- d) DASY4/5 System Handbook

Methods Applied and Interpretation of Parameters:

- *Measurement Conditions:* Further details are available from the Validation Report at the end of the certificate. All figures stated in the certificate are valid at the frequency indicated.
- *Antenna Parameters with TSL:* The dipole is mounted with the spacer to position its feed point exactly below the center marking of the flat phantom section, with the arms oriented parallel to the body axis.
- *Feed Point Impedance and Return Loss:* These parameters are measured with the dipole positioned under the liquid filled phantom. The impedance stated is transformed from the measurement at the SMA connector to the feed point. The Return Loss ensures low reflected power. No uncertainty required.
- *Electrical Delay:* One-way delay between the SMA connector and the antenna feed point. No uncertainty required.
- *SAR measured:* SAR measured at the stated antenna input power.
- *SAR normalized:* SAR as measured, normalized to an input power of 1 W at the antenna connector.
- *SAR for nominal TSL parameters:* The measured TSL parameters are used to calculate the nominal SAR result.

Measurement Conditions

DASY system configuration, as far as not given on page 1.

DASY Version	DASY5	V52.8.0
Extrapolation	Advanced Extrapolation	
Phantom	Modular Flat Phantom	
Distance Dipole Center - TSL	10 mm	with Spacer
Zoom Scan Resolution	dx, dy, dz = 5 mm	
Frequency	1950 MHz \pm 1 MHz	

Head TSL parameters

The following parameters and calculations were applied.

	Temperature	Permittivity	Conductivity
Nominal Head TSL parameters	22.0 °C	40.0	1.40 mho/m
Measured Head TSL parameters	(22.0 \pm 0.2) °C	40.8 \pm 6 %	1.35 mho/m \pm 6 %
Head TSL temperature change during test	< 0.5 °C	----	----

SAR result with Head TSL

SAR averaged over 1 cm ³ (1 g) of Head TSL	Condition	
SAR measured	250 mW input power	10.0 mW / g
SAR for nominal Head TSL parameters	normalized to 1W	41.0 mW / g \pm 17.0 % (k=2)

SAR averaged over 10 cm ³ (10 g) of Head TSL	condition	
SAR measured	250 mW input power	5.27 mW / g
SAR for nominal Head TSL parameters	normalized to 1W	21.4 mW / g \pm 16.5 % (k=2)

Body TSL parameters

The following parameters and calculations were applied.

	Temperature	Permittivity	Conductivity
Nominal Body TSL parameters	22.0 °C	53.3	1.52 mho/m
Measured Body TSL parameters	(22.0 \pm 0.2) °C	53.7 \pm 6 %	1.48 mho/m \pm 6 %
Body TSL temperature change during test	< 0.5 °C	----	----

SAR result with Body TSL

SAR averaged over 1 cm ³ (1 g) of Body TSL	Condition	
SAR measured	250 mW input power	9.62 mW / g
SAR for nominal Body TSL parameters	normalized to 1W	39.2 mW / g \pm 17.0 % (k=2)

SAR averaged over 10 cm ³ (10 g) of Body TSL	condition	
SAR measured	250 mW input power	5.10 mW / g
SAR for nominal Body TSL parameters	normalized to 1W	20.6 mW / g \pm 16.5 % (k=2)



Appendix

Antenna Parameters with Head TSL

Impedance, transformed to feed point	46.0 Ω - 0.8 j Ω
Return Loss	- 27.4 dB

Antenna Parameters with Body TSL

Impedance, transformed to feed point	46.6 Ω - 0.8 j Ω
Return Loss	- 28.8 dB

General Antenna Parameters and Design

Electrical Delay (one direction)	1.197 ns
----------------------------------	----------

After long term use with 100W radiated power, only a slight warming of the dipole near the feedpoint can be measured.

The dipole is made of standard semirigid coaxial cable. The center conductor of the feeding line is directly connected to the second arm of the dipole. The antenna is therefore short-circuited for DC-signals. On some of the dipoles, small end caps are added to the dipole arms in order to improve matching when loaded according to the position as explained in the "Measurement Conditions" paragraph. The SAR data are not affected by this change. The overall dipole length is still according to the Standard.

No excessive force must be applied to the dipole arms, because they might bend or the soldered connections near the feedpoint may be damaged.

Additional EUT Data

Manufactured by	SPEAG
Manufactured on	October 20, 2006

DASY5 Validation Report for Head TSL

Date: 23.02.2012

Test Laboratory: SPEAG, Zurich, Switzerland

DUT: Dipole 1950 MHz; Type: D1950V3; Serial: D1950V3 - SN: 1117

Communication System: CW; Frequency: 1950 MHz

Medium parameters used: $f = 1950$ MHz; $\sigma = 1.35$ mho/m; $\epsilon_r = 40.8$; $\rho = 1000$ kg/m³

Phantom section: Flat Section

Measurement Standard: DASY5 (IEEE/IEC/ANSI C63.19-2007)

DASY52 Configuration:

- Probe: ES3DV3 - SN3205; ConvF(4.86, 4.86, 4.86); Calibrated: 30.12.2011
- Sensor-Surface: 3mm (Mechanical Surface Detection)
- Electronics: DAE4 Sn601; Calibrated: 04.07.2011
- Phantom: Flat Phantom 5.0 (front); Type: QD000P50AA; Serial: 1001
- DASY52 52.8.0(692); SEMCAD X 14.6.4(4989)

Dipole Calibration for Head Tissue/Pin=250 mW, d=10mm/Zoom Scan (7x7x7)/Cube 0:

Measurement grid: dx=5mm, dy=5mm, dz=5mm

Reference Value = 99.546 V/m; Power Drift = 0.06 dB

Peak SAR (extrapolated) = 17.9980

SAR(1 g) = 10 mW/g; SAR(10 g) = 5.27 mW/g

Maximum value of SAR (measured) = 12.491 mW/g



0 dB = 12.490mW/g = 21.93 dB mW/g



Impedance Measurement Plot for Head TSL

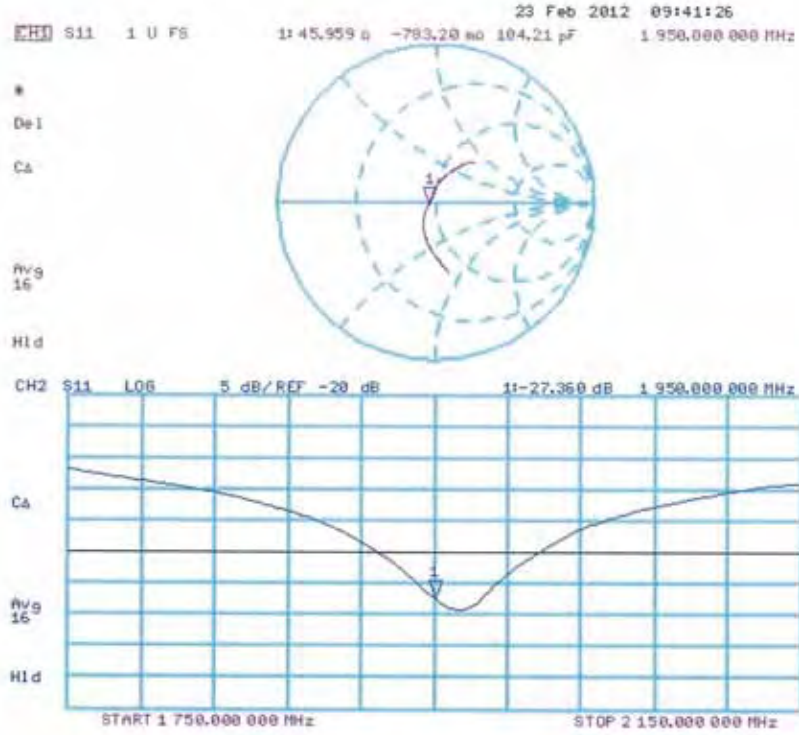

DASY5 Validation Report for Body TSL

Date: 23.02.2012

Test Laboratory: SPEAG, Zurich, Switzerland

DUT: Dipole 1950 MHz; Type: D1950V3; Serial: D1950V3 - SN: 1117

Communication System: CW; Frequency: 1950 MHz

Medium parameters used: $f = 1950$ MHz; $\sigma = 1.48$ mho/m; $\epsilon_r = 53.7$; $\rho = 1000$ kg/m³

Phantom section: Flat Section

Measurement Standard: DASY5 (IEEE/IEC/ANSI C63.19-2007)

DASY52 Configuration:

- Probe: ES3DV3 - SN3205; ConvF(4.73, 4.73, 4.73); Calibrated: 30.12.2011
- Sensor-Surface: 3mm (Mechanical Surface Detection)
- Electronics: DAE4 Sn601; Calibrated: 04.07.2011
- Phantom: Flat Phantom 5.0 (back); Type: QD000P50AA; Serial: 1002
- DASY52 52.8.0(692); SEMCAD X 14.6.4(4989)

Dipole Calibration for Body Tissue/Pin=250 mW, d=10mm/Zoom Scan (7x7x7)/Cube 0:

Measurement grid: dx=5mm, dy=5mm, dz=5mm

Reference Value = 94.502 V/m; Power Drift = -0.0015 dB

Peak SAR (extrapolated) = 16.6760

SAR(1 g) = 9.62 mW/g; SAR(10 g) = 5.1 mW/g

Maximum value of SAR (measured) = 12.159 mW/g

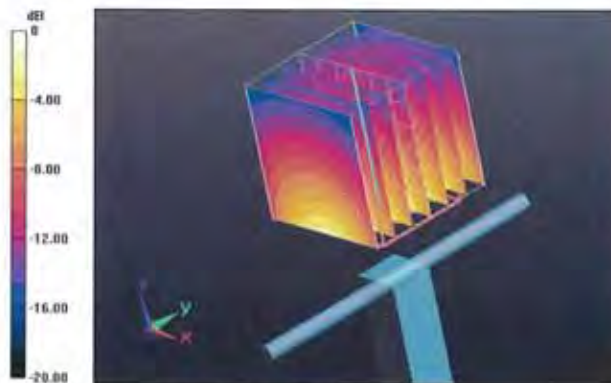

0 dB = 12.160mW/g = 21.70 dB mW/g



Impedance Measurement Plot for Body TSL

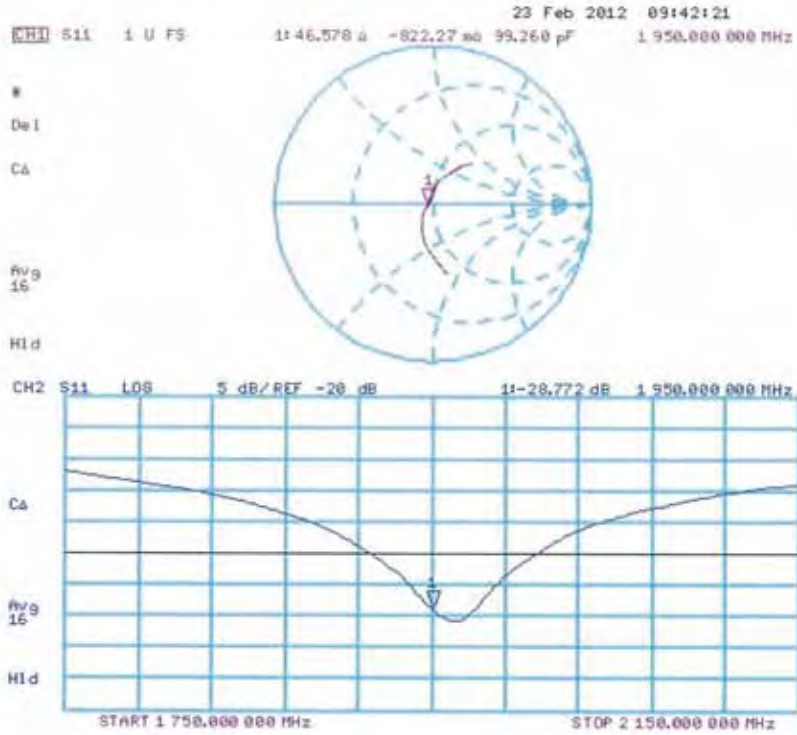



**Calibration Laboratory of
Schmid & Partner
Engineering AG**
Zeughausstrasse 43, 8004 Zurich, Switzerland



S Schweizerischer Kalibrierdienst
S Service suisse d'étalonnage
S Servizio svizzero di taratura
S Swiss Calibration Service

Accredited by the Swiss Accreditation Service (SAS)
The Swiss Accreditation Service is one of the signatories to the EA
Multilateral Agreement for the recognition of calibration certificates

Accreditation No.: **SCS 108**

Client **ATL (Auden)**

Certificate No: **EX3-3519_Feb12**

CALIBRATION CERTIFICATE

Object **EX3DV3 - SN:3519**

Calibration procedure(s) **QA CAL-01.v8, QA CAL-12.v7, QA CAL-14.v3, QA CAL-23.v4,
QA CAL-25.v4
Calibration procedure for dosimetric E-field probes**

Calibration date: **February 21, 2012**

This calibration certificate documents the traceability to national standards, which realize the physical units of measurements (SI).
The measurements and the uncertainties with confidence probability are given on the following pages and are part of the certificate.

All calibrations have been conducted in the closed laboratory facility: environment temperature (22 ± 3)°C and humidity < 70%.

Calibration Equipment used (M&TE critical for calibration)

Primary Standards	ID	Cal Date (Certificate No.)	Scheduled Calibration
Power meter E4419B	GB41293874	31-Mar-11 (No. 217-01372)	Apr-12
Power sensor E4412A	MY41498087	31-Mar-11 (No. 217-01372)	Apr-12
Reference 3 dB Attenuator	SN: S5054 (3c)	29-Mar-11 (No. 217-01369)	Apr-12
Reference 20 dB Attenuator	SN: S5086 (20b)	29-Mar-11 (No. 217-01367)	Apr-12
Reference 30 dB Attenuator	SN: S5129 (30b)	29-Mar-11 (No. 217-01370)	Apr-12
Reference Probe ES3DV2	SN: 3013	29-Dec-11 (No. ES3-3013_Dec11)	Dec-12
DAE4	SN: 654	3-May-11 (No. DAE4-654_May11)	May-12
Secondary Standards	ID	Check Date (in house)	Scheduled Check
RF generator HP 8648C	US3642U01700	4-Aug-99 (in house check Apr-11)	In house check: Apr-13
Network Analyzer HP 8753E	US37390585	18-Oct-01 (in house check Oct-11)	In house check: Oct-12

	Name	Function	Signature
Calibrated by:	Jeton Kastrati	Laboratory Technician	
Approved by:	Katja Pokovic	Technical Manager	
			Issued: February 21, 2012

This calibration certificate shall not be reproduced except in full without written approval of the laboratory.

**Calibration Laboratory of
Schmid & Partner
Engineering AG**
Zeughausstrasse 43, 8004 Zurich, Switzerland



S Schweizerischer Kalibrierdienst
S Service suisse d'étalonnage
S Servizio svizzero di taratura
S Swiss Calibration Service

Accredited by the Swiss Accreditation Service (SAS)
The Swiss Accreditation Service is one of the signatories to the EA
Multilateral Agreement for the recognition of calibration certificates

Accreditation No.: **SCS 108**

Glossary:

TSL	tissue simulating liquid
NORM _{x,y,z}	sensitivity in free space
ConvF	sensitivity in TSL / NORM _{x,y,z}
DCP	diode compression point
CF	crest factor (1/duty_cycle) of the RF signal
A, B, C	modulation dependent linearization parameters
Polarization φ	φ rotation around probe axis
Polarization ϑ	ϑ rotation around an axis that is in the plane normal to probe axis (at measurement center), i.e., $\vartheta = 0$ is normal to probe axis

Calibration is Performed According to the Following Standards:

- a) IEEE Std 1528-2003, "IEEE Recommended Practice for Determining the Peak Spatial-Averaged Specific Absorption Rate (SAR) in the Human Head from Wireless Communications Devices: Measurement Techniques", December 2003
- b) IEC 62209-1, "Procedure to measure the Specific Absorption Rate (SAR) for hand-held devices used in close proximity to the ear (frequency range of 300 MHz to 3 GHz)", February 2005

Methods Applied and Interpretation of Parameters:

- **NORM_{x,y,z}**: Assessed for E-field polarization $\vartheta = 0$ ($f \leq 900$ MHz in TEM-cell; $f > 1800$ MHz: R22 waveguide). NORM_{x,y,z} are only intermediate values, i.e., the uncertainties of NORM_{x,y,z} does not affect the E²-field uncertainty inside TSL (see below *ConvF*).
- **NORM(f)_{x,y,z} = NORM_{x,y,z} * frequency_response** (see Frequency Response Chart). This linearization is implemented in DASY4 software versions later than 4.2. The uncertainty of the frequency response is included in the stated uncertainty of *ConvF*.
- **DCP_{x,y,z}**: DCP are numerical linearization parameters assessed based on the data of power sweep with CW signal (no uncertainty required). DCP does not depend on frequency nor media.
- **PAR**: PAR is the Peak to Average Ratio that is not calibrated but determined based on the signal characteristics
- **A_{x,y,z}; B_{x,y,z}; C_{x,y,z}; VR_{x,y,z}**: A, B, C are numerical linearization parameters assessed based on the data of power sweep for specific modulation signal. The parameters do not depend on frequency nor media. VR is the maximum calibration range expressed in RMS voltage across the diode.
- **ConvF and Boundary Effect Parameters**: Assessed in flat phantom using E-field (or Temperature Transfer Standard for $f \leq 800$ MHz) and inside waveguide using analytical field distributions based on power measurements for $f > 800$ MHz. The same setups are used for assessment of the parameters applied for boundary compensation (alpha, depth) of which typical uncertainty values are given. These parameters are used in DASY4 software to improve probe accuracy close to the boundary. The sensitivity in TSL corresponds to NORM_{x,y,z} * ConvF whereby the uncertainty corresponds to that given for ConvF. A frequency dependent ConvF is used in DASY version 4.4 and higher which allows extending the validity from ± 50 MHz to ± 100 MHz.
- **Spherical isotropy (3D deviation from isotropy)**: in a field of low gradients realized using a flat phantom exposed by a patch antenna.
- **Sensor Offset**: The sensor offset corresponds to the offset of virtual measurement center from the probe tip (on probe axis). No tolerance required.



EX3DV3 – SN:3519

February 21, 2012

Probe EX3DV3

SN:3519

Manufactured: March 8, 2004
Calibrated: February 21, 2012

Calibrated for DASY/EASY Systems
(Note: non-compatible with DASY2 system!)



DASY/EASY - Parameters of Probe: EX3DV3 - SN:3519

Basic Calibration Parameters

	Sensor X	Sensor Y	Sensor Z	Unc (k=2)
Norm ($\mu\text{V}/(\text{V}/\text{m})^2$) ^A	0.81	0.70	0.72	± 10.1 %
DCP (mV) ^B	102.5	100.6	101.7	

Modulation Calibration Parameters

UID	Communication System Name	PAR		A dB	B dB	C dB	VR mV	Unc ^E (k=2)
10000	CW	0.00	X	0.00	0.00	1.00	120.7	±1.9 %
			Y	0.00	0.00	1.00	136.5	
			Z	0.00	0.00	1.00	108.9	

The reported uncertainty of measurement is stated as the standard uncertainty of measurement multiplied by the coverage factor k=2, which for a normal distribution corresponds to a coverage probability of approximately 95%.

^A The uncertainties of NormX,Y,Z do not affect the E²-field uncertainty inside TSL (see Pages 5 and 6).

^B Numerical linearization parameter: uncertainty not required.

^E Uncertainty is determined using the max. deviation from linear response applying rectangular distribution and is expressed for the square of the field value.



DASY/EASY - Parameters of Probe: EX3DV3 - SN:3519

Calibration Parameter Determined in Head Tissue Simulating Media

f (MHz) ^C	Relative Permittivity ^F	Conductivity (S/m) ^F	ConvF X	ConvF Y	ConvF Z	Alpha	Depth (mm)	Unct. (k=2)
450	43.5	0.87	10.74	10.74	10.74	0.10	1.00	± 13.4 %
750	41.9	0.89	10.59	10.59	10.59	0.22	1.15	± 12.0 %
835	41.5	0.90	10.13	10.13	10.13	0.21	1.25	± 12.0 %
900	41.5	0.97	9.99	9.99	9.99	0.31	0.93	± 12.0 %
1750	40.1	1.37	9.40	9.40	9.40	0.64	0.63	± 12.0 %
1810	40.0	1.40	9.17	9.17	9.17	0.52	0.76	± 12.0 %
1900	40.0	1.40	9.04	9.04	9.04	0.35	0.85	± 12.0 %
2000	40.0	1.40	8.93	8.93	8.93	0.46	0.76	± 12.0 %
2450	39.2	1.80	7.82	7.82	7.82	0.36	0.83	± 12.0 %
5200	36.0	4.66	5.06	5.06	5.06	0.35	1.80	± 13.1 %
5300	35.9	4.76	4.82	4.82	4.82	0.38	1.80	± 13.1 %
5500	35.6	4.96	4.67	4.67	4.67	0.40	1.80	± 13.1 %
5600	35.5	5.07	4.36	4.36	4.36	0.45	1.80	± 13.1 %
5800	35.3	5.27	4.31	4.31	4.31	0.42	1.80	± 13.1 %

^C Frequency validity of ± 100 MHz only applies for DASY v4.4 and higher (see Page 2), else it is restricted to ± 50 MHz. The uncertainty is the RSS of the ConvF uncertainty at calibration frequency and the uncertainty for the indicated frequency band.

^F At frequencies below 3 GHz, the validity of tissue parameters (ϵ and σ) can be relaxed to ± 10% if liquid compensation formula is applied to measured SAR values. At frequencies above 3 GHz, the validity of tissue parameters (ϵ and σ) is restricted to ± 5%. The uncertainty is the RSS of the ConvF uncertainty for indicated target tissue parameters.



DASY/EASY - Parameters of Probe: EX3DV3 - SN:3519

Calibration Parameter Determined in Body Tissue Simulating Media

f (MHz) ^C	Relative Permittivity ^F	Conductivity (S/m) ^F	ConvF X	ConvF Y	ConvF Z	Alpha	Depth (mm)	Unct. (k=2)
450	56.7	0.94	11.71	11.71	11.71	0.02	1.00	± 13.4 %
750	55.5	0.96	10.53	10.53	10.53	0.18	1.49	± 12.0 %
835	55.2	0.97	10.36	10.36	10.36	0.23	1.22	± 12.0 %
900	55.0	1.05	10.27	10.27	10.27	0.21	1.34	± 12.0 %
1750	53.4	1.49	9.70	9.70	9.70	0.41	0.92	± 12.0 %
1810	53.3	1.52	9.41	9.41	9.41	0.32	0.96	± 12.0 %
1900	53.3	1.52	9.04	9.04	9.04	0.37	0.91	± 12.0 %
2000	53.3	1.52	9.06	9.06	9.06	0.44	0.80	± 12.0 %
2300	52.9	1.81	8.56	8.56	8.56	0.39	0.84	± 12.0 %
2450	52.7	1.95	8.22	8.22	8.22	0.76	0.54	± 12.0 %
2600	52.5	2.16	7.82	7.82	7.82	0.80	0.50	± 12.0 %
3500	51.3	3.31	7.01	7.01	7.01	0.37	1.18	± 13.1 %
5200	49.0	5.30	4.38	4.38	4.38	0.50	1.90	± 13.1 %
5300	48.9	5.42	4.13	4.13	4.13	0.55	1.90	± 13.1 %
5500	48.6	5.65	3.92	3.92	3.92	0.55	1.90	± 13.1 %
5600	48.5	5.77	3.61	3.61	3.61	0.60	1.90	± 13.1 %
5800	48.2	6.00	3.88	3.88	3.88	0.60	1.90	± 13.1 %

^C Frequency validity of ± 100 MHz only applies for DASY v4.4 and higher (see Page 2), else it is restricted to ± 50 MHz. The uncertainty is the RSS of the ConvF uncertainty at calibration frequency and the uncertainty for the indicated frequency band.

^F At frequencies below 3 GHz, the validity of tissue parameters (ϵ and σ) can be relaxed to ± 10% if liquid compensation formula is applied to measured SAR values. At frequencies above 3 GHz, the validity of tissue parameters (ϵ and σ) is restricted to ± 5%. The uncertainty is the RSS of the ConvF uncertainty for indicated target tissue parameters.

Frequency Response of E-Field (TEM-Cell:ifi110 EXX, Waveguide: R22)

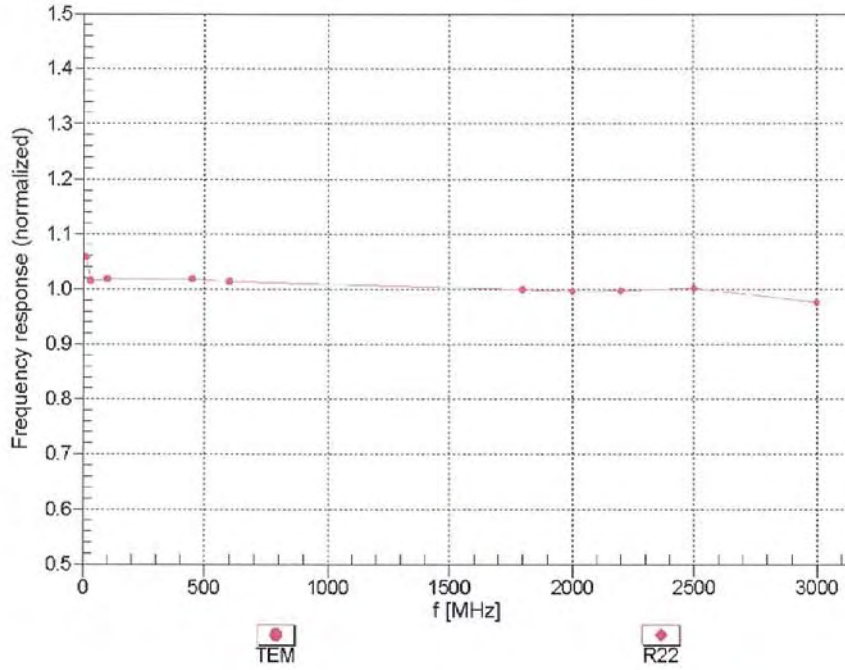

Uncertainty of Frequency Response of E-field: $\pm 6.3\%$ (k=2)

Receiving Pattern (ϕ), $\vartheta = 0^\circ$

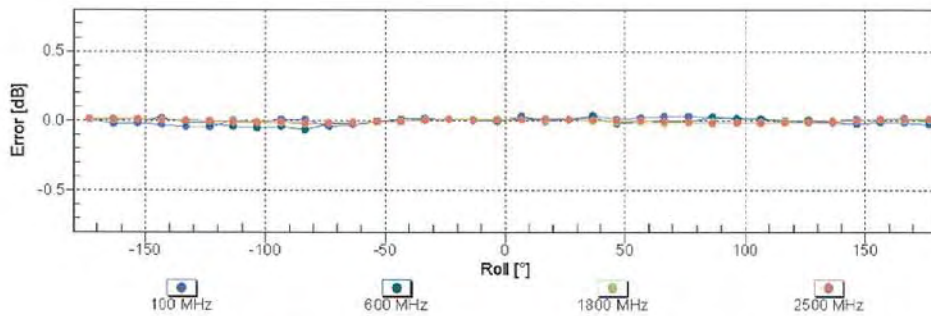
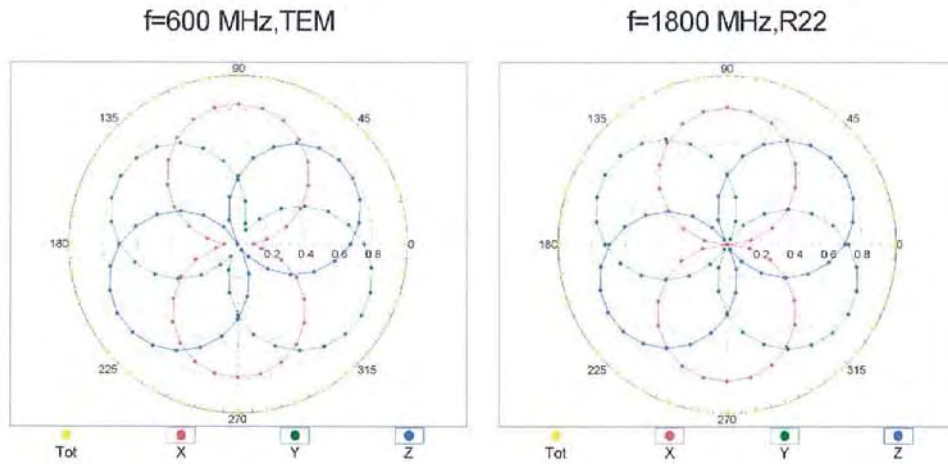

Uncertainty of Axial Isotropy Assessment: $\pm 0.5\%$ ($k=2$)

Dynamic Range $f(SAR_{head})$ (TEM cell , $f = 900$ MHz)

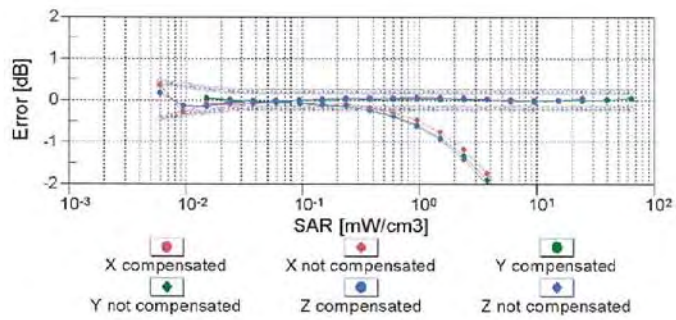
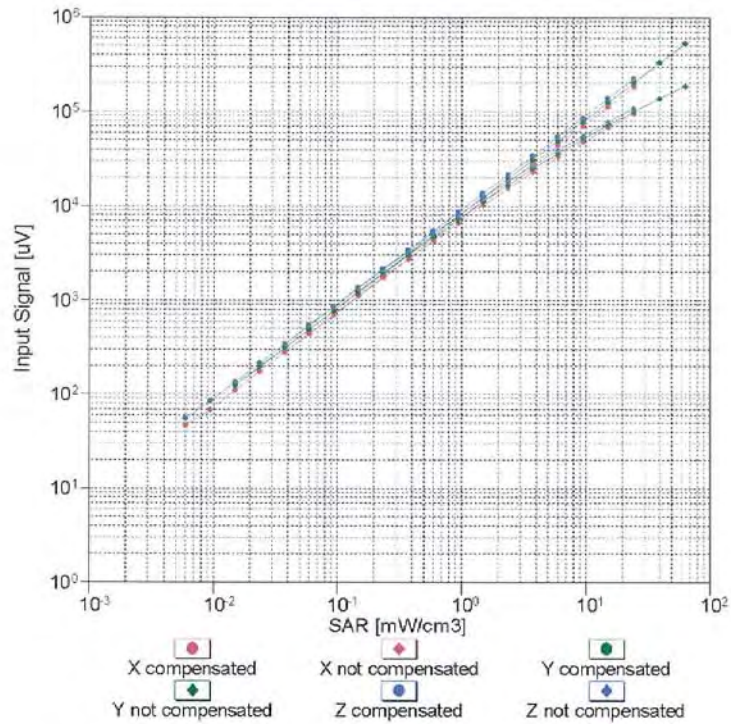

Uncertainty of Linearity Assessment: $\pm 0.6\%$ (k=2)

Conversion Factor Assessment

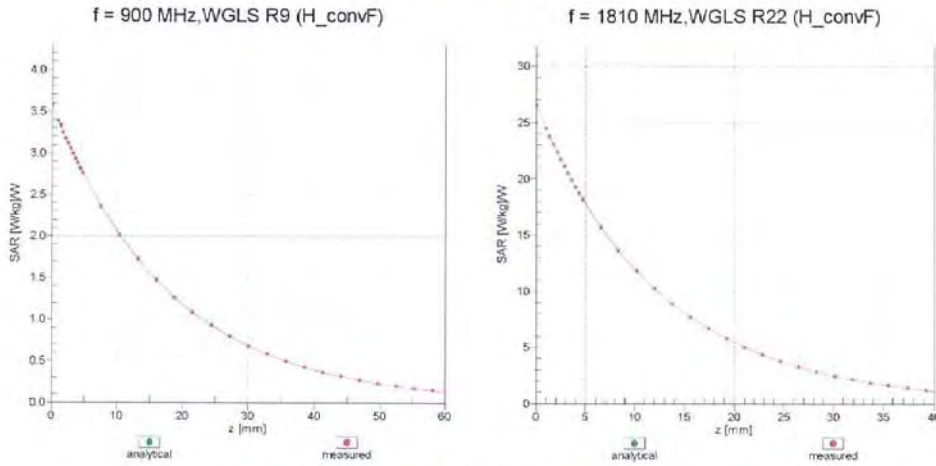

Deviation from Isotropy in Liquid Error (ϕ, θ), f = 900 MHz

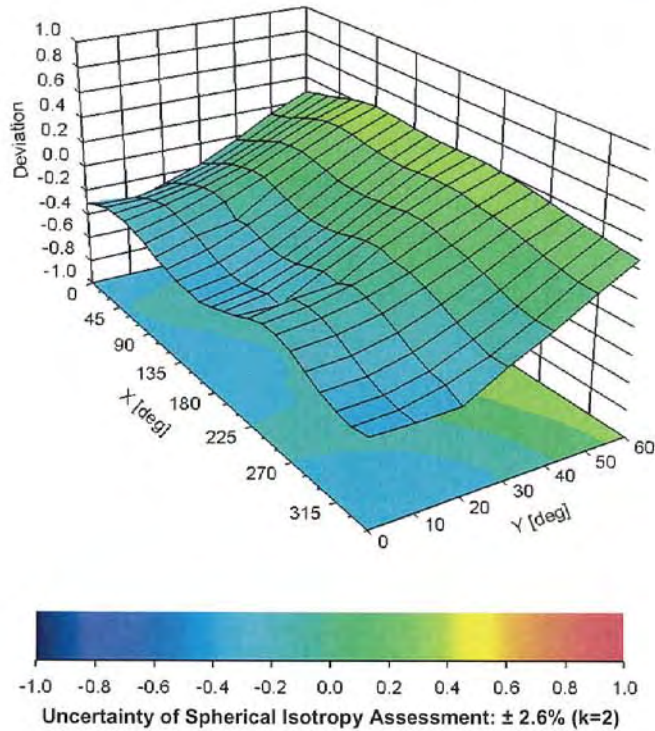



DASY/EASY - Parameters of Probe: EX3DV3 - SN:3519

Other Probe Parameters

Sensor Arrangement	Triangular
Connector Angle (°)	Not applicable
Mechanical Surface Detection Mode	enabled
Optical Surface Detection Mode	disabled
Probe Overall Length	337 mm
Probe Body Diameter	10 mm
Tip Length	9 mm
Tip Diameter	2.5 mm
Probe Tip to Sensor X Calibration Point	1 mm
Probe Tip to Sensor Y Calibration Point	1 mm
Probe Tip to Sensor Z Calibration Point	1 mm
Recommended Measurement Distance from Surface	2 mm

**Calibration Laboratory of
Schmid & Partner
Engineering AG**
Zeughausstrasse 43, 8004 Zurich, Switzerland



S Schweizerischer Kalibrierdienst
S Service suisse d'étalonnage
C Servizio svizzero di taratura
S Swiss Calibration Service

Accredited by the Swiss Accreditation Service (SAS)
The Swiss Accreditation Service is one of the signatories to the EA
Multilateral Agreement for the recognition of calibration certificates

Accreditation No.: **SCS 108**

Client **ATL (Auden)**

Certificate No: **DAE4-541_Jul12**

CALIBRATION CERTIFICATE

Object: **DAE4 - SD 000 D04 BJ - SN: 541**

Calibration procedure(s): **QA CAL-06.v24
Calibration procedure for the data acquisition electronics (DAE)**

Calibration date: **July 23, 2012**

This calibration certificate documents the traceability to national standards, which realize the physical units of measurements (SI).
The measurements and the uncertainties with confidence probability are given on the following pages and are part of the certificate.

All calibrations have been conducted in the closed laboratory facility; environment temperature (22 ± 3)°C and humidity < 70%.

Calibration Equipment used (M&TE critical for calibration)

Primary Standards	ID #	Cal Date (Certificate No.)	Scheduled Calibration
Keithley Multimeter Type 2001	SN: 0810278	28-Sep-11 (No:11450)	Sep-12
Secondary Standards	ID #	Check Date (in house)	Scheduled Check
Calibrator Box V2.1	SE UWS 053 AA 1001	05-Jan-12 (in house check)	in house check: Jan-13

	Name	Function	Signature
Calibrated by:	R. Mayoraz	Technician	
Approved by:	Fir Bornholt	R&D Director	

Issued: July 23, 2012

This calibration certificate shall not be reproduced except in full without written approval of the laboratory.

**Calibration Laboratory of
Schmid & Partner
Engineering AG**
Zeughausstrasse 43, 8004 Zurich, Switzerland



S Schweizerischer Kalibrierdienst
C Service suisse d'étalonnage
S Servizio svizzero di taratura
S Swiss Calibration Service

Accredited by the Swiss Accreditation Service (SAS)
The Swiss Accreditation Service is one of the signatories to the EA
Multilateral Agreement for the recognition of calibration certificates

Accreditation No.: **SCS 108**

Glossary

DAE data acquisition electronics
Connector angle information used in DASY system to align probe sensor X to the robot coordinate system.

Methods Applied and Interpretation of Parameters

- **DC Voltage Measurement:** Calibration Factor assessed for use in DASY system by comparison with a calibrated instrument traceable to national standards. The figure given corresponds to the full scale range of the voltmeter in the respective range.
- **Connector angle:** The angle of the connector is assessed measuring the angle mechanically by a tool inserted. Uncertainty is not required.
- The following parameters as documented in the Appendix contain technical information as a result from the performance test and require no uncertainty.
 - **DC Voltage Measurement Linearity:** Verification of the Linearity at +10% and -10% of the nominal calibration voltage. Influence of offset voltage is included in this measurement.
 - **Common mode sensitivity:** Influence of a positive or negative common mode voltage on the differential measurement.
 - **Channel separation:** Influence of a voltage on the neighbor channels not subject to an input voltage.
 - **AD Converter Values with inputs shorted:** Values on the internal AD converter corresponding to zero input voltage
 - **Input Offset Measurement:** Output voltage and statistical results over a large number of zero voltage measurements.
 - **Input Offset Current:** Typical value for information; Maximum channel input offset current, not considering the input resistance.
 - **Input resistance:** Typical value for information: DAE input resistance at the connector, during internal auto-zeroing and during measurement.
 - **Low Battery Alarm Voltage:** Typical value for information. Below this voltage, a battery alarm signal is generated.
 - **Power consumption:** Typical value for information. Supply currents in various operating modes.



DC Voltage Measurement

A/D - Converter Resolution nominal

High Range: 1LSB = 6.1 μ V, full range = -100...+300 mV

Low Range: 1LSB = 61nV, full range = -1.....+3mV

DASY measurement parameters: Auto Zero Time: 3 sec; Measuring time: 3 sec

Calibration Factors	X	Y	Z
High Range	404.561 \pm 0.1% (k=2)	404.461 \pm 0.1% (k=2)	404.227 \pm 0.1% (k=2)
Low Range	3.96788 \pm 0.7% (k=2)	3.93541 \pm 0.7% (k=2)	3.97576 \pm 0.7% (k=2)

Connector Angle

Connector Angle to be used in DASY system	289.5 $^{\circ}$ \pm 1 $^{\circ}$
---	-------------------------------------



Appendix

1. DC Voltage Linearity

High Range	Reading (μV)	Difference (μV)	Error (%)
Channel X + Input	199995.59	-0.97	-0.00
Channel X + Input	20003.10	2.41	0.01
Channel X - Input	-19994.35	5.66	-0.03
Channel Y + Input	199994.72	-2.07	-0.00
Channel Y + Input	19998.91	-1.88	-0.01
Channel Y - Input	-19998.62	1.36	-0.01
Channel Z + Input	199995.54	-1.18	-0.00
Channel Z + Input	20001.38	0.67	0.00
Channel Z - Input	-19996.65	3.36	-0.02

Low Range	Reading (μV)	Difference (μV)	Error (%)
Channel X + Input	2001.27	-0.06	-0.00
Channel X + Input	201.72	-0.07	-0.03
Channel X - Input	-198.20	0.03	-0.02
Channel Y + Input	2000.66	-0.72	-0.04
Channel Y + Input	201.70	-0.03	-0.01
Channel Y - Input	-198.66	-0.42	0.21
Channel Z + Input	2001.55	0.19	0.01
Channel Z + Input	201.25	-0.48	-0.24
Channel Z - Input	-199.31	-1.04	0.52

2. Common mode sensitivity

DASY measurement parameters: Auto Zero Time: 3 sec; Measuring time: 3 sec

	Common mode Input Voltage (mV)	High Range Average Reading (μV)	Low Range Average Reading (μV)
Channel X	200	11.94	10.52
	-200	-10.34	-11.69
Channel Y	200	1.48	1.37
	-200	-2.82	-2.33
Channel Z	200	0.59	0.59
	-200	-2.65	-2.37

3. Channel separation

DASY measurement parameters: Auto Zero Time: 3 sec; Measuring time: 3 sec

	Input Voltage (mV)	Channel X (μV)	Channel Y (μV)	Channel Z (μV)
Channel X	200	-	3.31	-1.21
Channel Y	200	9.54	-	3.87
Channel Z	200	3.34	7.99	-



4. AD-Converter Values with inputs shorted

DASY measurement parameters: Auto Zero Time: 3 sec; Measuring time: 3 sec

	High Range (LSB)	Low Range (LSB)
Channel X	16008	15626
Channel Y	15794	15710
Channel Z	15984	17133

5. Input Offset Measurement

DASY measurement parameters: Auto Zero Time: 3 sec; Measuring time: 3 sec

Input 10MΩ

	Average (μV)	min. Offset (μV)	max. Offset (μV)	Std. Deviation (μV)
Channel X	0.57	-0.86	1.95	0.41
Channel Y	0.09	-1.01	0.96	0.41
Channel Z	-0.78	-1.65	0.37	0.41

6. Input Offset Current

Nominal Input circuitry offset current on all channels: <25fA

7. Input Resistance (Typical values for information)

	Zeroing (kOhm)	Measuring (MOhm)
Channel X	200	200
Channel Y	200	200
Channel Z	200	200

8. Low Battery Alarm Voltage (Typical values for information)

Typical values	Alarm Level (VDC)
Supply (+ Vcc)	+7.9
Supply (- Vcc)	-7.6

9. Power Consumption (Typical values for information)

Typical values	Switched off (mA)	Stand by (mA)	Transmitting (mA)
Supply (+ Vcc)	+0.01	+6	+14
Supply (- Vcc)	-0.01	-8	-9