

# LS6405/6425/6425-2/6425-3/6425-4 Engraving

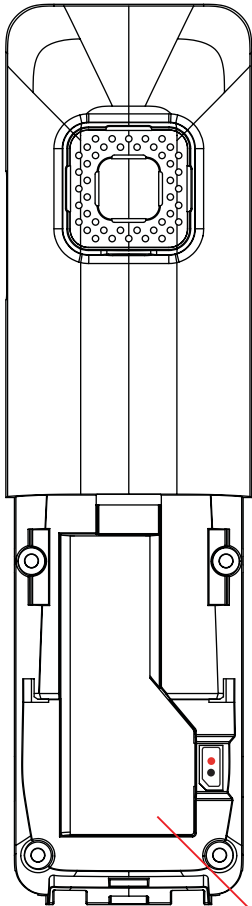

**HS**

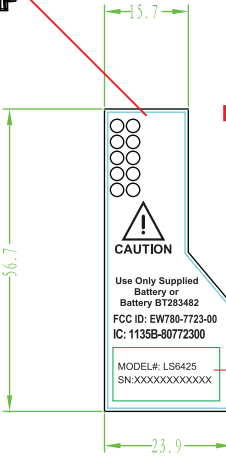

**HS CAUTION LABEL**

MODEL#: LS6405 SN:XXXXXXXXXXXX
MODEL#: LS6425 SN:XXXXXXXXXXXX
MODEL#: LS6425-2 SN:XXXXXXXXXXXX
MODEL#: LS6425-3 SN:XXXXXXXXXXXX
MODEL#: LS6425-4 SN:XXXXXXXXXXXX

**S/N LABEL  
SIZE: 20X10mm**

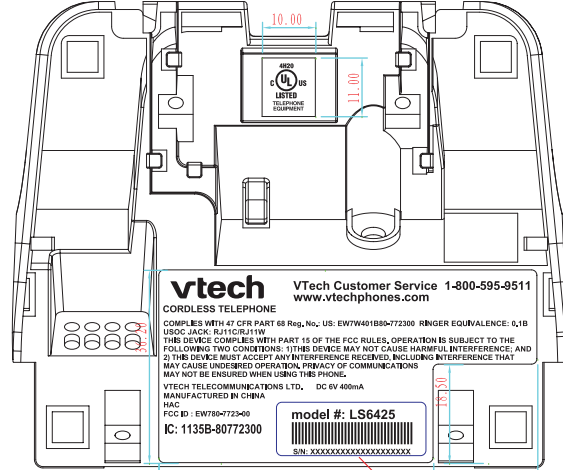
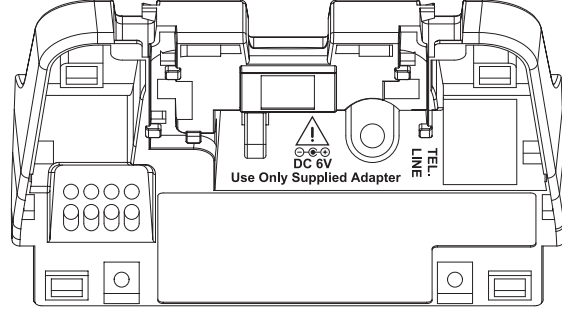
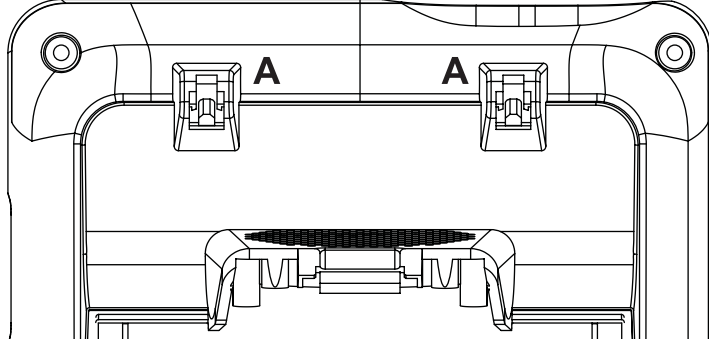

**BS**

model #: LS6425 SN:XXXXXXXXXXXX
model #: LS6425-2 SN:XXXXXXXXXXXX
model #: LS6425-3 SN:XXXXXXXXXXXX
model #: LS6425-4 SN:XXXXXXXXXXXX

**S/N LABEL  
SIZE: 28X10mm**

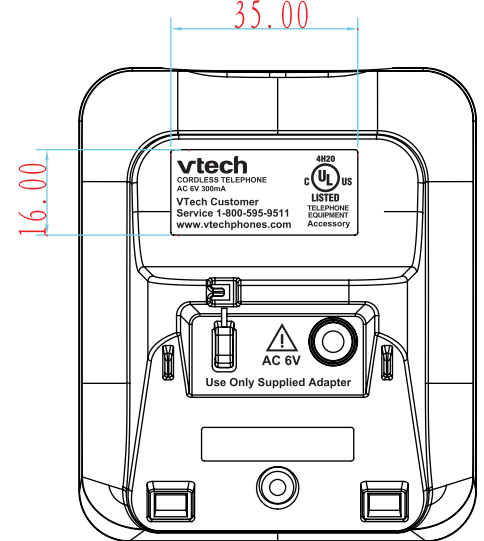

**S/N LABEL  
SIZE: 20X10mm**

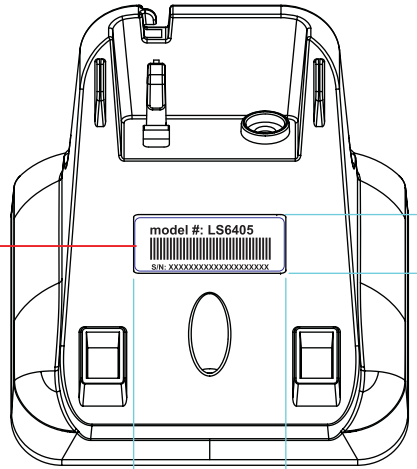

**CHG**