



A Test Lab Techno Corp.

Changan Lab : No. 140 -1, Changan Street, Bade City, Taoyuan County, Taiwan R.O.C.
Tel : 886-3-271-0188 / Fax : 886-3-271-0190

SAR EVALUATION REPORT



Test Report No.	: 0712FS18
Applicant	: VTech Telecommunications Ltd
FCC ID	: EW780-6270-00
Trade Name	: VTech
Model Name	: LS6125-2
Battery Type	: Ni-MH Battery (2.4V , 500mAh)
EUT Type	: DECT 6.0 Cordless Phone
Dates of Test	: Dec. 19, 2007
Test Environment	: Ambient Temperature : 22 ± 3 ° C Relative Humidity : 40 - 70 %
Test Specification	: Standard C95.1-1999 IEEE Std. 1528-2003
Max. SAR	: 0.026 W/kg UPCS Head SAR 0.045 W/kg UPCS Body SAR
FCC Rule Part(s)	: 2.1093;FCC/OET Bulletin 65 Supplement C [July 2001]
Test Lab	: Changan Lab



1. The test operations have to be performed with cautious behavior, the test results are as attached.
2. The test results are under chamber environment of A Test Lab Techno Corp. A Test Lab Techno Corp. does not assume responsibility for any conclusions and generalizations drawn from the test results with regard to other specimens or samples.
3. The measurement report has to be written approval of A Test Lab Techno Corp. It may only be reproduced or published in full.

Country Huang 20080103
Measurement Center Manager

Sam Chuang 20080103
Testing Engineer



Contents

1.	Description of Equipment Under Test (EUT)	3
2.	Other Accessories	5
3.	Introduction	6
4.	SAR Definition	7
5.	SAR Measurement Setup	8
6.	System Components	10
6.1	DASY4 E-Field Probe System.....	10
6.2	Data Acquisition Electronic (DAE) System.....	12
6.3	Robot.....	13
6.4	Measurement Server	13
6.5	Device Holder for Transmitters	13
6.6	Phantom - SAM v4.0	14
6.7	Data Storage and Evaluation	14
7.	Test Equipment List	17
8.	Tissue Simulating Liquids	18
8.1	Liquid Confirmation.....	19
9.	Measurement Process	21
9.1	Device and Test Conditions	21
9.2	System Performance Check.....	22
9.3	Dosimetric Assessment Setup.....	24
9.4	Spatial Peak SAR Evaluation.....	26
10.	Measurement Uncertainty	27
11.	SAR Test Results Summary	29
11.1	UPCS Head SAR.....	29
11.2	UPCS Body SAR	31
11.3	Std. C95.1-1999 RF Exposure Limit	32
12.	Conclusion	33
13.	References	34
Appendix A -	System Performance Check	35
Appendix B -	SAR Measurement Data	39
Appendix C -	Calibration	56



1. Description of Equipment Under Test (EUT)

Applicant : **VTech Telecommunications Ltd**
23/F., Tai Ping Industrial Centre, Block 1, 57 Ting Kok Road, Tai Po, HK

Manufacturer : Dongguan VTech Electronics Telecommunication Industries
Manufacturer Address : VTech Science Park, Xia Ling Bei Management Zone, Liaobu, Dongguan, Guangdong, China.
EUT Type : DECT 6.0 Cordless Phone
FCC ID : EW780-6270-00
Trade Name : VTech
Model Name : LS6125-2
Battery Type : Ni-MH Battery (2.4V · 500mAh)
Test Device : Production Unit
Tx Frequency : 1921.536 -1928.448 MHz (UPCS)
Max. RF Conducted Power : 0.106 W (20.26 dBm) UPCS
Max. SAR Measurement : 0.026 W/kg UPCS Head SAR
0.045 W/kg UPCS Body SAR
HW Version : NA
SW Version : NA
Antenna Type : Fixed Type
Antenna Gain : 0dBi
Device Category : Portable
RF Exposure Environment : General Population / Uncontrolled
Battery Option : Standard
Application Type : Certification

This wireless portable device has been shown to be capable of compliance for localized specific absorption rate (SAR) for uncontrolled environment / general population exposure limits specified in Standard C95.1-1999 and had been tested in accordance with the measurement procedures specified in IEEE Std. 1528-2003.



2. Other Accessories

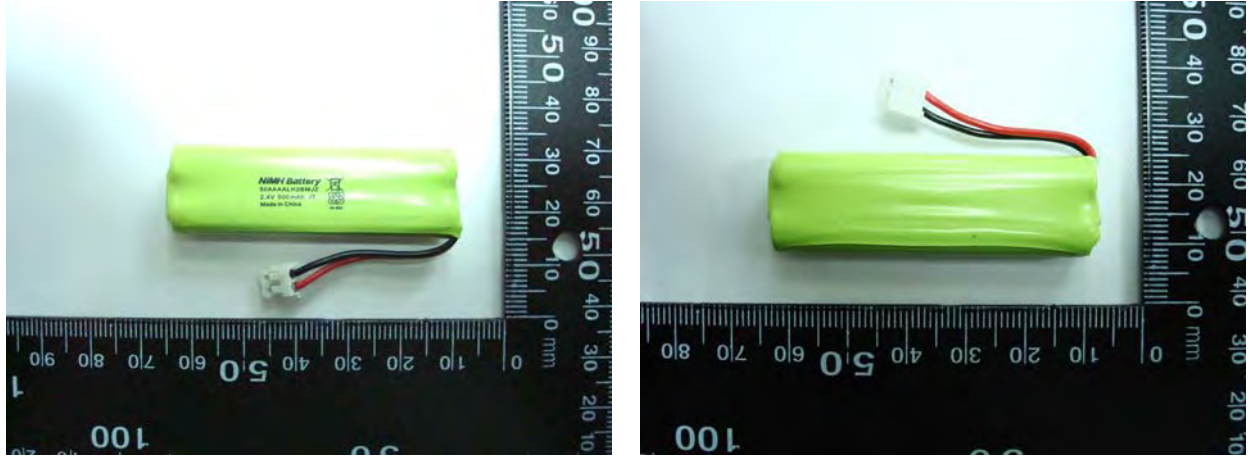

Figure 2. Battery (Ni-MH 2.4V , 500mAh)



Figure 3. Base



Figure 4. Base - AC Power



3. Introduction

The A Test Lab Techno Corp. has performed measurements of the maximum potential exposure to the user of **VTech Telecommunications Ltd Trade Name : VTech Model(s) : LS6125-2**. The test procedures, as described in American National Standards, Institute C95.1 - 1999 [1], FCC/OET Bulletin 65 Supplement C [July 2001] were employed and they specify the maximum exposure limit of 1.6mW/g as averaged over any 1 gram of tissue for portable devices being used within 20cm between user and EUT in the uncontrolled environment. A description of the product and operating configuration, detailed summary of the test results, methodology and procedures used in the equipment used are included within this test report.



4. SAR Definition

Specific Absorption Rate (SAR) is defined as the time derivative (rate) of the incremental energy (dw) absorbed by (dissipated in) an incremental mass (dm) contained in a volume element (dv) of a given density (ρ). It is also defined as the rate of RF energy absorption per unit mass at a point in an absorbing body (see Figure 2).

$$\text{SAR} = \frac{d}{dt} \left(\frac{dw}{dm} \right) = \frac{d}{dt} \left(\frac{dw}{\rho dv} \right)$$

Figure 5. SAR Mathematical Equation

SAR is expressed in units of Watts per kilogram (W/kg)

$$\text{SAR} = \frac{\sigma E^2}{\rho}$$

Where :

σ = conductivity of the tissue (S/m)

ρ = mass density of the tissue (kg/m³)

E = RMS electric field strength (V/m)

* **Note** :

The primary factors that control rate of energy absorption were found to be the wavelength of the incident field in relations to the dimensions and geometry of the irradiated organism, the orientation of the organism in relation to the polarity of field vectors, the presence of reflecting surfaces, and whether conductive contact is made by the organism with a ground plane [2]



5. SAR Measurement Setup

These measurements were performed with the automated near-field scanning system DASY4 from Schmid & Partner Engineering AG (SPEAG). The system is based on a high precision robot (working range greater than 0.9m) which positions the probes with a positional repeatability of better than $\pm 0.025\text{mm}$. Special E- and H-field probes have been developed for measurements close to material discontinuity, the sensors of which are directly loaded with a Schottky diode and connected via highly resistive lines (length = 300mm) to the data acquisition unit.

A cell controller system contains the power supply, robot controller, teach pendant (Joystick), and remote control, is used to drive the robot motors. The Measurement Server is based on a PC/104 CPU board with a 166MHz low-power Pentium, 32MB chipdisk and 64MB RAM. The necessary circuits for communication with either the DAE3 electronic box as well as the 16-bit AD-converter system for optical detection and digital I/O interface are contained on the DASY4 I/O-board, which is directly connected to the PC/104 bus of the CPU board. The PC consists of the Intel Pentium 4 2.4GHz computer with Windows2000 system and SAR Measurement Software DASY4, Post Processor SEMCAD, monitor, mouse, and keyboard. The Staubli Robot is connected to the cell controller to allow software manipulation of the robot. A data acquisition electronic (DAE) circuit performs the signal amplification, signal multiplexing, AD-conversion, offset measurements, mechanical surface detection, collision detection...etc. is connected to the Electro-optical converter (EOC). The EOC performs the conversion from the optical into digital electric signal of the DAE and transfers data to the Measurement Server.

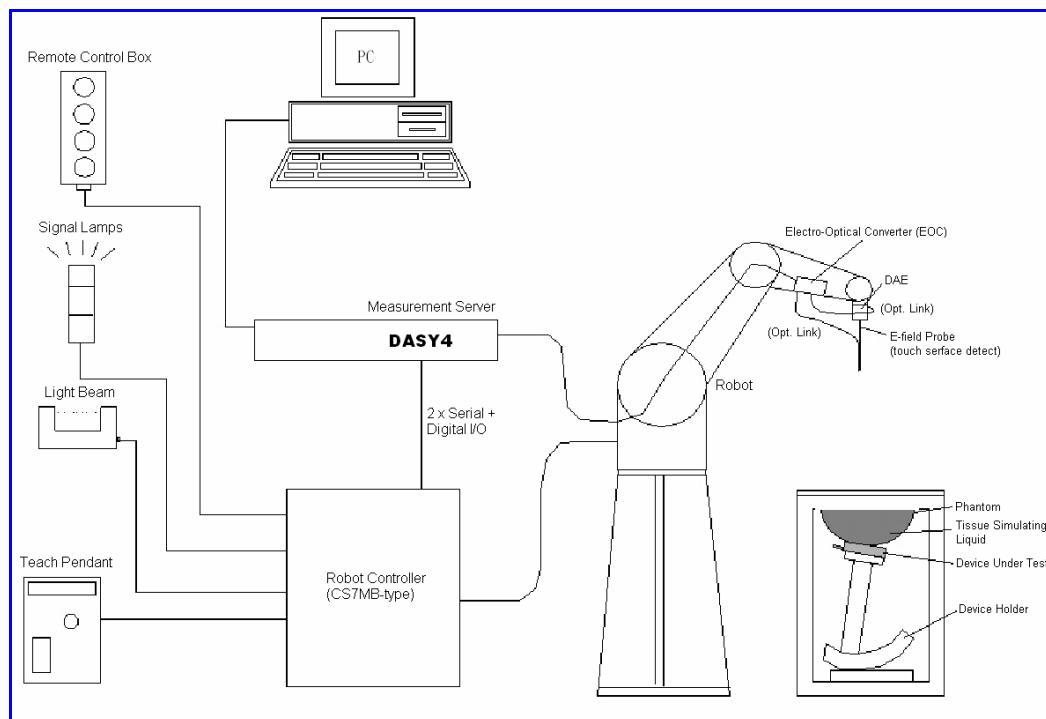

Figure 6. SAR Lab Test Measurement Setup



The DAE3 consists of a highly sensitive electrometer-grade preamplifier with auto-zeroing, a channel and gain-switching multiplexer, a fast 16 bit AD-converter and a command decoder and control logic unit. Transmission to the PC-card is accomplished through an optical downlink for data and status information and an optical uplink for commands and clock lines. The mechanical probe mounting device includes two different sensor systems for frontal and sidewise probe contacts. They are also used for mechanical surface detection and probe collision detection. The robot uses its own controller with a built in VME-bus computer. The system is described in detail in [3] .



6. System Components

6.1 DASY4 E-Field Probe System

The SAR measurements were conducted with the dosimetric probe ET3DV6 (manufactured by SPEAG), designed in the classical triangular configuration [3] and optimized for dosimetric evaluation. The probe is constructed using the thick film technique; with printed resistive lines on ceramic substrates. The probe is equipped with an optical multi-fiber line ending at the front of the probe tip. It is connected to the EOC box on the robot arm and provides an automatic detection of the phantom surface. Half of the fibers are connected to a pulsed infrared transmitter, the other half to a synchronized receiver. As the probe approaches the surface, the reflection from the surface produces a coupling from the transmitting to the receiving fibers. This reflection increases first during the approach, reaches maximum and then decreases. If the probe is flatly touching the surface, the coupling is zero. The distance of the coupling maximum to the surface is independent of the surface reflectivity and largely independent of the surface to probe angle. The DASY4 software reads the reflection during a software approach and looks for the maximum using a 2nd order fitting. The approach is stopped when reaching the maximum.



6.1.1 ET3DV6 E-Field Probe Specification

Construction	Symmetrical design with triangular core Built-in optical fiber for surface detection System. (ET3DV6 only) Built-in shielding against static charges PEEK enclosure material (resistant to organic solvents, e.q., glycol)
Calibration	In air from 10 MHz to 6 GHz In brain and muscle simulating tissue at frequencies of 900MHz, 1800MHz, 2000MHz and 2450MHz. (accuracy $\pm 8\%$) Calibration for other liquids and frequencies upon request
Frequency	10 MHz to > 6 GHz; Linearity: ± 0.2 dB (30 MHz to 3 GHz)
Directivity	± 0.3 dB in brain tissue (rotation around probe axis) ± 0.5 dB in brain tissue (rotation normal probe axis)
Dynamic Range	10 μ W/g to > 100mW/g; Linearity: ± 0.2 dB
Surface Detection	± 0.2 mm repeatability in air and clear liquids over diffuse reflecting surface (ET3DV6 only)
Dimensions	Overall length: 330mm Tip length: 20mm Body diameter: 12mm Tip diameter: 2.5mm Distance from probe tip to dipole centers: 1.0mm
Application	General dosimetry up to 6GHz Compliance tests of mobile phones Fast automatic scanning in arbitrary phantoms



Figure 7.
ET3DV6 E-field Probe



Figure 8.
Probe setup on robot



6.1.2 ET3DV6 E-Field Probe Calibration

Each probe is calibrated according to a dosimetric assessment procedure described in [4] with accuracy better than $\pm 10\%$. The spherical isotropy was evaluated with the procedure described in [5] and found to be better than $\pm 0.25\text{dB}$. The sensitivity parameters (NormX, NormY, and NormZ), the diode compression parameter (DCP) and the conversion factor (ConvF) of the probe are tested.

The free space E-field from amplified probe outputs is determined in a test chamber. This is performed in a TEM cell for frequencies below 1GHz, and in a wave guide above 1GHz for free space. For the free space calibration, the probe is placed in the volumetric center of the cavity and at the proper orientation with the field. The probe is then rotated 360 degrees.

E-field temperature correlation calibration is performed in a flat phantom filled with the appropriate simulated brain tissue. The measured free space E-field in the medium correlates to temperature rise in a dielectric medium. For temperature correlation calibration a RF transparent thermistor-based temperature probe is used in conjunction with the E-field probe.

$$\text{SAR} = C \frac{\Delta T}{\Delta t}$$

Where :

Δt = Exposure time (30 seconds),

C = Heat capacity of tissue (head or body),

ΔT = Temperature increase due to RF exposure.

Or

$$\text{SAR} = \frac{|E|^2 \sigma}{\rho}$$

Where :

σ = Simulated tissue conductivity,

ρ = Tissue density (kg/m^3).

6.2 Data Acquisition Electronic (DAE) System

Cell Controller

Processor : Intel Pentium 4
Clock Speed : 2.4GHz
Operating System : Windows XP Professional

Data Converter

Features : Signal Amplifier, multiplexer, A/D converter, and control logic
Software : DASY4 v4.7 (Build 55) & SEMCAD v1.8 (Build 176)
Connecting Lines : Optical downlink for data and status info
Optical uplink for commands and clock



6.3 Robot

Positioner : Stäubli Unimation Corp. Robot Model: RX90L
Repeatability : ± 0.025 mm
No. of Axis : 6

6.4 Measurement Server

Processor : PC/104 with a 166MHz low-power Pentium
I/O-board : Link to DAE3
16-bit A/D converter for surface detection system
Digital I/O interface
Serial link to robot
Direct emergency stop output for robot

6.5 Device Holder for Transmitters

In combination with the SAM Twin Phantom V4.0, the Mounting Device (POM) enables the rotation of the mounted transmitter in spherical coordinates whereby the rotation points is the ear opening. The devices can be easily, accurately, and repeat ably positioned according to the IEEE SCC34-SC2 and CENELEC specifications. The device holder can be locked at different phantom locations (left head, right head, and flat phantom).

***Note :** A simulating human hand is not used due to the complex anatomical and geometrical structure of the hand that may produced infinite number of configurations [6] . To produce the worst-case condition (the hand absorbs antenna output power), the hand is omitted during the tests.

Larger DUT cannot be tested using this device holder. Instead a support of bigger polystyrene cubes and thin polystyrene plates is used to position the DUT in all relevant positions to find and measure spots with maximum SAR values. Therefore those devices are normally only tested at the flat part of the SAM.

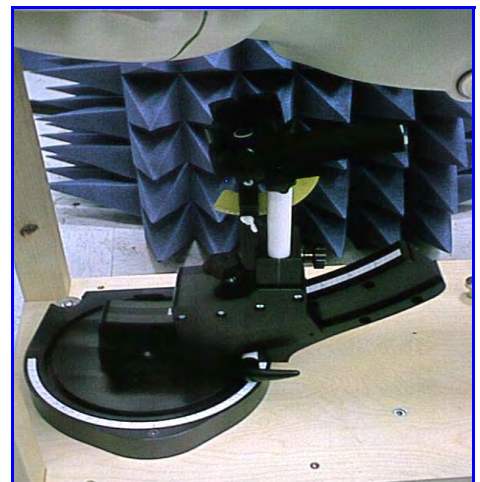

Figure 9. Device Holder

6.6 Phantom - SAM v4.0

The shell corresponds to the specifications of the Specific Anthropomorphic Mannequin (SAM) phantom defined in IEEE 1528-2003, CENELEC 50361 and IEC 62209. It enables the dosimetric evaluation of left and right hand phone usage as well as body mounted usage at the flat phantom region. A cover prevents evaporation of the liquid. Reference markings on the phantom allow the complete setup of all predefined phantom positions and measurement grids by manually teaching three points with the robot.

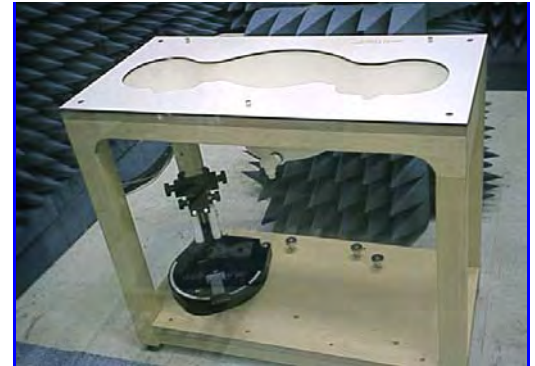

Figure 10. SAM Twin Phantom

Shell Thickness	2 ±0.2 mm
Filling Volume	Approx. 25 liters
Dimensions	810x1000x500 mm (HxLxW)

Table 1. Specification of SAM v4.0

6.7 Data Storage and Evaluation

6.7.1 Data Storage

The DASY4 software stores the assessed data from the data acquisition electronics as raw data (in microvolt readings from the probe sensors), together with all the necessary software parameters for the data evaluation (probe calibration data, liquid parameters and device frequency and modulation data) in measurement files with the extension .DA4. The postprocessing software evaluates the desired unit and format for output each time the data is visualized or exported. This allows verification of the complete software setup even after the measurement and allows correction of erroneous parameter settings. For example, if a measurement has been performed with an incorrect crest factor parameter in the device setup, the parameter can be corrected afterwards and the data can be reevaluated.



6.7.2 Data Evaluation

The DASY4 post processing software (SEMCAD) automatically executes the following procedures to calculate the field units from the microvolt readings at the probe connector. The parameters used in the evaluation are stored in the configuration modules of the software :

Probe parameters :	- Sensitivity	Normi, ai0, ai1, ai2
	- Conversion factor	ConvFi
	- Diode compression point	dcp _i
Device parameters :	- Frequency	f
	- Crest factor	cf
Media parameters :	- Conductivity	σ
	- Density	ρ

These parameters must be set correctly in the software. They can be found in the component documents or they can be imported into the software from the configuration files issued for the DASY components. In the direct measuring mode of the multimeter option, the parameters of the actual system setup are used. In the scan visualization and export modes, the parameters stored in the corresponding document files are used.

The first step of the evaluation is a linearization of the filtered input signal to account for the compression characteristics of the detector diode. The compensation depends on the input signal, the diode type and the DC-transmission factor from the diode to the evaluation electronics. If the exciting field is pulsed, the crest factor of the signal must be known to correctly compensate for peak power. The formula for each channel can be given as :

$$V_i = U_i + U_i^2 \cdot \frac{cf}{dcp_i}$$

with V_i = compensated signal of channel i ($i = x, y, z$)
 U_i = input signal of channel i ($i = x, y, z$)
 cf = crest factor of exciting field (DASY parameter)
 dcp_i = diode compression point (DASY parameter)

From the compensated input signals the primary field data for each channel can be evaluated :

E-field probes :

$$E_i = \sqrt{\frac{V_i}{Norm_i \cdot ConvF}}$$



H-field probes :

$$H_i = \sqrt{V_i} \cdot \frac{a_{i0} + a_{i1}f + a_{i2}f^2}{f}$$

with V_i = compensated signal of channel i ($i = x, y, z$)

$Norm_i$ = sensor sensitivity of channel i ($i = x, y, z$)
 $\mu V/(V/m)^2$ for E-field Probes

$ConvF$ = sensitivity enhancement in solution

a_{ij} = sensor sensitivity factors for H-field probes

f = carrier frequency [GHz]

E_i = electric field strength of channel i in V/m

Hi = magnetic field strength of channel i in A/m

The RSS value of the field components gives the total field strength (Hermitian magnitude) :

$$E_{tot} = \sqrt{E_x^2 + E_y^2 + E_z^2}$$

The primary field data are used to calculate the derived field units.

$$SAR = E_{tot}^2 \cdot \frac{\sigma}{\rho \cdot 1000}$$

with SAR = local specific absorption rate in mW/g

E_{tot} = total field strength in V/m

σ = conductivity in [mho/m] or [Siemens/m]

ρ = equivalent tissue density in g/cm^3

*** Note :** that the density is set to 1, to account for actual head tissue density rather than the density of the tissue simulating liquid.

The power flow density is calculated assuming the excitation field to be a free space field.

$$P_{pwe} = \frac{E_{tot}^2}{3770} \quad \text{or} \quad P_{pwe} = \frac{H_{tot}^2}{37.7}$$

with P_{pwe} = equivalent power density of a plane wave in mW/cm^2

E_{tot} = total electric field strength in V/m

H_{tot} = total magnetic field strength in A/m



7. Test Equipment List

Manufacturer	Name of Equipment	Type/Model	Serial Number	Calibration	
				Last Cal.	Due Date
SPEAG	Dosimetric E-Filed Probe	ET3DV6	1531	Jan. 22, 2007	Jan. 22, 2008
SPEAG	2000MHz System Validation Kit	D2000V2	1008	Feb. 14, 2007	Feb. 14, 2008
SPEAG	Data Acquisition Electronics	DAE4	541	Nov. 15, 2007	Nov. 15, 2008
SPEAG	Device Holder	N/A	N/A	NCR	NCR
SPEAG	Phantom	SAM V4.0	1009	NCR	NCR
SPEAG	Robot	Staubli RX90L	F00/589B1/A/01	NCR	NCR
SPEAG	Software	DASY4 V4.7 Build 55	N/A	NCR	NCR
SPEAG	Software	SEMCAD V1.8 Build 176	N/A	NCR	NCR
SPEAG	Measurement Server	SE UMS 001 BA	1021	NCR	NCR
R & S	Wireless Communication Test Set	CMU200	112387	Apr. 02, 2007	Apr. 02, 2008
Agilent	ENA Series Network Analyzer	E5071B	MY42404650	Jan. 19, 2007	Jan. 19, 2008
Agilent	Dielectric Probe Kit	85070C	US99360094	NCR	NCR
Agilent	Power Meter	E4418B	GB40206143	May. 28,2007	May. 28,2008
Agilent	Power Sensor	8481H	3318A20779	May. 23,2007	May. 23,2008
Agilent	Signal Generator	8648C	3847A05201	May. 28,2007	May. 28,2008
Agilent	Dual Directional Coupler	778D	50334	NCR	NCR
Mini-Circuits	Power Amplifier	ZHL-42W-SMA	D111103#5	NCR	NCR
Mini-Circuits	Power Amplifier	ZVE-8G-SMA	D042005 671800514	NCR	NCR

Table 2. Test Equipment List



8. Tissue Simulating Liquids

The mixture is calibrated to obtain proper dielectric constant (permittivity) and conductivity of the tissue.

The dielectric parameters of the liquids were verified prior to the SAR evaluation using an 85070C Dielectric Probe Kit and an 8720ES Network Analyzer.

INGREDIENT	FREQUENCY	
	HSL5G (Head)	MSL5G (Body)
Water	64%	78%
Mineral Oil	18%	11%
Emulsifiers	15%	9%
Additives and Salt	3%	2%

Table 3. Recipes for Head & Body Tissue Simulating Liquids

IEEE SCC-34/SC-2 in 1528 recommended Tissue Dielectric Parameters

The head tissue dielectric parameters recommended by the IEEE SCC-34/SC-2 in 1528 have been incorporated in the following table. These head parameters are derived from planar layer models simulating the highest expected SAR for the dielectric properties and tissue thickness variations in human head. Other head and body tissue parameters that have not been specified in 1528 are derived from the tissue dielectric parameters computed from the 4-Cole-Cole equation and extrapolated according to the head parameter specified in 1528.



Target Frequency (MHz)	Head		Body	
	ϵ_r	σ (S/m)	ϵ_r	σ (S/m)
150	52.3	0.76	61.9	0.80
300	45.3	0.87	58.2	0.92
450	43.5	0.87	56.7	0.94
835	41.5	0.90	55.2	0.97
900	41.5	0.97	55.0	1.05
915	41.5	0.98	55.0	1.06
1450	40.5	1.20	54.0	1.30
1610	40.3	1.29	53.8	1.40
1800 - 2000	40.0	1.40	53.3	1.52
2450	39.2	1.80	52.7	1.95
3000	38.5	2.40	52.0	2.73
5800	35.3	5.27	48.2	6.00

(ϵ_r = relative permittivity, σ = conductivity and $\rho = 1000 \text{ kg/m}^3$)

Table 4. Tissue dielectric parameters for head and body phantoms

8.1 Liquid Confirmation

8.1.1 Parameters

Liquid Verify								
Ambient Temperature : $22 \pm 3 \text{ }^\circ\text{C}$; Relative Humidity : 40 -70%								
Liquid Type	Frequency	Temp ($^\circ\text{C}$)	Parameters	Target Value	Measured Value	Deviation (%)	Limit (%)	Measured Date
2000MHz Head	2000MHz	22.0	ϵ_r	40.0	40.3	0.75	$\pm 5 \%$	Dec. 19, 2007
			σ	1.40	1.44	2.86	$\pm 5 \%$	
2000MHz Body	2000MHz	22.0	ϵ_r	53.3	53.5	0.38	$\pm 5 \%$	Dec. 19, 2007
			σ	1.52	1.54	1.32	$\pm 5 \%$	

Table 5. Measured Tissue dielectric parameters for head and body phantoms

8.1.2 Liquid Depth

The liquid level was during measurement 15cm \pm 0.5cm.

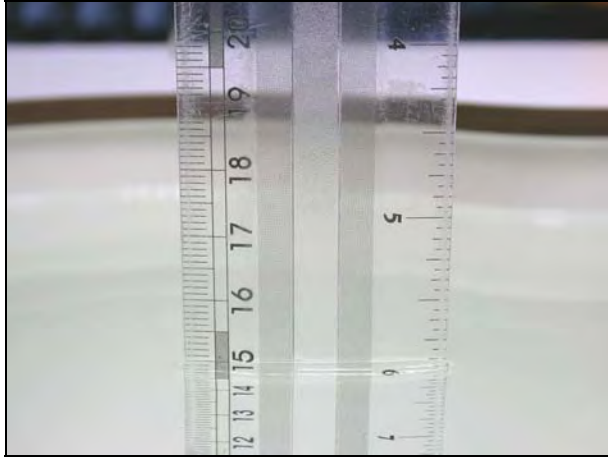

Figure 11. Head-Tissue-Simulating-Liquid



Figure 12. Body-Tissue-Simulating-Liquid



9. Measurement Process

9.1 Device and Test Conditions

The Test Device was provided by **VTech Telecommunications Ltd** for this evaluation. The spatial peak SAR alues were assessed for the lowest, middle and highest channels defined by UPCS (Ch0 = 1928.448MHz, Ch2 = 1924.992MHz, Ch4 = 1921.536MHz) systems. The antenna(s), battery and accessories shall be those specified by the manufacturer. The battery shall be fully charged before each measurement and there shall be no external connections.

Usage :		Operates with a built-in test mode by client		
Distance between antenna axis at the joint and the liquid surface :		For head, EUT left head, right head, to phantom, 0mm separation. For Body, EUT back to phantom, 0mm separation.		
Simulating human Head/Body :		Head and Body		
EUT Battery :		Fully-charged with Nickel-Metal batteries.		
Conducted power	Channel	Frequency MHz	Before SAR Test (dBm)	After SAR Test (dBm)
	Highest Channel - 0	1928.448	19.90	19.89
	Middle Channel - 2	1924.992	20.26	20.24
	Lowest Channel - 4	1921.536	19.93	19.92

Note:

1. The EUT has built-in test mode that used to evaluate SAR.
2. The EUT take Nickel-Metal as its power source. Each test was preceded under the condition of fully-charged EUT.

9.2 System Performance Check

9.2.1 Symmetric Dipoles for System Validation

Construction	Symmetrical dipole with 1/4 balun enables measurement of feed point impedance with NWA matched for use near flat phantoms filled with head simulating solutions Includes distance holder and tripod adaptor Calibration Calibrated SAR value for specified position and input power at the flat phantom in head simulating solutions.
Frequency	450MHz, 900MHz, 1800MHz, 2000MHz and 2450MHz
Return Loss	> 20 dB at specified validation position
Power Capability	> 100 W (f < 1GHz); > 40 W (f > 1GHz)
Options	Dipoles for other frequencies or solutions and other calibration conditions are available upon request
Dimensions	D450V2 : dipole length 270 mm; overall height 330 mm D900V2 : dipole length 149 mm; overall height 330 mm D1800V2 : dipole length 72 mm; overall height 300 mm D2000V2 : dipole length 65 mm; overall height 300 mm D2450V2 : dipole length 51.5 mm; overall height 300 mm



Figure 13. Validation Kit



9.2.2 Validation

Prior to the assessment, the system validation kit was used to test whether the system was operating within its specifications of $\pm 7\%$. The validation was performed at 2000MHz.

Validation kit		Mixture Type	SAR _{1g} [mW/g]		SAR _{10g} [mW/g]		Date of Calibration
D2000V2-SN1008		Head	41.2		21.56		Feb, 14, 2008
		Body	42.8		22.2		
Frequency (MHz)	Power (dBm)	SAR _{1g} (mW/g)	SAR _{10g} (mW/g)	Drift (dB)	Difference percentage		Date
					1g	10g	
2000 (Head)	250mW	10.7	5.65	-0.063	3.9 %	4.8 %	Dec. 19, 2007
	Normalize to 1 Watt	42.8	22.6				
2000 (Body)	250mW	10.7	5.71	-0.023	0.0 %	2.9 %	Dec. 19, 2007
	Normalize to 1 Watt	42.8	22.84				



9.3 Dosimetric Assessment Setup

9.3.1 Headset Test Position - Body - Worn

Body-Worn Configuration

Body-worn operating configurations should be tested with the belt-clips and holsters attached to the device and positioned against a flat phantom in normal use configurations. Devices with a handset output should be tested with a handset connected to the device.

Body-worn accessories may not always be supplied or available as options for some devices that are intended to be authorized for body-worn use. A separation distance of 1.5 cm between the back of the device and a flat phantom is recommended for testing body-worn SAR compliance under such circumstances.

For this test :

- The EUT is placed into the holster/belt clip and the holster is positioned against the surface of the phantom in a normal operating position.
- Since this EUT doesn't supply any body-worn accessory to the end user, a distance of 2 mm was tested to confirm the necessary "minimum SAR separation distance".
(* Note : This distance includes the 2 mm phantom shell thickness.)



9.3.2 Measurement Procedures

The evaluation was performed with the following procedures :

Surface Check : A surface check job gathers data used with optical surface detection. It determines the distance from the phantom surface where the reflection from the optical detector has its peak. Any following measurement jobs using optical surface detection will then rely on this value. The surface check performs its search a specified number of times, so that the repeatability can be verified. The probe tip distance is 1.3mm to phantom inner surface during scans.

Reference : The reference job measures the field at a specified reference position, at 4 mm from the selected section's grid reference point.

Area Scan : The area scan is used as a fast scan in two dimensions to find the area of high field values, before doing a finer measurement around the hot spot. The sophisticated interpolation routines can find the maximum locations even in relatively coarse grids. When an area scan has measured all reachable points, it computes the field maxima found in the scanned area, within a range of the global maximum. Any following zoom scan within the same procedure will then perform fine scans around these maxima. The area covered the entire dimension of the EUT and the horizontal grid spacing was 15 mm x 15 mm.

Zoom Scan : Zoom scans are used to assess the highest averaged SAR for cubic averaging volumes with 1 g and 10 g of simulated tissue. The zoom scan measures 5 x 5 x 7 points in a 32 x 32 x 30 mm cube whose base faces are centered around the maxima returned from a preceding area scan within the same procedure.

Drift : The drift job measures the field at the same location as the most recent reference job within the same procedure, with the same settings. The drift measurement gives the field difference in dB from the last reference measurement. Several drift measurements are possible for each reference measurement. This allows monitoring of the power drift of the device in the batch process. If the value changed by more than 5%, the evaluation was repeated.



9.4 Spatial Peak SAR Evaluation

The DASY4 software includes all numerical procedures necessary to evaluate the spatial peak SAR values. Based on the Draft: SCC-34, SC-2, WG-2 - Computational Dosimetry, IEEE P1529/D0.0 (Draft Recommended Practice for Determining the Spatial-Peak Specific Absorption Rate (SAR) Associated with the Use of Wireless Handsets - Computational Techniques), a new algorithm has been implemented. The spatial-peak SAR can be computed over any required mass.

The base for the evaluation is a "cube" measurement in a volume of $(32 \times 32 \times 30) \text{mm}^3$ ($5 \times 5 \times 7$ points). The measured volume must include the 1g and 10g cubes with the highest averaged SAR values. For that purpose, the center of the measured volume is aligned to the interpolated peak SAR value of a previously performed area scan. If the 10g cube or both cubes are not entirely inside the measured volumes, the system issues a warning regarding the evaluated spatial peak values within the Postprocessing engine (SEMCAD). This means that if the measured volume is shifted, higher values might be possible. To get the correct values you can use a finer measurement grid for the area scan. In complicated field distributions, a large grid spacing for the area scan might miss some details and give an incorrectly interpolated peak location.

The entire evaluation of the spatial peak values is performed within the Postprocessing engine (SEMCAD). The system always gives the maximum values for the 1g and 10g cubes. The algorithm to find the cube with highest averaged SAR is divided into three stages:

Interpolation and Extrapolation

The probe is calibrated at the center of the dipole sensors which is located 1 to 2.7mm away from the probe tip. During measurements, the probe stops shortly above the phantom surface, depending on the probe and the surface detecting system. Both distances are included as parameters in the probe configuration file. The software always knows exactly how far away the measured point is from the surface. As the probe cannot directly measure at the surface, the values between the deepest measured point and the surface must be extrapolated.

In DASY4, the choice of the coordinate system defining the location of the measurement points has no influence on the uncertainty of the interpolation, Maxima Search and SAR extrapolation routines. The interpolation, Maxima Search and extrapolation routines are all based on the modified Quadratic Shepard's method [7].



10. Measurement Uncertainty

Measurement uncertainties in SAR measurements are difficult to quantify due to several variables including biological, physiological, and environmental. However, we estimate the measurement uncertainties in SAR to be less than $\pm 27\%$ [8] .

According to Std. C95.3 [9] , the overall uncertainties are difficult to assess and will vary with the type of meter and usage situation. However, accuracy's of ± 1 to 3 dB can be expected in practice, with greater uncertainties in near-field situations and at higher frequencies (shorter wavelengths), or areas where large reflecting objects are present. Under optimum measurement conditions, SAR measurement uncertainties of at least ± 2 dB can be expected.

According to CENELEC [10] , typical worst-case uncertainty of field measurements is ± 5 dB. For well-defined modulation characteristics the uncertainty can be reduced to ± 3 dB.



Source of Uncertainty	Uncertainty Value	Probability Distribution	Divisor	C_i	Standard Uncertainty $\pm 1\%(1-g)$	V_i or V_{eff}
Type-A	0.9 %	Normal	1	1	0.9	9
Measurement System						
Probe Calibration	7 %	Normal	2	1	3.5	∞
Axial Isotropy	0.2dB	Rectangular	$\sqrt{3}$	$\sqrt{0.5}$	1.9	∞
Hemispherical Isotropy	9.6 %	Rectangular	$\sqrt{3}$	$\sqrt{0.5}$	3.9	∞
Spatial Resolution	0 %	Rectangular	$\sqrt{3}$	1	0	∞
Boundary Effect	11.0 %	Rectangular	$\sqrt{3}$	1	6.4	∞
Linearity	0.2dB	Rectangular	$\sqrt{3}$	1	2.7	∞
Detection Limit	1.0 %	Rectangular	$\sqrt{3}$	1	0.6	∞
Readout Electronics	1.0 %	Normal	1	1	1.0	∞
RF Ambient Conditions	3.0 %	Rectangular	$\sqrt{3}$	1	1.73	∞
Probe Positioner Mech. Const.	0.4 %	Rectangular	$\sqrt{3}$	1	0.2	∞
Probe Positioning	0.35 %	Rectangular	$\sqrt{3}$	1	0.2	∞
Extrapolation and Integration	3.9 %	Rectangular	$\sqrt{3}$	1	2.3	∞
Test sample Related						
Test sample Positioning	4.7 %	Normal	1	1	4.7	5
Device Holder Uncertainty	6.1 %	Normal	1	1	6.1	5
Drift of Output Power	5.0 %	Rectangular	$\sqrt{3}$	1	2.9	∞
Phantom and Setup						
Phantom Uncertainty (Including temperature effects)	4.0%	Rectangular	$\sqrt{3}$	1	2.3	∞
Liquid Conductivity (target)	5.0%	Rectangular	$\sqrt{3}$	0.6	1.7	∞
Liquid Conductivity (meas.)	10.0%	Rectangular	$\sqrt{3}$	0.6	3.4	∞
Liquid Permittivity (target)	5.0%	Rectangular	$\sqrt{3}$	0.6	1.7	∞
Liquid Permittivity (meas.)	5.0%	Rectangular	$\sqrt{3}$	0.6	1.7	∞
Combined standard uncertainty		RSS			13.5	88.7
Expanded uncertainty (Coverage factor = 2)		Normal (k=2)			27	

Table 6. Uncertainty Budget of DASY



11. SAR Test Results Summary

11.1 UPCS Head SAR

Ambient :

Temperature (°C) : 22 ± 3 Relative HUMIDITY (%) : 40 - 70

Liquid :

Mixture Type : HSL2000 Liquid Temperature (°C) : 22.0
 Depth of liquid (cm) : 15

Measurement :

Crest Factor : 1 Probe S/N : 1531

Frequency		Battery	Phantom Position	Accessory	SAR _{1g} [mW/g]	Power Drift (dB)	Temp.		Remark
MHz	CH						Amb.	Liq.	
1928.448	0	Ni-MH	Right-Cheek	N/A	0.022	-0.093	22.0	22.0	-
1924.992	2	Ni-MH	Right-Cheek	N/A	0.021	0.091	22.0	22.0	-
1921.536	4	Ni-MH	Right-Cheek	N/A	0.020	-0.178	22.0	22.0	-
1928.448	0	Ni-MH	Right-Tilted	N/A	0.018	-0.187	22.0	22.0	-
1924.992	2	Ni-MH	Right-Tilted	N/A	0.018	-0.109	22.0	22.0	-
1921.536	4	Ni-MH	Right-Tilted	N/A	0.019	0.036	22.0	22.0	-
1928.448	0	Ni-MH	Left-Cheek	N/A	0.026	0.067	22.0	22.0	-
1924.992	2	Ni-MH	Left-Cheek	N/A	0.026	-0.001	22.0	22.0	-
1921.536	4	Ni-MH	Left-Cheek	N/A	0.025	0.022	22.0	22.0	-
1928.448	0	Ni-MH	Left-Tilted	N/A	0.019	-0.034	22.0	22.0	-
1924.992	2	Ni-MH	Left-Tilted	N/A	0.018	-0.033	22.0	22.0	-
1921.536	4	Ni-MH	Left-Tilted	N/A	0.018	-0.077	22.0	22.0	-
Std. C95.1-1999 - Safety Limit Spatial Peak Uncontrolled Exposure/General Population					1.6 W/kg (mW/g) Averaged over 1 gram				

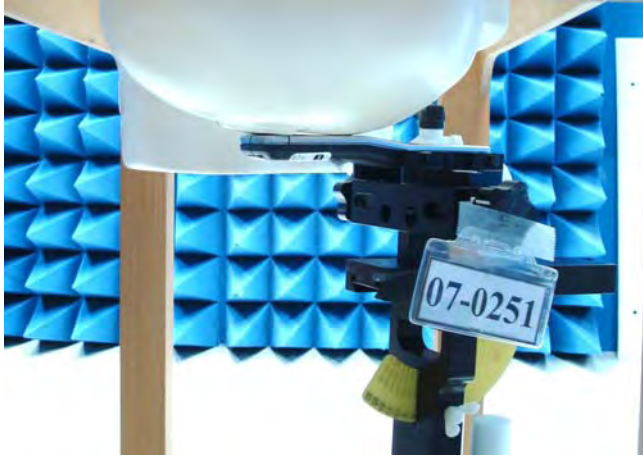

Figure 14. Right Head SAR Test Setup (Cheek)

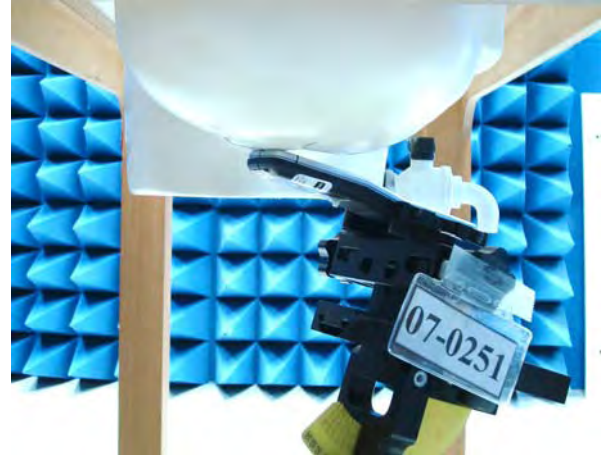

Figure 15. Right Head SAR Test Setup (Tilted)



Figure 16. Left Head SAR Test Setup (Cheek)

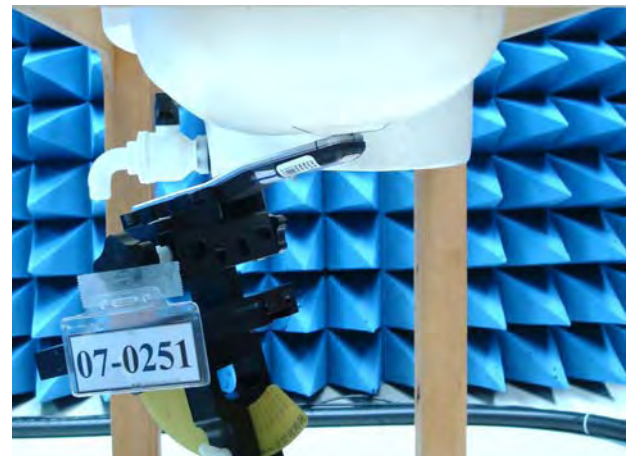

Figure 17. Left Head SAR Test Setup (Tilted)

11.2 UPCS Body SAR

Ambient :

Temperature (°C) : 22 ± 3 Relative HUMIDITY (%) : 40-70

Liquid :

Mixture Type : MSL2000 Liquid Temperature (°C) : 22.0
 Depth of liquid (cm) : 15

Measurement :

Crest Factor : 1 Probe S/N : 1531

Frequency		Battery	Phantom Position	Accessory	SAR _{1g} [mW/g]	Power Drift (dB)	Temp.		Remark
MHz	CH						Amb.	Liq.	
1928.448	0	Ni-MH	Flat	N/A	0.045	-0.099	22.0	22.0	-
1924.992	2	Ni-MH	Flat	N/A	0.040	-0.021	22.0	22.0	-
1921.536	4	Ni-MH	Flat	N/A	0.039	0.021	22.0	22.0	-
Std. C95.1-1999 - Safety Limit Spatial Peak Uncontrolled Exposure/General Population					1.6 W/kg (mW/g) Averaged over 1 gram				



Figure 18. Body SAR Test Setup (Flat Section)



11.3 Std. C95.1-1999 RF Exposure Limit

Human Exposure	Population Uncontrolled Exposure (W/kg) or (mW/g)	Occupational Controlled Exposure (W/kg) or (mW/g)
Spatial Peak SAR* (head)	1.60	8.00
Spatial Peak SAR** (Whole Body)	0.08	0.40
Spatial Peak SAR*** (Partial-Body)	1.60	8.00
Spatial Peak SAR**** (Hands / Feet / Ankle / Wrist)	4.00	20.00

Table 7. Safety Limits for Partial Body Exposure

Notes :

- * The Spatial Peak value of the SAR averaged over any 1 gram of tissue.
(defined as a tissue volume in the shape of a cube) and over the appropriate averaging time.
- ** The Spatial Average value of the SAR averaged over the whole - body.
- *** The Spatial Average value of the SAR averaged over the partial - body.
- **** The Spatial Peak value of the SAR averaged over any 10 grams of tissue.
(defined as a tissue volume in the shape of a cube) and over the appropriate averaging time.

Population / Uncontrolled Environments : are defined as locations where there is the exposure of individuals who have no knowledge or control of their exposure.

Occupational / Controlled Environments : are defined as locations where there is exposure that may be incurred by persons who are aware of the potential for exposure, (i.e. as a result of employment or occupation).



12. Conclusion

The SAR test values found for the portable mobile phone **VTech Telecommunications Ltd Trade Name : VTech Model(s) : LS6125-2** are below the maximum recommended level of 1.6 W/kg (mW/g).



13. References

- [1] Std. C95.1-1999, "American National Standard safety levels with respect to human exposure to radio frequency electromagnetic fields, 300KHz to 100GHz", New York.
- [2] NCRP, National Council on Radiation Protection and Measurements, "Biological Effects and Exposure Criteria for Radio frequency Electromagnetic Fields", NCRP report NO. 86, 1986.
- [3] T. Schmid, O. Egger, and N. Kuster, "Automatic E-field scanning system for dosimetric assessments", IEEE Transactions on Microwave Theory and Techniques, vol. 44, pp, 105-113, Jan. 1996.
- [4] K. Poković, T. Schmid, and N. Kuster, "Robust setup for precise calibration of E-field probes in tissue simulating liquids at mobile communications frequency", in ICECOM'97, Dubrovnik, October 15-17, 1997, pp.120-124.
- [5] K. Poković, T. Schmid, and N. Kuster, "E-field probe with improved isotropy in brain simulating liquids", in Proceedings of the ELMAR, Zadar, Croatia, 23-25 June, 1996, pp.172-175.
- [6] N. Kuster, and Q. Balzano, "Energy absorption mechanism by biological bodies in the near field of dipole antennas above 300MHz", IEEE Transaction on Vehicular Technology, vol. 41, no. 1, Feb. 1992, pp. 17-23.
- [7] Robert J. Renka, "Multivariate Interpolation Of Large Sets Of Scattered Data", University of North Texas ACM Transactions on Mathematical Software, vol. 14, no. 2, June 1988 , pp. 139-148.
- [8] N. Kuster, R. Kastle, T. Schmid, *Dosimetric evaluation of mobile communications equipment with known precision*, IEEE Transaction on Communications, vol. E80-B, no. 5, May 1997, pp. 645-652.
- [9] Std. C95.3-1991, "IEEE Recommended Practice for the Measurement of Potentially Hazardous Electromagnetic Fields - RF and Microwave, New York: IEEE, Aug. 1992.
- [10] CENELEC CLC/SC111B, European Prestandard (prENV 50166-2), *Human Exposure to Electromagnetic Fields High-frequency. 10KHz-300GHz*, Jan. 1995.



Appendix A - System Performance Check

See following Attached Pages for System Performance Check.



Test Laboratory: A Test Lab Techno Corp. Date/Time: 12/19/2007 10:12:29 AM

System Performance Check at 2000MHz_20071219_Head

DUT: Dipole 2000 MHz; Type: D 2000V2; Serial: D2000V2 - SN:1008

Communication System: CW; Frequency: 2000 MHz; Duty Cycle: 1:1

Medium parameters used: $f = 2000 \text{ MHz}$; $\sigma = 1.44 \text{ mho/m}$; $\epsilon_r = 40.3$; $\rho = 1000 \text{ kg/m}^3$

Phantom section: Flat Section

Measurement Standard: DASY4 (High Precision Assessment)

DASY4 Configuration:

- Probe: ET3DV6 - SN1531; ConvF(4.79, 4.79, 4.79); Calibrated: 1/22/2007
- Sensor-Surface: 4mm (Mechanical Surface Detection)
- Electronics: DAE4 Sn541; Calibrated: 11/15/2007
- Phantom: SAM 12; Type: SAM v4.0; Serial: TP:1009
- Measurement SW: DASY4, V4.7 Build 55; Postprocessing SW: SEMCAD, V1.8 Build 176

System Performance Check at 2000MHz/Area Scan (61x71x1):

Measurement grid: $dx=15\text{mm}$,

$dy=15\text{mm}$

Maximum value of SAR (interpolated) = 12.9 mW/g

System Performance Check at 2000MHz/Zoom Scan (7x7x7)/Cube 0:

Measurement grid: $dx=5\text{mm}$,

$dy=5\text{mm}$, $dz=5\text{mm}$

Reference Value = 96.8 V/m; Power Drift = -0.063 dB

Peak SAR (extrapolated) = 17.8 W/kg

SAR(1 g) = 10.7 mW/g; SAR(10 g) = 5.65 mW/g

Maximum value of SAR (measured) = 12.0 mW/g

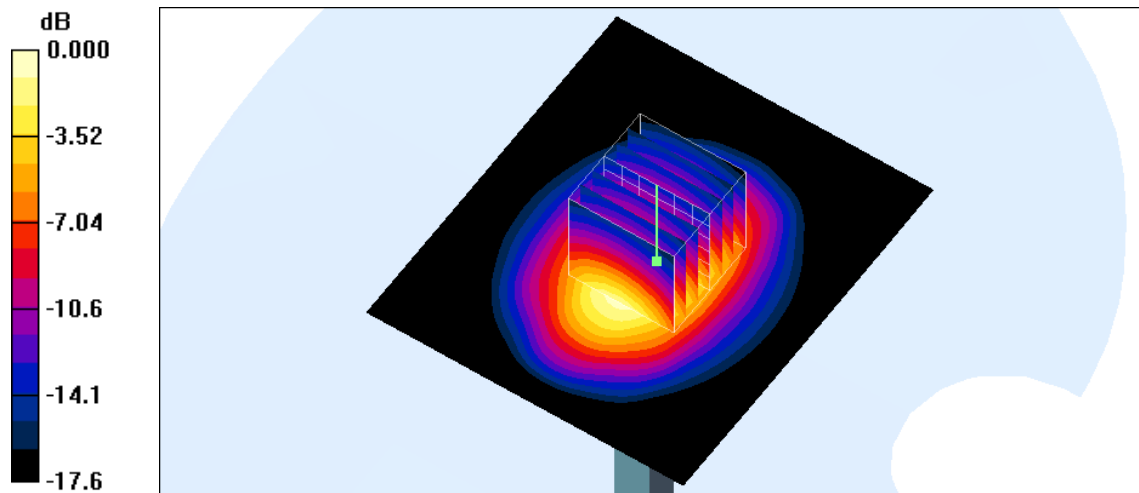

0 dB = 12.0mW/g



Test Laboratory: A Test Lab Techno Corp. Date/Time: 12/19/2007 4:35:07 PM

System Performance Check at 2000MHz_20071219_Body

DUT: Dipole 2000 MHz; Type: D 2000V2; Serial: D2000V2 - SN:1008

Communication System: CW; Frequency: 2000 MHz; Duty Cycle: 1:1

Medium parameters used: $f = 2000$ MHz; $\sigma = 1.54$ mho/m; $\epsilon_r = 53.5$; $\rho = 1000$ kg/m³

Phantom section: Flat Section

Measurement Standard: DASY4 (High Precision Assessment)

DASY4 Configuration:

- Probe: ET3DV6 - SN1531; ConvF(4.39, 4.39, 4.39); Calibrated: 1/22/2007
- Sensor-Surface: 4mm (Mechanical Surface Detection)
- Electronics: DAE4 Sn541; Calibrated: 11/15/2007
- Phantom: SAM 12; Type: SAM v4.0; Serial: TP:1009
- Measurement SW: DASY4, V4.7 Build 55; Postprocessing SW: SEMCAD, V1.8 Build 176

System Performance Check at 2000MHz/Area Scan (61x71x1):

Measurement grid: dx=15mm,

dy=15mm

Maximum value of SAR (interpolated) = 12.7 mW/g

System Performance Check at 2000MHz/Zoom Scan (7x7x7)/Cube 0:

Measurement grid: dx=5mm,

dy=5mm, dz=5mm

Reference Value = 94.6 V/m; Power Drift = -0.023 dB

Peak SAR (extrapolated) = 18.1 W/kg

SAR(1 g) = 10.7 mW/g; SAR(10 g) = 5.71 mW/g

Maximum value of SAR (measured) = 12.1 mW/g

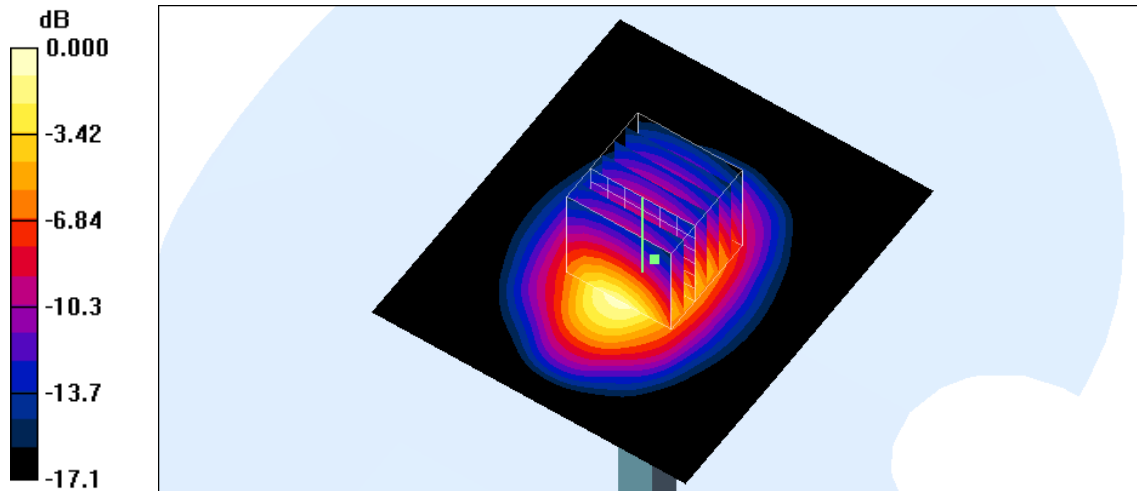

0 dB = 12.1mW/g



Z-axis Plot of System Performance Check

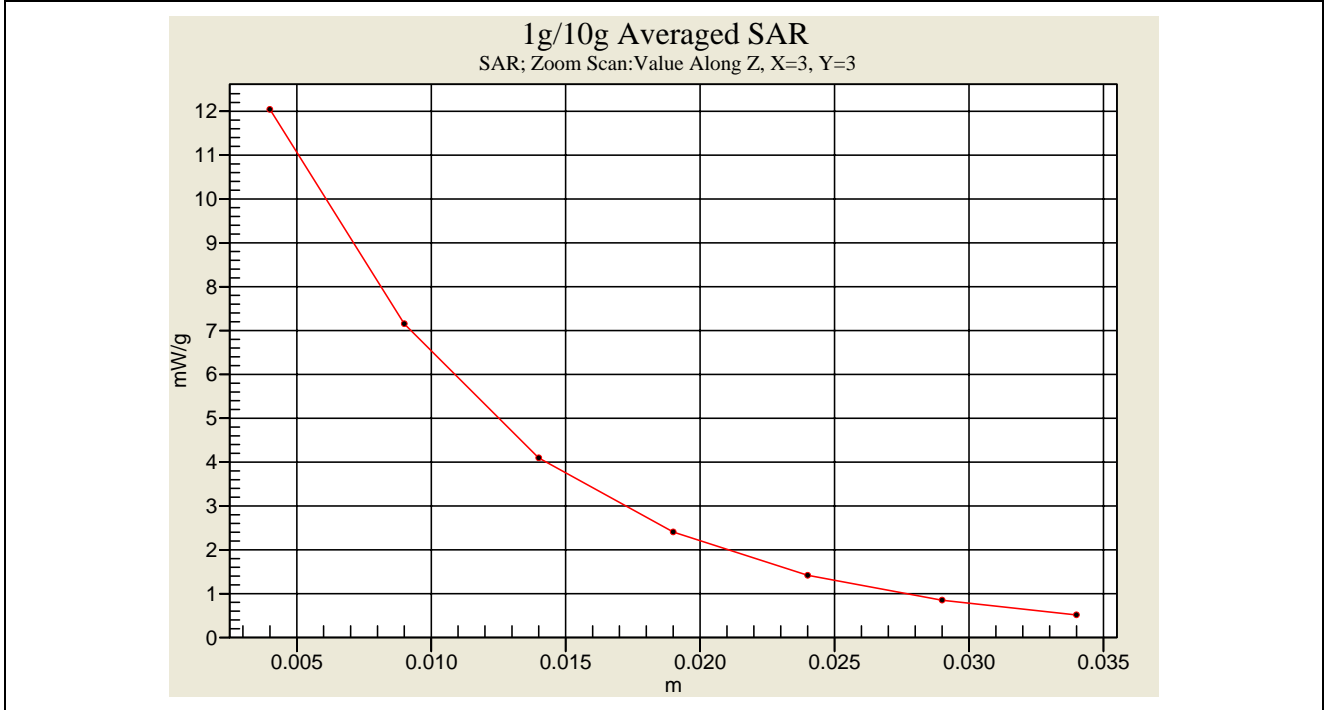

Head-Tissue-Simulating-Liquid 2GHz

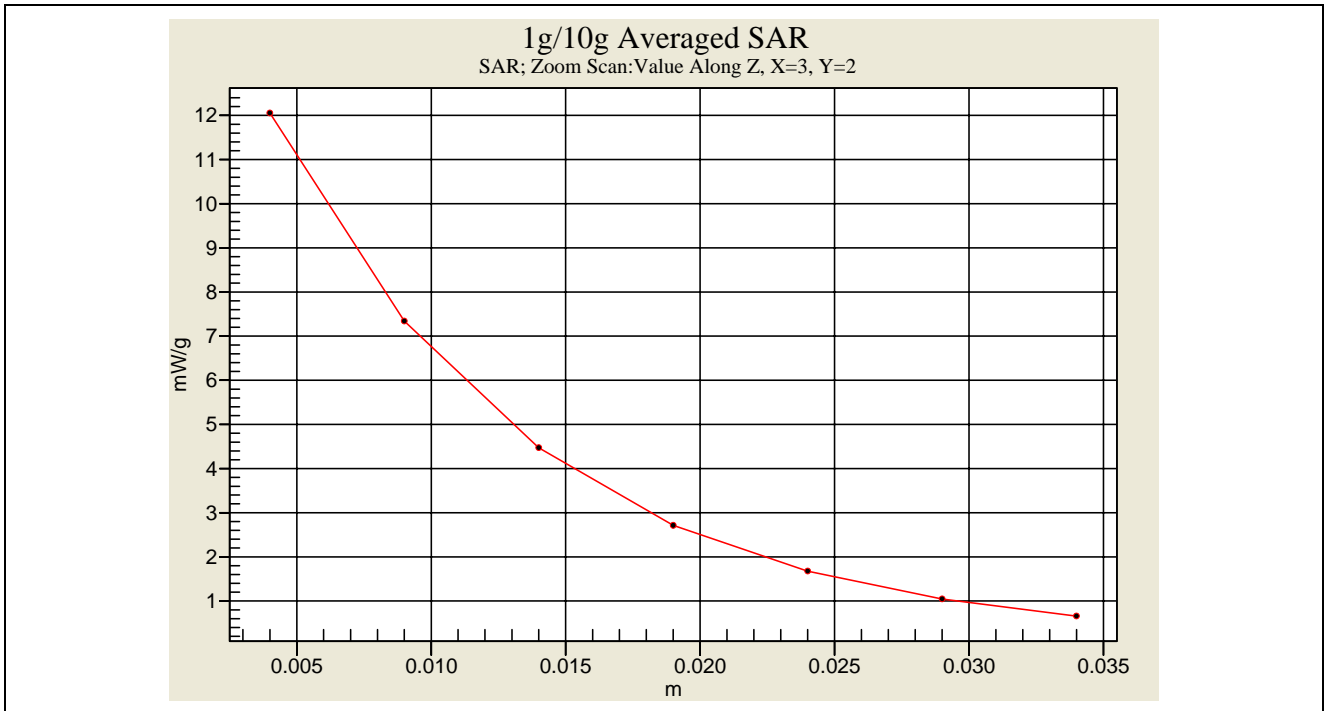

Body-Tissue-Simulating-Liquid 2GHz



Appendix B - SAR Measurement Data

See following Attached Pages for SAR Measurement Data.



Test Laboratory: A Test Lab Techno Corp. Date/Time: 12/19/2007 10:39:55 AM

RC_DECT CH0

DUT: LS6125-2; Type: DECT6.0 Cordless Phone; FCC ID: EW780-6270-00

Communication System: DECT; Frequency: 1928.448 MHz; Duty Cycle: 1:1

Medium parameters used (interpolated): $f = 1928.448$ MHz; $\sigma = 1.35$ mho/m; $\epsilon_r = 40.5$; $\rho = 1000$ kg/m³

Phantom section: Right Section

Measurement Standard: DAS4 (High Precision Assessment)

DASY4 Configuration:

- Probe: ET3DV6 - SN1531; ConvF(4.79, 4.79, 4.79); Calibrated: 1/22/2007
- Sensor-Surface: 4mm (Mechanical Surface Detection)
- Electronics: DAE4 Sn541; Calibrated: 11/15/2007
- Phantom: SAM 12; Type: SAM v4.0; Serial: TP:1009
- Measurement SW: DAS4, V4.7 Build 55; Postprocessing SW: SEMCAD, V1.8 Build 176

Right Cheek/Area Scan (71x131x1):

Measurement grid: dx=15mm, dy=15mm

Maximum value of SAR (interpolated) = 0.028 mW/g

Right Cheek/Zoom Scan (5x5x7)/Cube 0:

Measurement grid: dx=8mm, dy=8mm, dz=5mm

Reference Value = 3.76 V/m; Power Drift = -0.093 dB

Peak SAR (extrapolated) = 0.036 W/kg

SAR(1 g) = 0.022 mW/g; SAR(10 g) = 0.013 mW/g

Maximum value of SAR (measured) = 0.025 mW/g

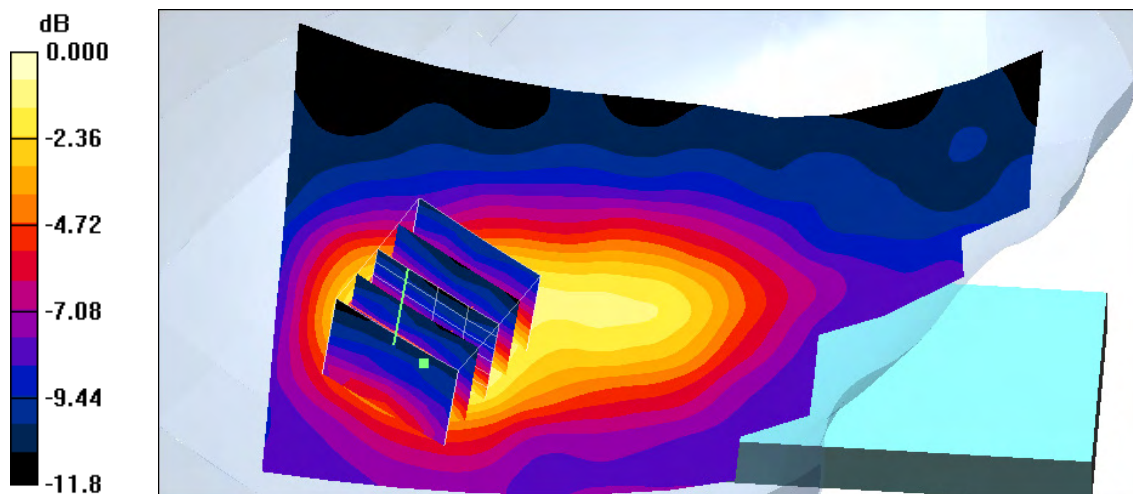



Test Laboratory: A Test Lab Techno Corp. Date/Time: 12/19/2007 11:01:41 AM

RC_DECT CH2

DUT: LS6125-2; Type: DECT6.0 Cordless Phone; FCC ID: EW780-6270-00

Communication System: DECT; Frequency: 1924.992 MHz; Duty Cycle: 1:1

Medium parameters used: $f = 1924.992$ MHz; $\sigma = 1.35$ mho/m; $\epsilon_r = 40.6$; $\rho = 1000$ kg/m³

Phantom section: Right Section

Measurement Standard: DAS4 (High Precision Assessment)

DASY4 Configuration:

- Probe: ET3DV6 - SN1531; ConvF(4.79, 4.79, 4.79); Calibrated: 1/22/2007
- Sensor-Surface: 4mm (Mechanical Surface Detection)
- Electronics: DAE4 Sn541; Calibrated: 11/15/2007
- Phantom: SAM 12; Type: SAM v4.0; Serial: TP:1009
- Measurement SW: DASY4, V4.7 Build 55; Postprocessing SW: SEMCAD, V1.8 Build 176

Right Cheek/Area Scan (61x131x1):

Measurement grid: dx=15mm, dy=15mm

Maximum value of SAR (interpolated) = 0.028 mW/g

Right Cheek/Zoom Scan (5x5x7)/Cube 0:

Measurement grid: dx=8mm, dy=8mm, dz=5mm

Reference Value = 3.35 V/m; Power Drift = 0.091 dB

Peak SAR (extrapolated) = 0.033 W/kg

SAR(1 g) = 0.021 mW/g; SAR(10 g) = 0.011 mW/g

Maximum value of SAR (measured) = 0.024 mW/g

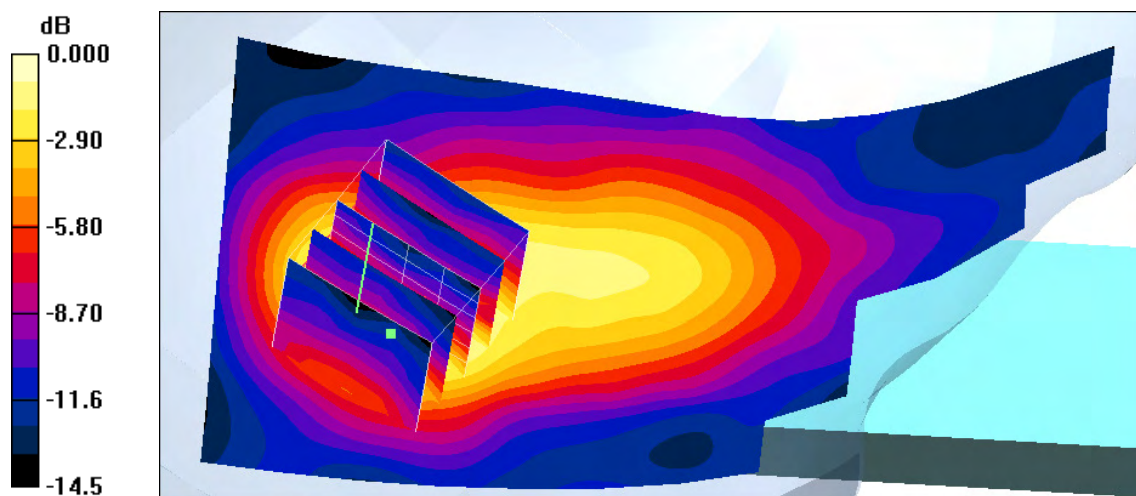

0 dB = 0.024mW/g



Test Laboratory: A Test Lab Techno Corp. Date/Time: 12/19/2007 11:21:19 AM

RC_DECT CH4

DUT: LS6125-2; Type: DECT6.0 Cordless Phone; FCC ID: EW780-6270-00

Communication System: DECT; Frequency: 1921.536 MHz; Duty Cycle: 1:1

Medium parameters used: $f = 1921.536$ MHz; $\sigma = 1.34$ mho/m; $\epsilon_r = 40.6$; $\rho = 1000$ kg/m³

Phantom section: Right Section

Measurement Standard: DASY4 (High Precision Assessment)

DASY4 Configuration:

- Probe: ET3DV6 - SN1531; ConvF(4.79, 4.79, 4.79); Calibrated: 1/22/2007
- Sensor-Surface: 4mm (Mechanical Surface Detection)
- Electronics: DAE4 Sn541; Calibrated: 11/15/2007
- Phantom: SAM 12; Type: SAM v4.0; Serial: TP:1009
- Measurement SW: DASY4, V4.7 Build 55; Postprocessing SW: SEMCAD, V1.8 Build 176

Right Cheek/Area Scan (61x131x1):

Measurement grid: dx=15mm, dy=15mm

Maximum value of SAR (interpolated) = 0.027 mW/g

Right Cheek/Zoom Scan (5x5x7)/Cube 0:

Measurement grid: dx=8mm, dy=8mm, dz=5mm

Reference Value = 3.35 V/m; Power Drift = -0.178 dB

Peak SAR (extrapolated) = 0.035 W/kg

SAR(1 g) = 0.020 mW/g; SAR(10 g) = 0.011 mW/g

Maximum value of SAR (measured) = 0.023 mW/g

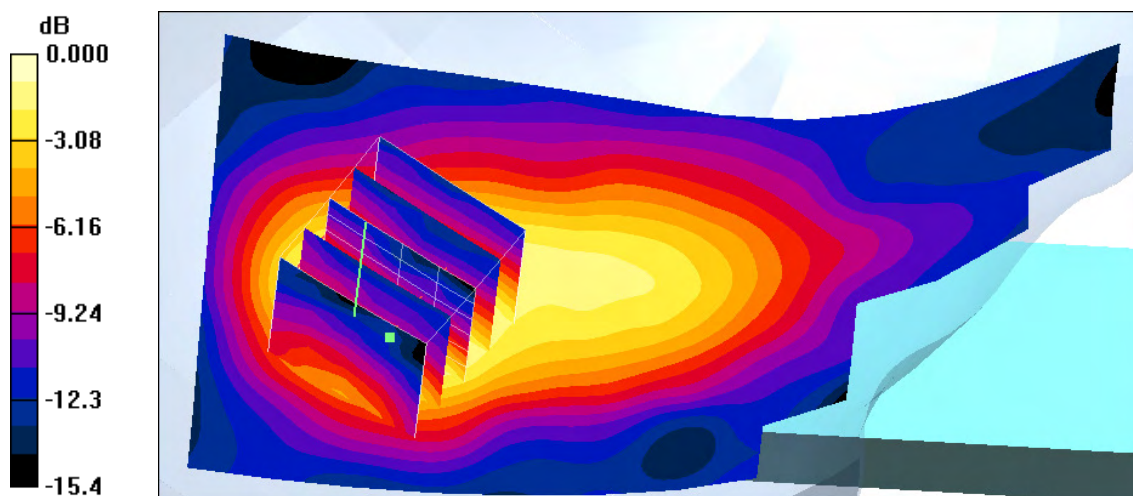

0 dB = 0.023mW/g



Test Laboratory: A Test Lab Techno Corp. Date/Time: 12/19/2007 11:42:56 AM

RT_DECT CH0

DUT: LS6125-2; Type: DECT6.0 Cordless Phone; FCC ID: EW780-6270-00

Communication System: DECT; Frequency: 1928.448 MHz; Duty Cycle: 1:1

Medium parameters used (interpolated): $f = 1928.448$ MHz; $\sigma = 1.35$ mho/m; $\epsilon_r = 40.5$; $\rho = 1000$ kg/m³

Phantom section: Right Section

Measurement Standard: DASYS4 (High Precision Assessment)

DASY4 Configuration:

- Probe: ET3DV6 - SN1531; ConvF(4.79, 4.79, 4.79); Calibrated: 1/22/2007
- Sensor-Surface: 4mm (Mechanical Surface Detection)
- Electronics: DAE4 Sn541; Calibrated: 11/15/2007
- Phantom: SAM 12; Type: SAM v4.0; Serial: TP:1009
- Measurement SW: DASYS4, V4.7 Build 55; Postprocessing SW: SEMCAD, V1.8 Build 176

Right Tilted/Area Scan (61x131x1):

Measurement grid: dx=15mm, dy=15mm

Maximum value of SAR (interpolated) = 0.021 mW/g

Right Tilted/Zoom Scan (5x5x7)/Cube 0:

Measurement grid: dx=8mm, dy=8mm, dz=5mm

Reference Value = 2.86 V/m; Power Drift = -0.187 dB

Peak SAR (extrapolated) = 0.031 W/kg

SAR(1 g) = 0.018 mW/g; SAR(10 g) = 0.00986 mW/g

Maximum value of SAR (measured) = 0.021 mW/g

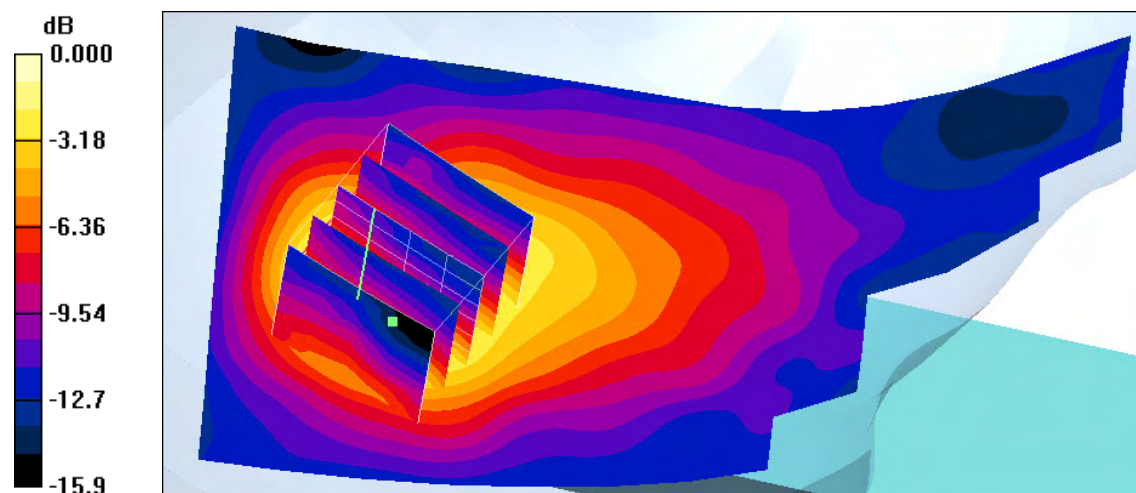

0 dB = 0.021mW/g



Test Laboratory: A Test Lab Techno Corp. Date/Time: 12/19/2007 12:06:50 PM

RT_DECT CH2

DUT: LS6125-2; Type: DECT6.0 Cordless Phone; FCC ID: EW780-6270-00

Communication System: DECT; Frequency: 1924.992 MHz; Duty Cycle: 1:1

Medium parameters used: $f = 1924.992$ MHz; $\sigma = 1.35$ mho/m; $\epsilon_r = 40.6$; $\rho = 1000$ kg/m³

Phantom section: Right Section

Measurement Standard: DASY4 (High Precision Assessment)

DASY4 Configuration:

- Probe: ET3DV6 - SN1531; ConvF(4.79, 4.79, 4.79); Calibrated: 1/22/2007
- Sensor-Surface: 4mm (Mechanical Surface Detection)
- Electronics: DAE4 Sn541; Calibrated: 11/15/2007
- Phantom: SAM 12; Type: SAM v4.0; Serial: TP:1009
- Measurement SW: DASY4, V4.7 Build 55; Postprocessing SW: SEMCAD, V1.8 Build 176

Right Tilted/Area Scan (61x131x1):

Measurement grid: dx=15mm, dy=15mm

Maximum value of SAR (interpolated) = 0.020 mW/g

Right Tilted/Zoom Scan (5x5x7)/Cube 0:

Measurement grid: dx=8mm, dy=8mm, dz=5mm

Reference Value = 2.76 V/m; Power Drift = -0.109 dB

Peak SAR (extrapolated) = 0.031 W/kg

SAR(1 g) = 0.018 mW/g; SAR(10 g) = 0.00928 mW/g

Maximum value of SAR (measured) = 0.020 mW/g

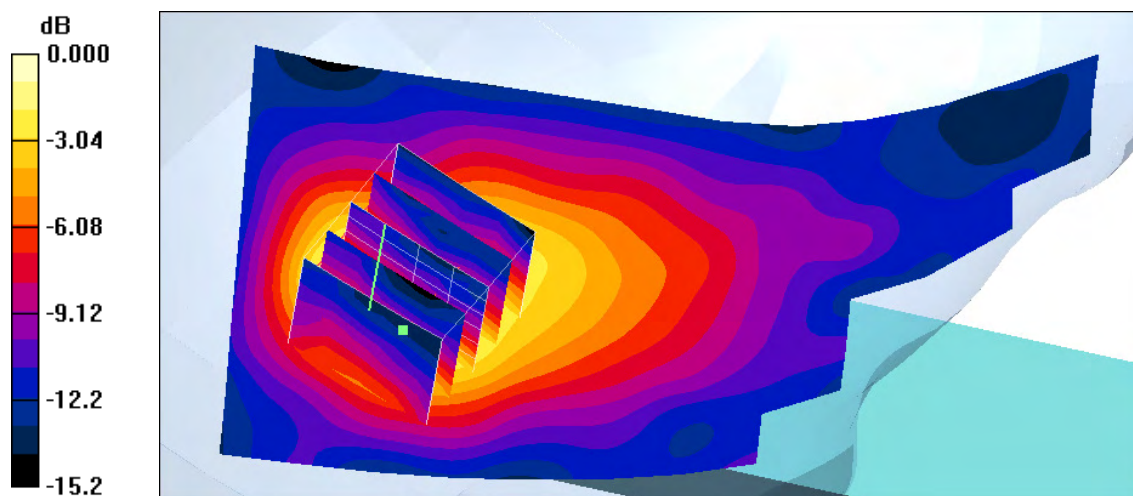

0 dB = 0.020mW/g



Test Laboratory: A Test Lab Techno Corp. Date/Time: 12/19/2007 12:30:53 PM

RT_DECT CH4

DUT: LS6125-2; Type: DECT6.0 Cordless Phone; FCC ID: EW780-6270-00

Communication System: DECT; Frequency: 1921.536 MHz; Duty Cycle: 1:1

Medium parameters used: $f = 1921.536$ MHz; $\sigma = 1.34$ mho/m; $\epsilon_f = 40.6$; $\rho = 1000$ kg/m³

Phantom section: Right Section

Measurement Standard: DASY4 (High Precision Assessment)

DASY4 Configuration:

- Probe: ET3DV6 - SN1531; ConvF(4.79, 4.79, 4.79); Calibrated: 1/22/2007
- Sensor-Surface: 4mm (Mechanical Surface Detection)
- Electronics: DAE4 Sn541; Calibrated: 11/15/2007
- Phantom: SAM 12; Type: SAM v4.0; Serial: TP:1009
- Measurement SW: DASY4, V4.7 Build 55; Postprocessing SW: SEMCAD, V1.8 Build 176

Right Tilted/Area Scan (61x131x1):

Measurement grid: dx=15mm, dy=15mm

Maximum value of SAR (interpolated) = 0.022 mW/g

Right Tilted/Zoom Scan (5x5x7)/Cube 0:

Measurement grid: dx=8mm, dy=8mm, dz=5mm

Reference Value = 2.87 V/m; Power Drift = 0.036 dB

Peak SAR (extrapolated) = 0.031 W/kg

SAR(1 g) = 0.019 mW/g; SAR(10 g) = 0.00992 mW/g

Maximum value of SAR (measured) = 0.022 mW/g

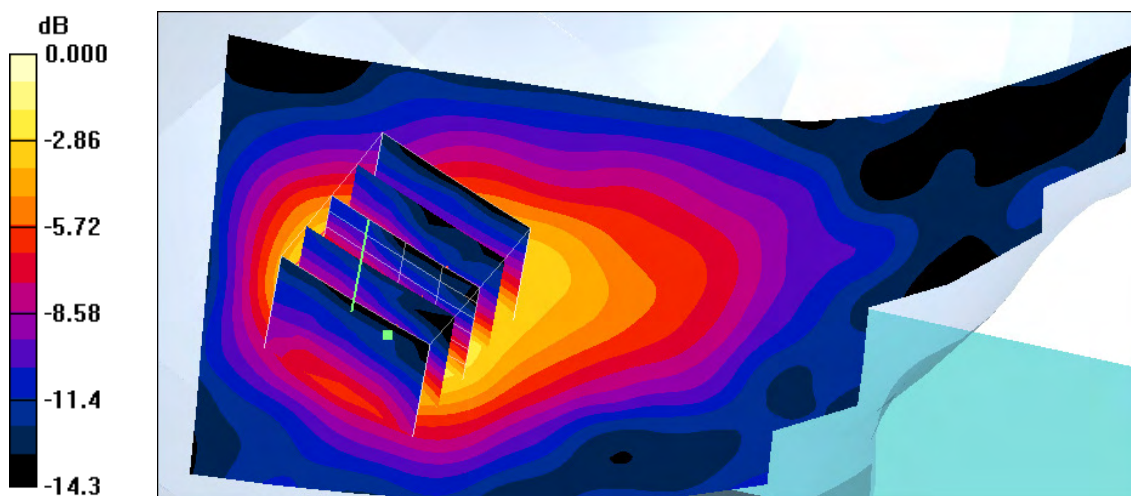

0 dB = 0.022mW/g



Test Laboratory: A Test Lab Techno Corp. Date/Time: 12/19/2007 1:51:36 PM

LC_DECT CH0

DUT: LS6125-2; Type: DECT6.0 Cordless Phone; FCC ID: EW780-6270-00

Communication System: DECT; Frequency: 1928.448 MHz; Duty Cycle: 1:1

Medium parameters used (interpolated): $f = 1928.448$ MHz; $\sigma = 1.35$ mho/m; $\epsilon_r = 40.5$; $\rho = 1000$ kg/m³

Phantom section: Left Section

Measurement Standard: DASY4 (High Precision Assessment)

DASY4 Configuration:

- Probe: ET3DV6 - SN1531; ConvF(4.79, 4.79, 4.79); Calibrated: 1/22/2007
- Sensor-Surface: 4mm (Mechanical Surface Detection)
- Electronics: DAE4 Sn541; Calibrated: 11/15/2007
- Phantom: SAM 12; Type: SAM v4.0; Serial: TP:1009
- Measurement SW: DASY4, V4.7 Build 55; Postprocessing SW: SEMCAD, V1.8 Build 176

Left Cheek/Area Scan (61x131x1):

Measurement grid: dx=15mm, dy=15mm

Maximum value of SAR (interpolated) = 0.029 mW/g

Left Cheek/Zoom Scan (5x5x7)/Cube 0:

Measurement grid: dx=8mm, dy=8mm, dz=5mm

Reference Value = 3.70 V/m; Power Drift = 0.067 dB

Peak SAR (extrapolated) = 0.038 W/kg

SAR(1 g) = 0.026 mW/g; SAR(10 g) = 0.015 mW/g

Maximum value of SAR (measured) = 0.029 mW/g

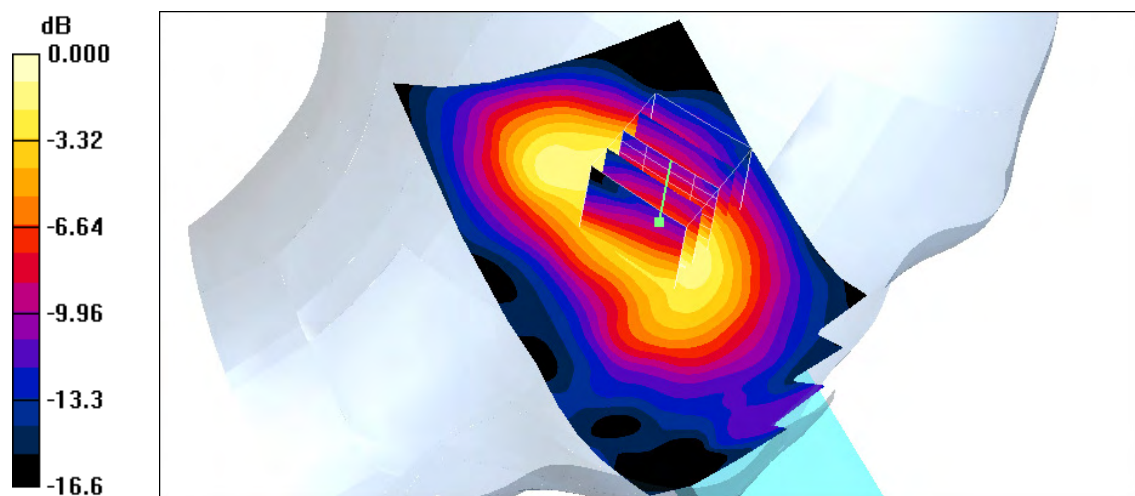

0 dB = 0.029mW/g



Test Laboratory: A Test Lab Techno Corp. Date/Time: 12/19/2007 1:27:27 PM

LC_DECT CH2

DUT: LS6125-2; Type: DECT6.0 Cordless Phone; FCC ID: EW780-6270-00

Communication System: DECT; Frequency: 1924.992 MHz; Duty Cycle: 1:1

Medium parameters used: $f = 1924.992$ MHz; $\sigma = 1.35$ mho/m; $\epsilon_r = 40.6$; $\rho = 1000$ kg/m³

Phantom section: Left Section

Measurement Standard: DASY4 (High Precision Assessment)

DASY4 Configuration:

- Probe: ET3DV6 - SN1531; ConvF(4.79, 4.79, 4.79); Calibrated: 1/22/2007
- Sensor-Surface: 4mm (Mechanical Surface Detection)
- Electronics: DAE4 Sn541; Calibrated: 11/15/2007
- Phantom: SAM 12; Type: SAM v4.0; Serial: TP:1009
- Measurement SW: DASY4, V4.7 Build 55; Postprocessing SW: SEMCAD, V1.8 Build 176

Left Cheek/Area Scan (61x131x1):

Measurement grid: dx=15mm, dy=15mm

Maximum value of SAR (interpolated) = 0.029 mW/g

Left Cheek/Zoom Scan (5x5x7)/Cube 0:

Measurement grid: dx=8mm, dy=8mm, dz=5mm

Reference Value = 3.67 V/m; Power Drift = -0.001 dB

Peak SAR (extrapolated) = 0.038 W/kg

SAR(1 g) = 0.026 mW/g; SAR(10 g) = 0.015 mW/g

Maximum value of SAR (measured) = 0.028 mW/g

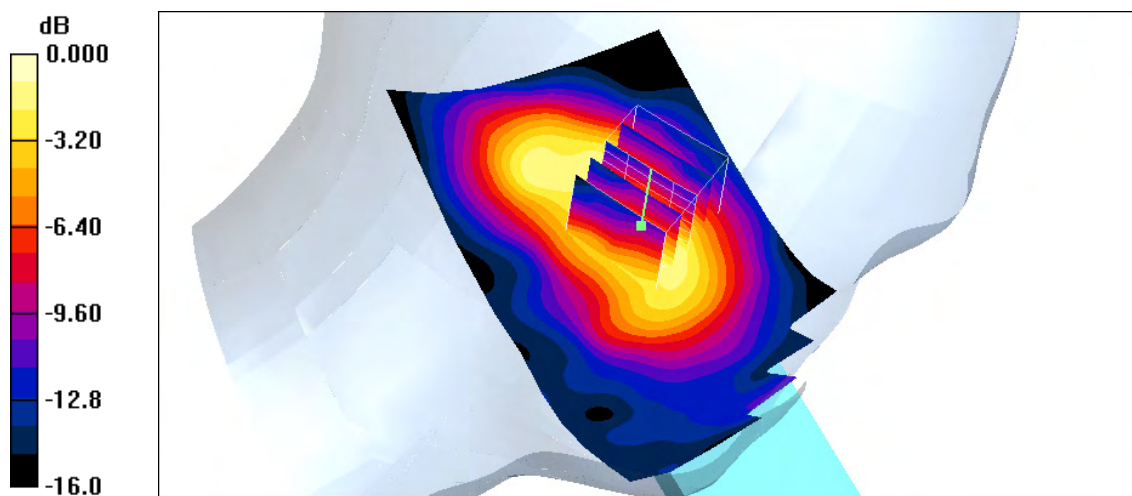

0 dB = 0.028mW/g



Test Laboratory: A Test Lab Techno Corp. Date/Time: 12/19/2007 1:01:52 PM

LC_DECT CH4

DUT: LS6125-2; Type: DECT6.0 Cordless Phone; FCC ID: EW780-6270-00

Communication System: DECT; Frequency: 1921.536 MHz; Duty Cycle: 1:1

Medium parameters used: $f = 1921.536$ MHz; $\sigma = 1.34$ mho/m; $\epsilon_r = 40.6$; $\rho = 1000$ kg/m³

Phantom section: Left Section

Measurement Standard: DASYS4 (High Precision Assessment)

DASY4 Configuration:

- Probe: ET3DV6 - SN1531; ConvF(4.79, 4.79, 4.79); Calibrated: 1/22/2007
- Sensor-Surface: 4mm (Mechanical Surface Detection)
- Electronics: DAE4 Sn541; Calibrated: 11/15/2007
- Phantom: SAM 12; Type: SAM v4.0; Serial: TP:1009
- Measurement SW: DASYS4, V4.7 Build 55; Postprocessing SW: SEMCAD, V1.8 Build 176

Left Cheek/Area Scan (61x131x1):

Measurement grid: dx=15mm, dy=15mm

Maximum value of SAR (interpolated) = 0.029 mW/g

Left Cheek/Zoom Scan (5x5x7)/Cube 0:

Measurement grid: dx=8mm, dy=8mm, dz=5mm

Reference Value = 3.67 V/m; Power Drift = 0.022 dB

Peak SAR (extrapolated) = 0.037 W/kg

SAR(1 g) = 0.025 mW/g; SAR(10 g) = 0.015 mW/g

Maximum value of SAR (measured) = 0.027 mW/g

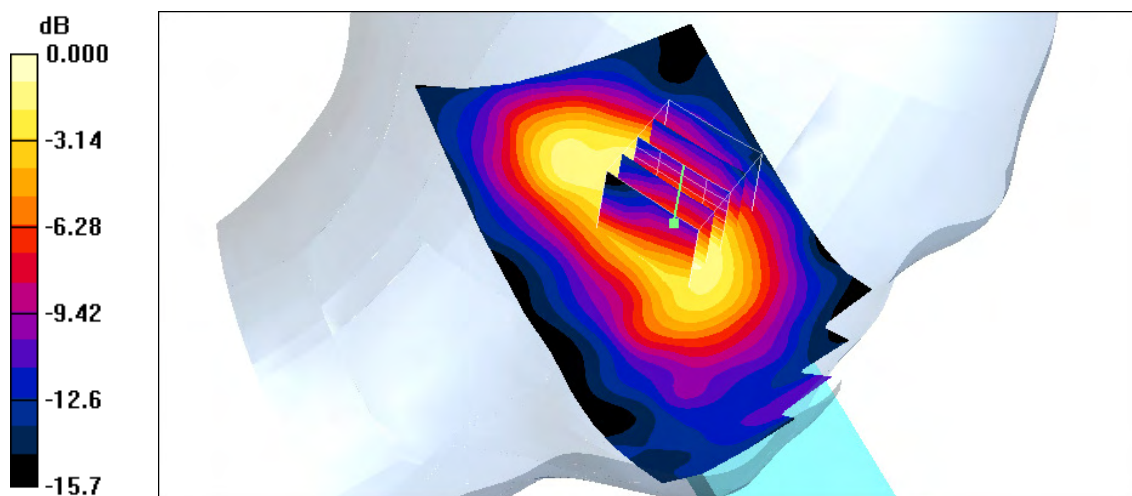

0 dB = 0.027mW/g



Test Laboratory: A Test Lab Techno Corp. Date/Time: 12/19/2007 2:18:55 PM

LT_DECT CH0

DUT: LS6125-2; Type: DECT6.0 Cordless Phone; FCC ID: EW780-6270-00

Communication System: DECT; Frequency: 1928.448 MHz; Duty Cycle: 1:1

Medium parameters used (interpolated): $f = 1928.448$ MHz; $\sigma = 1.35$ mho/m; $\epsilon_r = 40.5$; $\rho = 1000$ kg/m³

Phantom section: Left Section

Measurement Standard: DASY4 (High Precision Assessment)

DASY4 Configuration:

- Probe: ET3DV6 - SN1531; ConvF(4.79, 4.79, 4.79); Calibrated: 1/22/2007
- Sensor-Surface: 4mm (Mechanical Surface Detection)
- Electronics: DAE4 Sn541; Calibrated: 11/15/2007
- Phantom: SAM 12; Type: SAM v4.0; Serial: TP:1009
- Measurement SW: DASY4, V4.7 Build 55; Postprocessing SW: SEMCAD, V1.8 Build 176

Left Tilted/Area Scan (61x131x1):

Measurement grid: dx=15mm, dy=15mm

Maximum value of SAR (interpolated) = 0.022 mW/g

Left Tilted/Zoom Scan (5x5x7)/Cube 0:

Measurement grid: dx=8mm, dy=8mm, dz=5mm

Reference Value = 3.28 V/m; Power Drift = -0.034 dB

Peak SAR (extrapolated) = 0.031 W/kg

SAR(1 g) = 0.019 mW/g; SAR(10 g) = 0.00987 mW/g

Maximum value of SAR (measured) = 0.021 mW/g

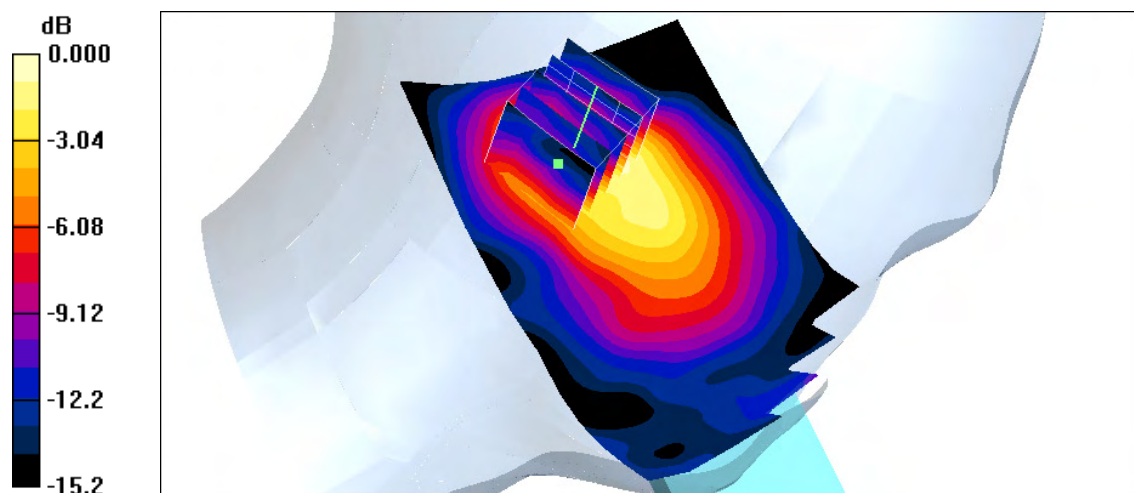

0 dB = 0.021mW/g



Test Laboratory: A Test Lab Techno Corp. Date/Time: 12/19/2007 2:38:18 PM

LT_DECT CH2

DUT: LS6125-2; Type: DECT6.0 Cordless Phone; FCC ID: EW780-6270-00

Communication System: DECT; Frequency: 1924.992 MHz; Duty Cycle: 1:1

Medium parameters used: $f = 1924.992$ MHz; $\sigma = 1.35$ mho/m; $\epsilon_f = 40.6$; $\rho = 1000$ kg/m³

Phantom section: Left Section

Measurement Standard: DASY4 (High Precision Assessment)

DASY4 Configuration:

- Probe: ET3DV6 - SN1531; ConvF(4.79, 4.79, 4.79); Calibrated: 1/22/2007
- Sensor-Surface: 4mm (Mechanical Surface Detection)
- Electronics: DAE4 Sn541; Calibrated: 11/15/2007
- Phantom: SAM 12; Type: SAM v4.0; Serial: TP:1009
- Measurement SW: DASY4, V4.7 Build 55; Postprocessing SW: SEMCAD, V1.8 Build 176

Left Tilted/Area Scan (61x131x1):

Measurement grid: dx=15mm, dy=15mm

Maximum value of SAR (interpolated) = 0.022 mW/g

Left Tilted/Zoom Scan (5x5x7)/Cube 0:

Measurement grid: dx=8mm, dy=8mm, dz=5mm

Reference Value = 3.35 V/m; Power Drift = -0.033 dB

Peak SAR (extrapolated) = 0.029 W/kg

SAR(1 g) = 0.018 mW/g; SAR(10 g) = 0.00988 mW/g

Maximum value of SAR (measured) = 0.020 mW/g

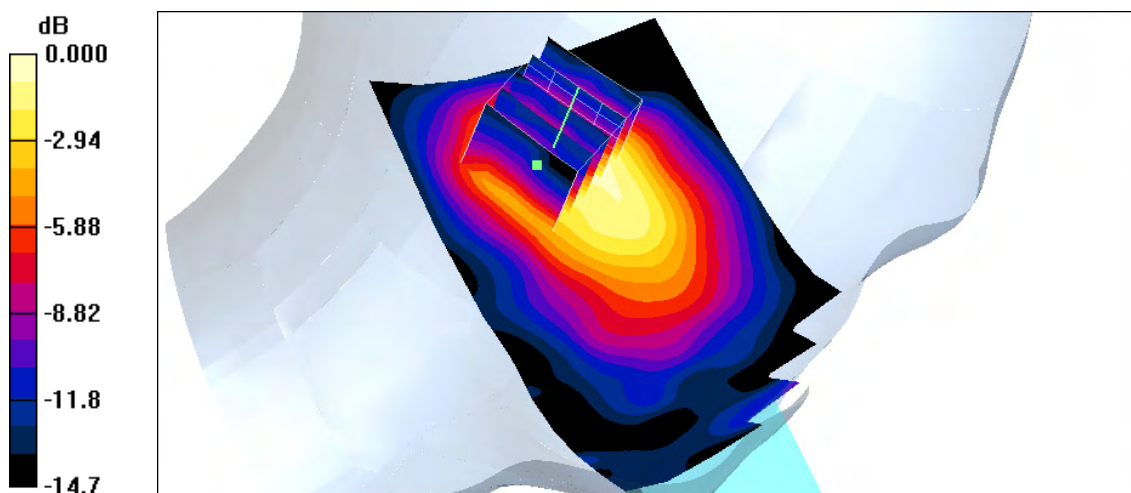

0 dB = 0.020mW/g



Test Laboratory: A Test Lab Techno Corp. Date/Time: 12/19/2007 2:57:47 PM

LT_DECT CH4

DUT: LS6125-2; Type: DECT6.0 Cordless Phone; FCC ID: EW780-6270-00

Communication System: DECT; Frequency: 1921.536 MHz; Duty Cycle: 1:1

Medium parameters used: $f = 1921.536$ MHz; $\sigma = 1.34$ mho/m; $\epsilon_f = 40.6$; $\rho = 1000$ kg/m³

Phantom section: Left Section

Measurement Standard: DASY4 (High Precision Assessment)

DASY4 Configuration:

- Probe: ET3DV6 - SN1531; ConvF(4.79, 4.79, 4.79); Calibrated: 1/22/2007
- Sensor-Surface: 4mm (Mechanical Surface Detection)
- Electronics: DAE4 Sn541; Calibrated: 11/15/2007
- Phantom: SAM 12; Type: SAM v4.0; Serial: TP:1009
- Measurement SW: DASY4, V4.7 Build 55; Postprocessing SW: SEMCAD, V1.8 Build 176

Left Tilted/Area Scan (61x131x1):

Measurement grid: dx=15mm, dy=15mm

Maximum value of SAR (interpolated) = 0.021 mW/g

Left Tilted/Zoom Scan (5x5x7)/Cube 0:

Measurement grid: dx=8mm, dy=8mm, dz=5mm

Reference Value = 3.31 V/m; Power Drift = -0.077 dB

Peak SAR (extrapolated) = 0.031 W/kg

SAR(1 g) = 0.018 mW/g; SAR(10 g) = 0.00953 mW/g

Maximum value of SAR (measured) = 0.020 mW/g

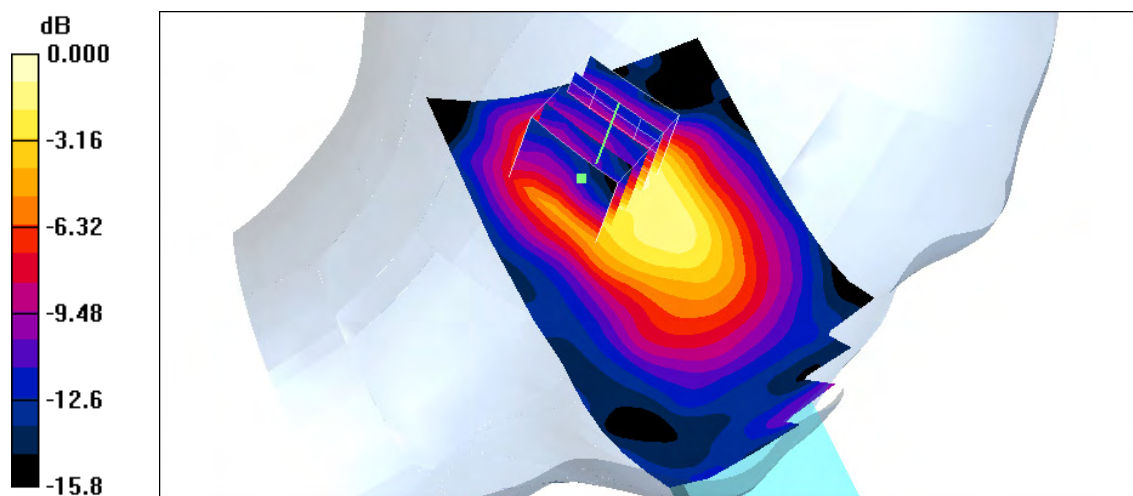

0 dB = 0.020mW/g



Test Laboratory: A Test Lab Techno Corp. Date/Time: 12/19/2007 5:07:40 PM

Flat_DECT CH0

DUT: LS6125-2; Type: DECT6.0 Cordless Phone; FCC ID: EW780-6270-00

Communication System: DECT; Frequency: 1928.448 MHz; Duty Cycle: 1:1

Medium parameters used (interpolated): $f = 1928.448$ MHz; $\sigma = 1.46$ mho/m; $\epsilon_r = 53.7$; $\rho = 1000$ kg/m³

Phantom section: Flat Section

Measurement Standard: DASY4 (High Precision Assessment)

DASY4 Configuration:

- Probe: ET3DV6 - SN1531; ConvF(4.39, 4.39, 4.39); Calibrated: 1/22/2007
- Sensor-Surface: 4mm (Mechanical Surface Detection)
- Electronics: DAE4 Sn541; Calibrated: 11/15/2007
- Phantom: SAM 12; Type: SAM v4.0; Serial: TP:1009
- Measurement SW: DASY4, V4.7 Build 55; Postprocessing SW: SEMCAD, V1.8 Build 176

Flat/Area Scan (61x131x1):

Measurement grid: dx=15mm, dy=15mm

Maximum value of SAR (interpolated) = 0.063 mW/g

Flat/Zoom Scan (5x5x7)/Cube 0:

Measurement grid: dx=8mm, dy=8mm, dz=5mm

Reference Value = 3.70 V/m; Power Drift = -0.099 dB

Peak SAR (extrapolated) = 0.087 W/kg

SAR(1 g) = 0.045 mW/g; SAR(10 g) = 0.022 mW/g

Maximum value of SAR (measured) = 0.054 mW/g

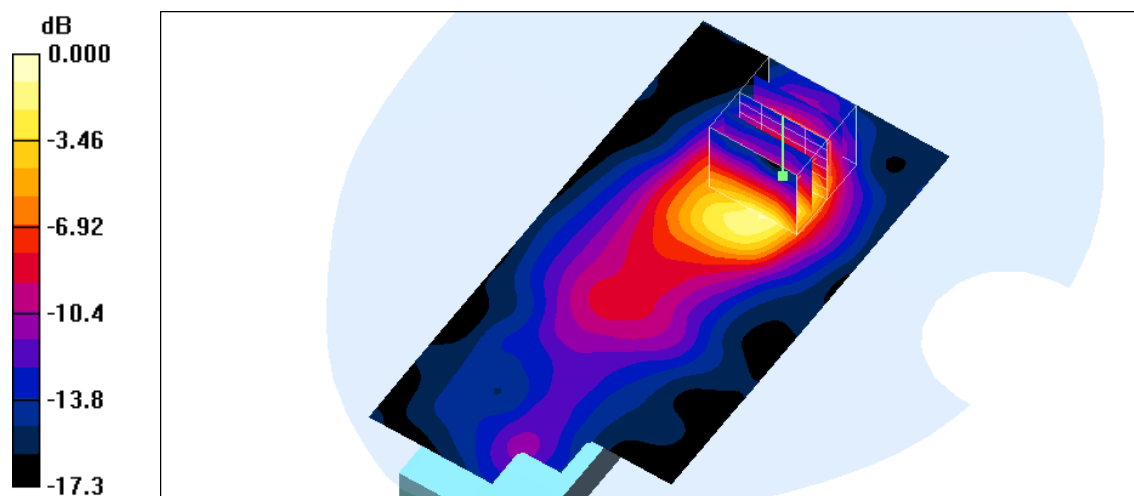



Test Laboratory: A Test Lab Techno Corp. Date/Time: 12/19/2007 5:25:38 PM

Flat_DECT CH2

DUT: LS6125-2; Type: DECT6.0 Cordless Phone; FCC ID: EW780-6270-00

Communication System: DECT; Frequency: 1924.992 MHz; Duty Cycle: 1:1

Medium parameters used: $f = 1924.992$ MHz; $\sigma = 1.46$ mho/m; $\epsilon_f = 53.7$; $\rho = 1000$ kg/m³

Phantom section: Flat Section

Measurement Standard: DASY4 (High Precision Assessment)

DASY4 Configuration:

- Probe: ET3DV6 - SN1531; ConvF(4.39, 4.39, 4.39); Calibrated: 1/22/2007
- Sensor-Surface: 4mm (Mechanical Surface Detection)
- Electronics: DAE4 Sn541; Calibrated: 11/15/2007
- Phantom: SAM 12; Type: SAM v4.0; Serial: TP:1009
- Measurement SW: DASY4, V4.7 Build 55; Postprocessing SW: SEMCAD, V1.8 Build 176

Flat/Area Scan (61x131x1):

Measurement grid: dx=15mm, dy=15mm

Maximum value of SAR (interpolated) = 0.050 mW/g

Flat/Zoom Scan (5x5x7)/Cube 0:

Measurement grid: dx=8mm, dy=8mm, dz=5mm

Reference Value = 3.49 V/m; Power Drift = -0.021 dB

Peak SAR (extrapolated) = 0.077 W/kg

SAR(1 g) = 0.040 mW/g; SAR(10 g) = 0.020 mW/g

Maximum value of SAR (measured) = 0.048 mW/g

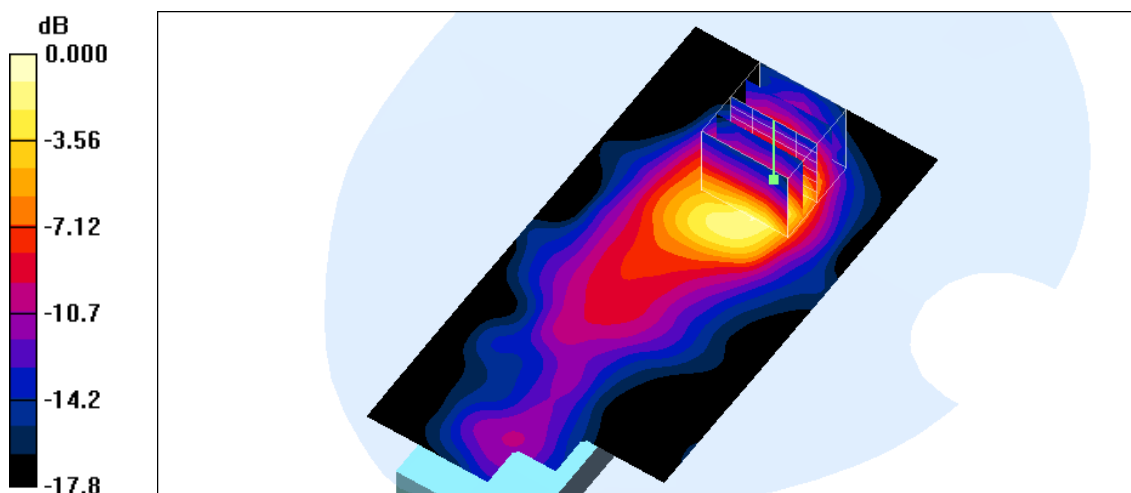

0 dB = 0.048mW/g



Test Laboratory: A Test Lab Techno Corp. Date/Time: 12/19/2007 5:47:54 PM

Flat_DECT CH4

DUT: LS6125-2; Type: DECT6.0 Cordless Phone; FCC ID: EW780-6270-00

Communication System: DECT; Frequency: 1921.536 MHz; Duty Cycle: 1:1

Medium parameters used: $f = 1921.536$ MHz; $\sigma = 1.45$ mho/m; $\epsilon_f = 53.7$; $\rho = 1000$ kg/m³

Phantom section: Flat Section

Measurement Standard: DASY4 (High Precision Assessment)

DASY4 Configuration:

- Probe: ET3DV6 - SN1531; ConvF(4.39, 4.39, 4.39); Calibrated: 1/22/2007
- Sensor-Surface: 4mm (Mechanical Surface Detection)
- Electronics: DAE4 Sn541; Calibrated: 11/15/2007
- Phantom: SAM 12; Type: SAM v4.0; Serial: TP:1009
- Measurement SW: DASY4, V4.7 Build 55; Postprocessing SW: SEMCAD, V1.8 Build 176

Flat/Area Scan (61x131x1):

Measurement grid: dx=15mm, dy=15mm

Maximum value of SAR (interpolated) = 0.047 mW/g

Flat/Zoom Scan (5x5x7)/Cube 0:

Measurement grid: dx=8mm, dy=8mm, dz=5mm

Reference Value = 3.48 V/m; Power Drift = 0.021 dB

Peak SAR (extrapolated) = 0.073 W/kg

SAR(1 g) = 0.039 mW/g; SAR(10 g) = 0.019 mW/g

Maximum value of SAR (measured) = 0.047 mW/g

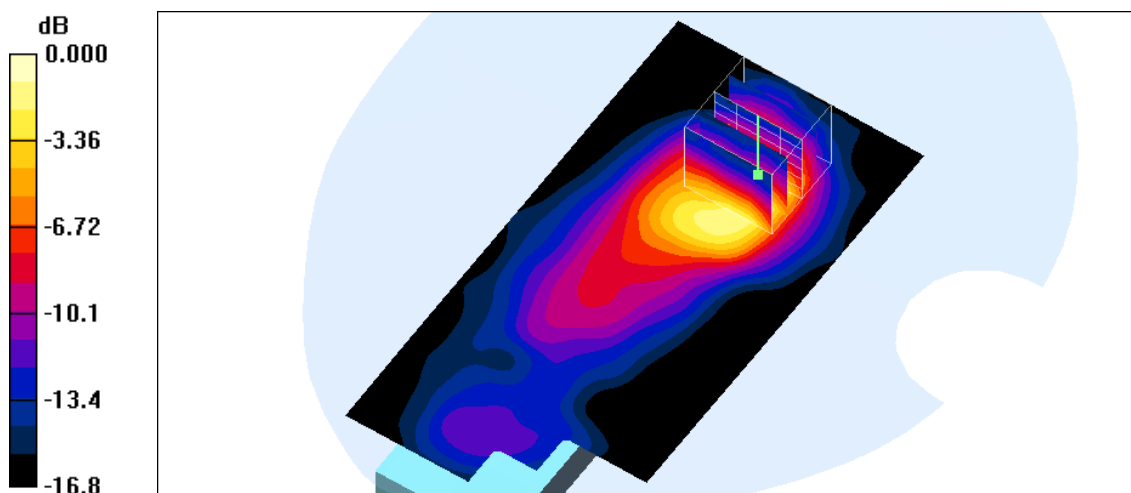



Z-axis Plot of SAR Measurement

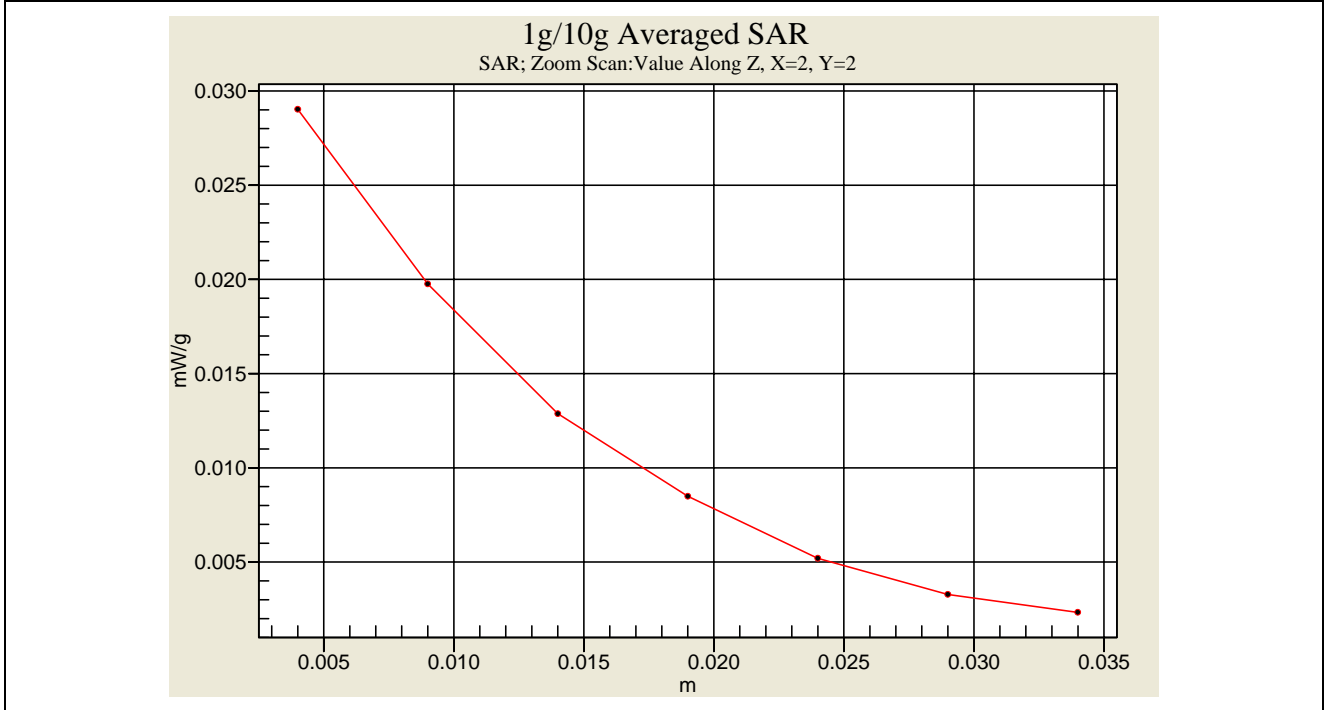

SAR Measurement _ Left Cheek CH0

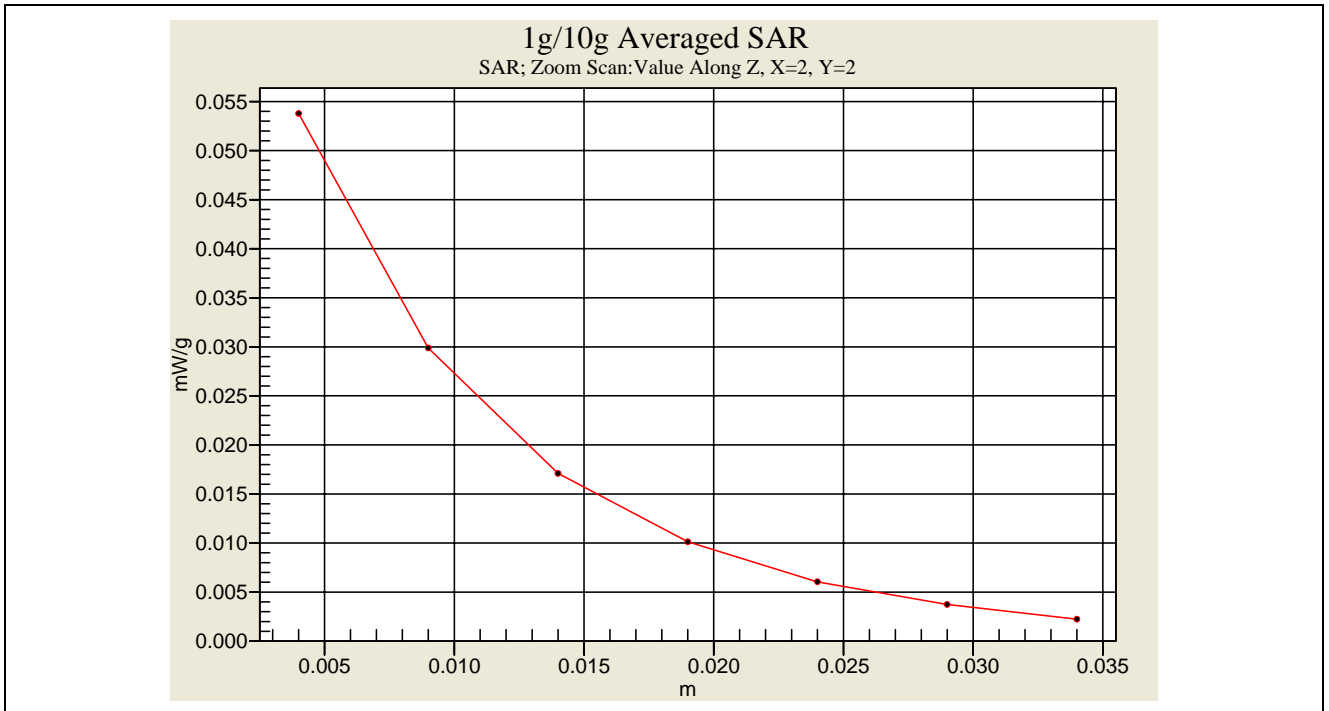

SAR Measurement _ Flat CH0



Appendix C - Calibration

All of the instruments Calibration information are listed below.

- Dipole _ D2000V2 SN:1008 Calibration No.D2000V2-1008_Feb07
- Probe _ ET3DV6 SN:1531 Calibration No.ET3-1531_Jan07
- DAE _ DAE4 SN:541 Calibration No.DAE4-541_Nov07