

CD440



www.philips.com/support

EN

Charge the handset(s) for 24 hours before use!

PHILIPS

Table of contents

1	Important Safety Instructions	3	4.6.3	How to make a 3-way conference call	15
1.1	Safety information	4	4.6.4	Caller Line Identification (CLI)	15
1.2	Power requirements	4	4.6.5	Call waiting	15
1.3	Battery requirements	4	4.7	How to find a handset	16
1.4	Telephone connection	5			
1.5	Safety precautions	5	5	Use more of your phone	17
1.6	Warranty	5	5.1	Call in progress	17
1.7	Conformity	5	5.1.1	Mute/Unmute microphone	17
1.8	Environmental care	5	5.1.2	How to adjust earpiece volume	17
			5.1.3	How to switch on the loudspeaker	17
2	Your phone	7	5.2	Phonebook	17
2.1	What's in the box	7	5.2.1	How to store a number in the phonebook	17
2.2	Overview of the phone	8	5.2.2	How to access the phonebook	17
2.2.1	Handset	8	5.2.3	How to edit a phonebook entry	17
2.2.2	Display icons on the handset	10	5.2.4	How to delete a phonebook entry	18
2.2.3	Base station	10	5.2.5	How to delete all phonebook entries	18
			5.2.6	How to store direct access memory	18
3	Getting started	11	5.2.7	How to transfer the phonebook	18
3.1	Connect the base station	11	5.3	Call log	19
3.2	Install rechargeable batteries	11	5.3.1	How to access the call log	19
3.3	Place the handset on the charging cradle	12	5.3.2	How to save call log entry to phonebook	19
3.4	Configure your phone	12	5.3.3	How to delete the call log entry	19
3.5	How to power off or on the handset power	12	5.3.4	How to delete the entire call log	19
			5.4	Redial list	19
4	Using your phone	13	5.4.1	How to access the redial list	19
4.1	Call	13	5.4.2	How to save a redial list entry to phonebook	20
4.1.1	How to make a call	13	5.4.3	How to delete a number from the redial list	20
4.1.2	How to answer a call	13	5.4.4	How to delete the entire redial list	20
4.1.3	How to answer a call in handsfree mode	13	5.5	Clock & alarm	20
4.1.4	How to end a call	13	5.5.1	How to set the time	20
4.1.5	Call timer	13	5.5.2	How to set an alarm	20
4.2	How to make a call from the call log	13	5.5.3	How to set the alarm tone	20
4.3	How to make a call from the phonebook	14	5.5.4	How to set the date and time format	20
4.4	How to make a call from the redial list	14	5.6	Personal settings	21
4.5	Flash	14	5.6.1	Handset tone	21
4.5.1	How to make a second call	14	5.6.2	How to adjust the contrast	22
4.5.2	How to answer a second call	14	5.6.3	How to rename the handset	22
4.6	How to use the intercom	14	5.6.4	How to set the auto pick-up	22
4.6.1	How to make an internal call	15	5.6.5	How to set the auto hang-up	22
4.6.2	How to transfer an external call to another handset	15			

5.6.6	How to set the menu language	22
5.6.7	How to turn on/off the keypad and LCD backlight	23
5.7	Advanced settings	23
5.7.1	How to select flash time	23
5.7.2	How to set the dial mode	23
5.7.3	Call barring	23
5.7.4	Baby call	24
5.7.5	How to manually select a base station	24
5.7.6	How to register an additional handset	24
5.7.7	How to unregister a handset	25
5.7.8	How to change the master PIN	25
5.7.9	How to reset to default settings	25
5.7.10	How to set the prefix number	25
5.7.11	Country setting	25
5.7.12	How to set conference mode on/off	26
5.8	Network services	26
5.8.1	Call forward	26
5.8.2	Voice mail	26
5.8.3	Information services from network operator	27
5.8.4	Call back	27
5.8.5	Cancel call back	27
5.8.6	Withhold ID	28
5.9	How to enter text and number	28
5.9.1	Entering text and digit	28
5.9.2	Switching between lowercase and uppercase	28
5.10	Default settings	29
5.11	Menu structure	30
6	Frequently asked questions	32
7	Index	34
FCC and IC statements		36
The RBRC® seal		38

1 Important Safety Instructions

Some of the following information may not apply to your particular product; however, when using telephone equipment, basic safety precautions should always be followed to reduce the risk of fire, electric shock and injury to persons, including the following :

- 1** Read and understand all instructions.
- 2** Follow all warnings and instructions marked on the product.
- 3** Unplug this product from the wall outlet before cleaning. Do not use liquid cleaners or aerosol cleaners. Use a damp cloth for cleaning.
- 4** Telephones should not be used while you are in a bathtub, shower or pool. Immersion of the telephone or handset in water could cause an electrical shock.
- 5** Slots and openings in the cabinet back or bottom are provided for ventilation, to protect it from overheating. These openings must not be blocked or covered. The openings should never be blocked by placing the product on the bed, sofa, rug, or other similar surface. This product should not be placed in a built-in installation unless proper ventilation is provided.
- 6** This product should be operated only from the type of power source indicated on the marking label. If you are not sure of the type of power supply to your home, consult your dealer or local power company.
- 7** Do not allow anything to rest on the power cord. Do not locate this product where the cord will be abused by persons walking on it.
- 8** Do not overload wall outlets and extension cords as this can result in the risk of fire or electric shock.
- 9** Never push objects of any kind into this product through cabinet slots as they may touch dangerous voltage points or short out parts that could result in a risk of fire or electric shock. Never spill liquid of any kind on the product.
- 10** To reduce the risk of electric shock, do not disassemble this product, but take it to a qualified service personnel when service or repair work is required. Opening or removing covers may expose you to dangerous voltages or other risks. Incorrect reassembly can cause electric shock when the appliance is subsequently used.
- 11** Do not expose the product to extreme temperatures such as areas near a hot radiator or stove or in a hot car.
- 12** Do not place lighted candles, cigarettes, cigars, etc., on the telephone.
- 13** Never touch uninsulated telephone wires or terminals unless the telephone line has been disconnected at the network interface.
- 14** Never install or modify telephone wiring during a lightning storm.
- 15** Never install telephone jacks in wet locations unless the jack is specifically designed for wet locations.
- 16** Use caution when installing or modifying telephone lines to prevent electrical shock and/or fire.
- 17** Unplug this product from the wall outlet and refer servicing to qualified service personnel under the following conditions:
 - A** When the power supply cord or plug is damaged or frayed.
 - B** If the product has been exposed to rain or water.
 - C** If the product does not operate normally by following the operating instructions.
 - D** If the product's cabinet has been damaged.
 - E** If the product exhibits a distinct change in performance.
- 18** Avoid using a telephone (other than a cordless type) during an electrical storm. There may be a remote risk of electric shock from lightning.
- 19** Do not use the telephone to report a gas leak in the vicinity of the leak.
- 20** Do not place this product on an unstable cart, stand or table. The product may fall, causing serious damage to the product.

IF YOUR PRODUCT UTILIZES BATTERIES, THE FOLLOWING ADDITIONAL PRECAUTIONS SHOULD BE OBSERVED :

- 1** Use only the type and size of battery(ies) specified in the user manual.
- 2** Do not dispose of the battery(ies) in fire. They may explode. Check with local codes for possible special disposal instructions.
- 3** Do not open or mutilate the battery(ies). Released electrolyte is corrosive and may cause damage to the eyes or skin. It may be toxic if swallowed.
- 4** Exercise care in handling battery(ies) in order not to short out the battery(ies) with conducting materials such as rings, bracelets, and keys. The battery(ies) or conductor may overheat and cause burns.
- 5** Do not attempt to recharge the battery(ies) provided with or identified for use with this product that are not intended to be charged. The battery(ies) may leak corrosive electrolyte or explode.
- 6** Do not attempt to rejuvenate the battery(ies) provided with or identified for use with this product by heating them. Sudden release of the battery(ies) electrolyte may occur causing burns or irritation to eyes or skin.
- 7** When replacing battery(ies), all batteries should be replaced at the same time. Mixing fresh and discharged batteries could increase internal cell pressure and rupture the discharged battery(ies). (Applies to products employing more than one separately replaceable primary battery.)
- 8** When inserting battery(ies) into this product, the proper polarity or direction must be observed. Reverse insertion of battery(ies) can cause charging, and that may result in leakage or explosion.
- 9** Remove battery(ies) from this product if storing over 30 days because the battery(ies) could leak and damage the product.
- 10** Discard “dead” battery(ies) as soon as possible since “dead” batteries are more likely to leak in a product.

- 11** Do not store this product, or the battery(ies) provided with or identified for use with this product, in high temperature areas. Batteries that are stored in a freezer or refrigerator for the purpose of extending shelf life should be protected from condensation during storage and defrosting. Batteries should be stabilized at room temperature prior to use after cold storage.
- 12** If your product uses rechargeable battery(ies), charge the battery(ies) only in accordance with the instructions and limitation specified in the User Manual.

SAVE THESE INSTRUCTIONS

1.1 Safety information

This telephone is not designed for making emergency telephone calls when the power fails. An alternative should be made available for access to emergency calling.

1.2 Power requirements

The product requires an electrical supply of 120 volts, single phase alternating current, excluding IT installations defined in standard EN UL 60950.

1.3 Battery requirements

The handset requires power source of two rechargeable NiMH batteries, size AAA 1.2V 750mAh (Hr11/45). IF THE INCORRECT TYPE OF BATTERIES ARE USED, A WARNING MESSAGE WILL BE DISPLAYED.

Use only Philips Multi-Life 750mAh rechargeable NiMH batteries.

For servicing or replacement, you can purchase a suitable headset through service centre or retail shop.

⚠ Warning

The electrical network is classified as dangerous according to criteria in the standard UL 60950. The only way to power down this product is by unplugging the power supply from the electrical outlet. Ensure the electrical outlet is located close to the apparatus and is always easily accessible.

1.4 Telephone connection

The voltage on the network is classified as TNV-3 (Telecommunication Network Voltages, as defined in the standard UL 60950). Following a power cut, the call in progress is lost.

1.5 Safety precautions

- Do not allow the handset to come into contact with liquids or moisture.
- Do not open the handset, base station or charger. This could expose you to high voltages.
- Do not allow the charging contacts of the charger or the battery to come into contact with extraneous conductive materials.
- There is a slight chance that the telephone could be damaged by an electrical storm. It is recommended that users unplug the phone from the USB socket and the phone line from the phone wall socket during a storm.
- Do not use the handset in an explosive hazard area such as where there is gas leaking.
- Young children should be supervised to ensure that they do not play with the telephone.
- Because the phone works by sending radio signals between the base unit and the handset, wearers of hearing aids may experience interference in the form of a humming noise.
- We advise that this phone should not be used near intensive care medical equipment or by persons with pacemakers.
- Your phone can interfere with electrical equipment such as answering machines, TV and radio sets if placed too close. It is recommended that you position the base unit at least one meter from such appliances.

Warning

Use only the mains adapter supplied with this telephone. Incorrect adapter polarity or voltage can seriously damage the unit.

Warning

RISK OF EXPLOSION IF BATTERY IS REPLACED BY AN INCORRECT TYPE.

Never use non-rechargeable batteries; use recommended type supplied with this telephone. NiMH batteries must be disposed of in accordance with the applicable waste disposal regulations.

FCC CERTIFICATION NUMBER IS LOCATED ON THE CABINET BOTTOM

The term „IC:“ before the certification number signifies that Industry Canada technical specifications were met. This certification means that the equipment meets certain radio communications and operational requirements. “This Class B digital apparatus complies with Canadian ICES-003.”

1.6 Warranty

The warranty informations are available on www.p4c.philips.com.

1.7 Conformity

The Declaration of conformity is available on www.p4c.philips.com.

1.8 Environmental care



Please remember to observe the local regulations regarding the disposal of your packaging materials, exhausted batteries and old phone and, where possible, promote their recycling.

Philips has marked the packaging with standard symbols designed to promote the recycling and appropriate disposal of your eventual waste.



A financial contribution has been paid to the associated national recovery & recycling system.



The labelled packaging material is recyclable.

IMPORTANTES MESURES DE SÉCURITÉ

Certaines mesures de sécurité doivent être prises pendant l'utilisation de matériel téléphonique afin de réduire les risques d'incendie, de choc électrique et de blessures.

En voici quelquesunes:

- 1** Ne pas utiliser l'appareil près de l'eau, p.ex., près d'une baignoire, d'un lavabo, d'un évier de cuisine, d'un bac à laver, dans un sous-sol humide ou près d'une piscine.
- 2** Éviter d'utiliser le téléphone (sauf s'il s'agit d'un appareil sans fil) pendant un orage électrique. Ceci peut présenter un risque de choc électrique causé par la foudre.
- 3** Ne pas utiliser l'appareil téléphonique pour signaler une fuite de gaz s'il est situé près de la fuite.
- 4** Utiliser seulement le cordon d'alimentation et le type de piles indiqués dans ce manuel. Ne pas jeter les piles dans le feu: elles peuvent exploser. Se conformer aux règlements pertinents quant à l'élimination des piles.
- 5** la socket-sortie sera installée près de l'équipement et sera facilement accessible
- 6** ATTENTION- Il y a danger d'explosion s'il y a remplacement incorrect de la batterie. Remplacer uniquement avec une batterie du même type ou d'un type équivalent recommandé par le constructeur. Mettre au rebut les batteries usagées conformément aux instructions du fabricant.
- 7** Pour l'entretien ou le remplacement, vous pouvez acheter un écouteur approprié par le centre commercial ou le magasin de détaillant.

CONSERVER CES INSTRUCTIONS

2 Your phone

2.1 What's in the box

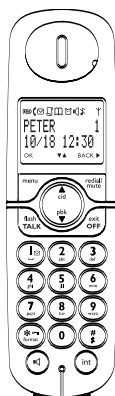

Telephone handset

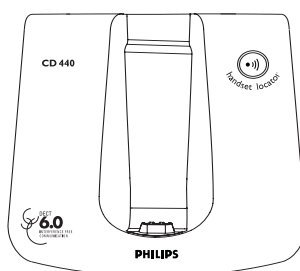

Base station

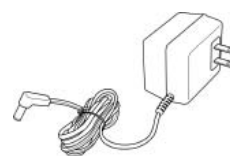

Power supply unit



Line cord (RJ11)



2xAAA Rechargeable
batteries



Quick start guide



User Manual



Warranty card

Note

The line adaptor may not be attached to the line cord. You may find the line adaptor in the box. In this case, you have to connect the line adaptor to the line cord first before plugging the line cord to the line socket.

In multihandset packs, you will find one or more additional handsets, chargers with power supply units and additional rechargeable batteries.

2.2 Overview of the phone

2.2.1 Handset

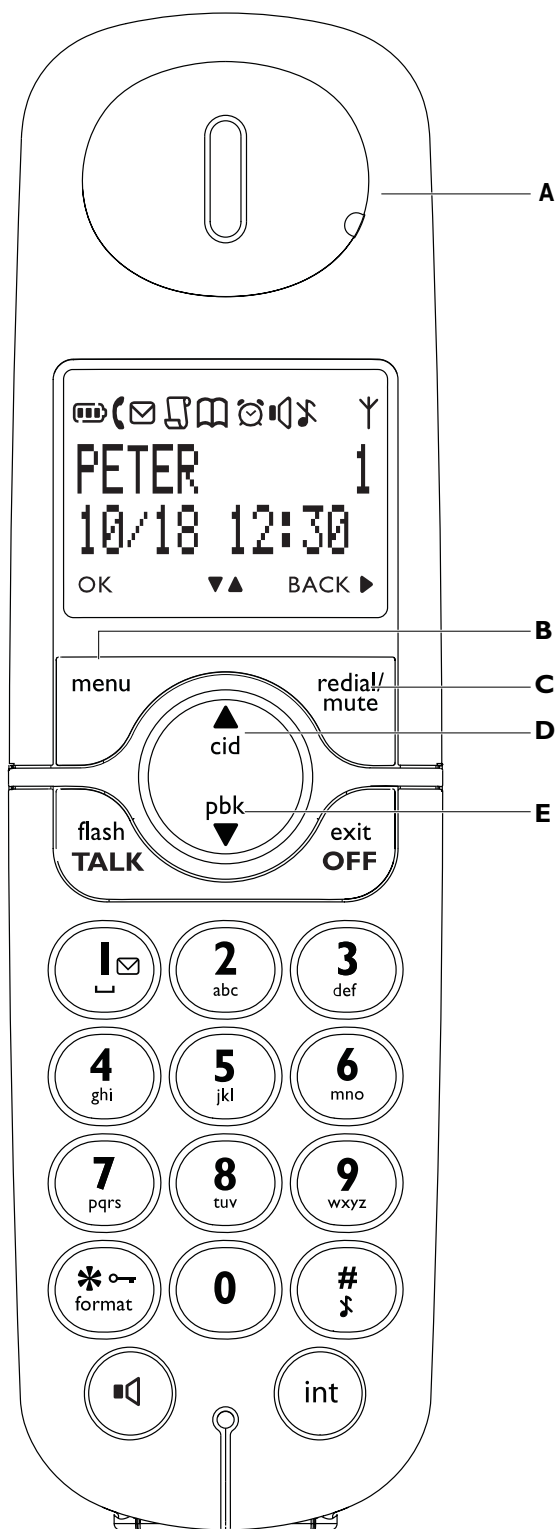

A Event LED

OFF: No new events

RED BLINKING: Unread events (example: a missed call if you have subscribed the Caller Line Identification Service (CLI) from your network provider.)

B Menu/OK key

In idle mode: Press to enter the main menu

In menu mode: Select the function displayed on the handset screen directly above it

C Redial/Mute/Next key

In idle mode: Press to access the redial list

In editing mode/predialling mode: Short press to delete one character/digit

In editing mode/predialling mode: Long press to delete all the characters/digits

During call connection: Press to mute the microphone

In menu mode: Press to go back to previous level

D Call log/Up key

In idle mode: Press to access call log

In menu mode: Press to scroll up the menu list

In phonebook/call log/Redial reviewing mode: Press to scroll up to other entries

During call connection: Press to increase earpiece volume

In editing mode: Press to go to the previous character or digit

E Phonebook/Down key

In idle mode: Press to access phonebook

In menu mode: Press to scroll down the menu list

In phonebook/call log/redial reviewing mode: Press to scroll down to other entries

During call connection: Press to decrease earpiece volume

In editing mode: Press to go to the next character or digit

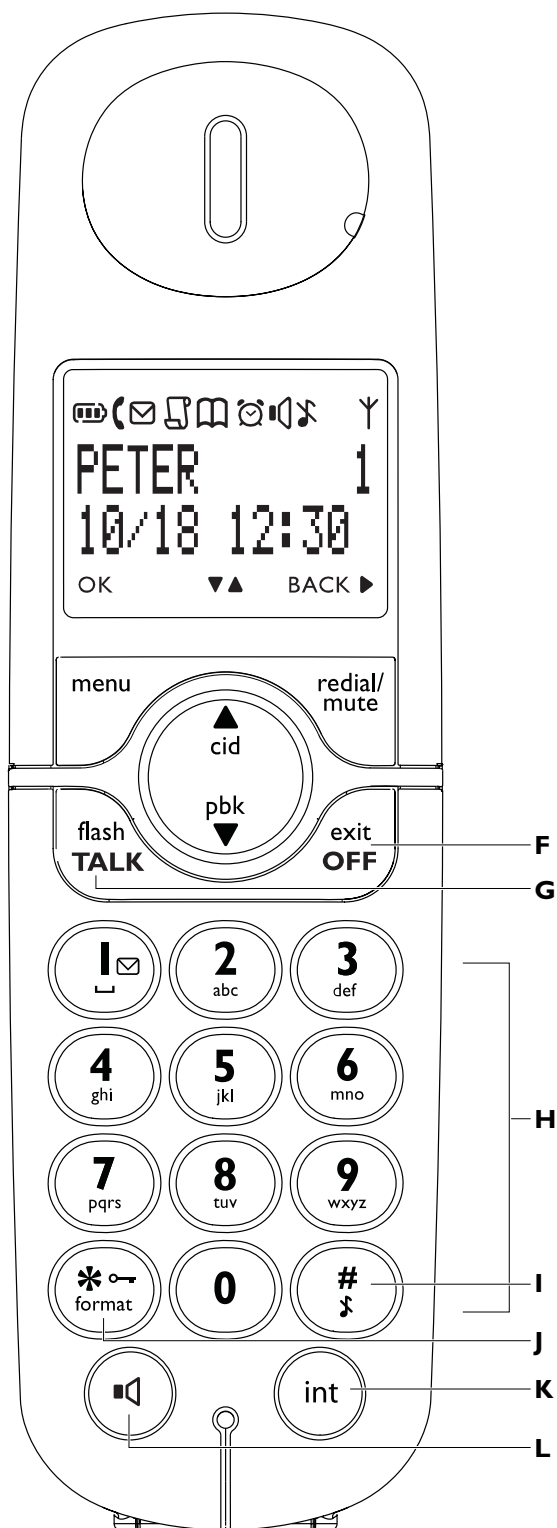

F Talk off/Exit key

In idle mode: Long press for about 5 seconds to power off the handset. If the handset is powered off, short press to power on the handset.

In menu mode: Long press to return to idle mode, short press to return to previous menu.

During call connection: Press to hang up a call

G Talk on/Flash key

In idle mode: Press to answer when there is an incoming external or internal call

During call connection: Press to insert flash for operator services

H Alphanumeric keypad

I Hash key

In idle/dialling mode: Short press to insert a #

In idle mode: Long press to mute the ringer

In dialling mode: Long press to enter a pause

In editing mode: Short press to switch between uppercase and lowercase

J Star/Format key

In idle/dialling mode: Short press to insert a *

In idle mode: Long press to activate or deactivate keypad lock

In call log reviewing mode: Press repeatedly to view the alternate dialling sequences

K Call Transfer/Intercom/conference

In idle mode: Short press to initiate an intercom call

During external call connection: Short press to initiate an internal call or switch call













between an internal call and an external call

Long press to initiate a conference call with an external call and another internal call

L Loudspeaker key

During call connection: Press to switch the loudspeaker on or off

2.2.2 Display icons on the handset

	Indicate battery level Display  when the battery is fully discharged Display  when the battery is running low Display  when the battery is partially charged Display  when the battery is fully charged Display battery icon animation during charging
	Display when the phone is in use. Blink during ringing.
	Blink when new voice mail messages are received and not read yet
	This feature is available if you have subscribed the Caller Line Identification service (CLI) with your network provider. Display when browsing the call log. Blink when missed calls are received if you have subscribed to Caller Line Identification (CLI)
	Display when browsing the phonebook
	Display when the alarm clock is turned on
	Display when the loudspeaker is turned on
	Display when the ringer is turned off
	Display when the handset is registered and within the range of the base station. Blink when the handset is out of range or is searching for a base.

2.2.3 Base station

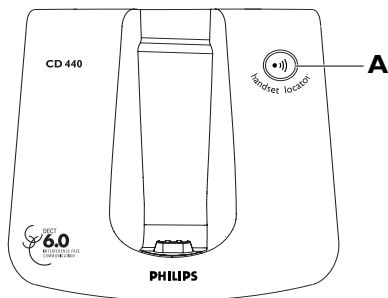

A Handset locator key

Press to locate the handset

Press and hold for three seconds to start registration procedure

3 Getting started

3.1 Connect the base station

⚠ Caution

Avoid placing the base station too close to large metal objects such as filing cabinets, radiators or electrical appliances. This can impair the range and sound quality. Buildings with thick internal and external walls may impair transmission of signals to and from the base.

⚠ Warning

Power is applied when the power adaptor is plugged into the unit and connected to the electricity socket. The only way to power down the unit is to unplug the power adaptor from the electricity socket. Therefore, ensure that the electricity socket is easily accessible.

The power adaptor and the telephone line cord have to be connected correctly, as incorrect connection could damage the unit. Always use the telephone line cord supplied with the unit. Otherwise, you may not get a dial tone.

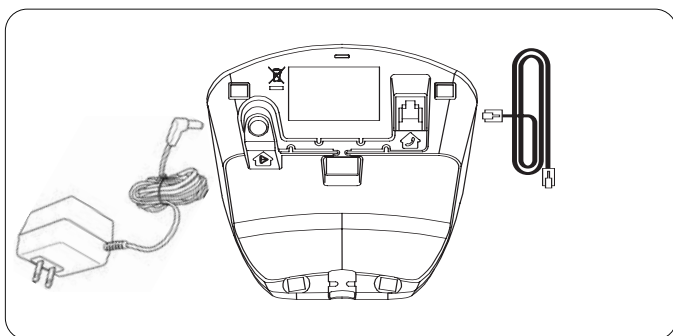

- 1** Insert the plug of the power cord into the socket under the base station.
- 2** Insert the plug of the line cord into the socket under the base station.

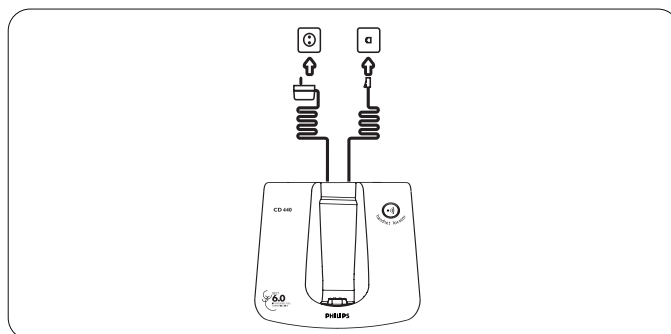

- 3** Connect the other end of the line cord to the telephone line socket and the other end of the power cable to the electricity socket.

ⓘ Note

The line adaptor may not be attached to the line cord. In this case, you have to connect the line adaptor to the line cord first before plugging the line cord to the line socket.

3.2 Install rechargeable batteries

Your CD440 is supplied with two rechargeable batteries. Before using the handset, install the batteries into the handset and fully charge them up.

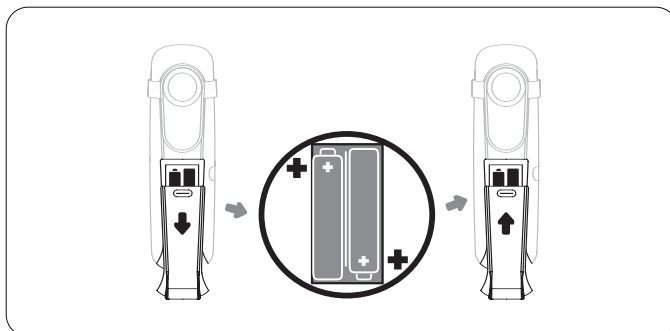

- 1** Slide out the battery cover
- 2** Place the batteries as indicated in the battery compartment and replace the battery cover.

3.3 Place the handset on the charging cradle

- 1 Place the handset on the charging cradle of the base station.
- 2 Leave it there until the batteries are fully charged.
- 3 When the handset is fully charged,  is displayed.

Note

When the battery is fully charged, the talk time of your phone is approximately 12 hours and the standby time is approximately 150 hours.

3.4 Configure your phone



Depending on your country, the **WELCOME** screen may not appear. In that case, you do not need to select the country code to configure your phone.

Before using your phone, you need to configure it according to the country of use. After charging it for a few minutes, the **WELCOME** screen appears. Follow these steps to configure your phone:

- 1 Press  to display the list of countries
 - Available country will display on the screen.

Note

If  is pressed, the handset will show the **WELCOME** screen again.

- 2 Press  /  to scroll to your country
- 3 Press  to confirm your selection
 - *Your phone is configured according to your selected country and back to idle screen.*

Note



Once the country is selected, the default line settings for the selected country will be applied to your phone automatically.

Tip

If you chose the country in use wrongly or would like to change the country after the first configuration, you can press  in idle mode to enter into the main menu, then input **##**793** to reset to default settings. After around 30 seconds, your phone will go back to **WELCOME** screen for you to select the country again.

3.5 How to power off or on the handset power

You can power off your handset in order to save battery power.

- 1 Press and hold  for about five seconds to power off the handset
- 2 Press  to power on the handset again

4 Using your phone

4.1 Call

4.1.1 How to make a call

4.1.1.1 Predialling

- 1 Enter the phone number (maximum 24 digits)
- 2 Press  to dial the number
 - *The call is initiated.*

4.1.1.2 Direct dialling

- 1 Press  to take the line
- 2 Enter the phone number
 - *The call is initiated.*

4.1.2 How to answer a call

When the phone rings, press .

- *The call is established.*

4.1.3 How to answer a call in handsfree mode

When the phone rings, press .

- *The call is established and  is on. You can talk to the caller without holding the handset.*

Warning

When the handset rings during an incoming call, please do not hold the handset too close to your ear as the volume of the ringing tone may damage your hearing.

Note

Incoming call has priority over other events. Whenever there is an incoming call, other status in progress such as phone settings, menu navigation, etc will be aborted.

Tip

If auto pick-up mode is activated, you can lift up the handset from its base station to answer the call.

4.1.4 How to end a call

Press  during a call connection

- *The call ends.*

OR

Put the handset on to the base station

- *The call ends.*





4.1.5 Call timer

The call timer shows the duration of your current call when you hang up your phone. It is shown in minutes and seconds format (MM:SS).

4.2 How to make a call from the call log

This feature is available if you have subscribed the Caller Line Identification service (CLI) with your network provider.

In idle mode:

- 1 Press  to select **CALL LIST**
- 2 Press 
- 3 Press / to scroll to your desired unanswered call

Note

The screen can either display:

- the caller's number*
- the caller's name (if matched with the phonebook)*
- **UNKNOWN** if it is an unidentified call**
- Availability of time and date information depends on the service providers
- * Subject to a subscription of CLI with your operator
- ** Unlisted numbers, withheld caller identification.





- 4 Press  to dial the number
 - *The call is initiated.*

Note





The latest unanswered call will display first and the oldest entry will be deleted when the memory is full.

4.3 How to make a call from the phonebook

In idle mode:





- 1 Press  to access the phonebook
- 2 Press  /  to select your desired phonebook entry
- 3 Press  to dial the number
 - *The call is initiated.*

Tip

Instead of pressing  or  to browse the phonebook entries, press the numeric key corresponding to the first letter of the phonebook entry that you wish to locate. For example, pressing  once will show the entries starting with A. Pressing  twice will show the entries starting with B.

4.4 How to make a call from the redial list

In idle mode:

- 1 Press  to access the redial list
 - *The display shows the last number dialed or the name if the dialed number is matched with the number stored in the phonebook.*
- 2 Press  /  to scroll to your desired entry
- 3 Press  to dial the number
 - *The call is initiated.*

Tip

The handset stores the last 10 numbers dialed. The last number dialed will appear first in the redial list. If the redial number matches a phonebook entry, the phonebook name will be displayed instead.





4.5 Flash

You can use the flash function to make or receive a second call. The operations mentioned in Section 4.5.1 and 4.5.2 may be varied by countries and local service providers. Subscribe and consult the details of flash operation of this service from your local service provider.



4.5.1 How to make a second call

To use this feature, you have to subscribe the service with your local service provider. You can use the flash function to make or receive a second call.

During a call:



- 1 Press  and  /  to select **INIT 2NDCALL**
- 3 Press  to dial your second call number
The second call is initiated.

Note



You can press  and  /  to select **SWITCH CALL** or **CONFERENCE** to switch calls between the first and second calls or to make a conference call.

4.5.2 How to answer a second call

To use this feature, you have to subscribe the service with your local service provider. If another call comes in during a call, you will hear a short beep periodically:

During displaying caller ID, press  and  /  to select functions to accept or reject the second call.

Note

After accepting the second call, you can press  and  /  to select **SWITCH CALL** or **CONFERENCE** to switch calls between the first and second calls or to make a conference call.

Note





If you have subscribed the Caller ID service, the caller ID of your callers will appear on the display.

4.6 How to use the intercom

This feature is only available when there are at least two registered handsets. It allows you to make internal calls, transfer external calls from one handset to another handset and make conference calls.

4.6.1 How to make an internal call

In idle mode:





- 1 Press 
 - The handsets available for intercom will be displayed
- 2 Press  /  to select your desired handset
- 3 Press  on the calling handset
 - Your desired handset rings.
- 4 Press  on the called handset
 - The intercom is established.

Note

If the called handset is busy, a busy tone will be emitted from the calling handset.

4.6.2 How to transfer an external call to another handset

During an external call:

- 1 Press  to initiate an internal call
 - The handsets available for intercom will be displayed and the external call is put on hold automatically.
- 2 Press  /  to select your desired handset
- 3 Press  to call your desired handset
 - Your desired handset rings.
- 4 Press  on the called handset to start intercom

Note





You can press  to switch the call between the internal call and the external call.

- 5 Press  on the calling handset
 - The calling handset transfers the external call to the called handset.

4.6.3 How to make a 3-way conference call

The conference call feature allows one external call to be shared with two handsets (in intercom). The three parties can share the conversation and no network subscription is required.

During an external call:



- 1 Press  to initiate an internal call
 - The handsets available for intercom will be displayed and the external call is put on hold automatically.
- 2 Press  /  to select your desired handset
- 3 Press  to call your desired handset
 - Your desired handset rings.
- 4 Press  on the called handset to start intercom

Note

You can press  to switch the call between the internal call and the external call.

- 5 Long press  on the calling handset
 - The calling handset, called handset and the external call would be in 3-way conference.

During the conference call:

- 1 Press  to put the external call on hold and go back to internal call
 - The external call is put on hold automatically.
- 2 Press and hold  to establish the conference call again

Note

Any handset hangs up during a conference call will leave the other handset still in connection with the external call.

4.6.4 Caller Line Identification (CLI)

Caller Line Identification (CLI) is a special service that you may subscribe from your network operator. If you have subscribed to CLI service and provided that the identity of the caller is not withheld, the number or name of the caller will be displayed when the phone rings so that you may decide whether to answer the call or not. Please contact your network provider for more information on this service.





4.6.5 Call waiting

If you have subscribed to Call Waiting service, the earpiece will emit a beep tone to inform you that there is a second incoming call. The number or name of the second caller will also be displayed if you have subscribed to Caller Line Identification service (CLI). Please contact your network provider for more information on this service.

To answer the second call, press .

4.7 How to find a handset

You can locate the handset by pressing  on the base station.

All the handsets registered to the base will produce the paging tone and you can stop the paging by pressing  /  /  /  on the handset or  on the base again.



5 Use more of your phone

5.1 Call in progress

Some options are available to you during a call. You can access these options by pressing corresponding key while a call is in progress. The available options are:



5.1.1 Mute/Unmute microphone

During a call:

- 1 Press 
 - The microphone is turned off and **MUTE ON** is displayed.
- 2 Press  again to turn on the microphone

5.1.2 How to adjust earpiece volume

During a call:

- 1 Press  to display the current earpiece volume level
- 2 Press  to select earpiece volume from Level 1 to Level 5
 - The earpiece volume is adjusted and the phone will go back to call connection screen.

5.1.3 How to switch on the loudspeaker

During a call:







- 1 Press  to activate loudspeaker mode

5.2 Phonebook

Your phone can store up to 100 phonebook memories. A maximum of nine of the stored phone numbers can be stored into the direct access memories for you to access the frequently used numbers directly. Each phone number can have a maximum of 24 digits. If you have more than one handset, each handset has its own phonebook.

5.2.1 How to store a number in the phonebook

In idle mode:







- 1 Press  to access the main menu
- 2 Press  to select **PHONEBOOK**
- 3 Press  to select **NEW ENTRY**
- 4 Enter the name (maximum 12 characters)
- 5 Press  to enter the number (maximum 24 digits)
- 6 Press  to choose a group (<No Group>, <Group A>, <Group B>, <Group C>)
- 7 Press  to save the entry
 - A beep tone is emitted and your phonebook entry is saved.

Note



If you have subscribed the caller identification service from your service provider, you can assign a specific ringtone for each group. When a call from that group calls you, you will hear the designated ringtone of that group. You can also assign individual contacts to specific groups of your choice.

5.2.2 How to access the phonebook

In idle mode:



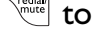

- 1 Press  to access the main menu
- 2 Press  to select **PHONEBOOK**
- 3 Press  to select **LIST ENTRY**
- 4 Press  and  to scroll to your desired phonebook entry
- 5 Press  to view the details of your desired phonebook entry









Tip

In idle mode, you can press  to access your phonebook, press  to select your desired phonebook entry and press  to view the details of your selected phonebook entry.

5.2.3 How to edit a phonebook entry









In idle mode:

- 1 Press  to access the main menu
- 2 Press  to select **PHONEBOOK**
- 3 Press  to scroll to **EDIT ENTRY**
- 4 Press  and  to choose the entry that you want to edit







- 5 Press 
- 6 Press  to erase the letters one by one, edit the name and press 
- 7 Press  to erase the digits one by one, edit the number and press 
- 8 Press / to choose a group (<No Group>, <Group A>, <Group B>, <Group C>)
- 9 Press  to save the entry
 - A beep tone is emitted and your selected phonebook entry is updated.

5.2.4 How to delete a phonebook entry



In idle mode:

- 1 Press 
- 2 Press  to select **PHONEBOOK**
- 3 Press / to scroll to **DELETE ENTRY**
- 4 Press  and / to choose the entry that you want to delete
- 5 Press  to confirm
 - A beep tone is emitted and your selected phonebook entry is deleted.

5.2.5 How to delete all phonebook entries

- 1 Press 
- 2 Press  to select **PHONEBOOK**
- 3 Press / to scroll to **DELETE ALL**
- 4 Press  to confirm
- 5 Press  to reconfirm
 - A beep tone is emitted and all your phonebook entries are deleted.











5.2.6 How to store direct access memory

You can store up to 9 direct access memories (Key  to ). A long press on the keys in idle mode will automatically dial the stored phone number.

Depending on your country, Key 1 and Key 2 may be preset to the voice mail number and information service number of your network operator respectively. In this case, Key 1 and Key 2 will not display. If voice mail number and information service number of your network

operator are unavailable, Key 1 and Key 2 will display on top of Key 3 as the direct access memory options, see Sections 5.8.2 and 5.8.3 for details.

In idle mode:

- 1 Press 
- 2 Press  to select **PHONEBOOK**
- 3 Press / to scroll to **DIRECT MEM.**
- 4 Press  and / to scroll to a direct access memory location from KEY 1 to KEY 9
- 5 Press  twice to select **ADD**
- 6 Press  to choose the phonebook entry that you wish to store into the selected direct access memory
- 7 Press  to confirm
 - A beep tone is emitted and your phonebook entry is saved into the selected direct access memory key.





Tip

Long press the direct memory key will dial out the phone number directly.



5.2.7 How to transfer the phonebook



This feature allows you to transfer the phonebook from one handset to another handset when there are at least two handsets registered to your base station.

In idle mode:

- 1 Press 
- 2 Press  to select **PHONEBOOK**
- 3 Press / to scroll to **PHB TRANSFER**
- 4 Press 
 - The handsets available for phonebook transfer are displayed.

Note

If there are more than two handsets, you can press / to select a specific handset.

- 5 The called handset will prompt with a message **"TRANS. FROM"**
- 6 To accept the phonebook transfer, press  on the called handset or press  to reject the phonebook transfer

- All your phonebook entries are transferred to the called handset and “**FINISH**” is displayed on the screens of both handsets after the transferring is done.





5.3 Call log

This feature is available if you have registered to the caller identification service (CLI) with your network operator.

Your phone can store up to 50 unanswered calls.  and the LED on the handset will blink to remind you of any unanswered calls received. If the identity of the caller is not withheld, the name (or number) of the caller will be displayed. The unanswered calls are displayed in chronological order with the most recent unanswered call at the top of the list.

5.3.1 How to access the call log







You can review the caller ID with alternate dialing sequences. You can then make a call with the selected dialing sequence directly or store this number in your phonebook.

- 1 Press  to access the call log
- 2 Press  to enter **CALL LIST**
 - The latest unanswered call is displayed.
- 3 Press / to view the entries
- 4 Press  repeatedly to view the alternate dialing sequences.

The screen will scroll through the various possible dialing options (e.g. 1 + area code+ number, area code + number, 1 + number, number only).

5.3.2 How to save call log entry to phonebook

In idle mode:

- 1 Press  to access the call log
- 2 Press  to enter **CALL LIST**
- 3 Press / to select an entry
- 4 Press  to select **COPY TO PHB**
- 5 Press  to enter the name
- 6 Press  to display the selected unanswered call number and edit the number if necessary









- 7 Press  to choose a group (<**No Group**>, <**Group A**>, <**Group B**>, <**Group C**>)

- 8 Press  to confirm

- A beep tone is emitted and the selected call log entry is saved into your phonebook.

5.3.3 How to delete the call log entry







In idle mode:

- 1 Press  to access the call log
- 2 Press  to enter **CALL LIST**
- 3 Press / to select an entry
- 4 Press  and / to select **DELETE**
- 5 Press  to confirm

- A beep tone is emitted and the selected call log entry is deleted.

5.3.4 How to delete the entire call log

In idle mode:

- 1 Press  to access the calls log
- 2 Press  to enter **CALL LIST**
- 3 Press / to select an entry
- 4 Press  to select **DELETE ALL**
- 5 Press  to confirm
- 6 Press  to re-confirm

- A beep tone is emitted. All the entries in the call log are deleted.

5.4 Redial list

Your phone can store the last 10 numbers your have dialed. Only the first 24 digits of each number are stored.

5.4.1 How to access the redial list

In idle mode:

- 1 Press 

The latest last number dialed is displayed at the top of the list.

- 2 Press / to view other dialed numbers

Tip

If the redial number is more than 12 digits, press  to review the other digits.

5.4.2 How to save a redial list entry to phonebook

In idle mode:

- 1 Press to access the redial list
 - 2 Press to select an entry
 - 3 Press to select **COPY TO PHB**
 - 4 Press to enter the name
 - 5 Press to display the selected redial number and edit the number if necessary
 - 6 Press to choose a group (<No Group>, <Group A>, <Group B>, <Group C>)
 - 7 Press to confirm
- A beep tone is emitted. The selected redial entry was copied to your phonebook.

5.4.3 How to delete a number from the redial list

- 1 Press to access the redial list
 - 2 Press to select an entry
 - 3 Press and to select **DELETE**
 - 4 Press to confirm
- A beep tone is emitted and the selected entry is deleted.

5.4.4 How to delete the entire redial list

- 1 Press to access the redial list
 - 2 Press and to select **DELETE ALL**
 - 3 Press to confirm
 - 4 Press to reconfirm
- A beep tone is emitted and the entire redial list is deleted.

5.5 Clock & alarm

5.5.1 How to set the time

- 1 Press to access the main menu
- 2 Press to select **CLOCK&ALARM**
- 3 Press to select **SET CLOCK**
- 4 Press and enter the current date (DD/MM/YY)
- 5 Press and enter the current time (HH:MM) in 24 hour format

Note

To change the date and time format, see Section 5.5.4.

- 6 Press to save the settings

5.5.2 How to set an alarm

- 1 Press to access the main menu
- 2 Press to select **CLOCK&ALARM**
- 3 Press and to select **ALARM**
- 4 Press and to select **OFF, ON ONCE, or ON DAILY**

Note

If you have selected **ON ONCE**, or **ON DAILY**, enter the time for the alarm

- 5 Press to save the settings

Note

When the alarm is selected as **ON ONCE** or **ON DAILY**, will display on the screen. When the alarm is reached, the alarm tone will sound and **ALARM** will blink on the screen. You can press to mute the alarm tone.

5.5.3 How to set the alarm tone

- 1 Press to access the main menu
- 2 Press to select **CLOCK&ALARM**
- 3 Press and to select **ALARM TONE**
- 4 Press and to choose your desired alarm tone from **MELODY 1** to **MELODY 10**





Note

The phone will play the corresponding melody when browsing the melody list.

- 5 Press to save the settings

5.5.4 How to set the date and time format

- 1 Press to access the main menu
- 2 Press to select **CLOCK&ALARM**
- 3 Press and to select **TIME/DATE**
- 4 Press and to choose the time format display (**12HR** or **24HR**)

- 5 Press  to confirm the time format display settings
- 6 Press  /  to choose the date format display (**DD/MM** or **MM/DD**)
- 7 Press  to confirm the date format display settings

5.6 Personal settings









5.6.1 Handset tone

5.6.1.1 How to set the ring volume



Your phone provides five ringer volume levels (one bar to five bars) and progressive ring volume for you to choose.

Warning

When the handset rings during an incoming call, please do not hold the handset too close to your ear as the volume of the ringing tone may damage your hearing.











- 1 Press  to access the main menu
- 2 Press  /  to select **PERSONAL SET**
- 3 Press  to select **HANDSET TONE**
- 4 Press  to select **RING VOLUME**
- 5 Press  and  /  to select your desired volume level
- 6 Press  to save the settings

Tip

You can press and hold  to turn off the ringer.  will display.

5.6.1.2 How to set the ring melody

10 ring melodies are available on your handset.













- 1 Press  to access the main menu
- 2 Press  /  to select **PERSONAL SET**
- 3 Press  to select **HANDSET TONE**
- 4 Press  and  /  to select **RING MELODY**
- 5 Press  and  /  to scroll to your desired ring melody
- 6 Press  to save the settings

5.6.1.3 How to set the group melody

To benefit from this feature, you must subscribe to the Caller Line Identification service.

This menu enables you to select and set the melodies to be played when there is an external incoming call from a contact whose name is stored in your phonebook and is part of a group. You can associate one ring melody to each group.

There are three phonebook groups (**Group A**, **B**, **C**) available for you to organize your contacts. Each group can be assigned a unique melody.

- 1 Press  to access the main menu
- 2 Press  /  to select **PERSONAL SET**
- 3 Press  to select **HANDSET TONE**
- 4 Press  and  /  to select **GROUP MELODY**
- 5 Press  and  /  to scroll to your desired group (**GROUP A**, **GROUP B**, **GROUP C**)
- 6 Press  and  /  to scroll to your desired group melody











Note

The phone will play the corresponding melody when browsing the melody list.



- 7 Press  to save the settings

5.6.1.4 How to turn on/off the key tone

A single beep is emitted when a key is pressed. You can turn off or turn on the key beep. By default, the key beep is **ON**.

- 1 Press  to access the main menu
- 2 Press  /  to select **PERSONAL SET**
- 3 Press  to select **HANDSET TONE**
- 4 Press  and  /  to select **KEY TONE**
- 5 Press  and  /  to select **ON** or **OFF**
- 6 Press  to save the settings.

5.6.1.5 How to activate/deactivate the keypad lock

- 1 Press and hold 
 - **KEYS LOCKED** is displayed if keypad lock is activated.
- 2 Press and hold  again to deactivate the keypad lock











- **KEYS LOCKED** is disappeared if keypad lock is deactivated.

Tip

You can also deactivate the keypad lock by removing and replacing the batteries of the handset.









5.6.1.6 How to turn on/off the first ring

If you have subscribed for Caller ID service with your service operator, your phone can suppress the first ring before the Caller ID. After resetting, your phone will automatically detect if Caller ID service is subscribed and start to suppress the first ring. You can change this settings to suit your preference.

- 1 Press  to access the main menu
- 2 Press  /  to select **PERSONAL SET**
- 3 Press  to select **HANDSET TONE**
- 4 Press  and  /  to select **FIRST RING**
- 5 Press  and  /  to select **ON** or **OFF**
- 6 Press  to save the settings

5.6.2 How to adjust the contrast

There are five contrast level options (**LEVEL 1**, **LEVEL 2**, **LEVEL 3**, **LEVEL 4** and **LEVEL 5**).

- 1 Press  to access the main menu
- 2 Press  /  to select **PERSONAL SET**
- 3 Press  and  /  to select **CONTRAST**
- 4 Press  and  /  to scroll to your desired contrast level







Note

The contrast effect will display when browsing different contrast levels.

- 5 Press  to save the settings

5.6.3 How to rename the handset

You can rename your handset and display the handset name in idle mode.

- 1 Press  to access the main menu
- 2 Press  /  to select **PERSONAL SET**
- 3 Press  and  /  to select **HANDSET NAME**
- 4 Press  to enter the handset name











Note

The maximum length of the handset name is 10 characters.

- 5 Press  to save the settings











5.6.4 How to set the auto pick-up

This function allows you to answer a call automatically by lifting the handset from the base station.

- 1 Press  to access the main menu
- 2 Press  /  to select **PERSONAL SET**
- 3 Press  and  /  to select **AUTO PICK-UP**
- 4 Press  and  /  to select **ON** or **OFF**
- 5 Press  to save the settings











5.6.5 How to set the auto hang-up

This function allows you to end a call automatically by placing the handset on the base station.

- 1 Press  to access the main menu
- 2 Press  /  to select **PERSONAL SET**
- 3 Press  and  /  to select **AUTO HANG-UP**
- 4 Press  and  /  to select **ON** or **OFF**
- 5 Press  to save the settings

5.6.6 How to set the menu language











Depending on your country, your handset display can support different languages. After changing the menu language, all the menus will be displayed in the chosen language. For some of the countries, your phone may not have this menu language option if only one language is available.

- 1 Press  to access the main menu
- 2 Press  /  to select **PERSONAL SET**
- 3 Press  and  /  to select **LANGUAGE**
- 4 Press  and  /  to choose your desired language
- 5 Press  to save the settings

Note

Available languages for selection vary with different countries





5.6.7 How to turn on/off the keypad and LCD backlight

- 1 Press  to access the main menu
- 2 Press  /  to select **PERSONAL SET**
- 3 Press  and  /  to select **BACKLIGHT**
- 4 Press  and  /  to select **ON** or **OFF**
- 5 Press  to save the settings

5.7 Advanced settings







5.7.1 How to select flash time

Flash time is the time delay by which the line will be disconnected after you press . The default value of flash time preset in your phone should be the best suited for your country network. You do not need to change it.

- 1 Press  to access the main menu
- 2 Press  /  to select **ADVANCED SET**
- 3 Press  to select **FLASH TIME**
- 4 Press  to select the flash time of your country

Note

Number of available recall time options varies with different countries.

- 5 Press  to confirm
- 1 Press  to access the main menu
- 2 Press  /  to select **ADVANCED SET**
- 3 Press  to select **RECALL TIME**
- 4 Press  to select the recall time of your country

Note



Number of available flash time options varies with different countries.



- 5 Press  to confirm



5.7.2 How to set the dial mode

The default value for dial mode that is preset in your CD440 should be the best suited for your country network and therefore you do need to change it.

There are two dial modes: Tone or Pulse.

- 1 Press  to access the main menu
- 2 Press  /  to select **ADVANCED SET**

- 3 Press  and  /  to select **DIAL MODE**

- 4 Press  and  /  to select **TONE** or **PULSE**

- 5 Press  to save the settings











5.7.3 Call barring

Call barring enables you to restrict selected handsets from dialling a phone number beginning with certain numbers. You can set up to four different barring numbers, with each number containing up to four digits.

Note

You will be required to enter the 4-digit master PIN before you can activate or deactivate call barring mode, add or modify call barring number.











5.7.3.1 How to set call barring mode on/off

- 1 Press  to access the main menu
- 2 Press  /  to select **ADVANCED SET**
- 3 Press  and  /  to select **CALL BARRING**
- 4 Press  to enter the 4-digit master PIN when prompted (default master PIN is 0000)
- 5 Press  to select **BARR MODE**
- 6 Press  to select **ON** or **OFF**
- 7 Press  to save the settings

Note

If barring mode is set to ON, **CALL BARR ON** will display on idle screen.

5.7.3.2 How to modify call barring number

- 1 Press  to access the main menu
- 2 Press  /  to select **ADVANCED SET**
- 3 Press  and  /  to select **CALL BARRING**
- 4 Press  to enter the 4-digit master PIN when prompted (default master PIN is 0000)
- 5 Press  and  /  to select **BARR NUMBER**

6 Press  to choose a number (**NUMBER 1, NUMBER 2, NUMBER 3, NUMBER 4**)

7 Press  to enter the number

8 Press  to save the settings

Note

If a restricted number is dialed, the call will not be connected. When this happens, the phone emits an error tone and returns to idle mode.

5.7.4 Baby call

When activated, the Baby Call feature enables you to dial the selected number by pressing any key on your handset. This feature is very useful for direct access to emergency services.



Note

You can enter up to 24 digits for baby call number.

5.7.4.1 How to activate baby call mode

1 Press  to access the main menu

2 Press  to select **ADVANCED SET**

3 Press  and  to select **BABY CALL**

4 Press  to select **BABY MODE**

5 Press  and  to select **ON**

6 Press  to save the settings

- The message “**BABYCALL ON**” will display on the idle screen.

5.7.4.2 How to deactivate baby call mode

1 Press and hold  (when Baby Call mode has been activated before).

2 Press  to select **OFF**



3 Press  to save the settings

- The message “**BABYCALL ON**” will disappear on the idle screen.

5.7.4.3 How to change baby call number

1 Press  to access the main menu

2 Press  to select **ADVANCED SET**

3 Press  and  to select **BABY CALL**

4 Press  and  to select **BABYCALL NR.**

5 Press  to enter the number



6 Press  to save the settings

5.7.5 How to manually select a base station

One CD440 handset can register up to four different CD440 base stations.

1 Press  to access the main menu

2 Scroll  to select **ADVANCED SET**

3 Press  and  to select **BASE SELECT**

4 Press  and  to select your desired base station

5 Press  to confirm

5.7.6 How to register an additional handset

Additional handsets must be registered to the base station before you can use them. Up to five handsets can be registered to one base station.

1 Press  to access the main menu

2 Scroll  to select **ADVANCED SET**



3 Press  and  to select **REGISTRATION**

4 Press  and  to select your desired base station

Note

The registered base station is marked with an asterisk at the rightmost of the display.

5 Press  and enter the 4-digit master PIN when prompted (default master PIN is 0000)

6 Press  and press  on the base station for more than three seconds at the same time.

- A beep tone is emitted from the handset to indicate successful registration and the screen returns to idle mode.











Note

If the base is found and the PIN is correct, the unused handset numbers will be assigned automatically.

If the PIN is incorrect, **WRONG PIN!** will be displayed with an error tone, and the handset returns to idle mode.

If no base is found within a certain period, **NO BASE** would be displayed with an error tone, and the handset return to idle mode.

5.7.7 How to unregister a handset











- 1 Press  to access the main menu
- 2 Press  /  to select **ADVANCED SET**
- 3 Press  and  /  to select **UNREGISTER**
- 4 Press  to enter the 4-digit master PIN when prompted (default master PIN is 0000)
- 5 Press  and  /  to select your desired handset
- 6 Press  to confirm
 - A beep tone is emitted from the handset to indicate the handset unregistration is successful and the screen shows **UNREGISTERED** and back to idle screen.

Note

If there are no key presses within 15 seconds, the unregistration procedure will be aborted and the handset will return to idle mode.

5.7.8 How to change the master PIN









The Master PIN is used for setting call barring, resetting your handset and for registration/deregistration of handsets. The default PIN is 0000. The length of the PIN is four digits. This PIN is also used to protect the settings of your handset. Your handset will prompt you whenever the PIN is required.

- 1 Press  to access the main menu
- 2 Press  /  to select **ADVANCED SET**
- 3 Press  and  /  to select **CHANGE PIN**
- 4 Press  to enter the 4-digit master PIN when prompted
- 5 Press  to enter the new 4-digit PIN
- 6 Press  to enter the new 4-digit PIN again for reconfirmation
- 7 Press  to save the settings

5.7.9 How to reset to default settings











You can reset your phone to the default settings (see Section 5.10). After a reset, all your personal settings and call log entries will be deleted, but your phonebook remains unchanged.

- 1 Press  to access the main menu

- 2 Press  /  to select **ADVANCED SET**
- 3 Press  and  /  to select **RESET**
- 4 Press  to enter the 4-digit master PIN when prompted (default master PIN is 0000)
- 5 Press  confirm
- 6 Press  to reconfirm
 - A beep tone is emitted and the screen returns to welcome screen. Your phone is reset to its default settings.
 - Some of the countries may not have welcome screen and your phone will return to idle screen after reset.

5.7.10 How to set the prefix number









This feature allows you to set the phone to use the cheapest operator prefix. The maximum length of the prefix is 5 digits. Once the prefix number is set, it is automatically inserted at the beginning of each number dialed out.

- 1 Press  to access the main menu
 - 2 Press  /  to select **ADVANCED SET**
 - 3 Press  and  /  to select **AUTO PREFIX**
 - 4 Press  to enter the detect digits
 - The last stored detect digits are displayed.
-  **Note**
- The maximum length of detect digits is five digits.
- 5 Press  to enter the auto prefix number
 - The last stored auto prefix number is displayed.
-  **Note**
- The maximum length of auto prefix number is 10 digits.
- 6 Press  to save the settings

5.7.11 Country setting

The availability of this menu is dependent on your country.

You can select another country different from the one chosen during welcome mode.

- 1 Press  to access the main menu
- 2 Press  /  to select **ADVANCED SET**
- 3 Press  and  /  to select **COUNTRY**
- 4 Press  and  /  to select your country









5 Press  to confirm your selection

Note

Once the country is selected, the default line settings for the selected country will be applied to your phone automatically.

5.7.12 How to set conference mode on/off

When conference mode is activated, you can initiate a three-party conference call with a second handset registered to your base station automatically if the second handset takes the line when there is already an external call in progress.

- 1 Press  to access the main menu
- 2 Press  /  to select **ADVANCED SET**
- 3 Press  and  /  to select **CONFER. MODE**
- 4 Press  to select **ON** or **OFF**
- 5 Press  to save the settings

5.8 Network services









This menu provides a convenient means for you to access, activate or deactivate some network services that are country/subscription dependent. Contact your network provider for more information about these services.

The default numbers and values that are preset in your phone should be the best suited for your country network and therefore you do not need to change them.

5.8.1 Call forward

There are three call forwarding options available: Unconditional Call Forwarding, When Busy and When Unanswered.

5.8.1.1 How to activate call forwarding











- 1 Press  to access the main menu
- 2 Press  /  to select **NET. SERVICE**
- 3 Press  and  /  to select the type of call forwarding option (**CALL FORWARD / CALLFW BUSY / CALLFW UNANS**)
- 4 Press  and  /  to select **ACTIVATE**
- 5 The number string for that selected service would be dialled.
- 6 When the number has been dialled, press

 key to return to idle mode.











Note

When this feature is activated, depending on the call forwarding option you have set, your incoming calls will be forwarded to the number of your choice.

5.8.1.2 How to deactivate call forwarding

- 1 Press  to access the main menu
- 2 Press  /  to select **NET. SERVICE**
- 3 Press  and  /  to select the type of call forwarding option (**CALL FORWARD / CALLFW BUSY / CALLFW UNANS**)
- 4 Press  and  /  to select **DEACTIVATE**
- 5 The number string for that selected service is dialled.
- 6 When the number has been dialled, press  to return to idle mode.



5.8.1.3 How to set the call forward number

- 1 Press  to access the main menu
- 2 Press  /  to select **NET. SERVICE**
- 3 Press  and  /  to select the type of call forwarding option (**CALL FORWARD / CALLFW BUSY / CALLFW UNANS**)
- 4 Press  and  /  to select **SETTINGS**
- 5 Press  to enter the number
- 6 Press  to save the settings

5.8.2 Voice mail

Depending of your country, the voice mail feature may not be available. This feature allows the caller to leave a voice message when you are unable to take a call yourself. **The availability of this feature is dependent on your country and your subscription with your network provider.** These voice messages are stored by the network rather than in your handset itself. Contact your network provider for more information about this feature.

5.8.2.1 How to activate voice mail

- 1 Press  to access the main menu
- 2 Press  /  to select **NET. SERVICE**

- 3 Press and / to select **VOICE MAIL**
- 4 Press and / to select **ACTIVATE**
- 5 The number string for voice mail service is dialed.
- 6 When the number has been dialed, press to return to idle mode.

5.8.2.2 How to set up voice mail number

Depending of your country, the voice mail feature may not be available.

- 1 Press to access the main menu
- 2 Press / to select **NET. SERVICE**
- 3 Press and / to select **VOICE MAIL**
- 4 Press and / to select **SETTINGS**
- 5 Press to enter the number
- 6 Press to save the settings

Tip

When a voice mail number is set, press and hold will dial out to the voice mail number directly.

5.8.3 Information services from network operator

This feature allows the caller to listen to information provided by your network provider.

The availability of this feature is dependent of your country and your subscription with your network provider.

This info are stored by the network rather than in your handset itself. Contact your network provider for more information about this feature.

5.8.3.1 How to activate info

- 1 Press to access the main menu
- 2 Press / to select **NET. SERVICE**
- 3 Press and / to select **INFO**
- 4 Press and / to select **ACTIVATE**
- 5 When the number has been dialed, press to return to idle mode

5.8.3.2 How to set up info number

- 1 Press to access the main menu
- 2 Scroll / to select **NET. SERVICE**
- 3 Press and / to select **INFO**
- 4 Press and / to select **SETTINGS**
- 5 Press to enter the number
- 6 Press to save the settings

Tip

When an info number is set, press and hold will dial out to the info number directly.

5.8.4 Call back

5.8.4.1 How to activate call back

- 1 Press to access the main menu
- 2 Press / to select **NET. SERVICE**
- 3 Press and / to select **CALL BACK**
- 4 Press and / to select **ACTIVATE**
- 5 When the number has been dialed, press to return to idle mode

5.8.4.2 How to set up call back number

- 1 Press to access the main menu
- 2 Press / to select **NET. SERVICE**
- 3 Press and / to select **CALL BACK**
- 4 Press and / to select **SETTINGS**
- 5 Press to enter the number
- 6 Press to save the settings

5.8.5 Cancel call back

5.8.5.1 How to activate cancel call back

- 1 Press to access the main menu
- 2 Press / to select **NET. SERVICE**
- 3 Press and / to select **NO CALLBK**
- 4 Press and / to select **ACTIVATE**
- 5 When the number has been dialed, press to return to idle mode

5.8.5.2 How to set up cancel call back number

- 1 Press to access the main menu
- 2 Scroll / to select **NET. SERVICE**
- 3 Press and / to select **NO CALLBK**
- 4 Press and / to select **SETTINGS**
- 5 Press to enter the number
- 6 Press to save the settings

5.8.6 Withhold ID

5.8.6.1 How to activate withhold ID

- 1 Press to access the main menu
- 2 Press / to select **NET. SERVICE**
- 3 Press and / to select **WITHHOLD ID**
- 4 Press and / to select **ACTIVATE**
- 5 When the number has been dialled, press to return to idle mode

5.8.6.2 How to set up withhold ID number

- 1 Press to access the main menu
- 2 Press / to select **NET. SERVICE**
- 3 Press and / to select **WITHHOLD ID**
- 4 Press and / to select **SETTINGS**
- 5 Press to enter the number
- 6 Press to save the settings

5.9 How to enter text and number

5.9.1 Entering text and digit

You can enter the names of your phonebook entries characters by character by pressing the relevant key once or several times to reach the desired character.

Key	Assignment
1	space 1 @ _ # = < > () & £ \$ ¥ € [] { } ☒
2	a b c 2 à ä Ç å Æ
3	d e f 3 é è Δ Φ
4	g h i 4 ì Γ
5	j k l 5 Λ
6	m n o 6 Ñ ò ö
7	p q r s 7 β Π Θ Σ
8	t u v 8 Ù Ü
9	w x y z 9 Ø Ω Ξ Ψ
0	. 0 , / ; " ' ! ; ? * + - % \ ^ ~

For example, to enter the name “PETER” in editing mode:

- Press once: P
 Press twice: E
 Press once: T
 Press twice: E
 Press three times: R

5.9.2 Switching between lowercase and uppercase

By default, all characters entered will be in uppercase. You can press to switch between uppercase and lowercase letters.

5.10 Default settings

Items	Default values
Handset name:	PHILIPS
Date:	--.---
Time:	--:--
Earpiece volume:	Level 3
Ring melody:	MELODY 1
Ring volume:	Level 3
Alarm:	OFF
Alarm ringer melody:	MELODY 1
Key tone:	ON
Contrast:	LEVEL 3
Auto pick-u:	OFF
Auto hang-up:	ON
First ring:	ON
Language:	Country dependent
Backlight	ON
Flash time:	Country dependent
Barring mode:	OFF
Dial mode:	TONE
Baby call mode:	OFF
Master PIN:	0000
Conference mode:	OFF

5.11 Menu structure

The table below describes the menu tree of your phone.

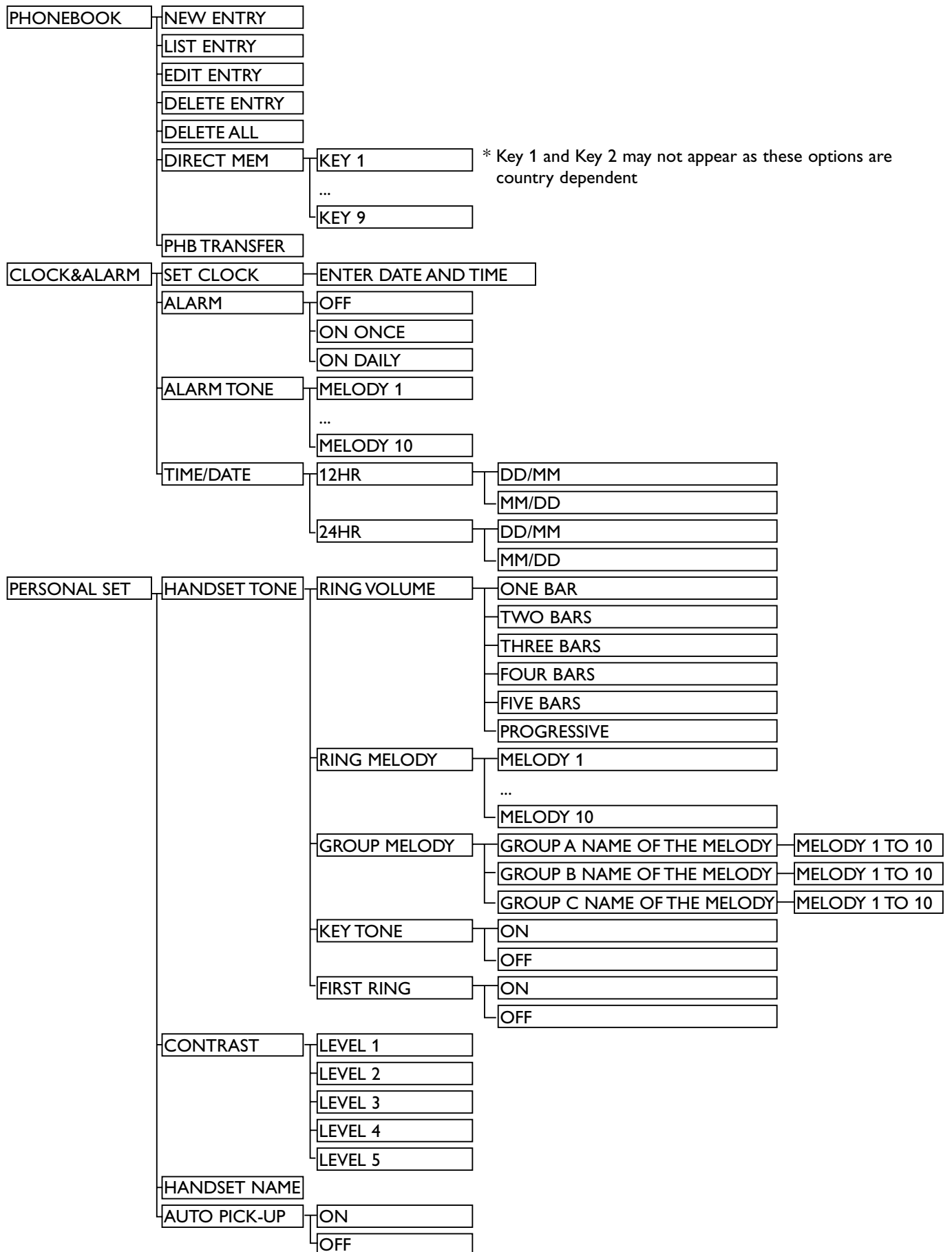

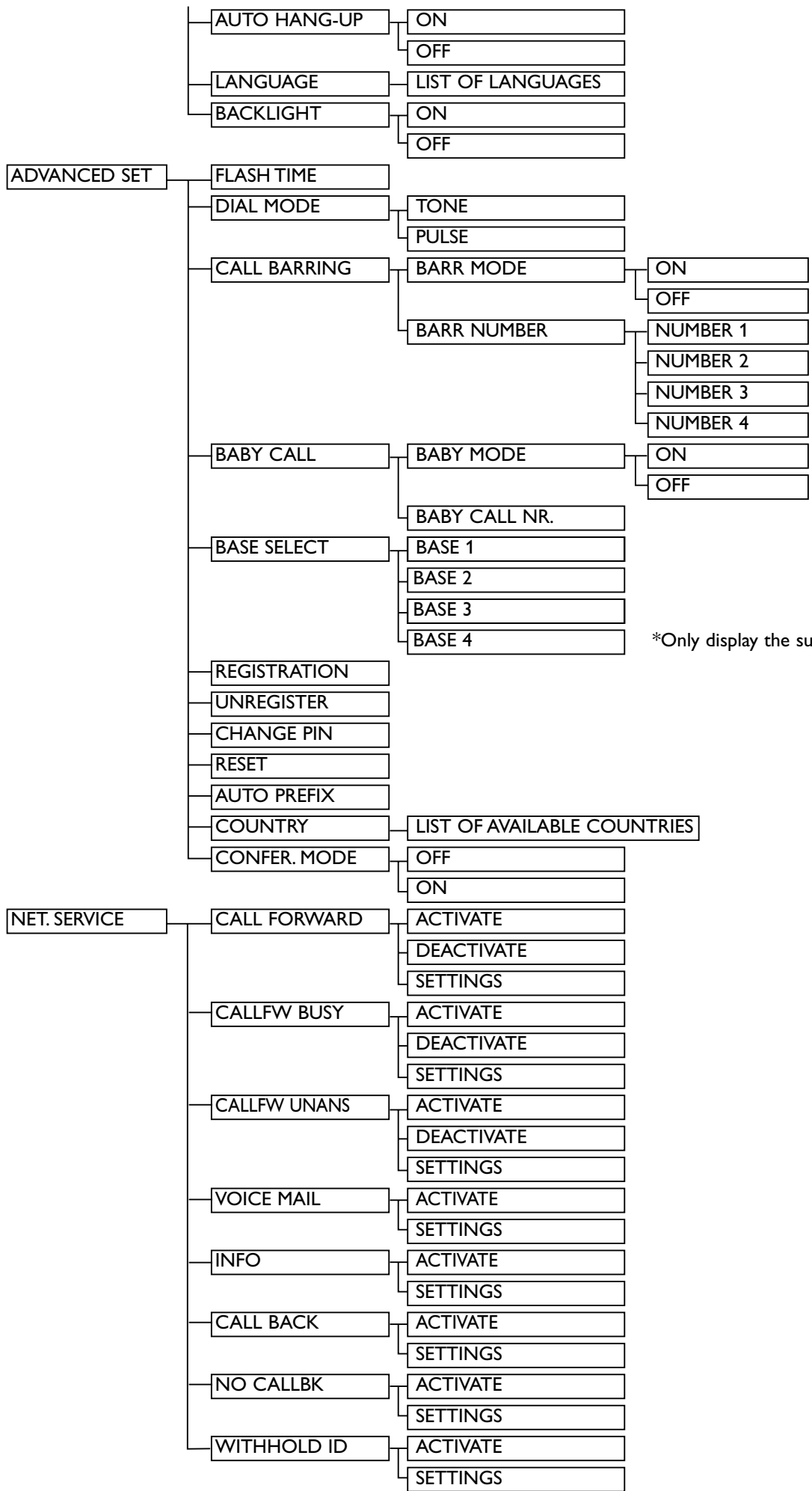

*Only display the subscribed base stations.

6 Frequently asked questions

In this chapter you will find the most frequently asked questions and answers about your phone.

Connection

The handset does not switch on!

- Charge the battery: Put the handset on charger. After a few moments the phone will switch on.
- Check the charger connections
- Use only the **SUPPLIED RECHARGEABLE BATTERIES**

The phone does not work at all.

- Make sure that the adaptor and the phone cord are connected properly
- Check that the batteries are fully charged and installed properly
- This phone does not work during power failure

Communication is lost during a call!

- Charge the battery
- Move closer to the base station

Poor audio quality

- Move closer to the base station
- Move the base station at least one metre away from any electrical appliances

No dialling tone

- Check the connections. Reset the phone: unplug and plug back in the mains.
- Charge the batteries for at least 24 hours
- Move closer to the base station
- Use the line cable provided
- Connect the line adaptor (when needed) to the line cord

The Ψ is blinking.

- Move closer to the base station
- Check battery level
- Register the handset to the base station

The appears.

- Replace the batteries with new ones (use only **RECHARGEABLE** batteries)
-

Set-up

Caller ID does not work properly.

- Check with your local phone company that the CID service is subscribed to
- Let the phone ring at least once before answering

The Call Waiting call cannot be answered.

- Check with your local phone company and select the correct flash duration

The handset LCD displays nothing.

- Try again by disconnecting and connecting the base station power supply and follow the procedure to register a handset (see Section 5.7.6)
- Make sure the two supplied rechargeable batteries have been inserted properly into the battery compartment
- Remove and place back the handset batteries
- Make sure the supplied batteries are charged up

The handset displays **UNREGISTERED**

- Follow the procedures to register the handset to a base
-

Sound

Handset does not ring!

- Increase the volume
- Make sure that the adaptor and the phone cord are connected properly
- Move the handset closer to the base unit
- Make sure the handset ringer is turned on

Caller does not hear me!

- Microphone may be muted: During a call, press .

Noise interference on your radio or television

- Move the power adaptor or base station as far away as possible

Product behaviour

- Caller Line Identification (CLI) service does not work
- Check your subscription with your network operator

A phonebook entry cannot be stored

- Check if the phonebook memory is full, delete an entry to free memory.

The handset is unable to register

- Make sure that  has been pressed for 3 seconds
- Each base can only register up to four handsets

A

Advanced Set 21, 22, 23, 24, 29
Alarm 9, 18, 27, 28
Alarm tone 18, 28
Answer a call 12, 20
Auto hang-up 20, 27, 29
Auto pick-up 12, 20, 28
Auto prefix 23, 29

B

Baby call 21, 22, 23, 27, 29
Backlight 20, 27, 29
Base station 6, 9, 10, 11, 12, 16, 20, 22, 23, 30, 31
Battery level 9, 30

C

Call back 25, 29
Call barring 21, 23, 29
Call forward 24, 29
Call log 7, 9, 12, 17, 23
Call transfer 8
Call waiting 14, 30
Caller Line Identification 9, 12, 14, 19, 31
Clock & Alarm 18
Conference call 8, 13, 14, 23
Conference mode 23, 27
Configure your phone 11
Conformity 5
Contrast 20, 27, 28
Country setting 23

D

Date and time format 18
Default settings 11, 23, 27
Delete a number from the redial list 18
Delete a phonebook entry 16
Delete all phonebook entries 16
Delete the call log entry 17
delete the entire call log 17
delete the entire redial list 18
Dial mode 21, 27, 29
Direct access memory 16

E

Earpiece volume 7, 15, 27
Edit a phonebook entry 15
End a call 12, 20
Enter text and number 26
Event LED 7

F

First ring 20, 27, 28
Flash time 22, 28, 30
Frequently asked questions 30, 31

G

Group melody 19, 28

H

Handset name 20, 27, 28
Handset tone 19, 20, 28
Handsfree 12

I

Icon 9
Idle mode 7, 8, 11, 12, 13, 14, 15, 16, 17, 20, 21,
22, 23, 24, 25, 26
Install rechargeable batteries 10
Intercom 8, 13, 14

K

Key tone 19, 27, 28
Keypad lock 8, 19

L

Language 20, 27, 29
Line cord 6, 10, 30
Loudspeaker 8, 9, 15

M

Make a call 12, 13
Master PIN 21, 22, 23, 27
Menu structure 28
Mute 7, 8, 15, 18

N

Network services 24

P

Page 9

Pause 8

Personal Set 19, 20, 28

Phonebook 7, 9, 12, 13, 15, 16, 17, 18, 19, 23, 26,
28, 31

predialling 7, 12

Pulse 21, 29

Q

Quick start guide 6

R

Redial 7, 13, 17, 18

Registration 9, 22, 23, 29

Reset 11, 23, 29, 30

Ring melody 15, 19, 27, 28

Ring volume 19, 27, 28

Ringer 8, 9, 19, 27, 31

S

Save a redial list entry 17

Store a number in the phonebook 15

Switch call 8, 13

T

Text 26

Tone (Dial mode) 19, 28

Transfer the phonebook 16

U

Unmute 15

Unregister 22, 29, 30

V

Voice mail 16, 24, 25, 29

W

Withhold ID 26, 29

FCC and IC statements

Equipment approval Information

Your telephone equipment is approved for connection to the public switched telephone network and is in compliance with parts 15 and 68, FCC Rules and Regulations and the Technical Requirements for Telephone Terminal Equipment published by ACTA.

Notification to the local telephone company

On the bottom of this equipment is a label indicating, among other information, the US number and Ringer Equivalence Number (REN) for the equipment. You must, upon request, provide this information to your telephone company.

The REN is useful in determining the number of devices you may connect to your telephone line and still have all of these devices ring when your telephone number is called. In most (but not all) areas, the sum of the RENs of all devices connected to one line should not exceed 5. To be certain of the number of devices you may connect to your line as determined by the REN, you should contact your local telephone company.

A plug and jack used to connect this equipment to the premises wiring and telephone network must comply with the applicable FCC Part 68 rules and requirements adopted by the ACTA. A compliant telephone cord and modular plug is provided with this product. It is designed to be connected to a compatible modular jack that is also compliant. See installation instructions for details.

Notes

- This equipment may not be used on coin service provided by the telephone company.
- Party lines are subject to state tariffs, and therefore, you may not be able to use your own telephone equipment if you are on a party line. Check with your local telephone company.

- Notice must be given to the telephone company upon permanent disconnection of your telephone from your line.
- If your home has specially wired alarm equipment connected to the telephone line, ensure the installation of this product does not disable your alarm equipment. If you have questions about what will disable alarm equipment, consult your telephone company or a qualified installer.

Rights of the Phone Company

Should your equipment cause trouble on your line which may harm the telephone network, the telephone company shall, where practicable, notify you that temporary discontinuance of service may be required. Where prior notice is not practicable and the circumstances warrant such action, the telephone company may temporarily discontinue service immediately. In case of such temporary discontinuance, the telephone company must:

(1) promptly notify you of such temporary discontinuance; (2) afford you the opportunity to correct the situation; and (3) inform you of your right to bring a complaint to the Commission pursuant to procedures set forth in Subpart E of Part 68, FCC Rules and Regulations.

The telephone company may make changes in its communications facilities, equipment, operations or procedures where such action is required in the operation of its business and not inconsistent with FCC rules and Regulations. If these changes are expected to affect the use or performance of your telephone equipment, the telephone company must give you adequate notice, in writing, to allow you to maintain uninterrupted service.

Interference Information

This device complies with Part 15 of the FCC Rules. Operation is subject to the following two conditions:

(1) this device may not cause harmful interference; and (2) this device must accept any interference received, including interference that may cause undesired operation.

This equipment has been tested and found to comply with the limits for a Class B digital device, pursuant to Part 15 of the FCC Rules. These limits are designed to provide reasonable protection against harmful interference in a residential installation.

This equipment generates, uses, and can radiate radio frequency energy and, if not installed and used in accordance with the instructions, may cause harmful interference to radio communications. However, there is no guarantee that interference will not occur in a particular installation.

If this equipment does cause harmful interference to radio or television reception, which can be determined by turning the equipment off and on, the user is encouraged to try to correct the interference by one or more of the following measures:

- Reorient or relocate the receiving antenna (that is, the antenna for radio or television that is “receiving” the interference).
- Reorient or relocate and increase the separation between the telecommunications equipment and receiving antenna.
- Connect the telecommunications equipment into an outlet on a circuit different from that to which the receiving antenna is connected.

If these measures do not eliminate the interference, please consult your dealer or an experienced radio / television technician for additional suggestions. Also, the Federal Communications Commission has prepared a helpful booklet, “How To Identify and Resolve Radio/TV Interference Problems”. This booklet is available from the U.S. Government Printing Office, Washington, D.C. 20402.

Please specify stock number 004-000-00345-4 when ordering copies.

Noise

Electrical pulse noise is present at one time or another. This is most intense during electrical storms. Certain kinds of electrical equipment, such as light dimmers, fluorescent bulbs, motors, fans, etc., also generate pulse noise. Because radio frequencies are susceptible to this, you may on occasion hear pulse noise through the

receiver. This is usually only a minor annoyance and should not be interpreted as a defect of the unit.

FCC RF Radiation Exposure Statement

This equipment complies with FCC RF radiation exposure limits set forth for an uncontrolled environment. This equipment should be installed and operated with a minimum distance of 20 centimeters between the radiator and your body. This transmitter must not be co-located or operating in conjunction with any other antenna or transmitter.

For hand held operation, this phone has been tested and meets the FCC RF exposure guidelines. Use of other accessories may not ensure compliance with FCC RF exposure guidelines.

Hearing Aid Compatibility (HAC)

This telephone system meets FCC and Industry Canada standards for Hearing Aid Compatibility.

Privacy

Privacy of communications may not be ensured when using this telephone.

Additional Information

I.C. Notice

Terminal Equipment

NOTICE : This equipment meets the applicable Industry Canada Terminal Equipment Technical Specifications.

This is confirmed by the registration number. The abbreviation, IC, before the registration number signifies that registration was performed based on a Declaration of Conformity indicating that Industry Canada technical specifications were met. It does not imply that Industry Canada approved the equipment.

NOTICE : The Ringer Equivalence Number (REN) for this terminal equipment is marked on the equipment itself. The REN assigned to each terminal equipment provides an indication of the maximum number of terminals allowed to be connected to a telephone interface. The

termination on an interface may consist of any combination of devices subject only to the requirement that the sum of the Ringer Equivalence Numbers of all the devices does not exceed five.

Radio Equipment

The term "IC:" before the radio certification number only signifies that Industry Canada technical specifications were met. Operation is subject to the following two conditions : (1) this device may not cause interference, and (2) this device must accept any interference, including interference that may cause undesired operation of the device.

Do not attempt to repair or modify this equipment

Repairs to certified equipment should be made by an authorized maintenance facility designated by the supplier.

Warning: Changes or modifications to this equipment not expressly approved by the party responsible for compliance could void the user's authority to operate the equipment.

Service Centers

USA

Philips Consumer Electronics
P.O. Box 671539
Marietta, GA 30006-0026
Phone: 1-888-PHILIPS (744-5477)
Phone: 1-800-363-7278 (English)
Phone: 1-800-661-6162 (Français)

CANADA

Philips - Consumer Service Division
4977 Levy Street
Ville St. Lurent,
Quebec H4R 2N9
Phone: 1-800-363-7278 (English)
Phone: 1-800-661-6162 (Français)

The RBRC® seal



The RBRC® Seal on the nickel metal hydride battery indicates that Philips Royal Electronics is voluntarily participating in an industry program to collect and recycle these batteries at the end of their useful lives, when taken out of service within the United States and Canada.

The RBRC® program provides a convenient alternative to placing used nickel metal hydride batteries into the trash or municipal waste, which may be illegal in your area.

Philips's participation in RBRC® makes it easy for you to drop off the spent battery at local retailers participating in the RBRC® program or at authorized Philips product service centers. Please call 1-800-8-BATTERY for information on Ni-MH battery recycling and disposal bans/restrictions in your area. Philips's involvement in this program is part of its commitment to protecting our environment and conserving natural resources.

RBRC® is a registered trademark of Rechargeable Battery Recycling Corporation.

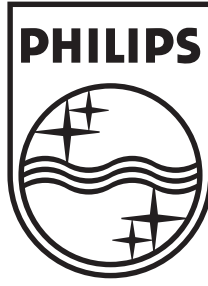

© 2006 Koninklijke Philips Electronics N.V.

All rights reserved.

Document number: 3111 285 34031