

NIGHT VISION

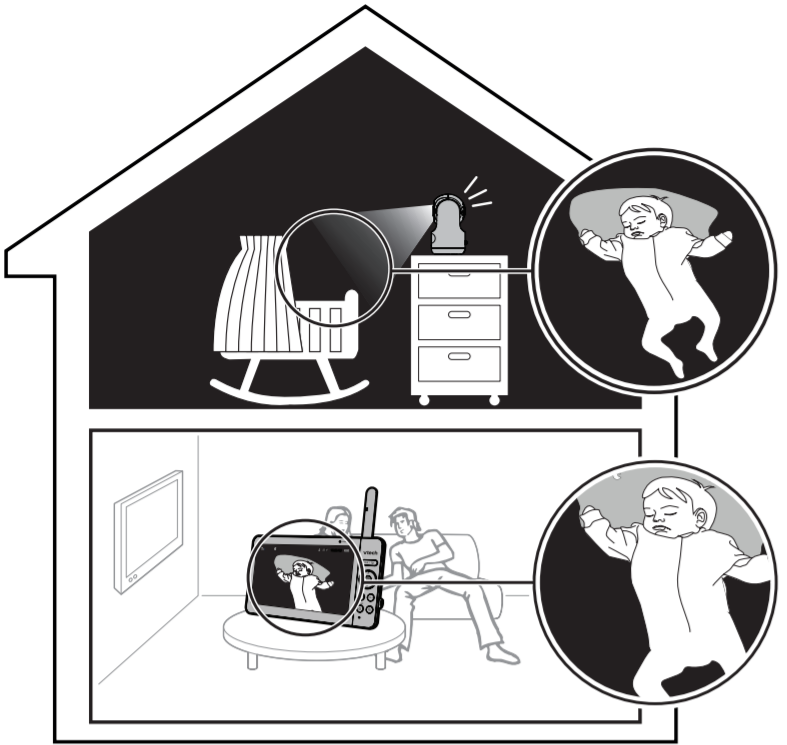



The baby unit has infrared LEDs that allow you to see your baby clearly at night or in a dark room. When the baby unit detects low light levels, the infrared LEDs are switched on automatically. The images from the baby unit are in black and white, and  appears on the parent unit screen.





NOTES

- A **click sound** from the baby unit is normal and occurs when your unit adapts to the environment lighting conditions.
- To achieve accurate and high quality video, your baby unit is equipped with an Infrared cut-off filter lens that optimizes color accuracy in bright, day-time environments. When the environment turns dark at night, this filter lens is withdrawn to enhance night vision quality. The brief **click sound** you hear is from the filter lens activating/deactivating as the unit switches from day to night vision (and vice versa).
- ✦ **Tip**
- Depending on the surroundings and other interfering factors, for example, lighting, objects, colors and backgrounds, the image quality may vary. Adjust the baby unit angle or place the baby unit at a higher location to prevent glare and a blurred display.

MOUNT THE BABY UNIT (OPTIONAL)

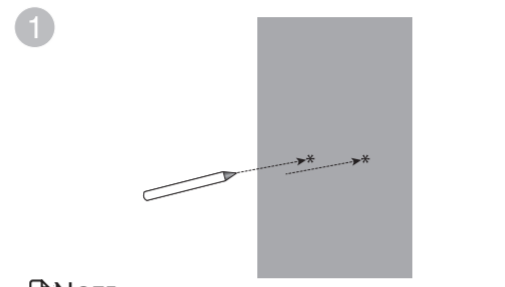
-  **Not Included**
- You will need to purchase the following items separately to mount your baby unit:
 -  2 screws
 -  2 anchors
-  The screw types and anchors you need depend on the composition of the wall.



-  **NOTE**
 - Check for reception strength and camera angle before drilling the holes.
- Use a pencil and mark the position of two holes to be drilled, making sure they are the same distance apart as the wall mount holes under the baby unit base

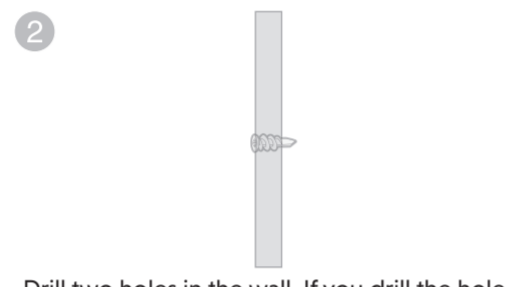

- Drill two holes in the wall. If you drill the holes into a stud, go to step 3.
- OR-**
- If you drill the holes into an object other than a stud, insert the wall anchors into the holes. Tap gently on the ends with a hammer until the wall anchors are flush with the wall.

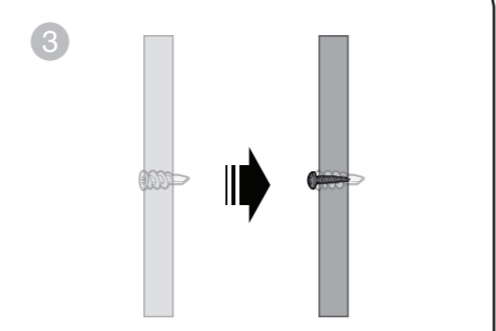

Insert the screws into the holes and tighten the screws until only 6.5 mm of the screws are exposed.

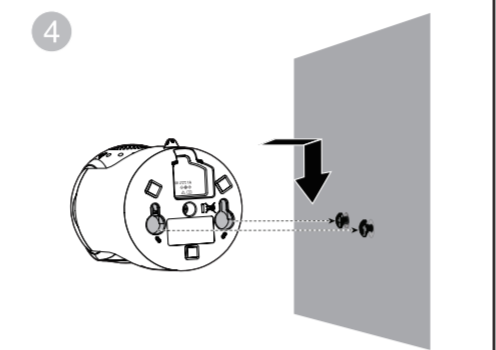

Align the wall mount holes on the baby unit with the screws on the wall. Slide the baby unit down until it locks into place.

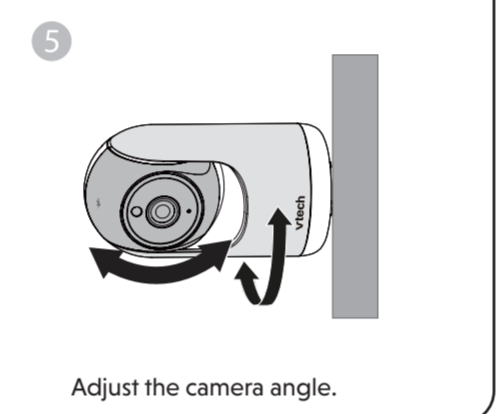

THE RBRC SEAL

The RBRC seal on the lithium-ion battery indicates that VTech Communications, Inc. is voluntarily participating in an industry program to collect and recycle these batteries at the end of their useful lives, when taken out of service within the United States and Canada. The program provides a convenient alternative to placing used lithium-ion batteries into the trash or municipal waste, which may be illegal in your area.

VTech's participation makes it easy for you to drop off the spent product at local retailers participating in the program or at authorized VTech product service centers. Please call **1 (800) 8 BATTERY** for information on Li-ion battery recycling and disposal bans/restrictions in your area. VTech's involvement in this program is part of its commitment to protecting our environment and conserving natural resources.

The RBRC Seal and **1 (800) 8 BATTERY** are registered trademarks of Call2recycle, Inc.

FCC AND IC REGULATIONS

FCC Part 15
NOTE: This equipment has been tested and found to comply with the requirements for a Class B digital device under Part 15 of the Federal Communications Commission (FCC) rules. These requirements are intended to provide reasonable protection against harmful interference in a residential installation. This equipment generates, uses and can radiate radio frequency energy and, if not installed and used in accordance with the instructions, may cause harmful interference to radio communications. However, there is no guarantee that interference will not occur in a particular installation. If this equipment does cause harmful interference to radio or television reception, which can be determined by turning the equipment off and on, the user is encouraged to try to correct the interference by one or more of the following measures:

- Reorient or relocate the receiving antenna.
- Increase the separation between the equipment and receiver.
- Connect the equipment into an outlet on a circuit different from that to which the receiver is connected.
- Consult the dealer or an experienced radio/TV technician for help.

WARNING: Changes or modifications to this equipment not expressly approved by the party responsible for compliance could void the user's authority to operate the equipment.

This device complies with Part 15 of the FCC rules. Operation is subject to the following two conditions: (1) this device may not cause harmful interference, and (2) this device must accept any interference received, including interference that may cause undesired operation.

To ensure safety of users, the FCC has established criteria for the amount of radio frequency energy that can be safely absorbed by a user or bystander according to the intended usage of the product. This product has been tested and found to comply with the FCC criteria. The baby unit shall be installed and used such that parts of all persons' body are maintained at a distance of approximately 8 in (20 cm) or more. The transmitter and antenna of the parent unit shall be held at least 1 in (2.5 cm) from your face.

This Class B digital apparatus complies with Canadian requirement: CAN ICES-3 (B)/NMB-3(B)

Industry Canada
This device contains licence-exempt transmitter(s)/receiver(s) that comply with Innovation, Science and Economic Development Canada's licence-exempt RSS(s). Operation is subject to the following two conditions: (1) This device may not cause interference. (2) This device must accept any interference, including interference that may cause undesired operation of the device.

The term "IC" before the certification/registration number only signifies that the Industry Canada technical specifications were met.

This product meets the applicable Innovation, Science and Economic Development Canada technical specifications.

RF radiation exposure statement
This product complies with FCC RF radiation exposure limits set forth for an uncontrolled environment. The baby unit should be installed and operated with a minimum distance of 8 in (20 cm) between the baby unit and all persons' body. Use of other accessories may not ensure compliance with FCC RF exposure guidelines. This equipment complies also with Industry Canada RSS-302 with respect to Canada's Health Code 6 for Exposure of Humans to RF Fields.

CALIFORNIA ENERGY COMMISSION BATTERY CHARGING TESTING MODE



This video monitor meets the California Energy Commission (CEC) regulations for energy consumption. Your video monitor is set up to comply with the energy-conserving standards right out of the box. Follow the instructions to install and charge the battery. The CEC battery charging testing mode is activated while charging. Even if the parent unit is paired to camera units, the CEC battery charging testing mode is activated while it is powered off and charging.

FOR CETL COMPLIANCE ONLY

La plaque signalétique appliquée est située au bas du socle de l'unité du bébé.

1. Observez toutes les instructions et mises en garde inscrites sur l'appareil.
2. L'installation par un adulte est requise.
3. **MISE EN GARDE:** N'installez pas l'unité du bébé à une hauteur supérieure à 2 mètres.
4. Ce produit a été conçu pour être un dispositif d'appoint seulement. Il n'est pas le remplacement d'une supervision responsable et adéquate par un adulte et ne devrait pas être utilisé comme telle.
5. Ce produit n'est pas conçu pour être utilisé en tant que moniteur médical.
6. N'utilisez pas cet appareil près de l'eau ni de toute autre source d'humidité, par exemple, près d'une baignoire, cuve à lessive, évier de cuisine, dans un sous-sol humide ni près d'une piscine, dans un sous-sol humide ou une douche.
7. **MISE EN GARDE:** N'utilisez que la pile fournie. Il peut y avoir un risque d'explosion si un mauvais type de pile est utilisé pour le dispositif apaisant. La pile ne peut pas être soumise à des températures extrêmes élevées ou basses, et à une faible pression atmosphérique à haute altitude pendant son utilisation, son entreposage ou son transport. Le fait de jeter la pile dans un feu ou dans un four chaud ou d'écraser ou de couper mécaniquement la pile peut entraîner une explosion. Le fait de laisser la pile dans un environnement à température extrêmement élevée peut entraîner une explosion ou une fuite de liquide ou de gaz inflammable. Une pile soumise à une pression d'air extrêmement basse peut provoquer une explosion ou une fuite de liquide ou de gaz inflammable. Mettez au rebut la pile usagée conformément aux informations figurant dans la section **Le sciau RBRC**.
8. N'utilisez que les adaptateurs inclus avec ce produit. L'utilisation d'un adaptateur dont la polarité ou la tension serait inadéquate risque d'endommager sérieusement le produit et mettre votre sécurité en péril.

  Informations sur les adaptateurs électriques :
Sortie : 5 V CC 1A
VTech Telecommunications Ltd. Modèle : VT05EUS05100
-Ou-
Jiangxi Jian Aohai Technology Co., Ltd.
Modèle : A318-050100W-US2

  Informations sur les piles rechargeables :
3.7V 5000mAh, 18.5Wh Lithium-ion batterie
Zhuhai Great Power Energy Co., Ltd.
Modèle : GSP806090-SAR-3.7V-153P

9. Lorsqu'ils sont branchés dans une prise de courant, les adaptateurs secteur ont été conçus pour être orientés correctement, soit à la verticale ou au plancher. Les broches n'ont pas été conçues pour supporter le poids du bloc d'alimentation et le maintenir en place si celui-ci est branché dans une prise au plafond, sous une table ou dans un meuble.
10. Pour les appareils raccordés, la prise de courant (de l'adaptateur secteur) doit être installée près de l'équipement et doit être facilement accessible.
11. Débranchez ce produit de la prise de courant avant de procéder au nettoyage. N'utilisez pas de nettoyeurs en aérosols. Utilisez un chiffon humide pour le nettoyer.
12. Ne coupez pas les cordons d'alimentation pour remplacer les fiches, car ceci peut présenter un danger potentiel.
13. Ne laissez aucun objet reposer ni appuyer sur le cordon d'alimentation. N'installez pas cet appareil dans un endroit où l'on risque d'écraser le cordon d'alimentation ou de le piétiner.
14. Ne laissez fonctionner cet appareil qu'avec le type d'alimentation indiqué sur l'étiquette. Si vous ne connaissez pas le type d'alimentation que vous devez à votre domicile, consultez votre marchand ou votre compagnie locale d'électricité.
15. L'équipement doit être fourni à partir d'un acquiescement gauche identifié à USB aux conditions de la source d'énergie limitée.
16. Ne rechargez pas les prises de courant murales ni les rallonges électriques.
17. Ne placez pas cet appareil sur un chariot, meuble, trépiéd, support de montage ni table chancelante.
18. Les trous et ouvertures du boîtier, situés à l'arrière de l'appareil ou sous celui-ci, servent à aérer l'appareil. Pour l'empêcher de surchauffer, ne bloquez sous aucun prétexte ces ouvertures et



n'empêchez pas l'aération adéquate de l'appareil en le plaçant sur un lit, divan, tapis ou toute autre surface similaire. De même, ne le positionnez pas à proximité ni au-dessus d'une source de chaleur ou d'un calorifère. De plus, ne placez pas l'appareil dans un endroit avant de vous assurer qu'il y ait une bonne circulation d'air.

19. N'enfoncez jamais d'objets à travers les ouvertures de cet appareil, car ils pourraient entrer en contact avec des points de tension dangereux ou causer des courts-circuits qui peuvent dégénérer en incendies ou en risques d'électrocution. Ne renversez jamais de liquide dans ce produit.
20. Afin de réduire les risques d'électrocution, ne démontez pas cet appareil, mais apportez-le dans un centre de service autorisé. L'ouverture du boîtier ou le retrait de toutes pièces que contiennent cet appareil, à l'exception de l'accès autorisé à certaines portes ou ouvertures, risque de vous exposer à des points de tension dangereux ou d'autres dangers. Un remontage incorrect peut par la suite présenter des risques d'électrocution.
21. Vous devriez tester la réception chaque fois que vous mettez l'appareil en fonction.
22. Examinez les composantes afin de vérifier si celles-ci ne sont pas endommagées.
23. Il existe un très faible risque de perte de confidentialité avec certains appareils électroniques (autres écoute-bébés, téléphones sans fils etc.). Pour l'éviter, assurez que le produit n'a jamais été utilisé avant l'achat, réinitialiser l'unité de façon périodique, éteindre l'écoute-bébé quand il n'est pas en cours d'utilisation.
24. Les enfants devraient être supervisés afin de vous assurer qu'ils ne jouent pas avec l'appareil.
25. Les petites pièces de ce moniteur peuvent être avalées par les bébés ou les petits enfants. Veuillez tenir ces pièces hors de portée des enfants.
26. Le produit n'est pas conçu pour être utilisé par des personnes (incluant des enfants) aux capacités physiques, sensorielles ou mentales réduites ou qui manquent d'expérience et de connaissances, à moins qu'on leur ait donné suffisamment de supervision ou d'instructions relativement à l'utilisation de l'appareil par une personne responsable de leur sécurité.

CONSERVEZ CES INSTRUCTIONS

Mises en garde

- Utilisez et entreposez le produit à une température entre 0° C (32° F) et 40° C (104° F).
- Risque de brûlure, risque d'incendie, risque d'explosion associé à une mauvaise manipulation de la batterie.
- N'exposez pas cet appareil à des froids ou des chaleurs extrêmes, ainsi qu'à la lumière directe du soleil. Ne l'installez pas près d'une source de chauffage.

  Avertissement - Risque de strangulation - Les enfants se sont ETRANGLÉS dans des cordons. Gardez ce cordon hors de portée des enfants (à plus de 0,9 m). N'enlevez pas cette étiquette.

 D'autres produits électroniques peuvent causer des interférences auprès de votre caméra IP. Essayez d'installer votre caméra IP le plus loin possible de ces dispositifs électroniques : routeurs sans fil, radios, téléphones cellulaires, interphones, moniteurs de pièces, téléviseurs, ordinateurs personnels, appareils électriques de cuisine et téléphones sans fil.

Stimulateurs cardiaques implantés dans l'organisme
Les stimulateurs cardiaques (ne s'applique qu'aux dispositifs numériques sans fil):
L'organisme "Wireless Technology Research, LLC (WTR)", une firme de recherche indépendante, a mené une évaluation pluridisciplinaire des interférences entre les téléphones sans fil portatifs et les stimulateurs cardiaques implantés dans l'organisme. Appuyez sur l'Administration des aliments et drogues (FDA) des États-Unis, la firme WTR recommande aux médecins:

- Vous devriez maintenir les dispositifs sans fil à au moins six pouces du stimulateur cardiaque.
 - Ils ne doivent PAS placer le téléphone sans fil directement sur le stimulateur cardiaque, tel que dans une poche de chemise, lorsque celui-ci est en marche.
- L'étude effectuée par l'organisme WRS n'a pas identifié de risque pour les détenteurs de stimulateurs cardiaques causés par les gens qui utilisent des dispositifs sans fil à proximité de ceux-ci.

Champs électromagnétiques (EMF)
Ce produit de VTech est conforme à toutes les normes se rapportant aux champs électromagnétiques (EMF) standard. Si vous le manipulez correctement en suivant les instructions de ce guide, son utilisation sera sécuritaire et conforme aux normes en vigueur, selon les meilleures évidences scientifiques dont nous disposons aujourd'hui.

CABLE MANAGEMENT

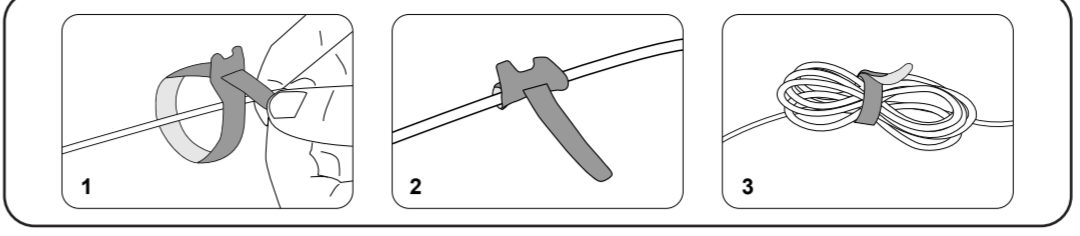

NEED HELP?

For instructions and guides to make the best use of your baby monitor, and for the latest information and support, check out our online help topics and FAQs. The online help page will also be updated periodically to reflect product system updates.

Use your smartphone or mobile phone to access our online help.

- Go to <https://help.vtechphones.com/346700> or <https://help.vtechphones.com/346800>; OR
- Scan the QR code on the right. Launch the camera app or QR code scanner app on your smartphone or tablet. Hold the device's camera up to the QR code and frame it. Tap the notification to be redirected to the online help page.
 - If the QR code is not clearly displayed, adjust your camera's focus by moving your device closer or further away until the image is clear.

If you would like to contact us, visit <https://help.vtechphones.com/cs>.

You can also call our Customer Support at 1 (800) 595-9511 [in US] or 1 (800) 267-7377 [in Canada] for help.



Advanced HQ Max, VM929HQ, 928 Plus online help (Model no. 346700)



Advanced HQ Max Twin, VM929-2HQ, 928 Plus Twin online help (Model no. 346800)

LIMITED WARRANTY

What does this limited warranty cover?
The manufacturer of this VTech Product warrants to the holder of a valid proof of purchase ("Consumer" or "you") that the Product and all accessories provided in the sales package ("Product") are free from defects in material and workmanship, pursuant to the following terms and conditions, when installed and used normally and in accordance with the Product operating instructions. This limited warranty extends only to the Consumer for Products purchased and used in the United States of America and Canada.

What will VTech do if the Product is not free from defects in materials and workmanship during the limited warranty period ("Materially Defective Product")?
During the limited warranty period, VTech's authorized service representative will replace a VTech's option, without charge, a Materially Defective Product. If we choose to replace the Product, we may replace it with a new or refurbished Product of the same or similar design. We will retain defective parts, modules, or equipment. Replacement of the Product, at VTech's option, is your exclusive remedy. VTech will return the replacement Products to you in working condition. You should expect the replacement to take approximately 30 days.

How long is the limited warranty period?
The limited warranty period for the Product extends for ONE (1) YEAR from the date of purchase (90 days on products purchased as Refurbished"). This limited warranty also applies to the replacement Product for a period of either (a) 90 days from the date the replacement Product is shipped to you or (b) the time remaining on the original one-year warranty (90-day limited warranty on products that are purchased as Refurbished"); whichever is longer.

*Refurbished products purchased from our online store carry a 90-day replacement warranty.

What is not covered by this limited warranty?
This limited warranty does not cover:

1. Product that has been subjected to misuse, accident, shipping or other physical damage, improper installation, abnormal operation or handling, neglect, inundation, fire, water or other liquid intrusion; or
2. Product that has been damaged due to repair, alteration or modification by anyone other than an authorized service representative of VTech; or
3. Product to the extent that the problem experienced is caused by signal conditions, network reliability, or cable or antenna systems; or
4. Product to the extent that the problem is caused by use with non-VTech accessories; or
5. Product whose warranty/quality stickers, product serial number plates or electronic serial numbers have been removed, altered or rendered illegible; or
6. Product purchased, used, serviced, or shipped for repair from outside the United States of America or Canada, or used for commercial or institutional purposes (including but not limited to Products used for rental purposes); or
7. Product returned without a valid proof of purchase (see item 2 below); or
8. Charges for installation or set up, adjustment of customer controls, and installation or repair of systems outside the unit.

TECHNICAL SPECIFICATIONS

Frequency control	Crystal controlled PLL synthesizer
Transmit frequency	Baby unit: 2405 - 2475MHz Parent unit: 2407.5 - 2475 MHz Maximum power used by the transmitter: 0.1W (100mW)
Channels	32
LCD	7" Color LCD (IPS 1024 x 600 pixels)
Nominal effective range	Maximum power allowed by FCC and IC. Actual operating range may vary according to environmental conditions at the time of use.
Power requirements	Parent unit: 3.7V 5000mAh, 18.5Wh Lithium-ion battery Baby unit power adapter: Output: 5V DC @ 1A Parent unit power adapter: Output: 5V DC @ 2A

GENERAL PRODUCT CARE

To keep this product working well and looking good, follow these guidelines:

- Avoid placing near heating appliances and devices that generate electrical noise (for example, motors or fluorescent lamps).
- DO NOT expose to direct sunlight or moisture.
- Avoid dropping the product or treating it roughly.
- Clean with a soft damp cloth.
- Clean the USB charging port of dust, dirt, and lint regularly.
- DO NOT immerse the parent unit or the baby unit in water and do not clean under running water.
- DO NOT use solvents, household cleaning sprays, or liquid cleaners.
- Make sure the parent unit and the baby unit are dry before reconnecting to the mains supply.

STORAGE

When you are not going to use the video monitor for some time, store the parent unit, the baby unit and the adapters in a cool, dry place.

DISCLAIMER AND LIMITATION OF LIABILITY

VTech Communications, Inc. and its suppliers assume no responsibility for any damage or loss resulting from the use of this user's manual. VTech Communications, Inc. and its suppliers assume no responsibility for any loss or claims by third parties that may arise through the use of this product.

Company: VTech Communications, Inc.
Address: 9020 SW Washington Square Road - Ste 555 Tigard, OR 97223, United States
Phone: 1 (800) 595-9511 in the U.S. or 1 (800) 267-7377 in Canada

NOTE: Before calling for service, please review the user's manual - a check of the Product's controls and features may save you a service call.
Except as provided by applicable law, you assume the risk of loss or damage during transit and transportation and are responsible for delivery or handling charges incurred in the transport of the Product(s) to the service location. VTech will return replaced Product under this limited warranty. Transportation, delivery or handling charges are prepaid. VTech assumes no risk for damage or loss of the Product in transit.

What must you return with the Product to get warranty service?

1. Return the entire original package and contents including the Product to the VTech service location along with a description of the malfunction or difficulty; and
2. Include a "valid proof of purchase" (sales receipt) identifying the Product purchased (Product model) and the date of purchase or receipt; and
3. Provide your name, complete and correct mailing address, and telephone number.

Other limitations
This warranty is the complete and exclusive agreement between you and VTech. It supersedes all other written or oral communications related to this Product. VTech provides no other warranties for this Product. The warranty exclusively describes all of VTech's responsibilities regarding the Product. There are no other express warranties. No one is authorized to make modifications to this limited warranty and you should not rely on any such modification. State/Provincial Law Rights: This warranty gives you specific legal rights, and you may also have other rights, which vary from state to state or province to province.

Limitations: Implied warranties, including those of fitness for a particular purpose and merchantability (an unwritten warranty that the Product is fit for ordinary use) are limited to one year from the date of purchase. Some states/provinces do not allow limitations on how long an implied warranty lasts, so the above limitation may not apply to you. In no event shall VTech be liable for any indirect, special, incidental, consequential, or similar damages (including, but not limited to lost profits or revenue, inability to use the Product or other associated equipment, the cost of substitute equipment, and claims by third parties) resulting from the use of this Product. Some states/provinces do not allow the exclusion or limitation of incidental or consequential damages, so the above limitation or exclusion may not apply to you.

Please retain your original sales receipt as proof of purchase.

 **Product Recycling**
Recycle this product when you are done with it. For more information, scan the QR code or visit vtechphones.com/recycle.



 Specifications are subject to change without notice.
© 2024 VTech Communications, Inc.
All rights reserved. 09/24: 346700_346800_US_QSG_V1

