

TEST REPORT

Report No.: 24120199HKG-002

Application For Original Grant of 47 CFR Part 15 Certification

New Family of RSS-247 Issue 3 Equipment Certification

Video Baby Monitor

FCC ID: EW780-2655-01C

IC: 1135B-80265501C

Prepared and Checked by:

Approved by:

Signed on File

Leung Chun Ning, Peter
Assistant Engineer

Wong Cheuk Ho, Herbert
Assistant Manager

Date: January 13, 2025

Intertek's standard Terms and Conditions can be obtained at our website <http://www.intertek.com/terms/>.

The test report only allows to be revised within the retention period unless further standard or the requirement was noticed.

This report is for the exclusive use of Intertek's Client and is provided pursuant to the agreement between Intertek and its Client. Intertek's responsibility and liability are limited to the terms and conditions of the agreement. Intertek assumes no liability to any party, other than to the Client in accordance with the agreement, for any loss, expense or damage occasioned by the use of this report. Only the Client is authorized to permit copying or distribution of this report and then only in its entirety. Any use of the Intertek name or one of its marks for the sale or advertisement of the tested material, product or service must first be approved in writing by Intertek. The observations and test results in this report are relevant only to the sample tested. This report by itself does not imply that the material, product, or service is or has ever been under an Intertek certification program.

© 2017 Intertek

TEST REPORT

GENERAL INFORMATION

| | |
|------------------------------------|--|
| Grantee: | VTech Telecommunications Ltd. |
| Grantee Address: | 23/F., Tai Ping Industrial Centre, Block 1, 57 Ting Kok Road, Tai Po, Hong Kong. |
| Manufacturer Name: | VTech (Dongguan) Telecommunications Limited |
| Manufacturer Address: | VTech Science Park, Xia Ling Bei Management Zone, Liaobu, Dongguan, Guangdong, China. |
| FCC Specification Standard: | FCC Part 15, October 1, 2023 Edition |
| FCC ID: | EW780-2655-01C |
| FCC Model(s): | VM924 PU, VM924-2 PU, VM924-3 PU, VM924-4 PU |
| IC Specification Standard: | RSS-247 Issue 3, August 2023 RSS-Gen Issue 5 Amendment 2, February 2021 |
| IC: | 1135B-80265501C |
| HVIN: | 35-202489PU |
| PMN: | VM924 PU, VM924-2 PU, VM924-3 PU, VM924-4 PU |
| Type of EUT: | Spread Spectrum Transmitter |
| Description of EUT: | Video Baby Monitor |
| Sample Receipt Date: | December 04, 2024 |
| Date of Test: | December 04, 2024 to December 17, 2024 |
| Report Date: | January 13, 2025 |
| Environmental Conditions: | Temperature: +10 to 40°C Humidity: 10 to 90% |
| Conclusion: | Test was conducted by client submitted sample. The submitted sample as received complied with the 47 CFR Part 15 / RSS-247 Issue 3 Certification. |

TEST REPORT

TABLE OF CONTENTS

EXHIBIT 1 TEST RESULTS SUMMARY & STATEMENT OF COMPLIANCE..... 4

 1.1 Summary of Test Results4

 1.2 Statement of Compliance.....4

EXHIBIT 2 GENERAL DESCRIPTION 5

 2.1 Product Description5

 2.2 Test Methodology5

 2.3 Test Facility6

 2.4 Related Submittal Grants6

EXHIBIT 3 SYSTEM TEST CONFIGURATION 7

 3.1 Justification7

 3.2 EUT Exercising Software.....8

 3.3 Details of EUT and Description of Accessories9

 3.4 Measurement Uncertainty.....9

EXHIBIT 4 TEST RESULTS..... 10

 4.1 Maximum Conducted (Peak) Output Power at Antenna Terminals10

 4.2 Maximum 20dB RF Bandwidth11

 4.3 Minimum Number of Hopping Frequencies.....11

 4.4 Minimum Hopping Channel Carrier Frequency Separation.....13

 4.5 Average Channel Occupancy Time15

 4.6 Out of Band Conducted Emissions16

 4.7 Field Strength Calculation18

 4.8 Transmitter Radiated Emission in Restricted Bands and Spurious Emission19

 4.9 AC Power Line Conducted Emission26

EXHIBIT 5 EQUIPMENT LIST..... 30

TEST REPORT

EXHIBIT 1 TEST RESULTS SUMMARY & STATEMENT OF COMPLIANCE

1.1 Summary of Test Results

| Test Items | FCC Part 15 Section | RSS-210/ RSS-Gen [#] | Results | Details See Section |
|---|---------------------|----------------------------------|---------|------------------------|
| Antenna Requirement | 15.203 | 8.3 [#] | Pass | 2.1 |
| Max. Conducted Output Power | 15.247(b)(1) & (4) | 5.4(2) | Pass | 4.1 |
| Max. 20dB RF Bandwidth | N/A | 5.1(1) | N/A | 4.2 |
| Min. No. of Hopping Frequencies | 15.247(a)(1)(iii) | 5.1(4) | Pass | 4.3 |
| Min. Hopping Channel Carrier Frequency Separation | 15.247(a)(1) | 5.1(2) | Pass | 4.4 |
| Average Time of Occupancy | 15.247(a)(1)(iii) | 5.1(4) | Pass | 4.5 |
| Out of Band Antenna Conducted Emission | 15.247(d) | 5.5 | Pass | 4.6 |
| Radiated Emission in Restricted Bands and Spurious Emissions | 15.247(d) | 8.10 [#] | Pass | 4.8 |
| AC Power Line Conducted Emission | 15.207 & 15.107 | 8.8 [#] | Pass | 4.9 |

Note: Pursuant to FCC Part 15 Section 15.215(c), the 20dB bandwidth of the emission was contained within the frequency band designated (mentioned as above) which the EUT operated. The effects, if any, from frequency sweeping, frequency hopping, other modulation techniques and frequency stability over expected variations in temperature and supply voltage were considered.

1.2 Statement of Compliance

The equipment under test is found to be complying with the following standards:

FCC Part 15, October 1, 2023 Edition
RSS-247 Issue 3, August 2023
RSS-Gen Issue 5 Amendment 2, February 2021

TEST REPORT

EXHIBIT 2 GENERAL DESCRIPTION

2.1 Product Description

The VM924 PU (35-202489PU) is a Video Monitor - Parent Unit.

The Equipment Under Test (EUT) operates at frequency range of 2405MHz to 2475MHz. There are totally 32 non-overlapping channels with 16 active channels out of the 32 channels. The channels are shown in below table.

| | | | | |
|--------|--------|------|------|--------|
| 2405 | 2407 | 2409 | 2411 | 2413 |
| 2415 | 2418 | 2420 | 2422 | 2424 |
| 2426 | 2428 | 2430 | 2433 | 2435 |
| 2437 | 2439 | 2441 | 2444 | 2446 |
| 2450 | 2452 | 2454 | 2456 | 2458.5 |
| 2460.5 | 2462.5 | 2467 | 2469 | 2471 |
| 2473 | 2475 | | | |

The EUT is powered by AC/DC Adaptor.

(Model: VT05EUS05100; Input: 100-240VAC 50/60Hz; Output: 5.0VDC 1.0A)

(Model: A318-050100W-US2; Input: 100-240VAC 50/60Hz; Output: 5.0VDC 1.0A)

The antenna(s) used in the EUT is integral, and the test sample is a prototype.

Maximum Antenna Gain: 2dBi

For FCC, the Model(s): VM924-2 PU, VM924-3 PU, VM924-4 PU are the same as the Model: VM924 PU in electronics/electrical designs including software & firmware, PCB layout and construction design/physical design/enclosure as declared by client. The only differences between these models are the number of identical baby unit(s) contained in the package to be sold for marketing purpose as declared by client.

The circuit description and frequency hopping algorithm are attached in the Appendix and saved with filename: descri.pdf.

2.2 Test Methodology

Both AC power line-conducted and radiated emission measurements were performed according to the procedures in ANSI C63.10 (2013). Preliminary radiated scans and all radiated measurements were performed in radiated emission test sites. All Radiated tests were performed at an antenna to EUT distance of 3 meters, unless stated otherwise in the "**Justification Section**" of this Application. Antenna port conducted measurements were performed according to ANSI C63.10 (2013) and KDB Publication No. 558074 D01 v05r02 (April 02, 2019). All other measurements were made in accordance with the procedures in 47 CFR Part 2 and RSS-Gen Issue 5 Amendment 2, February 2021.

TEST REPORT

2.3 Test Facility

The radiated emission test site, AC power line conducted measurement facility and antenna port conducted measurement facility used to collect the radiated data, AC Power Line conducted data, and conductive data are at Intertek Testing Services Hong Kong Ltd., which is located at Workshop No. 3, G/F., World-Wide Industrial Centre, 43-47 Shan Mei Street, Fo Tan, Sha Tin, N.T., Hong Kong SAR, China. This test facility and site measurement data have been fully placed on file with FCC and Industry Canada No.: 2042H, CABID is "HKAP01".

2.4 Related Submittal Grants

This is a single application for certification of a transceiver (FHSS Portion).

TEST REPORT

EXHIBIT 3 SYSTEM TEST CONFIGURATION

3.1 Justification

For radiated emissions testing, the equipment under test (EUT) was setup to transmit / receive continuously to simplify the measurement methodology. Care was taken to ensure proper power supply voltages during testing. During testing, all cables (if any) were manipulated to produce worst case emissions.

The EUT is powered by AC/DC Adaptor.

(Model: VT05EUS05100; Input: 100-240VAC 50/60Hz; Output: 5.0VDC 1.0A)

(Model: A318-050100W-US2; Input: 100-240VAC 50/60Hz; Output: 5.0VDC 1.0A)

For the measurements, the EUT was attached to a plastic stand if necessary and placed on the wooden turntable at 0.8m height from the ground plane for emission testing at or below 1GHz and 1.5m for emission measurements above 1GHz. If the baby unit attached to peripherals, they were connected and operational (as typical as possible). The parent unit was remotely located as far from the antenna and the baby as possible to ensure full power transmission from the parent unit. Else, the base was wired to transmit full power with modulation.

The signal was maximized through rotation and placement in the three orthogonal axes. The antenna height and polarization were varied during the search for maximum signal level. The antenna height was varied from 1 to 4 meters. Radiated emissions were taken at three meters unless the signal level was too low for measurement at that distance. If necessary, a pre-amplifier was used and/or the test was conducted at a closer distance.

For any intentional radiator powered by AC power line, measurements of the radiated signal level of the fundamental frequency component of the emission was performed with the supply voltage varied between 85% and 115% of the nominal rated supply voltage.

For transmitter radiated measurement, the spectrum analyzer resolution bandwidth was 100 kHz for frequencies below 1000 MHz. The resolution bandwidth was 3 MHz for frequencies above 1000 MHz.

Radiated emission measurement for transmitter were performed from the lowest radio frequency signal generated in the device which is greater than 9 kHz to the tenth harmonic of the highest fundamental frequency or to 40 GHz, whichever is lower. Receiver was performed from 30MHz to the fifth harmonic of the highest frequency or 40GHz, whichever is lower.

Emission that are directly caused by digital circuits in the transmit path and transmitter portion were measured, and the limit are according to FCC Part 15 Section 15.209. Digital circuitries used to control additional functions other than the operation of the transmitter are subject to FCC Part 15 Section 15.109 Limits.

TEST REPORT

3.1 Justification (Cont'd)

Detector function for radiated emissions was in peak mode. Average readings, when required, were taken by measuring the duty cycle of the equipment under test and subtracting the corresponding amount in dB from the measured peak readings. A detailed description for the calculation of the average factor can be found in section 4.3.4.

Determination of pulse desensitization was made according to *Hewlett Packard Application Note 150-2, Spectrum Analysis... Pulsed RF*. The effective period (Teff) was referred to Exhibit 4.3.4. With the resolution bandwidth 1MHz and spectrum analyzer IF bandwidth 3dB, the pulse desensitization factor was 0dB.

For AC line conducted emission test, the EUT along with its peripherals were placed on a 1.0m(W)x1.5m(L) and 0.8m in height wooden table and the EUT was adjusted to maintain a 0.4 meter space from a vertical reference plane. The EUT was connected to power mains through a line impedance stabilization network (LISN), which provided 50ohm coupling impedance for measuring instrument. The LISN housing, measuring instrument case, reference ground plane, and vertical ground plane were bounded together. The excess power cable between the EUT and the LISN was bundled.

All connecting cables of EUT and peripherals were manipulated to find the maximum emission.

All relevant operation modes have been tested, and the worst-case data is included in this report.

3.2 EUT Exercising Software

The EUT exercise program (ComTestSerial v3.0.0.108) used during radiated and conducted testing was designed to exercise the various system components in a manner similar to a typical use.

TEST REPORT

3.3 Details of EUT and Description of Accessories

Details of EUT:

An AC/DC Adaptor (Provided with the unit) was used to power the device. Their descriptions are listed below.

An AC/DC adaptor (Model: VT05EUS05100; Input: 100-240VAC 50/60Hz; Output: 5.0VDC 1.0A) (Provided by Applicant)

An AC/DC adaptor (Model: A318-050100W-US2; Input: 100-240VAC 50/60Hz; Output: 5.0VDC 1.0A) (Provided by Applicant)

Description of Accessories:

Baby Unit, Model: VM924 BU, FCC ID: EW780-2655-00C (Provided by Applicant)

3.4 Measurement Uncertainty

Decision Rule for compliance: For FCC/IC standard, the measured value must be within the limits of applicable standard without accounting for the measurement uncertainty. For EN/IEC/HKTA/HKTC standard, conformity rules will be used as per standard directly excepted EN/IEC 61000-3-2, EN/IEC 61000-3-3, HKTA1004, HKCA1008, HKTA1019, HKTA1020, HKTA1041 and HKTA1044.

Uncertainty and Compliance - Unless the standard specifically states that measured values are to be extended by the measurement uncertainty in determining compliance, all compliance determinations are based on the actual measured value.

TEST REPORT

EXHIBIT 4 TEST RESULTS

4.1 Maximum Conducted (Peak) Output Power at Antenna Terminals

RF Conducted measurement Test Setup by a Spectrum Analyzer

The figure below shows the test setup, which is utilized to make these measurements.

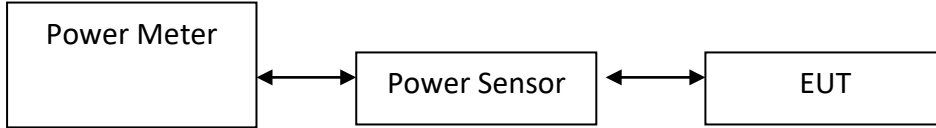

- The antenna power of the EUT was connected to the input of a power meter. Power was read directly and cable loss correction was added to the reading to obtain power at the EUT antenna terminals.
- The antenna port of the EUT was connected to the input of a spectrum analyzer. The analyzer was set for RBW>20dB bandwidth and power was read directly in dBm. External attenuation and cable loss were compensated for using the OFFSET function of the analyzer.

Parent Unit Peak Antenna Gain = 2 dBi

| Frequency (MHz) | Output in dBm | Output in mWatt |
|----------------------|---------------|-----------------|
| Low Channel: 2405 | 15.5 | 35.48 |
| Middle Channel: 2441 | 16.9 | 48.98 |
| High Channel: 2475 | 15.1 | 32.36 |

Cable loss: 0.5dB External Attenuation: 0dB

Cable loss, external attenuation: included in OFFSET function
 added to SA raw reading

dBm Max. Output Level = 16.9 dBm

Limits:

0.125W (21dBm) for antennas with gains of 6dBi or less.

TEST REPORT

4.2 Maximum 20dB RF Bandwidth

The figure below shows the test setup, which is utilized to make these measurements.

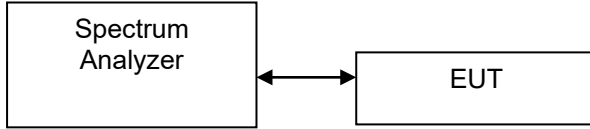

The antenna port of the EUT was connected to the input of a spectrum analyzer. Analyzer RES BW was chosen so that the display was a result of the hopping channel modulation. For each RF output channel investigated, the spectrum analyzer center frequency was set to the channel carrier. A PEAK output reading was taken, a DISPLAY line was drawn 20dB lower than PEAK level. The 20dB bandwidth was determined from where the channel output spectrum intersected the display line.

Parent Unit (Refer to Test Data.pdf)

| Frequency (MHz) | 20dB Bandwidth (kHz) |
|-----------------------------|----------------------|
| Low Channel: 2405 (P.12) | 2082 |
| Middle Channel: 2441 (P.24) | 2097 |
| High Channel: 2475 (P.31) | 1483 |

Limits:

N/A for 2400-2483.5MHz

4.3 Minimum Number of Hopping Frequencies

The figure below shows the test setup, which is utilized to make these measurements.

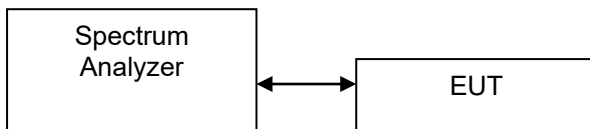

With the analyzer set to MAX HOLD readings were taken for 2-3 minutes in each band. The channel peaks so recorded were added together, and the total number compared to the minimum number of channels required in the regulation.

| Parent Unit | |
|--------------------------|----|
| No. of Hopping Channels: | 16 |

Minimum Requirements:

At least 15 hopping channels for 2400MHz-2483.5MHz

The plots of number of hopping frequencies are saved as below.

TEST REPORT

PLOTS OF NUMBER OF HOPPING FREQUENCIES

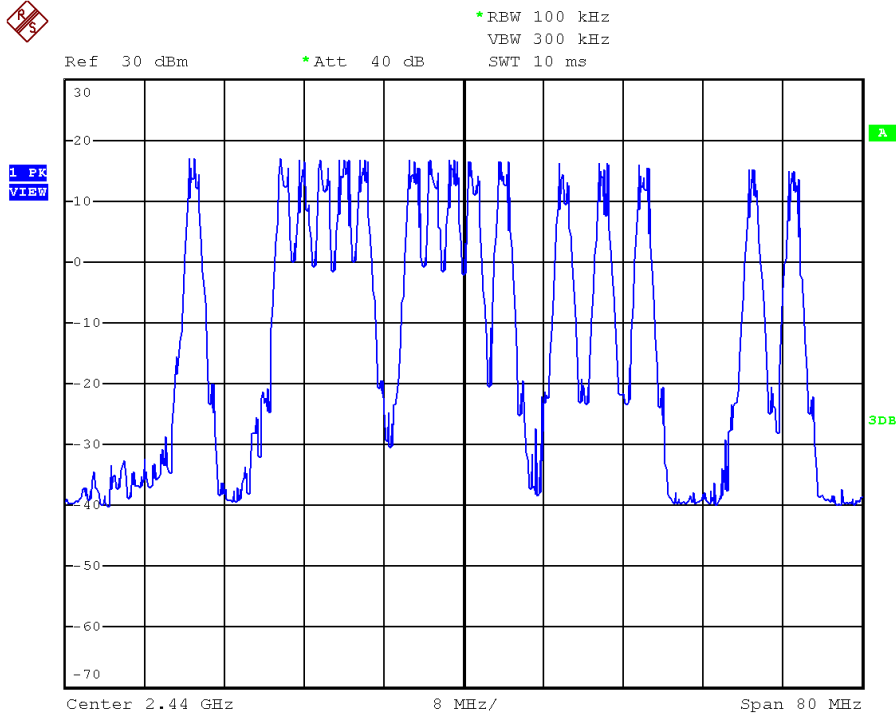

TEST REPORT

4.4 Minimum Hopping Channel Carrier Frequency Separation

The figure below shows the test setup, which is utilized to make these measurements.

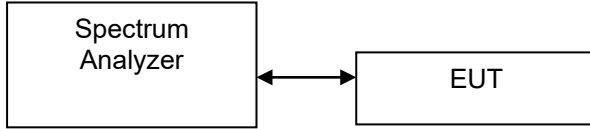

Using the DELTA MARKER function of the analyzer, the frequency separation between two adjacent channels was measured and met the requirement.

| Parent Unit | |
|--|---------|
| Channel Separation (Channel 8 and Channel 9) | 2000kHz |

Limits:

The channel separation must be larger than:
2/3 of 20dB bandwidth of hopping channel: 1398kHz

The plot(s) of hopping channel carrier frequency separation is saved as below.

TEST REPORT

PLOTS OF HOPPING CHANNEL CARRIER FREQUENCY SEPARATION

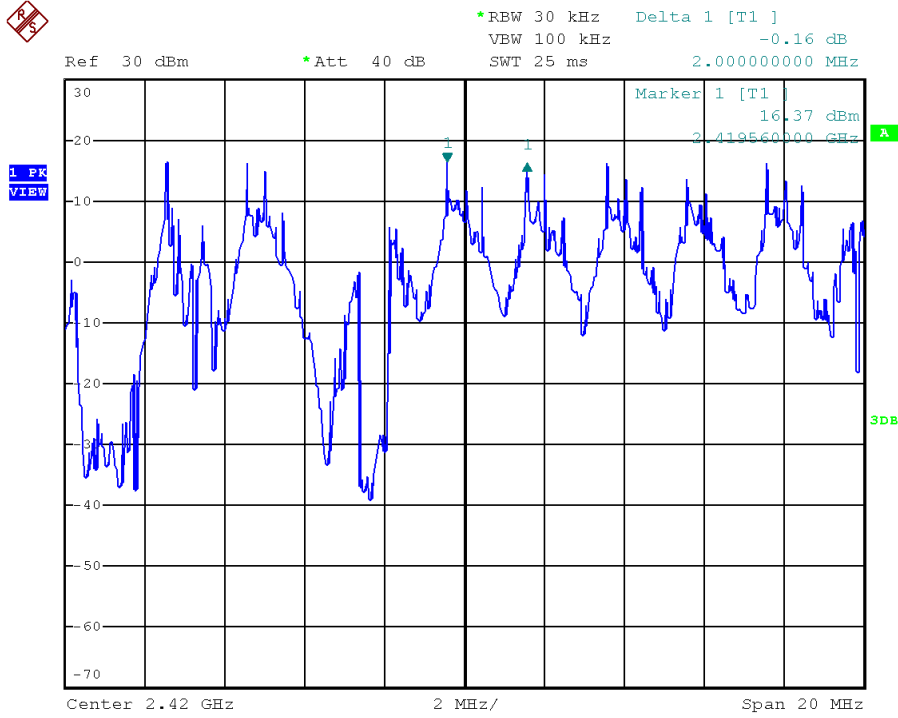

TEST REPORT

4.5 Average Channel Occupancy Time

The figure below shows the test setup, which is utilized to make these measurements.

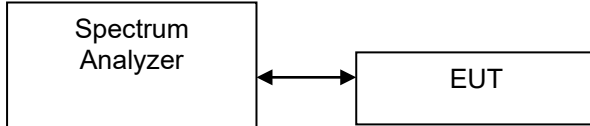

The spectrum analyzer center frequency was set to one of the known hopping channels. The SWEEP was set to 1ms, the SPAN was set to ZERO SPAN, and the TRIGGER was set to VIDEO. The time duration of the transmission so captured was measured with the MARKER DELTA function.

The SWEEP was then set to the time required by the regulation (20 seconds for 902-928 MHz devices, if the 20dB bandwidth is less than 250kHz, 10 seconds for 902-928 MHz if the 20dB bandwidth is or greater than 250kHz, “0.4 seconds x Number of hopping channels employed” seconds for 2400-2483.5 MHz, 30 seconds for 5725-5850 MHz). The analyzer was set to SINGLE SWEEP, the total ON time was added and compared against the limit (0.4 seconds).

| Parent Unit (Worst-Case) (Refer to Test Data.pdf P.10) | |
|---|----------|
| Average Occupancy Time (Traffic – in a clear RF environment) = | 38.834ms |

Limits:

Average 0.4 seconds maximum occupancy in:
2400MHz-2483.5MHz
(Traffic – in a clear RF environment)

TEST REPORT

4.6 Out of Band Conducted Emissions

The figure below shows the test setup, which is utilized to make these measurements.

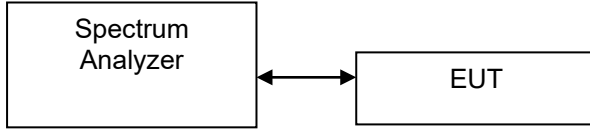

In any 100kHz bandwidth outside the EUT passband, the RF power produced by the modulation products of the spreading sequence, the information sequence, and the carrier frequency shall be at least 20dB below that of the maximum in-band 100 kHz emission.

The plot(s) of bandedge compliance is shown the worst-case which has been already considered between enable and disable the hopping function of the EUT.

Furthermore, delta measurement technique for measuring bandedge emissions was incorporated in the test of the edge at 2483.5MHz.

Limits:

All spurious emission and up to the tenth harmonic was measured and they were found to be at least 20 dB below the highest level of the desired power in the passband.

Parent Unit (Refer to Test Data.pdf)

| Frequency (MHz) | Out of Band Conducted Emissions | Band Edge (Frequency Dependent) | Band Edge (Frequency Independent) |
|----------------------|---------------------------------|---------------------------------|-----------------------------------|
| Low Channel: 2405 | P.21 | P.15 | P.4 |
| Middle Channel: 2441 | P.28 | N/A | N/A |
| High Channel: 2475 | P.40 | P.34 | P.7 |

TEST REPORT

OCCUPIED BANDWIDTH

The figure below shows the test setup, which is utilized to make these measurements.

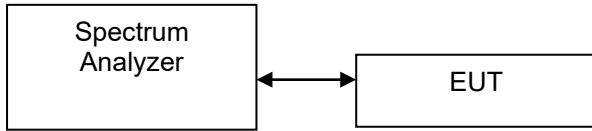

Occupied Bandwidth Results: (Parent Unit) (Refer to Test Data.pdf)

| Frequency (MHz) | Occupied Bandwidth (kHz) |
|-----------------------------|--------------------------|
| Low Channel: 2405 (P.13) | 1873 |
| Middle Channel: 2441 (P.25) | 1903 |
| High Channel: 2475 (P.32) | 1753 |

TEST REPORT

4.7 Field Strength Calculation

The field strength is calculated by adding the reading on the Spectrum Analyzer to the factors associated with preamplifiers (if any), antennas, cables, pulse desensitization and average factors (when specified limit is in average and measurements are made with peak detectors). A sample calculation is included below.

$$FS = RA + AF + CF - AG + PD + AV$$

where

| | | |
|----|---|---|
| FS | = | Field Strength in dB μ V/m |
| RA | = | Receiver Amplitude (including preamplifier) in dB μ V |
| CF | = | Cable Attenuation Factor in dB |
| AF | = | Antenna Factor in dB |
| AG | = | Amplifier Gain in dB |
| PD | = | Pulse Desensitization in dB |
| AV | = | Average Factor in -dB |

In the radiated emission table which follows, the reading shown on the data table may reflect the preamplifier gain. An example of the calculations, where the reading does not reflect the preamplifier gain, follows:

$$FS = RA + AF + CF - AG + PD + AV$$

Example:

Assume a receiver reading of 62.0 dB μ V is obtained. The antenna factor of 7.4 dB and cable factor of 1.6 dB is added. The amplifier gain of 29.0 dB is subtracted. The pulse desensitization factor of the spectrum analyzer is 0.0 dB, and the resultant average factor is -10.0 dB. The net field strength for comparison to the appropriate emission limit is 32.0 dB μ V/m. This value in dB μ V/m is converted to its corresponding level in μ V/m.

| | | |
|----|---|---|
| RA | = | 62.0 dB μ V |
| AF | = | 7.4 dB |
| CF | = | 1.6 dB |
| AG | = | 29 dB |
| PD | = | 0.0 dB |
| AV | = | -10 dB |
| FS | = | $62.0 + 7.4 + 1.6 - 29.0 + 0.0 + (-10.0) = 32.0$ dB μ V/m |

$$\text{Level in } \mu\text{V/m} = \text{Common Antilogarithm } [(32.0 \text{ dB}\mu\text{V/m})/20] = 39.8 \mu\text{V/m}$$

TEST REPORT

4.8 Transmitter Radiated Emission and Spurious Emission

Data is included of the worst-case configuration (the configuration which resulted in the highest emission levels). A sample calculation, configuration photographs and data tables of the emissions are included.

The data on the following pages list the significant emission frequencies, the limit and the margin of compliance.

4.8.1 Radiated Emission Configuration Photograph

Worst Case Radiated Emission

at Parent Unit: 288.02MHz

The worst case radiated emission configuration photographs are attached in the Appendix and saved with filename: setup photos.pdf

4.8.2 Radiated Emission Data

The data in tables 1-5 list the significant emission frequencies, the limit and the margin of compliance.

Judgement –

Parent Unit: Passed by 2.8 dB

TEST REPORT

4.8.3 Radiated Emission Test Setup

The figure below shows the test setup, which is utilized to make these measurements.

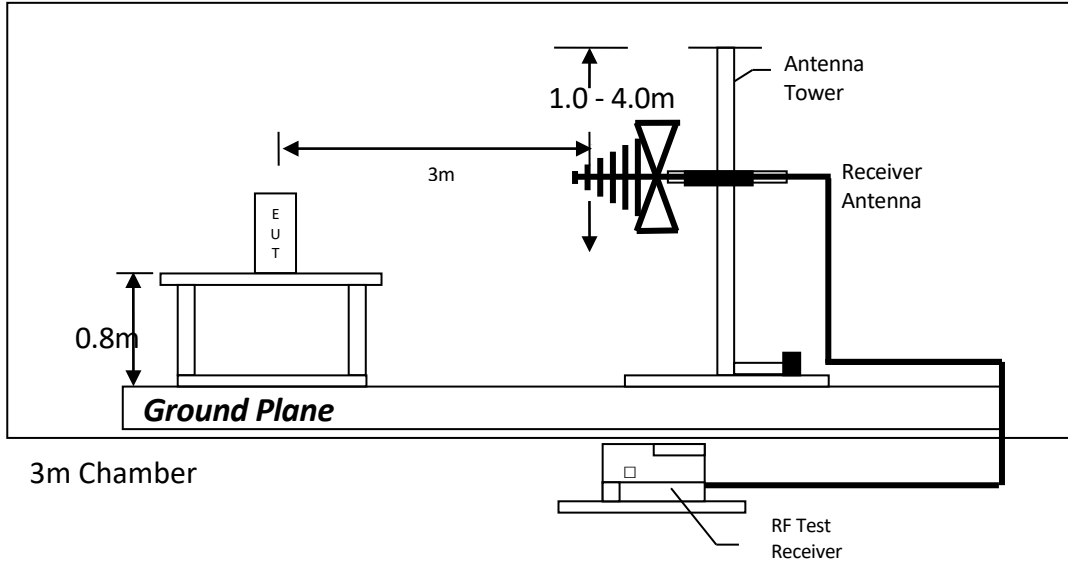

Test setup of radiated emissions up to 1GHz

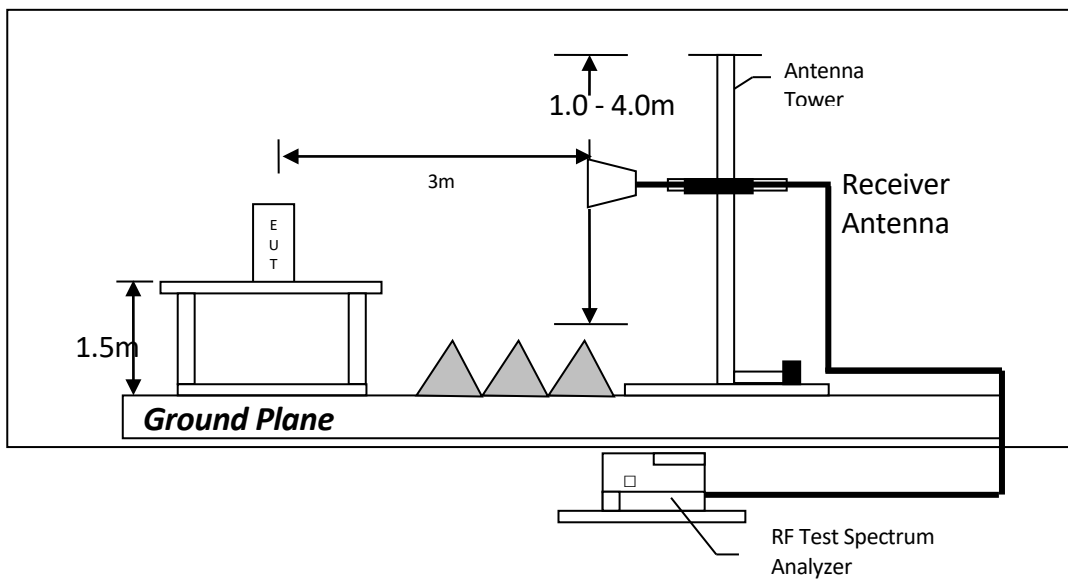

Test setup of radiated emissions above 1GHz

TEST REPORT

RADIATED EMISSION DATA

Mode: TX-Channel 2405

Table 1, Parent Unit

| Polarization | Frequency (MHz) | Reading (dB μ V) | Pre-Amp Gain (dB) | Antenna Factor (dB) | Net at 3m (dB μ V/m) | Average Limit at 3m (dB μ V/m) | Margin (dB) |
|--------------|-----------------|----------------------|-------------------|---------------------|--------------------------|------------------------------------|-------------|
| V | 2390.000 | 43.6 | 33 | 29.4 | 40.0 | 54.0 | -14.0 |
| V | 4810.000 | 34.8 | 33 | 34.9 | 36.7 | 54.0 | -17.3 |
| V | 7215.000 | 33.2 | 33 | 37.9 | 38.1 | 54.0 | -15.9 |
| H | 9620.000 | 33.4 | 33 | 40.4 | 40.8 | 54.0 | -13.2 |
| H | 12025.000 | 37.7 | 33 | 40.5 | 45.2 | 54.0 | -8.8 |
| H | 14430.000 | 38.5 | 33 | 40.0 | 45.5 | 54.0 | -8.5 |

| Polarization | Frequency (MHz) | Reading (dB μ V) | Pre-Amp Gain (dB) | Antenna Factor (dB) | Net at 3m - Peak (dB μ V/m) | Peak Limit at 3m (dB μ V/m) | Margin (dB) |
|--------------|-----------------|----------------------|-------------------|---------------------|---------------------------------|---------------------------------|-------------|
| V | 2390.000 | 64.2 | 33 | 29.4 | 60.6 | 74.0 | -13.4 |
| V | 4810.000 | 60.0 | 33 | 34.9 | 61.9 | 74.0 | -12.1 |
| V | 7215.000 | 57.3 | 33 | 37.9 | 62.2 | 74.0 | -11.8 |
| H | 9620.000 | 46.7 | 33 | 40.4 | 54.1 | 74.0 | -19.9 |
| H | 12025.000 | 50.9 | 33 | 40.5 | 58.4 | 74.0 | -15.6 |
| H | 14430.000 | 52.1 | 33 | 40.0 | 59.1 | 74.0 | -14.9 |

- NOTES:
1. Peak detector is used for the emission measurement.
 2. Average detector is used for the average data of emission measurement.
 3. All measurements were made at 3 meters.
 4. Negative value in the margin column shows emission below limit.
 5. Horn antenna is used for the emission over 1000MHz
 6. Emissions within the restricted band meets the requirement of FCC Part 15 Section 15.205 / RSS-Gen Section 8.10
 7. Measurement Uncertainty is ± 5.3 dB at a level of confidence of 95%.

TEST REPORT

RADIATED EMISSION DATA

Mode: TX-Channel 2441

Table 2, Parent Unit

| Polarization | Frequency (MHz) | Reading (dBμV) | Pre-Amp Gain (dB) | Antenna Factor (dB) | Net at 3m (dBμV/m) | Average Limit at 3m (dBμV/m) | Margin (dB) |
|--------------|-----------------|----------------|-------------------|---------------------|--------------------|------------------------------|-------------|
| V | 4882.000 | 34.1 | 33 | 34.9 | 36.0 | 54.0 | -18.0 |
| V | 7323.000 | 33.1 | 33 | 37.9 | 38.0 | 54.0 | -16.0 |
| H | 9764.000 | 34.2 | 33 | 40.4 | 41.6 | 54.0 | -12.4 |
| H | 12205.000 | 38.1 | 33 | 40.5 | 45.6 | 54.0 | -8.4 |
| V | 14646.000 | 38.6 | 33 | 38.4 | 44.0 | 54.0 | -10.0 |

| Polarization | Frequency (MHz) | Reading (dBμV) | Pre-Amp Gain (dB) | Antenna Factor (dB) | Net at 3m - Peak (dBμV/m) | Peak Limit at 3m (dBμV/m) | Margin (dB) |
|--------------|-----------------|----------------|-------------------|---------------------|---------------------------|---------------------------|-------------|
| V | 4882.000 | 58.8 | 33 | 34.9 | 60.7 | 74.0 | -13.3 |
| V | 7323.000 | 55.1 | 33 | 37.9 | 60.0 | 74.0 | -14.0 |
| H | 9764.000 | 47.5 | 33 | 40.4 | 54.9 | 74.0 | -19.1 |
| H | 12205.000 | 51.7 | 33 | 40.5 | 59.2 | 74.0 | -14.8 |
| V | 14646.000 | 51.7 | 33 | 38.4 | 57.1 | 74.0 | -16.9 |

- NOTES: 1. Peak detector is used unless otherwise stated.
 2. Average detector is used for the average data of emission measurement.
 3. All measurements were made at 3 meters.
 4. Negative value in the margin column shows emission below limit.
 5. Horn antenna is used for the emission over 1000MHz
 6. Emissions within the restricted band meets the requirement of FCC Part 15 Section 15.205 / RSS-Gen Section 8.10
 7. Measurement Uncertainty is ±5.3dB at a level of confidence of 95%.

TEST REPORT

RADIATED EMISSION DATA

Mode: TX-Channel 2475

Table 3, Parent Unit

| Polarization | Frequency (MHz) | Reading (dBμV) | Pre-Amp Gain (dB) | Antenna Factor (dB) | Net at 3m (dBμV/m) | Average Limit at 3m (dBμV/m) | Margin (dB) |
|--------------|-----------------|----------------|-------------------|---------------------|--------------------|------------------------------|-------------|
| V | 2483.500 | 43.3 | 33 | 29.4 | 39.7 | 54.0 | -14.3 |
| V | 4950.000 | 33.8 | 33 | 34.9 | 35.7 | 54.0 | -18.3 |
| V | 7425.000 | 33.3 | 33 | 37.9 | 38.2 | 54.0 | -15.8 |
| V | 9900.000 | 33.6 | 33 | 40.4 | 41.0 | 54.0 | -13.0 |
| H | 12375.000 | 39.2 | 33 | 40.5 | 46.7 | 54.0 | -7.3 |
| H | 14850.000 | 38.9 | 33 | 38.4 | 44.3 | 54.0 | -9.7 |

| Polarization | Frequency (MHz) | Reading (dBμV) | Pre-Amp Gain (dB) | Antenna Factor (dB) | Net at 3m - Peak (dBμV/m) | Peak Limit at 3m (dBμV/m) | Margin (dB) |
|--------------|-----------------|----------------|-------------------|---------------------|---------------------------|---------------------------|-------------|
| V | 2483.500 | 62.8 | 33 | 29.4 | 59.2 | 74.0 | -14.8 |
| V | 4950.000 | 57.0 | 33 | 34.9 | 58.9 | 74.0 | -15.1 |
| V | 7425.000 | 56.0 | 33 | 37.9 | 60.9 | 74.0 | -13.1 |
| V | 9900.000 | 46.8 | 33 | 40.4 | 54.2 | 74.0 | -19.8 |
| H | 12375.000 | 52.3 | 33 | 40.5 | 59.8 | 74.0 | -14.2 |
| H | 14850.000 | 52.1 | 33 | 38.4 | 57.5 | 74.0 | -16.5 |

- NOTES:
1. Peak detector is used unless otherwise stated.
 2. Average detector is used for the average data of emission measurement.
 3. All measurements were made at 3 meters.
 4. Negative value in the margin column shows emission below limit.
 5. Horn antenna is used for the emission over 1000MHz
 6. Emissions within the restricted band meets the requirement of FCC Part 15 Section 15.205 / RSS-Gen Section 8.10
 7. Measurement Uncertainty is ±5.3dB at a level of confidence of 95%.

TEST REPORT

RADIATED EMISSION DATA

Mode: PU Operating

Table 4, Parent Unit (Adaptor: VT05EUS05100)

| Polarization | Frequency (MHz) | Reading (dB μ V) | Pre-amp (dB) | Antenna Factor (dB) | Net at 3m (dB μ V/m) | Limit at 3m (dB μ V/m) | Margin (dB) |
|--------------|-----------------|----------------------|--------------|---------------------|--------------------------|----------------------------|-------------|
| H | 117.976 | 38.3 | 16 | 14.0 | 36.3 | 43.5 | -7.2 |
| H | 124.349 | 40.2 | 16 | 14.0 | 38.2 | 43.5 | -5.3 |
| V | 130.906 | 41.7 | 16 | 14.0 | 39.7 | 43.5 | -3.8 |
| H | 287.986 | 36.1 | 16 | 22.0 | 42.1 | 46.0 | -3.9 |
| V | 392.718 | 32.3 | 16 | 25.0 | 41.3 | 46.0 | -4.7 |
| H | 445.074 | 31.9 | 16 | 26.0 | 41.9 | 46.0 | -4.1 |

- NOTES:
1. Quasi-Peak detector is used for the emission measurement.
 2. Average detector is used for the average data of emission measurement.
 3. All measurements were made at 3 meters.
 4. Negative value in the margin column shows emission below limit.
 5. Emissions within the restricted band meets the requirement of FCC Part 15 Section 15.205 / RSS-Gen Section 8.10
 6. Measurement Uncertainty is ± 5.3 dB at a level of confidence of 95%.

TEST REPORT

RADIATED EMISSION DATA

Mode: PU Operating

Table 5, Parent Unit (Adaptor: A318-050100W-US2)

| Polarization | Frequency (MHz) | Reading (dBμV) | Pre-amp (dB) | Antenna Factor (dB) | Net at 3m (dBμV/m) | Limit at 3m (dBμV/m) | Margin (dB) |
|--------------|-----------------|----------------|--------------|---------------------|--------------------|----------------------|-------------|
| H | 130.880 | 42.1 | 16 | 14.0 | 40.1 | 43.5 | -3.4 |
| H | 288.020 | 37.2 | 16 | 22.0 | 43.2 | 46.0 | -2.8 |
| H | 317.726 | 28.3 | 16 | 23.0 | 35.3 | 46.0 | -10.7 |
| H | 325.608 | 32.1 | 16 | 24.0 | 40.1 | 46.0 | -5.9 |
| V | 392.659 | 30.4 | 16 | 25.0 | 39.4 | 46.0 | -6.6 |
| V | 399.934 | 30.7 | 16 | 25.0 | 39.7 | 46.0 | -6.3 |

- NOTES:
1. Peak and Quasi-Peak detector are used for the emission measurement.
 2. Average detector is used for the average data of emission measurement.
 3. All measurements were made at 3 meters.
 4. Negative value in the margin column shows emission below limit.
 5. Emissions within the restricted band meets the requirement of FCC Part 15 Section 15.205 / RSS-Gen Section 8.10
 6. Measurement Uncertainty is ± 5.3 dB at a level of confidence of 95%.

TEST REPORT

4.9 AC Power Line Conducted Emission

EUT connects to AC power line. Emission Data is listed in following pages.

4.9.1 AC Power Line Conducted Emission Configuration Photograph

Worst Case Line-Conducted Configuration

at 0.375 MHz

The worst-case line conducted configuration photographs are attached in the Appendix and saved with filename: setup photos.pdf.

4.9.2 AC Power Line Conducted Emission Data

The plot(s) and data in the following pages list the significant emission frequencies, the limit and the margin of compliance.

Passed by 15.6 dB margin compare with CISPR Average limit.

4.9.3 Conducted Emission Test Setup

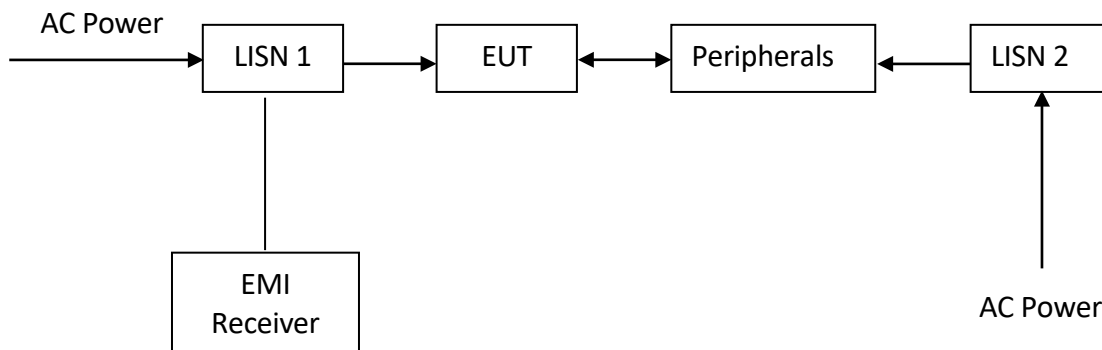

The EUT along with its peripherals were placed on a 1.0m(W)×1.5m(L) and 0.8m in height wooden table and the EUT was adjusted to maintain a 0.4 meter space from a vertical reference plane. The EUT was connected to power mains through a line impedance stabilization network (LISN), which provided 50 ohm coupling impedance for measuring instrument and the chassis ground was bounded to the horizontal ground plane of shielded room. The excess power cable between the EUT and the LISN was bundled.

All connecting cables of EUT and peripherals were moved to find the maximum emission.

TEST REPORT

AC POWER LINE CONDUCTED EMISSION

Worst Case: PU Operating (Adaptor: VT05EUS05100)

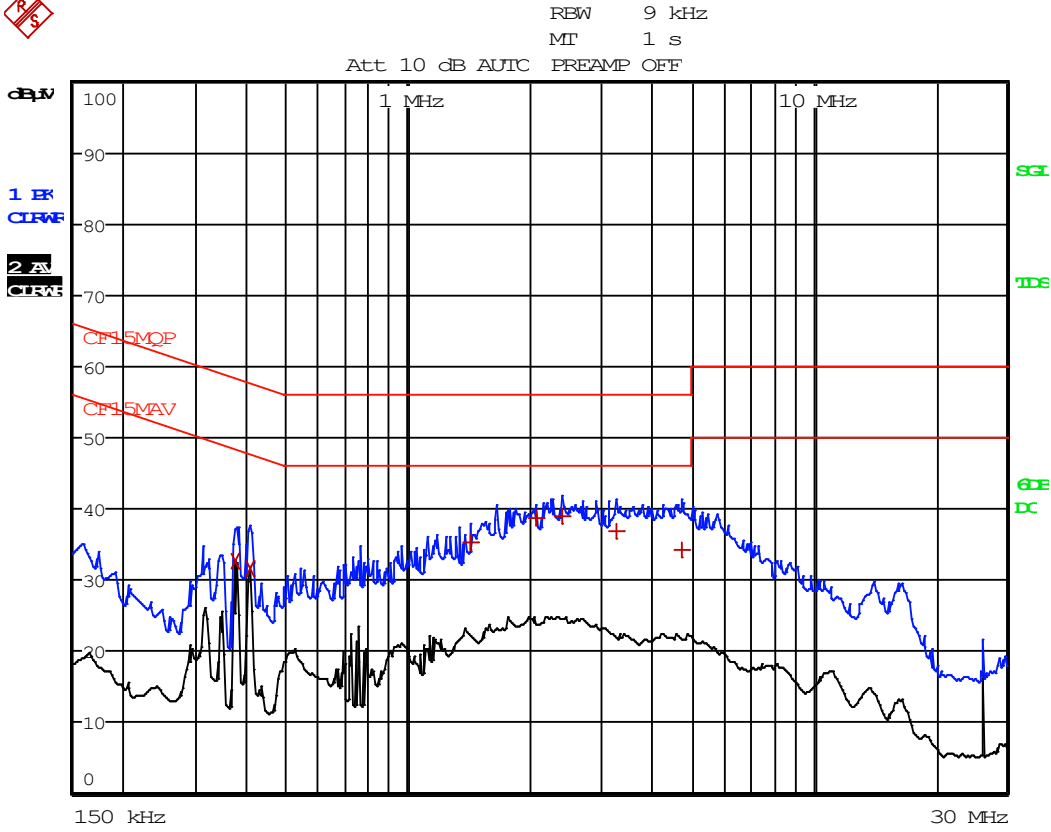

TEST REPORT

AC POWER LINE CONDUCTED EMISSION

Worst Case: PU Operating (Adaptor: VT05EUS05100)

EDIT PEAK LIST (Final Measurement Results)

Trace1: CF15MQP

Trace2: CF15MAV

Trace3: ---

| | TRACE | FREQUENCY | LEVEL dB μ V | | DELTA LIMIT dB |
|---|---------------|------------|------------------|----|----------------|
| 2 | CISPR Average | 375 kHz | 32.78 | L1 | -15.60 |
| 2 | CISPR Average | 406.5 kHz | 31.60 | L1 | -16.11 |
| 1 | Quasi Peak | 1.4235 MHz | 35.20 | N | -20.79 |
| 1 | Quasi Peak | 2.0805 MHz | 38.73 | N | -17.26 |
| 1 | Quasi Peak | 2.3955 MHz | 38.85 | N | -17.14 |
| 1 | Quasi Peak | 3.273 MHz | 36.85 | N | -19.14 |
| 1 | Quasi Peak | 4.7355 MHz | 34.24 | N | -21.75 |

TEST REPORT

AC POWER LINE CONDUCTED EMISSION

Worst Case: PU Operating (Adaptor: A318-050100W-US2)



RBW 120 kHz
MT 100 ms

Att 10 dB AUTOC PREAMP OFF

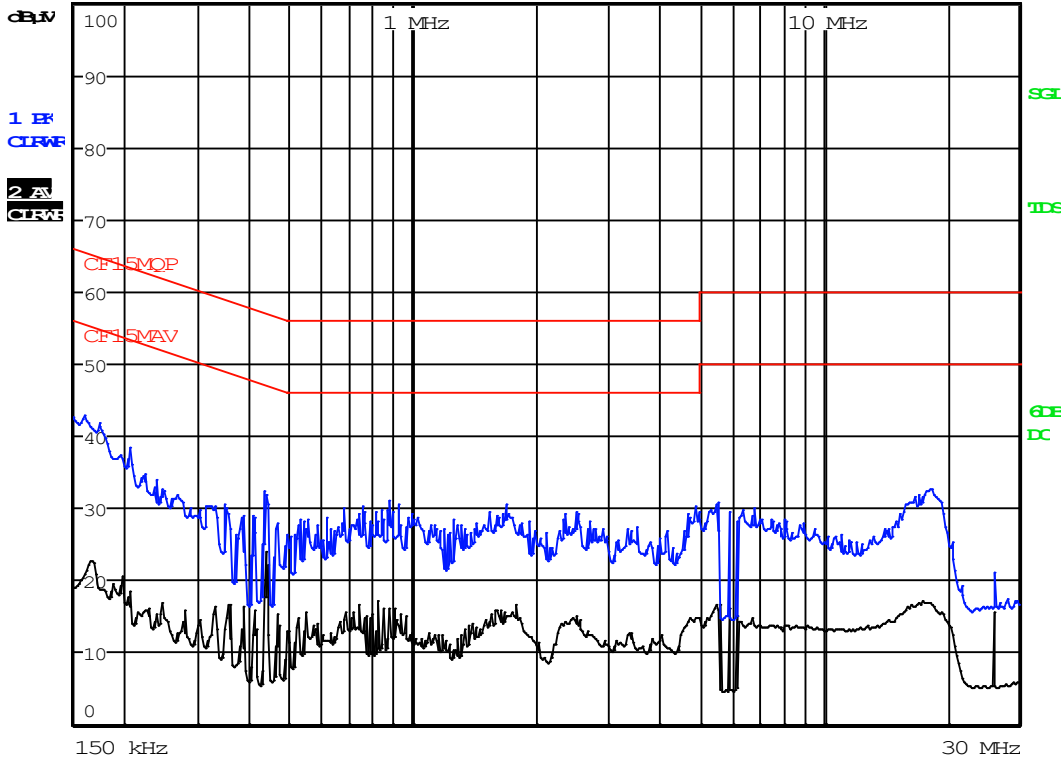

TEST REPORT

EXHIBIT 5 EQUIPMENT LIST

1) Radiated Emissions Test

| Equipment | EMI Test Receiver (9kHz to 26.5GHz) | Biconical Antenna (30MHz to 300MHz) | Log Periodic Antenna |
|----------------------|--|--|----------------------|
| Registration No. | EW-3156 | EW-3242 | EW-3243 |
| Manufacturer | ROHDESCHWARZ | EMCO | EMCO |
| Model No. | ESR26 | 3110C | 3148B |
| Calibration Date | January 31, 2024 | July 30, 2024 | July 30, 2024 |
| Calibration Due Date | January 31, 2025 | July 30, 2026 | January 30, 2026 |

| Equipment | Double Ridged Guide Antenna (1GHz - 18GHz) | Active Loop Antenna (H-field) (9kHz to 30MHz) | RF Preamplifier (9kHz to 6000MHz) |
|----------------------|--|---|--------------------------------------|
| Registration No. | EW-0194 | EW-3326 | EW-3006b |
| Manufacturer | EMCO | EMCO | SCHWARZBECK |
| Model No. | 3115 | 6502 | BBV9718 |
| Calibration Date | May 10, 2023 | January 05, 2024 | October 20, 2023 |
| Calibration Due Date | February 10, 2025 | July 05, 2025 | January 20, 2025 |

| Equipment | 2.4GHz Notch Filter | 14m Double Shield RF Cable (9kHz - 6GHz) | RF Cable 14m (1GHz to 26.5GHz) |
|----------------------|---------------------|--|-----------------------------------|
| Registration No. | EW-3435 | EW-2376 | EW-2781 |
| Manufacturer | MICROWAVE | RADIALL | GREATBILLION |
| Model No. | N0324413 | n m/br56/bnc m 14m | SMA m/SHF5MPU /SMA m ra14m,26G |
| Calibration Date | September 26, 2023 | September 19, 2023 | January 16, 2024 |
| Calibration Due Date | December 26, 2024 | December 19, 2024 | January 16, 2025 |

| Equipment | 12 metre RF Cable (1- 40)GHz | Pyramidal Horn Antenna |
|----------------------|---------------------------------|---------------------------|
| Registration No. | EW-2774 | EW-0905 |
| Manufacturer | GREATBILLION | EMCO |
| Model No. | SMA m-m ra 12m 40G outdoor | 3160-09 |
| Calibration Date | January 16, 2024 | December 15, 2023 |
| Calibration Due Date | January 16, 2025 | June 15, 2025 |

TEST REPORT

5.0 EQUIPMENT LIST (CONT'D)

2) Conducted Emissions Test

| Equipment | RF Cable 240cm (RG142) (9kHz to 30MHz) | Artificial Mains Network | EMI Test Receiver (9kHz to 3GHz) |
|----------------------|---|-----------------------------|-------------------------------------|
| Registration No. | EW-2454 | EW-3360 | EW-3095 |
| Manufacturer | RADIALL | ROHDESCHWARZ | ROHDESCHWARZ |
| Model No. | Bnc m st / 142 / bnc mra 240cm | ENV-216 | ESCI |
| Calibration Date | June 20, 2024 | April 07, 2024 | January 18, 2024 |
| Calibration Due Date | June 20, 2025 | April 07, 2025 | January 18, 2025 |

3) Conductive Measurement Test

| Equipment | RF Power Meter with Power Sensor (N1921A) | EMI Test Receiver (9kHz to 26.5GHz) |
|----------------------|---|--|
| Registration No. | EW-3309 | EW-3156 |
| Manufacturer | ROHDESCHWARZ | ROHDESCHWARZ |
| Model No. | NRP-Z81 | ESR26 |
| Calibration Date | January 23, 2024 | January 31, 2024 |
| Calibration Due Date | January 23, 2025 | January 31, 2025 |

4) Control Software for Radiated Emission

| Software Information | |
|----------------------|---------------------|
| Software Name | EMC32 |
| Manufacturer | ROHDESCHWARZ |
| Software version | 10.50.40 & 10.40.10 |

END OF TEST REPORT