

Go to www.vtechphones.com to register your product for enhanced warranty support and the latest Vtech product news.

RM5756HD
RM5756HD-2
5" Smart Wi-Fi 1080p
Video Monitor



For more support information

vtech
Quick start guide

Congratulations

on purchasing your new Vtech product.
Before using this baby monitor, please read the **Important safety instructions**.

What does HD Video Monitor do?

Vtech 5" Smart Wi-Fi 1080p Video Monitor allows you to stay close to your baby when you are on the move or away. This monitor is Wi-Fi enabled, using your home wireless network to stream live video and audio through the 1080p baby unit and 5-inch colour screen parent unit. It allows you to maintain a constant connection to your baby.

You can also monitor from your smartphone or mobile tablet.
Vtech 5" Smart Wi-Fi 1080p Video Monitor uses **MyVTech Baby Pro** app to let you instantly see and hear what's happening with your baby from anywhere in the world. The app can be downloaded from the App Store or the Google Play™ Store.

IMPORTANT SAFETY INSTRUCTIONS

The applied nameplate is located at the bottom of the baby unit's base. When using your equipment, basic safety precautions should always be followed to reduce the risk of fire, electric shock and injury, including the following:

- Follow all warnings and instructions marked on the product.
- Adult setup is required.
- CAUTION:** Do not install the baby unit at a height above 6.5 feet (2 meters).
- This product is intended as an aid. It is not a substitute for responsible and proper adult supervision and should not be used as such.
- This product is not intended for use as a medical monitor.
- Do not use this product near water, for example, near to a bath, sink, swimming pool or shower.
- CAUTION:** Use only the battery provided. There may be a risk of explosion if a wrong type of battery is used for the parent unit. The battery cannot be subjected to high or low extreme temperature and low air pressure at high altitude during use, storage or transportation. Disposal of battery into fire or a hot oven, or mechanically crushing or cutting of the battery can result in an explosion. Leaving the battery in an extremely high temperature surrounding environment can result in an explosion or the leakage of flammable liquid or gas. Battery subjected to extremely low air pressure may result in an explosion or the leakage of flammable liquid or gas. Dispose of used battery according to the instructions.
- Use only the adapters included with this product. Incorrect adapter polarity or voltage can seriously damage the product.

- Power adapters information:**
Baby Unit Output: 5V DC 3000mA
Vtech Telecommunications Ltd.
Model: VT05EU505100
Parent Unit Output: 5V DC 2A
Vtech Telecommunications Ltd.
Model: VT05EU505200
- Rechargeable battery information:**
3.7V 5000mAh, 18.5Wh Lithium-ion battery
Zuhai Great Power Energy Co., Ltd.
Model: GSPB06090-5Ah-3.7V-151P
- The power adapter is intended to be correctly oriented in a vertical or floor mount position. The prongs are not designed to hold the plug in place if it is plugged into a ceiling, under-the-table or cabinet outlet.
 - For pluggable equipment, the socket-outlet (power adapter) should be installed near the equipment and should be easily accessible.
 - Unplug this product from the wall outlet before cleaning. Do not use liquid or aerosol cleaners. Use a damp cloth for cleaning.
 - Do not cut off the power adapters to replace them with other plugs, as this causes a hazardous situation.
 - Do not allow anything to rest on the power cords. Do not install this product where the cords may be walked on or crimped.
 - This product should be operated only from the type of power source indicated on the marking label. If you are not sure of the type of power supply in your home, consult your dealer or local power company.
 - Do not overload wall outlets or use an extension cord.
 - Do not place this product on an unstable table, shelf, stand or other unstable surfaces.
 - This product should not be placed in any area where proper ventilation is not provided. Slots and openings in the back or bottom of this product are provided for ventilation. To protect them from overheating, these openings must not be blocked by placing the product on a soft surface such as a bed, sofa or rug. This product should never be placed near or over a radiator or heat source.
 - Never push objects of any kind into this product through the slots because they may touch dangerous voltage points or create a short circuit. Never spill liquid of any kind on the product.

SAVE THESE INSTRUCTIONS

- Cautions**
- Use and store the product at a temperature between 0°C and 40°C.
 - Burn hazard, fire hazard, explosion hazard associated with mishandling of the battery.
 - Do not expose the product to extreme cold, heat or direct sunlight. Do not put the product close to a heating source.
 - Warning—Strangulation Hazard—Children have STRANGLERED in cords.** Keep this cord out of the reach of children (more than 3 ft (0.9m) away). Do not remove this tag.
 - Never place the camera unit(s) inside the baby's cot or playpen. Never cover the camera unit(s) or parent unit with anything such as a towel or a blanket.
 - Other electronic products may cause interference with your camera unit. Try installing your camera unit as far away from these electronic devices as possible: wireless routers, radios, cellular telephones, intercoms, room monitors, televisions, personal computers, kitchen appliances and cordless telephones.

WHAT'S IN THE BOX

Your baby monitor package contains the following items. Save your sales receipt and original packaging in the event warranty service is necessary.

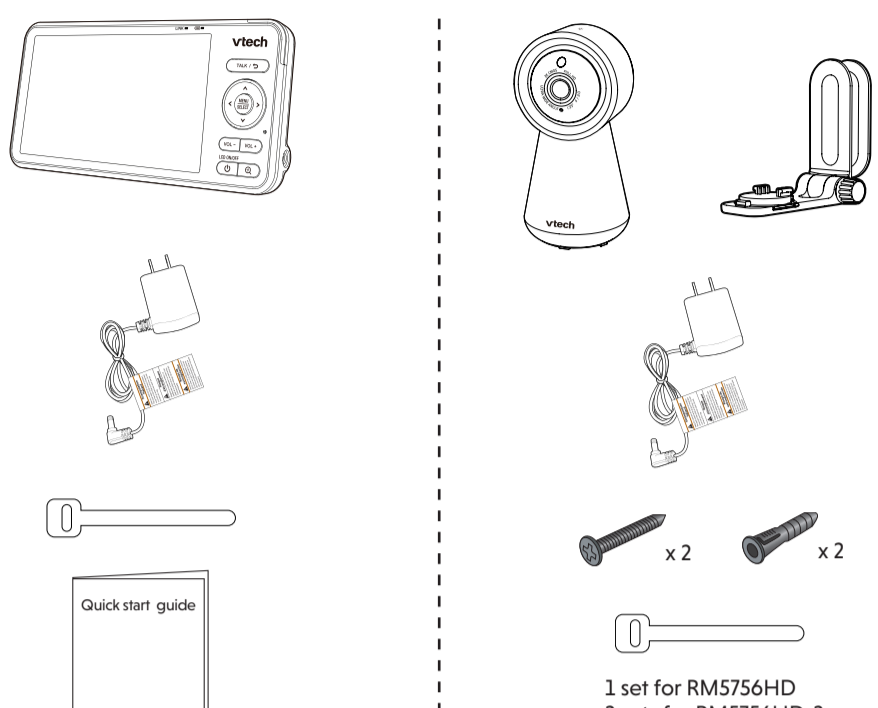

1 set for RM5756HD
2 sets for RM5756HD-2

Requirements

For mobile access:

MyVTech Baby Pro mobile app	Wi-Fi
Network	Wi-Fi
Wi-Fi router	2.4GHz 802.11 b/g/n
Internet connection	1.5 Mbps @ 720p or 2.5 Mbps @1080p upload bandwidth per baby unit

DOWNLOAD APP FOR MOBILE ACCESS

- Download the free **MyVTech Baby Pro** mobile app and install it to a mobile device, then use your mobile device and the mobile app to monitor your baby remotely.

- Press **MENU/SELECT** when the parent unit is idle.

- Go to > **Connect Mobile Phone**.

- Scan the QR code in the parent unit to download the app into your mobile device if you have not installed the app yet.
- Follow the instructions in the mobile app to set up and pair your baby unit to the mobile app.

Alternatively, you can download the mobile app from the App Store or Google Play store.

Install MyVTech Baby Pro mobile app

- Browse the App Store or the Google Play store .
- Search for the mobile app with the keyword "myvtech baby pro".
- Download and install the **MyVTech Baby Pro** mobile app to your mobile device.

OR

Scan the QR codes on the right to get the app.

NOTE

- Make sure your mobile device meets the minimum requirement for the mobile app.

Minimum requirement

The mobile app is compatible with:

- Android™ 6.0 or later; and
- iOS 12 or later.

- After installing the mobile app, follow the instructions in the mobile app and parent unit to set up and pair your baby unit.

In your mobile device:

- Tap to run the mobile app in your mobile device, and then create a user account.
- We recommend that you use common webmail services, such as Google Gmail for registration of your user account. Check your email (and Spam folder), and activate your new camera account via the email link, then sign in to your account.
- Follow the instructions in the mobile app to pair the camera. Tap then **Add Camera** in the mobile app to get started.

OVERVIEW

Baby unit overview

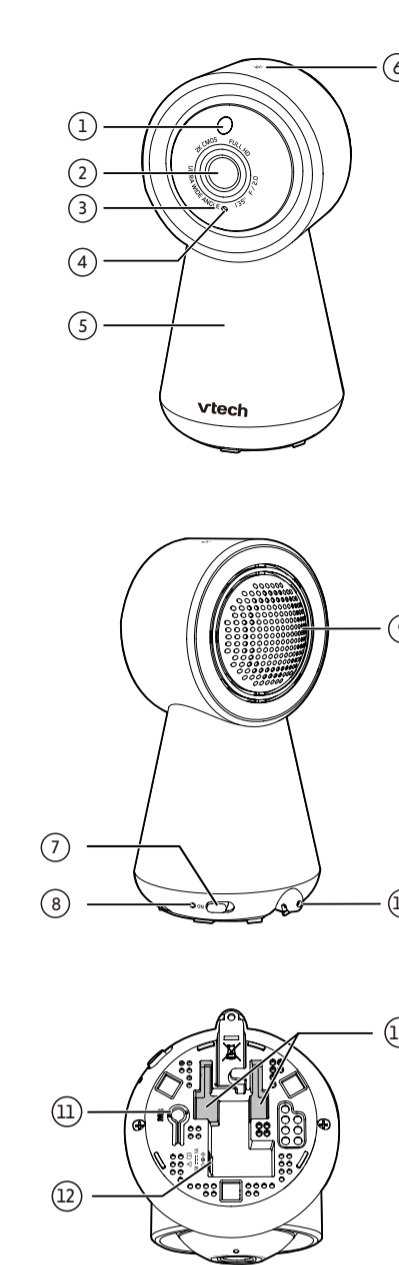

- Light sensor**
- Camera lens**
- Infrared LEDs**
• Allow you to see clearly in a dark environment.
- Microphone**
- Night Light**
- Night Light Control Key**
• Go to **Night Light** section to learn more.
- ON/OFF switch**
• Power it on or off.
- LED indicator**
• Red is steadily on when the baby unit is connecting to the parent unit in direct mode.
• Green is steadily on when the baby unit is connected in Wi-Fi router mode.
• Red flashes slowly during video streaming in direct mode.
• Green flashes slowly during video streaming in Wi-Fi router mode.
- Speaker**
- Temperature sensor**
- PAIR**
• **Press and hold** for three seconds to enter pairing mode.
• **Press and hold PAIR key** until you hear a beep sound.
• **Release the PAIR key**, and then press the **PAIR key** again five times until you hear another beep sound.
• The baby unit will sound another beep when the reset completes. Then, the baby unit will reboot.
- Power jack**
- Wall mount slots**

Parent unit overview

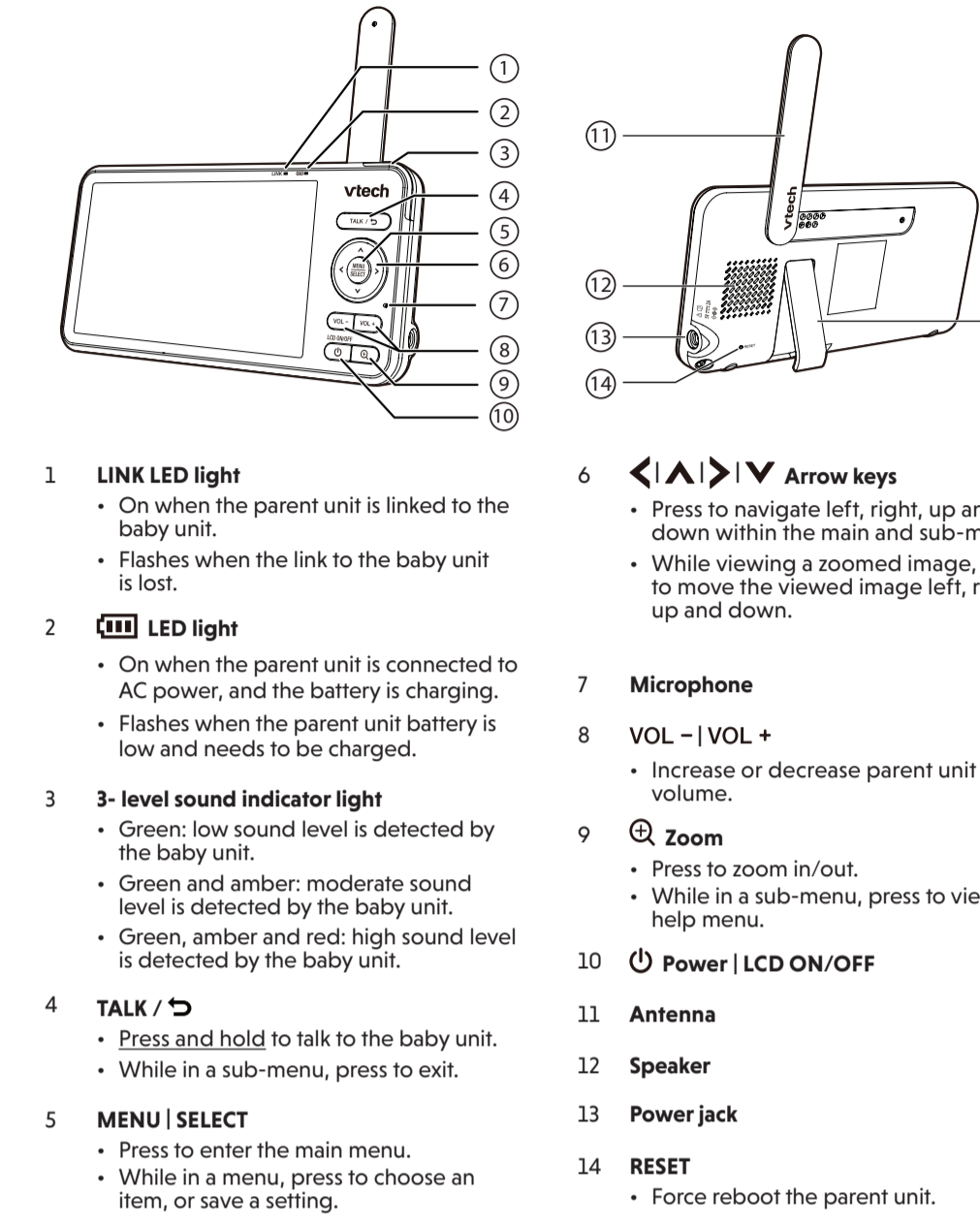

- LINK LED light**
• On when the parent unit is linked to the baby unit.
• Flashes when the link to the baby unit is lost.
- LED light**
• On when the parent unit is connected to AC power, and the battery is charging.
• Flashes when the parent unit battery is low and needs to be charged.
- 3-level sound indicator light**
• Green: low sound level is detected by the baby unit.
• Green and amber: moderate sound level is detected by the baby unit.
• Green, amber and red: high sound level is detected by the baby unit.
- TALK /**
• **Press and hold** to talk to the baby unit.
• While in a sub-menu, press to exit.
- MENU | SELECT**
• Press to enter the main menu.
• While in a menu, press to choose an item, or save a setting.
- Arrow keys**
• Press to navigate left, right, up and down within the main and sub-menus.
• While viewing a zoomed image, press to move the viewed image left, right, up and down.
- Microphone**
- VOL - | VOL +**
• Increase or decrease parent unit volume.
- Zoom**
• Press to zoom in/out.
• While in a sub-menu, press to view the help menu.
- Power | LCD ON/OFF**
- Antenna**
- Speaker**
- Power jack**
- RESET**
• Force reboot the parent unit.
- Stand**

CABLE MANAGEMENT

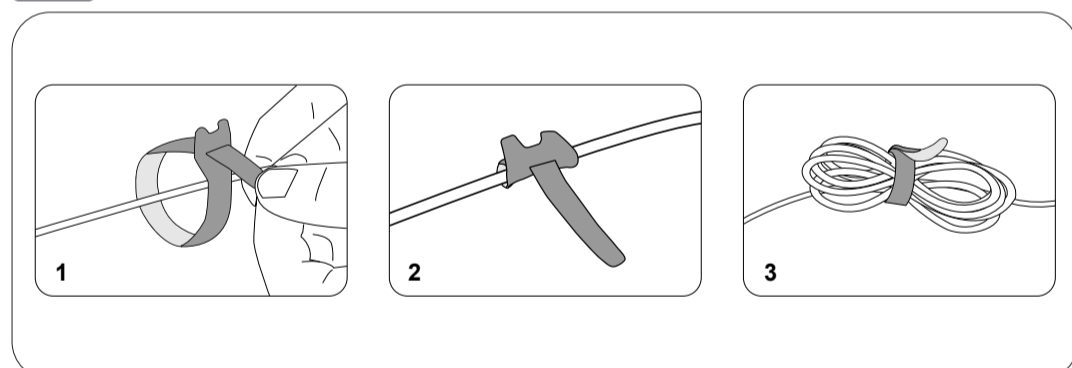

PROTECT YOUR PRIVACY AND ONLINE SECURITY

Vtech cares about your privacy and peace of mind. That's why we've put together a list of industry-recommended best practices to help keep your wireless connection private and all of devices protected when online. We recommend you carefully review and consider complying with the following tips.

- Ensure your wireless connection is secure.
- Before installing a device, ensure your router's wireless signal is encrypted by selecting the "WPA2-PSK with AES" setting in your router's wireless security menu.
- Change default settings.
- Change your wireless router's default wireless network name (SSID) to something unique.
 - Change default passwords to unique, strong passwords. A strong password:
 - Is at least 10 characters long.
 - Is complex.
 - Does not contain dictionary words or personal information.
 - Contains a mix of uppercase letters, lowercase letters, special characters and numbers.

Keep your devices up to date.

- Download security patches from manufacturers as soon as they become available. This will ensure you always have the latest security updates.
- If the feature is available, enable automatic updates for future releases.

Disable Universal Plug and Play (UPnP) on your router.

- UPnP enabled on a router can limit the effectiveness of your firewall by allowing other network devices to open inbound ports without any intervention or approval from you. A virus or other malware program could use this function to compromise security for the entire network.

For more information on wireless connections and protecting your data, please review the following resources from industry experts:

- Federal Communications Commission: Wireless Connections and Bluetooth Security Tips – www.fcc.gov/consumers/guides/how-protect-yourself-online.
- U.S. Department of Homeland Security: Before You Connect a New Computer to the Internet – www.us-cert.gov/ncas/tips/ST15-003.
- Federal Trade Commission: Using IP Cameras Safely – <https://www.consumer.ftc.gov/articles/0382-using-ip-cameras-safely>.
- Wi-Fi Alliance: Discover Wi-Fi Security – <http://www.wi-fi.org/discover-wi-fi/security>.

CONNECT, CHARGE AND POWER ON THE BABY MONITOR

Connect the baby monitor

NOTES

- The rechargeable battery in the parent unit is built-in.
- Use only the power adapters supplied with this product.
- Make sure the parent unit and the baby unit are not connected to the switch controlled electric outlets.
- Connect the power adapters in a vertical or floor mount position only. The adapter prongs are not designed to hold the weight of the parent unit and the baby unit, so do not connect them to any ceiling, under-the-table, or cabinet outlets. Otherwise, the adapter may not properly connect to the outlets.
- Make sure the parent unit, the baby unit and the power adapter cords are out of reach of children.

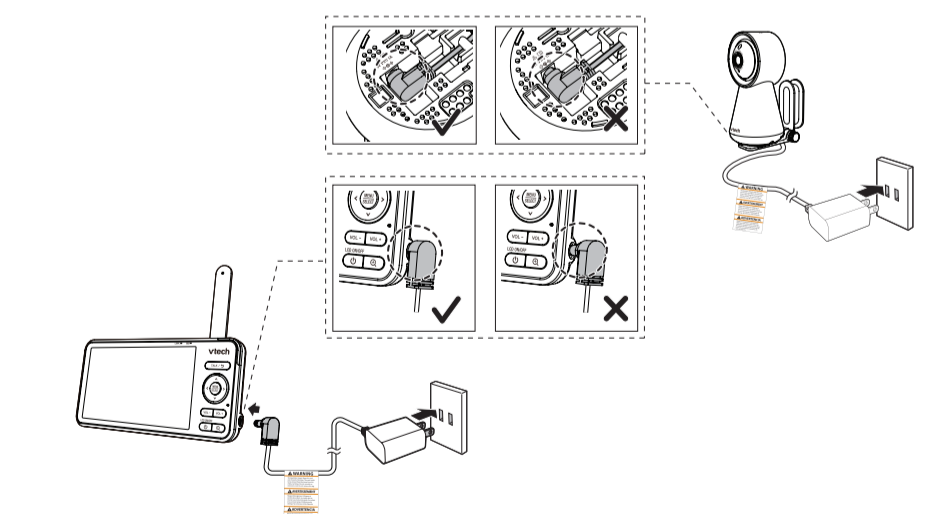

Slide the switch to **ON** to power on your baby unit.

NOTES

- After powering up, the baby unit status LED will turn on and then turn off after a short time.
- The status LED is set to off by default. If you want to keep the LED on, press **MENU**, then go to > **Status LED** and turn it on.

NOTE:

Camera lens and surface may get warm during normal operation.

Charge the parent unit battery before use

The parent unit runs on rechargeable battery or AC power. To continuously monitor your baby, keep the parent unit connected to AC power.

NOTES

- Before using the baby monitor for the first time, charge the parent unit battery for 12 hours. When the parent unit battery is fully charged, the battery icon becomes solid .
- The standby time varies depending on your actual use.

After the parent unit is fully charged, press **Power** until the welcome screen appears.

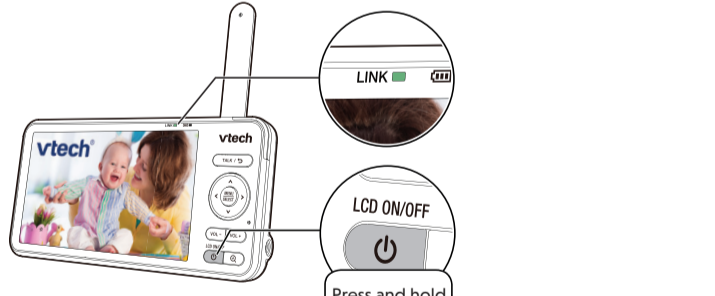

The battery icon indicates the battery status (see the following table).

BATTERY INDICATORS	BATTERY STATUS	ACTION
The screen displays and . The LED light flashes.	The battery has very little charge and may be used for only a short time.	Charge without interruption (about 30 minutes).
The battery icon becomes solid .	The battery is fully charged.	To keep the battery charged, connect it to AC power when in use.

Raise the parent unit antenna for better reception

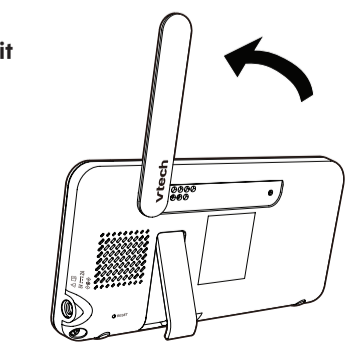

PARENT UNIT ICONS

Main Menu	Options	Main Menu	Options
Monitoring mode (For RM5756HD-2 only)	<ul style="list-style-type: none"> View baby units in Single mode. View baby units in Patrol mode. View baby units in Split screen. 	General settings	<ul style="list-style-type: none"> Configure Wi-Fi. <ul style="list-style-type: none"> Change Wi-Fi Network Selection Connection Mode Connection Status Connect mobile phone. Reset Settings to factory default. Software Update.
Night light	<ul style="list-style-type: none"> Turn on or turn off night light. Select a night light color. Adjust night light brightness. Set a night light timer. 	Status icons	<ul style="list-style-type: none"> Direct mode Parent unit, baby unit 1 and baby unit 2 (*For RM5756HD-2 only) are connected to each others directly. Wi-Fi Router mode Parent unit, baby unit 1 and baby unit 2 (*For RM5756HD-2 only) are connected to home Wi-Fi network. Baby unit 1 and 2 are being viewed in Patrol mode (*For RM5756HD-2 only). Baby unit 1 and 2 are being viewed in Split mode (*For RM5756HD-2 only). Night vision is turned on. Motion detection alert is turned on. Sound detection alert is turned on. Melodies and soothing sounds are playing. Night light is turned on. Auto night light brightness is activated. Temperature alert is turned on. Parent unit is muted.
Melodies and soothing sounds	<ul style="list-style-type: none"> Select play all melodies, or play one of the five melodies and five soothing sounds. You can also set the timer to stop playing after 15, 30 or 60 minutes, or playing non-stop. 	Alerts - Sound, motion and temperature	<ul style="list-style-type: none"> Select the sound and motion sensitivity level. Turn on/off sound and motion detection alerts. Select maximum and minimum temperature for alert range. Turn on/off temperature alert. Turn on/off Auto Wake Up function.
Parent unit settings	<ul style="list-style-type: none"> Adjust parent unit screen brightness. Adjust Low Battery Alert Tone. Adjust No Link Alert Tone. Turn on/off Dim mode. 	Baby unit settings	<ul style="list-style-type: none"> Turn on/off Night Vision. Turn on/off baby unit Status LED. Adjust baby unit speaker volume.

AUTO SOFTWARE AND FIRMWARE UPDATE

To ensure that your baby monitor is always at its best performance, the parent unit will prompt you to update its software and the baby unit firmware when there are new versions available.

- Follow the instructions on the parent unit screen to update your baby monitor. If you skip the updates, the parent unit and baby unit will be updated automatically when the parent unit is powered off, and then powered on again.

To check if your device is running on the latest software or to update your device software, go to:

> **Software Update**

Connect your baby monitor to Wi-Fi

- You must connect your video monitor to your secured home Wi-Fi network in order to receive the latest software and firmware updates. To set it up, go to:

> **Configure Wi-Fi**

NIGHT LIGHT

You can control the night light remotely on the parent unit or directly on the baby unit.

On the parent unit:	On the baby unit:
<ol style="list-style-type: none"> Press MENU. Press or to scroll to Night Light menu, then press MENU or to enter. Press or to choose below options: 	<ul style="list-style-type: none"> Night Light Control Key Single Tap: Turn on/off Tap and hold: Adjust night light brightness
<ul style="list-style-type: none"> Turn on/off night light Change night light color Adjust night light brightness Set night light timer 	

TECHNICAL SPECIFICATIONS

Channels	11
LCD	5" (1280x720 pixels)
Normal effective range	Actual operating range may vary according to environmental conditions at the time of use.
Power requirement	Baby unit power adapter: Output: 5V DC, 1000mA. Parent unit power adapter: Output: 5V DC, 2A. Parent unit battery: 3.7V, 5000mAh, 18.5Wh Lithium-ion battery.
Disclaimer and Limitation of Liability	<p>Vtech Communications, Inc. and its suppliers assume no responsibility for any damage or loss resulting from the use of this user's manual. Vtech Communications, Inc. and its suppliers assume no responsibility for any loss or claims by third parties that may arise through the use of this product.</p> <p>Company: Vtech Communications, Inc. Address: 9020 SW Washington Square Road - 5th Floor, Beaverton, OR 97008, United States Phone: 1 (800) 595-9511 in the U.S. or 1 (800) 267-7377 in Canada</p>

All rights reserved. © 2022 Vtech Communications, Inc. All trademarks and registered trademarks of Vtech are used under license.