

## TEST REPORT

**Report Number: 21020645HKG-001**

Application For Original Grant of 47 CFR Part 15 Certification

Unlicensed Personal Communication Service Devices

(Base Unit)

**FCC ID: EW780-2400-00**

**Prepared and Checked by:**

**Approved by:**

Signed On File  
Leung Chiu Kuen, Stanley  
Engineer

---

Tang Kwan Mo, Jess  
Lead Engineer  
Date: March 03, 2021

## TEST REPORT

### GENERAL INFORMATION

<b>Grantee:</b>	VTech Telecommunications Ltd.
<b>Grantee Address:</b>	23/F., Tai Ping Industrial Centre, Block 1, 57 Ting Kok Road, Tai Po, Hong Kong.
<b>FCC Specification Standard:</b>	FCC Part 15, October 1, 2019 Edition
<b>FCC ID:</b>	EW780-2400-00
<b>FCC Model(s):</b>	1. CS6214-2, CS6214, CS6214-11, CS6214-21, CS621Z-XY, VG101, VG101-11, VG101-XY 2. CS6224-2, CS6224, CS6224-11, CS6224-21, CS622Z-XY, VG104, VG104-11, VG104-XY
<b>Type of EUT:</b>	Unlicensed Personal Communications Service Devices
<b>Description of EUT:</b>	DECT 6.0 Cordless Telephone - Base Unit
<b>Serial Number:</b>	N/A
<b>Sample Receipt Date:</b>	February 10, 2021
<b>Date of Test:</b>	February 15, 2021 to March 01, 2021
<b>Report Date:</b>	March 03, 2021
<b>Environmental Conditions:</b>	Temperature: +10 to 40°C Humidity: 10 to 90%
<b>Conclusion:</b>	Test was conducted by client submitted sample. The submitted sample as received complied with the 47 CFR Part 15 Certification.

**TEST REPORT**

**TABLE OF CONTENTS**

**1.0 TEST RESULTS SUMMARY & STATEMENT OF COMPLIANCE ..... 5**

    1.1 Summary of Test Results .....5

    1.2 Statement of Compliance .....6

**2.0 GENERAL DESCRIPTION ..... 7**

    2.1 Product Description.....7

    2.2 Technical Description .....7

    2.3 Test Methodology .....7

    2.4 Test Facility .....7

**3.0 SYSTEM TEST CONFIGURATION..... 8**

    3.1 Justification .....8

    3.2 Radiated Emission Test Setup .....9

    3.3 AC Line Conducted Emission Test Setup.....10

    3.4 Conducted Emission Test Configuration.....11

    3.5 Conducted Monitoring and Operational Test Configuration .....11

    3.6 EUT Exercising Software.....11

    3.7 Details of EUT and Description of Accessories.....12

    3.8 Measurement Uncertainty .....12

**4.0 MEASUREMENT RESULTS ..... 13**

    4.1 Antenna Requirement.....13

    4.2 Digital Modulation Techniques.....13

    4.3 Emission Bandwidth .....14

    4.4 Directional Gain of the Antenna.....17

    4.5 Peak Transmit Power .....18

    4.6 Power Spectral Density .....21

    4.7 Automatic Discontinuation of Transmission.....24

    4.8 Unwanted Emission Inside the Sub-Band .....25

    4.9 Emissions Outside the Sub-Band .....30

        4.9.1 Radiated Emissions Configuration Photographs .....31

        4.9.2 Radiated Emissions Data .....31

        4.9.3 Field Strength Calculation.....42

        4.9.4 Average Factor Calculation and Transmitter ON Time Measurements.....43

    4.10 AC Power Line Conducted Emissions.....44

        4.10.1 AC Power Line Conducted Emissions Configuration Photographs .....45

        4.10.2 AC Power Line Conducted Emissions Data .....45

**TEST REPORT**

**TABLE OF CONTENTS**

4.11 Frame Repetition Stability .....58

4.12 Frame Period and Jitter.....59

4.13 Carrier Frequency Stability .....60

4.14 Monitoring Threshold .....61

4.14.1 Monitoring Threshold Limit.....62

4.14.2 Least Interfered Channel .....63

4.14.2.1 Least Interfered Channel (LIC) Selection .....64

4.14.2.2 Least Interfered Channel (LIC) Confirmation .....65

4.14.2.3 Maximum Spectrum Occupancy.....65

4.15 Monitoring Time .....66

4.16 Maximum Transmit Period.....67

4.17 System Acknowledgement.....68

4.18 Random Waiting .....69

4.19 Monitoring Bandwidth .....70

4.20 Maximum Reaction Time .....71

4.21 Monitoring Antenna.....71

4.22 Duplex Connections .....72

4.23 Alternative Monitoring Interval for Co-located Device .....73

4.24 Fair Access .....73

**5.0 EQUIPMENT LIST ..... 74**

**TEST REPORT**

**1.0 TEST RESULTS SUMMARY & STATEMENT OF COMPLIANCE**

1.1 Summary of Test Results

Test Items	General Technical Requirements		Results	Details See Section
	FCC Part 15 Section	Test Procedure ANSI C63.17 / ANSI C63.4*		
Antenna Requirement	15.317	---	Pass	4.1
Digital Modulation Techniques	15.319(b)	6.1.4	Pass	4.2
Occupied/Emission Bandwidth	15.323(a)	6.1.3	Pass	4.3
Directional Gain of the Antenna	15.319(e)	4.3.1	Pass	4.4
Peak Transmit Power	15.319(c)	6.1.2	Pass	4.5
Power Spectral Density	15.319(d)	6.1.5	Pass	4.6
Automatic Discontinuation of Transmission	15.319(f)	---	Pass	4.7
AC Power Line Conducted Emissions from EUT	15.315	7 *	Pass	4.10
Security Code Information	---	---	Pass	2.2

## TEST REPORT

### 1.1 Summary of Test Results (continued)

Specific Requirements for UPCS Device				
Test Items	FCC Part 15 Section	Test Procedure ANSI C63.17	Results	Details See Section
Unwanted Emission Inside the Sub-Band	15.323(d)	6.1.6.1	Pass	4.8
Emissions Outside the Sub-Band	15.323(d)	6.1.6.2	Pass	4.9
Frame Repetition Stability	15.323(e)	6.2.2	Pass	4.11
Frame Period and Jitter	15.323(e)	6.2.3	Pass	4.12
Carrier Frequency Stability	15.323(f)	6.2.1	Pass	4.13
Monitoring Threshold Limit	15.323(c2&c9)	7.3.1	NA	4.14.1
Least Interfered Channel (LIC) Selection	15.323(c)(5)	7.3.2	Pass	4.14.2.1
Least Interfered Channel (LIC) Confirmation	15.323(c)(5)	7.3.2	Pass	4.14.2.2
Maximum Spectrum Occupancy	15.323(c)(5)	---	Pass	4.14.2.3
Monitoring Time	15.323(c)(1)	7.3.3	Pass	4.15
Maximum Transmit Period	15.323(c)(3)	8.2.2	Pass	4.16
System Acknowledgement	15.323(c4)	8.1 or 8.2	Pass	4.17
Random Waiting	15.323(c)(6)	8.1.2 or 8.1.3	Pass	4.18
Monitoring Bandwidth	15.323(c)(7)	7.4	Pass	4.19
Maximum Reaction Time	15.323(c)(7)	7.5	Pass	4.20
Monitoring Antenna	15.323(c)(8)	4	Pass	4.21
Duplex Connections	15.323(c)(10)	8.3	NA	4.22
Alternative Monitoring Interval for Co-located Device	15.323(c)(11)	8.4	NA	4.23
Fair Access	15.323(c)(12)	---	Pass	4.24

### 1.2 Statement of Compliance

The equipment under test is found to be complying with the following standards:

FCC Part 15, October 1, 2019 Edition

## TEST REPORT

### 2.0 GENERAL DESCRIPTION

#### 2.1 Product Description

The CS6214-2 is a DECT 6.0 Cordless Telephone - Base Unit, while CS6224-2 is a DECT 6.0 Cordless Telephone with Answering Machine - Base Unit. It operates at frequency range of 1921.536MHz to 1928.448MHz with 5 channels (1921.536MHz, 1923.264MHz, 1924.992MHz, 1926.720MHz and 1928.448MHz). The Base Unit is powered by an adaptor 100-120VAC 60Hz 150mA.

The antennas used in base unit are integral, and the test sample is a prototype.

The Model(s): CS6214, CS6214-11, CS6214-21, CS621Z-XY, VG101, VG101-11 and VG101-XY are the same as the Model: CS6214-2 in electrical designs including software & firmware, PCB layout and construction design/physical design/enclosure as declared by client. The Model(s): CS6224, CS6224-11, CS6224-21, CS622Z-XY, VG104, VG104-11 and VG104-XY are the same as the Model: CS6224-2 in electrical designs including software & firmware, PCB layout and construction design/physical design/enclosure as declared by client. The only differences between these models are model number, color, with or without answer machine, external appearance, package type, and number of handsets and chargers to be sold for marketing purpose as declared by client. Suffix ("X, Y, Z" in CS621Z-XY, CS622Z-XY and VG104-XY) indicates different package type (material), different number of handsets and chargers, and different color of enclosure as declared by client.

Connection between the device and the telephone network is accomplished through the use of USOC RJ11C in the 2-wire loop calling central office line.

#### 2.2 Technical Description

The circuit description and digital modulation techniques description are saved with filename: descri.pdf.

#### 2.3 Test Methodology

The radiated emission measurements for unintentional radiator (if any) and AC power line-conducted emission measurements were performed according to the test procedures specified in ANSI C63.4 (2014). The radiated emission measurements for intentional radiator contained in UPCS device, conducted emission measurements, Listen Before Transmit (LBT) tests, Time Frame and Frequency Stability tests were performed according to the test procedures specified in ANSI C63.17 (2013). All radiated measurements were performed in radiated emission test site. Preliminary scans were performed in the radiated emission test site only to determine worst case modes. All radiated tests were performed at an antenna to EUT distance of 3 meters, unless stated otherwise in the "Justification Section" of this Application. All other measurements were made in accordance with the procedures in 47 CFR Part 2.

#### 2.4 Test Facility

The radiated emission test site, AC power line conducted measurement facility and antenna port conducted measurement facility used to collect the radiated data, AC Power Line conducted data, and conductive data are at Intertek Testing Services Hong Kong Ltd., which is located at Workshop No. 3, G/F., World-Wide Industrial Centre, 43-47 Shan Mei Street, Fo Tan, Sha Tin, N.T., Hong Kong SAR, China. This test facility and site measurement data have been fully placed on file with FCC.

## TEST REPORT

### 3.0 SYSTEM TEST CONFIGURATION

#### 3.1 Justification

For emissions testing, the equipment under test (EUT) was set up to transmit continuously in burst mode with pseudo-random data to simplify the measurement methodology. Care was taken to ensure proper power supply voltages during testing. During testing, all cables (if any) were manipulated to produce worst-case emissions.

The Base Unit was powered by a 100-120VAC 60Hz 150mA to 6.0VDC 400mA adaptor.

For the measurements, the EUT was attached to a plastic stand if necessary and placed on the wooden turntable. If the EUT is attached to accessories, they were connected and operational (as typical as possible).

The signal was maximized through rotation and placement in the three orthogonal axes. The antenna height and polarization were varied during the search for maximum signal level. The antenna height was varied from 1 to 4 meters. Detector function was in peak mode. Radiated emissions are taken at three meters unless the signal level was too low for measurement at that distance. If necessary, a pre-amplifier was used and/or the test was conducted at a closer distance.

For UPCS transmitter radiated measurement, the spectrum analyzer resolution bandwidth was approximately 1% of EUT emission bandwidth, unless otherwise specified.

Radiated emission measurements for UPCS transmitter were performed from the lowest radio frequency signal generated in the device which is greater than 9 kHz to the tenth harmonic of the highest fundamental frequency or to 40 GHz, whichever is lower.

RF modules for the two base units are identical including RF algorithm. Therefore conducted emission measurements for jitter, frame repetition stability, carrier stability and listen before transmit requirements are the same

As the base unit has 2 antennas, both have been checked. While conducting the test on one of antennas, another one was being disable its transmission. The data in this report represented the worst-case.

For AC line conducted emission test, the EUT along with its peripherals were placed on a 1.0m(W)x1.5m(L) and 0.8m in height wooden table and the EUT was adjusted to maintain a 0.4 meter space from a vertical reference plane. The EUT was connected to power mains through a line impedance stabilization network (LISN), which provided 50ohm coupling impedance for measuring instrument. The LISN housing, measuring instrument case, reference ground plane, and vertical ground plane were bounded together. The excess power cable between the EUT and the LISN was bundled.

All connecting cables of EUT and peripherals were manipulated to find the maximum emission.

All relevant operation modes and different type of adaptors have been tested, and the worst case data is included in this report.

**TEST REPORT**

3.2 Radiated Emission Test Setup

The figure below shows the test setup, which is utilized to make these measurements.

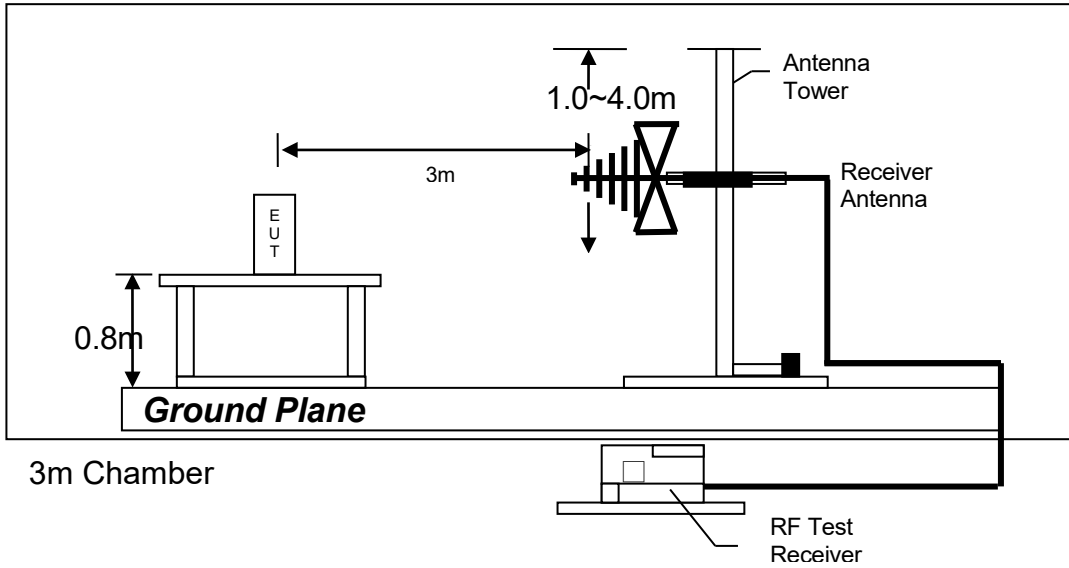

Test setup of radiated emissions up to 1GHz

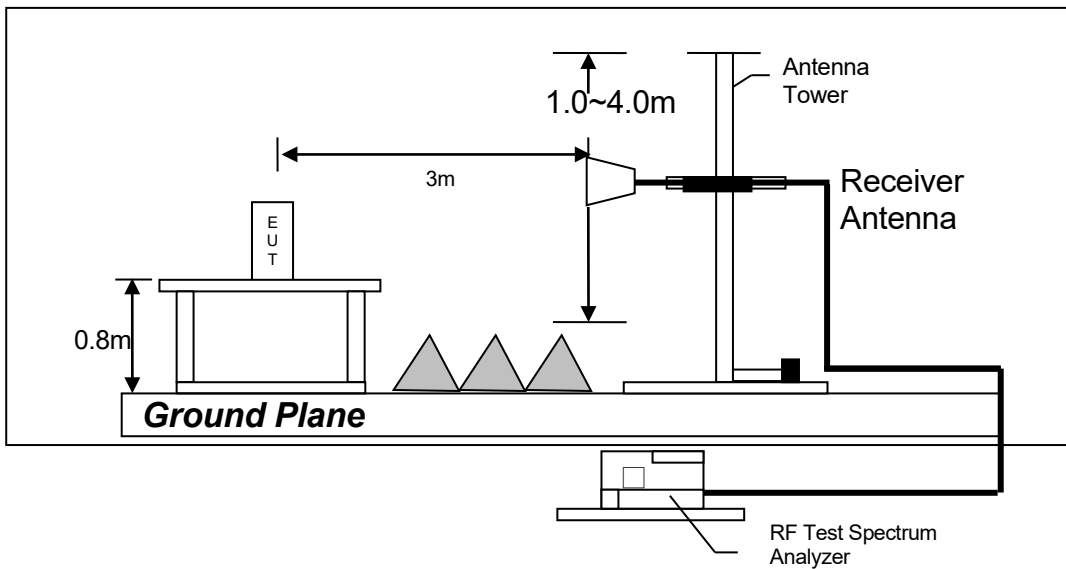

Test setup of radiated emissions above 1GHz

Figure 3.2.1

## TEST REPORT

### 3.3 AC Line Conducted Emission Test Setup

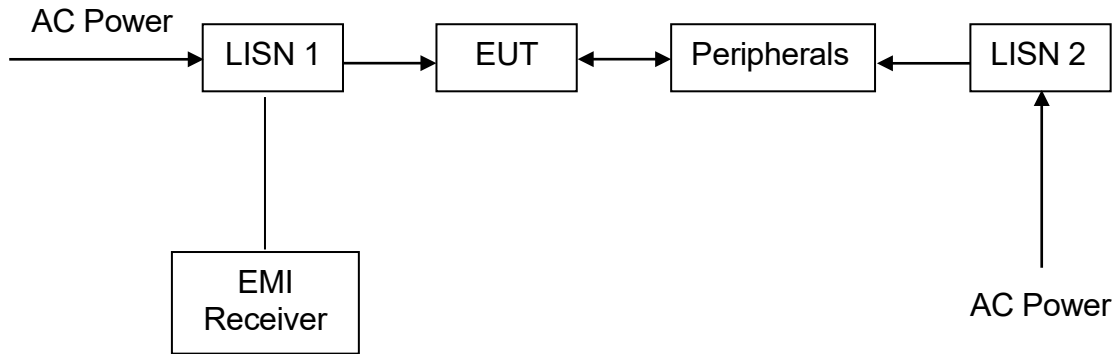

Figure 3.3.1

## TEST REPORT

### 3.4 Conducted Emission Test Configuration

The setup and equipment setting were made in accordance with ANSI C63.17. The antenna of EUT transmitter was replaced by a coaxial cable. The impedance matching of connection, cable loss and external RF attenuator are taken into account. The EUT was arranged to communicate via a fixed carrier frequency between its transmitter and a companion device. The transmission was configured in burst mode with pseudo-random data as typical as normal operation.

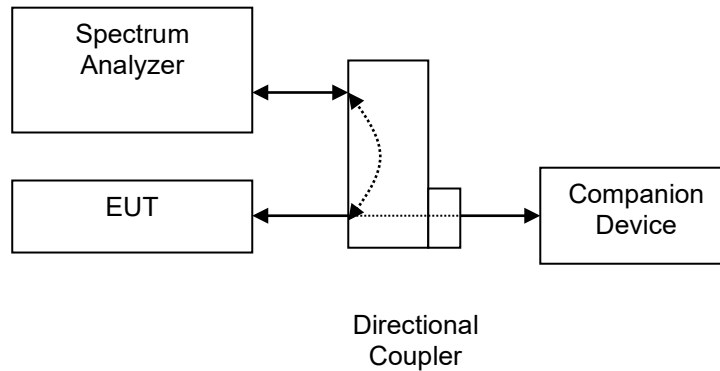

Figure 3.4.1

### 3.5 Conducted Monitoring and Operation Test Configuration

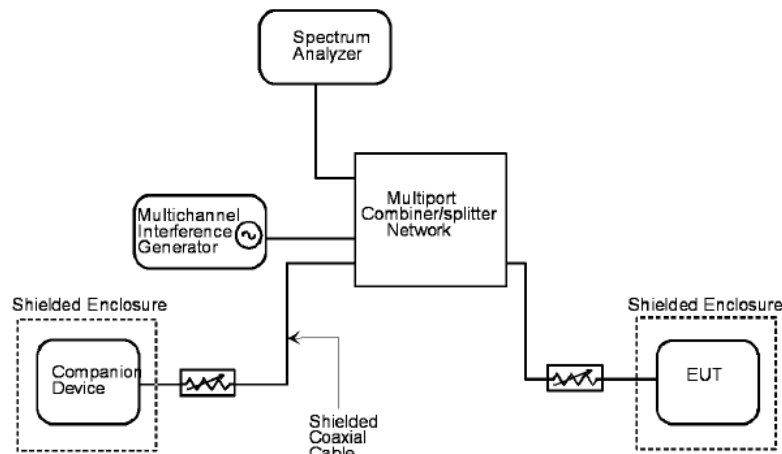

Figure 3.5.1

### 3.6 EUT Exercising Software

The EUT exercise program (if any) used during radiated and conducted testing was designed to exercise the various system components in a manner similar to a typical use.

## TEST REPORT

### 3.7 Details of EUT and Description of Accessories

#### Details of EUT:

An AC adaptor (provided with the unit) were used to power the device. Their descriptions are listed below.

- (1) An AC adaptor (100-120VAC 60Hz 150mA to 6.0VDC 400mA, Model: VT05UUS06040, Brand: VTPL) (Supplied by Client)
- (2) An AC adaptor (100-120VAC 60Hz 150mA to 6.0VDC 400mA, Model: S003AKU0600040, Brand: Ten Pao) (Supplied by Client)
- (3) An AC adaptor (100-120VAC 60Hz 150mA to 6.0VDC 400mA, Model: A318 -060040W-US1, Brand: Ao Hai) (Supplied by Client)

#### Description of Accessories:

- (1) Telecommunication cable with RJ11C connectors (1m, unshielded), terminated (Supplied by Intertek)
- (2) Handset, Model: CS6214-2, FCC ID: EW780-2400-00 (Supplied by Client)

### 3.8 Measurement Uncertainty

Decision Rule for compliance: For FCC/IC standard, the measured value must be within the limits of applicable standard without accounting for the measurement uncertainty. For EN/IEC/HKTA/HKTC standard, conformity rules will be used as per standard directly excepted EN/IEC 61000-3-2, EN/IEC 61000-3-3, HKTA1004, HKCA1008, HKTA1019, HKTA1020, HKTA1041 and HKTA1044. For these excepted or not mentioned standards, Cl 4.2.2 of ILAC-G8:09/2019 decision rules will be reference and guard band will be equal to our measurement uncertainty with 95% confidence level (k=2). In case, the measured value is within guard band region, undetermined decision will be used. The values of the Measurement uncertainty for radiated emission test, AC line conducted emission test and RF conducted test, frequency stability and timing jitter are  $\pm 5.3\text{dB}$ ,  $\pm 4.2\text{dB}$ ,  $\pm 1\text{dB}$ ,  $\pm 23\text{Hz}$ ,  $0.1\mu\text{s}$  respectively.

Uncertainty and Compliance - Unless the standard specifically states that measured values are to be extended by the measurement uncertainty in determining compliance, all compliance determinations are based on the actual measured value.

## TEST REPORT

### 4.0 MEASUREMENT RESULTS

#### 4.1 Antenna Requirement, FCC Rule 15.317:

EUT must meet the antenna requirement of FCC Rule 15.203.

- EUT uses permanently attached antenna(s) which is considered sufficient to comply with the provisions of this rule. Please refer to internal photos.pdf for more details.
- EUT uses unique antenna jack(s) or electrical connector(s) which is considered sufficient to comply with the provisions of this rule. Please refer to internal photos.pdf for more details.

#### 4.2 Digital Modulation Techniques, FCC Rule 15.319(b):

All transmissions must use only digital modulation techniques.

The requirements are made in accordance with ANSI C63.17 sub-clause 6.1.4.

Attestation:

Please refer to the technical description(descr.pdf) or relevant DECT standards for more details.

**TEST REPORT**

4.3 Emission Bandwidth, FCC Rule 15.323(a):

Operation shall be contained within the 1920 – 1930 MHz band. The emission bandwidth (*B*) shall be less than 2.5 MHz and greater than 50 kHz.

Measurements are made in accordance with ANSI C63.17 sub-clause 6.1.3. Test setup is shown in section 3.4 Figure 3.4.1.

Test Results:

I. Base unit - Traffic Carrier (For CS6214 series)

Channel	Channel Frequency (MHz)	Measuring Signal Level	Measured Emission Bandwidth (MHz)	Results
Lowest	1921.536	26 dB down	1.49	Pass
Highest	1928.448	26 dB down	1.50	Pass

II. Base unit - Traffic Carrier (For CS6224 series)

Channel	Channel Frequency (MHz)	Measuring Signal Level	Measured Emission Bandwidth (MHz)	Results
Lowest	1921.536	26 dB down	1.48	Pass
Highest	1928.448	26 dB down	1.48	Pass

The plots of emission bandwidth are saved as below.

**TEST REPORT**

**PLOTS OF EMISSION BANDWIDTH**

For CS6214 series

Base unit, Lowest channel, Traffic carrier

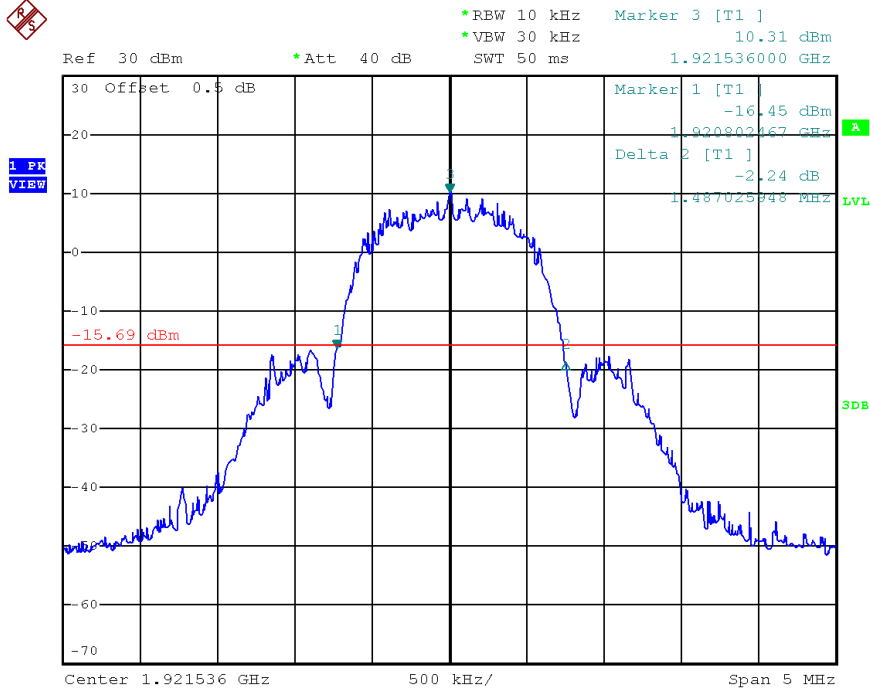

Base unit, Highest channel, Traffic carrier

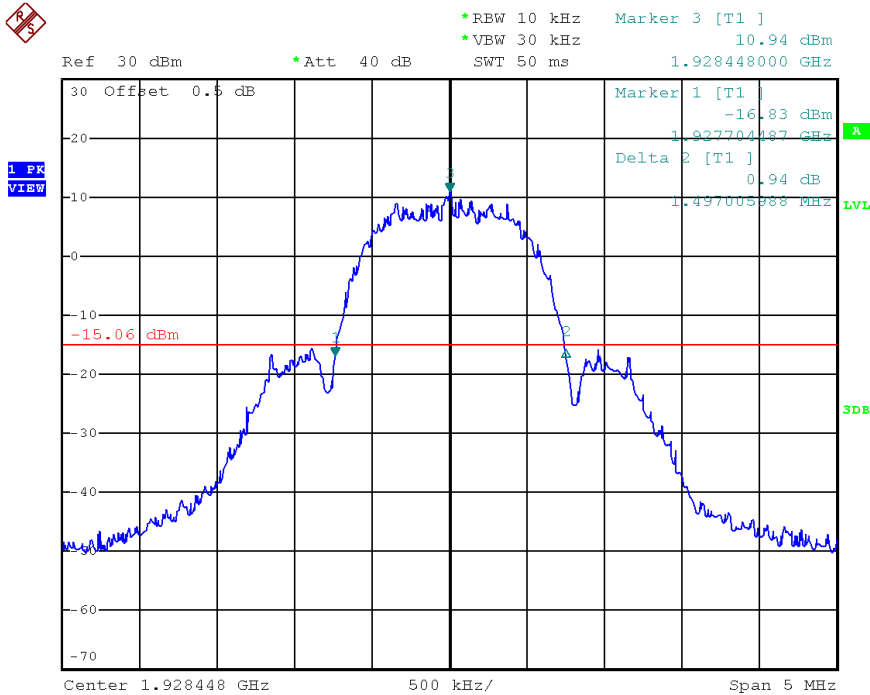

**TEST REPORT**

**PLOTS OF EMISSION BANDWIDTH**

For CS6224 series

Base unit, Lowest channel, Traffic carrier

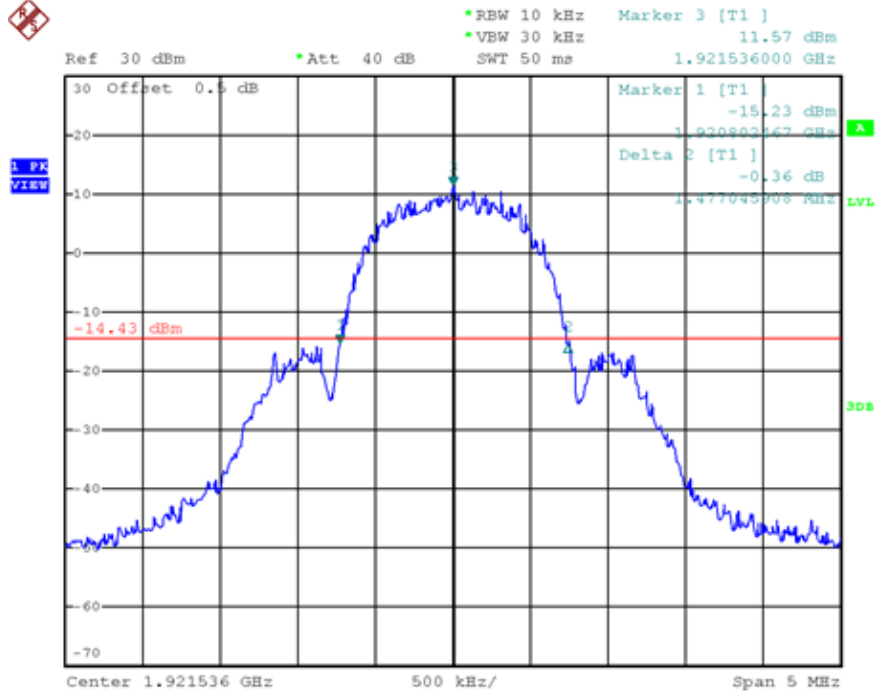

Base unit, Highest channel, Traffic carrier

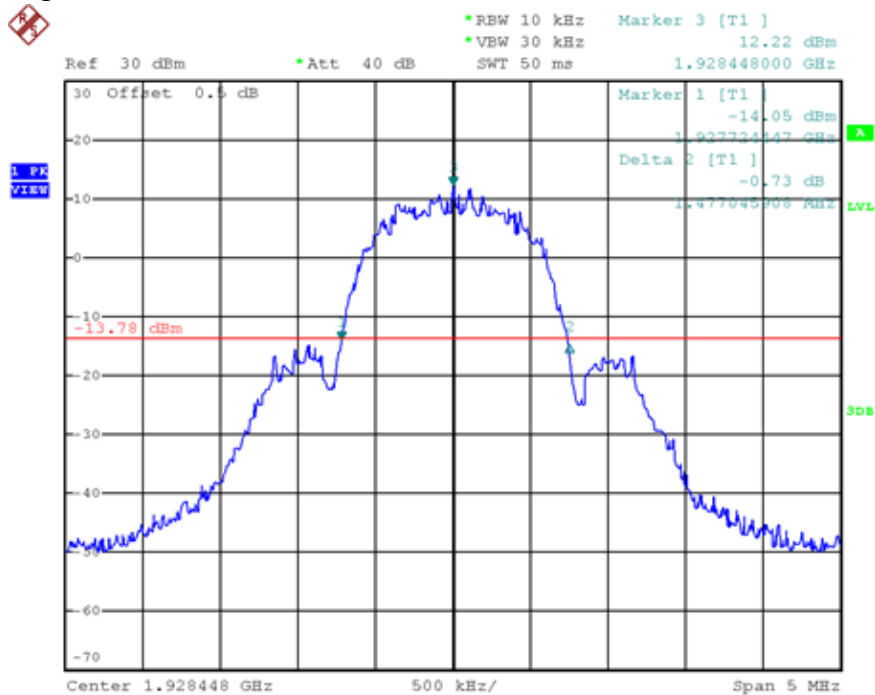

## TEST REPORT

### 4.4 Directional Gain of the Antenna, FCC Rule FCC 15.319(e):

The peak transmit power shall be reduced by the amount in dB that the maximum directional gain of the antenna exceeds 3 dBi.

The requirements are made in accordance with ANSI C63.17 sub-clause 4.3.1.

- [ × ] Manufacturer declares that the directional gain of the antenna is less than or equal to 3dBi. No peak transmit power reduction is required.
- [ ] Manufacturer declares that the directional gain of the antenna is greater than 3dBi. The peak transmit power shall be reduced by \_\_\_ dB.

**TEST REPORT**

4.5 Peak Transmit Power, FCC Rule 15.319(c):

The peak transmit power ( $P_{EUT}$ ) shall not exceed  $100\mu\text{W}$  multiplied by the square root of the emission bandwidth ( $B$ ) in Hz or  $5 \log_{10} B - 10$  dBm. The peak transmit power shall be reduced by the amount in dB that the maximum directional gain of the antenna exceeds 3 dBi.

Measurements are made in accordance with ANSI C63.17 sub-clause 6.1.2. Test setup is shown in section 3.4 Figure 3.4.1. The cable loss and/or external attenuation are included in OFFSET function of spectrum analyzer.

Calculation of Peak Transmit Power Limit ( $P_{max}$ ):

$$\begin{aligned}
 [ \times ] \quad P_{max} &= 5 \log_{10} B - 10 \text{ dBm} && \text{when } G_A \leq 3\text{dBi} \\
 [ \quad ] \quad P_{max} &= 5 \log_{10} B - 10 \text{ dBm} - (G_A - 3\text{dBi}) && \text{when } G_A > 3\text{dBi}
 \end{aligned}$$

Where  $G_A$  = EUT Antenna 0 and 1 Gain: 0 dBi  
 $B$  = Measured Emission Bandwidth

Test Results:

I. Base unit - Traffic Carrier (For CS6214 series)

Channel	Channel Frequency (MHz)	Measured Peak Transmit Power (dBm)	Limit (dBm)	Results
Lowest	1921.536	19.71	20.87	Pass
Highest	1928.448	19.90	20.88	Pass

II. Base unit - Traffic Carrier (For CS6224 series)

Channel	Channel Frequency (MHz)	Measured Peak Transmit Power (dBm)	Limit (dBm)	Results
Lowest	1921.536	19.96	20.85	Pass
Highest	1928.448	19.81	20.85	Pass

The plots of peak transmit power are saved as below.

**TEST REPORT**

**PLOTS OF PEAK TRANSMIT POWER**

For CS6214 series

Base unit, Lowest channel, Traffic carrier

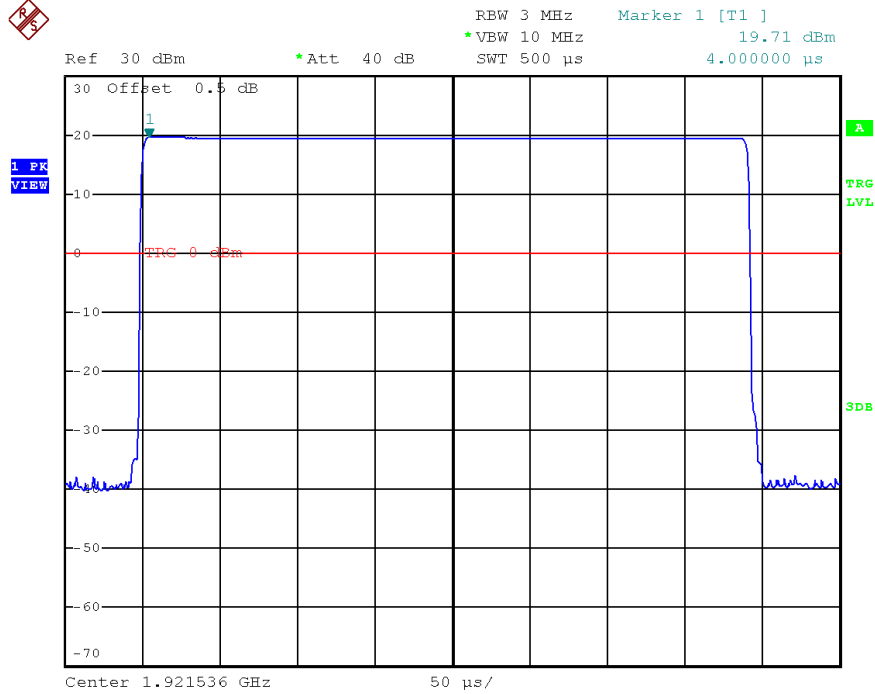

Base unit, Highest channel, Traffic carrier

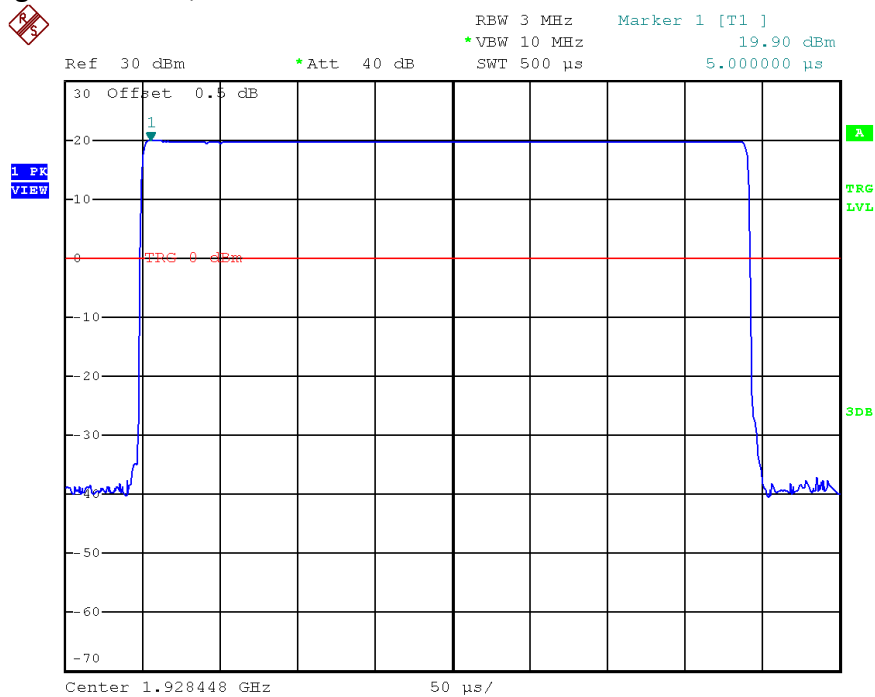

**TEST REPORT**

**PLOTS OF PEAK TRANSMIT POWER**

For CS6224 series

Base unit, Lowest channel, Traffic carrier

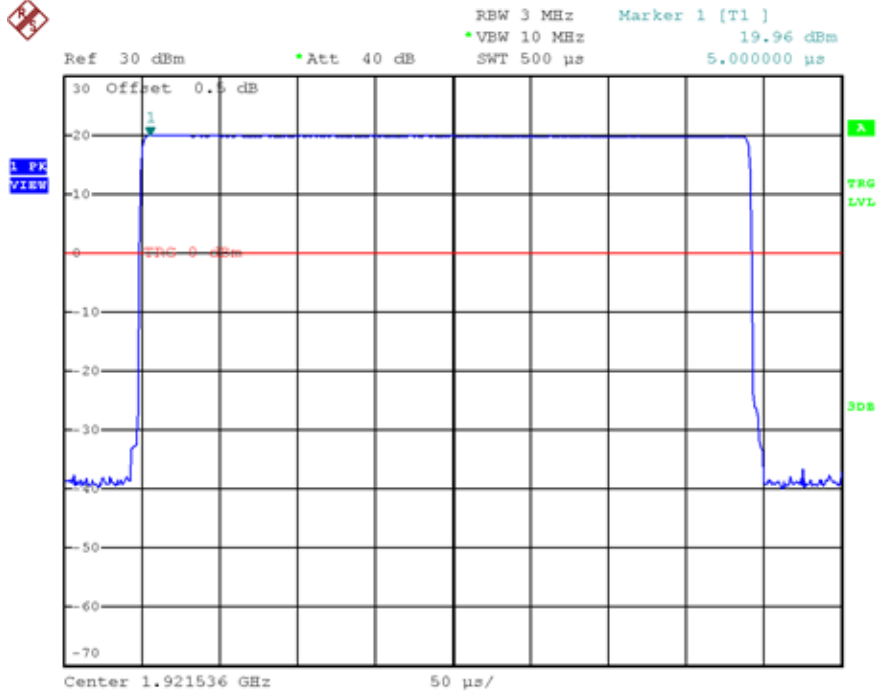

Base unit, Highest channel, Traffic carrier

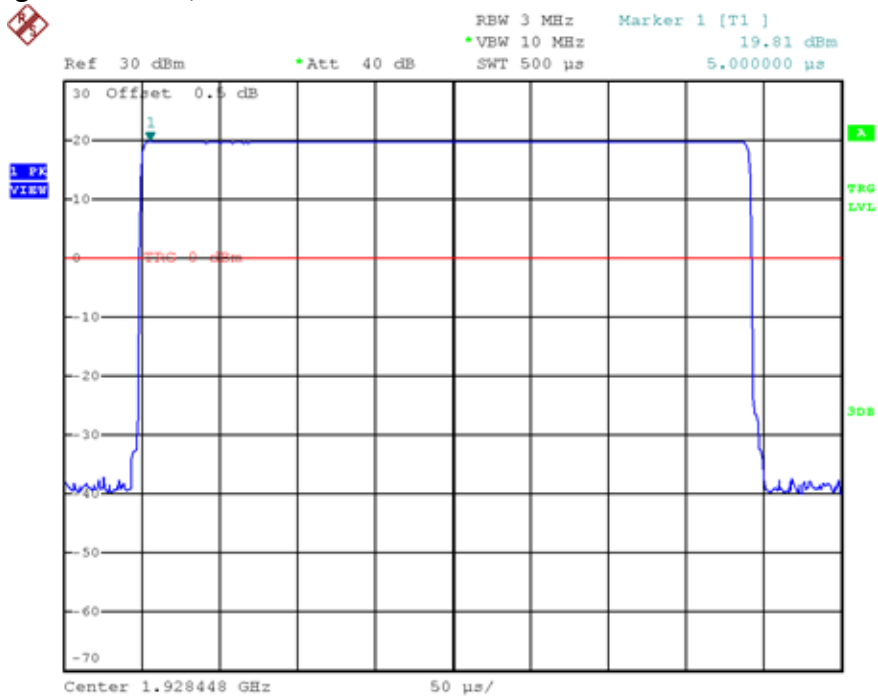

**TEST REPORT**

4.6 Power Spectral Density, FCC Rule 15.319(d):

Power spectral density shall not exceed 3 mW (4.8dBm) in any 3 kHz bandwidth as measured with a spectrum analyzer having a resolution bandwidth of 3 kHz.

Measurements are made in accordance with ANSI C63.17 sub-clause 6.1.5. Test setup is shown in section 3.4 Figure 3.4.1.

Test Results:

I. Base unit - Traffic Carrier (For CS6214 series)

Channel	Channel Frequency (MHz)	Measured Power Spectral Density (dBm/3kHz)	Limit (dBm/3 kHz)	Results
Lowest	1921.536	-5.1	4.8	Pass
Highest	1928.448	-5.4	4.8	Pass

II. Base unit - Traffic Carrier (For CS6224 series)

Channel	Channel Frequency (MHz)	Measured Power Spectral Density (dBm/3kHz)	Limit (dBm/3 kHz)	Results
Lowest	1921.536	-4.1	4.8	Pass
Highest	1928.448	-4.5	4.8	Pass

The plots of the power spectral density are as below.

**TEST REPORT**

**PLOTS OF THE POWER SPECTRAL DENSITY**

For CS6214 series

Base unit, Lowest channel, Traffic carrier

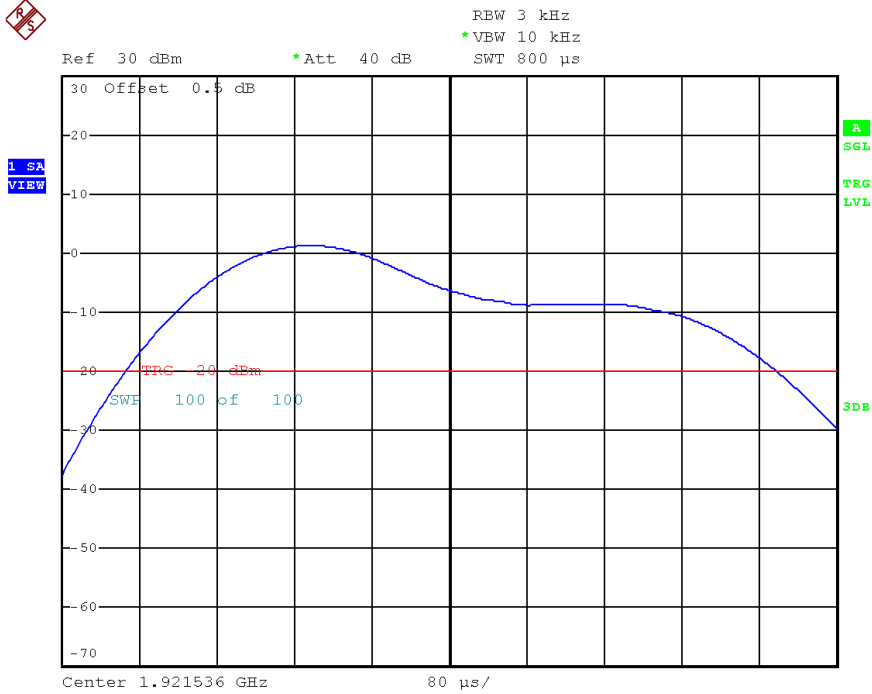

Base unit, Highest channel, Traffic carrier

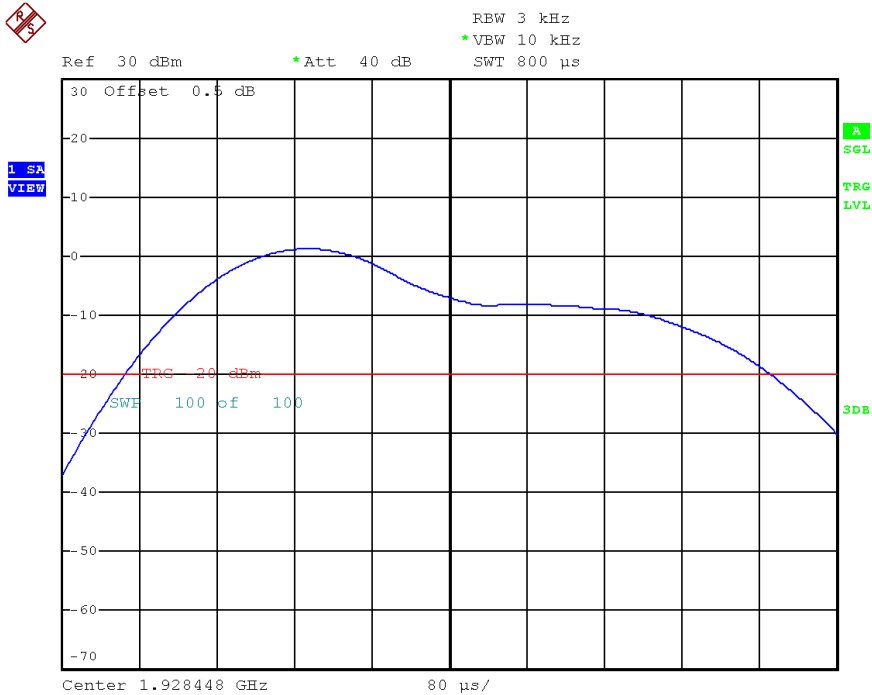

**TEST REPORT**

**PLOTS OF THE POWER SPECTRAL DENSITY**

For CS6224 series

Base unit, Lowest channel, Traffic carrier

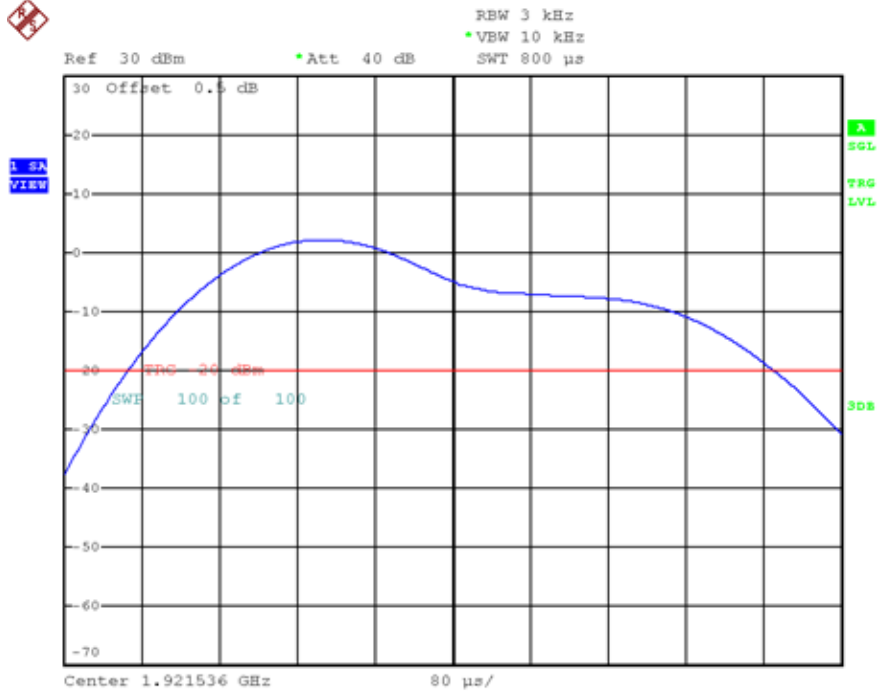

Base unit, Highest channel, Traffic carrier

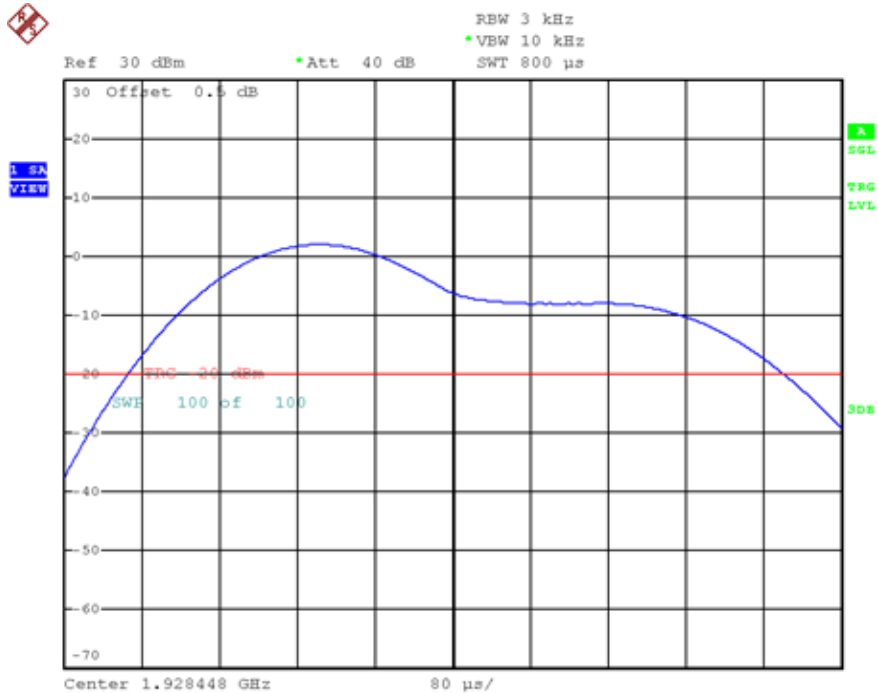

## TEST REPORT

### 4.7 Automatic Discontinuation of Transmission, FCC Rule 15.319(f):

The EUT shall automatically discontinue transmission in case of either absence of information to transmit or operational failure. These provisions are not intended to preclude transmission of control and signaling information or use of repetitive codes used by certain digital technologies to complete frame or burst intervals.

The manufacturer declares that the EUT can automatically discontinue transmission in case of either absent information to transmit or operational failure. Please refer to the declaration letter for details, which is saved with filename: declaration.pdf.

**TEST REPORT**

4.8 Unwanted Emission Inside the Sub-Band, FCC Rule 15.323(d):

Emissions inside the sub-band must comply with the following emission mask:

1. In the bands between  $1B$  and  $2B$  measured from the center of the emission bandwidth, emission shall be at least 30 dB below the permitted peak transmit power.
2. In the bands between  $2B$  and  $3B$  measured from the center of the emission bandwidth, emission shall be at least 50 dB below the permitted peak transmit power.
3. In the bands between  $3B$  and the band edge, emission shall be at least 60 dB below the permitted peak transmit power.

Where  $B$  = emission bandwidth in Hz

Measurements are made in accordance with ANSI C63.17 sub-clause 6.1.6.1. Test setup is shown in section 3.4 Figure 3.4.1

Test Results:

I. Base unit - Traffic Carrier

Channel	Channel Frequency (MHz)	Results
Lowest	1921.536	Pass
Middle	1924.992	Pass
Highest	1928.448	Pass

The plots of the unwanted emission inside the sub-band are as below.

**TEST REPORT**

**PLOTS OF THE UNWANTED EMISSION INSIDE THE SUB-BAND**

For CS6214 series

Base unit, Lowest channel, Traffic carrier

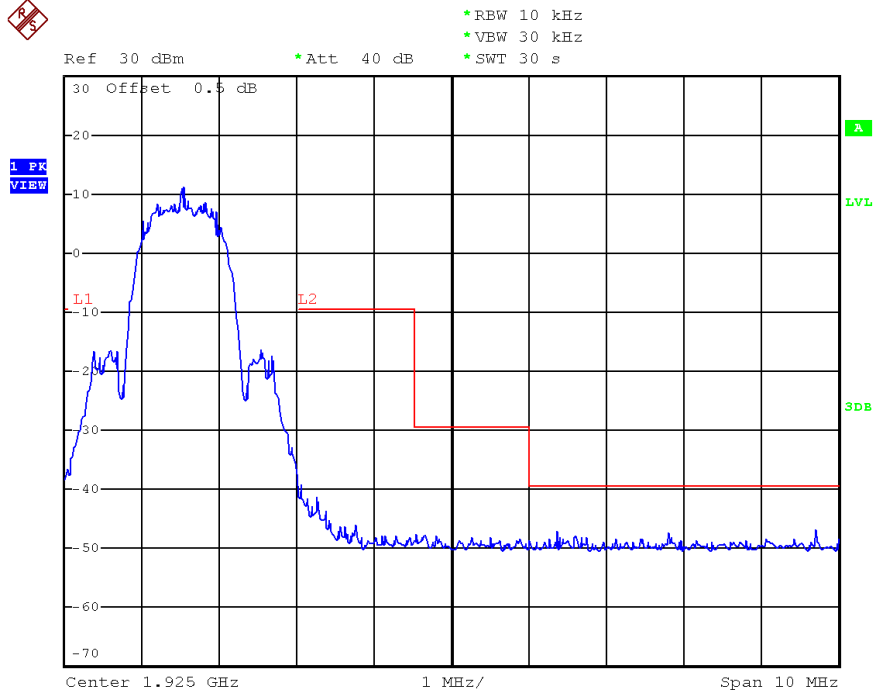

Base unit, Middle channel, Traffic carrier

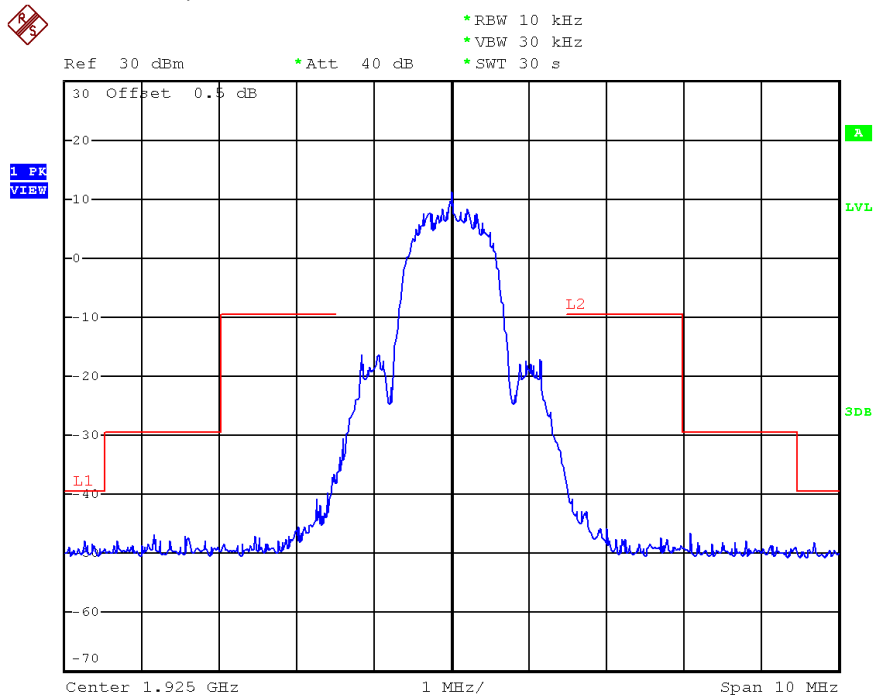



**TEST REPORT**

**PLOTS OF THE UNWANTED EMISSION INSIDE THE SUB-BAND**

For CS6224 series

Base unit, Lowest channel, Traffic carrier

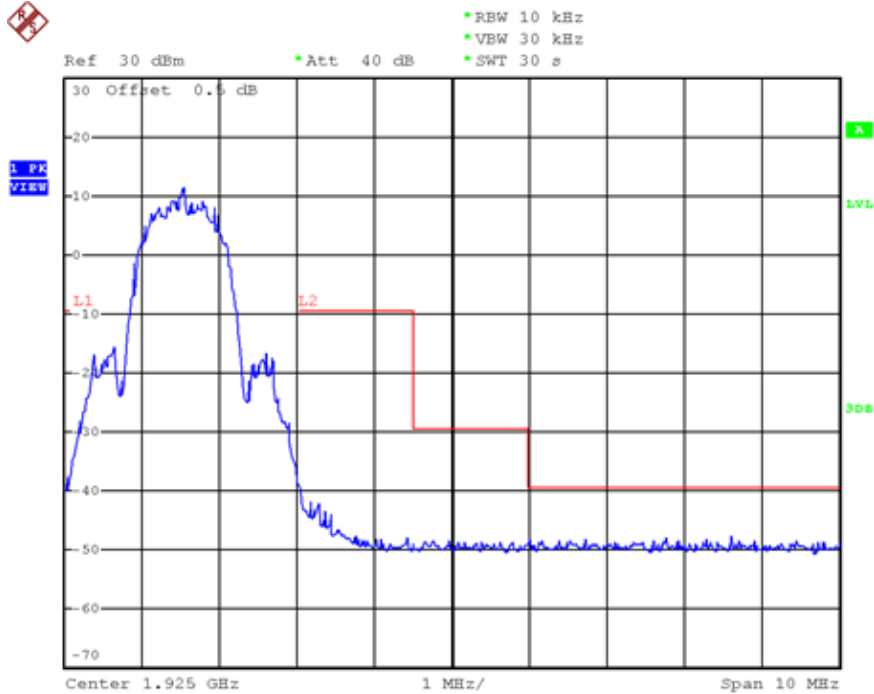

Base unit, Middle channel, Traffic carrier

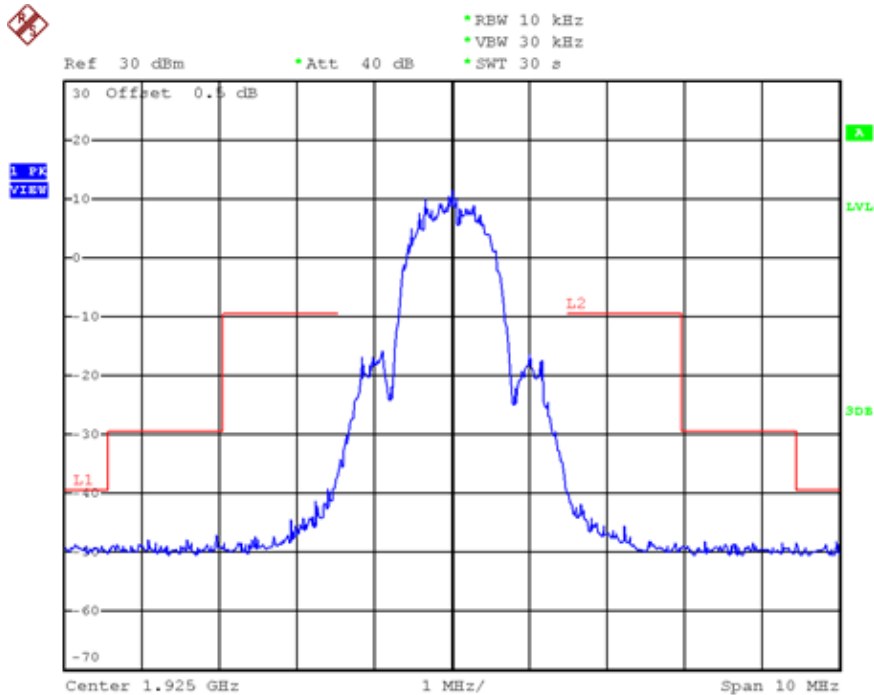

## TEST REPORT

### PLOTS OF THE UNWANTED EMISSION INSIDE THE SUB-BAND

Base unit, Highest channel, Traffic carrier

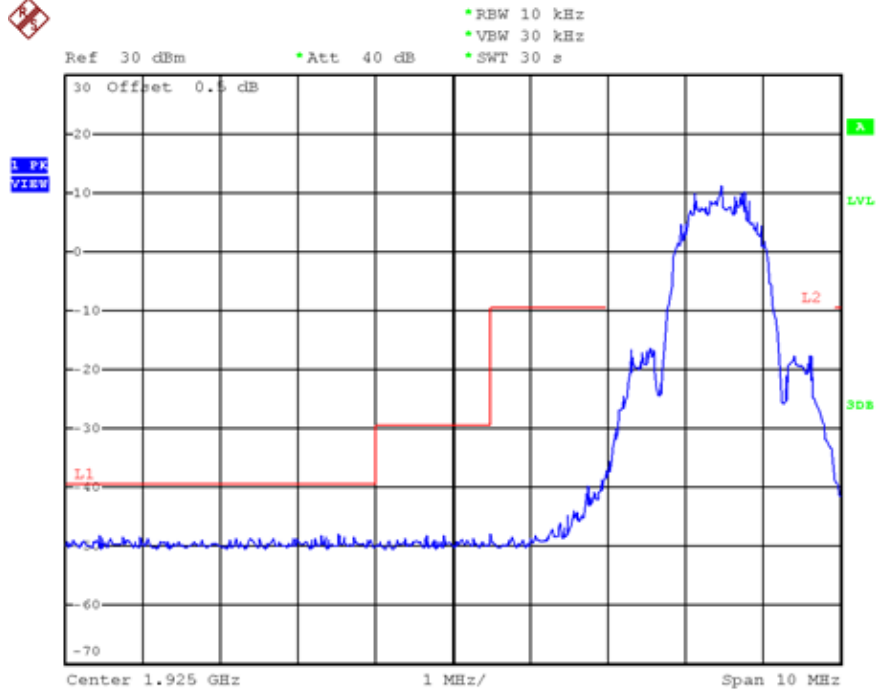

**TEST REPORT**

4.9 Emissions Outside the Sub-Band, FCC Rule 15.323(d):

Emissions outside the sub-band shall be attenuated below a reference power of 112 mW (20.5 dBm) as follows:

1. 30 dB between the band edge and 1.25 MHz above or below the band;
2. 50 dB between 1.25 and 2.5 MHz above or below the band; and
3. 60 dB at 2.5 MHz or greater above or below the band, or shall meet the requirement of FCC Rule 15.319(g) which shall not exceed the limits of FCC Rule 15.209.

Example: Calculation of Limit for emissions between the band edge and 1.25 MHz (1920.000 – 1918.750 MHz)

The emissions shall not exceed the Limit: 20.5 dBm – 30 dB = -9.5 dBm

Measurements are made in accordance with ANSI C63.17 sub-clause 6.1.6.2. Radiated emissions test method is used. Emissions that are directly caused by digital circuits in the transmit path and transmitter portion are measured.

Test setup is shown in section 3.2 Figure 3.2.1

Test Results:

Channel	Carrier Frequency (MHz)	Measured Band (MHz)	Limit (dBm)	Results
Lowest	1921.536	1920.000 - 1918.750	-9.5	Pass
		1918.750 - 1917.500	-29.5	Pass
		0.009 - 1917.500 & 1932.500 - 19300.000	-39.5 / RSS-Gen Clause 8.9	Pass
Highest	1928.448	1930.000 - 1931.250	-9.5	Pass
		1931.250 - 1932.500	-29.5	Pass
		0.009 – 1917.500 & 1932.500 - 19300.000	-39.5 / RSS-Gen Clause 8.9	Pass

## TEST REPORT

### 4.9.1 Radiated Emissions Configuration Photographs:

Worst Case Radiated Emission  
at

For CS6214 series: 3843.072 MHz

For CS6224 series: 3843.072 MHz

The worst case radiated emission configuration photographs are saved with filename: config photos.pdf

### 4.9.2 Radiated Emissions Data:

Data are included of the worst case configuration (the configuration which resulted in the highest emission levels). A sample calculation, configuration photographs and data tables of the emissions are included. All measurements were performed with peak detection unless otherwise specified.

The data in table 1-10 list the significant emission frequencies, the limit and the margin of compliance.

Judgement:

For CS6214 series - Passed by 7.9 dB margin

For CS6224 series - Passed by 10.6 dB margin

**TEST REPORT**

**RADIATED EMISSIONS DATA**

For CS6214 series:

Mode: Transmission with AoHai Adaptor

Table 1, Base Unit

**Pursuant to FCC Part 15 Section 15.323 (d) Emissions Requirements**

Lowest Channel

Polarization	Frequency (MHz)	Measured Power (dBm)	Power Limit (dBm)	Margin (dB)
V	1915.613	-64.0	-39.5	-24.5
V	1917.803	-63.1	-29.5	-33.6
V	1919.999	-48.8	-9.5	-39.3
V	3843.072	-47.4	-39.5	-7.9
H	5764.608	-63.1	-39.5	-23.6
V	7686.144	-59.5	-39.5	-20.0
H	9607.680	-67.6	-39.5	-28.1
V	11529.216	-66.7	-39.5	-27.2
H	13450.752	-63.0	-39.5	-23.5

NOTES:

1. Peak detector is used for the emission measurement.
2. All measurements were made at 3 meters.
3. Negative value in the margin column shows emission below limit.

**TEST REPORT**

Mode: Transmission with AoHai Adaptor

Table 2, Base Unit

**Pursuant to FCC Part 15 Section 15.323 (d) Emissions Requirements**

Highest Channel

Polarization	Frequency (MHz)	Measured Power (dBm)	Power Limit (dBm)	Margin (dB)
V	1930.001	-54.4	-9.5	-44.9
V	1931.450	-63.1	-29.5	-33.6
V	1932.977	-64.6	-39.5	-25.1
V	3856.896	-47.9	-39.5	-8.4
H	5785.344	-64.0	-39.5	-24.5
V	7713.792	-60.2	-39.5	-20.7
H	9642.240	-67.8	-39.5	-28.3
V	11570.688	-67.0	-39.5	-27.5
H	13499.136	-63.5	-39.5	-24.0

NOTES:

1. Peak detector is used for the emission measurement.
2. All measurements were made at 3 meters.
3. Negative value in the margin column shows emission below limit.

**TEST REPORT**

Mode: Talk with VTPL Adaptor

Table 3, Base Unit

**Pursuant to FCC Part 15 Section 15.323 (d) Emissions Requirements**

Polarization	Frequency (MHz)	Measured Power (dBm)	Power Limit (dBm)	Margin (dB)
V	55.834	-75.5	-39.5	-36.0
V	111.166	-69.5	-39.5	-30.0
V	118.789	-69.0	-39.5	-29.5
V	234.869	-69.0	-39.5	-29.5
V	890.554	-63.6	-39.5	-24.1
V	962.114	-62.1	-39.5	-22.6

NOTES:

1. Peak detector is used for the emission measurement.
2. All measurements were made at 3 meters.
3. Negative value in the margin column shows emission below limit.

**TEST REPORT**

Mode: Talk with Ten Pao Adaptor

Table 4, Base Unit

**Pursuant to FCC Part 15 Section 15.323 (d) Emissions Requirements**

Polarization	Frequency (MHz)	Measured Power (dBm)	Power Limit (dBm)	Margin (dB)
V	31.825	-75.8	-39.5	-36.3
V	56.688	-73.9	-39.5	-34.4
V	234.869	-70.4	-39.5	-30.9
V	262.670	-67.0	-39.5	-27.5
H	345.653	-68.9	-39.5	-29.4
H	960.770	-58.1	-39.5	-18.6

NOTES:

1. Peak detector is used for the emission measurement.
2. All measurements were made at 3 meters.
3. Negative value in the margin column shows emission below limit.

**TEST REPORT**

Mode: Talk with AoHai Adaptor

Table 5, Base Unit

**Pursuant to FCC Part 15 Section 15.323 (d) Emissions Requirements**

Polarization	Frequency (MHz)	Measured Power (dBm)	Power Limit (dBm)	Margin (dB)
V	131.397	-74.4	-39.5	-34.9
V	235.113	-71.4	-39.5	-31.9
H	290.322	-68.4	-39.5	-28.9
H	317.916	-65.5	-39.5	-26.0
H	345.653	-71.3	-39.5	-31.8
V	961.670	-56.8	-39.5	-17.3

NOTES:

1. Peak detector is used for the emission measurement.
2. All measurements were made at 3 meters.
3. Negative value in the margin column shows emission below limit.

**TEST REPORT**

For CS6224 series:

Mode: Transmission with AoHai Adaptor

Table 6, Base Unit

**Pursuant to FCC Part 15 Section 15.323 (d) Emissions Requirements**

Lowest Channel

Polarization	Frequency (MHz)	Measured Power (dBm)	Power Limit (dBm)	Margin (dB)
H	1915.707	-54.8	-39.5	-15.3
H	1917.838	-53.9	-29.5	-24.4
H	1919.012	-49.1	-9.5	-39.6
H	3843.072	-50.1	-39.5	-10.6
V	5764.608	-60.5	-39.5	-21.0
V	7686.144	-62.7	-39.5	-23.2
H	9607.680	-62.4	-39.5	-22.9
V	11529.216	-59.1	-39.5	-19.6
H	13450.752	-57.0	-39.5	-17.5

NOTES:

1. Peak detector is used for the emission measurement.
2. All measurements were made at 3 meters.
3. Negative value in the margin column shows emission below limit.

**TEST REPORT**

Mode: Transmission with AoHai Adaptor

Table 7, Base Unit

**Pursuant to FCC Part 15 Section 15.323 (d) Emissions Requirements**

Highest Channel

Polarization	Frequency (MHz)	Measured Power (dBm)	Power Limit (dBm)	Margin (dB)
H	1930.010	-49.5	-9.5	-40.0
H	1931.750	-54.6	-29.5	-25.1
H	1933.319	-54.9	-39.5	-15.4
H	3856.896	-51.0	-39.5	-11.5
V	5785.344	-61.4	-39.5	-21.9
V	7713.792	-63.5	-39.5	-24.0
H	9642.240	-62.9	-39.5	-23.4
V	11570.688	-59.4	-39.5	-19.9
H	13499.136	-57.3	-39.5	-17.8

NOTES:

1. Peak detector is used for the emission measurement.
2. All measurements were made at 3 meters.
3. Negative value in the margin column shows emission below limit.

**TEST REPORT**

Mode: Talk with VTPL Adaptor

Table 8, Base Unit

**Pursuant to FCC Part 15 Section 15.323 (d) Emissions Requirements**

Polarization	Frequency (MHz)	Measured Power (dBm)	Power Limit (dBm)	Margin (dB)
V	45.353	-78.4	-39.5	-38.9
V	56.322	-76.0	-39.5	-36.5
V	124.084	-69.2	-39.5	-29.7
V	159.745	-69.2	-39.5	-29.7
V	393.184	-67.4	-39.5	-27.9
V	891.671	-64.4	-39.5	-24.9

NOTES:

1. Peak detector is used for the emission measurement.
2. All measurements were made at 3 meters.
3. Negative value in the margin column shows emission below limit.

**TEST REPORT**

Mode: Talk with Ten Pao Adaptor

Table 9, Base Unit

**Pursuant to FCC Part 15 Section 15.323 (d) Emissions Requirements**

Polarization	Frequency (MHz)	Measured Power (dBm)	Power Limit (dBm)	Margin (dB)
V	31.947	-75.0	-39.5	-35.5
V	55.713	-77.6	-39.5	-38.1
V	62.781	-77.0	-39.5	-37.5
V	131.763	-69.9	-39.5	-30.4
V	158.331	-72.8	-39.5	-33.3
H	393.222	-66.1	-39.5	-26.6

NOTES:

1. Peak detector is used for the emission measurement.
2. All measurements were made at 3 meters.
3. Negative value in the margin column shows emission below limit.

**TEST REPORT**

Mode: Talk with AoHai Adaptor

Table 10, Base Unit

**Pursuant to FCC Part 15 Section 15.323 (d) Emissions Requirements**

Polarization	Frequency (MHz)	Measured Power (dBm)	Power Limit (dBm)	Margin (dB)
V	72.166	-80.3	-39.5	-40.8
V	118.966	-70.8	-39.5	-31.3
V	131.397	-70.2	-39.5	-30.7
V	143.584	-76.3	-39.5	-36.8
V	393.215	-61.8	-39.5	-22.3
H	961.609	-60.1	-39.5	-20.6

NOTES:

1. Peak detector is used for the emission measurement.
2. All measurements were made at 3 meters.
3. Negative value in the margin column shows emission below limit.

## TEST REPORT

### 4.9.3 Field Strength Calculation

The field strength is calculated by adding the reading on the Spectrum Analyzer to the factors associated with preamplifiers (if any), antennas, cables, pulse desensitization and average factors (when specified limit is in average and measurements are made with peak detectors). A sample calculation is included below.

$$FS = RA + AF + CF - AG + PD + AV$$

Where FS = Field Strength in dB $\mu$ V/m

RA = Receiver Amplitude (including preamplifier) in dB $\mu$ V

CF = Cable Attenuation Factor in dB

AF = Antenna Factor in dB

AG = Amplifier Gain in dB

PD = Pulse Desensitization in dB

AV = Average Factor in -dB

In the radiated emission table which follows, the reading shown on the data table may reflect the preamplifier gain. An example of the calculations, where the reading does not reflect the preamplifier gain, follows:

$$FS = RA + AF + CF - AG + PD + AV$$

#### Example

Assume a receiver reading of 62.0 dB $\mu$ V is obtained. The antenna factor of 7.4 dB and cable factor of 1.6 dB is added. The amplifier gain of 29.0 dB is subtracted. The pulse desensitization factor of the spectrum analyzer is 0.0 dB, and the resultant average factor is -10.0 dB. The net field strength for comparison to the appropriate emission limit is 32.0 dB $\mu$ V/m. This value in dB $\mu$ V/m is converted to its corresponding level in  $\mu$ V/m.

$$RA = 62.0 \text{ dB}\mu\text{V}$$

$$AF = 7.4 \text{ dB}$$

$$CF = 1.6 \text{ dB}$$

$$AG = 29.0 \text{ dB}$$

$$PD = 0.0 \text{ dB}$$

$$AV = -10 \text{ dB}$$

$$FS = 62.0 + 7.4 + 1.6 - 29.0 + 0.0 + (-10.0) = 32.0 \text{ dB}\mu\text{V/m}$$

$$\text{Level in } \mu\text{V/m} = \text{Common Antilogarithm } [(32.0 \text{ dB}\mu\text{V/m})/20] = 39.8 \mu\text{V/m}$$

## TEST REPORT

### 4.9.4 Average Factor Calculation and Transmitter ON Time Measurements, FCC Rule 15.35(b, c)

- [ ] The EUT antenna output port was connected to the input of the spectrum analyzer. The analyzer center frequency was set to EUT RF channel carrier. The SPAN function on the analyzer was set to ZERO. The transmitter ON time was determined from the resultant time-amplitude display:

Please refer to the attached plots for more details:

The plots of Transmitter ON Time Measurements are as below.

- [ ] Please refer to the attached transmitter timing diagram that are provided by manufacturer
- [ x ] Not applicable - No average factor is required.
- [ ] Please refer to Technical Description (descri.pdf) for more details

## TEST REPORT

### 4.10 AC Power Line Conducted Emissions, FCC Rule 15.315:

The AC power line conducted emission shall not exceed the limits of FCC Rule 15.207.

Measurements are made in accordance with ANSI C63.4 sub-clause 7. Emissions that are directly caused by digital circuits in the transmit path and transmitter portion are measured.

Test setup is shown in section 3.3 Figure 3.3.1.

- [ ] Not applicable – EUT is only powered by battery for operation.
  
- [ ] EUT connects to AC power line. Emission Data is listed in following pages.
  
- [ x ] Base Unit connects to AC power line and has transmission. Handset connects to AC power line (indirectly) but has no transmission. Emission Data of Base Unit is listed in following pages.
  
- [ ] Handset connects to AC power line (indirectly) only during charging. Emission Data is listed in following pages.

## TEST REPORT

### 4.10.1 AC Power Line Conducted Emissions Configuration Photographs:

Worst Case AC Power Line Conducted Emission  
at

For CS6214 series: 528 kHz

For CS6214 series: 528 kHz

The worst case AC power Line conducted emission configuration photographs are saved with filename: config photos.pdf

### 4.10.2 AC Power Line Conducted Emissions Data:

The plot(s) and data in the following pages list the significant emission frequencies, the limit and the worst case margin of compliance.

Judgment:

For CS6214 series: Passed by 9.63 dB margin compared with the quasi-peak limit

For CS6214 series: Passed by 9.56 dB margin compared with the quasi-peak limit

**TEST REPORT**

Model No.: CS6214-2  
Worst Case: Talk with VTPL Adaptor



RES 9 kHz  
MT 1 s

Att 10 dB AUTIC PREAMP OFF

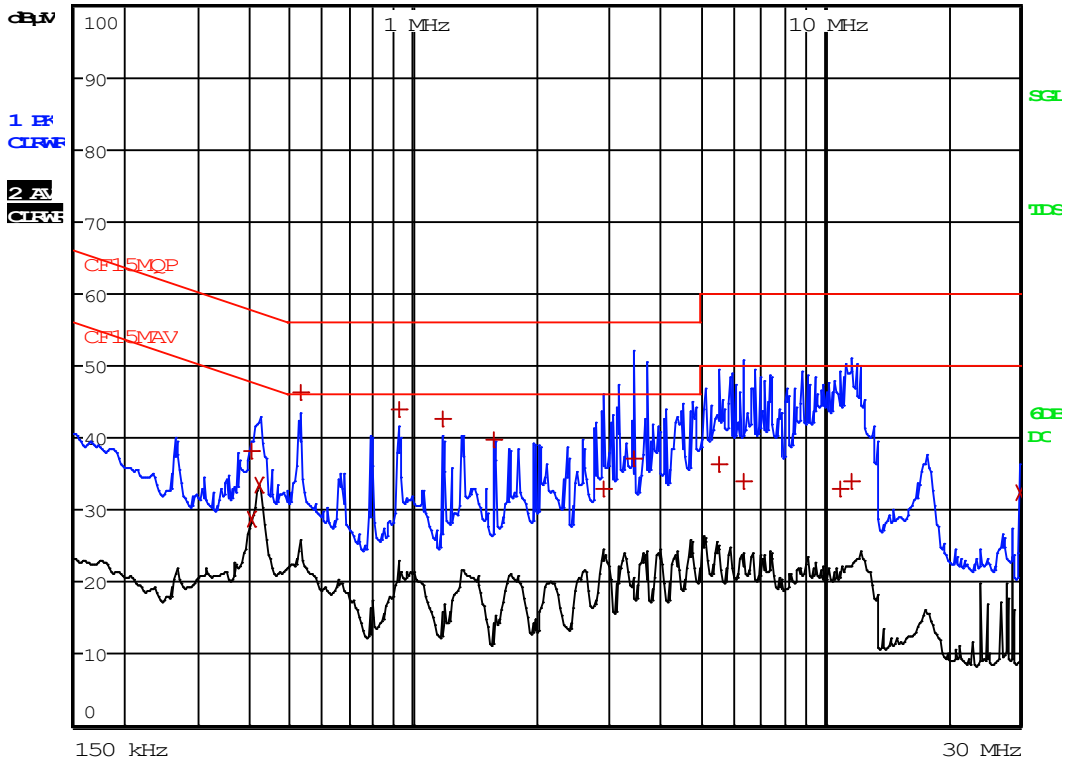

**TEST REPORT**

Model No.: CS6214-2  
Worst Case: Talk with VTPL Adaptor

EDIT PEAK LIST (Final Measurement Results)				
Trace1:	CF15MQP			
Trace2:	CF15MAV			
Trace3:	---			
TRACE	FREQUENCY	LEVEL dB $\mu$ V		DELTA LIMIT dB
1 Quasi Peak	402 kHz	38.29	L1	-19.51
2 CISPR Average	402 kHz	28.73	L1	-19.07
2 CISPR Average	420 kHz	33.59	L1	-13.85
1 Quasi Peak	528 kHz	46.36	L1	-9.63
1 Quasi Peak	924 kHz	44.00	L1	-11.99
1 Quasi Peak	1.185 MHz	42.52	N	-13.47
1 Quasi Peak	1.5765 MHz	39.80	N	-16.19
1 Quasi Peak	2.913 MHz	33.06	N	-22.93
1 Quasi Peak	3.462 MHz	37.01	L1	-18.98
1 Quasi Peak	5.5815 MHz	36.26	L1	-23.73
1 Quasi Peak	6.3825 MHz	33.92	L1	-26.08
1 Quasi Peak	10.9815 MHz	33.02	L1	-26.97
1 Quasi Peak	11.7375 MHz	34.02	L1	-25.97
2 CISPR Average	29.9985 MHz	32.46	L1	-17.53

**TEST REPORT**

Model No.: CS6214-2  
Worst Case: Talk with Ten Pao Adaptor



RBW 9 kHz  
MT 1 s  
Att 10 dB AUTIC PREAMP OFF

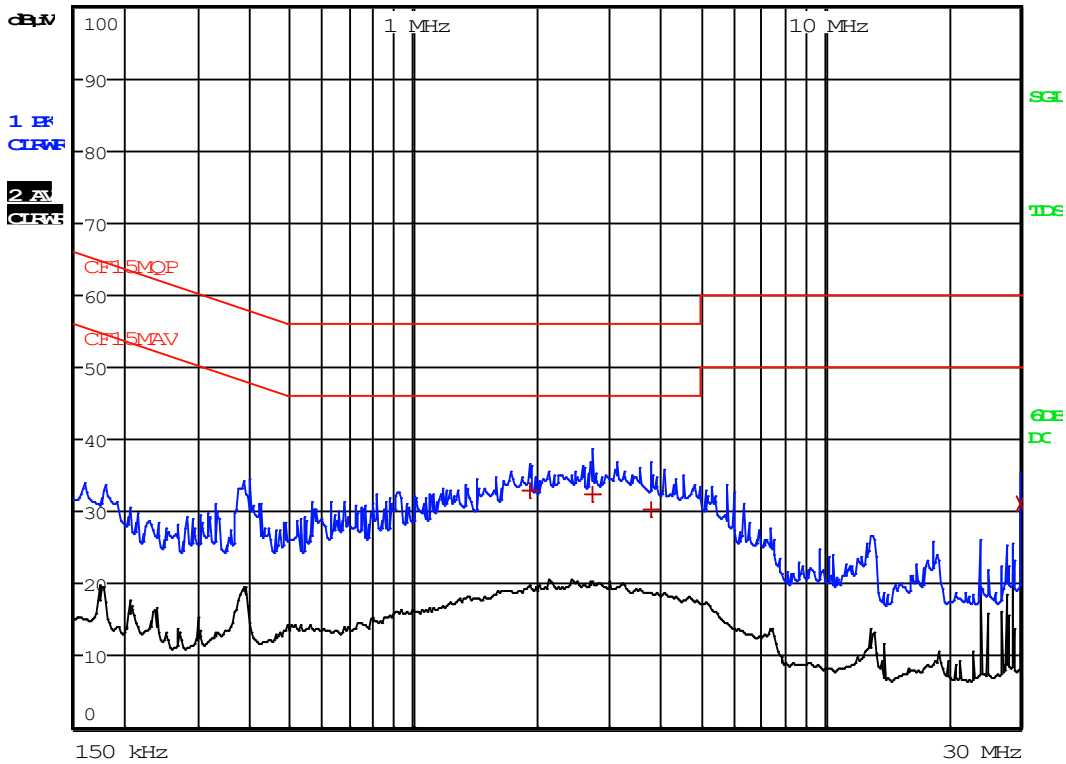

**TEST REPORT**

Model No.: CS6214-2  
Worst Case: Talk with Ten Pao Adaptor

EDIT PEAK LIST (Final Measurement Results)				
Trace1:	CF15MQP			
Trace2:	CF15MAV			
Trace3:	---			
TRACE	FREQUENCY	LEVEL dB $\mu$ V		DELTA LIMIT dB
1 Quasi Peak	1.932 MHz	32.95	N	-23.04
1 Quasi Peak	2.7195 MHz	32.50	N	-23.49
1 Quasi Peak	3.804 MHz	30.41	N	-25.58
2 CISPR Average	29.9985 MHz	30.99	N	-19.01

**TEST REPORT**

Model No.: CS6214-2  
Worst Case: Talk with AoHai Adaptor



REW 9 kHz  
MT 1 s  
Att 10 dB AUTIC PREAMP OFF

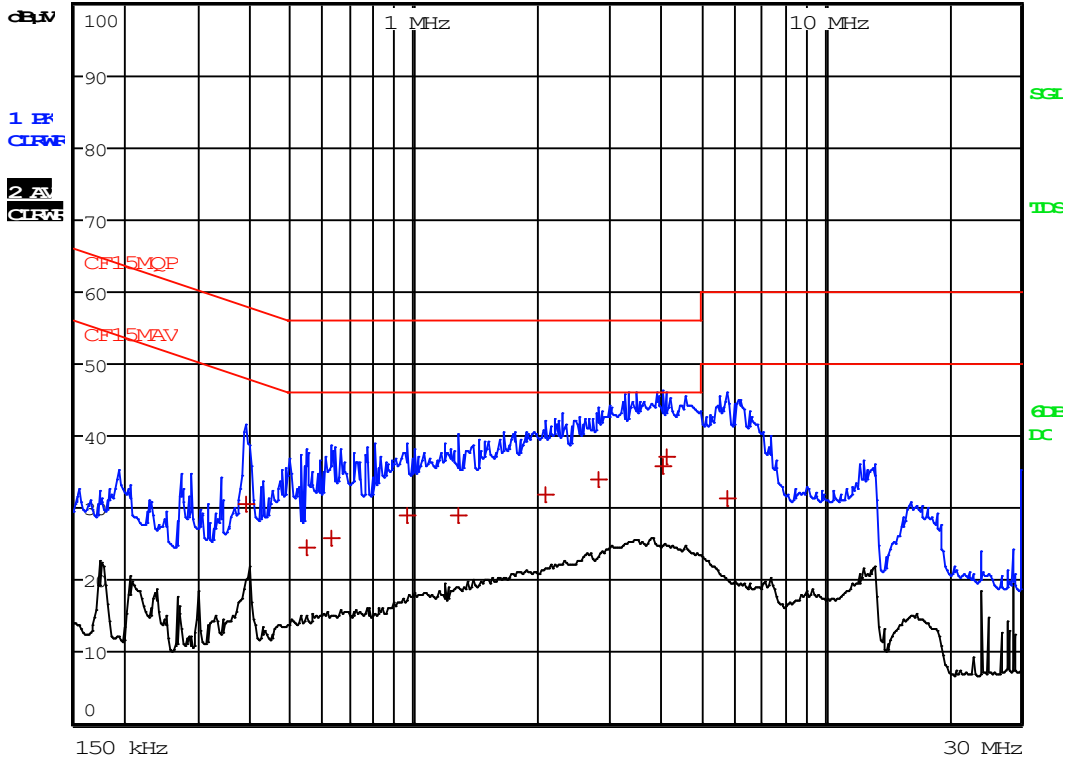

**TEST REPORT**

Model No.: CS6214-2  
Worst Case: Talk with AoHai Adaptor

EDIT PEAK LIST (Final Measurement Results)				
Trace1:	CF15MQP			
Trace2:	CF15MAV			
Trace3:	---			
TRACE	FREQUENCY	LEVEL dB $\mu$ V		DELTA LIMIT dB
1 Quasi Peak	388.5 kHz	30.59	L1	-27.50
1 Quasi Peak	550.5 kHz	24.41	N	-31.58
1 Quasi Peak	631.5 kHz	25.77	N	-30.22
1 Quasi Peak	964.5 kHz	29.12	N	-26.87
1 Quasi Peak	1.2885 MHz	29.09	N	-26.90
1 Quasi Peak	2.085 MHz	31.98	N	-24.01
1 Quasi Peak	2.8275 MHz	34.03	N	-21.96
1 Quasi Peak	4.0425 MHz	35.77	N	-20.22
1 Quasi Peak	4.1325 MHz	37.26	N	-18.73
1 Quasi Peak	5.802 MHz	31.45	N	-28.54

**TEST REPORT**

Model No.: CS6224-2  
Worst Case: Talk with VTPL Adaptor



RESW 9 kHz  
MT 1 s

Att 10 dB AUTIC PREAMP OFF

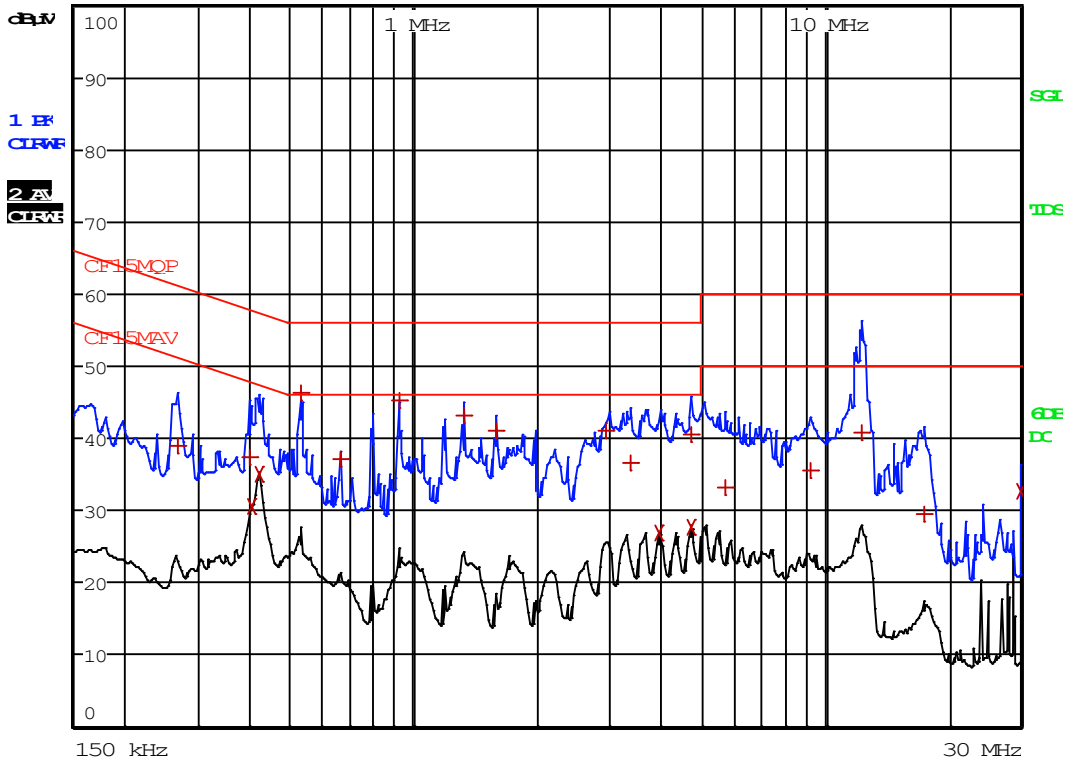

**TEST REPORT**

Model No.: CS6224-2  
Worst Case: Talk with VTPL Adaptor

EDIT PEAK LIST (Final Measurement Results)				
Trace1:		CF15MQP		
Trace2:		CF15MAV		
Trace3:		---		
TRACE	FREQUENCY	LEVEL dB $\mu$ V		DELTA LIMIT dB
1 Quasi Peak	267 kHz	38.88	L1	-22.33
1 Quasi Peak	397.5 kHz	37.43	L1	-20.47
2 CISPR Average	402 kHz	30.58	L1	-17.22
2 CISPR Average	420 kHz	35.11	L1	-12.33
1 Quasi Peak	528 kHz	46.43	L1	-9.56
1 Quasi Peak	663 kHz	37.26	L1	-18.73
1 Quasi Peak	924 kHz	45.39	L1	-10.60
1 Quasi Peak	1.3245 MHz	43.10	L1	-12.89
1 Quasi Peak	1.59 MHz	41.04	N	-14.95
1 Quasi Peak	2.931 MHz	41.06	L1	-14.93
1 Quasi Peak	3.363 MHz	36.71	L1	-19.28
2 CISPR Average	3.9525 MHz	26.82	N	-19.17
2 CISPR Average	4.74 MHz	27.71	N	-18.28
1 Quasi Peak	4.767 MHz	40.49	N	-15.50
1 Quasi Peak	5.739 MHz	33.13	L1	-26.86
1 Quasi Peak	9.204 MHz	35.64	L1	-24.35
1 Quasi Peak	12.3765 MHz	40.79	L1	-19.20
1 Quasi Peak	17.4255 MHz	29.63	L1	-30.36
2 CISPR Average	29.9985 MHz	32.72	L1	-17.27

**TEST REPORT**

Model No.: CS6224-2  
Worst Case: Talk with Ten Pao Adaptor



RES 9 kHz  
MT 1 s

Att 10 dB AUTOC PREAMP OFF

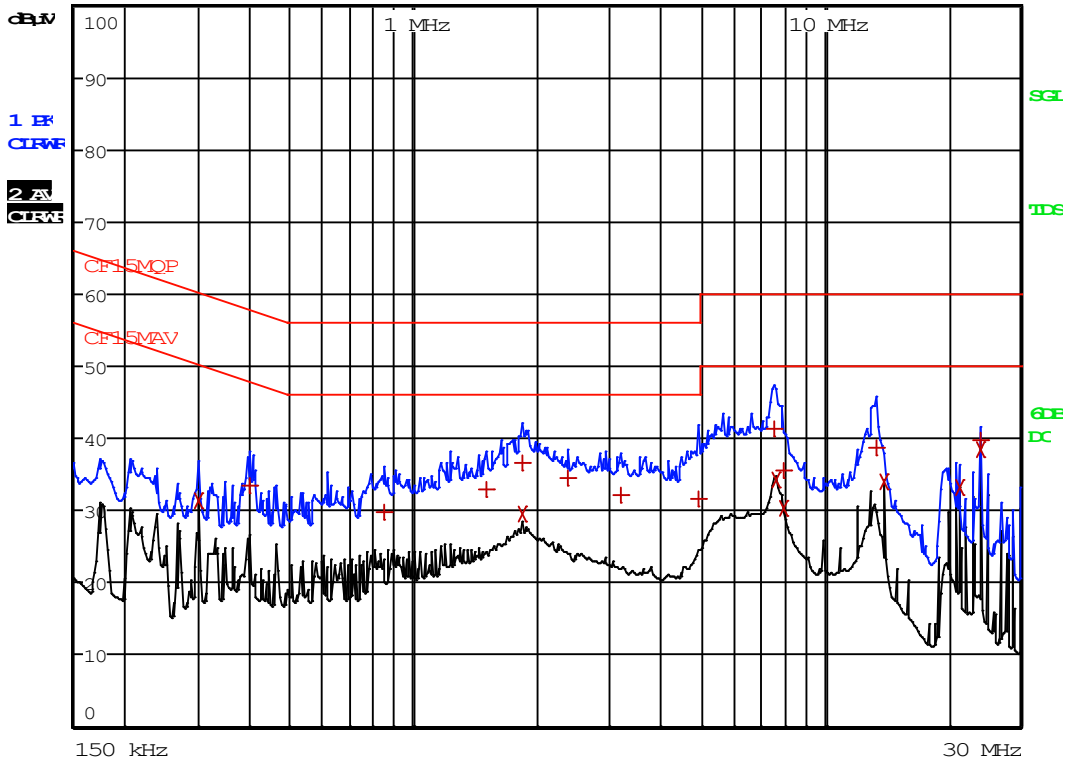

**TEST REPORT**

Model No.: CS6224-2  
Worst Case: Talk with Ten Pao Adaptor

EDIT PEAK LIST (Final Measurement Results)				
Trace1:		CF15MQP		
Trace2:		CF15MAV		
Trace3:		---		
TRACE	FREQUENCY	LEVEL	dB $\mu$ V	DELTA LIMIT dB
2	CISPR Average 298.5 kHz	31.47	N	-18.80
1	Quasi Peak 397.5 kHz	33.38	N	-24.52
1	Quasi Peak 852 kHz	29.75	N	-26.24
1	Quasi Peak 1.5045 MHz	33.06	N	-22.93
2	CISPR Average 1.842 MHz	29.62	N	-16.37
1	Quasi Peak 1.851 MHz	36.71	N	-19.28
1	Quasi Peak 2.3865 MHz	34.48	N	-21.51
1	Quasi Peak 3.201 MHz	32.26	N	-23.73
1	Quasi Peak 4.9695 MHz	31.65	N	-24.34
1	Quasi Peak 7.566 MHz	41.25	L1	-18.74
2	CISPR Average 7.6425 MHz	34.30	N	-15.69
2	CISPR Average 8.0025 MHz	30.37	N	-19.62
1	Quasi Peak 8.007 MHz	35.66	L1	-24.33
1	Quasi Peak 13.425 MHz	38.66	L1	-21.33
2	CISPR Average 14.001 MHz	33.97	N	-16.02
2	CISPR Average 21.48 MHz	33.13	L1	-16.86
1	Quasi Peak 24 MHz	39.77	L1	-20.22
2	CISPR Average 24 MHz	38.53	L1	-11.46

**TEST REPORT**

Model No.: CS6224-2  
Worst Case: Talk with AoHai Adaptor



RES 9 kHz  
MT 1 s

Att 10 dB AUTIC PREAMP OFF

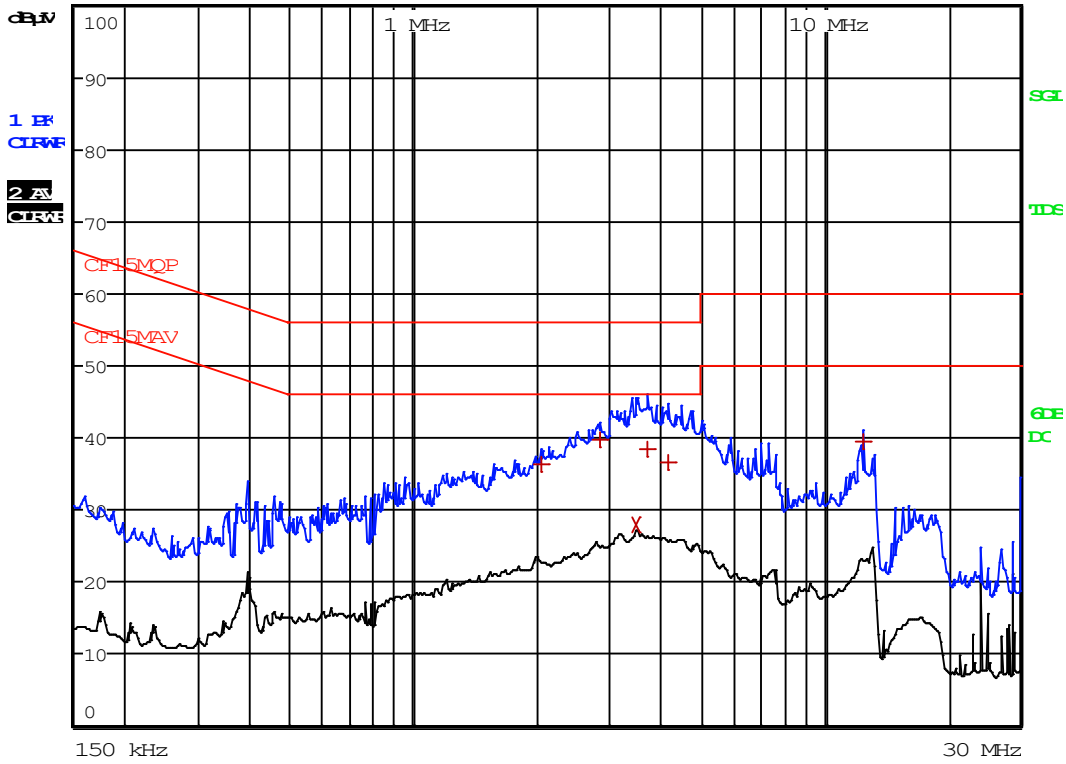

**TEST REPORT**

Model No.: CS6224-2  
Worst Case: Talk with AoHai Adaptor

EDIT PEAK LIST (Final Measurement Results)					
TRACE		FREQUENCY	LEVEL dB $\mu$ V		DELTA LIMIT dB
Trace1:	CF15MQP				
Trace2:	CF15MAV				
Trace3:	---				
1	Quasi Peak	2.0535 MHz	36.34	N	-19.65
1	Quasi Peak	2.859 MHz	39.70	N	-16.30
2	CISPR Average	3.5025 MHz	28.02	N	-17.97
1	Quasi Peak	3.705 MHz	38.53	N	-17.47
1	Quasi Peak	4.182 MHz	36.69	N	-19.30
1	Quasi Peak	12.381 MHz	39.60	N	-20.39

**TEST REPORT**

4.11 Frame Repetition Stability, FCC Rule 15.323(e):

- [ ] EUT implements Time Division Duplex (TDD) (not include TDMA) in order to support duplex connection on a given frequency carrier shall maintain a frame repetition rate whereby 3 x standard deviation of the frequency stability shall not exceed 50 ppm, not including a shift of the mean.
- [ x ] EUT uses Time Division Multiple Access (TDMA) in order to support multiple communication links on a given frequency carrier shall maintain a frame repetition rate whereby 3 x standard deviation of the frequency stability shall not exceed 10 ppm, not including a shift of the mean.

Measurements are made in accordance with ANSI C63.17 sub-clause 6.2.2. Test setup is shown in section 3.4 Figure 3.4.1. A spectrum analyzer measures the time duration between rising edges of two consecutive frames over a time period of at least 1000 frame periods. These measurement values are used to compute the 3 x standard deviation of the frequency stability.

Test Results:

I. Base unit

Maximum Frame Repetition Stability (ppm)	Limit (ppm)	Results
0.0405	±10	Pass

**TEST REPORT**

4.12 Frame Period and Jitter, FCC Rule 15.323(e):

The frame period (a set of consecutive time slots in which the position of each time slot can be identified by reference to a synchronizing source) of EUT operating in these sub-bands shall be 20 ms or 10 ms/X where X is a positive whole number.

The jitter (time-related, abrupt, spurious variations in the duration of the frame interval) introduced at the two ends of such a communication link shall not exceed 25 μs for any two consecutive transmissions. Transmissions shall be continuous in every time and spectrum window during the frame period defined for EUT.

Measurements are made in accordance with ANSI C63.17 sub-clause 6.2.3. Test setup is shown in section 3.4 Figure 3.4.1. A spectrum analyzer measures the time duration between the rising edges of two consecutive frames. The measurements are taken over 100,000 frames. These measurement values are used to compute mean value and the difference between any two consecutive frame periods. The mean value is the frame period.

Test Results:

I. Base unit

Measured Maximum Jitter (μs)	Limit (μs)	Result
-0.2369	±25	Pass

**TEST REPORT**

4.13 Carrier Frequency Stability, FCC Rule 15.323(f):

The carrier frequency stability of EUT shall be maintained within +/-10 ppm at the following conditions:

1. Over 1 hour at nominal supply voltage and a temperature of +20 °C;
2. Over a variation in the primary supply voltage of 85 % to 115 % of nominal supply voltage at a temperature of +20 °C. This test does not apply to an EUT that is only powered by battery for operation;
3. Over a temperature variation of -20 °C to +50 °C or at extreme temperatures as declared by manufacturer, and at nominal supply voltage.

The nominal supply voltage: 115 VAC and the extreme temperatures of -20°C to +50°C are declared by manufacturer.

Measurements are made in accordance with ANSI C63.17 sub-clause 6.2.1 The EUT and CMD60 is connected with shielded coaxial cable. The EUT is controlled by DECT Radio Communication Tester, CMD60, to use a fixed frequency channel during test as well as record the frequency offset. The transmission of EUT is in burst mode with pseudo-random data. Test setup is shown as follows.

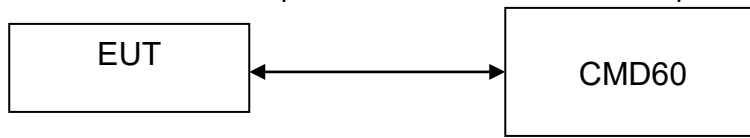

Test Results:

I a. Carrier Frequency Stability over time - base unit

Supply Voltage	Temperature (°C)	Measured Frequency Offset Over an hour (ppm)		Limit (ppm)	Result
		Max.	Min.		
Nominal	+20°C	0.57	-1.24	±10	Pass

I b. Carrier Frequency Stability over Power Supply Voltage - base unit

Supply Voltage	Temperature (°C)	Measured Frequency Offset (ppm)	Limit (ppm)	Results
85%	+20°C	0.73	±10	Pass
115%	+20°C	0.73	±10	Pass

I c. Carrier Frequency Stability over Temperature - base unit

Supply Voltage	Temperature (°C)	Measured Frequency Offset (ppm)	Limit (ppm)	Results
Nominal	-20°C	-2.36	±10	Pass
Nominal	+50°C	1.05	±10	Pass

**TEST REPORT**

4.14 Monitoring Threshold:

Monitoring threshold can be relaxed according to FCC Rule 15.323(c)(9). EUT that has a power output lower than the maximum permitted under FCC Rule 15.319(c) may increase their monitoring detection threshold by one decibel for each one decibel that the transmitter power is below the maximum permitted.

Calculation of Monitoring Threshold Limit:

$$\begin{aligned} \text{Monitoring Threshold } (T) &\leq -174 + 10 \log_{10} B + M_L + P_{\max} - P_{\text{EUT}} \text{ dBm} \\ &\leq 15 \log_{10} B - 184 + M_L - P_{\text{EUT}} \text{ dBm} \end{aligned}$$

- Where
- $B$  = Measured Emission Bandwidth - 1.48 x10<sup>6</sup>Hz
  - $M_L$  = Specified by the manufacturer declared in declaration.pdf for Monitoring Threshold ( $T_L$ )
  - $P_{\max}$  =  $5 \log_{10} B - 10$  dBm
  - $P_{\text{EUT}}$  = Measured Peak Transmit Power - 19.96 dBm

Calculated Monitoring Threshold Limits:

I. Base unit

Monitoring Threshold ( $T_L + U_M$ ) in dBm	-75.4
---	-------

NA - Not applicable

**TEST REPORT**

4.14.1 Monitoring Threshold Limit, FCC Rule 15.323(c)(2):

- [ × ] Not applicable – EUT supports at least of 20 duplex system access channels and implements Least Interfered Channel (LIC) algorithm. Please refer to the section 4.14.2 for more details.
- [ ] The monitoring threshold must not be more than 30 dB above the thermal noise power for a bandwidth equivalent to the emission bandwidth used by EUT.

Measurements are made in accordance with ANSI C63.17 sub-clause 7.3.1. Test setup is shown in section 3.5 Figure 3.5.1. The test is performed on the carrier closest to center of the band. RF signal generators apply uniform CW interference on all EUT carriers each at level  $T_L + U_M + 10$  dB. Then, the interference level is reduced uniformly on all carriers until the EUT can transmit. The interference level shall be lower than or equal to the threshold limit.

Test Results:

I. Base unit

Measured Maximum Interference Level (dBm)	Monitoring Threshold Limit (dBm) ( $T_L + U_M$ )	Results
NA	-75.4	NA

NA - Not applicable

## TEST REPORT

### 4.14.2 Least Interfered Channel, LIC, FCC Rule 15.323(c)(5):

- [ ] Not implemented – EUT met monitoring threshold requirements. Please refer to the section 4.14.1 for more details
  
- [ × ] If access to spectrum is not available as determined by section 4.14.1 and a minimum of 20 duplex system access channels are defined for the EUT, the time and spectrum windows with the lowest power level may be accessed

Number of duplex channels per frequency channel = 12

Number of frequency channel = 5

Total Duplex Channels = 60

**TEST REPORT**

4.14.2.1 Least Interfered Channel (LIC) Selection, FCC Rule 15.323(c)(5):

The criteria are specified in section 4.14.2. In addition, the power measurement resolution for this comparison must be accurate to within 6 dB.

Measurements are made in accordance with ANSI C63.17 sub-clause 7.3.2. Test setup is shown in section 3.5 Figure 3.5.1. RF signal generators apply uniform CW interference on all EUT carriers except two carriers (designated  $f_1$  and  $f_2$ ), each at level  $T_L + U_M + 14\text{dB}$  (cases 1 and 2) and  $T_L + U_M + 8\text{dB}$  (cases 3 and 4). EUT can only transmit on  $f_2$  carrier (cases 1 and 3) and  $f_1$  carrier (cases 2 and 4).

Test Descriptions and Results:

I. LIC Procedure - Base unit

	Test Descriptions	EUT Transmits on	Results
1	Apply interference on $f_1$ at level $T_L + U_M + 7\text{ dB}$ . Apply interference on $f_2$ at level $T_L + U_M$ . Initiate transmission. Verify transmission on $f_2$ . Terminate transmission. Repeat 5 times.	$f_2$	Pass
2	Apply interference on $f_1$ at level $T_L + U_M$ . Apply interference on $f_2$ at level $T_L + U_M + 7\text{ dB}$ . Initiate transmission. Verify transmission on $f_1$ . Terminate transmission. Repeat 5 times.	$f_1$	Pass
3	Apply interference on $f_1$ at level $T_L + U_M + 1\text{ dB}$ . Apply interference on $f_2$ at level $T_L + U_M - 6\text{ dB}$ . Initiate transmission. Verify transmission on $f_2$ . Terminate transmission. Repeat 5 times.	$f_2$	Pass
4	Apply interference on $f_1$ at level $T_L + U_M - 6\text{ dB}$ . Apply interference on $f_2$ at level $T_L + U_M + 1\text{ dB}$ . Initiate transmission. Verify transmission on $f_1$ . Terminate transmission. Repeat 5 times.	$f_1$	Pass

NA - Not applicable

## TEST REPORT

### 4.14.2.2 Least Interfered Channel (LIC) Confirmation, FCC Rule 15.323(c)(5):

EUT utilizing the provision of FCC Rule 15.323(c)(5) must have monitored all access channels defined for its system within the last 10 s and must verify, within the 20 ms (40 ms for EUT designed to use a 20 ms frame period) immediately preceding actual channel access that the detected power of the selected time and spectrum windows is no higher than the previously detected value.

Measurements are made in accordance with ANSI C63.17 sub-clause 7.3.3. This test is performed in section 4.14.2 and 4.15.

Results:

The tests are reported in section 4.14.2 and 4.15.

### 4.14.2.3 Maximum Spectrum Occupancy, FCC Rule 15.323(c)(5):

No EUT or group of co-operating EUTs located within 1 meter of each other shall during any frame period occupy more than 6 MHz of aggregate bandwidth, or alternatively, more than one third of the time and spectrum windows defined by the EUT.

Attestation:

According to the technical description provided, the total number of the time and spectrum windows defined by the system is  $5 \times 12 = 60$ .

During any frame period, the maximum number of time and spectrum windows occupied by the system will be 12, which is less than one third of the time and spectrum windows defined by the system.

**TEST REPORT**

4.15 Monitoring Time, FCC Rule 15.323(c)(1):

Immediately prior to initiating transmission, EUT must monitor the combined time and spectrum windows in which they intend to transmit for a period of at least 10 ms for EUT designed to use a 10 ms or shorter frame period, or at least 20 ms for EUT designed to use a 20 ms frame period.

Measurements are made in accordance with ANSI C63.17 sub-clause 7.3.3. Test setup is shown in section 3.5 Figure 3.5.1. RF signal generators apply uniform CW interference on all system carriers except two carriers (designated  $f_1$  and  $f_2$ ), each at level  $T_L + U_M + 20\text{dB}$ . EUT can only transmit on these two carriers.

Test Descriptions and Results:

I. Base unit

	<b>Test Descriptions</b>	<b>EUT Transmits on</b>	<b>Results</b>
1	Apply interference on $f_1$ at level $T_L + U_M + 20\text{dB}$ , and no interference on $f_2$ . Initiate transmission. Verify transmission on $f_2$ . Then, terminate transmission.	$f_2$	Pass
2	Apply interference on $f_2$ at level $T_L + U_M + 20\text{dB}$ , and remove interference from $f_1$ immediately. Also immediately initiate transmission but is at least 20 ms after interference on $f_2$ is applied. Verify transmission on $f_1$ .	$f_1$	Pass

**TEST REPORT**

4.16 Maximum Transmit Period, FCC Rule 15.323(c)(3):

If no signal above the threshold level is detected, transmission may commence and continue with the same emission bandwidth in the monitored time and spectrum windows without further monitoring. However, occupation of the same combined time and spectrum windows by a EUT or group of co-operating EUTs continuously over a period of time longer than 8 hours is not permitted without repeating the access criteria.

EUT establishes a communication channel with its companion device, which occupies the duplex pair combined time and spectrum windows. Reference RF signal generator synchronized with the sample and then generated a pulse as a time frame reference. The centre frequency of spectrum analyzer was set to the carrier frequency and the SPAN was set to ZERO. The spectrum analyzer was used to monitor the time (reference to the time signal) and spectrum of the communication channel. The occupied time or spectrum of the communication channel shall be changed over a period of time no longer than 8 hours. For a EUT with a frame period of 10/X ms, no more than 2,880,000 X frames should be transmitted without a break.

Test setup is shown as follows:

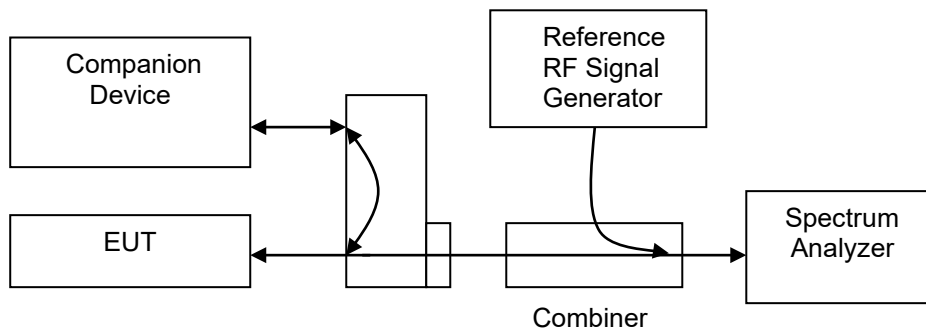

Test Results:

I. Base unit

Measured Maximum Transmission Duration (minutes)	Limit (minutes)	Results
360	480	Pass

**TEST REPORT**

4.17 System Acknowledgement, FCC Rule 15.323(c)(4):

Once access to specific combined time and spectrum windows is obtained an acknowledgment from a system participant must be received by the initiating transmitter within one second or transmission must cease. Periodic acknowledgments must be received at least every 30 seconds or transmission must cease. Channels used exclusively for control and signaling information may transmit continuously for 30 seconds without receiving an acknowledgment, at which time the access criteria must be repeated.

Measurements are made in accordance with ANSI C63.17 sub-clause 8.1.1 and 8.2.1. Test setup is shown in section 3.5 Figure 3.5.1.

Test Results:

I. Base Unit

[ x ] Timing for EUTs using control and signaling channel type transmissions:

Conditions	Transmission Duration (seconds)	Limit (seconds)	Results
Time needed to repeat access criteria	1.28	30	Pass

[ x ] Timing for EUTs using communications channel type transmissions:

Conditions	Transmission Duration (seconds)	Limit (seconds)	Results
Activate EUT w/ companion device off	NA	1	NA
Time needed to cease Traffic Channel	5.1	30	Pass

NA - Not applicable

**TEST REPORT**

4.18 Random Waiting, FCC Rule 15.323(c)(6):

If the selected combined time and spectrum windows are unavailable, the EUT may either monitor and select different windows or seek to use the same windows after waiting an amount of time, randomly chosen from a uniform random distribution between 10 and 150 ms, commencing when the channel becomes available.

Measurements are made in accordance with ANSI C63.17 sub-clause 8.1.2 or 8.1.3. Test setup is shown in section 3.5 Figure 3.5.1.

Test Results:

I. Base unit

[ × ] Random Waiting is not implemented in the EUT:

Conditions	Transmit Channel	Results
Interference applied at operating Channel, $f_1$	$f_2$	Pass

[ ] Random Waiting is implemented in the EUT:

Maximum Time Interval from the End of Interference to the Start of the Control Channel	The Distribution of the Measured Time Intervals	Results
NA	NA	NA

NA - Not applicable

**TEST REPORT**

4.19 Monitoring Bandwidth, FCC Rule 15.323(c)(7).1:

The monitoring bandwidth must be equal to or greater than the emission bandwidth of the intended transmission.

Measurements are made in accordance with ANSI C63.17 sub-clause 7.4. Test setup is shown in section 3.5 Figure 3.5.1.

Attestation:

[ x ] Monitoring bandwidth of the EUT is equal to the occupied bandwidth of the intended transmission. Monitoring is made through the radio receiver used by the EUT for communication. Please refer to the section 2.2 Technical Description for more details. Designed bandwidth refers to section 4.3 Emission Bandwidth.

[ ] Compliance is demonstrated by Monitoring Bandwidth Tests as shown below.

Test Results:

Ia. Simple Compliance Test Results - Base unit

Interference from Carrier	Reaction of EUT	Results
-30% EBW	NA	NA
+30% EBW	NA	NA

Ib. Detailed Compliance Test Results - Base unit

CW Interference from Carrier	Reaction of EUT	Results
+ 6 dB	NA	NA
+ 12 dB	NA	NA
- 6 dB	NA	NA
- 12 dB	NA	NA

- A – Could Transmit
- B – Could not Transmit
- NA – Not applicable

\*Remarks: Detailed Compliance Test was used to show the compliance of the EUT.

**TEST REPORT**

4.20 Maximum Reaction Time, FCC Rule 15.323(c)(7).2:

The monitoring system bandwidth must have a maximum reaction time less than  $50 \times \text{SQRT}(1.25/\text{emission bandwidth } B \text{ in MHz}) \mu\text{s}$  for signals at the applicable threshold level but shall not be required to be less than  $50 \mu\text{s}$ . If a signal is detected that is 6 dB or more above the applicable threshold level, the maximum reaction time shall be  $35 \times \text{SQRT}(1.25/\text{emission bandwidth } B \text{ in MHz}) \mu\text{s}$  but shall not be required to be less than  $35 \mu\text{s}$ .

Measurements are made in accordance with ANSI C63.17 sub-clause 7.5. Test setup is shown in section 3.5 Figure 3.5.1.

Test Results:

	Test	Reaction of EUT	Results
1	Apply Interference Pulse $50\mu\text{s}$ on $f_1$ at pulsed level $T_L + U_m$ , then apply a CW signal on $f_2$ at the level $T_L$	$f_2$	Pass
2	Change Interference Pulse to $35\mu\text{s}$ on $f_1$ at pulsed level $T_L + U_m + 6\text{dB}$ ,	$f_2$	Pass

4.21 Monitoring Antenna, FCC Rule 15.323(c)(8):

The monitoring system shall use the same antenna used for transmission, or an antenna that yields equivalent reception at that location.

- EUT uses the same antenna used for transmission and monitoring that is in compliance meet above provision.
- EUT uses difference antenna used for transmission and monitoring. It must be verified that the monitoring antenna provides coverage equivalent to that of the transmitting antenna. Measurements are made in accordance with ANSI C63.17 sub-clause 4.

**TEST REPORT**

4.22 Duplex Connections, FCC 15.323(c)(10):

An initiating device may attempt to establish a duplex connection by monitoring both its intended transmit (Tx) and receive (Rx) time and spectrum windows. If both the intended transmit and receive time and spectrum windows meet the access criteria, then the initiating device can initiate a transmission in the intended transmit time and spectrum window. If the power detected by the responding device can be decoded as a duplex connection signal from the initiating device, then the responding device may immediately begin transmitting on the receive time and spectrum window monitored by the initiating device.

Attestation:

[ x ] The Handset is the initiating device of the duplex connection

Measurements are made in accordance with ANSI C63.17 sub-clause 8.3. Test setup is shown in section 3.5 Figure 3.5.1.

Test Results:

1a. Base unit

[ ] Dual Access Criteria Check for EUT not implemented the LIC algorithm and do not offer at least 20 duplex communications channels:

Interference	Reaction of EUT	Results
All Tx and Rx Window, except one for Rx Window	NA	NA
All Tx and Rx Window, except one for Tx Window	NA	NA

1b. Base unit

[ x ] Dual Access Criteria Check for EUT implemented the LIC algorithm and offer at least 20 duplex communications channels:

Interference	Reaction of EUT	Results
All Tx windows with level $T_L + U_M$ & Rx windows with level $T_L + U_M + 7\text{dB}$ , except one for Tx window & one for Rx window, which are not duplex.	NA	NA
All Tx windows with level $T_L + U_M + 7\text{dB}$ & Rx windows with level $T_L + U_M$ , except one for Tx window & one for Rx, which are not duplex	NA	NA

- A – Could be connected on the target Rx window and its duplex mate
- B – Could be connected on the target Tx window and its duplex mate
- C – Connected on window which is not the target Tx/Rx window
- D – Could not be connected
  
- NA – Not applicable

## TEST REPORT

### 4.23 Alternative Monitoring Interval for Co-located Device, FCC Rule 15.323(c)(11):

An initiating device that is prevented from monitoring during its intended transmit window due to monitoring system blocking from the transmissions of a co-located (within one meter) transmitter of the same system, may monitor the portions of the time and spectrum windows in which they intend to receive over a period of at least 10 ms. The monitored time and spectrum window must total at least 50 % of the 10 ms frame interval and the monitored spectrum must be within the 1.25 MHz frequency channel(s) already occupied by that device or co-located co-operating devices. If the access criteria is met for the intended receive time and spectrum window under the above conditions, then transmission in the intended transmit window by the initiating device may commence.

Measurements are made in accordance with ANSI C63.17 sub-clause 8.4.

Attestation:

- [ ] Appropriate as it is co-located device, in which the monitoring system will be blocked from the transmissions of a co-located (Within one meter) transmitter of the same system. Please refer to attachment, 15.323(c)(11).pdf , for details.
- [ x ] Not appropriate, as the system always monitor both the transmit and receive time/spectrum windows, it is not a co-located device.

### 4.24 Fair Access, FCC Rule 15.323(c)(12):

The provisions of FCC Rule 15.323(c)(10) or (c)(11) shall not be used to extend the range of spectrum occupied over space or time for the purpose of denying fair access to spectrum to other devices.

Attestation:

The manufacturer declares that the device does not use any mechanisms as provided by Part 15.323(c)(10) or (c)(11) to extend the range of spectrum occupied over space or time for the purpose of denying fair access to spectrum to other devices.

Please refer to the declaration letter which is saved with filename: declaration.pdf.

**TEST REPORT**

**5.0 EQUIPMENT LIST**

1) Radiated Emissions Test

Equipment	EMI Test Receiver	Spectrum Analyzer	BiConiLog Antenna (30MHz - 6GHz)
Registration No.	EW-3156	EW-3281	EW-3408
Manufacturer	ROHDESCHWARZ	R&S	EMCO
Model No.	ESR26	FSP40	
Calibration Date	September 30, 2020	March 04, 2020	October 25, 2020
Calibration Due Date	September 30, 2021	March 04, 2021	October 25, 2021

Equipment	14m Double Shield RF Cable (20MHz - 6GHz)	High Frequency Coaxial Cable Assembly (4 pcs)	Double Ridged Guide Antenna
Registration No.	EW-2074	EW-2107	EW-0194
Manufacturer	RADIALL	RADIALL	EMCO
Model No.		SMA(m)-SHF5MPU- SMA(m) R.A 14m	3115
Calibration Date	August 29, 2020	July 03, 2020	September 26, 2019
Calibration Due Date	August 29, 2021	July 03, 2021	March 26, 2021

2) Conducted Emissions Test

Equipment	EMI Test Receiver	RF Cable 80cm (RG142) (9kHz to 30MHz)	LISN
Registration No.	EW-3156	EW-2452	EW-2501
Manufacturer	ROHDESCHWARZ	RADIALL	R&S
Model No.	ESR26	bnc m st / 142 / bnc m st 80cm	ENV-216
Calibration Date	September 30, 2020	November 10, 2020	September 11, 2020
Calibration Due Date	September 30, 2021	November 10, 2021	September 11, 2021

## TEST REPORT

### 3) Conductive Measurement Test

Equipment	Coaxial Directional Coupler	Spectrum Analyzer	Digital Radiocommunication Tester for DECT
Registration No.	EW-2337	EW-3281	EW-1739
Manufacturer	MAGNA	R&S	ROHDESCHWARZ
Model No.	4222-16	FSP40	CMD60
Calibration Date	Nil*	March 04, 2020	June 17, 2020
Calibration Due Date	Nil*	March 04, 2021	June 17, 2021

Equipment	Vector Signal Generator	Temperature & Humidity Chamber	Digital Multimeter
Registration No.	EW-3457	EW-2134	EW-0519
Manufacturer	R&S	GIANT FORCE	FLUKE
Model No.	SMBV100B	GTH-750-40-CP-SD	77-3
Calibration Date	February 25, 2020	September 18, 2019	February 26, 2020
Calibration Due Date	May 25, 2021	September 18, 2021	August 15, 2021

**END OF TEST REPORT**