

# FCC SAR TEST REPORT

**Application No:** ZR/2019/20007  
**Applicant:** VTech Telecommunications Ltd.  
**Manufacturer:** VTech Telecommunications Ltd.  
**Factory:** VTech (Dongguan) Telecommunications Limited.  
**Product Name:** Video Monitor  
**Model No.(EUT):** VM320 PU, VM320-2 PU, VM320-ab PU  
**Trade Mark:** VTech  
**FCC ID:** EW780-1384-01  
**Standards:** FCC 47CFR §2.1093  
**Date of Receipt:** 2019-03-04  
**Date of Test:** 2019-04-28 to 2019-04-28  
**Date of Issue:** 2019-05-16  
**Test Result:** **PASS \***

\* In the configuration tested, the EUT detailed in this report complied with the standards specified above.

Authorized Signature:

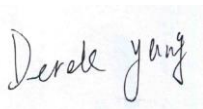

Derek Yang

Wireless Laboratory Manager





## REVISION HISTORY

Revision Record				
Version	Chapter	Date	Modifier	Remark
01		2019-05-16		Original



Unless otherwise agreed in writing, this document is issued by the Company subject to its General Conditions of Service printed overleaf, available on request or accessible at <http://www.sgs.com/en/Terms-and-Conditions.aspx> and, for electronic format documents, subject to Terms and Conditions for Electronic Documents at <http://www.sgs.com/en/Terms-and-Conditions/Terms-e-Documents.aspx>. Attention is drawn to the limitation of liability, indemnification and jurisdiction issues defined therein. Any holder of this document is advised that information contained hereon reflects the Company's findings at the time of its intervention only and within the limits of Client's instructions, if any. The Company's sole responsibility is to its Client and this document does not exonerate parties to a transaction from exercising all their rights and obligations under the transaction documents. This document cannot be reproduced except in full, without prior written approval of the Company. Any unauthorized alteration, forgery or falsification of the content or appearance of this document is unlawful and offenders may be prosecuted to the fullest extent of the law. Unless otherwise stated the results shown in this test report refer only to the sample(s) tested and such sample(s) are retained for 30 days only.  
**Attention: To check the authenticity of testing /inspection report & certificate, please contact us at telephone: (86-755) 8307 1443, or email: CN.Doccheck@sgs.com**

## TEST SUMMARY

Frequency Band	Test position	Test mode	Max Report SAR1-g (W/kg)	SAR limit (W/kg)	Verdict
2.4G (user-defined)	Body	FSK	<b>0.29</b>	1.6	PASS

**Approved & Released by**

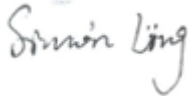

Simon Ling

SAR Manager

**Tested by**



Jackson Li

SAR Engineer



## CONTENTS

<b>1</b>	<b>GENERAL INFORMATION</b> .....	<b>6</b>
1.1	DETAILS OF CLIENT .....	6
1.2	TEST LOCATION .....	6
1.3	TEST FACILITY .....	7
1.4	GENERAL DESCRIPTION OF EUT .....	8
1.5	TEST SPECIFICATION .....	9
1.6	RF EXPOSURE LIMITS.....	9
<b>2</b>	<b>SAR MEASUREMENTS SYSTEM CONFIGURATION</b> .....	<b>10</b>
2.1	THE SAR MEASUREMENT SYSTEM.....	10
2.2	ISOTROPIC E-FIELD PROBE EX3DV4 .....	11
2.3	DATA ACQUISITION ELECTRONICS (DAE).....	12
2.4	SAM TWIN PHANTOM .....	12
2.5	ELI PHANTOM.....	13
2.6	DEVICE HOLDER FOR TRANSMITTERS.....	14
2.7	MEASUREMENT PROCEDURE.....	15
2.7.1	Scanning procedure.....	15
2.7.2	Data Storage.....	17
2.7.3	Data Evaluation by SEMCAD.....	17
<b>3</b>	<b>DESCRIPTION OF TEST POSITION</b> .....	<b>19</b>
3.1	THE BODY TEST POSITION.....	19
<b>4</b>	<b>SAR SYSTEM VERIFICATION PROCEDURE</b> .....	<b>20</b>
4.1	TISSUE SIMULATE LIQUID .....	20
4.1.1	Recipes for Tissue Simulate Liquid.....	20
4.1.2	Measurement for Tissue Simulate Liquid.....	21
4.2	SAR SYSTEM CHECK .....	22
4.2.1	Justification for Extended SAR Dipole Calibrations.....	23
4.2.2	Summary System Check Result(s).....	23
4.2.3	Detailed System Check Results.....	23
<b>5</b>	<b>TEST RESULTS AND MEASUREMENT DATA</b> .....	<b>24</b>



Unless otherwise agreed in writing, this document is issued by the Company subject to its General Conditions of Service printed overleaf, available on request or accessible at <http://www.sgs.com/en/Terms-and-Conditions.aspx> and, for electronic format documents, subject to Terms and Conditions for Electronic Documents at <http://www.sgs.com/en/Terms-and-Conditions/Terms-e-Documents.aspx>. Attention is drawn to the limitation of liability, indemnification and jurisdiction issues defined therein. Any holder of this document is advised that information contained hereon reflects the Company's findings at the time of its intervention only and within the limits of Client's instructions, if any. The Company's sole responsibility is to its Client and this document does not exonerate parties to a transaction from exercising all their rights and obligations under the transaction documents. This document cannot be reproduced except in full, without prior written approval of the Company. Any unauthorized alteration, forgery or falsification of the content or appearance of this document is unlawful and offenders may be prosecuted to the fullest extent of the law. Unless otherwise stated the results shown in this test report refer only to the sample(s) tested and such sample(s) are retained for 30 days only.  
**Attention: To check the authenticity of testing /inspection report & certificate, please contact us at telephone: (86-755) 8307 1443, or email: CN.Doccheck@sgs.com**

<b>5.1</b>	<b>OPERATION CONFIGURATIONS</b> .....	<b>24</b>
5.1.1	Operation Configuration .....	24
5.1.2	DUT Antenna Locations ( Front View ) .....	25
5.1.3	EUT side for SAR Testing .....	26
<b>5.2</b>	<b>MEASUREMENT OF RF CONDUCTED POWER</b> .....	<b>27</b>
5.2.1	Conducted Power of 2.4G(user-defined) .....	27
<b>5.3</b>	<b>MEASUREMENT OF SAR DATA</b> .....	<b>28</b>
5.3.1	SAR Result of 2.4G(user-defined).....	28
<b>6</b>	<b>EQUIPMENT LIST</b> .....	<b>29</b>
<b>7</b>	<b>MEASUREMENT UNCERTAINTY</b> .....	<b>30</b>
<b>8</b>	<b>CALIBRATION CERTIFICATE</b> .....	<b>30</b>
<b>9</b>	<b>PHOTOGRAPHS</b> .....	<b>30</b>
<b>APPENDIX A: DETAILED SYSTEM CHECK RESULTS</b> .....		<b>31</b>
<b>APPENDIX B: DETAILED TEST RESULTS</b> .....		<b>31</b>
<b>APPENDIX C: CALIBRATION CERTIFICATE</b> .....		<b>31</b>
<b>APPENDIX D: PHOTOGRAPHS</b> .....		<b>31</b>



Unless otherwise agreed in writing, this document is issued by the Company subject to its General Conditions of Service printed overleaf, available on request or accessible at <http://www.sgs.com/en/Terms-and-Conditions.aspx> and, for electronic format documents, subject to Terms and Conditions for Electronic Documents at <http://www.sgs.com/en/Terms-and-Conditions/Terms-e-Documents.aspx>. Attention is drawn to the limitation of liability, indemnification and jurisdiction issues defined therein. Any holder of this document is advised that information contained hereon reflects the Company's findings at the time of its intervention only and within the limits of Client's instructions, if any. The Company's sole responsibility is to its Client and this document does not exonerate parties to a transaction from exercising all their rights and obligations under the transaction documents. This document cannot be reproduced except in full, without prior written approval of the Company. Any unauthorized alteration, forgery or falsification of the content or appearance of this document is unlawful and offenders may be prosecuted to the fullest extent of the law. Unless otherwise stated the results shown in this test report refer only to the sample(s) tested and such sample(s) are retained for 30 days only.  
**Attention: To check the authenticity of testing /inspection report & certificate, please contact us at telephone: (86-755) 8307 1443, or email: CN.Doccheck@sgs.com**

# 1 General Information

## 1.1 Details of Client

Applicant:	VTech Telecommunications Ltd.
Address:	23/F, Tai Ping Industrial Centre, Block 1,57 Ting Kok Road, Tai Po, Hong Kong
Manufacturer:	VTech Telecommunications Ltd.
Address:	23/F, Tai Ping Industrial Centre, Block 1,57 Ting Kok Road, Tai Po, Hong Kong
Factory:	VTech (Dongguan) Telecommunications Limited.
Address:	VTech Science Park, Xia Ling Bei Management Zone, Liaobu, Dongguan, Guangdong, China.

## 1.2 Test Location

Company: SGS-CSTC Standards Technical Services Co., Ltd. Shenzhen Branch E&E Lab  
 Address: No. 1 Workshop, M-10, Middle section, Science & Technology Park, Shenzhen, Guangdong, China  
 Post code: 518057  
 Telephone: +86 (0) 755 2601 2053  
 Fax: +86 (0) 755 2671 0594  
 E-mail: ee.shenzhen@sgs.com



Unless otherwise agreed in writing, this document is issued by the Company subject to its General Conditions of Service printed overleaf, available on request or accessible at <http://www.sgs.com/en/Terms-and-Conditions.aspx> and, for electronic format documents, subject to Terms and Conditions for Electronic Documents at <http://www.sgs.com/en/Terms-and-Conditions/Terms-e-Documents.aspx>. Attention is drawn to the limitation of liability, indemnification and jurisdiction issues defined therein. Any holder of this document is advised that information contained hereon reflects the Company's findings at the time of its intervention only and within the limits of Client's instructions, if any. The Company's sole responsibility is to its Client and this document does not exonerate parties to a transaction from exercising all their rights and obligations under the transaction documents. This document cannot be reproduced except in full, without prior written approval of the Company. Any unauthorized alteration, forgery or falsification of the content or appearance of this document is unlawful and offenders may be prosecuted to the fullest extent of the law. Unless otherwise stated the results shown in this test report refer only to the sample(s) tested and such sample(s) are retained for 30 days only.  
**Attention: To check the authenticity of testing /inspection report & certificate, please contact us at telephone: (86-755) 8307 1443, or email: [CN.Doccheck@sgs.com](mailto:CN.Doccheck@sgs.com)**

### 1.3 Test Facility

The test facility is recognized, certified, or accredited by the following organizations:

• **CNAS (No. CNAS L2929)**

CNAS has accredited SGS-CSTC Standards Technical Services Co., Ltd. Shenzhen Branch EMC Lab to ISO/IEC 17025:2005 General Requirements for the Competence of Testing and Calibration Laboratories (CNAS-CL01 Accreditation Criteria for the Competence of Testing and Calibration Laboratories) for the competence in the field of testing.

• **A2LA (Certificate No. 3816.01)**

SGS-CSTC Standards Technical Services Co., Ltd., Shenzhen EMC Laboratory is accredited by the American Association for Laboratory Accreditation (A2LA). Certificate No. 3816.01.

• **VCCI**

The 10m Semi-anechoic chamber and Shielded Room of SGS-CSTC Standards Technical Services Co., Ltd. have been registered in accordance with the Regulations for Voluntary Control Measures with Registration No.: G-823, R-4188, T-1153 and C-2383 respectively.

• **FCC –Designation Number: CN1178**

SGS-CSTC Standards Technical Services Co., Ltd., Shenzhen EMC Laboratory has been recognized as an accredited testing laboratory.

Designation Number: CN1178. Test Firm Registration Number: 406779.

• **Industry Canada (IC)**

Two 3m Semi-anechoic chambers and the 10m Semi-anechoic chamber of SGS-CSTC Standards Technical Services Co., Ltd. Shenzhen Branch EMC Lab have been registered by Certification and Engineering Bureau of Industry Canada for radio equipment testing with Registration No.: 4620C-1, 4620C-2, 4620C-3.



Unless otherwise agreed in writing, this document is issued by the Company subject to its General Conditions of Service printed overleaf, available on request or accessible at <http://www.sgs.com/en/Terms-and-Conditions.aspx> and, for electronic format documents, subject to Terms and Conditions for Electronic Documents at <http://www.sgs.com/en/Terms-and-Conditions/Terms-e-Documents.aspx>. Attention is drawn to the limitation of liability, indemnification and jurisdiction issues defined therein. Any holder of this document is advised that information contained hereon reflects the Company's findings at the time of its intervention only and within the limits of Client's instructions, if any. The Company's sole responsibility is to its Client and this document does not exonerate parties to a transaction from exercising all their rights and obligations under the transaction documents. This document cannot be reproduced except in full, without prior written approval of the Company. Any unauthorized alteration, forgery or falsification of the content or appearance of this document is unlawful and offenders may be prosecuted to the fullest extent of the law. Unless otherwise stated the results shown in this test report refer only to the sample(s) tested and such sample(s) are retained for 30 days only.  
**Attention: To check the authenticity of testing /inspection report & certificate, please contact us at telephone: (86-755) 8307 1443, or email: CN.Doccheck@sgs.com**

## 1.4 General Description of EUT

Product Name:	Video Monitor		
Model No.(EUT):	VM320 PU, VM320-2 PU, VM320-ab PU		
Trade Mark:	VTech		
Product Phase:	production unit		
Device Type :	portable device		
Exposure Category:	uncontrolled environment / general population		
FCC ID:	EW780-1384-01		
Hardware Version:	35-201154PU		
Software Version:	V1430		
Antenna Type:	Integral Antenna		
<b>Device Operating Configurations :</b>			
Modulation Mode:	<b>2.4G(user-defined):</b> FSK;		
Frequency Bands:	Band	Tx (MHz)	Rx (MHz)
	2.4G(user-defined)	2405-2475	2405-2475
Battery Information:	Model No.:	GP80AAAHC3BMXZ	
	Normal Voltage :	3.6V	
	Rated capacity :	800mAh	
	Manufacturer:	GPI International LTD.	

### Remark:

Model No.: VM320 PU, VM320-2 PU, VM320-ab PU.

Only the model VM320 PU was tested, since the electrical circuit design, layout, components used, internal wiring and functions were identical for the above models, with only differences on model No.



## 1.5 Test Specification

Identity	Document Title
FCC 47CFR §2.1093	Radiofrequency Radiation Exposure Evaluation: Portable Devices
ANSI/IEEE Std C95.1 – 1992	IEEE Standard for Safety Levels with Respect to Human Exposure to Radio Frequency Electromagnetic Fields, 3 kHz – 300 GHz.
IEEE 1528-2013	Recommended Practice for Determining the Peak Spatial-Average Specific Absorption Rate (SAR) in the Human Head from Wireless Communications Devices: Measurement Techniques
KDB447498 D01 v06	General RF Exposure Guidance
KDB447498 D03 v01	Supplement C Cross-Reference
KDB 865664 D01 v01r04	SAR Measurement 100 MHz to 6 GHz
KDB 865664 D02 v01r02	RF Exposure Reporting

## 1.6 RF exposure limits

Human Exposure	Uncontrolled Environment General Population	Controlled Environment Occupational
<b>Spatial Peak SAR*</b> (Brain*Trunk)	<b>1.60 W/Kg</b>	8.00 W/Kg
<b>Spatial Average SAR**</b> (Whole Body)	0.08 W/Kg	0.40 W/Kg
<b>Spatial Peak SAR***</b> (Hands/Feet/Ankle/Wrist)	4.00 W/Kg	20.00 W/Kg

### Notes:

\* The Spatial Peak value of the SAR averaged over any 1 gram of tissue (defined as a tissue volume in the shape of a cube) and over the appropriate averaging time

\*\* The Spatial Average value of the SAR averaged over the whole body.

\*\*\* The Spatial Peak value of the SAR averaged over any 10 grams of tissue (defined as a tissue volume in the shape of a cube) and over the appropriate averaging time.

**Uncontrolled Environments** are defined as locations where there is the exposure of individuals who have no knowledge or control of their exposure.

**Controlled Environments** are defined as locations where there is exposure that may be incurred by persons who are aware of the potential for exposure, (i.e. as a result of employment or occupation.)



## 2 SAR Measurements System Configuration

### 2.1 The SAR Measurement System

This SAR Measurement System uses a Computer-controlled 3-D stepper motor system (SPEAG DASY5 professional system). A E-field probe is used to determine the internal electric fields. The SAR can be obtained from the equation  $SAR = \sigma (|E|^2) / \rho$  where  $\sigma$  and  $\rho$  are the conductivity and mass density of the tissue-Simulate.

The DASY5 system for performing compliance tests consists of the following items:

A standard high precision 6-axis robot (Stabile RX family) with controller, teach pendant and software .An arm extension for accommodation the data acquisition electronics (DAE).

A dosimetric probe, i.e., an isotropic E-field probe optimized and calibrated for usage in tissue simulating liquid. The probe is equipped with an optical surface detector system.

A data acquisition electronics (DAE) which performs the signal amplification, signal multiplexing, AD-conversion, offset measurements, mechanical surface detection, collision detection, etc. The unit is battery powered with standard or rechargeable batteries. The signal is optically transmitted to the EOC.

The Electro-optical converter (EOC) performs the conversion between optical and electrical of the signals for the digital communication to DAE and for the analog signal from the optical surface detection. The EOC is connected to the measurement server.

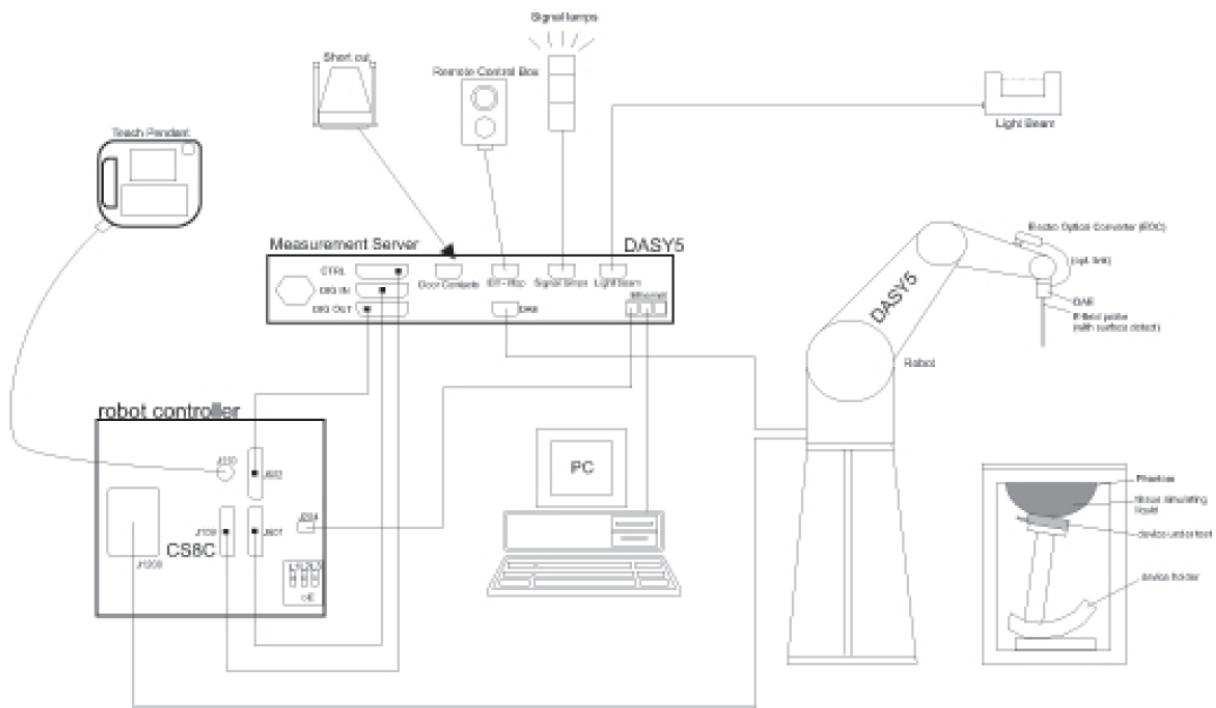

F-1. SAR Measurement System Configuration

- The function of the measurement server is to perform the time critical tasks such as signal filtering, control of the robot operation and fast movement interrupts.
- A probe alignment unit which improves the (absolute) accuracy of the probe positioning.
- A computer operating Windows 7.
- DASY5 software.
- Remote control with teach pendant and additional circuitry for robot safety such as warning lamps, etc.
- The SAM twin phantom enabling testing left-hand, right-hand and Body Worn usage.
- The device holder for handheld mobile phones.
- Tissue simulating liquid mixed according to the given recipes.
- Validation dipole kits allowing to validating the proper functioning of the system.

## 2.2 Isotropic E-field Probe EX3DV4

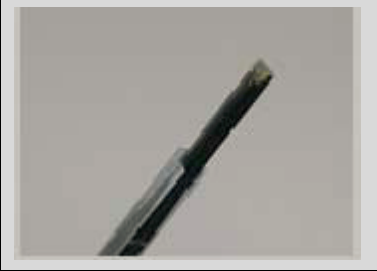
	<p>Symmetrical design with triangular core          Built-in shielding against static charges          PEEK enclosure material (resistant to organic solvents, e.g., DGBE)</p>
<p><b>Calibration</b></p>	<p>ISO/IEC 17025 <a href="#">calibration service</a> available.</p>
<p><b>Frequency</b></p>	<p>10 MHz to &gt; 6 GHz          Linearity: <math>\pm 0.2</math> dB (30 MHz to 6 GHz)</p>
<p><b>Directivity</b></p>	<p><math>\pm 0.3</math> dB in TSL (rotation around probe axis)  <math>\pm 0.5</math> dB in TSL (rotation normal to probe axis)</p>
<p><b>Dynamic Range</b></p>	<p>10 <math>\mu</math>W/g to &gt; 100 mW/g          Linearity: <math>\pm 0.2</math> dB (noise: typically &lt; 1 <math>\mu</math>W/g)</p>
<p><b>Dimensions</b></p>	<p>Overall length: 337 mm (Tip: 20 mm)          Tip diameter: 2.5 mm (Body: 12 mm)          Typical distance from probe tip to dipole centers: 1 mm</p>
<p><b>Application</b></p>	<p>High precision dosimetric measurements in any exposure scenario (e.g., very strong gradient fields); the only probe that enables compliance testing for frequencies up to 6 GHz with precision of better 30%.</p>
<p><b>Compatibility</b></p>	<p>DASY3, DASY4, DASY52 SAR and higher, EASY4/MRI</p>



Unless otherwise agreed in writing, this document is issued by the Company subject to its General Conditions of Service printed overleaf, available on request or accessible at <http://www.sgs.com/en/Terms-and-Conditions.aspx> and, for electronic format documents, subject to Terms and Conditions for Electronic Documents at <http://www.sgs.com/en/Terms-and-Conditions/Terms-e-Documents.aspx>. Attention is drawn to the limitation of liability, indemnification and jurisdiction issues defined therein. Any holder of this document is advised that information contained hereon reflects the Company's findings at the time of its intervention only and within the limits of Client's instructions, if any. The Company's sole responsibility is to its Client and this document does not exonerate parties to a transaction from exercising all their rights and obligations under the transaction documents. This document cannot be reproduced except in full, without prior written approval of the Company. Any unauthorized alteration, forgery or falsification of the content or appearance of this document is unlawful and offenders may be prosecuted to the fullest extent of the law. Unless otherwise stated the results shown in this test report refer only to the sample(s) tested and such sample(s) are retained for 30 days only.  
**Attention: To check the authenticity of testing /inspection report & certificate, please contact us at telephone: (86-755) 8307 1443, or email: [CN.Doccheck@sgs.com](mailto:CN.Doccheck@sgs.com)**

### 2.3 Data Acquisition Electronics (DAE)

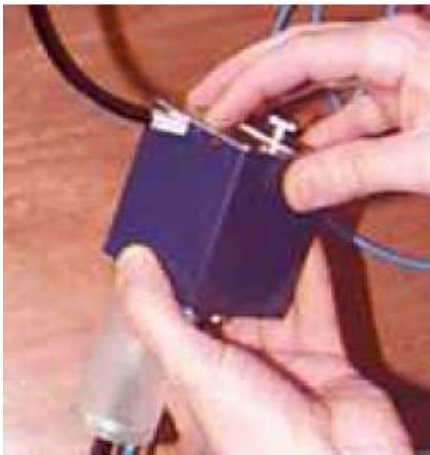
<b>Model</b>	DAE	
<b>Construction</b>	Signal amplifier, multiplexer, A/D converter and control logic. Serial optical link for communication with DASY4/5 embedded system (fully remote controlled). Two step probe touch detector for mechanical surface detection and emergency robot stop.	
<b>Measurement Range</b>	-100 to +300 mV (16 bit resolution and two range settings: 4mV,400mV)	
<b>Input Offset Voltage</b>	< 5μV (with auto zero)	
<b>Input Bias Current</b>	< 50 f A	
<b>Dimensions</b>	60 x 60 x 68 mm	

### 2.4 SAM Twin Phantom

<b>Material</b>	Vinylester, glass fiber reinforced (VE-GF)	
<b>Liquid Compatibility</b>	Compatible with all SPEAG tissue simulating liquids (incl. DGBE type)	
<b>Shell Thickness</b>	2 ± 0.2 mm (6 ± 0.2 mm at ear point)	
<b>Dimensions (incl. Wooden Support)</b>	Length: 1000 mm Width: 500 mm Height: adjustable feet	
<b>Filling Volume</b>	approx. 25 liters	
<b>Wooden Support</b>	SPEAG standard phantom table	

The shell corresponds to the specifications of the Specific Anthropomorphic Mannequin (SAM) phantom defined in IEEE 1528 and IEC 62209-1. It enables the dosimetric evaluation of left and right hand phone usage as well as body mounted usage at the flat phantom region. A cover prevents evaporation of the liquid. Reference markings on the phantom allow the complete setup of all predefined phantom positions and measurement grids by teaching three points with the robot.

Twin SAM V5.0 has the same shell geometry and is manufactured from the same material as Twin SAM V4.0, but has reinforced top structure.

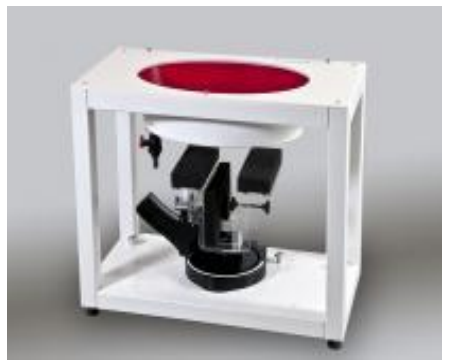

## 2.5 ELI Phantom

<b>Material</b>	Vinylester, glass fiber reinforced (VE-GF)	
<b>Liquid Compatibility</b>	Compatible with all SPEAG tissue simulating liquids (incl. DGBE type)	
<b>Shell Thickness</b>	2.0 ± 0.2 mm (bottom plate)	
<b>Dimensions</b>	Major axis: 600 mm Minor axis: 400 mm	
<b>Filling Volume</b>	approx. 30 liters	
<b>Wooden Support</b>	SPEAG standard phantom table	

Phantom for compliance testing of handheld and body-mounted wireless devices in the frequency range of 30 MHz to 6 GHz. ELI is fully compatible with the IEC 62209-2 standard and all known tissue simulating liquids. ELI has been optimized regarding its performance and can be integrated into our standard phantom tables. A cover prevents evaporation of the liquid. Reference markings on the phantom allow installation of the complete setup, including all predefined phantom positions and measurement grids, by teaching three points. The phantom is compatible with all SPEAG dosimetric probes and dipoles.

ELI V5.0 has the same shell geometry and is manufactured from the same material as ELI4, but has reinforced top structure.



Unless otherwise agreed in writing, this document is issued by the Company subject to its General Conditions of Service printed overleaf, available on request or accessible at <http://www.sgs.com/en/Terms-and-Conditions.aspx> and, for electronic format documents, subject to Terms and Conditions for Electronic Documents at <http://www.sgs.com/en/Terms-and-Conditions/Terms-e-Documents.aspx>. Attention is drawn to the limitation of liability, indemnification and jurisdiction issues defined therein. Any holder of this document is advised that information contained hereon reflects the Company's findings at the time of its intervention only and within the limits of Client's instructions, if any. The Company's sole responsibility is to its Client and this document does not exonerate parties to a transaction from exercising all their rights and obligations under the transaction documents. This document cannot be reproduced except in full, without prior written approval of the Company. Any unauthorized alteration, forgery or falsification of the content or appearance of this document is unlawful and offenders may be prosecuted to the fullest extent of the law. Unless otherwise stated the results shown in this test report refer only to the sample(s) tested and such sample(s) are retained for 30 days only.  
**Attention: To check the authenticity of testing /inspection report & certificate, please contact us at telephone: (86-755) 8307 1443, or email: [CN.Doccheck@sgs.com](mailto:CN.Doccheck@sgs.com)**

## 2.6 Device Holder for Transmitters



F-2. Device Holder for Transmitters

- The DASY device holder is designed to cope with different positions given in the standard. It has two scales for the device rotation (with respect to the body axis) and the device inclination (with respect to the line between the ear reference points). The rotation centres for both scales are the ear reference point (ERP). Thus the device needs no repositioning when changing the angles.
- The DASY device holder has been made out of low-loss POM material having the following dielectric parameters: relative permittivity  $\epsilon=3$  and loss tangent  $\delta=0.02$ . The amount of dielectric material has been reduced in the closest vicinity of the device, since measurements have suggested that the influence of the clamp on the test results could thus be lowered.



## 2.7 Measurement procedure

### 2.7.1 Scanning procedure

#### Step 1: Power reference measurement

The “reference” and “drift” measurements are located at the beginning and end of the batch process. They measure the field drift at one single point in the liquid over the complete procedure.

#### Step 2: Area scan

The SAR distribution at the exposed side of the head was measured at a distance of 4mm from the inner surface of the shell. The area covered the entire dimension of the head and the horizontal grid spacing was 15mm\*15mm or 12mm\*12mm or 10mm\*10mm. Based on the area scan data, the area of the maximum absorption was determined by spline interpolation.

#### Step 3: Zoom scan

Around this point, a volume of 30mm\*30mm\*30mm (fine resolution volume scan, zoom scan) was assessed by measuring 5x5x7 points ( $\leq 2\text{GHz}$ ) and 7x7x7 points ( $\geq 2\text{GHz}$ ). On this basis of this data set, the spatial peak SAR value was evaluated with the following procedure:

The data at the surface was extrapolated, since the centre of the dipoles is 2.0mm away from the tip of the probe and the distance between the surface and the lowest measuring point is 1.2mm. (This can be variable. Refer to the probe specification). The extrapolation was based on a least square algorithm. A polynomial of the fourth order was calculated through the points in z-axes. This polynomial was then used to evaluate the points between the surface and the probe tip. The maximum interpolated value was searched with a straight-forward algorithm. Around this maximum the SAR values averaged over the spatial volumes (1g or 10g) were computed using the 3D-Spline interpolation algorithm. The volume was integrated with the trapezoidal algorithm. One thousand points were interpolated to calculate the average. All neighbouring volumes were evaluated until no neighboring volume with a higher average value was found.

The area and zoom scan resolutions specified in the table below must be applied to the SAR measurements. Probe boundary effect error compensation is required for measurements with the probe tip closer than half a probe tip diameter to the phantom surface. Both the probe tip diameter and sensor offset distance must satisfy measurement protocols; to ensure probe boundary effect errors are minimized and the higher fields closest to the phantom surface can be correctly measured and extrapolated to the phantom surface for computing 1-g SAR. Tolerances of the post-processing algorithms must be verified by the test laboratory for the scan resolutions used in the SAR measurements, according to the reference distribution functions specified in IEEE Std. 1528-2013.



Unless otherwise agreed in writing, this document is issued by the Company subject to its General Conditions of Service printed overleaf, available on request or accessible at <http://www.sgs.com/en/Terms-and-Conditions.aspx> and, for electronic format documents, subject to Terms and Conditions for Electronic Documents at <http://www.sgs.com/en/Terms-and-Conditions/Terms-e-Documents.aspx>. Attention is drawn to the limitation of liability, indemnification and jurisdiction issues defined therein. Any holder of this document is advised that information contained hereon reflects the Company's findings at the time of its intervention only and within the limits of Client's instructions, if any. The Company's sole responsibility is to its Client and this document does not exonerate parties to a transaction from exercising all their rights and obligations under the transaction documents. This document cannot be reproduced except in full, without prior written approval of the Company. Any unauthorized alteration, forgery or falsification of the content or appearance of this document is unlawful and offenders may be prosecuted to the fullest extent of the law. Unless otherwise stated the results shown in this test report refer only to the sample(s) tested and such sample(s) are retained for 30 days only.  
**Attention: To check the authenticity of testing /inspection report & certificate, please contact us at telephone: (86-755) 8307 1443, or email: CN.Doccheck@sgs.com**

		$\leq 3$ GHz	$> 3$ GHz
Maximum distance from closest measurement point (geometric center of probe sensors) to phantom surface		$5 \pm 1$ mm	$\frac{1}{2} \cdot \delta \cdot \ln(2) \pm 0.5$ mm
Maximum probe angle from probe axis to phantom surface normal at the measurement location		$30^\circ \pm 1^\circ$	$20^\circ \pm 1^\circ$
Maximum area scan spatial resolution: $\Delta x_{Area}$ , $\Delta y_{Area}$		$\leq 2$ GHz: $\leq 15$ mm 2 – 3 GHz: $\leq 12$ mm	3 – 4 GHz: $\leq 12$ mm 4 – 6 GHz: $\leq 10$ mm
		When the x or y dimension of the test device, in the measurement plane orientation, is smaller than the above, the measurement resolution must be $\leq$ the corresponding x or y dimension of the test device with at least one measurement point on the test device.	
Maximum zoom scan spatial resolution: $\Delta x_{Zoom}$ , $\Delta y_{Zoom}$		$\leq 2$ GHz: $\leq 8$ mm 2 – 3 GHz: $\leq 5$ mm*	3 – 4 GHz: $\leq 5$ mm* 4 – 6 GHz: $\leq 4$ mm*
Maximum zoom scan spatial resolution, normal to phantom surface	uniform grid: $\Delta z_{Zoom}(n)$	$\leq 5$ mm	3 – 4 GHz: $\leq 4$ mm 4 – 5 GHz: $\leq 3$ mm 5 – 6 GHz: $\leq 2$ mm
	graded grid	$\Delta z_{Zoom}(1)$ : between 1 <sup>st</sup> two points closest to phantom surface	$\leq 4$ mm
		$\Delta z_{Zoom}(n>1)$ : between subsequent points	$\leq 1.5 \cdot \Delta z_{Zoom}(n-1)$
Minimum zoom scan volume	x, y, z	$\geq 30$ mm	3 – 4 GHz: $\geq 28$ mm 4 – 5 GHz: $\geq 25$ mm 5 – 6 GHz: $\geq 22$ mm
<p>Note: <math>\delta</math> is the penetration depth of a plane-wave at normal incidence to the tissue medium; see draft standard IEEE P1528-2011 for details.</p> <p>* When zoom scan is required and the <i>reported</i> SAR from the <i>area scan based 1-g SAR estimation</i> procedures of KDB 447498 is <math>\leq 1.4</math> W/kg, <math>\leq 8</math> mm, <math>\leq 7</math> mm and <math>\leq 5</math> mm zoom scan resolution may be applied, respectively, for 2 GHz to 3 GHz, 3 GHz to 4 GHz and 4 GHz to 6 GHz.</p>			

#### Step 4: Power reference measurement (drift)

The Power Drift Measurement job measures the field at the same location as the most recent power reference measurement job within the same procedure, and with the same settings. The indicated drift is mainly the variation of the DUT's output power and should vary max.  $\pm 5\%$



Unless otherwise agreed in writing, this document is issued by the Company subject to its General Conditions of Service printed overleaf, available on request or accessible at <http://www.sgs.com/en/Terms-and-Conditions.aspx> and, for electronic format documents, subject to Terms and Conditions for Electronic Documents at <http://www.sgs.com/en/Terms-and-Conditions/Terms-e-Documents.aspx>. Attention is drawn to the limitation of liability, indemnification and jurisdiction issues defined therein. Any holder of this document is advised that information contained hereon reflects the Company's findings at the time of its intervention only and within the limits of Client's instructions, if any. The Company's sole responsibility is to its Client and this document does not exonerate parties to a transaction from exercising all their rights and obligations under the transaction documents. This document cannot be reproduced except in full, without prior written approval of the Company. Any unauthorized alteration, forgery or falsification of the content or appearance of this document is unlawful and offenders may be prosecuted to the fullest extent of the law. Unless otherwise stated the results shown in this test report refer only to the sample(s) tested and such sample(s) are retained for 30 days only.  
**Attention: To check the authenticity of testing /inspection report & certificate, please contact us at telephone: (86-755) 8307 1443, or email: CN.Doccheck@sgs.com**

SGS-CSTC Standards Technical Services Co., Ltd.  
 Shenzhen Branch, Technology Park, Middle Section, Science & Technology Park, Shenzhen, China

No.1 Workshop, M-10, Middle Section, Science & Technology Park, Shenzhen, China 518057 t (86-755) 26012053 f (86-755) 26710594 www.sgs.com  
 中国·深圳·科技园中区M-10栋一号厂房 邮编: 518057 t (86-755) 26012053 f (86-755) 26710594 sgs.china@sgs.com

### 2.7.2 Data Storage

The DASY software stores the acquired data from the data acquisition electronics as raw data (in microvolt readings from the probe sensors), together with all necessary software parameters for the data evaluation (probe calibration data, liquid parameters and device frequency and modulation data) in measurement files with the extension "DAE". The software evaluates the desired unit and format for output each time the data is visualized or exported. This allows verification of the complete software setup even after the measurement and allows correction of incorrect parameter settings. For example, if a measurement has been performed with a wrong crest factor parameter in the device setup, the parameter can be corrected afterwards and the data can be re-evaluated. The measured data can be visualized or exported in different units or formats, depending on the selected probe type ([V/m], [A/m], [°C], [m W/g], [m W/cm<sup>2</sup>], [dBrel], etc.). Some of these units are not available in certain situations or show meaningless results, e.g., a SAR output in a lossless media will always be zero. Raw data can also be exported to perform the evaluation with other software packages.

### 2.7.3 Data Evaluation by SEMCAD

The SEMCAD software automatically executes the following procedures to calculate the field units from the microvolt readings at the probe connector. The parameters used in the evaluation are stored in the configuration modules of the software:

Probe parameters:	- Sensitivity	Normi, ai0, ai1, ai2
	- Conversion factor	ConvFi
	- Diode compression point	Dcpi
Device parameters:	- Frequency	f
	- Crest factor	cf
Media parameters:	- Conductivity	ε
	- Density	ρ

These parameters must be set correctly in the software. They can be found in the component documents or they can be imported into the software from the configuration files issued for the DASY components. In the direct measuring mode of the multimeter option, the parameters of the actual system setup are used. In the scan visualization and export modes, the parameters stored in the corresponding document files are used.

The first step of the evaluation is a linearization of the filtered input signal to account for the compression characteristics of the detector diode. The compensation depends on the input signal, the diode type and the DC-transmission factor from the diode to the evaluation electronics.

If the exciting field is pulsed, the crest factor of the signal must be known to correctly compensate for peak power.

The formula for each channel can be given as:

$$V_i = U_i + U_i^2 \cdot cf / dcp_i$$

With  $V_i$  = compensated signal of channel  $i$  ( $i = x, y, z$ )

$U_i$  = input signal of channel  $i$  ( $i = x, y, z$ )

cf = crest factor of exciting field (DASY parameter)

dcp  $i$  = diode compression point (DASY parameter)



Unless otherwise agreed in writing, this document is issued by the Company subject to its General Conditions of Service printed overleaf, available on request or accessible at <http://www.sgs.com/en/Terms-and-Conditions.aspx> and, for electronic format documents, subject to Terms and Conditions for Electronic Documents at <http://www.sgs.com/en/Terms-and-Conditions/Terms-e-Documents.aspx>. Attention is drawn to the limitation of liability, indemnification and jurisdiction issues defined therein. Any holder of this document is advised that information contained hereon reflects the Company's findings at the time of its intervention only and within the limits of Client's instructions, if any. The Company's sole responsibility is to its Client and this document does not exonerate parties to a transaction from exercising all their rights and obligations under the transaction documents. This document cannot be reproduced except in full, without prior written approval of the Company. Any unauthorized alteration, forgery or falsification of the content or appearance of this document is unlawful and offenders may be prosecuted to the fullest extent of the law. Unless otherwise stated the results shown in this test report refer only to the sample(s) tested and such sample(s) are retained for 30 days only.  
**Attention: To check the authenticity of testing / inspection report & certificate, please contact us at telephone: (86-755) 8307 1443, or email: CN.Doccheck@sgs.com**

From the compensated input signals the primary field data for each channel can be evaluated:

E-field probes:

$$E_i = (V_i / Norm_i \cdot ConvF)^{1/2}$$

H-field probes:

$$H_i = (V_i)^{1/2} \cdot (a_{i0} + a_{i1}f + a_{i2}f^2) / f$$

With  $V_i$  = compensated signal of channel  $i$  ( $i = x, y, z$ )

$Norm_i$  = sensor sensitivity of channel  $i$  ( $i = x, y, z$ )

[mV/(V/m)<sup>2</sup>] for E-field Probes

ConvF = sensitivity enhancement in solution

$a_{ij}$  = sensor sensitivity factors for H-field probes

$f$  = carrier frequency [GHz]

$E_i$  = electric field strength of channel  $i$  in V/m

$H_i$  = magnetic field strength of channel  $i$  in A/m

The RSS value of the field components gives the total field strength (Hermitian magnitude):

$$E_{tot} = (E_x^2 + E_y^2 + E_z^2)^{1/2}$$

The primary field data are used to calculate the derived field units.

$$SAR = (E_{tot}^2 \cdot \sigma) / (\epsilon \cdot 1000)$$

with SAR = local specific absorption rate in mW/g

$E_{tot}$  = total field strength in V/m

$\sigma$  = conductivity in [mho/m] or [Siemens/m]

$\epsilon$  = equivalent tissue density in g/cm<sup>3</sup>

Note that the density is normally set to 1 (or 1.06), to account for actual brain density rather than the density of the simulation liquid. The power flow density is calculated assuming the excitation field to be a free space field.

$$P_{pwe} = E_{tot}^2 / 3770 \text{ or } P_{pwe} = H_{tot}^2 \cdot 37.7$$

with  $P_{pwe}$  = equivalent power density of a plane wave in mW/cm<sup>2</sup>

$E_{tot}$  = total electric field strength in V/m

$H_{tot}$  = total magnetic field strength in A/m



### 3 Description of Test Position

#### 3.1 The Body Test Position

SAR can test the sides near the antenna, the surface of the device should be tested for SAR compliance with the device touching the phantom. The SAR Exclusion Threshold in KDB 447498 D01 can be applied to determine SAR test exclusion for adjacent edge configurations. The closest distance from the antenna to an adjacent device surface is used to determine if SAR testing is required for the adjacent surfaces, with the adjacent surface positioned against the phantom and the surface containing the antenna positioned perpendicular to the phantom.



Unless otherwise agreed in writing, this document is issued by the Company subject to its General Conditions of Service printed overleaf, available on request or accessible at <http://www.sgs.com/en/Terms-and-Conditions.aspx> and, for electronic format documents, subject to Terms and Conditions for Electronic Documents at <http://www.sgs.com/en/Terms-and-Conditions/Terms-e-Documents.aspx>. Attention is drawn to the limitation of liability, indemnification and jurisdiction issues defined therein. Any holder of this document is advised that information contained hereon reflects the Company's findings at the time of its intervention only and within the limits of Client's instructions, if any. The Company's sole responsibility is to its Client and this document does not exonerate parties to a transaction from exercising all their rights and obligations under the transaction documents. This document cannot be reproduced except in full, without prior written approval of the Company. Any unauthorized alteration, forgery or falsification of the content or appearance of this document is unlawful and offenders may be prosecuted to the fullest extent of the law. Unless otherwise stated the results shown in this test report refer only to the sample(s) tested and such sample(s) are retained for 30 days only.  
**Attention: To check the authenticity of testing /inspection report & certificate, please contact us at telephone: (86-755) 8307 1443, or email: [CN.Doccheck@sgs.com](mailto:CN.Doccheck@sgs.com)**

## 4 SAR System Verification Procedure

### 4.1 Tissue Simulate Liquid

#### 4.1.1 Recipes for Tissue Simulate Liquid

The following tables give the recipes for tissue simulating liquids to be used in different frequency bands:

Ingredients (% by weight)	Frequency (MHz)							
	450		700-950		1700-2000		2300-2700	
Tissue Type	Head	Body	Head	Body	Head	Body	Head	Body
Water	38.56	51.16	40.30	50.75	55.24	70.17	55.00	68.53
Salt (NaCl)	3.95	1.49	1.38	0.94	0.31	0.39	0.2	0.1
Sucrose	56.32	46.78	57.90	48.21	0	0	0	0
HEC	0.98	0.52	0.24	0	0	0	0	0
Bactericide	0.19	0.05	0.18	0.10	0	0	0	0
Tween	0	0	0	0	44.45	29.44	44.80	31.37
Salt: 99+% Pure Sodium Chloride				Sucrose: 98+% Pure Sucrose				
Water: De-ionized, 16 MΩ <sup>+</sup> resistivity				HEC: Hydroxyethyl Cellulose				
Tween: Polyoxyethylene (20) sorbitan monolaurate								
HSL5GHz is composed of the following ingredients:								
Water: 50-65%								
Mineral oil: 10-30%								
Emulsifiers: 8-25%								
Sodium salt: 0-1.5%								
MSL5GHz is composed of the following ingredients:								
Water: 64-78%								
Mineral oil: 11-18%								
Emulsifiers: 9-15%								
Sodium salt: 2-3%								

Table 1 : Recipe of Tissue Simulate Liquid



#### 4.1.2 Measurement for Tissue Simulate Liquid

The dielectric properties for this Tissue Simulate Liquids were measured by using the Agilent Model 85070E Dielectric Probe in conjunction with Agilent E5071C Network Analyzer (300 KHz-8500 MHz). The Conductivity ( $\sigma$ ) and Permittivity ( $\rho$ ) are listed in Table 2. For the SAR measurement given in this report. The temperature variation of the Tissue Simulate Liquids was  $22\pm 2^\circ\text{C}$ .

Tissue Type	Measured Frequency (MHz)	Target Tissue ( $\pm 5\%$ )		Measured Tissue		Liquid Temp.	Measured Date
		$\epsilon_r$	$\sigma(\text{S/m})$	$\epsilon_r$	$\sigma(\text{S/m})$	( $^\circ\text{C}$ )	
2450 Body	2450	52.70 (50.07~55.34)	1.95 (1.85~2.05)	52.708	1.998	22.0	2019/4/28

Table 2 : Measurement result of Tissue electric parameters



Unless otherwise agreed in writing, this document is issued by the Company subject to its General Conditions of Service printed overleaf, available on request or accessible at <http://www.sgs.com/en/Terms-and-Conditions.aspx> and, for electronic format documents, subject to Terms and Conditions for Electronic Documents at <http://www.sgs.com/en/Terms-and-Conditions/Terms-e-Document.aspx>. Attention is drawn to the limitation of liability, indemnification and jurisdiction issues defined therein. Any holder of this document is advised that information contained hereon reflects the Company's findings at the time of its intervention only and within the limits of Client's instructions, if any. The Company's sole responsibility is to its Client and this document does not exonerate parties to a transaction from exercising all their rights and obligations under the transaction documents. This document cannot be reproduced except in full, without prior written approval of the Company. Any unauthorized alteration, forgery or falsification of the content or appearance of this document is unlawful and offenders may be prosecuted to the fullest extent of the law. Unless otherwise stated the results shown in this test report refer only to the sample(s) tested and such sample(s) are retained for 30 days only.  
**Attention: To check the authenticity of testing /inspection report & certificate, please contact us at telephone: (86-755) 8307 1443, or email: CN.Doccheck@sgs.com**

## 4.2 SAR System Check

The microwave circuit arrangement for system Check is sketched in F-3. The daily system accuracy verification occurs within the flat section of the SAM phantom. A SAR measurement was performed to see if the measured SAR was within +/- 10% from the target SAR values. The tests were conducted on the same days as the measurement of the EUT. The obtained results from the system accuracy verification are displayed in the following table (A power level of 250mW (below 3GHz) or 100mW (3-6GHz) was input to the dipole antenna). During the tests, the ambient temperature of the laboratory was in the range 22±2°C, the relative humidity was in the range 60% and the liquid depth above the ear reference points was above 15±0.5 cm in all the cases. It is seen that the system is operating within its specification, as the results are within acceptable tolerance of the reference values.

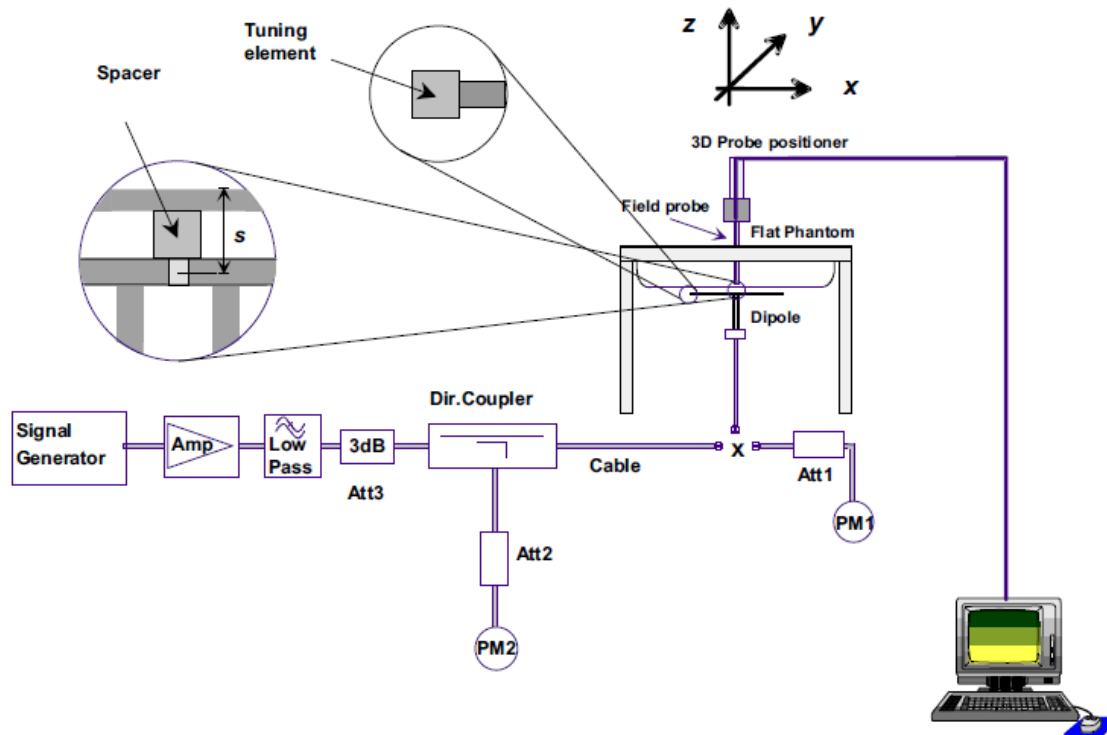

F-3. the microwave circuit arrangement used for SAR system check

#### 4.2.1 Justification for Extended SAR Dipole Calibrations

1) Referring to KDB865664 D01 requirements for dipole calibration, instead of the typical annual calibration recommended by measurement standards, longer calibration intervals of up to three years may be considered when it is demonstrated that the SAR target, impedance and return loss of a dipole have remain stable according to the following requirements. Each measured dipole is expected to evaluate with the following criteria at least on annual interval in Appendix C.

- a) There is no physical damage on the dipole;
- b) System check with specific dipole is within 10% of calibrated value;
- c) Return-loss is within 10% of calibrated measurement;
- d) Impedance is within 5Ω from the previous measurement.

2) Network analyzer probe calibration against air, distilled water and a shorting block performed before measuring liquid parameters.

#### 4.2.2 Summary System Check Result(s)

Validation Kit	Measured SAR 250mW	Measured SAR 250mW	Measured SAR (normalized to 1W)	Measured SAR (normalized to 1W)	Target SAR (normalized to 1W) (±10%)	Target SAR (normalized to 1W) (±10%)	Liquid Temp. (°C)	Measured Date	
									1g (W/kg)
D2450V2	Body	13.20	6.21	52.80	24.84	51.0 (45.9~56.1)	23.5 (21.15~25.85)	22.0	2019/4/28

Table 3 : SAR System Check Result

#### 4.2.3 Detailed System Check Results

Please see the Appendix A



## 5 Test results and Measurement Data

### 5.1 Operation Configurations

#### 5.1.1 Operation Configuration

For the SAR tests, a communication link is set up with the test mode software for 2.4G. The Absolute Radio Frequency Channel Number (ARFCN) is allocated to 0, 17 and 32 respectively in the case of 2405~2475 MHz during the test at each test frequency channel. The EUT is operated at the RF continuous emission mode. Each channel should be tested at the lowest rate. operating modes are tested independently according to the service requirements in each frequency band.

- 2.4G(user-defined)  
Duty cycle=100%

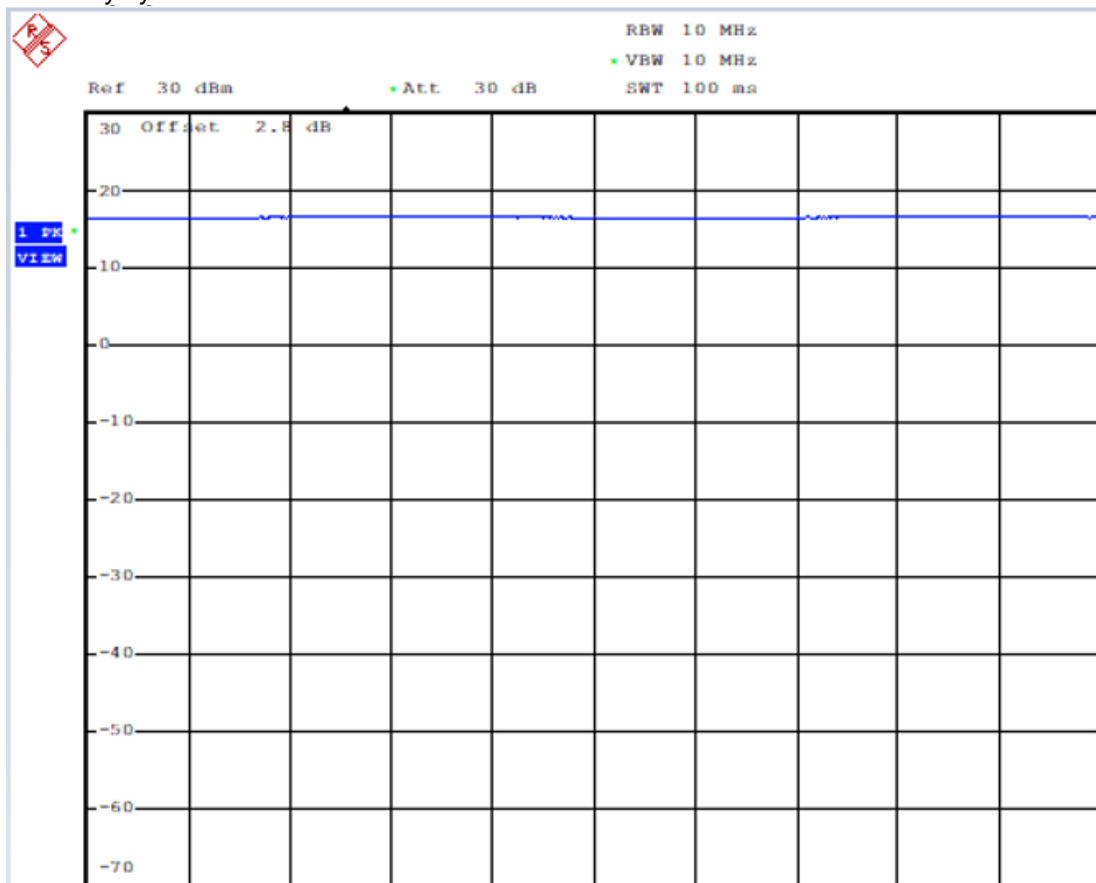

5.1.2 DUT Antenna Locations ( Front View )



### 5.1.3 Stand-alone SAR test evaluation

Unless specifically required by the published RF exposure KDB procedures, standalone 1-g body SAR evaluation for general population exposure conditions, by measurement or numerical simulation, is not required when the corresponding SAR Test Exclusion Threshold condition is satisfied. These test exclusion conditions are based on source-based time-averaged maximum conducted output power of the RF channel requiring evaluation, adjusted for tune-up tolerance, and the minimum test separation distance required for the exposure conditions.

Freq. Band	Frequency (GHz)	Position	Average Power		Test Separation (mm)	Calculate Value	Exclusion Threshold	Exclusion (Y/N)
			dBm	mW				
2.4G (user-defined)	2.475	Body	18.00	63.10	5	19.85	3	N

The 1-g and 10-g SAR test exclusion thresholds for 100 MHz to 6 GHz at test separation distances  $\leq 50$  mm are determined by:

$$[(\text{max. power of channel, including tune-up tolerance, mW}) / (\text{min. test separation distance, mm})] \cdot [\sqrt{f(\text{GHz})}] \leq 3.0$$

- for 1-g SAR and  $\leq 7.5$  for 10-g extremity SAR, where
- $f(\text{GHz})$  is the RF channel transmit frequency in GHz
  - Power and distance are rounded to the nearest mW and mm before calculation
  - The result is rounded to one decimal place for comparison

The test exclusions are applicable only when the minimum test separation distance is  $\leq 50$  mm and for transmission frequencies between 100 MHz and 6 GHz. When the minimum test separation distance is  $< 5$  mm, a distance of 5 mm is applied to determine SAR test exclusion.



Unless otherwise agreed in writing, this document is issued by the Company subject to its General Conditions of Service printed overleaf, available on request or accessible at <http://www.sgs.com/en/Terms-and-Conditions.aspx> and, for electronic format documents, subject to Terms and Conditions for Electronic Documents at <http://www.sgs.com/en/Terms-and-Conditions/Terms-e-Documents.aspx>. Attention is drawn to the limitation of liability, indemnification and jurisdiction issues defined therein. Any holder of this document is advised that information contained hereon reflects the Company's findings at the time of its intervention only and within the limits of Client's instructions, if any. The Company's sole responsibility is to its Client and this document does not exonerate parties to a transaction from exercising all their rights and obligations under the transaction documents. This document cannot be reproduced except in full, without prior written approval of the Company. Any unauthorized alteration, forgery or falsification of the content or appearance of this document is unlawful and offenders may be prosecuted to the fullest extent of the law. Unless otherwise stated the results shown in this test report refer only to the sample(s) tested and such sample(s) are retained for 30 days only.  
**Attention: To check the authenticity of testing /inspection report & certificate, please contact us at telephone: (86-755) 8307 1443, or email: CN.Doccheck@sgs.com**

## 5.2 Measurement of RF conducted Power

### 5.2.1 Conducted Power of 2.4G(user-defined)

2.4G(user-defined)			
Channel	Frequency (MHz)	Average Power (dBm)	Tune up
1	2405	16.50	18.00
17	2439	16.50	18.00
32	2475	16.20	18.00

Table 4 : Conducted Power of 2.4G(user-defined).



Unless otherwise agreed in writing, this document is issued by the Company subject to its General Conditions of Service printed overleaf, available on request or accessible at <http://www.sgs.com/en/Terms-and-Conditions.aspx> and, for electronic format documents, subject to Terms and Conditions for Electronic Documents at <http://www.sgs.com/en/Terms-and-Conditions/Terms-e-Documents.aspx>. Attention is drawn to the limitation of liability, indemnification and jurisdiction issues defined therein. Any holder of this document is advised that information contained hereon reflects the Company's findings at the time of its intervention only and within the limits of Client's instructions, if any. The Company's sole responsibility is to its Client and this document does not exonerate parties to a transaction from exercising all their rights and obligations under the transaction documents. This document cannot be reproduced except in full, without prior written approval of the Company. Any unauthorized alteration, forgery or falsification of the content or appearance of this document is unlawful and offenders may be prosecuted to the fullest extent of the law. Unless otherwise stated the results shown in this test report refer only to the sample(s) tested and such sample(s) are retained for 30 days only.  
**Attention: To check the authenticity of testing /inspection report & certificate, please contact us at telephone: (86-755) 8307 1443, or email: CN.Doccheck@sgs.com**

### 5.3 Measurement of SAR Data

#### 5.3.1 SAR Result of 2.4G(user-defined)

Test position	Test Ch./Freq.	Duty Cycle	Duty Cycle Scaled factor	SAR (W/kg) 1-g	Power drift (dB)	Conducted power (dBm)	Tune up Limit (dBm)	Scaled factor	Scaled SAR (W/kg)	Liquid Temp.
Body Test data (Separate 0mm)										
Front side	17/2439	100.00%	1.000	0.116	0.19	16.50	18.00	1.413	0.164	22.0
Back side	17/2439	100.00%	1.000	0.101	-0.04	16.50	18.00	1.413	0.143	22.0
Left side	17/2439	100.00%	1.000	0.113	0.12	16.50	18.00	1.413	0.160	22.0
Right side	17/2439	100.00%	1.000	0.063	0.02	16.50	18.00	1.413	0.089	22.0
Top side	17/2439	100.00%	1.000	0.208	0.09	16.50	18.00	1.413	<b>0.294</b>	22.0
Top side	1/2405	100.00%	1.000	0.203	0.04	16.50	18.00	1.413	0.287	22.0
Top side	32/2475	100.00%	1.000	0.191	0.05	16.20	18.00	1.514	0.289	22.0
Bottom side	17/2439	100.00%	1.000	0.067	0.00	16.50	18.00	1.413	0.095	22.0

Table 5: SAR of 2.4G(user-defined).

Note:

- 1) The maximum Scaled SAR value is marked in **bold**. Graph Results refer to Appendix B
- 2) If the reported (scaled) SAR measured at the middle channel or highest output power channel for each test configuration is  $\leq 0.8$  W/kg then testing at the other channels is not required for such test configuration(s).
- 3) Upper and lower frequencies were measured at the worst position.



Unless otherwise agreed in writing, this document is issued by the Company subject to its General Conditions of Service printed overleaf, available on request or accessible at <http://www.sgs.com/en/Terms-and-Conditions.aspx> and, for electronic format documents, subject to Terms and Conditions for Electronic Documents at <http://www.sgs.com/en/Terms-and-Conditions/Terms-e-Documents.aspx>. Attention is drawn to the limitation of liability, indemnification and jurisdiction issues defined therein. Any holder of this document is advised that information contained hereon reflects the Company's findings at the time of its intervention only and within the limits of Client's instructions, if any. The Company's sole responsibility is to its Client and this document does not exonerate parties to a transaction from exercising all their rights and obligations under the transaction documents. This document cannot be reproduced except in full, without prior written approval of the Company. Any unauthorized alteration, forgery or falsification of the content or appearance of this document is unlawful and offenders may be prosecuted to the fullest extent of the law. Unless otherwise stated the results shown in this test report refer only to the sample(s) tested and such sample(s) are retained for 30 days only.  
Attention: To check the authenticity of testing /inspection report & certificate, please contact us at telephone: (86-755) 8307 1443, or email: [CN.Doccheck@sgs.com](mailto:CN.Doccheck@sgs.com)

## 6 Equipment list

Test Platform		SPEAG DASY5 Professional				
Location		SGS-CSTC Standards Technical Services Co., Ltd. Shenzhen Branch				
Description		SAR Test System (Frequency range 300MHz-6GHz)				
Software Reference		DASY52 52.8.8(1222); SEMCAD X 14.6.10(7331)				
<b>Hardware Reference</b>						
Equipment	Manufacturer	Model	Serial Number	Calibration Date	Due date of calibration	
<input checked="" type="checkbox"/> Robot	Staubli	RX90L	F03/5V32A1/A01	NCR	NCR	
<input checked="" type="checkbox"/> ELI	SPEAG	ELI V5.0	1132	NCR	NCR	
<input checked="" type="checkbox"/> DAE	SPEAG	DAE3	414	2018-12-03	2019-12-02	
<input checked="" type="checkbox"/> E-Field Probe	SPEAG	EX3DV4	3793	2019-03-25	2020-03-24	
<input checked="" type="checkbox"/> Validation Kits	SPEAG	D2450V2	733	2016-12-07	2019-12-06	
<input checked="" type="checkbox"/> Agilent Network Analyzer	Agilent	E5071C	MY46523590	2019-04-12	2020-04-11	
<input checked="" type="checkbox"/> Dielectric Probe Kit	Agilent	85070E	US01440210	NCR	NCR	
<input checked="" type="checkbox"/> RF Bi-Directional Coupler	Agilent	86205-60001	MY31400031	NCR	NCR	
<input checked="" type="checkbox"/> Signal Generator	Agilent	N5171B	MY53050736	2019-04-12	2020-04-11	
<input checked="" type="checkbox"/> Preamplifier	Mini-Circuits	ZHL-42W	15542	NCR	NCR	
<input checked="" type="checkbox"/> Power Meter	Agilent	E4416A	GB41292095	2019-04-12	2020-04-11	
<input checked="" type="checkbox"/> Power Sensor	Agilent	8481H	MY41091234	2019-04-12	2020-04-11	
<input checked="" type="checkbox"/> Power Sensor	R&S	NRP-Z92	100025	2019-04-12	2020-04-11	
<input checked="" type="checkbox"/> Attenuator	SHX	TS2-3dB	30704	NCR	NCR	
<input checked="" type="checkbox"/> Coaxial low pass filter	Mini-Circuits	VLF-2500(+)	NA	NCR	NCR	
<input checked="" type="checkbox"/> Coaxial low pass filter	Microlab Fxr	LA-F13	NA	NCR	NCR	
<input checked="" type="checkbox"/> 50 Ω coaxial load	Mini-Circuits	KARN-50+	00850	NCR	NCR	
<input checked="" type="checkbox"/> DC POWER SUPPLY	SAKO	SK1730SL5A	NA	NCR	NCR	
<input checked="" type="checkbox"/> Speed reading thermometer	MingGao	T809	NA	2019-04-15	2020-04-14	
<input checked="" type="checkbox"/> Humidity and Temperature Indicator	KIMTOKA	KIMTOKA	NA	2019-04-15	2020-04-14	

Note: All the equipments are within the valid period when the tests are performed.



Unless otherwise agreed in writing, this document is issued by the Company subject to its General Conditions of Service printed overleaf, available on request or accessible at <http://www.sgs.com/en/Terms-and-Conditions.aspx> and, for electronic format documents, subject to Terms and Conditions for Electronic Documents at <http://www.sgs.com/en/Terms-and-Conditions/Terms-e-Documents.aspx>. Attention is drawn to the limitation of liability, indemnification and jurisdiction issues defined therein. Any holder of this document is advised that information contained hereon reflects the Company's findings at the time of its intervention only and within the limits of Client's instructions, if any. The Company's sole responsibility is to its Client and this document does not exonerate parties to a transaction from exercising all their rights and obligations under the transaction documents. This document cannot be reproduced except in full, without prior written approval of the Company. Any unauthorized alteration, forgery or falsification of the content or appearance of this document is unlawful and offenders may be prosecuted to the fullest extent of the law. Unless otherwise stated the results shown in this test report refer only to the sample(s) tested and such sample(s) are retained for 30 days only.  
**Attention: To check the authenticity of testing / inspection report & certificate, please contact us at telephone: (86-755) 8307 1443, or email: CN.Doccheck@sgs.com**

## 7 Measurement Uncertainty

Per KDB865664 D01 SAR Measurement 100 MHz to 6 GHz, when the highest measured 1-g SAR within a frequency band is < 1.5 W/kg, the extensive SAR measurement uncertainty analysis described in IEEE Std 1528-2013 is not required in SAR reports submitted for equipment approval. The equivalent ratio (1.5/1.6) is applied to extremity and occupational exposure conditions.

## 8 Calibration certificate

Please see the Appendix C

## 9 Photographs

Please see the Appendix D



Unless otherwise agreed in writing, this document is issued by the Company subject to its General Conditions of Service printed overleaf, available on request or accessible at <http://www.sgs.com/en/Terms-and-Conditions.aspx> and, for electronic format documents, subject to Terms and Conditions for Electronic Documents at <http://www.sgs.com/en/Terms-and-Conditions/Terms-e-Documents.aspx>. Attention is drawn to the limitation of liability, indemnification and jurisdiction issues defined therein. Any holder of this document is advised that information contained hereon reflects the Company's findings at the time of its intervention only and within the limits of Client's instructions, if any. The Company's sole responsibility is to its Client and this document does not exonerate parties to a transaction from exercising all their rights and obligations under the transaction documents. This document cannot be reproduced except in full, without prior written approval of the Company. Any unauthorized alteration, forgery or falsification of the content or appearance of this document is unlawful and offenders may be prosecuted to the fullest extent of the law. Unless otherwise stated the results shown in this test report refer only to the sample(s) tested and such sample(s) are retained for 30 days only.  
**Attention: To check the authenticity of testing /inspection report & certificate, please contact us at telephone: (86-755) 8307 1443, or email: [CN.Doccheck@sgs.com](mailto:CN.Doccheck@sgs.com)**



## Appendix A: Detailed System Check Results

## Appendix B: Detailed Test Results

## Appendix C: Calibration certificate

## Appendix D: Photographs

---END---





# **Appendix A**

## **Detailed System Check Results**

1. System Performance Check
-----------------------------

System Performance Check 2450 MHz Body
--

Test Laboratory: SGS-SAR Lab

## System Performance Check 2450MHz Body

**DUT: D2450V2; Type: D2450V2; Serial: 733**

Communication System: UID 0, CW (0); Frequency: 2450 MHz; Duty Cycle: 1:1

Medium: MSL2450; Medium parameters used:  $f = 2450$  MHz;  $\sigma = 1.998$  S/m;  $\epsilon_r = 52.708$ ;  $\rho = 1000$  kg/m<sup>3</sup>

Phantom section: Flat Section

DASY 5 Configuration:

- Probe: EX3DV4 - SN3793; ConvF(7.12, 7.12, 7.12); Calibrated: 2019-03-25;
- Sensor-Surface: 1.4mm (Mechanical Surface Detection),  $z = -2.0, 31.0$
- Electronics: DAE3 Sn414; Calibrated: 2018-12-03
- Phantom: ELI V5.0; Type: ELI; Serial: 1132
- DASY52 52.8.8(1222); SEMCAD X 14.6.10(7331)

**Body/d=10mm, Pin=250mW/Area Scan (10x11x1):** Measurement grid:  $dx=12$ mm,  $dy=12$ mm

Maximum value of SAR (measured) = 21.2 W/kg

**Body/d=10mm, Pin=250mW/Zoom Scan (7x7x7)/Cube 0:** Measurement grid:  $dx=5$ mm,  $dy=5$ mm,  $dz=5$ mm

Reference Value = 76.89 V/m; Power Drift = 0.07 dB

Peak SAR (extrapolated) = 26.3 W/kg

**SAR(1 g) = 13.2 W/kg; SAR(10 g) = 6.21 W/kg**

Maximum value of SAR (measured) = 21.7 W/kg

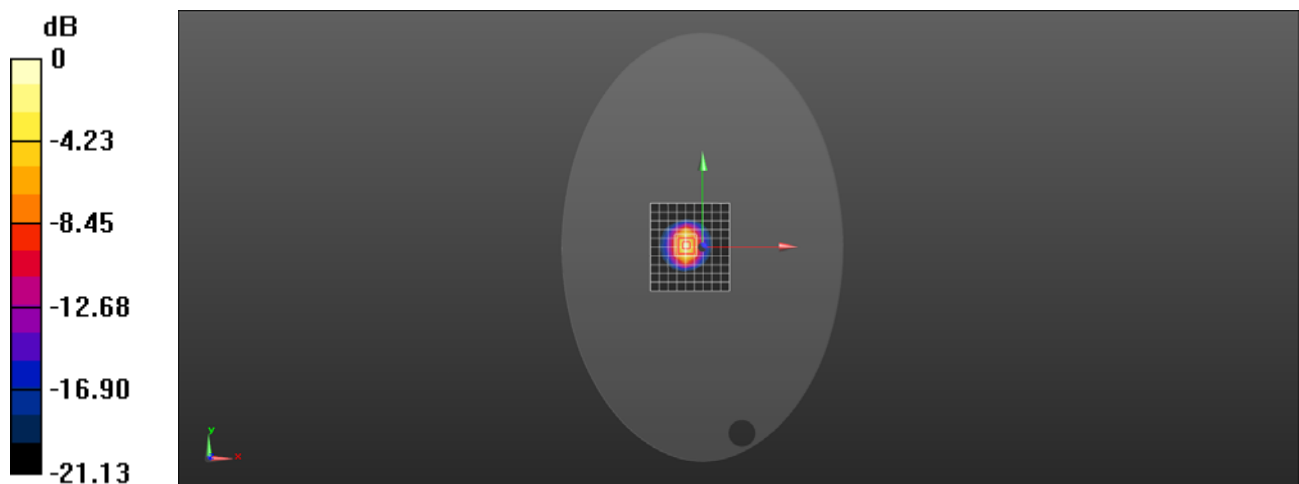

0 dB = 21.7 W/kg = 13.36 dBW/kg



# **Appendix B**

## **Detailed Test Results**

1. 2.4G
2.4G for Body

Test Laboratory: SGS-SAR Lab

## VM320 PU 2.4G 17CH Top side 0mm

**DUT: VM320 PU; Type: Video Bccby Monitor; Serial: NA**

Communication System: UID 0, 2.4GHz (0); Frequency: 2439 MHz; Duty Cycle: 1:1

Medium: MSL2450; Medium parameters used:  $f = 2439$  MHz;  $\sigma = 1.984$  S/m;  $\epsilon_r = 52.796$ ;  $\rho = 1000$  kg/m<sup>3</sup>

Phantom section: Flat Section

DASY 5 Configuration:

- Probe: EX3DV4 - SN3793; ConvF(7.12, 7.12, 7.12); Calibrated: 2019-03-25;
- Sensor-Surface: 1.4mm (Mechanical Surface Detection),  $z = -2.0, 31.0$
- Electronics: DAE3 Sn414; Calibrated: 2018-12-03
- Phantom: ELI V5.0; Type: ELI; Serial: 1132
- DASY52 52.8.8(1222); SEMCAD X 14.6.10(7331)

**Configuration/Body/Area Scan (7x14x1):** Measurement grid:  $dx=12$ mm,  $dy=12$ mm

Maximum value of SAR (measured) = 0.343 W/kg

**Configuration/Body/Zoom Scan (7x7x7)/Cube 0:** Measurement grid:  $dx=5$ mm,  $dy=5$ mm,  $dz=5$ mm

Reference Value = 3.239 V/m; Power Drift = 0.09 dB

Peak SAR (extrapolated) = 0.454 W/kg

**SAR(1 g) = 0.208 W/kg; SAR(10 g) = 0.087 W/kg**

Maximum value of SAR (measured) = 0.371 W/kg

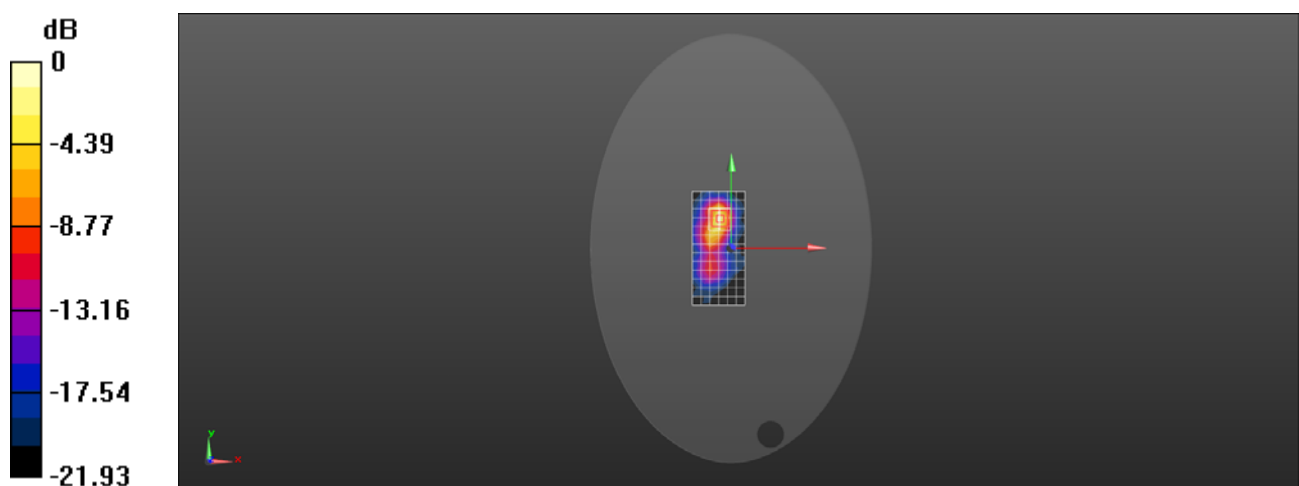

0 dB = 0.371 W/kg = -4.31 dBW/kg



# Appendix C

## Calibration certificate

1. Dipole
D2450V2-SN 733(2016-12-07)
2. DAE
DAE3-SN 414(2018-12-03)
3. Probe
EX3DV4-SN 3793(2019-03-25)



In Collaboration with  
**s p e a g**  
CALIBRATION LABORATORY



中国认可  
国际互认  
校准  
CALIBRATION  
CNAS L0570

Add: No.51 Xueyuan Road, Haidian District, Beijing, 100191, China  
Tel: +86-10-62304633-2079 Fax: +86-10-62304633-2504  
E-mail: cttl@chinattl.com [Http://www.chinattl.cn](http://www.chinattl.cn)

Client **SGS(Boce)**

Certificate No: **Z16-97242**

## CALIBRATION CERTIFICATE

Object **D2450V2 - SN: 733**

Calibration Procedure(s) **FD-Z11-003-01**  
**Calibration Procedures for dipole validation kits**

Calibration date: **December 7, 2016**

This calibration Certificate documents the traceability to national standards, which realize the physical units of measurements(SI). The measurements and the uncertainties with confidence probability are given on the following pages and are part of the certificate.

All calibrations have been conducted in the closed laboratory facility: environment temperature(22±3)°C and humidity<70%.

Calibration Equipment used (M&TE critical for calibration)

Primary Standards	ID #	Cal Date(Calibrated by, Certificate No.)	Scheduled Calibration
Power Meter NRP2	101919	27-Jun-16 (CTTL, No.J16X04777)	Jun-17
Power sensor NRP-Z91	101547	27-Jun-16 (CTTL, No.J16X04777)	Jun-17
Reference Probe EX3DV4	SN 7433	26-Sep-16(SPEAG,No.EX3-7433_Sep16)	Sep-17
DAE4	SN 771	02-Feb-16(CTTL-SPEAG,No.Z16-97011)	Feb-17
Secondary Standards	ID #	Cal Date(Calibrated by, Certificate No.)	Scheduled Calibration
Signal Generator E4438C	MY49071430	01-Feb-16 (CTTL, No.J16X00893)	Jan-17
Network Analyzer E5071C	MY46110673	26-Jan-16 (CTTL, No.J16X00894)	Jan-17

	Name	Function	Signature
Calibrated by:	Zhao Jing	SAR Test Engineer	
Reviewed by:	Qi Dianyuan	SAR Project Leader	
Approved by:	Lu Bingsong	Deputy Director of the laboratory	

Issued: December 11, 2016

This calibration certificate shall not be reproduced except in full without written approval of the laboratory.



In Collaboration with

**s p e a g**  
**CALIBRATION LABORATORY**

Add: No.51 Xueyuan Road, Haidian District, Beijing, 100191, China  
Tel: +86-10-62304633-2079 Fax: +86-10-62304633-2504  
E-mail: cttl@chinattl.com Http://www.chinattl.cn

#### Glossary:

TSL	tissue simulating liquid
ConvF	sensitivity in TSL / NORM <sub>x,y,z</sub>
N/A	not applicable or not measured

#### Calibration is Performed According to the Following Standards:

- IEEE Std 1528-2013, "IEEE Recommended Practice for Determining the Peak Spatial-Averaged Specific Absorption Rate (SAR) in the Human Head from Wireless Communications Devices: Measurement Techniques", June 2013
- IEC 62209-1, "Procedure to measure the Specific Absorption Rate (SAR) For hand-held devices used in close proximity to the ear (frequency range of 300MHz to 3GHz)", February 2005
- IEC 62209-2, "Procedure to measure the Specific Absorption Rate (SAR) For wireless communication devices used in close proximity to the human body (frequency range of 30MHz to 6GHz)", March 2010
- KDB865664, SAR Measurement Requirements for 100 MHz to 6 GHz

#### Additional Documentation:

- DASY4/5 System Handbook

#### Methods Applied and Interpretation of Parameters:

- Measurement Conditions:** Further details are available from the Validation Report at the end of the certificate. All figures stated in the certificate are valid at the frequency indicated.
- Antenna Parameters with TSL:** The dipole is mounted with the spacer to position its feed point exactly below the center marking of the flat phantom section, with the arms oriented parallel to the body axis.
- Feed Point Impedance and Return Loss:** These parameters are measured with the dipole positioned under the liquid filled phantom. The impedance stated is transformed from the measurement at the SMA connector to the feed point. The Return Loss ensures low reflected power. No uncertainty required.
- Electrical Delay:** One-way delay between the SMA connector and the antenna feed point. No uncertainty required.
- SAR measured:** SAR measured at the stated antenna input power.
- SAR normalized:** SAR as measured, normalized to an input power of 1 W at the antenna connector.
- SAR for nominal TSL parameters:** The measured TSL parameters are used to calculate the nominal SAR result.

The reported uncertainty of measurement is stated as the standard uncertainty of Measurement multiplied by the coverage factor  $k=2$ , which for a normal distribution Corresponds to a coverage probability of approximately 95%.



In Collaboration with

**s p e a g****CALIBRATION LABORATORY**

Add: No.51 Xueyuan Road, Haidian District, Beijing, 100191, China

Tel: +86-10-62304633-2079

Fax: +86-10-62304633-2504

E-mail: cttl@chinattl.com

Http://www.chinattl.cn

## Measurement Conditions

DASY system configuration, as far as not given on page 1.

DASY Version	DASY52	52.8.8.1258
Extrapolation	Advanced Extrapolation	
Phantom	Triple Flat Phantom 5.1C	
Distance Dipole Center - TSL	10 mm	with Spacer
Zoom Scan Resolution	dx, dy, dz = 5 mm	
Frequency	2450 MHz $\pm$ 1 MHz	

## Head TSL parameters

The following parameters and calculations were applied.

	Temperature	Permittivity	Conductivity
Nominal Head TSL parameters	22.0 °C	39.2	1.80 mho/m
Measured Head TSL parameters	(22.0 $\pm$ 0.2) °C	39.4 $\pm$ 6 %	1.81 mho/m $\pm$ 6 %
Head TSL temperature change during test	<1.0 °C	---	---

## SAR result with Head TSL

<b>SAR averaged over 1 cm<sup>3</sup> (1 g) of Head TSL</b>	Condition	
SAR measured	250 mW input power	13.3 mW / g
SAR for nominal Head TSL parameters	normalized to 1W	<b>53.1 mW / g <math>\pm</math> 20.8 % (k=2)</b>
<b>SAR averaged over 10 cm<sup>3</sup> (10 g) of Head TSL</b>	Condition	
SAR measured	250 mW input power	6.22 mW / g
SAR for nominal Head TSL parameters	normalized to 1W	<b>24.9 mW / g <math>\pm</math> 20.4 % (k=2)</b>

## Body TSL parameters

The following parameters and calculations were applied.

	Temperature	Permittivity	Conductivity
Nominal Body TSL parameters	22.0 °C	52.7	1.95 mho/m
Measured Body TSL parameters	(22.0 $\pm$ 0.2) °C	53.1 $\pm$ 6 %	1.94 mho/m $\pm$ 6 %
Body TSL temperature change during test	<1.0 °C	---	---

## SAR result with Body TSL

<b>SAR averaged over 1 cm<sup>3</sup> (1 g) of Body TSL</b>	Condition	
SAR measured	250 mW input power	12.7 mW / g
SAR for nominal Body TSL parameters	normalized to 1W	<b>51.0 mW / g <math>\pm</math> 20.8 % (k=2)</b>
<b>SAR averaged over 10 cm<sup>3</sup> (10 g) of Body TSL</b>	Condition	
SAR measured	250 mW input power	5.85 mW / g
SAR for nominal Body TSL parameters	normalized to 1W	<b>23.5 mW / g <math>\pm</math> 20.4 % (k=2)</b>



In Collaboration with

**s p e a g**  
**CALIBRATION LABORATORY**

Add: No.51 Xueyuan Road, Haidian District, Beijing, 100191, China  
Tel: +86-10-62304633-2079 Fax: +86-10-62304633-2504  
E-mail: cttl@chinattl.com Http://www.chinattl.cn

## Appendix

### Antenna Parameters with Head TSL

Impedance, transformed to feed point	52.9Ω+ 4.11jΩ
Return Loss	- 26.3dB

### Antenna Parameters with Body TSL

Impedance, transformed to feed point	49.7Ω+ 5.90jΩ
Return Loss	- 24.6dB

### General Antenna Parameters and Design

Electrical Delay (one direction)	1.257 ns
----------------------------------	----------

After long term use with 100W radiated power, only a slight warming of the dipole near the feedpoint can be measured.

The dipole is made of standard semirigid coaxial cable. The center conductor of the feeding line is directly connected to the second arm of the dipole. The antenna is therefore short-circuited for DC-signals. On some of the dipoles, small end caps are added to the dipole arms in order to improve matching when loaded according to the position as explained in the "Measurement Conditions" paragraph. The SAR data are not affected by this change. The overall dipole length is still according to the Standard.

No excessive force must be applied to the dipole arms, because they might bend or the soldered connections near the feedpoint may be damaged.

### Additional EUT Data

Manufactured by	SPEAG
-----------------	-------



Add: No.51 Xueyuan Road, Haidian District, Beijing, 100191, China  
Tel: +86-10-62304633-2079 Fax: +86-10-62304633-2504  
E-mail: cttl@chinattl.com Http://www.chinattl.cn

**DASY5 Validation Report for Head TSL**

Date: 11.07.2016

Test Laboratory: CTTL, Beijing, China

**DUT: Dipole 2450 MHz; Type: D2450V2; Serial: D2450V2 - SN: 733**

Communication System: UID 0, CW; Frequency: 2450 MHz; Duty Cycle: 1:1

Medium parameters used:  $f = 2450$  MHz;  $\sigma = 1.809$  S/m;  $\epsilon_r = 39.42$ ;  $\rho = 1000$  kg/m<sup>3</sup>

Phantom section: Center Section

Measurement Standard: DASY5 (IEEE/IEC/ANSI C63.19-2007)

DASY5 Configuration:

- Probe: EX3DV4 - SN7433; ConvF(7.45, 7.45, 7.45); Calibrated: 9/26/2016;
- Sensor-Surface: 2mm (Mechanical Surface Detection)
- Electronics: DAE4 Sn771; Calibrated: 2/2/2016
- Phantom: Triple Flat Phantom 5.1C; Type: QD 000 P51 CA; Serial: 1161/1
- Measurement SW: DASY52, Version 52.8 (8); SEMCAD X Version 14.6.10 (7372)

**Dipole Calibration/Zoom Scan (7x7x7) (7x7x7)/Cube 0: Measurement grid: dx=5mm, dy=5mm, dz=5mm**

Reference Value = 106.8 V/m; Power Drift = 0.03 dB

Peak SAR (extrapolated) = 27.5 W/kg

**SAR(1 g) = 13.3 W/kg; SAR(10 g) = 6.22 W/kg**

Maximum value of SAR (measured) = 20.4 W/kg

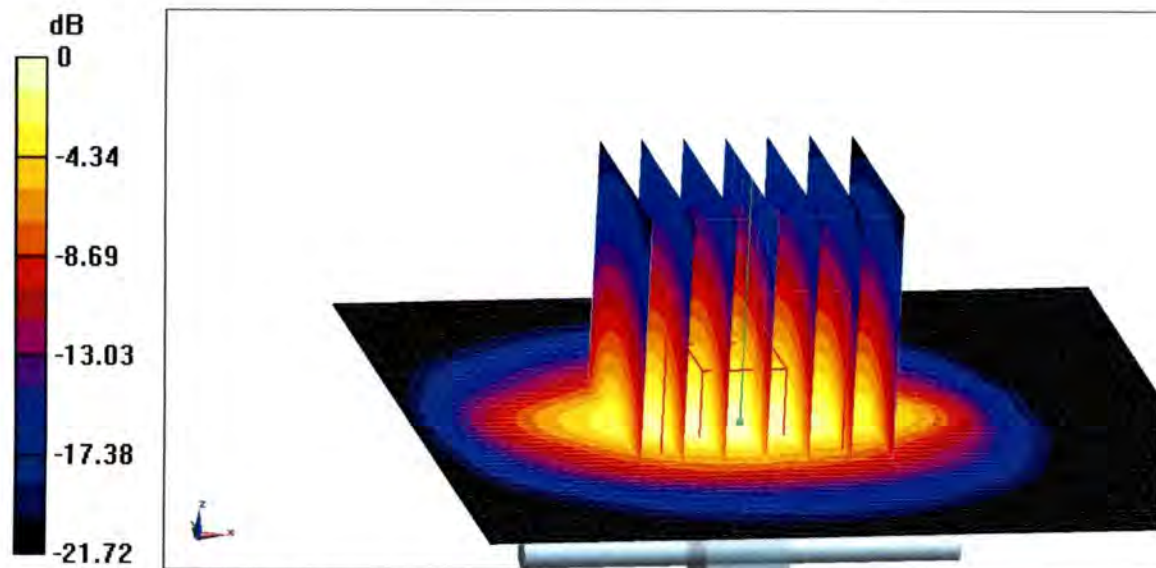

**0 dB = 20.4 W/kg = 13.10 dBW/kg**



Add: No.51 Xueyuan Road, Haidian District, Beijing, 100191, China  
Tel: +86-10-62304633-2079 Fax: +86-10-62304633-2504  
E-mail: cttl@chinattl.com Http://www.chinattl.cn

### Impedance Measurement Plot for Head TSL

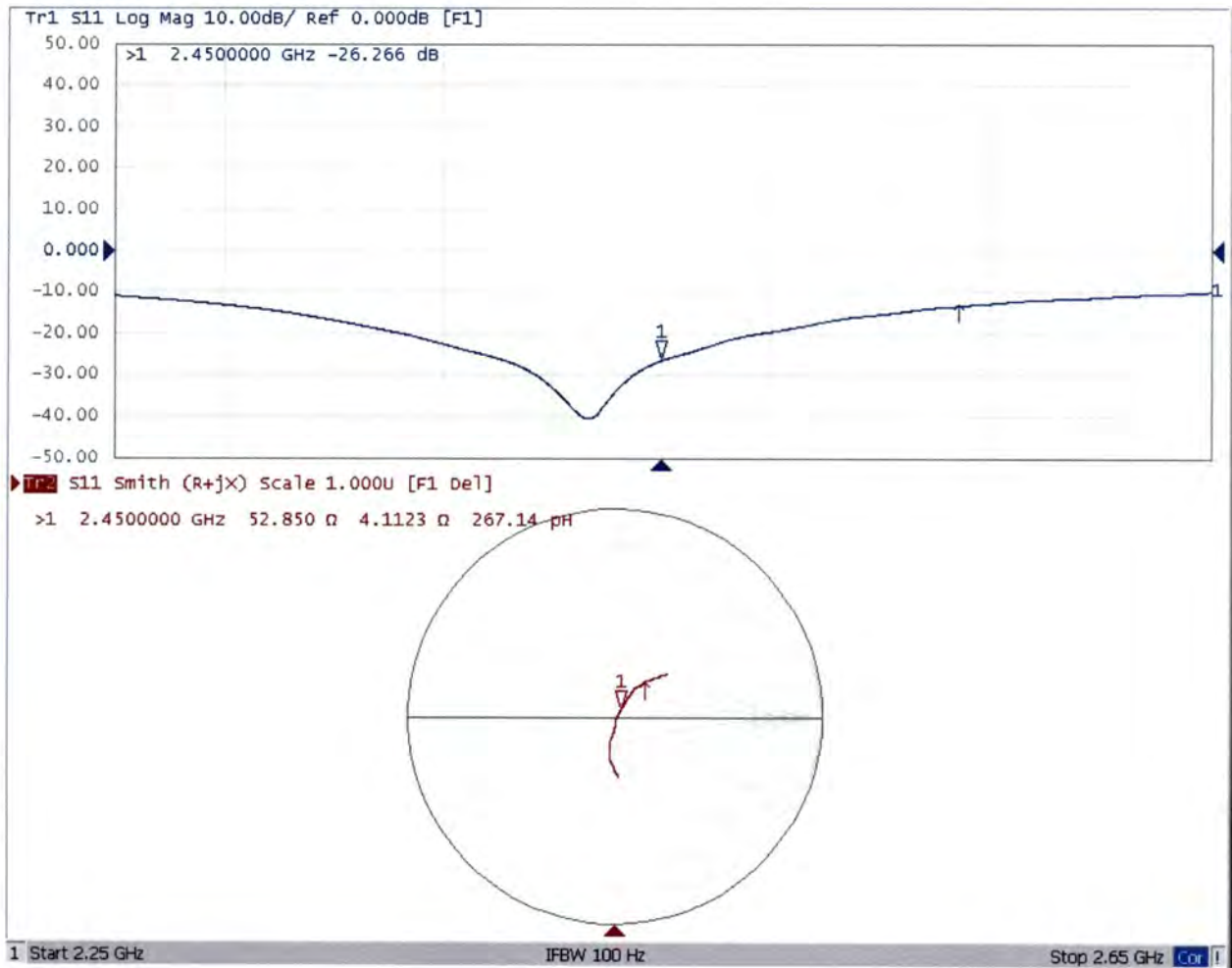



In Collaboration with

**s p e a g**  
**CALIBRATION LABORATORY**

Add: No.51 Xueyuan Road, Haidian District, Beijing, 100191, China  
Tel: +86-10-62304633-2079 Fax: +86-10-62304633-2504  
E-mail: cttl@chinattl.com Http://www.chinattl.cn

### DASY5 Validation Report for Body TSL

Date: 12.07.2016

Test Laboratory: CTTL, Beijing, China

**DUT: Dipole 2450 MHz; Type: D2450V2; Serial: D2450V2 - SN: 733**

Communication System: UID 0, CW; Frequency: 2450 MHz; Duty Cycle: 1:1

Medium parameters used:  $f = 2450$  MHz;  $\sigma = 1.943$  S/m;  $\epsilon_r = 53.12$ ;  $\rho = 1000$  kg/m<sup>3</sup>

Phantom section: Right Section

Measurement Standard: DASY5 (IEEE/IEC/ANSI C63.19-2007)

DASY5 Configuration:

- Probe: EX3DV4 - SN7433; ConvF(7.46, 7.46, 7.46); Calibrated: 9/26/2016;
- Sensor-Surface: 2mm (Mechanical Surface Detection)
- Electronics: DAE4 Sn771; Calibrated: 2/2/2016
- Phantom: Triple Flat Phantom 5.1C; Type: QD 000 P51 CA; Serial: 1161/1
- Measurement SW: DASY52, Version 52.8 (8); SEMCAD X Version 14.6.10 (7372)

**Dipole Calibration/Zoom Scan (7x7x7) (7x7x7)/Cube 0:** Measurement grid: dx=5mm, dy=5mm, dz=5mm

Reference Value = 98.60 V/m; Power Drift = -0.01 dB

Peak SAR (extrapolated) = 26.0 W/kg

**SAR(1 g) = 12.7 W/kg; SAR(10 g) = 5.85 W/kg**

Maximum value of SAR (measured) = 19.2 W/kg

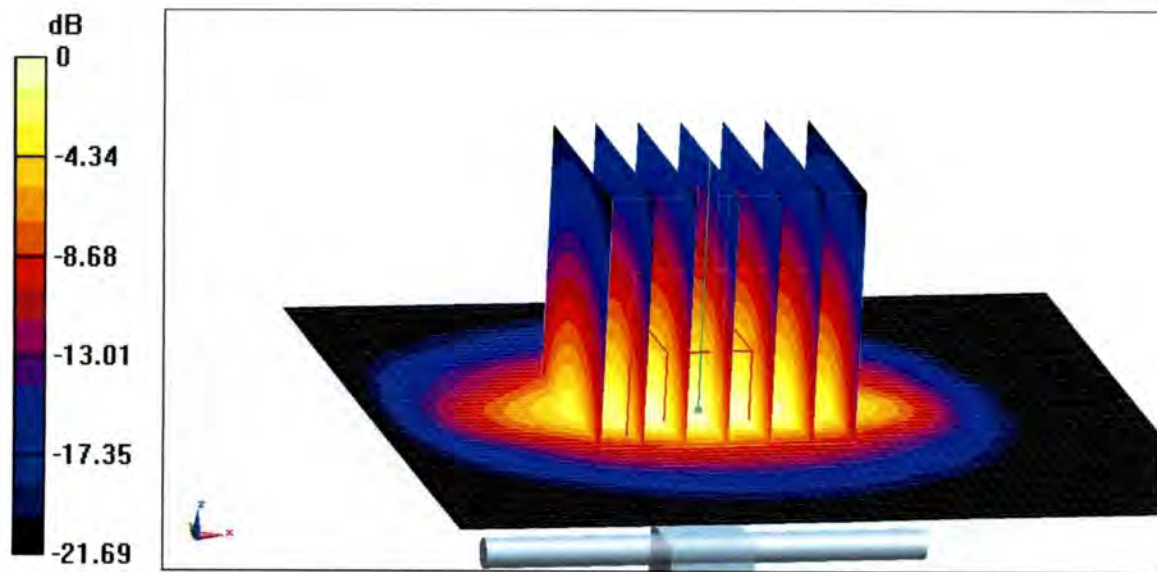

**0 dB = 19.2 W/kg = 12.83 dBW/kg**



Add: No.51 Xueyuan Road, Haidian District, Beijing, 100191, China  
Tel: +86-10-62304633-2079 Fax: +86-10-62304633-2504  
E-mail: cttl@chinattl.com Http://www.chinattl.cn

### Impedance Measurement Plot for Body TSL

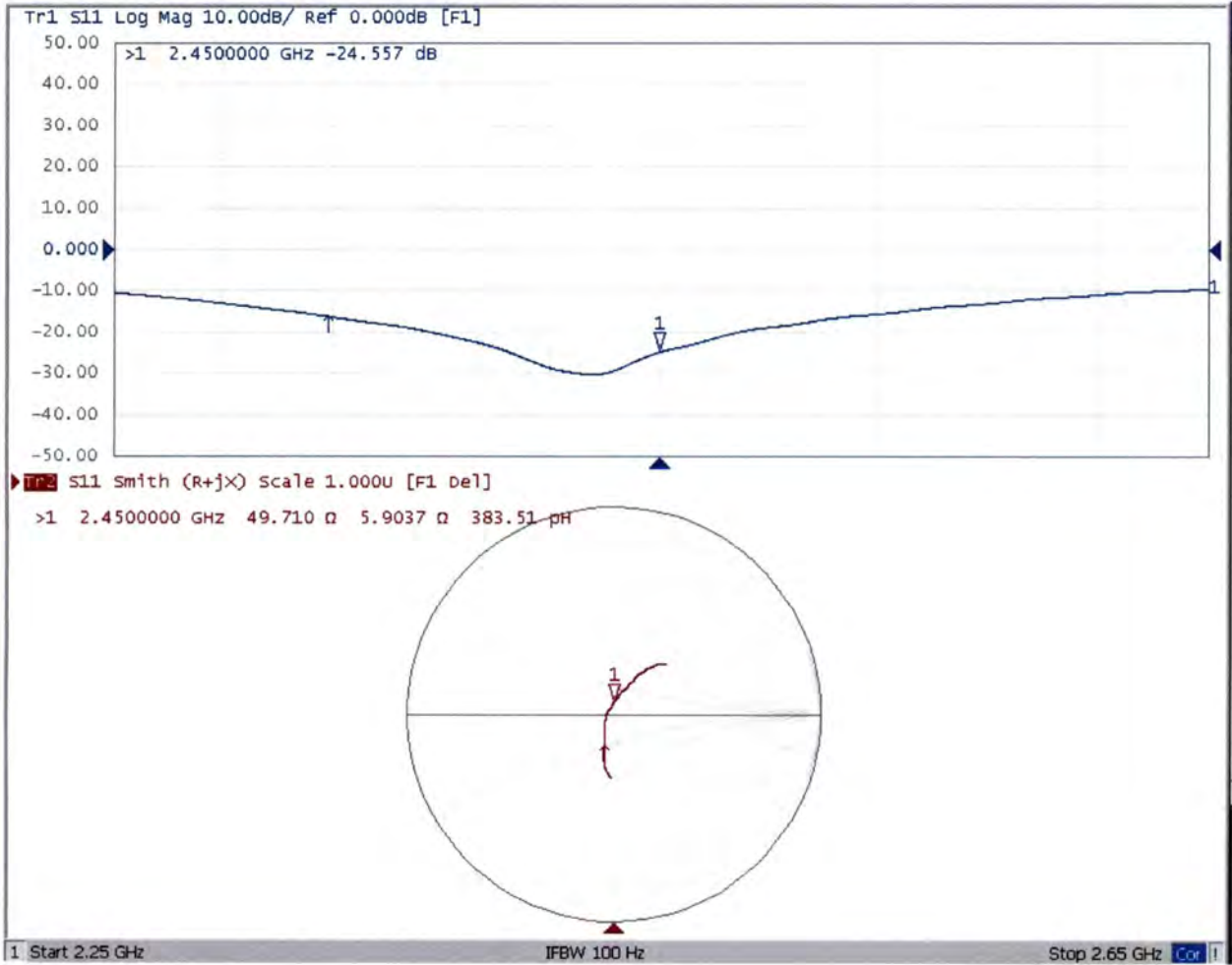



In Collaboration with  
**s p e a g**  
CALIBRATION LABORATORY



中国认可  
国际互认  
校准  
CALIBRATION  
CNAS L0570

Add: No.51 Xueyuan Road, Haidian District, Beijing, 100191, China  
Tel: +86-10-62304633-2512 Fax: +86-10-62304633-2504  
E-mail: cttl@chinattl.com [Http://www.chinattl.cn](http://www.chinattl.cn)

Client : **SGS**

Certificate No: **Z18-60503**

## CALIBRATION CERTIFICATE

Object **DAE3 - SN: 414**

Calibration Procedure(s) **FF-Z11-002-01  
Calibration Procedure for the Data Acquisition Electronics  
(DAEx)**

Calibration date: **December 03, 2018**

This calibration Certificate documents the traceability to national standards, which realize the physical units of measurements(SI). The measurements and the uncertainties with confidence probability are given on the following pages and are part of the certificate.

All calibrations have been conducted in the closed laboratory facility: environment temperature(22±3)°C and humidity<70%.

Calibration Equipment used (M&TE critical for calibration)

Primary Standards	ID #	Cal Date(Calibrated by, Certificate No.)	Scheduled Calibration
Process Calibrator 753	1971018	20-Jun-18 (CTTL, No.J18X05034)	June-19

	Name	Function	Signature
Calibrated by:	Yu Zongying	SAR Test Engineer	
Reviewed by:	Lin Hao	SAR Test Engineer	
Approved by:	Qi Dianyuan	SAR Project Leader	

Issued: December 05, 2018

This calibration certificate shall not be reproduced except in full without written approval of the laboratory.



In Collaboration with

**s p e a g**  
**CALIBRATION LABORATORY**

Add: No.51 Xueyuan Road, Haidian District, Beijing, 100191, China  
Tel: +86-10-62304633-2512 Fax: +86-10-62304633-2504  
E-mail: cttl@chinattl.com Http://www.chinattl.cn

### **Glossary:**

DAE data acquisition electronics  
Connector angle information used in DASY system to align probe sensor X to the robot coordinate system.

### **Methods Applied and Interpretation of Parameters:**

- *DC Voltage Measurement:* Calibration Factor assessed for use in DASY system by comparison with a calibrated instrument traceable to national standards. The figure given corresponds to the full scale range of the voltmeter in the respective range.
- *Connector angle:* The angle of the connector is assessed measuring the angle mechanically by a tool inserted. Uncertainty is not required.
- The report provide only calibration results for DAE, it does not contain other performance test results.



Add: No.51 Xueyuan Road, Haidian District, Beijing, 100191, China  
Tel: +86-10-62304633-2512 Fax: +86-10-62304633-2504  
E-mail: cttl@chinattl.com Http://www.chinattl.cn

### DC Voltage Measurement

A/D - Converter Resolution nominal

High Range: 1LSB = 6.1 $\mu$ V, full range = -100...+300 mV

Low Range: 1LSB = 61nV, full range = -1.....+3mV

DASY measurement parameters: Auto Zero Time: 3 sec; Measuring time: 3 sec

Calibration Factors	X	Y	Z
High Range	404.470 $\pm$ 0.15% (k=2)	404.356 $\pm$ 0.15% (k=2)	404.354 $\pm$ 0.15% (k=2)
Low Range	3.96006 $\pm$ 0.7% (k=2)	3.97507 $\pm$ 0.7% (k=2)	3.95370 $\pm$ 0.7% (k=2)

### Connector Angle

Connector Angle to be used in DASY system	325 $^{\circ}$ $\pm$ 1 $^{\circ}$
---	-----------------------------------



Add: No.51 Xueyuan Road, Haidian District, Beijing, 100191, China  
Tel: +86-10-62304633-2512 Fax: +86-10-62304633-2504  
E-mail: cttl@chinattl.com Http://www.chinattl.cn

Client **SGS**

Certificate No: **Z19-60063**

## CALIBRATION CERTIFICATE

Object **EX3DV4 - SN:3793**

Calibration Procedure(s) **FF-Z11-004-01**  
**Calibration Procedures for Dosimetric E-field Probes**

Calibration date: **March 25, 2019**

This calibration Certificate documents the traceability to national standards, which realize the physical units of measurements(SI). The measurements and the uncertainties with confidence probability are given on the following pages and are part of the certificate.

All calibrations have been conducted in the closed laboratory facility: environment temperature(22±3)°C and humidity<70%.

Calibration Equipment used (M&TE critical for calibration)

Primary Standards	ID #	Cal Date(Calibrated by, Certificate No.)	Scheduled Calibration
Power Meter NRP2	101919	20-Jun-18 (CTTL, No.J18X05032)	Jun-19
Power sensor NRP-Z91	101547	20-Jun-18 (CTTL, No.J18X05032)	Jun-19
Power sensor NRP-Z91	101548	20-Jun-18 (CTTL, No.J18X05032)	Jun-19
Reference10dBAttenuator	18N50W-10dB	09-Feb-18(CTTL, No.J18X01133)	Feb-20
Reference20dBAttenuator	18N50W-20dB	09-Feb-18(CTTL, No.J18X01132)	Feb-20
Reference Probe EX3DV4	SN 7514	27-Aug-18(SPEAG,No.EX3-7514_Aug18/2)	Aug-19
DAE4	SN 1555	20-Aug-18(SPEAG, No.DAE4-1555_Aug18)	Aug -19
Secondary Standards	ID #	Cal Date(Calibrated by, Certificate No.)	Scheduled Calibration
SignalGeneratorMG3700A	6201052605	21-Jun-18 (CTTL, No.J18X05033)	Jun-19
Network Analyzer E5071C	MY46110673	24-Jan-19 (CTTL, No.J19X00547)	Jan -20

	Name	Function	Signature
Calibrated by:	Yu Zongying	SAR Test Engineer	
Reviewed by:	Lin Hao	SAR Test Engineer	
Approved by:	Qi Dianyuan	SAR Project Leader	

Issued: March 27, 2019

This calibration certificate shall not be reproduced except in full without written approval of the laboratory.



### Glossary:

TSL	tissue simulating liquid
NORM <sub>x,y,z</sub>	sensitivity in free space
ConvF	sensitivity in TSL / NORM <sub>x,y,z</sub>
DCP	diode compression point
CF	crest factor (1/duty_cycle) of the RF signal
A,B,C,D	modulation dependent linearization parameters
Polarization $\Phi$	$\Phi$ rotation around probe axis
Polarization $\theta$	$\theta$ rotation around an axis that is in the plane normal to probe axis (at measurement center), $\theta=0$ is normal to probe axis

Connector Angle information used in DASY system to align probe sensor X to the robot coordinate system

### Calibration is Performed According to the Following Standards:

- IEEE Std 1528-2013, "IEEE Recommended Practice for Determining the Peak Spatial-Averaged Specific Absorption Rate (SAR) in the Human Head from Wireless Communications Devices: Measurement Techniques", June 2013
- IEC 62209-1, "Measurement procedure for the assessment of Specific Absorption Rate (SAR) from hand-held and body-mounted devices used next to the ear (frequency range of 300 MHz to 6 GHz)", July 2016
- IEC 62209-2, "Procedure to determine the Specific Absorption Rate (SAR) for wireless communication devices used in close proximity to the human body (frequency range of 30 MHz to 6 GHz)", March 2010
- KDB 865664, "SAR Measurement Requirements for 100 MHz to 6 GHz"

### Methods Applied and Interpretation of Parameters:

- NORM<sub>x,y,z</sub>**: Assessed for E-field polarization  $\theta=0$  ( $f \leq 900$  MHz in TEM-cell;  $f > 1800$  MHz: waveguide). NORM<sub>x,y,z</sub> are only intermediate values, i.e., the uncertainties of NORM<sub>x,y,z</sub> does not effect the  $E^2$ -field uncertainty inside TSL (see below ConvF).
- NORM(f)<sub>x,y,z</sub>** = NORM<sub>x,y,z</sub> \* frequency\_response (see Frequency Response Chart). This linearization is implemented in DASY4 software versions later than 4.2. The uncertainty of the frequency response is included in the stated uncertainty of ConvF.
- DCP<sub>x,y,z</sub>**: DCP are numerical linearization parameters assessed based on the data of power sweep (no uncertainty required). DCP does not depend on frequency nor media.
- PAR**: PAR is the Peak to Average Ratio that is not calibrated but determined based on the signal characteristics.
- A<sub>x,y,z</sub>; B<sub>x,y,z</sub>; C<sub>x,y,z</sub>; VR<sub>x,y,z</sub>**: A,B,C are numerical linearization parameters assessed based on the data of power sweep for specific modulation signal. The parameters do not depend on frequency nor media. VR is the maximum calibration range expressed in RMS voltage across the diode.
- ConvF and Boundary Effect Parameters**: Assessed in flat phantom using E-field (or Temperature Transfer Standard for  $f \leq 800$  MHz) and inside waveguide using analytical field distributions based on power measurements for  $f > 800$  MHz. The same setups are used for assessment of the parameters applied for boundary compensation (alpha, depth) of which typical uncertainty valued are given. These parameters are used in DASY4 software to improve probe accuracy close to the boundary. The sensitivity in TSL corresponds to NORM<sub>x,y,z</sub> \* ConvF whereby the uncertainty corresponds to that given for ConvF. A frequency dependent ConvF is used in DASY version 4.4 and higher which allows extending the validity from  $\pm 50$  MHz to  $\pm 100$  MHz.
- Spherical isotropy (3D deviation from isotropy)**: in a field of low gradients realized using a flat phantom exposed by a patch antenna.
- Sensor Offset**: The sensor offset corresponds to the offset of virtual measurement center from the probe tip (on probe axis). No tolerance required.
- Connector Angle**: The angle is assessed using the information gained by determining the NORM<sub>x</sub> (no uncertainty required).



In Collaboration with  
**s p e a g**  
**CALIBRATION LABORATORY**

Add: No.51 Xueyuan Road, Haidian District, Beijing, 100191, China  
Tel: +86-10-62304633-2512 Fax: +86-10-62304633-2504  
E-mail: [ctl@chinattl.com](mailto:ctl@chinattl.com) [Http://www.chinattl.cn](http://www.chinattl.cn)

# Probe EX3DV4

## SN: 3793

Calibrated: March 25, 2019

Calibrated for DASY/EASY Systems

(Note: non-compatible with DASY2 system!)



## DASY/EASY – Parameters of Probe: EX3DV4 – SN: 3793

### Basic Calibration Parameters

	Sensor X	Sensor Y	Sensor Z	Unc (k=2)
Norm( $\mu\text{V}/(\text{V}/\text{m})^2$ ) <sup>A</sup>	0.48	0.46	0.47	$\pm 10.0\%$
DCP(mV) <sup>B</sup>	102.1	104.4	103.4	

### Modulation Calibration Parameters

UID	Communication System Name		A dB	B dB $\sqrt{\mu\text{V}}$	C	D dB	VR mV	Unc <sup>E</sup> (k=2)
0	CW	X	0.0	0.0	1.0	0.00	166.6	$\pm 2.5\%$
		Y	0.0	0.0	1.0		162.7	
		Z	0.0	0.0	1.0		164.4	

The reported uncertainty of measurement is stated as the standard uncertainty of Measurement multiplied by the coverage factor k=2, which for a normal distribution Corresponds to a coverage probability of approximately 95%.

<sup>A</sup> The uncertainties of Norm X, Y, Z do not affect the E<sup>2</sup>-field uncertainty inside TSL (see Page 5 and Page 6).

<sup>B</sup> Numerical linearization parameter: uncertainty not required.

<sup>E</sup> Uncertainty is determined using the max. deviation from linear response applying rectangular distribution and is expressed for the square of the field value.



## DASY/EASY – Parameters of Probe: EX3DV4 – SN: 3793

### Calibration Parameter Determined in Head Tissue Simulating Media

f [MHz] <sup>C</sup>	Relative Permittivity <sup>F</sup>	Conductivity (S/m) <sup>F</sup>	ConvF X	ConvF Y	ConvF Z	Alpha <sup>G</sup>	Depth <sup>G</sup> (mm)	Unct. (k=2)
750	41.9	0.89	9.41	9.41	9.41	0.11	1.39	± 12.1%
835	41.5	0.90	9.04	9.04	9.04	0.07	1.80	± 12.1%
1750	40.1	1.37	7.85	7.85	7.85	0.20	1.15	± 12.1%
1900	40.0	1.40	7.54	7.54	7.54	0.28	0.99	± 12.1%
2450	39.2	1.80	6.93	6.93	6.93	0.63	0.70	± 12.1%
2600	39.0	1.96	6.78	6.78	6.78	0.52	0.78	± 12.1%
3500	37.9	2.91	6.43	6.43	6.43	0.65	0.92	± 13.3%
3700	37.7	3.12	6.34	6.34	6.34	0.65	0.85	± 13.3%

<sup>C</sup> Frequency validity above 300 MHz of ±100MHz only applies for DASY v4.4 and higher (Page 2), else it is restricted to ±50MHz. The uncertainty is the RSS of ConvF uncertainty at calibration frequency and the uncertainty for the indicated frequency band. Frequency validity below 300 MHz is ± 10, 25, 40, 50 and 70 MHz for ConvF assessments at 30, 64, 128, 150 and 220 MHz respectively. Above 5 GHz frequency validity can be extended to ± 110 MHz.

<sup>F</sup> At frequency below 3 GHz, the validity of tissue parameters ( $\epsilon$  and  $\sigma$ ) can be relaxed to ±10% if liquid compensation formula is applied to measured SAR values. At frequencies above 3 GHz, the validity of tissue parameters ( $\epsilon$  and  $\sigma$ ) is restricted to ±5%. The uncertainty is the RSS of the ConvF uncertainty for indicated target tissue parameters.

<sup>G</sup> Alpha/Depth are determined during calibration. SPEAG warrants that the remaining deviation due to the boundary effect after compensation is always less than ± 1% for frequencies below 3 GHz and below ± 2% for the frequencies between 3-6 GHz at any distance larger than half the probe tip diameter from the boundary.



## DASY/EASY – Parameters of Probe: EX3DV4 – SN: 3793

### Calibration Parameter Determined in Body Tissue Simulating Media

f [MHz] <sup>C</sup>	Relative Permittivity <sup>F</sup>	Conductivity (S/m) <sup>F</sup>	ConvF X	ConvF Y	ConvF Z	Alpha <sup>G</sup>	Depth <sup>G</sup> (mm)	Unct. (k=2)
750	55.5	0.96	9.43	9.43	9.43	0.40	0.80	±12.1%
835	55.2	0.97	9.11	9.11	9.11	0.19	1.35	±12.1%
1750	53.4	1.49	7.56	7.56	7.56	0.20	1.19	±12.1%
1900	53.3	1.52	7.41	7.41	7.41	0.21	1.18	±12.1%
2450	52.7	1.95	7.12	7.12	7.12	0.60	0.75	±12.1%
2600	52.5	2.16	6.87	6.87	6.87	0.67	0.70	±12.1%
3500	51.3	3.31	6.23	6.23	6.23	0.52	1.08	±13.3%
3700	51.0	3.55	6.15	6.15	6.15	0.52	1.05	±13.3%

<sup>C</sup> Frequency validity above 300 MHz of ±100MHz only applies for DASY v4.4 and higher (Page 2), else it is restricted to ±50MHz. The uncertainty is the RSS of ConvF uncertainty at calibration frequency and the uncertainty for the indicated frequency band. Frequency validity below 300 MHz is ± 10, 25, 40, 50 and 70 MHz for ConvF assessments at 30, 64, 128, 150 and 220 MHz respectively. Above 5 GHz frequency validity can be extended to ± 110 MHz.

<sup>F</sup> At frequency below 3 GHz, the validity of tissue parameters ( $\epsilon$  and  $\sigma$ ) can be relaxed to ±10% if liquid compensation formula is applied to measured SAR values. At frequencies above 3 GHz, the validity of tissue parameters ( $\epsilon$  and  $\sigma$ ) is restricted to ±5%. The uncertainty is the RSS of the ConvF uncertainty for indicated target tissue parameters.

<sup>G</sup> Alpha/Depth are determined during calibration. SPEAG warrants that the remaining deviation due to the boundary effect after compensation is always less than ± 1% for frequencies below 3 GHz and below ± 2% for the frequencies between 3-6 GHz at any distance larger than half the probe tip diameter from the boundary.



## Frequency Response of E-Field (TEM-Cell: ifi110 EXX, Waveguide: R22)

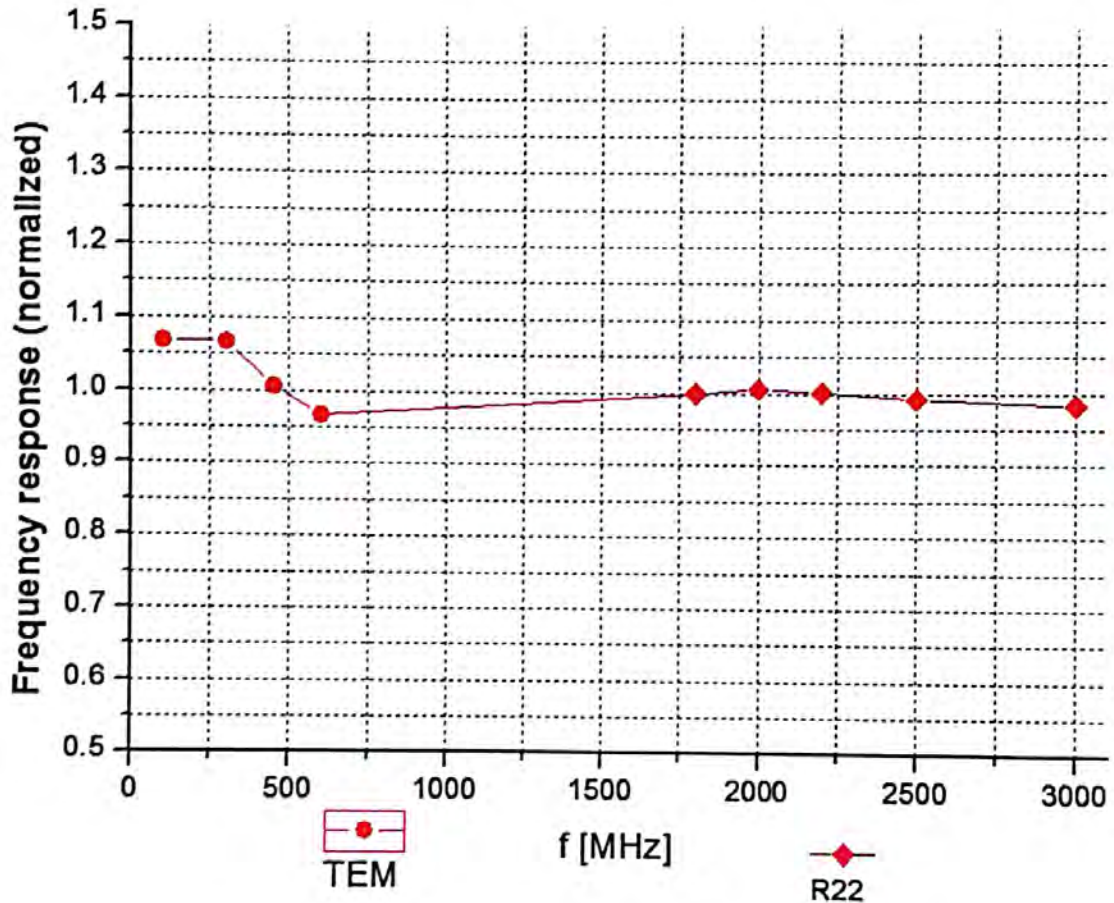

Uncertainty of Frequency Response of E-field:  $\pm 7.4\%$  ( $k=2$ )



## Receiving Pattern ( $\Phi$ ), $\theta=0^\circ$

**f=600 MHz, TEM**

**f=1800 MHz, R22**

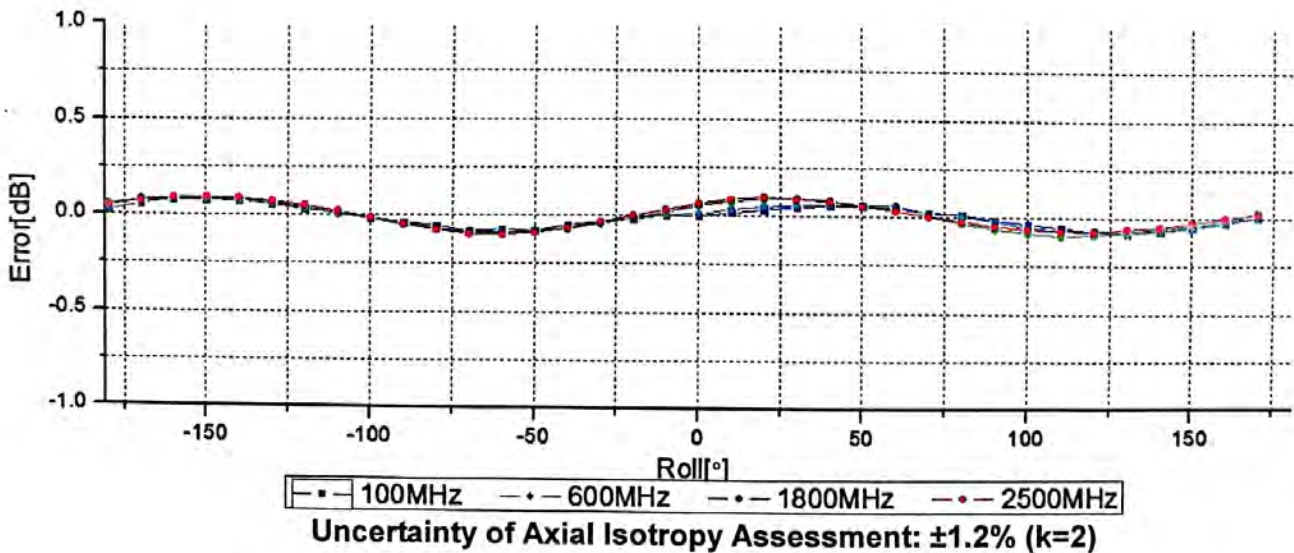
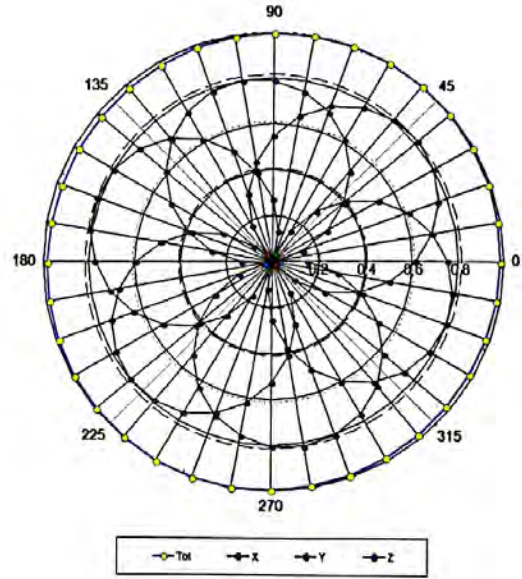
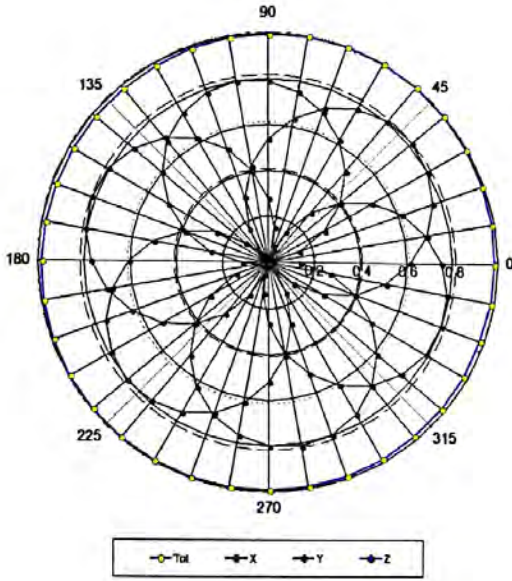



### Dynamic Range $f(\text{SAR}_{\text{head}})$ (TEM cell, $f = 900 \text{ MHz}$ )

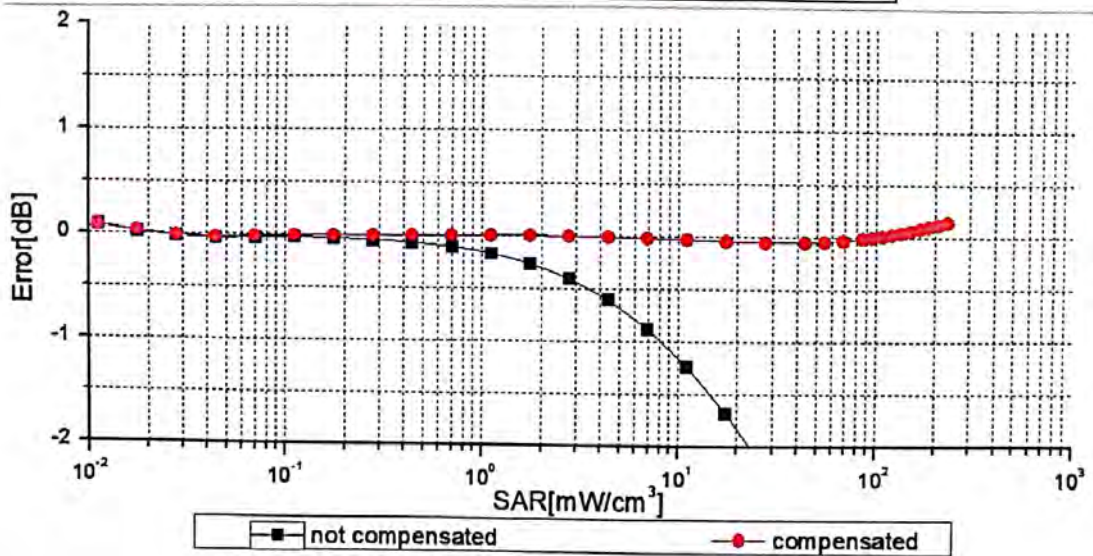
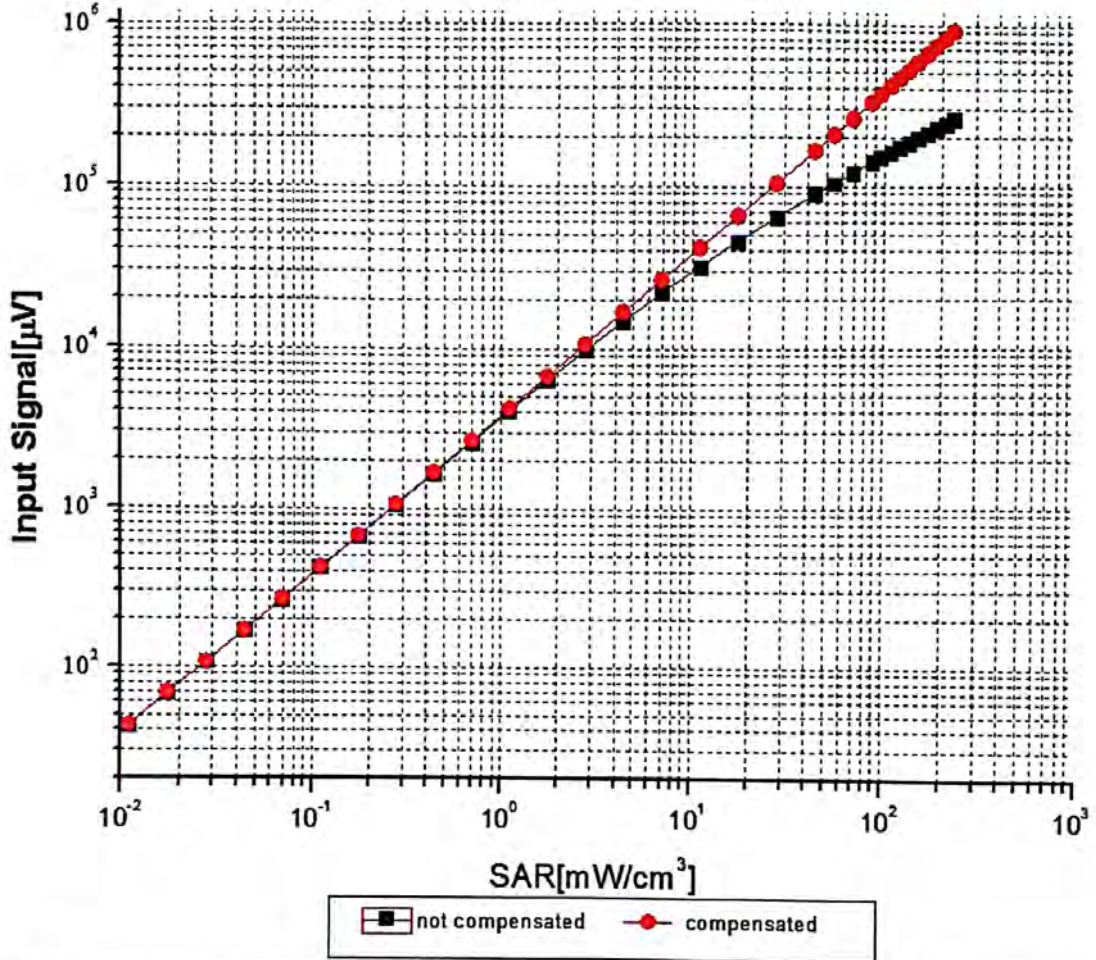

Uncertainty of Linearity Assessment:  $\pm 0.9\%$  ( $k=2$ )



## Conversion Factor Assessment

f=750 MHz, WGLS R9(H\_convF)

f=1750 MHz, WGLS R22(H\_convF)

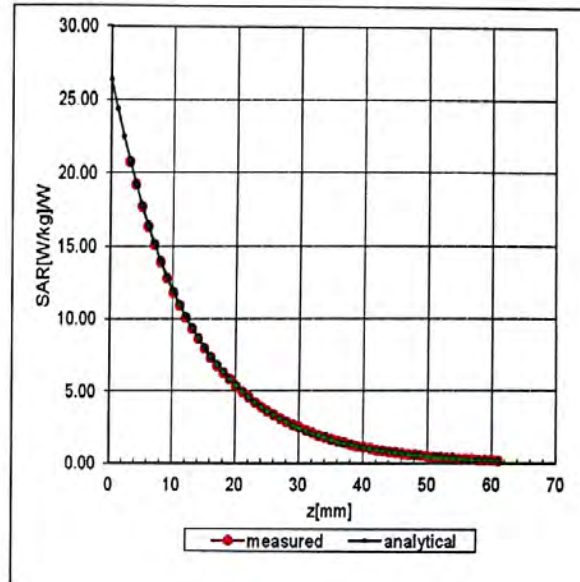
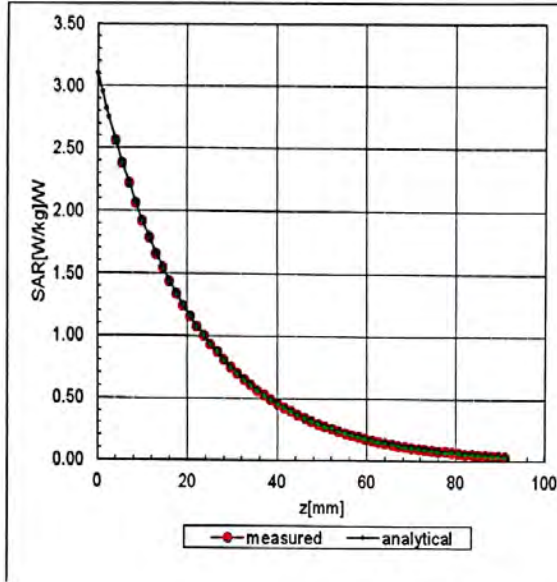

## Deviation from Isotropy in Liquid

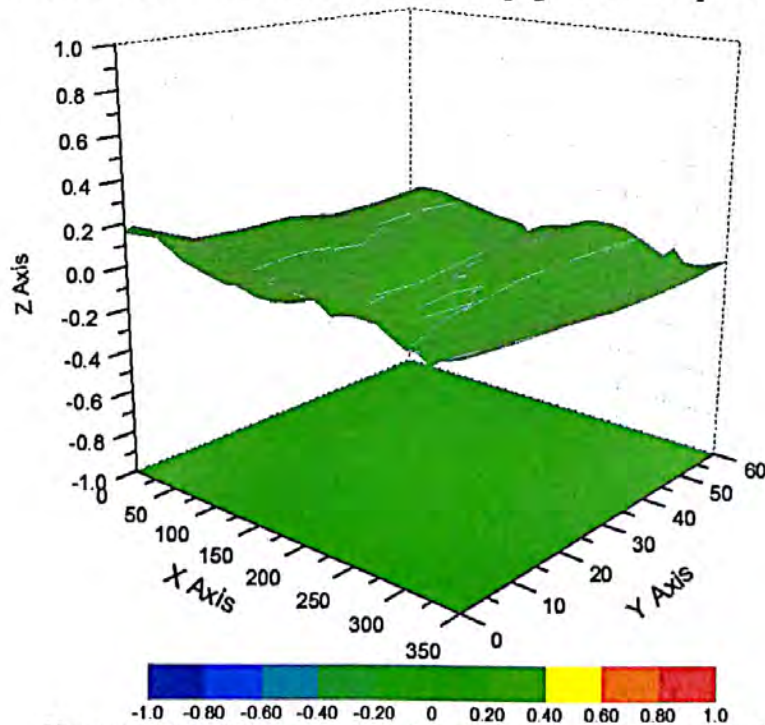



## DASY/EASY – Parameters of Probe: EX3DV4 – SN: 3793

### Other Probe Parameters

<b>Sensor Arrangement</b>	<b>Triangular</b>
<b>Connector Angle (°)</b>	<b>117.4</b>
<b>Mechanical Surface Detection Mode</b>	<b>enabled</b>
<b>Optical Surface Detection Mode</b>	<b>disable</b>
<b>Probe Overall Length</b>	<b>337mm</b>
<b>Probe Body Diameter</b>	<b>10mm</b>
<b>Tip Length</b>	<b>9mm</b>
<b>Tip Diameter</b>	<b>2.5mm</b>
<b>Probe Tip to Sensor X Calibration Point</b>	<b>1mm</b>
<b>Probe Tip to Sensor Y Calibration Point</b>	<b>1mm</b>
<b>Probe Tip to Sensor Z Calibration Point</b>	<b>1mm</b>
<b>Recommended Measurement Distance from Surface</b>	<b>1.4mm</b>

Dipole D2450V2 SN 733				
Head Liquid				
Date of Measurement	Return Loss(dB)	$\Delta$ %	Impedance ( $\Omega$ )	$\Delta\Omega$
2016-12-07	-26.3	/	52.9	/
2017-12-06	-27.5	4.56%	56.1	3.2 $\Omega$
2018-12-05	-27.1	3.04%	55.7	2.8 $\Omega$
Body Liquid				
Date of Measurement	Return Loss(dB)	$\Delta$ %	Impedance ( $\Omega$ )	$\Delta\Omega$
2016-12-07	-24.6	/	49.7	/
2017-12-06	-25.3	2.85%	51.8	2.1 $\Omega$
2018-12-05	-25.1	2.03%	52.1	2.4 $\Omega$



# Appendix D

## Photographs

1. SAR measurement System
2. Photographs of Tissue Simulate Liquid
3. Photographs of EUT test position
4. EUT Constructional Details
5. Serial Number of EUT





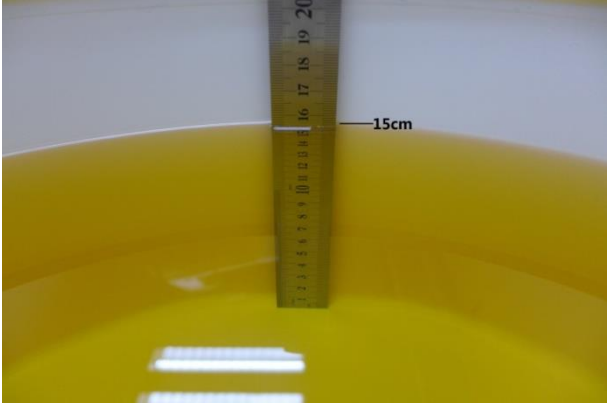

## 1. SAR measurement System





## 2. Photographs of Tissue Simulate Liquid

Photo 1: Tissue Simulant Liquid for Body 2450	NA
	NA

### 3. Photographs of EUT test position

<p><b>Photo 2: Front side 0mm</b></p>	<p><b>Photo 3: Back side 0mm</b></p>
	
<p><b>Photo 4: Left side 0mm</b></p>	<p><b>Photo 5: Right side 0mm</b></p>
	
<p><b>Photo 6: Top side 0mm</b></p>	<p><b>Photo 7: Bottom side 0mm</b></p>
	

### 4. EUT Constructional Details

<p align="center"><b>Photo 8: Front View</b></p>	<p align="center"><b>Photo 9: Back View</b></p>
	
<p align="center"><b>Photo 10: Accessory</b></p>	<p align="center">NA</p>
	<p align="center">NA</p>