

TEST REPORT

Report Number: 17110447HKG-001

Application for Original Grant of 47 CFR Part 15 Certification

New Single of RSS-247 Issue 2 Equipment

FCC ID: EW780-0619-00

IC: 1135B-80061900

PREPARED AND CHECKED BY:

APPROVED BY:

Signed On File
Yao Xin Lu, Josie
Engineer

Tang Kwan Mo, Jess
Lead Engineer
Date: December 19, 2017

Intertek's standard Terms and Conditions can be obtained at our website <http://www.intertek.com/terms/>.

The test report only allows to be revised within the retention period unless further standard or the requirement was noticed

This report is for the exclusive use of Intertek's Client and is provided pursuant to the agreement between Intertek and its Client. Intertek's responsibility and liability are limited to the terms and conditions of the agreement. Intertek assumes no liability to any party, other than to the Client in accordance with the agreement, for any loss, expense or damage occasioned by the use of this report. Only the Client is authorized to permit copying or distribution of this report and then only in its entirety. Any use of the Intertek name or one of its marks for the sale or advertisement of the tested material, product or service must first be approved in writing by Intertek. The observations and test results in this report are relevant only to the sample tested. This report by itself does not imply that the material, product, or service is or has ever been under an Intertek certification program.

© 2017 Intertek

TEST REPORT**GENERAL INFORMATION**

Applicant Name:	VTech Telecommunications Ltd.
Applicant Address:	23/F., Tai Ping Industrial Centre, Block 1, 57 Ting Kok Road, Tai Po, Hong Kong.
FCC Specification Standard:	FCC Part 15, October 1, 2016 Edition
FCC ID:	EW780-0619-00
FCC Model(s):	VM4261 BU VM4261-2 BU, VM4x61-ab BU, VM4221 BU, VM4261-ab BU
IC Specification Standard:	RSS-247 Issue 2, February 2017 RSS-Gen Issue 4, December 2014
IC:	1135B-80061900
HVIN:	35-400177BU
IC Model(s):	VM4261 BU VM4261-2 BU, VM4x61-ab BU, VM4221 BU, VM4261-ab BU
PMN:	Full Color Video Monitor with Wide-angle Lens
Type of EUT:	Spread Spectrum Transmitter
Description of EUT:	Full Color Video Monitor with Wide-angle Lens- Baby Unit
Serial Number:	N/A
Sample Receipt Date:	November 13, 2017
Date of Test:	November 15, 2017 to December 15, 2017
Report Date:	December 19, 2017
Environmental Conditions:	Temperature: +10 to 40°C Humidity: 10 to 90%

TEST REPORT

TABLE OF CONTENTS

1.0 Test Results Summary & Statement of Compliance..... 4

 1.1 Summary of Test Results 4

 1.2 Statement of Compliance..... 4

2.0 General Description..... 5

 2.1 Product Description 5

 2.3 Test Methodology..... 5

 2.4 Test Facility 5

3.0 System Test Configuration..... 6

 3.1 Justification 6

 3.2 EUT Exercising Software..... 7

 3.3 Details of EUT and Description of Accessories..... 8

 3.4 Measurement Uncertainty..... 8

4.0 Test Results..... 9

 4.1 Maximum Conducted Output Power at Antenna Terminals 9

 4.2 Maximum 20 dB RF Bandwidth 12

 4.3 Minimum Number of Hopping Frequencies 15

 4.4 Minimum Hopping Channel Carrier Frequency Separation 17

 4.5 Average Channel Occupancy Time 19

 4.6 Out of Band Conducted Emissions 22

 4.7 Field Strength Calculation 27

 4.8 Transmitter Radiated Emissions in Restricted Bands and Spurious Emissions 28

 4.8.1 Radiated Emission Configuration Photograph 29

 4.8.2 Radiated Emission Data..... 29

 4.8.4 Radiated Emission Test Setup 30

 4.8.3 Transmitter Duty Cycle Calculation 39

 4.9 AC Power Line Conducted Emission 41

 4.9.1 AC Power Line Conducted Emission Configuration Photograph 41

 4.9.2 AC Power Line Conducted Emission Data 41

 4.9.3 AC Line Conducted Emission Test Setup..... 46

5.0 Equipment List..... 47

TEST REPORT

EXHIBIT 1 TEST RESULTS SUMMARY & STATEMENT OF COMPLIANCE

1.0 TEST RESULTS SUMMARY & STATEMENT OF COMPLIANCE

1.1 Summary of Test Results

TEST ITEMS	FCC PART 15 SECTION	RSS-247/ RSS-GEN# SECTION	RESULTS	DETAILS SEE SECTION
Antenna Requirement	15.203	8.3 [#]	Pass	2.1
Max. Conducted Output Power	15.247(b)(1) & (4)	5.4(2)	Pass	4.1
Max. 20dB RF Bandwidth	N/A	5.1(1)	N/A	4.2
Min. No. of Hopping Frequencies	15.247(a)(1)(iii)	5.1(4)	Pass	4.3
Min. Hopping Channel Carrier Frequency Separation	15.247(a)(1)	5.1(2)	Pass	4.4
Average Time of Occupancy	15.247(a)(1)(iii)	5.1(4)	Pass	4.5
Out of Band Antenna Conducted Emission	15.247(d)	5.5	Pass	4.6
Radiated Emission in Restricted Bands and Spurious Emissions	15.247(d)	8.10 [#]	Pass	4.8
AC Power Line Conducted Emission	15.207 & 15.107	8.8 [#]	Pass	4.9

Note: Pursuant to FCC Part 15 Section 15.215(c), the 20dB bandwidth of the emission was contained within the frequency band designated (mentioned as above) which the EUT operated. The effects, if any, from frequency sweeping, frequency hopping, other modulation techniques and frequency stability over expected variations in temperature and supply voltage were considered.

1.2 Statement of Compliance

The equipment under test is found to be complying with the following standards:

- FCC Part 15, October 1, 2016 Edition
- RSS-247 Issue 2, February 2017
- RSS-Gen Issue 4, November 2014

TEST REPORT

EXHIBIT 2 GENERAL DESCRIPTION

2.0 GENERAL DESCRIPTION

2.1 Product Description

The VM4261 BU is a Full Color Video Monitor with Wide-angle Lens- Baby Unit.

The Equipment Under Test (EUT) operates at frequency range of 2405MHz to 2475MHz. There are totally 32 non-overlapping channels with 2MHz channel separation and 17 active channels out of the 32 channels.

The EUT is powered by a 100-240 AC adaptor.

The antenna used in the EUT is integral, and the test sample is a prototype.

For FCC, the Model(s): VM4261-2 BU, VM4x61-ab BU, VM4221 BU and VM4261-ab BU are the same as the Model: VM4261 BU in electronics/electrical designs including software & firmware, PCB layout and construction design/physical design/enclosure. The only differences between these models are color and model number to be sold for marketing purpose. Suffix (a,b,x) indicates different type packaging, different number of baby unit, and different color of enclosure.

For IC, the Model(s): VM4261-2 BU, VM4x61-ab BU, VM4221 BU and VM4261-ab BU are the same as the Model: VM4261 BU in electronics/electrical designs including software & firmware, PCB layout and construction design/physical design/enclosure. The only differences between these models are color and model number to be sold for marketing purpose. Suffix (a,b,x) indicates different type packaging, different number of baby unit, and different color of enclosure.

The circuit description and frequency hopping algorithm are attached in the Appendix and saved with filename: descri.pdf.

2.2 Test Methodology

Both AC power line-conducted and radiated emission measurements were performed according to the procedures in ANSI C63.10 (2013). Preliminary radiated scans and all radiated measurements were performed in radiated emission test sites. All Radiated tests were performed at an antenna to EUT distance of 3 meters, unless stated otherwise in the "**Justification Section**" of this Application. Antenna port conducted measurements were performed according to ANSI C63.10 (2013). All other measurements were made in accordance with the procedures in 47 CFR Part 2.

2.3 Test Facility

The radiated emission test site, AC power line conducted measurement facility and antenna port conducted measurement facility used to collect the radiated data, AC Power Line conducted data, and conductive data are at Intertek Testing Services Hong Kong Ltd., which is located at Workshop No. 3, G/F., World-Wide Industrial Centre, 43-47 Shan Mei Street, Fo Tan, Sha Tin, N.T., Hong Kong. This test facility and site measurement data have been fully placed on file with FCC and Industry Canada No. 2042V.

TEST REPORT

EXHIBIT 3 SYSTEM TEST CONFIGURATION

3.0 SYSTEM TEST CONFIGURATION

3.1 Justification

For radiated emissions testing, the equipment under test (EUT) was setup to transmit / receive continuously to simplify the measurement methodology. Care was taken to ensure proper power supply voltages during testing. During testing, all cables (if any) were manipulated to produce worst case emissions.

The EUT was powered by a 100-240 VAC adaptor.

For the measurements, the EUT was attached to a plastic stand if necessary and placed on the wooden turntable at 0.8m height from the ground plane for emission testing at or below 1GHz and 1.5m for emission measurements above 1GHz. If the baby unit attached to peripherals, they were connected and operational (as typical as possible). The parent unit was remotely located as far from the antenna and the baby as possible to ensure full power transmission from the parent unit. Else, the base was wired to transmit full power with modulation.

The signal was maximized through rotation and placement in the three orthogonal axes. The antenna height and polarization were varied during the search for maximum signal level. The antenna height was varied from 1 to 4 meters. Radiated emissions were taken at three meters unless the signal level was too low for measurement at that distance. If necessary, a pre-amplifier was used and/or the test was conducted at a closer distance.

For any intentional radiator powered by AC power line, measurements of the radiated signal level of the fundamental frequency component of the emission was performed with the supply voltage varied between 85% and 115% of the nominal rated supply voltage.

For transmitter radiated measurement, the spectrum analyzer resolution bandwidth was 100 kHz for frequencies below 1000 MHz. The resolution bandwidth was 1 MHz for frequencies above 1000 MHz.

Radiated emission measurement for transmitter were performed from the lowest radio frequency signal generated in the device which is greater than 9 kHz to the tenth harmonic of the highest fundamental frequency or to 40 GHz, whichever is lower.

TEST REPORT

3.1 Justification - Cont'd

Emission that are directly caused by digital circuits in the transmit path and transmitter portion were measured, and the limit are according to FCC Part 15 Section 15.209. Digital circuitry used to control additional functions other than the operation of the transmitter is subject to FCC Part Section 15.109 Limits.

Detector function for radiated emissions was in peak mode. Average readings, when required, were taken by measuring the duty cycle of the equipment under test and subtracting the corresponding amount in dB from the measured peak readings. A detailed description for the calculation of the average factor can be found in section 4.3.4.

Determination of pulse desensitization was made according to *Hewlett Packard Application Note 150-2, Spectrum Analysis... Pulsed RF*. The effective period (Teff) was referred to Exhibit 4.3.4. With the resolution bandwidth 1MHz and spectrum analyzer IF bandwidth 3dB, the pulse desensitization factor was 0dB.

For AC line conducted emission test, the EUT along with its peripherals were placed on a 1.0m(W)x1.5m(L) and 0.8m in height wooden table and the EUT was adjusted to maintain a 0.4 meter space from a vertical reference plane. The EUT was connected to power mains through a line impedance stabilization network (LISN), which provided 50ohm coupling impedance for measuring instrument. The LISN housing, measuring instrument case, reference ground plane, and vertical ground plane were bounded together. The excess power cable between the EUT and the LISN was bundled.

All connecting cables of EUT and peripherals were manipulated to find the maximum emission.

All relevant operation modes have been tested, and the worst case data is included in this report.

3.2 EUT Exercising Software

The EUT exercise program used during radiated and conducted testing was designed to exercise the various system components in a manner similar to a typical use.

TEST REPORT

3.3 Details of EUT and Description of Accessories

Details of EUT:

An AC adaptor (provided with the unit) was used to power the device. Their description are listed below.

- (1) An AC adaptor (100-240VAC 50/60Hz 150mA to 5.0VDC 800mA, Model: S005BNU0500080, Brand: TenPao) (Provided by Client)
- (2) An AC adaptor (100-240VAC 50/60Hz 200mA to 5.0VDC 800mA, Model: CS6F050080FU, Brand: Csec) (Provided by Client)

Description of Accessories:

- (1) Parent Unit, Model: VM4261 PU, FCC ID: EW780-0619-01 (Provided by Client)

3.4 Measurement Uncertainty

When determining of the test conclusion, the Measurement Uncertainty of test at a level of confidence of 95% has been considered. The values of the Measurement uncertainty for radiated emission test and RF conducted measurement test are $\pm 5.3\text{dB}$ and $\pm 0.99\text{dB}$ respectively. The value of the Measurement uncertainty for conducted emission test is $\pm 4.2\text{dB}$.

Uncertainty and Compliance - Unless the standard specifically states that measured values are to be extended by the measurement uncertainty in determining compliance, all compliance determinations are based on the actual measured value.

TEST REPORT

EXHIBIT 4 TEST RESULTS

4.0 TEST RESULTS

RF Conducted measurement Test Setup by a Spectrum Analyzer.

The figure below shows the test setup, which is utilized to make these measurements.

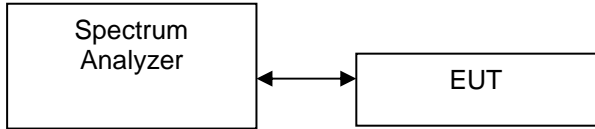

4.1 Maximum Conducted (peak) Output Power at Antenna Terminals

- The antenna power of the EUT was connected to the input of a power meter. Power was read directly and cable loss correction was added to the reading to obtain power at the EUT antenna terminals.
- The antenna port of the EUT was connected to the input of a spectrum analyzer. The analyzer was set for RBW>20dB bandwidth and power was read directly in dBm. External attenuation and cable loss were compensated for using the OFFSET function of the analyzer.

(Baby Unit) Antenna Gain = 0 dBi

Frequency (MHz)	Output in dBm	Output in mWatt
Low Channel: 2405	14.96	31.333
Middle Channel: 2441	14.78	30.061
High Channel: 2475	14.50	28.184

Cable loss : 0.5 dB External Attenuation : 20 dB

Cable loss, external attenuation: included in OFFSET function
 added to SA raw reading

dBm max. output level = 14.96 dBm

Limits:

- 0.125W (21dBm) for antennas with gains of 6dBi or less
- 0.25W (24dBm) for antennas with gains of 6dBi or less
- 1W (30dBm) for antennas with gains of 6dBi or less
- ___W (___dBm) for antennas with gains more than 6dBi

The plots of conducted output power are saved as below.

TEST REPORT

PLOTS OF CONDUCTED OUTPUT POWER

Lowest Channel

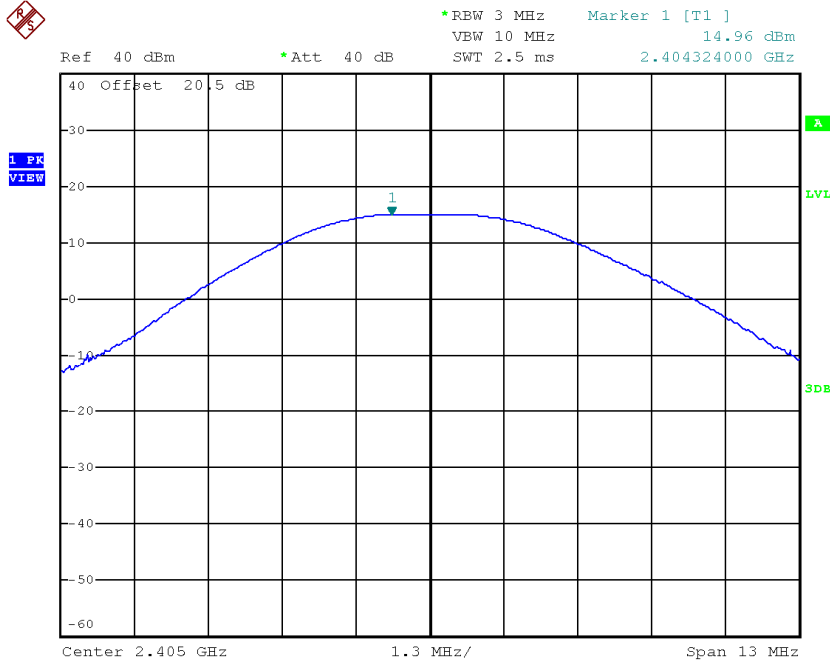

Middle Channel

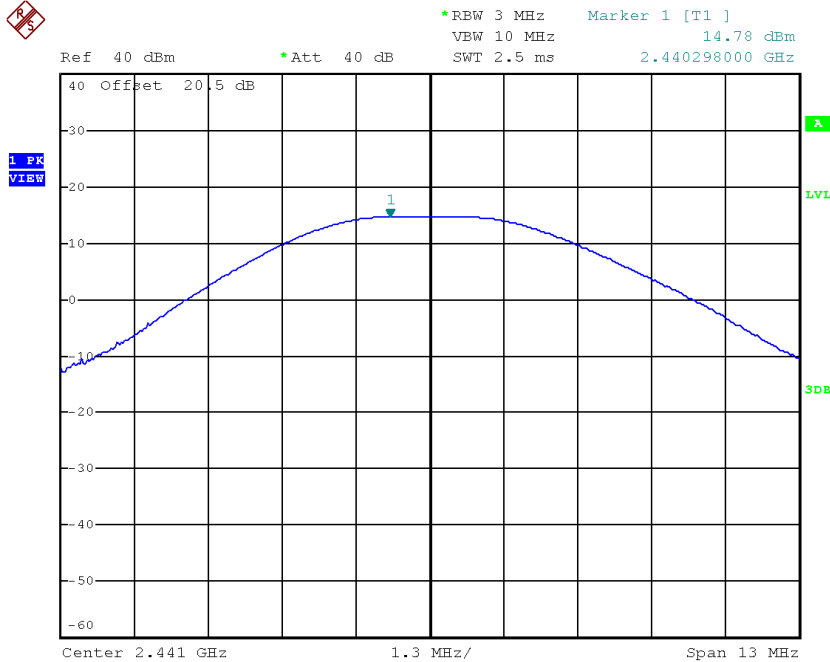

TEST REPORT

PLOTS OF CONDUCTED OUTPUT POWER

Highest Channel

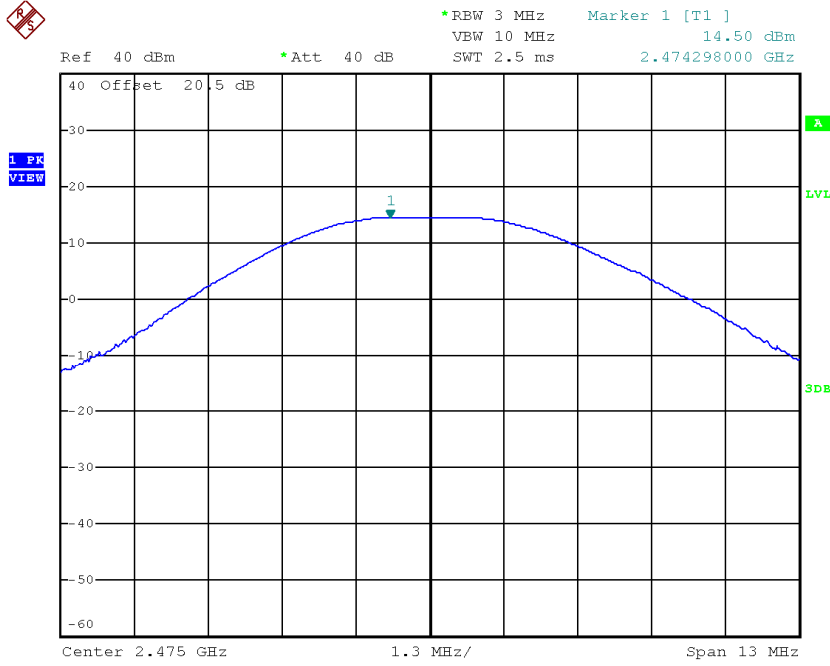

TEST REPORT

4.2 Maximum 20 dB RF Bandwidth

The antenna port of the EUT was connected to the input of a spectrum analyzer. Analyzer RES BW was chosen so that the display was a result of the hopping channel modulation. For each RF output channel investigated, the spectrum analyzer center frequency was set to the channel carrier. A PEAK output reading was taken, a DISPLAY line was drawn 20 dB lower than PEAK level. The 20 dB bandwidth was determined from where the channel output spectrum intersected the display line.

Baby Unit

	Frequency (MHz)	20 dB Bandwidth (kHz)
Low Channel:	2405	2544
Middle Channel:	2441	2484
High Channel:	2475	2532

Limits

- ≤500kHz for 902-928MHz
- N/A for 2400-2483.5MHz
- ≤1MHz for 5725-5850MHz

The plots of 20dB RF bandwidth are saved as below.

TEST REPORT

PLOTS OF 20dB RF BANDWIDTH

Lowest Channel

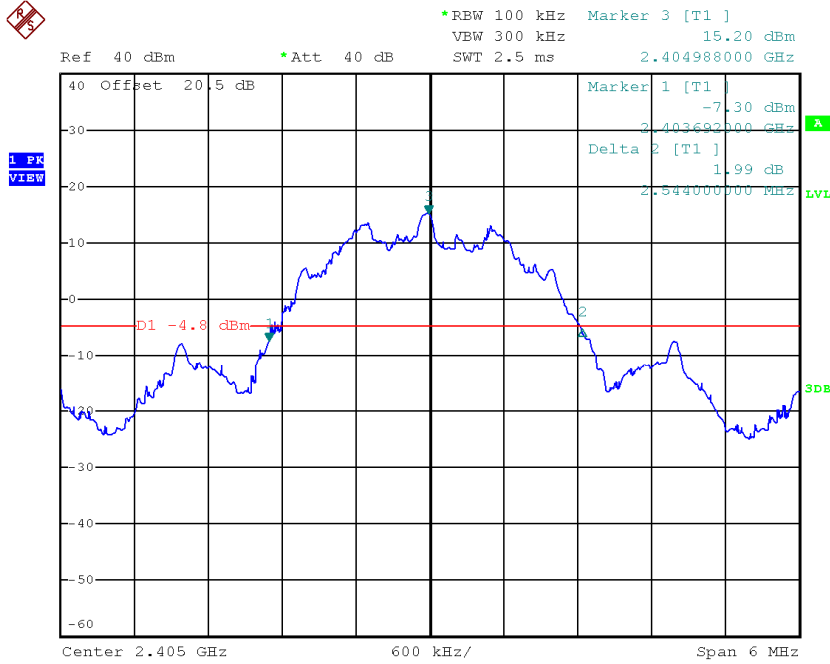

Middle Channel

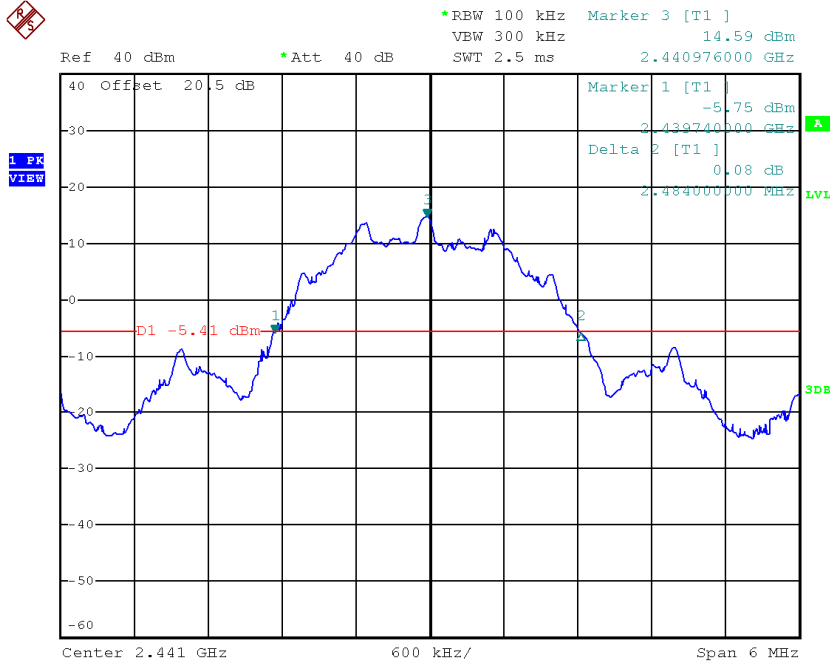

TEST REPORT

PLOTS OF 20dB RF BANDWIDTH

Highest Channel

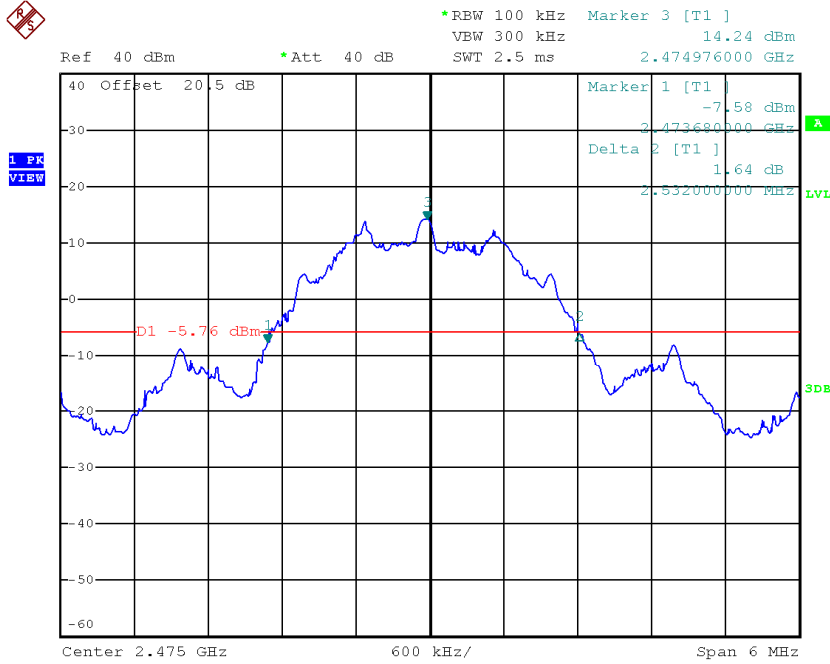

TEST REPORT

4.3 Minimum Number of Hopping Frequencies

With the analyzer set to MAX HOLD readings were taken for 2-3 minutes in each band. The channel peaks so recorded were added together, and the total number compared to the minimum number of channels required in the regulation.

Baby Unit	
No. of hopping channels	17

Minimum Requirements:

- at least 50 hopping channels for 902MHz-928MHz (20 dB bandwidth of hopping channel < 250kHz)
- at least 25 hopping channels for 902MHz-928MHz (20 dB bandwidth of hopping channel ≥ 250kHz)
- at least 15 hopping channels for 2400MHz-2483.5MHz.
- at least 75 hopping channels for 5725MHz-5850MHz.

The plots of number of hopping frequencies are saved as below.

TEST REPORT

PLOTS OF NUMBER OF HOPPING FREQUENCIES

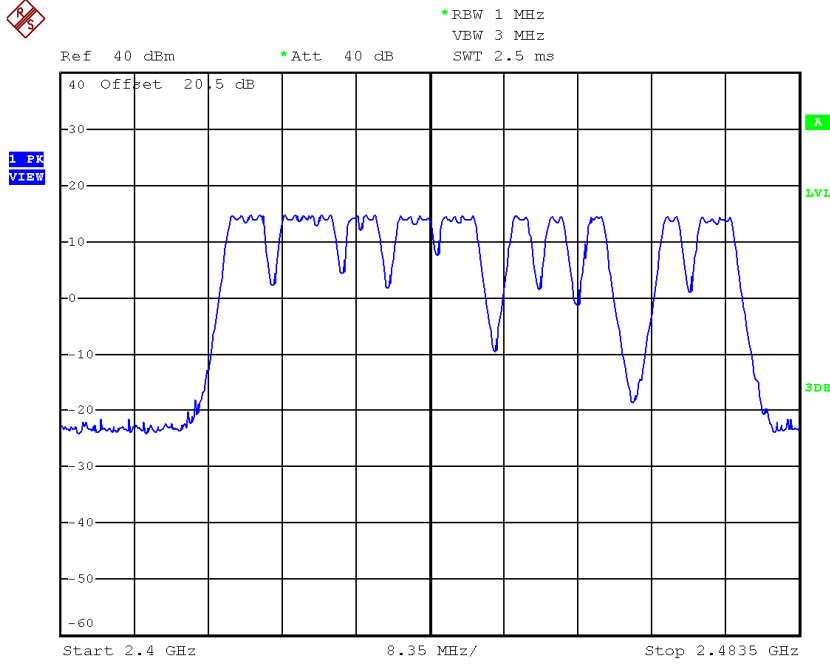

TEST REPORT**4.4 Minimum Hopping Channel Carrier Frequency Separation**

Using the DELTA MARKER function of the analyzer, the frequency separation between two adjacent channels was measured and met the requirement.

	Baby Unit
Channel Separation (Channel 15 and Channel 16)	2016 kHz

Limits:

The channel separation must be larger than:

- 25 kHz
- 20 dB bandwidth of hopping channel: ___ Hz
- 2/3 of 20dB bandwidth of hopping channel: 1696 kHz

The plot(s) of hopping channel carrier frequency separation is saved as below.

TEST REPORT

PLOTS OF HOPPING CHANNEL CARRIER FREQUENCY SEPARATION

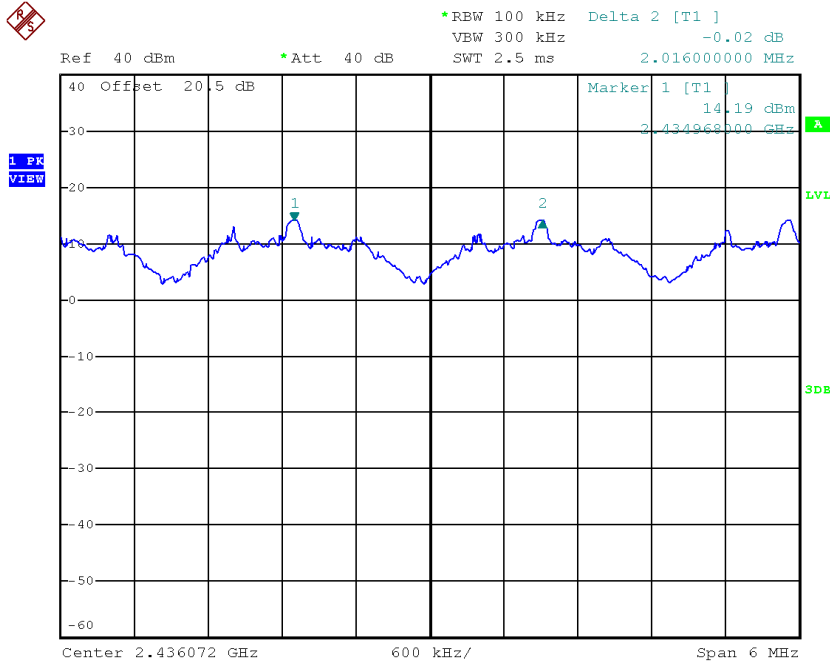

TEST REPORT

4.5 Average Channel Occupancy Time

The spectrum analyzer center frequency was set to one of the known hopping channels. The SWEEP was set to 1ms, the SPAN was set to ZERO SPAN, and the TRIGGER was set to VIDEO. The time duration of the transmission so captured was measured with the MARKER DELTA function.

The SWEEP was then set to the time required by the regulation (20 seconds for 902-928 MHz devices, if the 20dB bandwidth is less than 250kHz, 10 seconds for 902-928 MHz if the 20dB bandwidth is or greater than 250kHz, “0.4 seconds x Number of hopping channels employed” seconds for 2400-2483.5 MHz, 30 seconds for 5725-5850 MHz). The analyzer was set to SINGLE SWEEP, the total ON time was added and compared against the limit (0.4 seconds).

Baby Unit (worst-case: 1 parent unit operation)

Average Occupancy Time (Traffic – in a clear RF environment) =	1.1ms x 7 x 11 x 4 = 338.8ms
---	------------------------------

Limits:

Average 0.4 seconds maximum occupancy in:

- 6.8 seconds (0.4 sec. x 17) for 2400MHz-2483.5MHz
(Traffic – in a clear RF environment)
- 20 seconds for 902MHz-928MHz ≥ 50 hopping channels
- 10 seconds for 902MHz-928MHz ≥ 25 hopping channels
- 30 seconds for 5725-5850MHz

The plots of average channel occupancy time are saved as below.

TEST REPORT

PLOTS AVERAGE CHANNEL OCCUPANCY TIME

Plot A

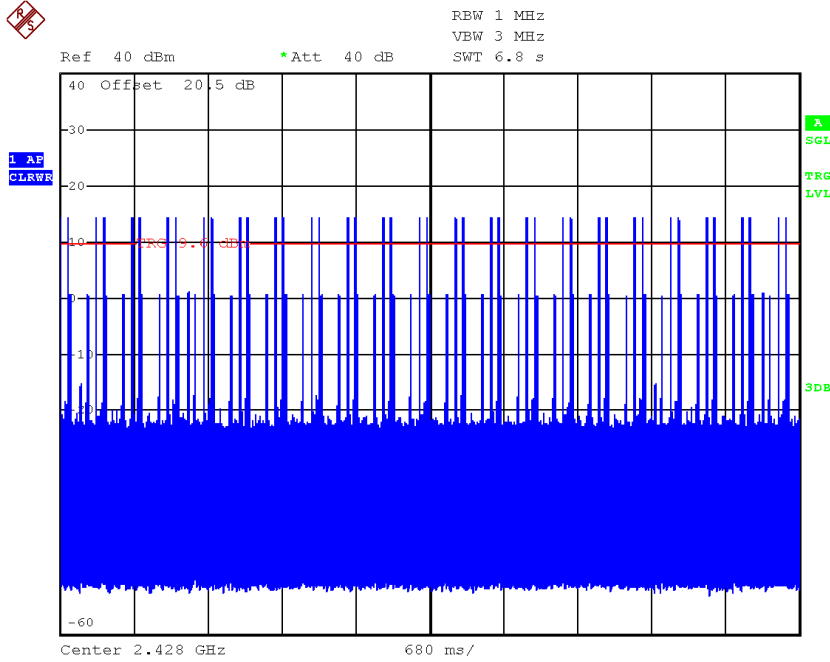

Plot B

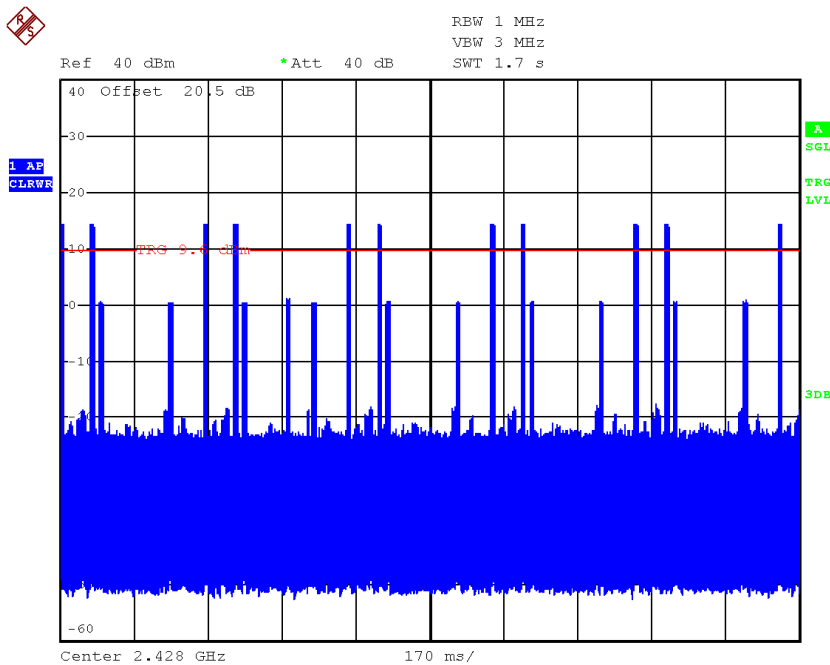

TEST REPORT

PLOTS AVERAGE CHANNEL OCCUPANCY TIME

Plot C

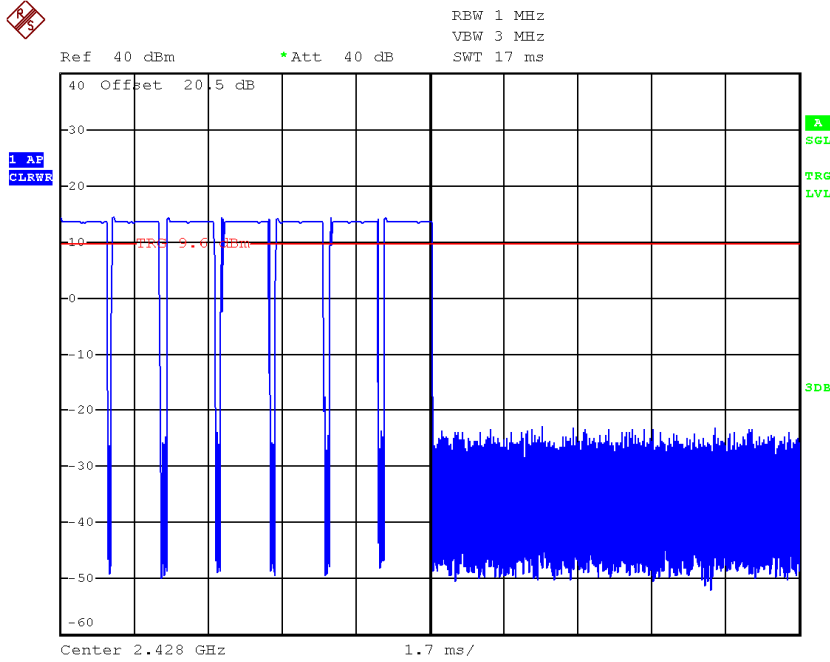

Plot D

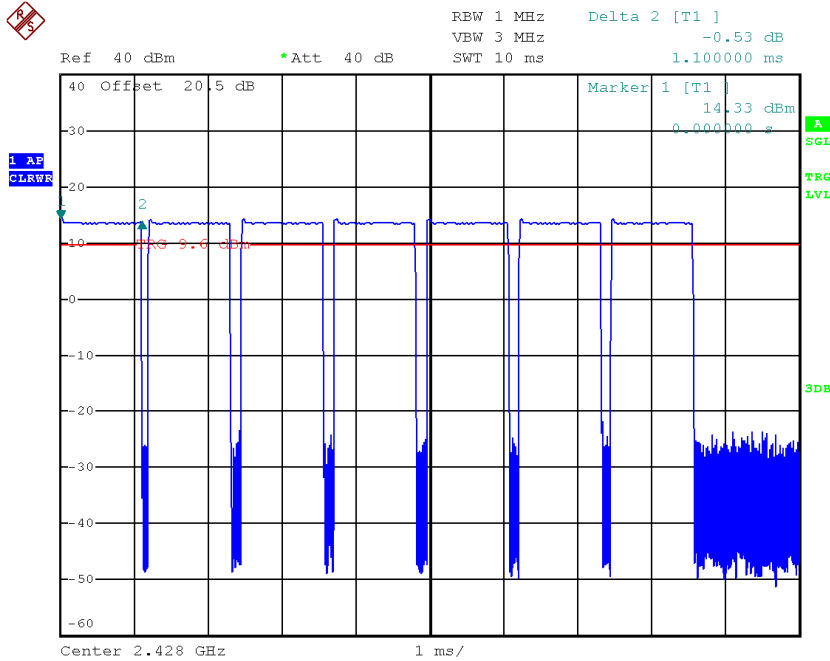

TEST REPORT

4.6 Out of Band Conducted Emissions

In any 100 kHz bandwidth outside the EUT passband, the RF power produced by the modulation products of the spreading sequence, the information sequence, and the carrier frequency shall be at least 20 dB below that of the maximum in-band 100 kHz emission.

The plot(s) of bandedge compliance is shown the worst-case which has been already considered between enable and disable the hopping function of the EUT.

Furthermore, delta measurement technique for measuring bandedge emissions was incorporated in the test of the edge at 2483.5MHz.

Limits:

All spurious emission and up to the tenth harmonic was measured and they were found to be at least 20 dB below the highest level of the desired power in the passband.

The plots of out of band conducted emissions are saved as below.

TEST REPORT

PLOTS OF OUT OF BAND CONDUCTED EMISSIONS

Lowest Channel, Plot 1

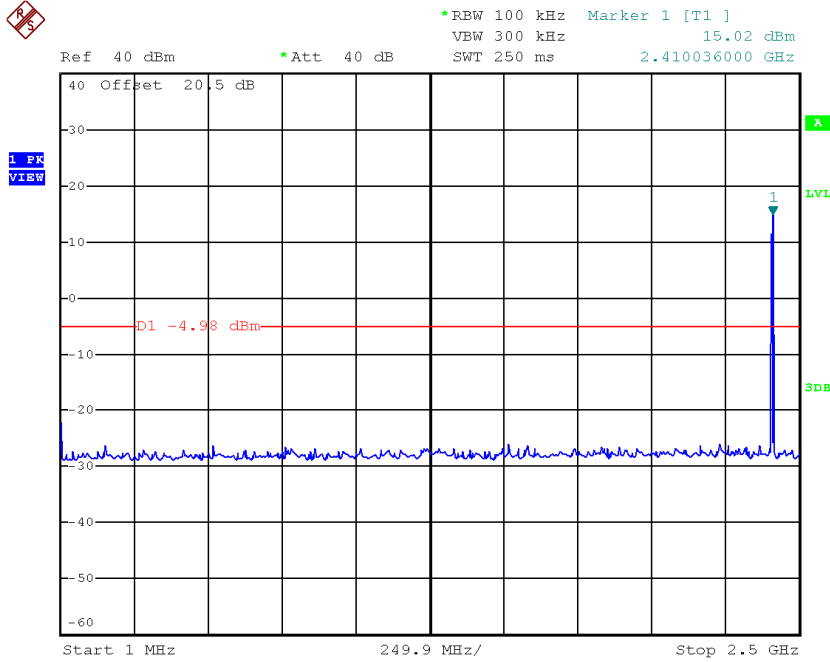

Lowest Channel, Plot 2

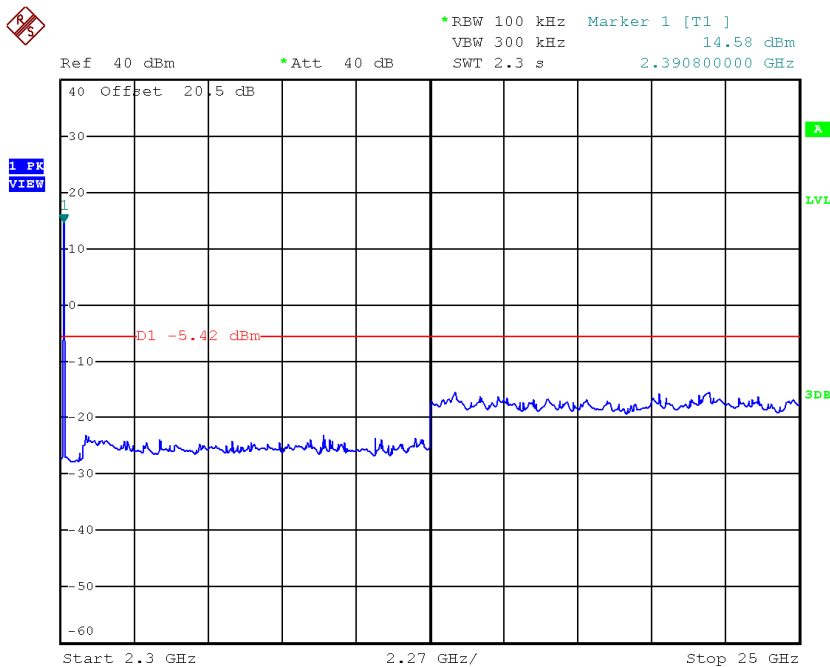

TEST REPORT

PLOTS OF OUT OF BAND CONDUCTED EMISSIONS

Middle Channel, Plot 1

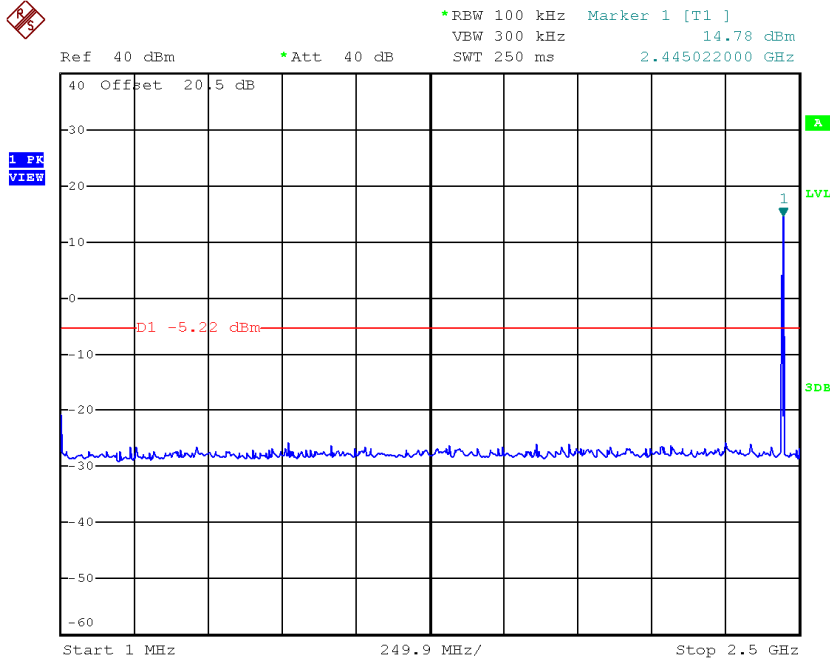

Middle Channel, Plot 2

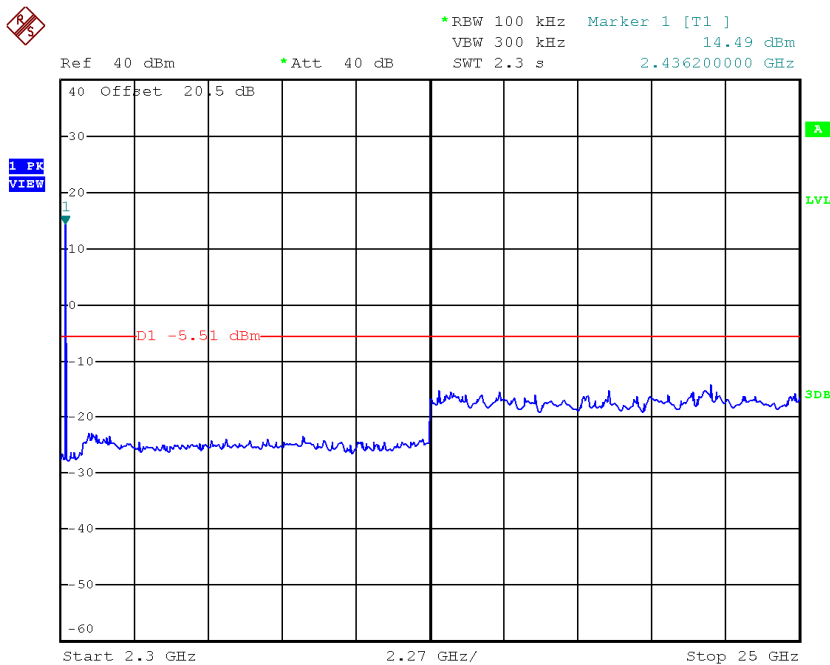

TEST REPORT

PLOTS OF OUT OF BAND CONDUCTED EMISSIONS

Highest Channel, Plot 1

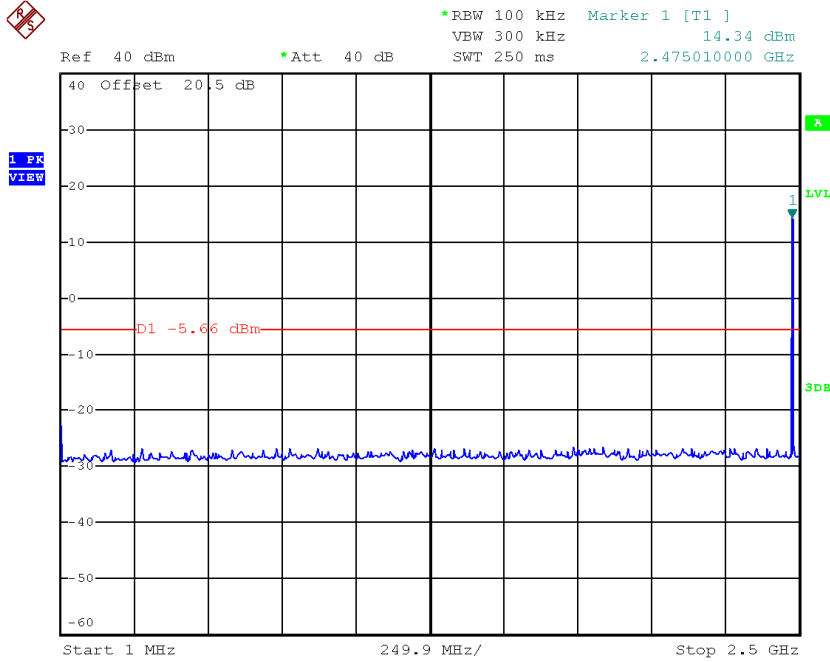

Highest Channel, Plot 2

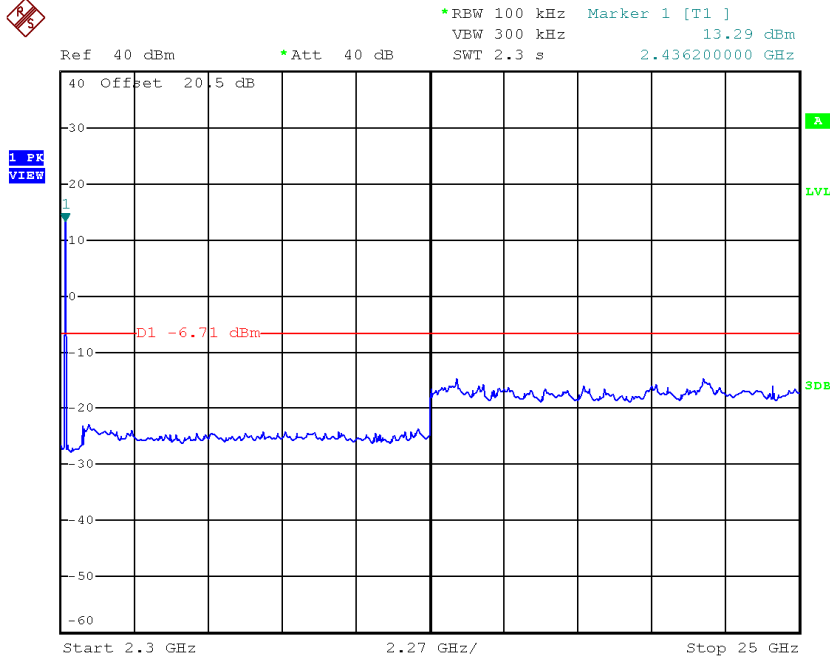

TEST REPORT

PLOTS OF BANDEGE

Lowest Bandedge

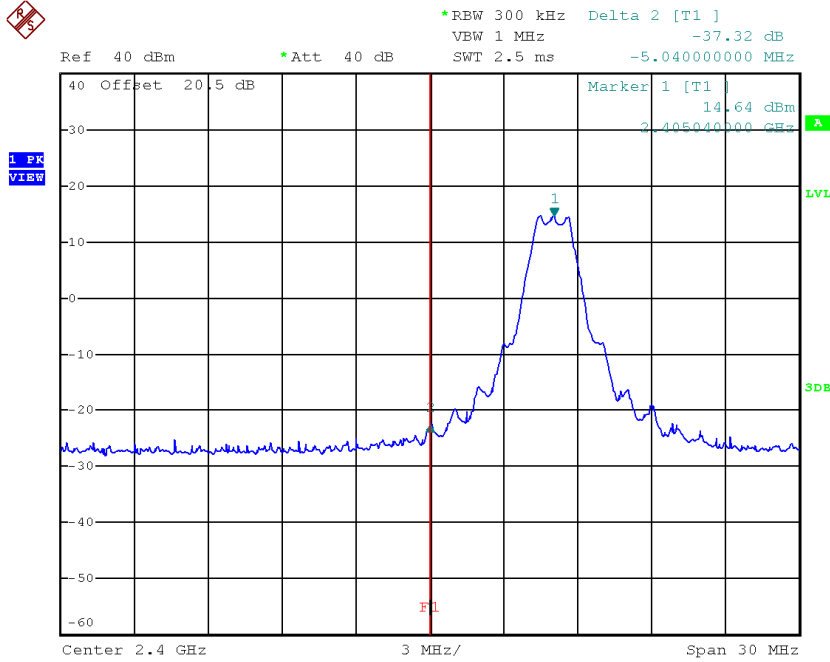

Highest Bandedge

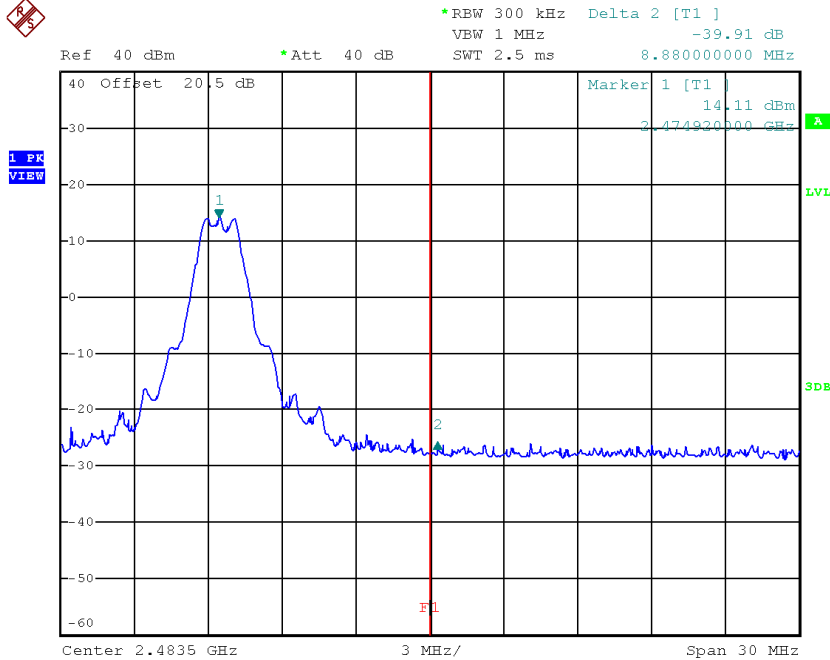

TEST REPORT**4.7 Field Strength Calculation**

The field strength is calculated by adding the reading on the Spectrum Analyzer to the factors associated with preamplifiers (if any), antennas, cables, pulse desensitization and average factors (when specified limit is in average and measurements are made with peak detectors). A sample calculation is included below.

$$FS = RA + AF + CF - AG + PD + AV$$

where

- FS = Field Strength in dB μ V/m
- RA = Receiver Amplitude (including preamplifier) in dB μ V
- CF = Cable Attenuation Factor in dB
- AF = Antenna Factor in dB
- AG = Amplifier Gain in dB
- PD = Pulse Desensitization in dB
- AV = Average Factor in -dB

In the radiated emission table which follows, the reading shown on the data table may reflect the preamplifier gain. An example of the calculations, where the reading does not reflect the preamplifier gain, follows:

$$FS = RA + AF + CF - AG + PD + AV$$

Example

Assume a receiver reading of 62.0 dB μ V is obtained. The antenna factor of 7.4 dB and cable factor of 1.6 dB is added. The amplifier gain of 29 dB is subtracted. The pulse desensitization factor of the spectrum analyzer was 0 dB, and the resultant average factor was -10 dB. The net field strength for comparison to the appropriate emission limit is 32 dB μ V/m. This value in dB μ V/m was converted to its corresponding level in μ V/m.

$$RA = 62.0 \text{ dB}\mu\text{V}$$

$$AF = 7.4 \text{ dB}$$

$$CF = 1.6 \text{ dB}$$

$$AG = 29 \text{ dB}$$

$$PD = 0 \text{ dB}$$

$$AV = -10 \text{ dB}$$

$$FS = 62 + 7.4 + 1.6 - 29 + 0 + (-10) = 32 \text{ dB}\mu\text{V/m}$$

$$\text{Level in } \mu\text{V/m} = \text{Common Antilogarithm } [(32 \text{ dB}\mu\text{V/m})/20] = 39.8 \mu\text{V/m}$$

TEST REPORT

4.8 Transmitter Radiated Emissions in Restricted Bands and Spurious Emissions

Data is included of the worst case configuration (the configuration which resulted in the highest emission levels). A sample calculation, configuration photographs and data tables of the emissions are included.

The data on the following pages list the significant emission frequencies, the limit and the margin of compliance.

TEST REPORT

4.8.1 Radiated Emission Configuration Photograph

Worst Case Restricted Band Radiated Emission
at

Baby Unit with TenPao adaptor: 2483.5 MHz
Baby Unit with Csec adaptor: 2483.5 MHz

The worst case radiated emission configuration photographs are attached in the Appendix and saved with filename: config photos.pdf

4.8.2 Radiated Emission Data

The data in tables 1-8 list the significant emission frequencies, the limit and the margin of compliance.

Judgement -

Baby Unit with TenPao adaptor: Passed by 0.1 dB
Baby Unit with Csec adaptor: Passed by 0.4 dB

TEST REPORT

4.8.3 Radiated Emission Test Setup

The figure below shows the test setup, which is utilized to make these measurements.

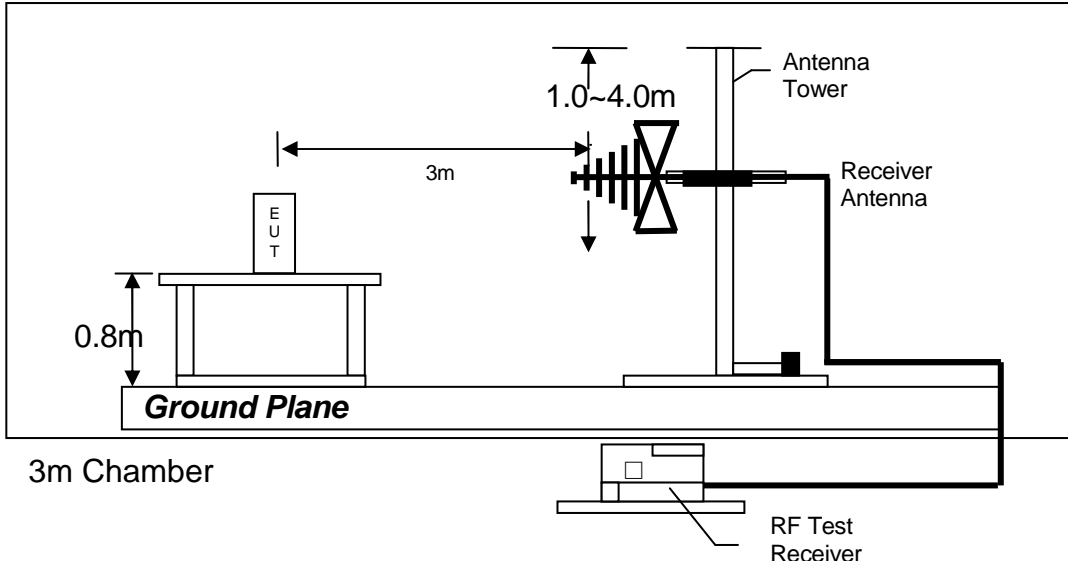

Test setup of radiated emissions up to 1GHz

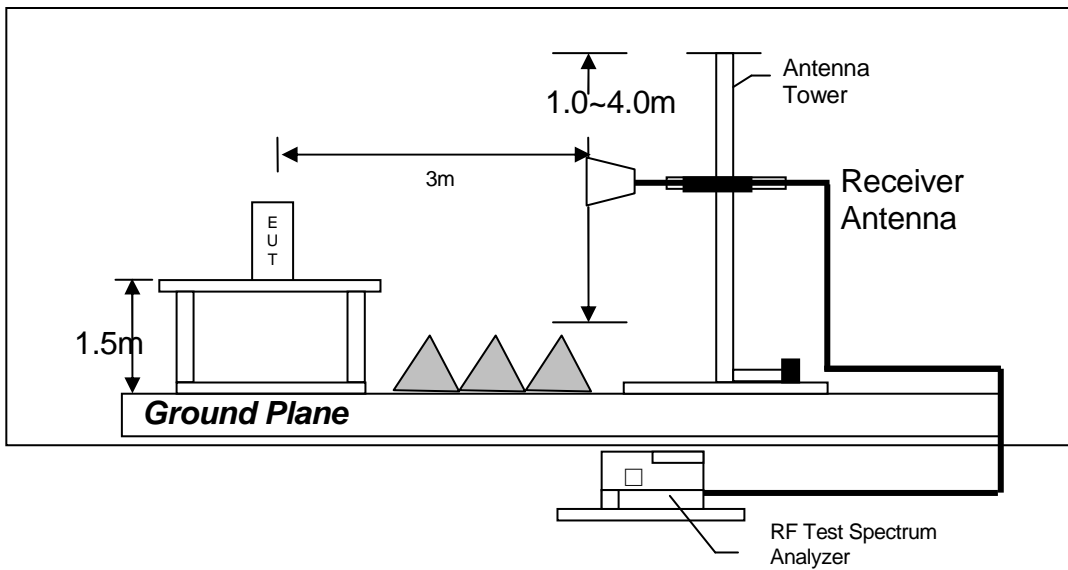

Test setup of radiated emissions above 1GHz

TEST REPORT

RADIATED EMISSION DATA

Mode: TX-Channel 1 with TenPao adaptor

Table 1, Baby Unit

Polarization	Frequency (MHz)	Reading (dBµV)	Pre-Amp Gain (dB)	Antenna Factor (dB)	Net at 3m (dBµV/m)	Average Factor (dB)	Calculated at 3m (dBµV/m)	Average Limit at 3m (dBµV/m)	Margin (dB)
V	2390.000	62.8	33	29.4	59.2	16.2	43.0	54.0	-11.0
H	4810.000	65.9	33	34.9	67.8	16.2	51.6	54.0	-2.4
V	12025.000	44.6	33	40.5	52.1	16.2	35.9	54.0	-18.1

Polarization	Frequency (MHz)	Reading (dBµV)	Pre-Amp Gain (dB)	Antenna Factor (dB)	Net at 3m - Peak (dBµV/m)	Peak Limit at 3m (dBµV/m)	Margin (dB)
V	2390.000	62.8	33	29.4	59.2	74.0	-14.8
H	4810.000	65.9	33	34.9	67.8	74.0	-6.2
V	12025.000	44.6	33	40.5	52.1	74.0	-21.9

- NOTES:
1. Peak detector is used for the emission measurement.
 2. All measurements were made at 3 meters. Radiated emissions not detected at the 3-meter distance were measured at 0.3-meter and an inverse proportional extrapolation was performed to compare the signal level to the 3-meter limit. No other radiated emissions than those reported were detected at a test distance of 0.3-meter.
 3. Negative value in the margin column shows emission below limit.
 4. Horn antenna is used for the emission over 1000MHz.
 5. Emission (the row indicated by **bold italic**) within the restricted band meets the requirement of FCC Part 15 Section 15.205 / RSS-Gen Section 8.10.

TEST REPORT

Mode: TX-Channel 18 with TenPao adaptor

Table 2, Baby Unit

Polarization	Frequency (MHz)	Reading (dBµV)	Pre-Amp Gain (dB)	Antenna Factor (dB)	Net at 3m (dBµV/m)	Average Factor (dB)	Calculated at 3m (dBµV/m)	Average Limit at 3m (dBµV/m)	Margin (dB)
<i>H</i>	<i>4882.000</i>	<i>65.7</i>	<i>33</i>	<i>34.9</i>	<i>67.6</i>	<i>16.2</i>	<i>51.4</i>	<i>54.0</i>	<i>-2.6</i>
<i>V</i>	<i>7323.000</i>	<i>45.7</i>	<i>33</i>	<i>37.9</i>	<i>50.6</i>	<i>16.2</i>	<i>34.4</i>	<i>54.0</i>	<i>-19.6</i>
<i>V</i>	<i>12205.000</i>	<i>44.3</i>	<i>33</i>	<i>40.5</i>	<i>51.8</i>	<i>16.2</i>	<i>35.6</i>	<i>54.0</i>	<i>-18.4</i>

Polarization	Frequency (MHz)	Reading (dBµV)	Pre-Amp Gain (dB)	Antenna Factor (dB)	Net at 3m - Peak (dBµV/m)	Peak Limit at 3m (dBµV/m)	Margin (dB)
<i>H</i>	<i>4882.000</i>	<i>65.7</i>	<i>33</i>	<i>34.9</i>	<i>67.6</i>	<i>74.0</i>	<i>-6.4</i>
<i>V</i>	<i>7323.000</i>	<i>45.7</i>	<i>33</i>	<i>37.9</i>	<i>50.6</i>	<i>74.0</i>	<i>-23.4</i>
<i>V</i>	<i>12205.000</i>	<i>44.3</i>	<i>33</i>	<i>40.5</i>	<i>51.8</i>	<i>74.0</i>	<i>-22.2</i>

- NOTES:
1. Peak detector is used for the emission measurement.
 2. All measurements were made at 3 meters. Radiated emissions not detected at the 3-meter distance were measured at 0.3-meter and an inverse proportional extrapolation was performed to compare the signal level to the 3-meter limit. No other radiated emissions than those reported were detected at a test distance of 0.3-meter.
 3. Negative value in the margin column shows emission below limit.
 4. Horn antenna is used for the emission over 1000MHz.
 5. Emission (the row indicated by ***bold italic***) within the restricted band meets the requirement of FCC Part 15 Section 15.205 / RSS-Gen Section 8.10.

TEST REPORT

Mode: TX-Channel 32 with TenPao adaptor

Table 3, Baby Unit

Polari- zation	Frequency (MHz)	Reading (dBµV)	Pre-Amp Gain (dB)	Antenna Factor (dB)	Net at 3m (dBµV/m)	Average Factor (dB)	Calculated at 3m (dBµV/m)	Average Limit at 3m (dBµV/m)	Margin (dB)
V	2483.500	73.7	33	29.4	70.1	16.2	53.9	54.0	-0.1
H	4950.000	67.5	33	34.9	69.4	16.2	53.2	54.0	-0.8
V	7425.000	43.8	33	37.9	48.7	16.2	32.5	54.0	-21.5
V	12375.000	44.5	33	40.5	52.0	16.2	35.8	54.0	-18.2

Polari- zation	Frequency (MHz)	Reading (dBµV)	Pre-Amp Gain (dB)	Antenna Factor (dB)	Net at 3m - Peak (dBµV/m)	Peak Limit at 3m (dBµV/m)	Margin (dB)
V	2483.500	73.7	33	29.4	70.1	74.0	-3.9
H	4950.000	67.5	33	34.9	69.4	74.0	-4.6
V	7425.000	43.8	33	37.9	48.7	74.0	-25.3
V	12375.000	44.5	33	40.5	52.0	74.0	-22.0

- NOTES:
1. Peak detector is used for the emission measurement.
 2. All measurements were made at 3 meters. Radiated emissions not detected at the 3-meter distance were measured at 0.3-meter and an inverse proportional extrapolation was performed to compare the signal level to the 3-meter limit. No other radiated emissions than those reported were detected at a test distance of 0.3-meter.
 3. Negative value in the margin column shows emission below limit.
 4. Horn antenna is used for the emission over 1000MHz.
 5. Emission (the row indicated by **bold italic**) within the restricted band meets the requirement of FCC Part 15 Section 15.205 / RSS-Gen Section 8.10.

TEST REPORT

Mode: Live Mode with TenPao adaptor

Table 4, Baby Unit

Polarization	Frequency (MHz)	Reading (dBµV)	Pre-amp (dB)	Antenna Factor (dB)	Net at 3m (dBµV/m)	Limit at 3m (dBµV/m)	Margin (dB)
V	53.800	37.4	16	11.0	32.4	40.0	-7.6
V	59.822	40.2	16	10.0	34.2	40.0	-5.8
V	84.060	40.4	16	8.0	32.4	40.0	-7.6
V	132.000	39.3	16	14.0	37.3	43.5	-6.2
H	144.240	38.1	16	14.0	36.1	43.5	-7.4
V	168.040	33.4	16	18.0	35.4	43.5	-8.1
V	432.000	31.3	16	25.0	40.3	46.0	-5.7
V	552.000	29.9	16	28.0	41.9	46.0	-4.1
V	576.000	25.4	16	28.0	37.4	46.0	-8.6
V	864.100	23.3	16	31.0	38.3	46.0	-7.7
V	912.100	21.0	16	33.0	38.0	46.0	-8.0

- NOTES:
1. Peak detector is used for the emission measurement.
 2. All measurements were made at 3 meters. Radiated emissions not detected at the 3-meter distance were measured at 0.3-meter and an inverse proportional extrapolation was performed to compare the signal level to the 3-meter limit. No other radiated emissions than those reported were detected at a test distance of 0.3-meter.
 3. Negative value in the margin column shows emission below limit.
 4. Emission (the row indicated by **bold italic**) within the restricted band meets the requirement of FCC Part 15 Section 15.205 / RSS-Gen Section 8.10.

TEST REPORT

Mode: TX-Channel 1 with Csec adaptor

Table 5, Baby Unit

Polari- zation	Frequency (MHz)	Reading (dBµV)	Pre-Amp Gain (dB)	Antenna Factor (dB)	Net at 3m (dBµV/m)	Average Factor (dB)	Calculated at 3m (dBµV/m)	Average Limit at 3m (dBµV/m)	Margin (dB)
V	2390.000	62.5	33	29.4	58.9	16.2	42.7	54.0	-11.3
H	4810.000	65.6	33	34.9	67.5	16.2	51.3	54.0	-2.7
V	12025.000	44.3	33	40.5	51.8	16.2	35.6	54.0	-18.4

Polari- zation	Frequency (MHz)	Reading (dBµV)	Pre-Amp Gain (dB)	Antenna Factor (dB)	Net at 3m - Peak (dBµV/m)	Peak Limit at 3m (dBµV/m)	Margin (dB)
V	2390.000	62.5	33	29.4	58.9	74.0	-15.1
H	4810.000	65.6	33	34.9	67.5	74.0	-6.5
V	12025.000	44.3	33	40.5	51.8	74.0	-22.2

- NOTES:
1. Peak detector is used for the emission measurement.
 2. All measurements were made at 3 meters. Radiated emissions not detected at the 3-meter distance were measured at 0.3-meter and an inverse proportional extrapolation was performed to compare the signal level to the 3-meter limit. No other radiated emissions than those reported were detected at a test distance of 0.3-meter.
 3. Negative value in the margin column shows emission below limit.
 4. Horn antenna is used for the emission over 1000MHz.
 5. Emission (the row indicated by **bold italic**) within the restricted band meets the requirement of FCC Part 15 Section 15.205 / RSS-Gen Section 8.10.

TEST REPORT

Mode: TX-Channel 18 with Csec adaptor

Table 6, Baby Unit

Polarization	Frequency (MHz)	Reading (dBµV)	Pre-Amp Gain (dB)	Antenna Factor (dB)	Net at 3m (dBµV/m)	Average Factor (dB)	Calculated at 3m (dBµV/m)	Average Limit at 3m (dBµV/m)	Margin (dB)
<i>H</i>	<i>4882.000</i>	<i>65.2</i>	<i>33</i>	<i>34.9</i>	<i>67.1</i>	<i>16.2</i>	<i>50.9</i>	<i>54.0</i>	<i>-3.1</i>
<i>V</i>	<i>7323.000</i>	<i>45.2</i>	<i>33</i>	<i>37.9</i>	<i>50.1</i>	<i>16.2</i>	<i>33.9</i>	<i>54.0</i>	<i>-20.1</i>
<i>V</i>	<i>12205.000</i>	<i>43.7</i>	<i>33</i>	<i>40.5</i>	<i>51.2</i>	<i>16.2</i>	<i>35.0</i>	<i>54.0</i>	<i>-19.0</i>

Polarization	Frequency (MHz)	Reading (dBµV)	Pre-Amp Gain (dB)	Antenna Factor (dB)	Net at 3m - Peak (dBµV/m)	Peak Limit at 3m (dBµV/m)	Margin (dB)
<i>H</i>	<i>4882.000</i>	<i>65.2</i>	<i>33</i>	<i>34.9</i>	<i>67.1</i>	<i>74.0</i>	<i>-6.9</i>
<i>V</i>	<i>7323.000</i>	<i>45.2</i>	<i>33</i>	<i>37.9</i>	<i>50.1</i>	<i>74.0</i>	<i>-23.9</i>
<i>V</i>	<i>12205.000</i>	<i>43.7</i>	<i>33</i>	<i>40.5</i>	<i>51.2</i>	<i>74.0</i>	<i>-22.8</i>

- NOTES:
1. Peak detector is used for the emission measurement.
 2. All measurements were made at 3 meters. Radiated emissions not detected at the 3-meter distance were measured at 0.3-meter and an inverse proportional extrapolation was performed to compare the signal level to the 3-meter limit. No other radiated emissions than those reported were detected at a test distance of 0.3-meter.
 3. Negative value in the margin column shows emission below limit.
 4. Horn antenna is used for the emission over 1000MHz.
 5. Emission (the row indicated by ***bold italic***) within the restricted band meets the requirement of FCC Part 15 Section 15.205 / RSS-Gen Section 8.10.

TEST REPORT

Mode: TX-Channel 32 with Csec adaptor

Table 7, Baby Unit

Polarization	Frequency (MHz)	Reading (dBµV)	Pre-Amp Gain (dB)	Antenna Factor (dB)	Net at 3m (dBµV/m)	Average Factor (dB)	Calculated at 3m (dBµV/m)	Average Limit at 3m (dBµV/m)	Margin (dB)
V	2483.500	73.4	33	29.4	69.8	16.2	53.6	54.0	-0.4
H	4950.000	67.2	33	34.9	69.1	16.2	52.9	54.0	-1.1
V	7425.000	43.3	33	37.9	48.2	16.2	32.0	54.0	-22.0
V	12375.000	44.5	33	40.5	52.0	16.2	35.8	54.0	-18.2

Polarization	Frequency (MHz)	Reading (dBµV)	Pre-Amp Gain (dB)	Antenna Factor (dB)	Net at 3m - Peak (dBµV/m)	Peak Limit at 3m (dBµV/m)	Margin (dB)
V	2483.500	73.4	33	29.4	69.8	74.0	-4.2
H	4950.000	67.2	33	34.9	69.1	74.0	-4.9
V	7425.000	43.3	33	37.9	48.2	74.0	-25.8
V	12375.000	44.5	33	40.5	52.0	74.0	-22.0

- NOTES:
1. Peak detector is used for the emission measurement.
 2. All measurements were made at 3 meters. Radiated emissions not detected at the 3-meter distance were measured at 0.3-meter and an inverse proportional extrapolation was performed to compare the signal level to the 3-meter limit. No other radiated emissions than those reported were detected at a test distance of 0.3-meter.
 3. Negative value in the margin column shows emission below limit.
 4. Horn antenna is used for the emission over 1000MHz.
 5. Emission (the row indicated by **bold italic**) within the restricted band meets the requirement of FCC Part 15 Section 15.205 / RSS-Gen Section 8.10.

TEST REPORT

Mode: Live Mode with Csec adaptor

Table 8, Baby Unit

Polarization	Frequency (MHz)	Reading (dBµV)	Pre-amp (dB)	Antenna Factor (dB)	Net at 3m (dBµV/m)	Limit at 3m (dBµV/m)	Margin (dB)
V	48.000	44.1	16	11.0	39.1	40.0	-0.9
V	53.800	38.5	16	11.0	33.5	40.0	-6.5
V	59.822	40.8	16	10.0	34.8	40.0	-5.2
V	84.060	40.1	16	8.0	32.1	40.0	-7.9
V	132.000	38.9	16	14.0	36.9	43.5	-6.6
H	144.240	38.5	16	14.0	36.5	43.5	-7.0
V	168.040	31.5	16	18.0	33.5	43.5	-10.0
V	432.000	31.7	16	25.0	40.7	46.0	-5.3
V	552.000	29.6	16	28.0	41.6	46.0	-4.4
V	576.000	26.2	16	28.0	38.2	46.0	-7.8
V	864.100	23.5	16	31.0	38.5	46.0	-7.5
V	912.100	22.1	16	33.0	39.1	46.0	-6.9

- NOTES:
1. Peak detector is used for the emission measurement.
 2. All measurements were made at 3 meters. Radiated emissions not detected at the 3-meter distance were measured at 0.3-meter and an inverse proportional extrapolation was performed to compare the signal level to the 3-meter limit. No other radiated emissions than those reported were detected at a test distance of 0.3-meter.
 3. Negative value in the margin column shows emission below limit.
 4. Emission (the row indicated by **bold italic**) within the restricted band meets the requirement of FCC Part 15 Section 15.205 / RSS-Gen Section 8.10.

TEST REPORT

4.8.4 Transmitter Duty Cycle Calculation

$$\begin{aligned}\text{Duty Cycle (DC)} &= (\text{Maximum ON time in 100 ms}) / (100 \text{ ms}) \\ &= 1.1 \text{ ms} \times 14 / 100 \text{ ms}\end{aligned}$$

$$\begin{aligned}\text{Average Factor (AF)} &= 20 \log(\text{DC}) \\ &= 20 * \log(0.154) \\ &= -16.2 \text{ dB}\end{aligned}$$

The plot(s) shows the bit timing is saved as below.

TEST REPORT

PLOTS OF TRANSMITTER DUTY CYCLE

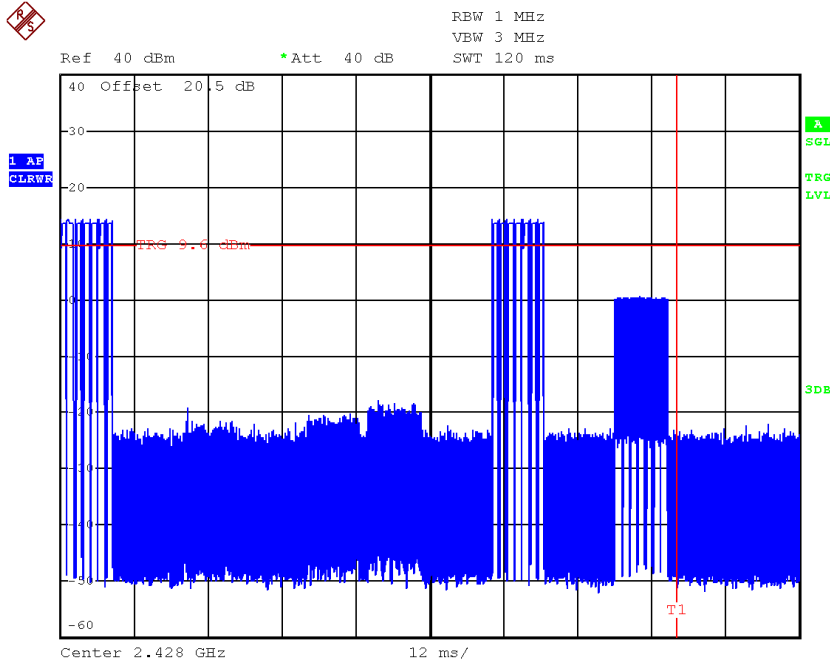

TEST REPORT

4.9 AC Power Line Conducted Emission

- Not applicable – EUT is only powered by battery for operation.
- EUT connects to AC power line. Emission Data is listed in following pages.
- Base Unit connects to AC power line and has transmission. Handset connects to AC power line but has no transmission. Emission Data of Base Unit is listed in following pages.

4.9.1 AC Power Line Conducted Emission Configuration Photograph

Worst Case Line-Conducted Configuration
at

With TenPao adaptor: 366 kHz

With Csec adaptor: 402 kHz

The worst case line conducted configuration photographs are attached in the Appendix and saved with filename: config photos.pdf

4.9.2 AC Power Line Conducted Emission Data

The plot(s) and data in the following pages list the significant emission frequencies, the limit and the margin of compliance.

With TenPao adaptor: Passed by 6.52 dB margin compare with CISPR average limit

With Csec adaptor: Passed by 15.4 dB margin compare with CISPR average limit

TEST REPORT

AC POWER LINE CONDUCTED EMISSION

Worst Case: Live Mode with TenPao adaptor



RBW 9 kHz

MT 1 s

Att 10 dB AUTO PREAMP OFF

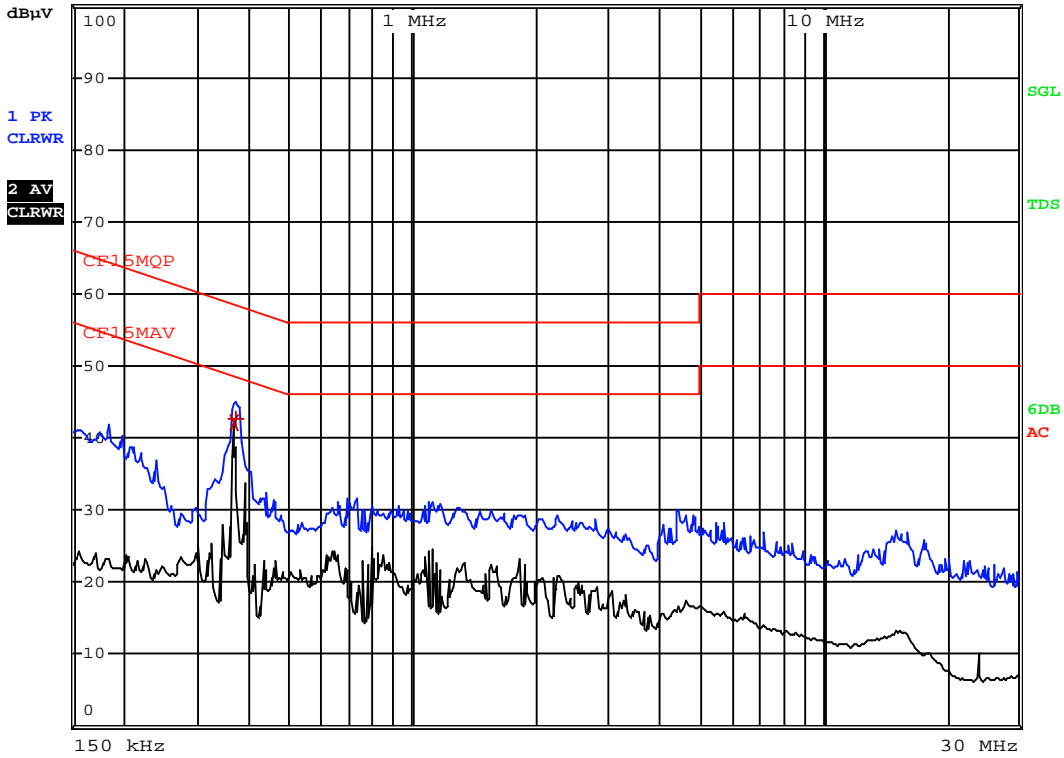

TEST REPORT

Worst Case: Live Mode with TenPao adaptor

EDIT PEAK LIST (Final Measurement Results)				
Trace1:	CF15MQP			
Trace2:	CF15MAV			
Trace3:	---			
TRACE	FREQUENCY	LEVEL dBμV		DELTA LIMIT dB
2 CISPR Average	366 kHz	42.06	N	-6.52
1 Quasi Peak	370.5 kHz	42.67	L1	-15.81

TEST REPORT

Worst Case: Live Mode with Csec adaptor

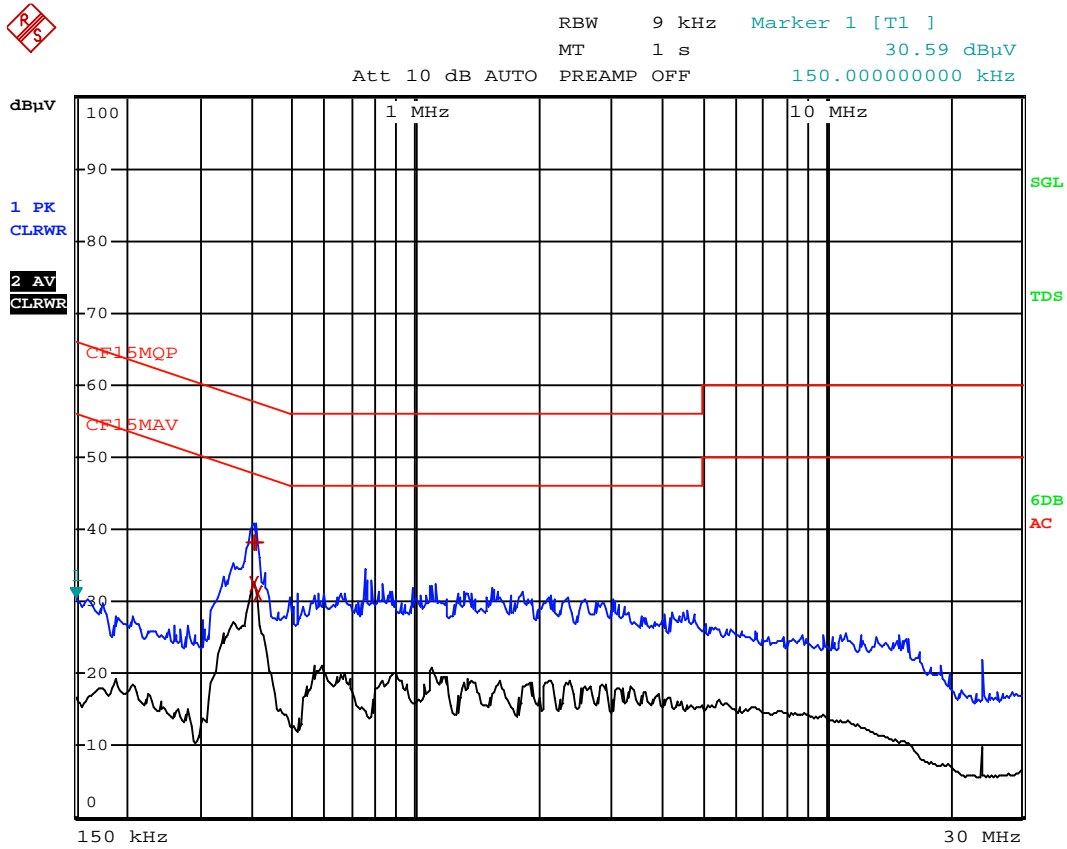

TEST REPORT

Worst Case: Live Mode with Csec adaptor

EDIT PEAK LIST (Final Measurement Results)				
Trace1:	CF15MQP			
Trace2:	CF15MAV			
Trace3:	---			
TRACE	FREQUENCY	LEVEL dBμV		DELTA LIMIT dB
1 Quasi Peak	402 kHz	38.31	N	-19.49
2 CISPR Average	402 kHz	32.41	L1	-15.40
1 Quasi Peak	406.5 kHz	38.31	N	-19.40
2 CISPR Average	411 kHz	31.18	N	-16.43

TEST REPORT

4.9.3 AC Line Conducted Emission Test Setup

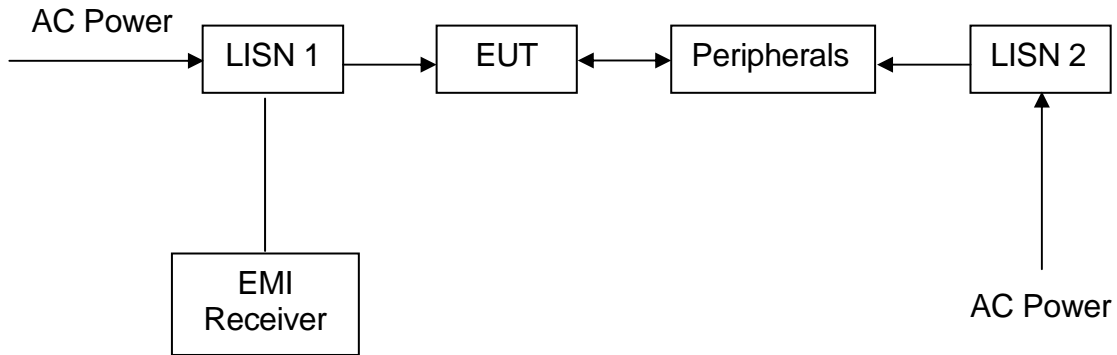

The EUT along with its peripherals were placed on a 1.0m(W)×1.5m(L) and 0.8m in height wooden table and the EUT was adjusted to maintain a 0.4 meter space from a vertical reference plane. The EUT was connected to power mains through a line impedance stabilization network (LISN), which provided 50 ohm coupling impedance for measuring instrument and the chassis ground was bounded to the horizontal ground plane of shielded room. The excess power cable between the EUT and the LISN was bundled.

All connecting cables of EUT and peripherals were moved to find the maximum emission.

TEST REPORT

EXHIBIT 5 EQUIPMENT LIST

5.0 EQUIPMENT LIST

1) Radiated Emissions Test

Equipment	Biconical Antenna	EMI Test Receiver (9kHz to 26.5GHz)	Double Ridged Guide Antenna
Registration No.	EW-2512	EW-3156	EW-0194
Manufacturer	EMCO	ROHDESCHWARZ	EMCO
Model No.	3104C	ESR26	3115
Calibration Date	Nov. 16, 2016	Nov. 10, 2017	Aug. 10, 2016
Calibration Due Date	May. 16, 2018	Nov. 10, 2018	Feb. 10, 2018

Equipment	Log Periodic Antenna	Pyramidal Horn Antenna	Spectrum Analyzer
Registration No.	EW-3243	EW-0905	EW-2466
Manufacturer	EMCO	EMCO	R&S
Model No.	3148B	3160-09	FSP30
Calibration Date	Sep. 12, 2016	Aug. 18, 2017	Sep. 04, 2017
Calibration Due Date	Feb. 17, 2018	Feb. 18, 2019	Jul, 16, 2018

Equipment	Active Loop H-field (9kHz to 30MHz)	RF Cable 9kHz to 1000MHz	RF Cable 14m (1GHz to 26.5GHz)
Registration No.	EW-2313	EW-3170	EW-2781
Manufacturer	ELECTROMETRI	N/A	GREATBILLION
Model No.	EM-6876	9kHz to 1000MHz	1-26.5 GHz
Calibration Date	June. 27, 2016	Mar. 20, 2017	Sep. 25, 2017
Calibration Due Date	Dec. 27, 2017	Mar. 20, 2018	Sep. 25, 2018

Equipment	RF Pre-amplifier 3 pcs (9kHz to 40GHz)	RF Pre-amplifier 3 pcs (9kHz to 40GHz)	Notch Filter (cutoff frequency 2.4GHz to 2.5GHz)
Registration No.	EW-3006	EW-3006	EW-3155
Manufacturer	SCHWARZBECK	SCHWARZBECK	MICROTRONICS
Model No.	BBV 9718	BBV 9744	BRM50701-02
Calibration Date	Mar. 23, 2017	Mar. 23, 2017	May. 26, 2017
Calibration Due Date	Mar. 23, 2018	Mar. 23, 2018	May. 26, 2018

2) Conducted Emissions Test

Equipment	EMI Test Receiver	RF Cable 9kHz to 1000MHz	LISN
Registration No.	EW-3156	EW-3170	EW-2874
Manufacturer	ROHDESCHWARZ	N/A	R&S
Model No.	ESR26	9kHz to 1000MHz	ENV-216
Calibration Date	Nov. 10, 2017	Mar. 20, 2017	Mar. 16, 2017
Calibration Due Date	Nov. 10, 2018	Mar. 20, 2018	Mar. 16, 2018

TEST REPORT

3) Conductive Measurement Test

Equipment	Spectrum Analyzer	RF Cable (up to 40GHz) 1.5m length	RF Power Meter with Power Sensor (N1921A)
Registration No.	EW-2466	EW-3104	EW-2270
Manufacturer	R&S	N/A	AGILENTTECH
Model No.	FSP30	SMA-M to SMA-M	N1911A
Calibration Date	Sep. 04, 2017	Feb. 28, 2017	Jan. 04, 2017
Calibration Due Date	Jul, 16. 2018	Feb. 28, 2018	Jan. 04, 2018

- End of Report -