



Valued Quality. Delivered.

TEST REPORT

Report Number: 16061281HKG-001

Application
for
Original Grant of 47 CFR Part 15 Certification

4-Port Ethernet Router

FCC ID: EW780-0554-00

Prepared and Checked by:

Approved by:

Signed On File

Josie Yao
Engineer

Koo Wai Ip
Assistant Supervisor
August 18, 2016

- Intertek's standard Terms and Conditions can be obtained at our website: <http://www.intertek.com/terms/>.
- The test report only allows to be revised within the retention period unless further standard or the requirement was noticed.
- This report is for the exclusive use of Intertek's Client and is provided pursuant to the agreement between Intertek and its Client. Intertek's responsibility and liability are limited to the terms and conditions of the agreement. Intertek assumes no liability to any party, other than to the Client in accordance with the agreement, for any loss, expense or damage occasioned by the use of this report. Only the Client is authorized to permit copying or distribution of this report and then only in its entirety. Any use of the Intertek name or one of its marks for the sale or advertisement of the tested material, product or service must first be approved in writing by Intertek. The observations and test results in this report are relevant only to the sample tested. This report by itself does not imply that the material, product, or service is or has ever been under an Intertek certification program.
- © 2016 Intertek

Intertek Testing Services Hong Kong Ltd.

2/F., Garment Centre, 576 Castle Peak Road, Kowloon, Hong Kong.
Tel: (852) 2173 8888 Fax: (852) 2785 5487 Website: www.hk.intertek-etlsemko.com

INTERTEK TESTING SERVICES

GENERAL INFORMATION

Applicant Name:	VTech Telecommunications Ltd.
Applicant Address:	23/F., Tai Ping Industrial Centre, Block 1, 57 Ting Kok Road, Tai Po, Hong Kong.
FCC Specification Standard:	FCC Part 15, October 1, 2014 Edition
FCC ID:	EW780-0554-00
FCC Model(s):	VNT832
Type of EUT:	Spread Spectrum Transmitter
Description of EUT:	4-Port Ethernet Router
Serial Number:	N/A
Sample Receipt Date:	June 20, 2016
Date of Test:	August 8, 2016
Report Date:	August 18, 2016
Environmental Conditions:	Temperature: +10 to 40°C Humidity: 10 to 90%

INTERTEK TESTING SERVICES

Table of Contents

1.0 Test Results Summary & Statement of Compliance	4
1.1 Summary of Test Results	4
1.2 Statement of Compliance	4
2.0 General Description	6
2.1 Product Description	6
2.2 Test Methodology	6
2.3 Test Facility	6
2.4 Related Submittal(s) Grants	7
3.0 System Test Configuration	9
3.1 Justification	9
3.2 EUT Exercising Software	10
3.3 Details of EUT and Description of Accessories	11
3.4 Measurement Uncertainty	11
4.0 Test Results	13
4.1 Maximum Conducted Output Power at Antenna Terminals	13
4.2 Minimum 6dB RF Bandwidth	18
4.3 Maximum Power Spectral Density	35
4.4 Out of Band Conducted Emissions	54
4.5 Field Strength Calculation	83
4.6 Transmitter Radiated Emissions in Restricted Bands and Spurious Emissions	84
4.6.1 Radiated Emission Configuration Photograph	84
4.6.2 Radiated Emission Data	84
4.6.3 Radiated Emission Test Setup	100
4.6.4 Transmitter Duty Cycle Calculation	101
4.7 AC Power Line Conducted Emission	102
4.7.1 AC Power Line Conducted Emission Configuration Photograph	102
4.7.2 AC Power Line Conducted Emission Data	102
4.7.3 Conducted Emission Test Setup	107
5.0 Equipment List	109

INTERTEK TESTING SERVICES

**EXHIBIT 1
TEST RESULTS SUMMARY & STATEMENT OF COMPLIANCE**

INTERTEK TESTING SERVICES

1.0 Test Results Summary & Statement of Compliance

1.1 Summary of Test Results

Test Items	FCC Part 15 Section	Results	Details see section
Antenna Requirement	15.203	Pass	2.1
Max. Conducted Output Power (peak)	15.247(b)(3)&(4)	Pass	4.1
Min. 6dB RF Bandwidth	15.247(a)(2)	Pass	4.2
Max. Power Density (peak)	15.247(e)	Pass	4.3
Out of Band Antenna Conducted Emission	15.247(d)	Pass	4.4
Radiated Emission in Restricted Bands and Spurious Emissions	15.247(d), 15.209 & 15.109	Pass	4.6
AC Power Line Conducted Emission	15.207 & 15.107	Pass	4.7

Note: Pursuant to FCC Part 15 Section 15.215(c), the 20dB bandwidth of the emission was contained within the frequency band designated (mentioned as above) which the EUT operated. The effects, if any, from frequency sweeping, frequency hopping, other modulation techniques and frequency stability over expected variations in temperature and supply voltage were considered.

1.2 Statement of Compliance

The equipment under test is found to be complying with the following standard:

FCC Part 15, October 1, 2014 Edition

INTERTEK TESTING SERVICES

**EXHIBIT 2
GENERAL DESCRIPTION**

INTERTEK TESTING SERVICES

2.0 General Description

2.1 Product Description

The VNT832 is a 4-Port Ethernet Router.

The Equipment Under Test (EUT) operates at frequency range of 2412MHz to 2462MHz with 11 channels. For 802.11g mode, it operates at frequency range of 2412.000MHz to 2462.000MHz with 11 channels. It transmits via Orthogonal Frequency Division Multiplexing (OFDM) modulation. Maximum bit rate can be up to 54Mbps. For 802.11n (with 20MHz bandwidth) mode, it operates at frequency range of 2412.000MHz to 2462.000MHz with 11 channels. It transmits via Orthogonal Frequency Division Multiplexing (OFDM) modulation. Maximum bit rate can support up to 65Mbps. For 802.11n (with 40MHz bandwidth) mode, it operates at frequency range of 2422.000MHz to 2452.000MHz with 7 channels. It transmits via Orthogonal Frequency Division Multiplexing (OFDM) modulation. Maximum bit rate can support up to 65Mbps.

It operates at frequency range of The EUT is power by a 100-240VAC to 12VDC 1.0A adaptor.

The antenna(s) used in the EUT is integral, and the test sample is a prototype. The circuit description is saved with filename: descri.pdf.

2.2 Test Methodology

Both AC power line-conducted and radiated emission measurements were performed according to the procedures in ANSI C63.4 (2014). Preliminary radiated scans and all radiated measurements were performed in radiated emission test sites. All Radiated tests were performed at an antenna to EUT distance of 3 meters, unless stated otherwise in the "**Justification Section**" of this Application. Antenna port conducted measurements were performed according to ANSI C63.10 (2013), KDB Publication No.558074 D01 v03r05 (08-April-2016) and 662911 D01 Multiple Transmitter Output v02r01 (31-October-2013). All other measurements were made in accordance with the procedures in 47 CFR Part 2.

2.3 Test Facility

The radiated emission test site and antenna port conducted measurement facility used to collect the radiated data and conductive data are at Workshop No. 3, G/F., World-Wide Industrial Centre, 43-47 Shan Mei Street, Fo Tan, Sha Tin, N.T., Hong Kong. This test facility and site measurement data have been fully placed on file with the FCC.

INTERTEK TESTING SERVICES

2.4 Related Submittal(s) Grants

This is a single application for certification of a transceiver (WiFi portion).

The Certification procedure of PC Connectivity for this transceiver (with FCC ID: EW780-0554-00) is being processed at the same time of this application.

INTERTEK TESTING SERVICES

**EXHIBIT 3
SYSTEM TEST CONFIGURATION**

INTERTEK TESTING SERVICES

3.0 System Test Configuration

3.1 Justification

For radiated emissions testing, the equipment under test (EUT) was setup to transmit / receive continuously to simplify the measurement methodology. Care was taken to ensure proper power supply voltages during testing. During testing, all cables (if any) were manipulated to produce worst case emissions.

The EUT was powered by a 100-240VAC to 12VDC 1.0A adaptor.

For the measurements, the EUT was attached to a plastic stand if necessary and placed on the wooden turntable. If the base unit attached to peripherals, they were connected and operational (as typical as possible).

The signal was maximized through rotation and placement in the three orthogonal axes. The antenna height and polarization were varied during the search for maximum signal level. The antenna height was varied from 1 to 4 meters. Radiated emissions were taken at three meters unless the signal level was too low for measurement at that distance. If necessary, a pre-amplifier was used and/or the test was conducted at a closer distance.

For any intentional radiator powered by AC power line, measurements of the radiated signal level of the fundamental frequency component of the emission was performed with the supply voltage varied between 85% and 115% of the nominal rated supply voltage.

Radiated emission measurement for transmitter were performed from the lowest radio frequency signal generated in the device which is greater than 9 kHz to the tenth harmonic of the highest fundamental frequency or to 40 GHz, whichever is lower.

Emission that are directly caused by digital circuits in the transmit path and transmitter portion were measured, and the limit are according to FCC Part 15 Section 15.209. Digital circuitries used to control additional functions other than the operation of the transmitter are subject to FCC Part 15 Section 15.109 Limits.

INTERTEK TESTING SERVICES

3.1 Justification – Cont'd

Detector function for radiated emissions was in peak mode. Average readings, when required, were taken by measuring the duty cycle of the equipment under test and subtracting the corresponding amount in dB from the measured peak readings. A detailed description for the calculation of the average factor can be found in section 4.2.3.

Determination of pulse desensitization was made according to *Hewlett Packard Application Note 150-2, Spectrum Analysis... Pulsed RF*. The effective period (Teff) was referred to Exhibit 4.6.3. With the resolution bandwidth 1MHz and spectrum analyzer IF bandwidth 3dB, the pulse desensitization factor was 0dB.

The EUT along with its peripherals were placed on a 1.0m(W)x1.5m(L) and 0.8m in height wooden table and the EUT was adjusted to maintain a 0.4 meter space from a vertical reference plane. The EUT power cord connected to one LISN (Line impedance stabilization network), which provided 50ohm coupling impedance for measuring instrument. Meanwhile, the peripheral or support equipment power cords connected to a separate LISN. The ac powers for all LISNs were obtained from the same power source. The LISN housing, measuring instrument case, reference ground plane, and vertical ground plane were bounded together. The excess power cable between the EUT and the LISN was bundled. Power cords of non-EUT equipment (peripherals) were not bundled. AC power cords of peripheral equipments draped over the rear edge of the table, and routed them down onto the floor of the ac power line conducted emission test site to the second LISN.

All connecting cables of EUT and peripherals were manipulated to find the maximum emission.

Different data rates have been tested. Worst case is reported only.

All relevant operation modes have been tested, and the worst case data is included in this report.

All data rates were tested under normal mode of WiFi. Only the worst-case data is shown in the report for DSSS and OFDM

3.2 EUT Exercising Software

The EUT exercise program (if any) used during radiated and conducted testing was designed to exercise the various system components in a manner similar to a typical use.

INTERTEK TESTING SERVICES

3.3 Details of EUT and Description of Accessories

Details of EUT:

An AC adaptor (provided with the unit) was used to power the device. Their description are listed below.

- (1) An AC adaptor (100-240VAC to 12VDC 1.0A, Model: CS12N120100FUF) (Supplied by Client)

Description of Accessories:

- (1) 5 X LAN cable of 1m in length (Supplied by Intertek)
- (2) Notebook (HP Probook 430) (Provided by Intertek)
- (3) 1 X 4GB USB flash drive (Provided by Intertek)

3.4 Measurement Uncertainty

When determining of the test conclusion, the Measurement Uncertainty of test at a level of confidence of 95% has been considered. The values of the Measurement uncertainty for radiated emission test and RF conducted measurement test are $\pm 5.3\text{dB}$ and $\pm 0.99\text{dB}$ respectively. The value of the Measurement uncertainty for conducted emission test is $\pm 4.2\text{dB}$.

Uncertainty and Compliance - Unless the standard specifically states that measured values are to be extended by the measurement uncertainty in determining compliance, all compliance determinations are based on the actual measured value.

INTERTEK TESTING SERVICES

**EXHIBIT 4
TEST RESULTS**

INTERTEK TESTING SERVICES

4.0 Test Results

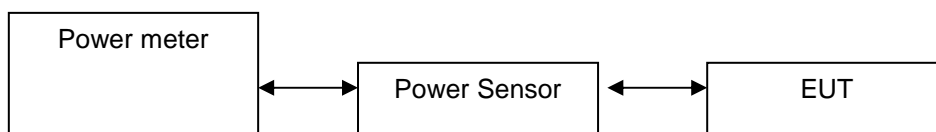

4.1 Maximum Conducted (peak) Output Power at Antenna Terminals

The antenna port of the EUT was connected to the input of a power meter.

- The antenna power of the EUT was connected to the input of a power meter. Power was read directly and cable loss correction was added to the reading to obtain power at the EUT antenna terminals. The measurement procedure 9.1.2 was used.
- The EUT should be configured to transmit continuously (at a minimum duty cycle of 98%) at full power over the measurement duration. The measurement procedure AVG1 was used.

(Antenna 0) IEEE 802.11b (DSSS, 1 Mbps) Antenna Gain = 1.5 dBi		
Frequency (MHz)	Output in dBm	Output in mWatt
Low Channel: 2412	25.5	354.813
Middle Channel: 2437	25.1	323.594
High Channel: 2462	24.8	301.995

(Antenna 1) IEEE 802.11b (DSSS, 1 Mbps) Antenna Gain = 1.5 dBi		
Frequency (MHz)	Output in dBm	Output in mWatt
Low Channel: 2412	24.3	269.154
Middle Channel: 2437	24.1	257.040
High Channel: 2462	23.8	239.883

INTERTEK TESTING SERVICES

(Antenna 0) IEEE 802.11g (OFDM, 6 Mbps) Antenna Gain = 1.5 dBi		
Frequency (MHz)	Output in dBm	Output in mWatt
Low Channel: 2412	25.6	363.078
Middle Channel: 2437	25.5	354.813
High Channel: 2462	25.2	331.131

(Antenna 1) IEEE 802.11g (OFDM, 6 Mbps) Antenna Gain = 1.5 dBi		
Frequency (MHz)	Output in dBm	Output in mWatt
Low Channel: 2412	25.5	354.813
Middle Channel: 2437	25.5	354.813
High Channel: 2462	25.3	338.844

INTERTEK TESTING SERVICES

(Antenna 0) IEEE 802.11n (20MHz) (OFDM, MCS0) Antenna Gain = 1.5 dBi		
Frequency (MHz)	Output in dBm	Output in mWatt
Low Channel: 2412	25.7	371.535
Middle Channel: 2437	25.5	354.813
High Channel: 2462	25.3	338.844

(Antenna 1) IEEE 802.11n (20MHz) (OFDM, MCS0) Antenna Gain = 1.5 dBi		
Frequency (MHz)	Output in dBm	Output in mWatt
Low Channel: 2412	25.7	371.535
Middle Channel: 2437	25.6	363.078
High Channel: 2462	25.4	346.737

IEEE 802.11n (20MHz) (OFDM, MCS0)			
Frequency (MHz)	Output in dBm		
	Antenna 0	Antenna 1	Antenna 0 + Antenna 1
Low Channel: 2412	25.7	25.7	28.7
Middle Channel: 2437	25.5	25.6	28.6
High Channel: 2462	25.3	25.4	28.4

INTERTEK TESTING SERVICES

(Antenna 0) IEEE 802.11n (40MHz) (OFDM, MCS0) Antenna Gain = 1.5 dBi		
Frequency (MHz)	Output in dBm	Output in mWatt
Low Channel: 2422	25.5	354.813
Middle Channel: 2437	25.4	346.737
High Channel: 2452	25.1	323.594

(Antenna 1) IEEE 802.11n (40MHz) (OFDM, MCS0) Antenna Gain = 1.5 dBi		
Frequency (MHz)	Output in dBm	Output in mWatt
Low Channel: 2422	25.6	363.078
Middle Channel: 2437	25.4	346.737
High Channel: 2452	25.3	338.844

IEEE 802.11n (40MHz) (OFDM, MCS0)			
Frequency (MHz)	Output in dBm		
	Antenna 0	Antenna 1	Antenna 0 + Antenna 1
Low Channel: 2422	25.5	25.6	28.6
Middle Channel: 2437	25.4	25.4	28.4
High Channel: 2452	25.1	25.3	28.2

INTERTEK TESTING SERVICES

4.1 Maximum Conducted Output Power at Antenna Terminals – Cont'd

Cable loss : 0.5 dB External Attenuation : 20 dB

Cable loss, external attenuation: included in OFFSET function
 added to SA raw reading

IEEE 802.11b (DSSS, 1 Mbps)
max. conducted (peak) output level = 25.5 dBm

IEEE 802.11g (OFDM, 9 Mbps)
max. conducted (peak) output level = 25.6 dBm

IEEE 802.11n (20MHz) (OFDM, MCS0)
max. conducted (peak) output level = 28.7 dBm

IEEE 802.11n (40MHz) (OFDM, MCS0)
max. conducted (peak) output level = 28.6 dBm

The transmit signals are correlated with each other,
Directional gain = $G_{Ant} + 10 \log(N_{Ant})$ dBi = 1.5 + 3 = 4.5 dBi

Limits:

1W (30dBm) for antennas with gains of 6dBi or less

___W (___dBm) for antennas with gains more than 6dBi

The plots of conducted output power are saved as below.

INTERTEK TESTING SERVICES

4.2 Minimum 6dB RF Bandwidth

The antenna port of the EUT was connected to the input of a spectrum analyzer. The EBW measurement procedure was used. A PEAK output reading was taken, a DISPLAY line was drawn 6dB lower than PEAK level. The 6dB bandwidth was determined from where the channel output spectrum intersected the display line.

IEEE 802.11b (DSSS, 1 Mbps)		
Frequency (MHz)	6dB Bandwidth (MHz)	
	Ant0 Gain = 1.5 dBi	Ant1 Gain = 1.5 dBi
Low Channel: 2412	10.3	9.3
Middle Channel: 2437	10.2	9.3
High Channel: 2462	10.3	9.4

IEEE 802.11g (OFDM, 6 Mbps)		
Frequency (MHz)	6dB Bandwidth (MHz)	
	Ant0 Gain = 1.5 dBi	Ant1 Gain = 1.5 dBi
Low Channel: 2412	16.6	16.6
Middle Channel: 2437	16.6	16.6
High Channel: 2462	16.6	16.6

IEEE 802.11n (20MHz) (OFDM, MCS0)		
Frequency (MHz)	6dB Bandwidth (MHz)	
	Ant0 Gain = 1.5 dBi	Ant1 Gain = 1.5 dBi
Low Channel: 2412	17.9	17.9
Middle Channel: 2437	17.8	17.9
High Channel: 2462	17.8	17.8

IEEE 802.11n (40MHz) (OFDM, MCS0)		
Frequency (MHz)	6dB Bandwidth (MHz)	
	Ant0 Gain = 1.5 dBi	Ant1 Gain = 1.5 dBi
Low Channel: 2422	36.12	36.15
Middle Channel: 2437	36.00	36.00
High Channel: 2452	35.88	36.00

Limits

6 dB bandwidth shall be at least 500kHz

The plots of 6dB RF bandwidth and occupied bandwidth are saved as below.

INTERTEK TESTING SERVICES

Plots of 6dB RF bandwidth (Antenna 0)

802.11b, Lowest Channel

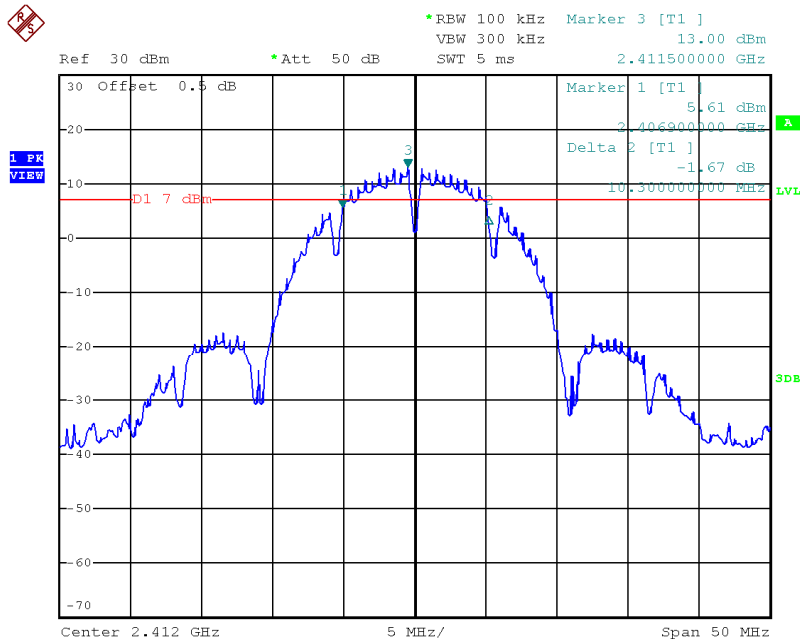

802.11b, Middle Channel

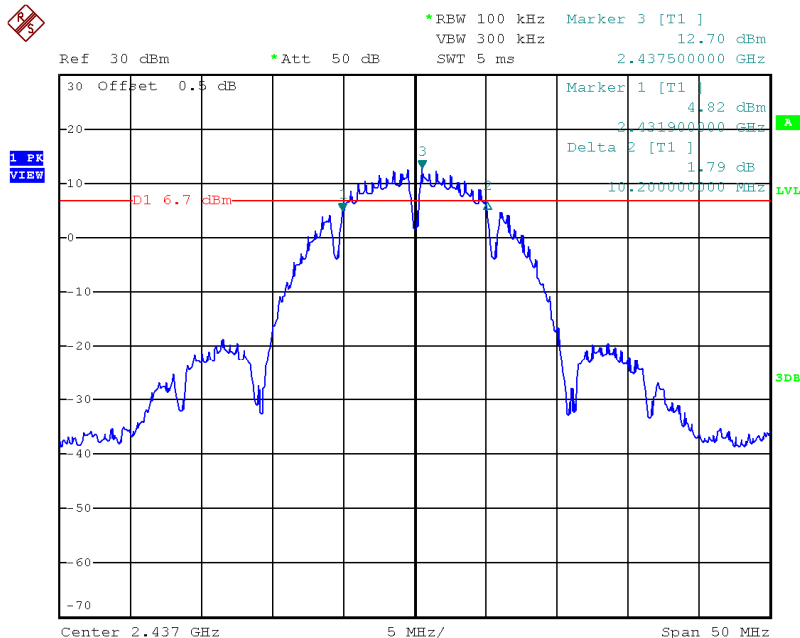

INTERTEK TESTING SERVICES

Plots of 6dB RF bandwidth (Antenna 0)

802.11b, Highest Channel

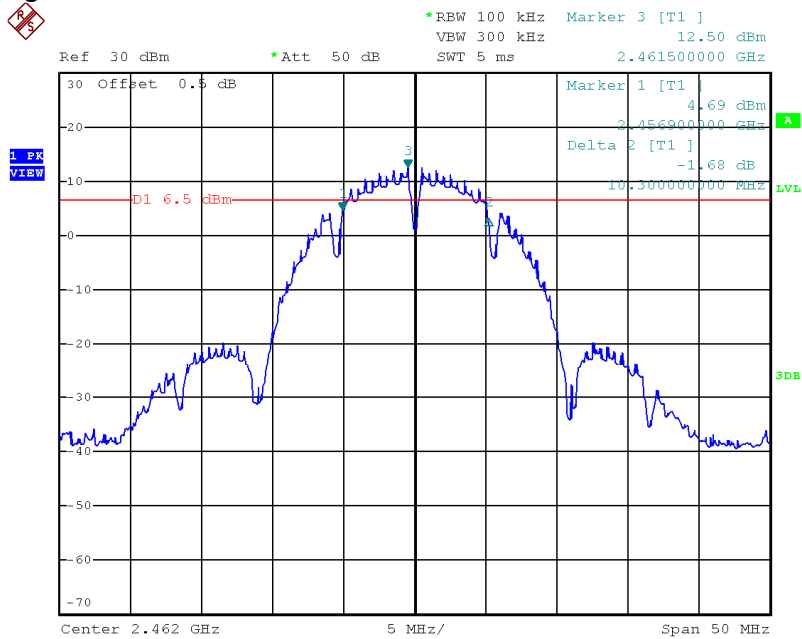

INTERTEK TESTING SERVICES

Plots of 6dB RF bandwidth (Antenna 1)

802.11b, Lowest Channel

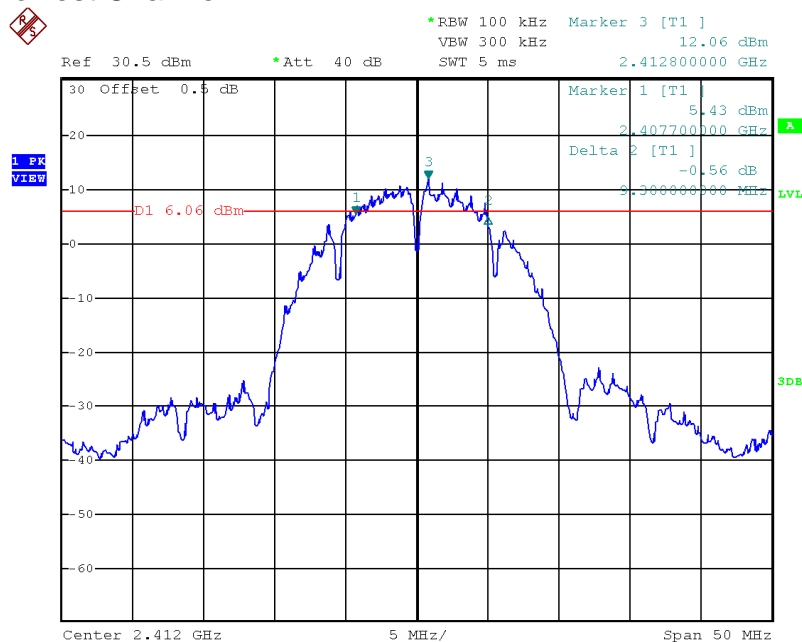

802.11b, Middle Channel

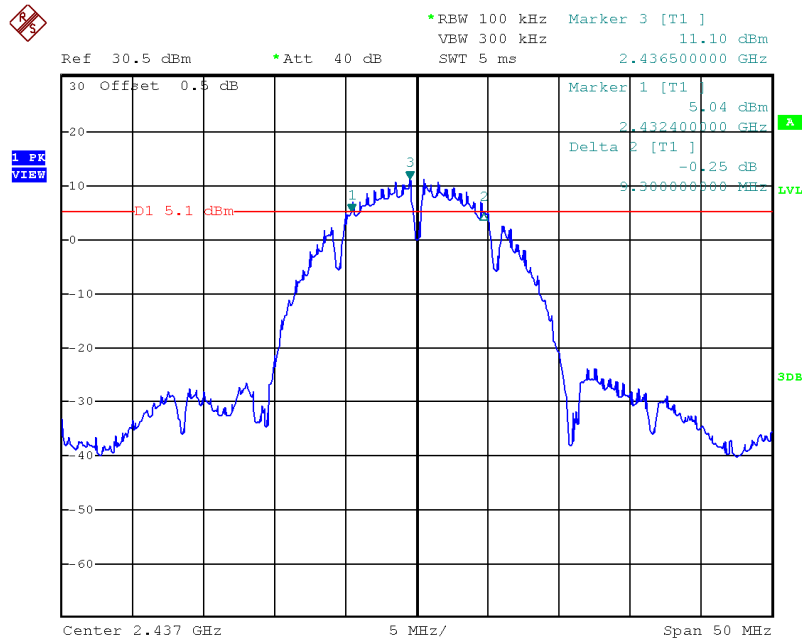

INTERTEK TESTING SERVICES

Plots of 6dB RF bandwidth (Antenna 1)

802.11b, Highest Channel

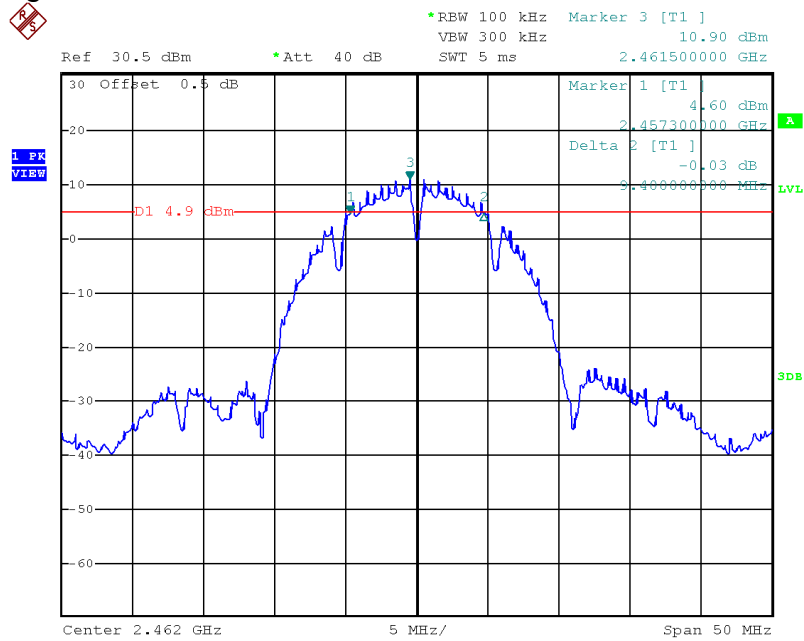

INTERTEK TESTING SERVICES

Plots of 6dB RF bandwidth (Antenna 0)

802.11g, Lowest Channel

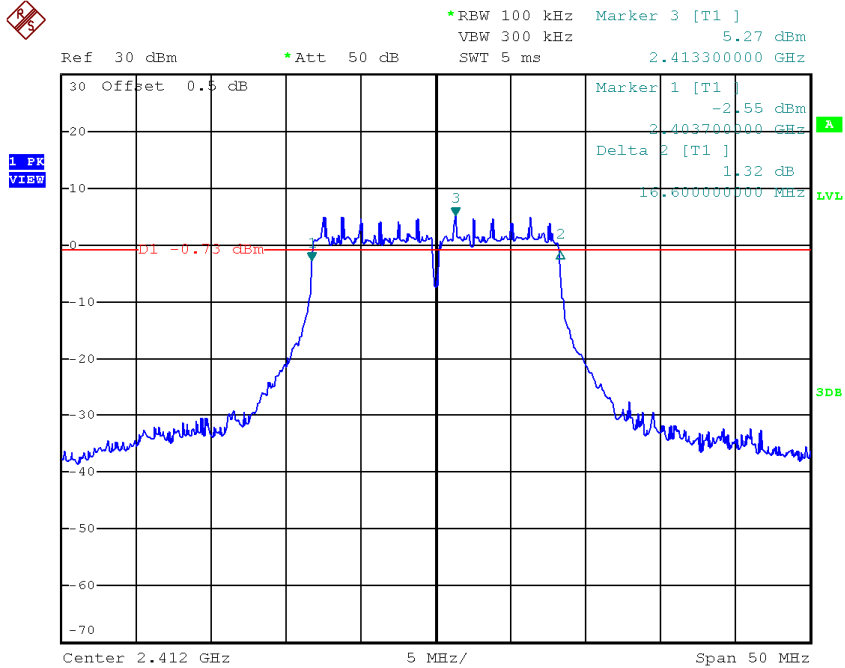

802.11g, Middle Channel

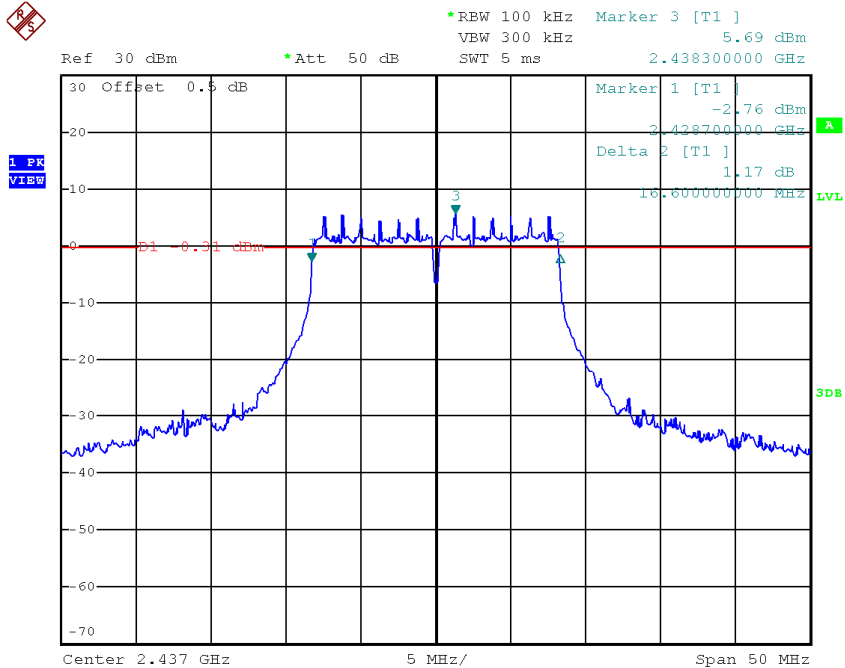

INTERTEK TESTING SERVICES

Plots of 6dB RF bandwidth (Antenna 0)

802.11g, Highest Channel

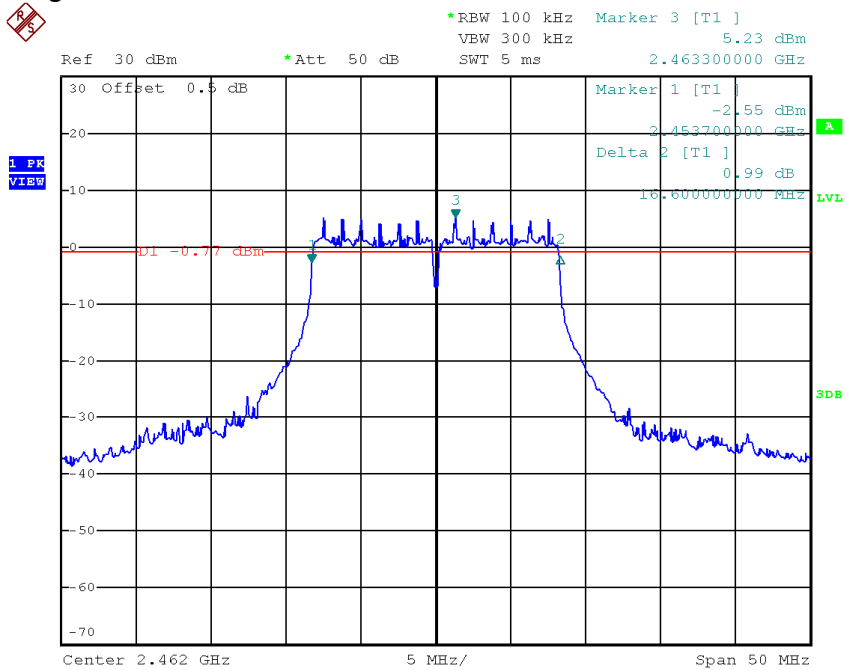

INTERTEK TESTING SERVICES

Plots of 6dB RF bandwidth (Antenna 1)

802.11g, Lowest Channel

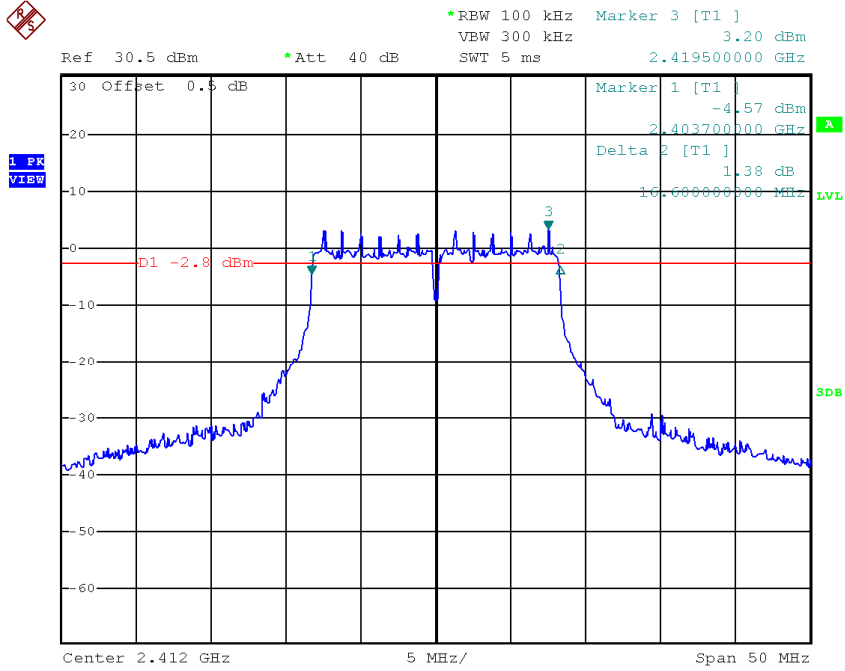

802.11g, Middle Channel

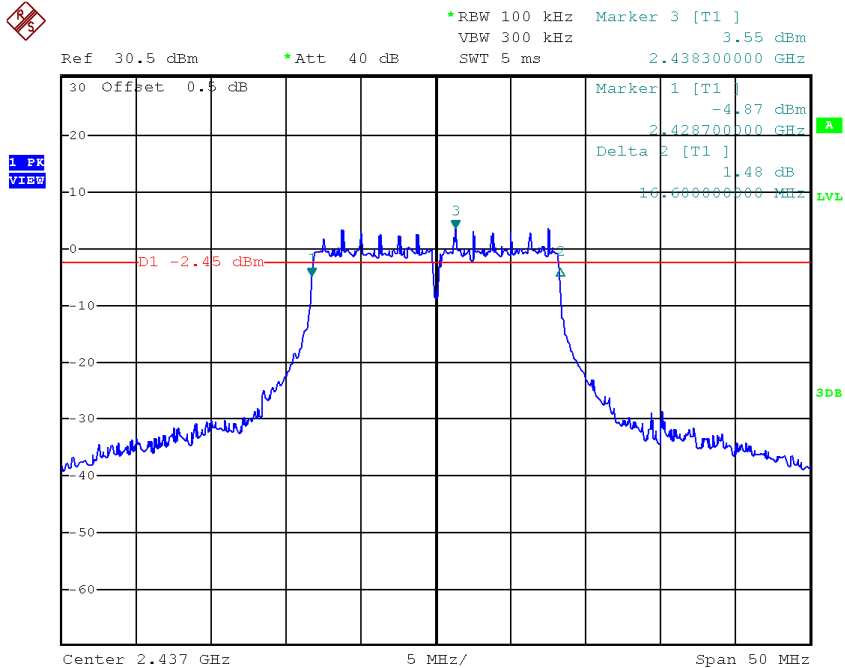

INTERTEK TESTING SERVICES

Plots of 6dB RF bandwidth (Antenna 1)

802.11g, Highest Channel

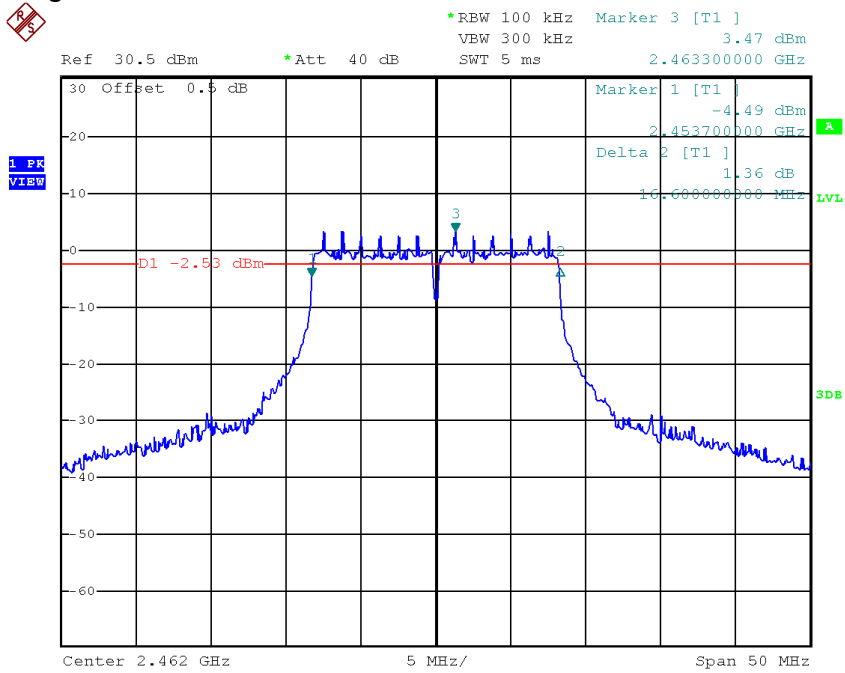

INTERTEK TESTING SERVICES

Plots of 6dB RF bandwidth (Antenna 0)

802.11n(20M), Highest Channel

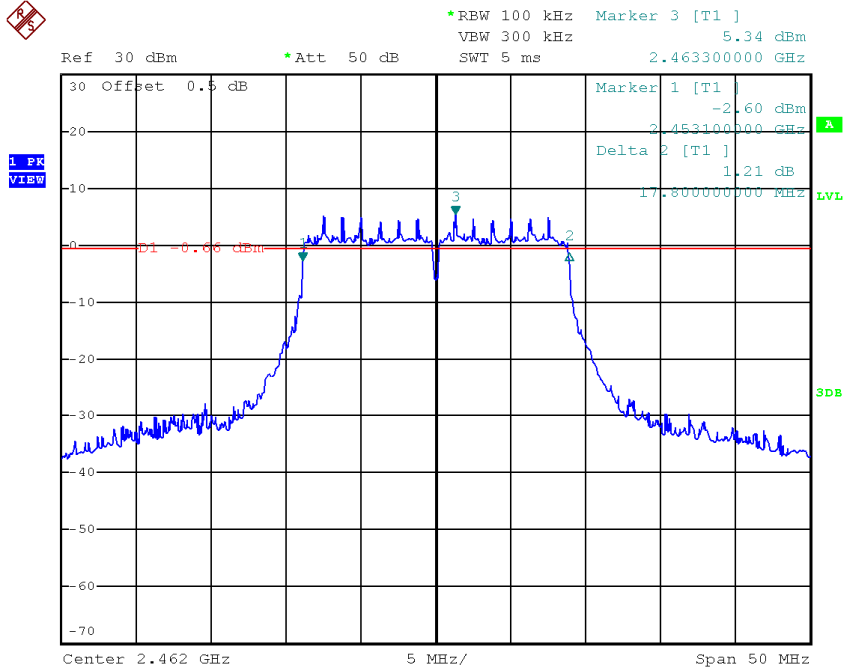

INTERTEK TESTING SERVICES

Plots of 6dB RF bandwidth (Antenna 1)

802.11n(20M), Lowest Channel

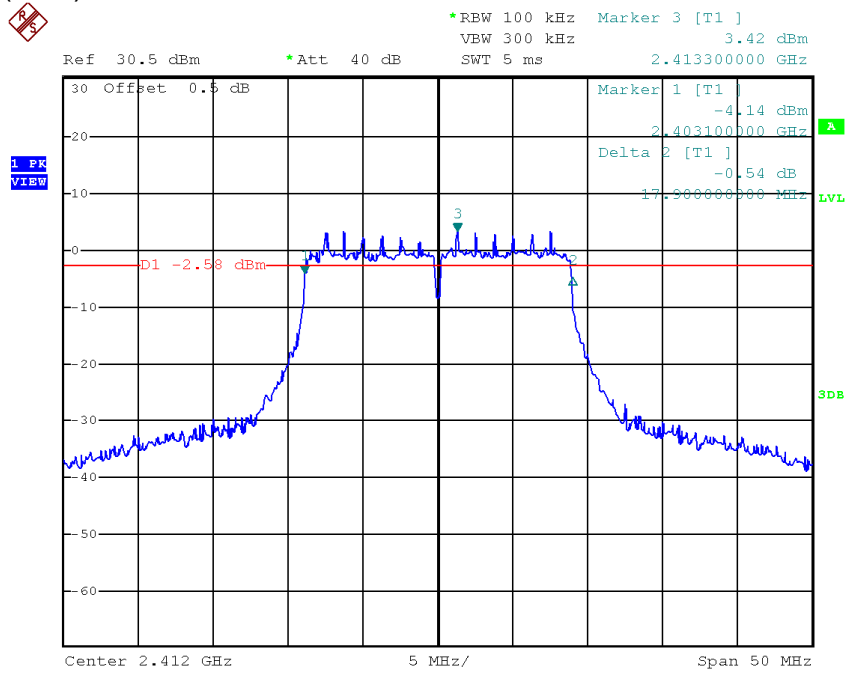

802.11n(20M), Middle Channel

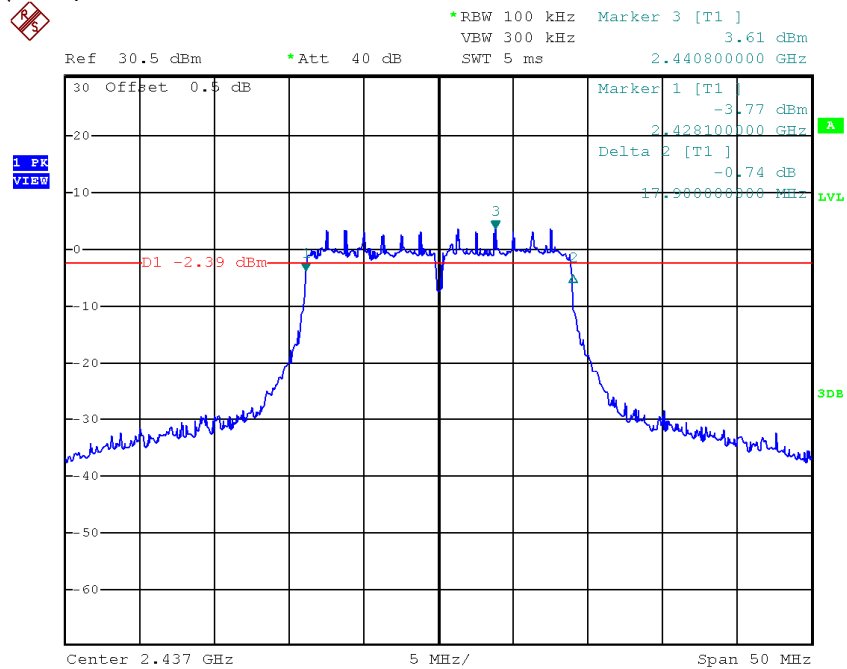

INTERTEK TESTING SERVICES

Plots of 6dB RF bandwidth (Antenna 1)

802.11n(20M), Highest Channel

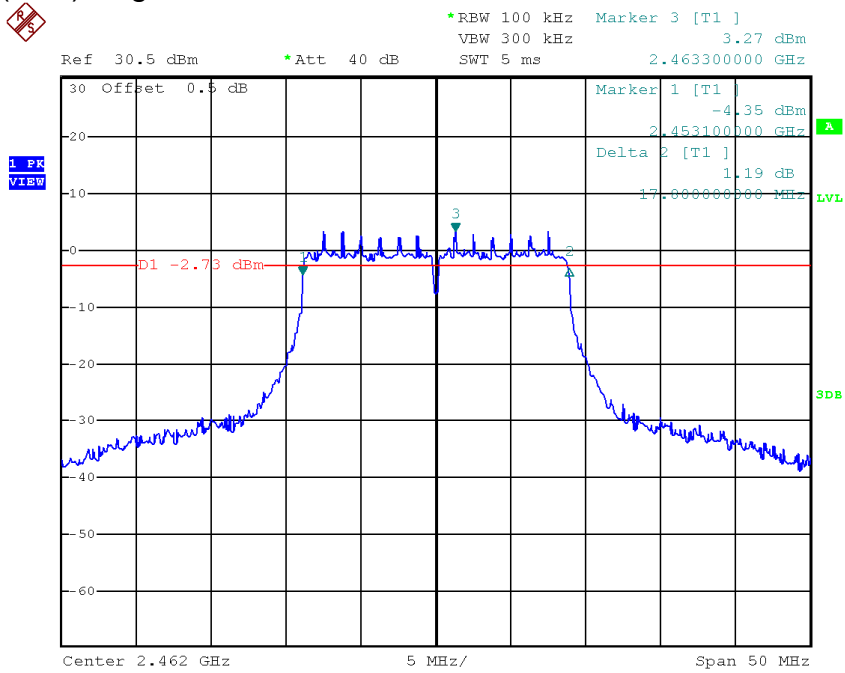

INTERTEK TESTING SERVICES

Plots of 6dB RF bandwidth (Antenna 0)

802.11n(40M), Lowest Channel

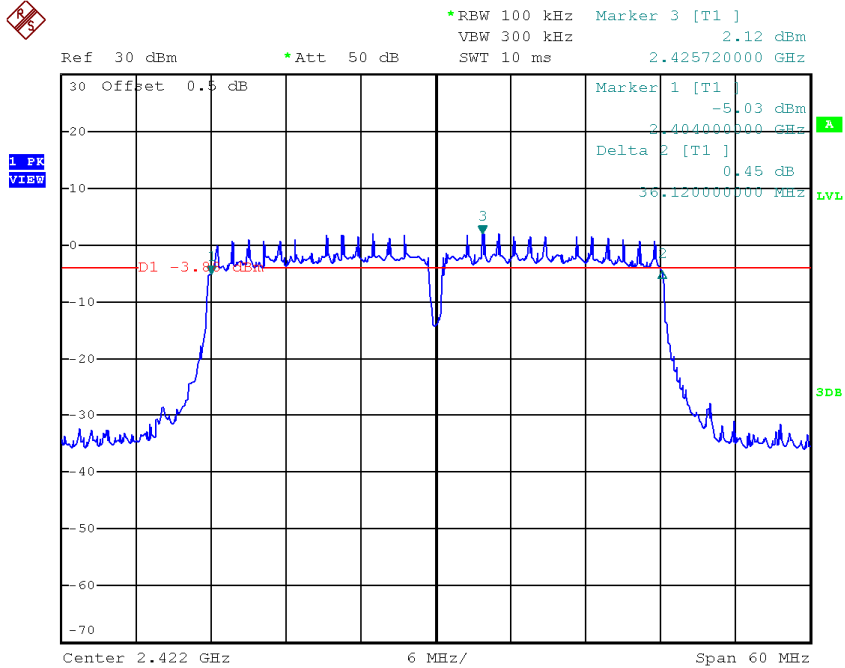

802.11n(40M), Middle Channel

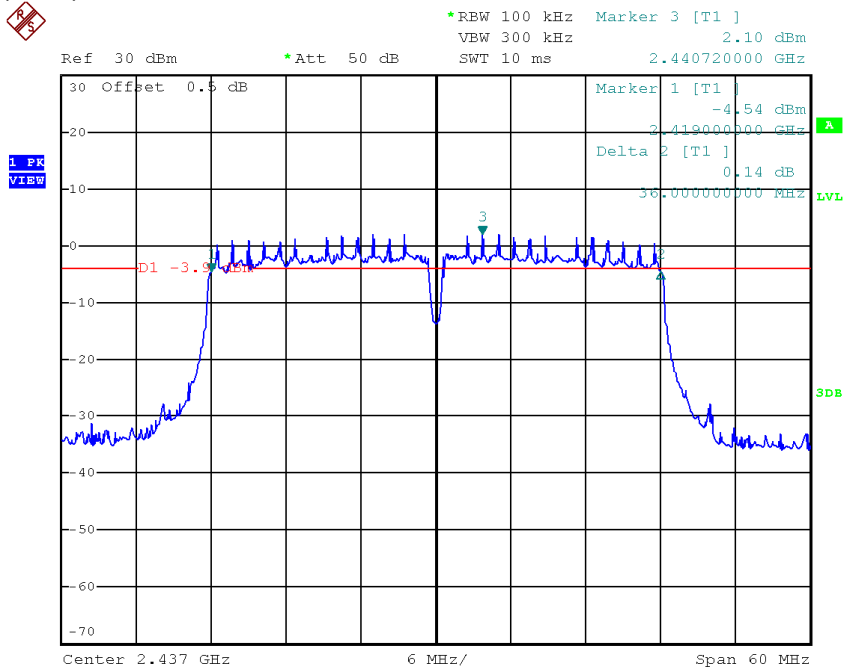

INTERTEK TESTING SERVICES

Plots of 6dB RF bandwidth (Antenna 0)

802.11n(40M), Highest Channel

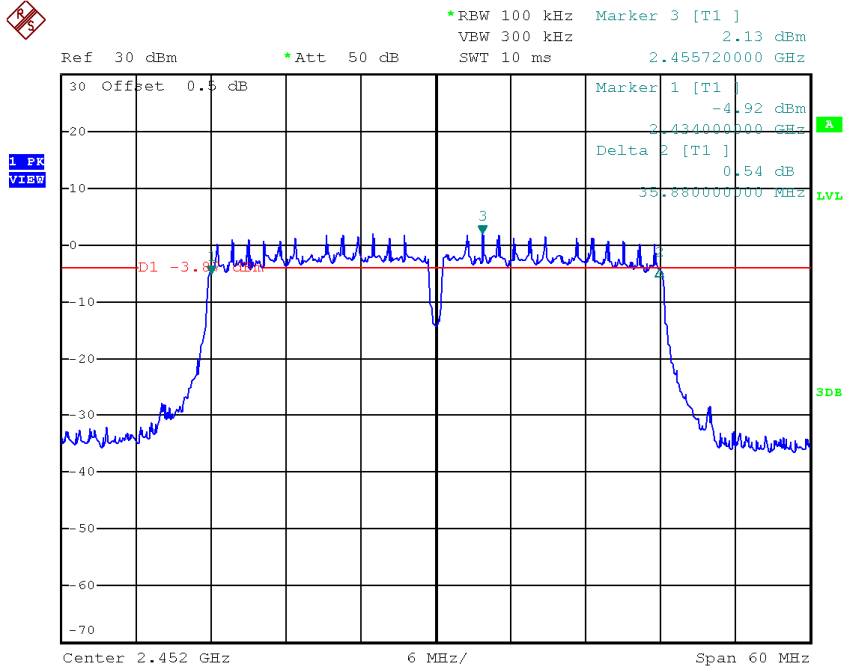

INTERTEK TESTING SERVICES

Plots of 6dB RF bandwidth (Antenna 1)

802.11n(40M), Lowest Channel

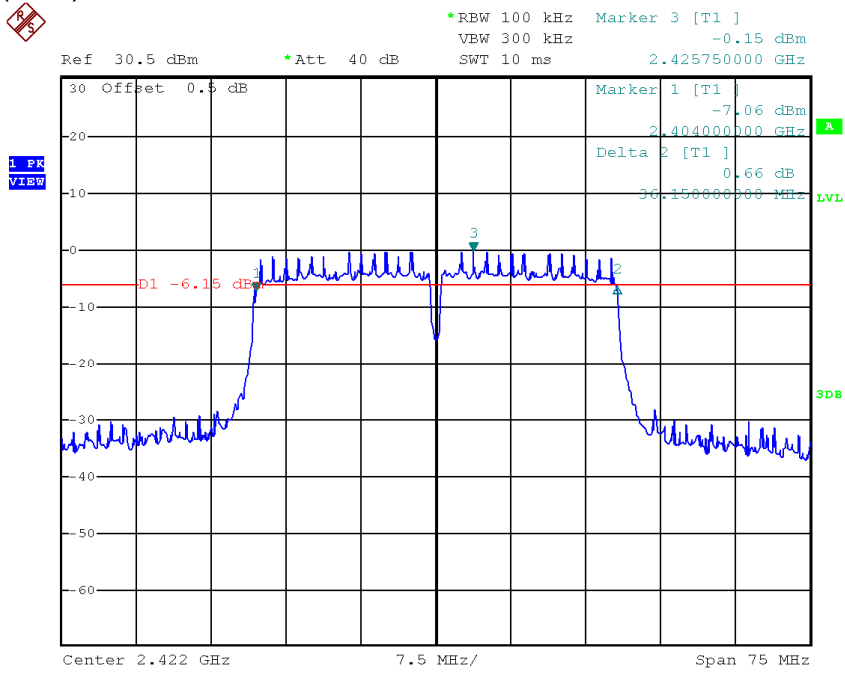

802.11n(40M), Middle Channel

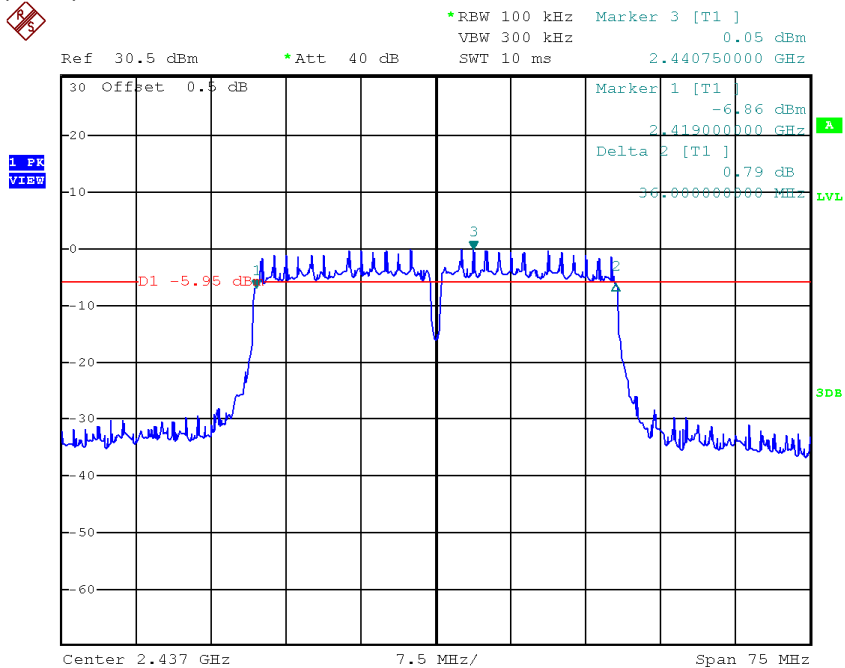

INTERTEK TESTING SERVICES

Plots of 6dB RF bandwidth (Antenna 1)

802.11n(40M), Highest Channel

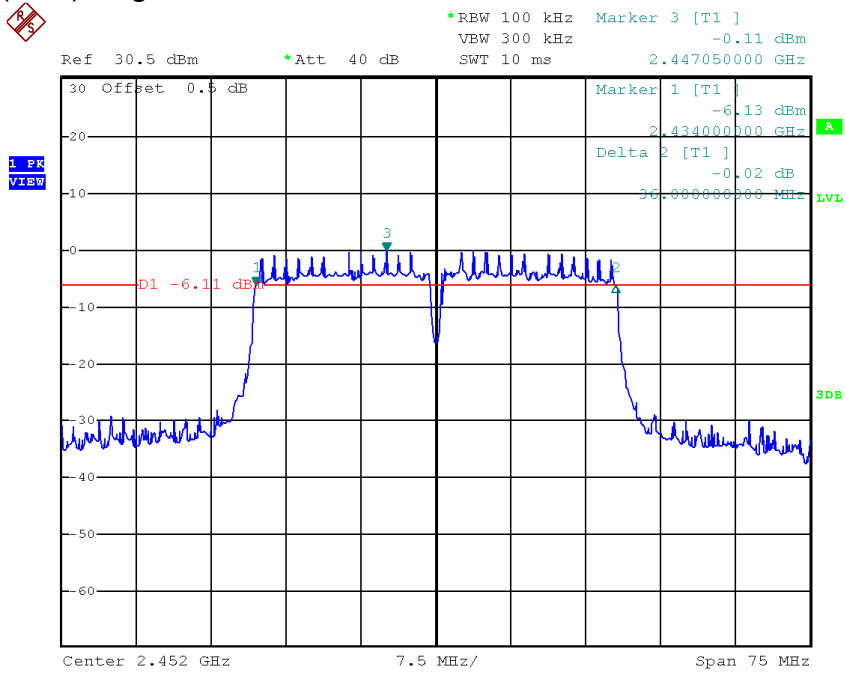

INTERTEK TESTING SERVICES

4.3 Maximum Power Spectral Density

Antenna output of the EUT was coupled directly to spectrum analyzer. The measurement procedure 10.2 PKPSD-1 was used. If an external attenuator and/or cable was used, these losses are compensated for using the OFFSET function of the analyser.

IEEE 802.11b (DSSS, 1 Mbps) (Antenna 0)		
Frequency (MHz)	PSD in 100kHz (dBm)	PSD in 3kHz (dBm)
Low Channel: 2412	--	7.27
Middle Channel: 2437	--	7.24
High Channel: 2462	--	5.47

IEEE 802.11b (DSSS, 1 Mbps) (Antenna 1)		
Frequency (MHz)	PSD in 100kHz (dBm)	PSD in 3kHz (dBm)
Low Channel: 2412	--	5.62
Middle Channel: 2437	--	4.98
High Channel: 2462	--	5.58

IEEE 802.11g (OFDM, 6 Mbps) (Antenna 0)		
Frequency (MHz)	PSD in 100kHz (dBm)	PSD in 3kHz (dBm)
Low Channel: 2412	5.59	--
Middle Channel: 2437	5.66	--
High Channel: 2462	5.33	--

IEEE 802.11g (OFDM, 6 Mbps) (Antenna 1)		
Frequency (MHz)	PSD in 100kHz (dBm)	PSD in 3kHz (dBm)
Low Channel: 2412	3.49	--
Middle Channel: 2437	3.70	--
High Channel: 2462	3.46	--

INTERTEK TESTING SERVICES

IEEE 802.11n (20MHz) (OFDM, MCS0) (Antenna 0)		
Frequency (MHz)	PSD in 100kHz (dBm)	PSD in 3kHz (dBm)
Low Channel: 2412	5.71	--
Middle Channel: 2437	5.72	--
High Channel: 2462	5.46	--

IEEE 802.11n (20MHz) (OFDM, MCS0) (Antenna 1)		
Frequency (MHz)	PSD in 100kHz (dBm)	PSD in 3kHz (dBm)
Low Channel: 2412	3.64	--
Middle Channel: 2437	3.66	--
High Channel: 2462	4.05	--

IEEE 802.11n (20MHz) (OFDM, MCS0)			
Frequency (MHz)	PSD in 100kHz (dBm)		
	Antenna 0	Antenna 1	Antenna 0 + Antenna 1
Low Channel: 2412	5.71	3.64	7.81
Middle Channel: 2437	5.72	3.66	7.82
High Channel: 2462	5.46	4.05	7.82

INTERTEK TESTING SERVICES

IEEE 802.11n (40MHz) (OFDM, MCS0) (Antenna 0)		
Frequency (MHz)	PSD in 100kHz (dBm)	PSD in 3kHz (dBm)
Low Channel: 2422	2.66	--
Middle Channel: 2437	2.47	--
High Channel: 2452	2.35	--

IEEE 802.11n (40MHz) (OFDM, MCS0) (Antenna 1)		
Frequency (MHz)	PSD in 100kHz (dBm)	PSD in 3kHz (dBm)
Low Channel: 2422	0.67	--
Middle Channel: 2437	0.75	--
High Channel: 2452	0.66	--

IEEE 802.11n (20MHz) (OFDM, MCS0)			
Frequency (MHz)	PSD in 100kHz (dBm)		
	Antenna 0	Antenna 1	Antenna 0 + Antenna 1
Low Channel: 2422	2.66	0.67	4.79
Middle Channel: 2437	2.47	0.75	4.70
High Channel: 2452	2.35	0.66	4.60

Cable Loss: 0.5 dB

Limit:
8dBm

The plots of power spectral density are as below.

INTERTEK TESTING SERVICES

Plots of power spectral density in 3KHz (Antenna 0) 802.11b, Lowest channel

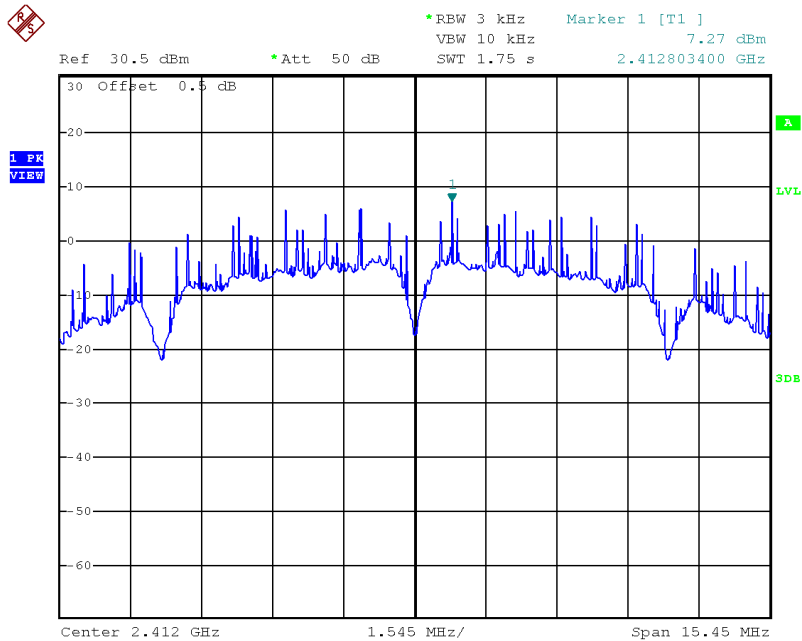

802.11b, Middle channel

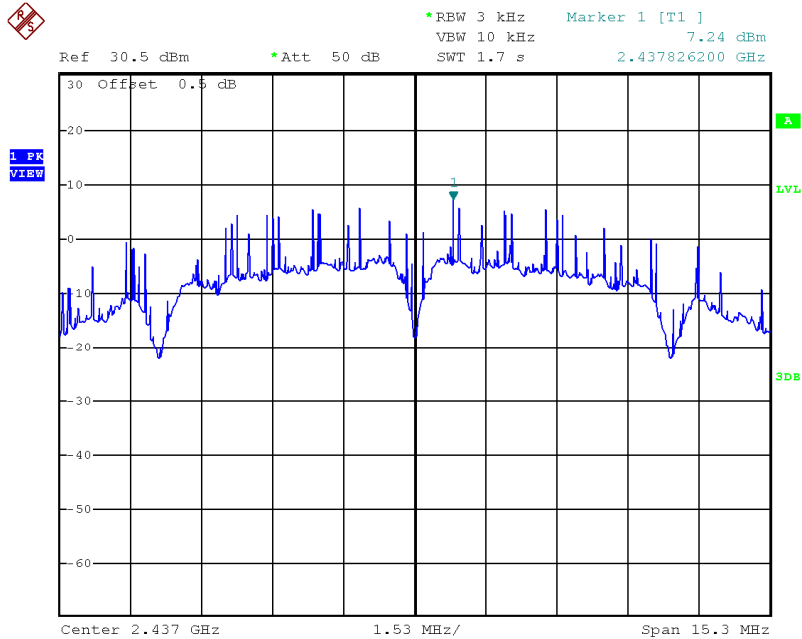

INTERTEK TESTING SERVICES

Plots of power spectral density in 3KHz (Antenna 0) 802.11b, Highest channel

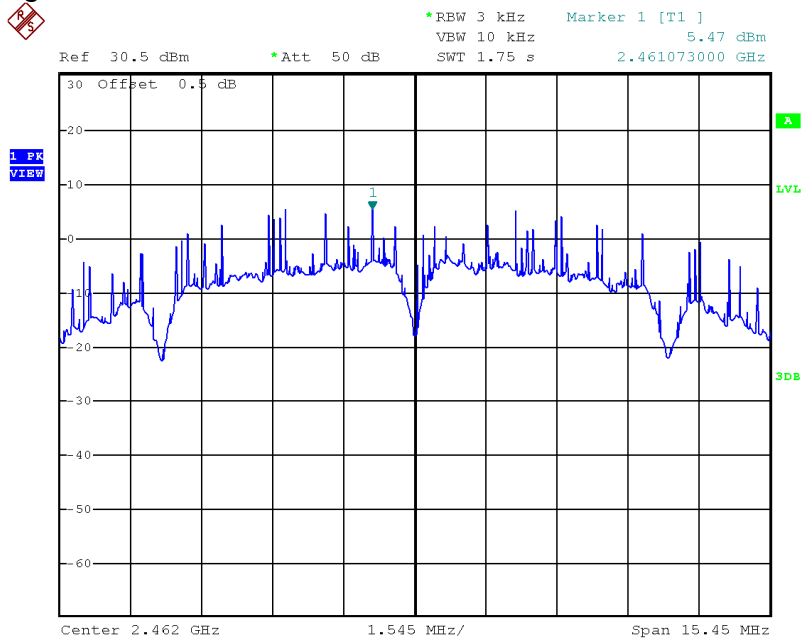

INTERTEK TESTING SERVICES

Plots of power spectral density in 3KHz (Antenna 1) 802.11b, Lowest channel

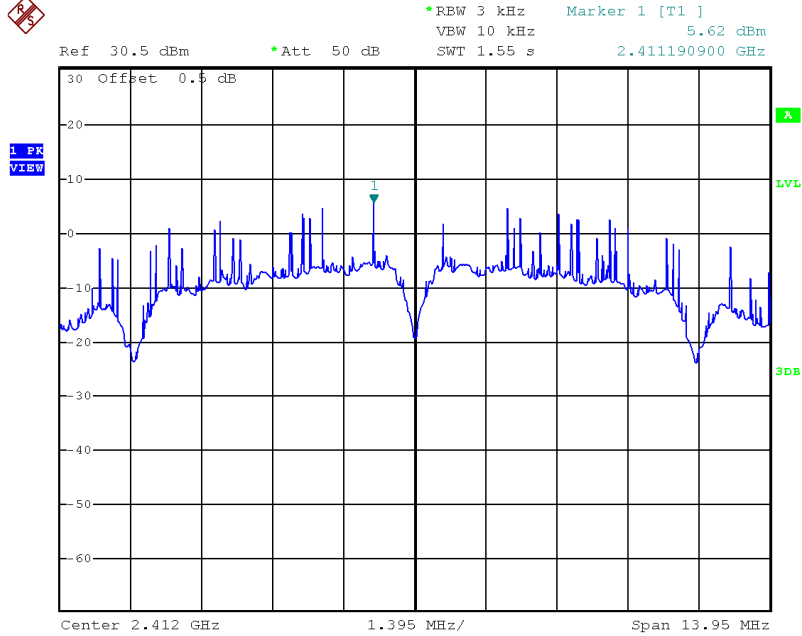

802.11b, Middle channel

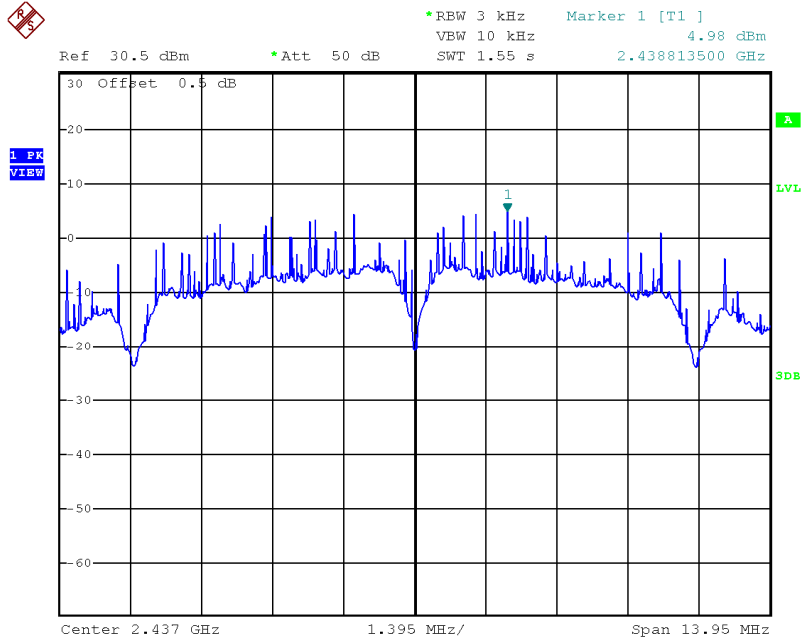

INTERTEK TESTING SERVICES

Plots of power spectral density in 3KHz (Antenna 1) 802.11b, Highest channel

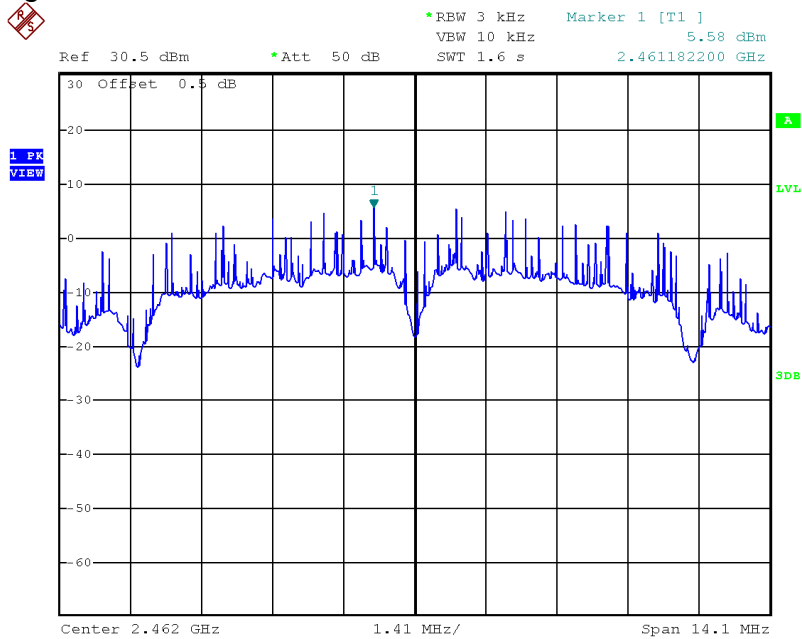

INTERTEK TESTING SERVICES

Plots of power spectral density (Antenna 0) 802.11g, Lowest channel

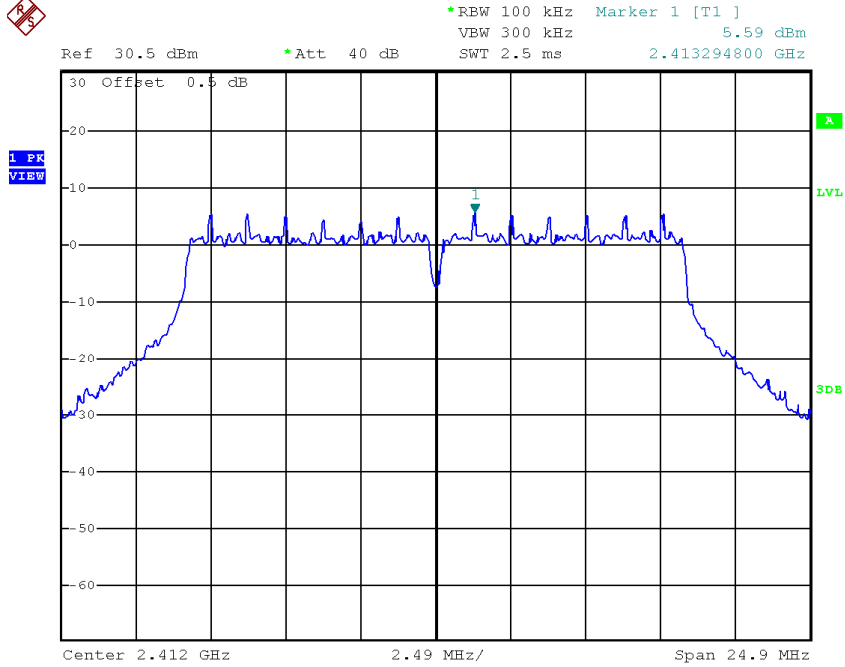

802.11g, Middle channel

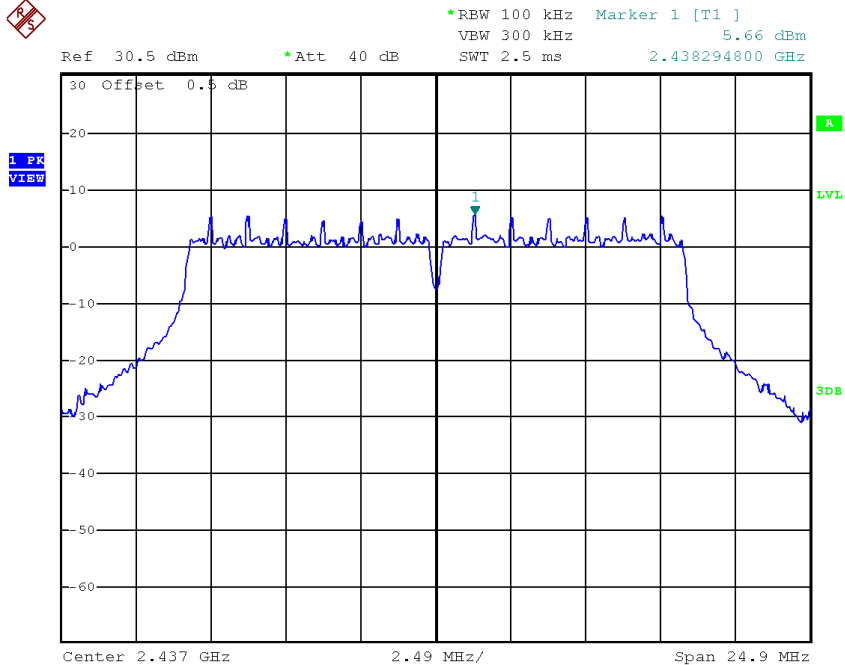

INTERTEK TESTING SERVICES

Plots of power spectral density (Antenna 0)

802.11g, Highest channel

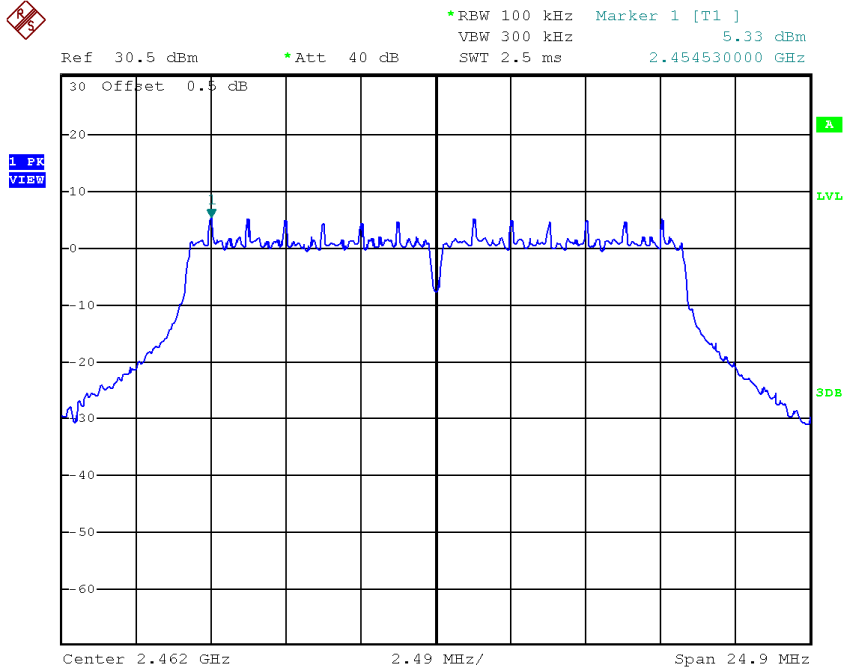

INTERTEK TESTING SERVICES

Plots of power spectral density (Antenna 1)

802.11g, Lowest channel

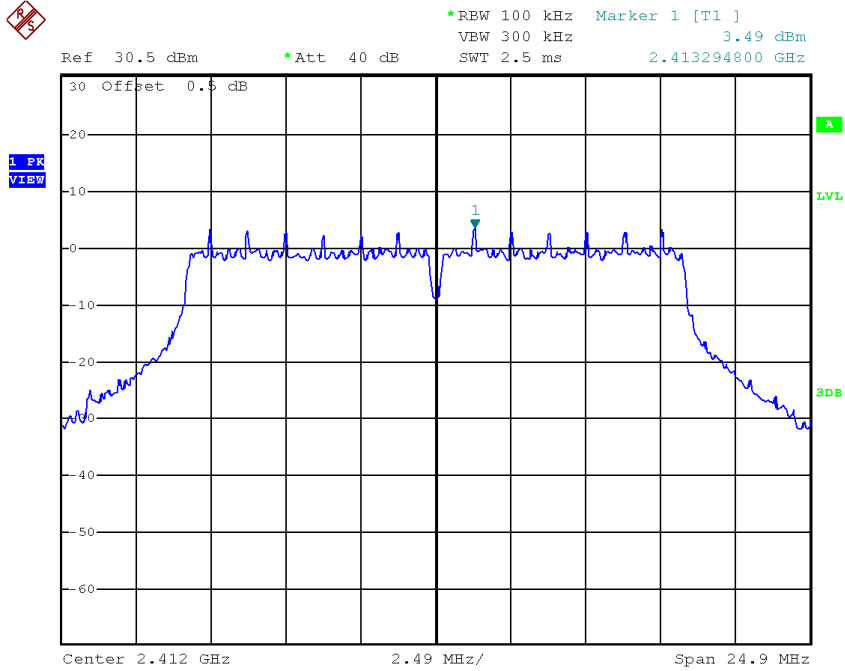

802.11g, Middle channel

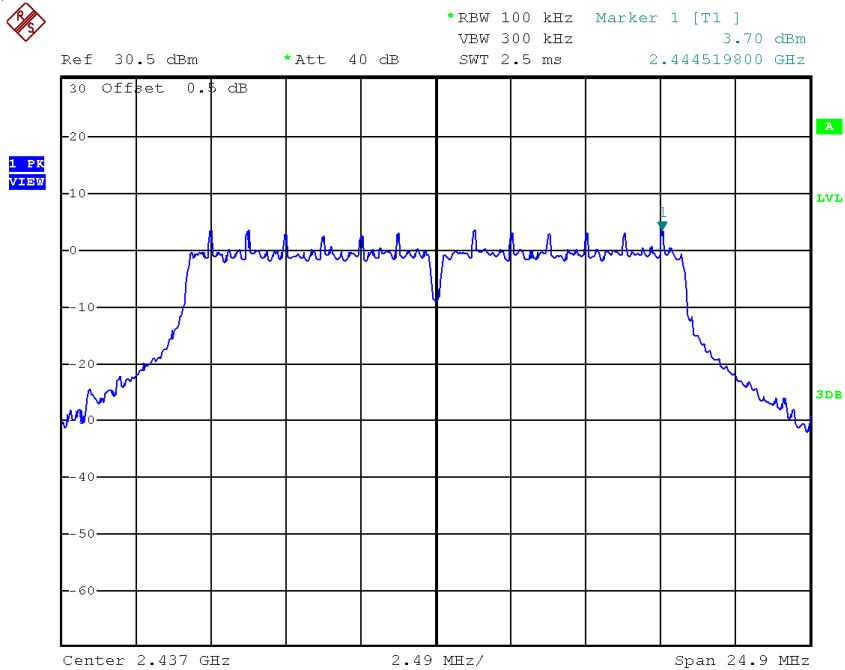

INTERTEK TESTING SERVICES

Plots of power spectral density (Antenna 1)

802.11g, Highest channel

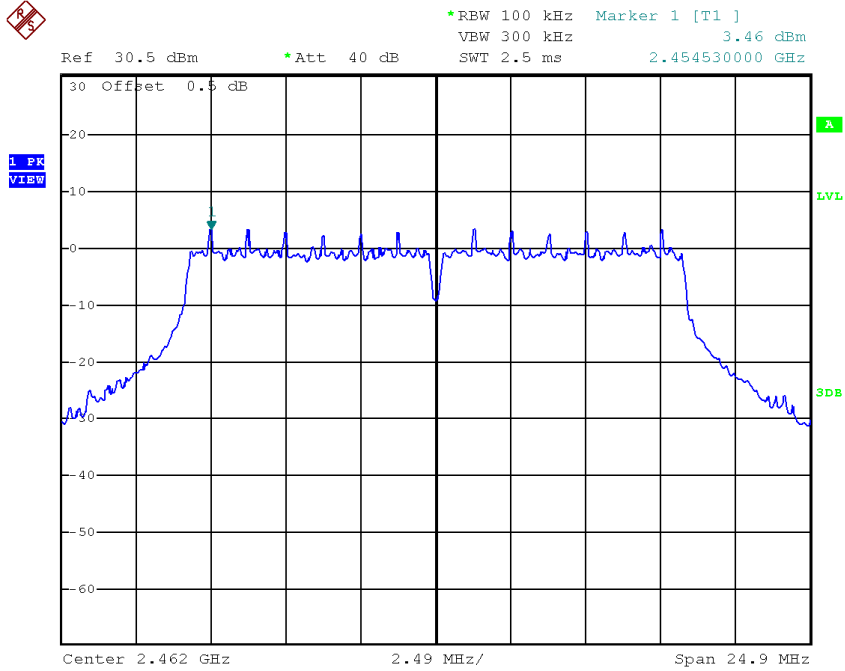

INTERTEK TESTING SERVICES

Plots of power spectral density (Antenna 0)

802.11n(20M), Lowest channel

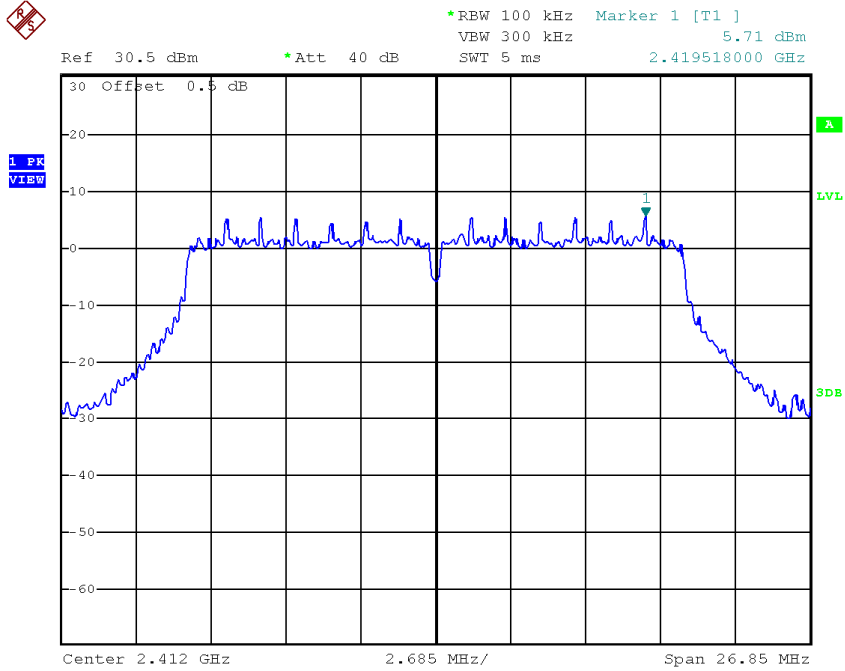

802.11n(20M), Middle channel

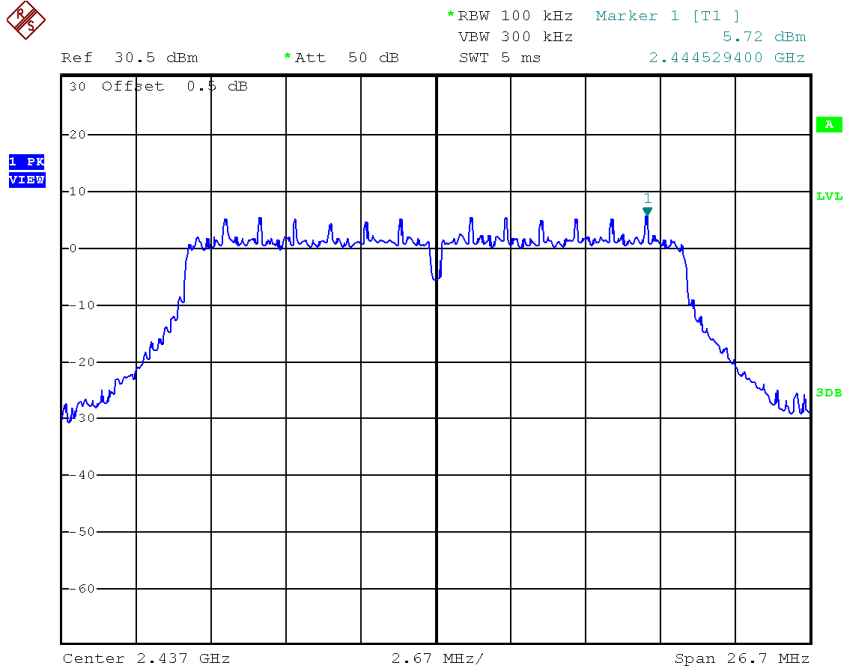

INTERTEK TESTING SERVICES

Plots of power spectral density (Antenna 0) 802.11n(20M), Highest channel

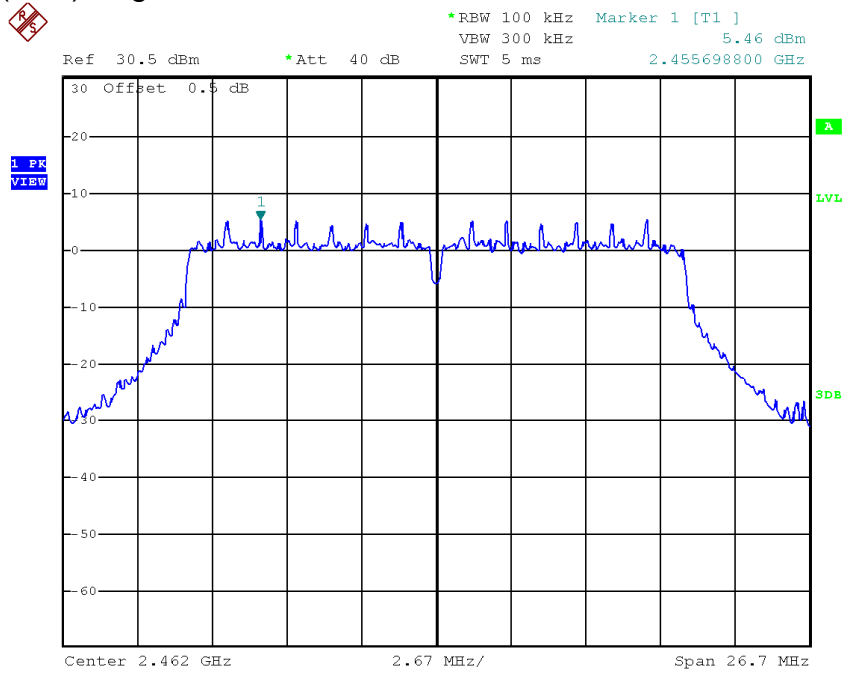

INTERTEK TESTING SERVICES

Plots of power spectral density (Antenna 1)

802.11n(20M), Lowest channel

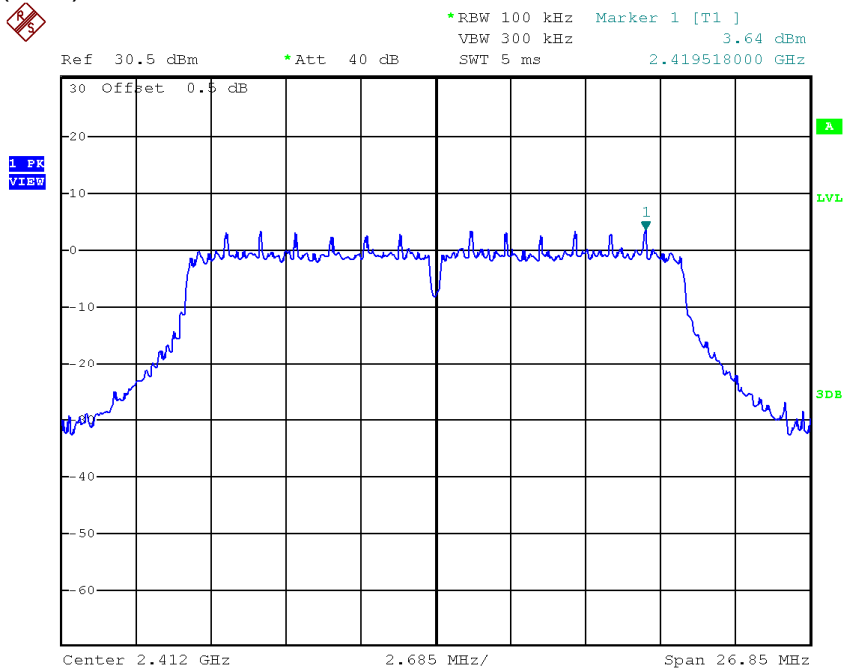

802.11n(20M), Middle channel

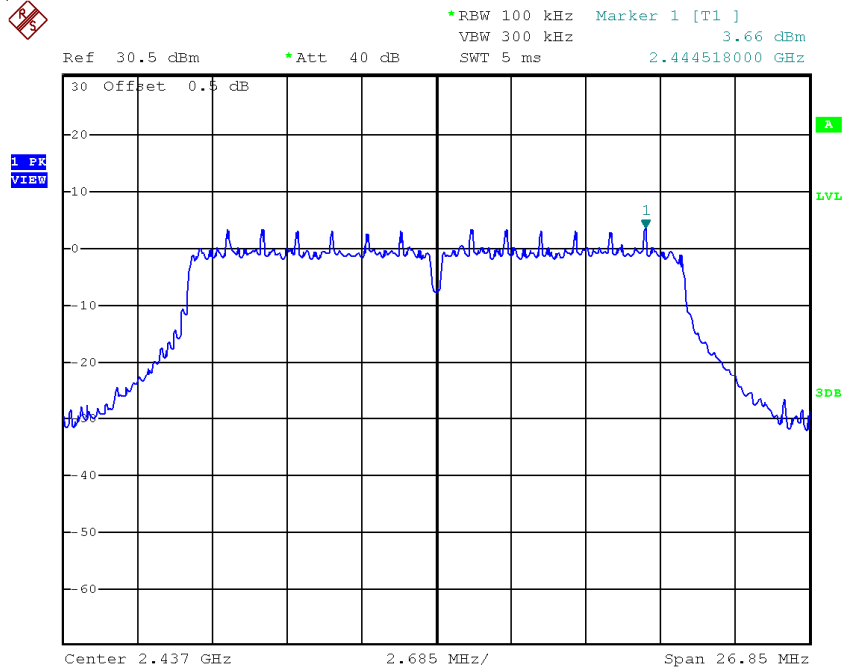

INTERTEK TESTING SERVICES

Plots of power spectral density (Antenna 1)

802.11n(20M), Highest channel

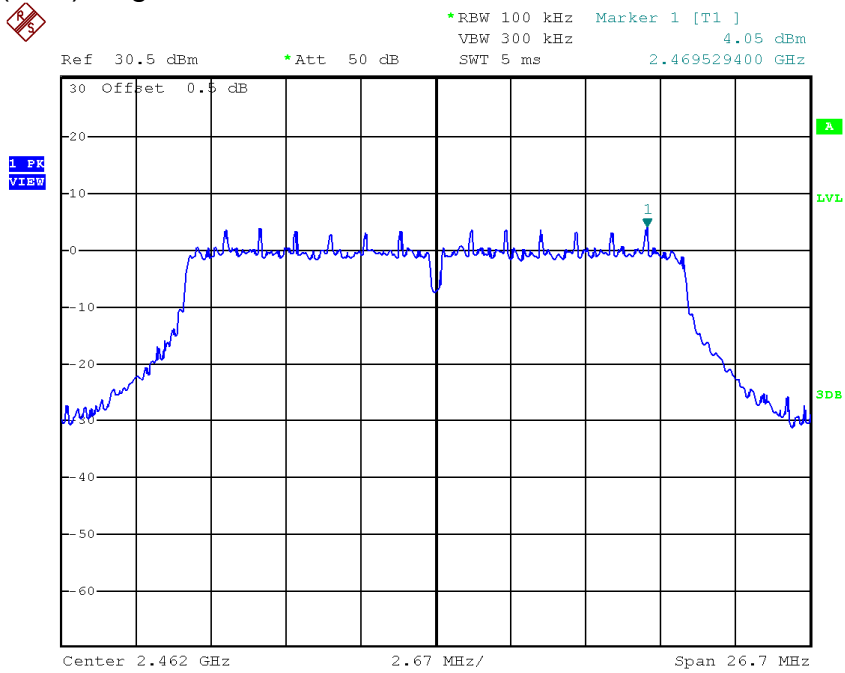

INTERTEK TESTING SERVICES

Plots of power spectral density (Antenna 0)

802.11n(40M), Lowest channel

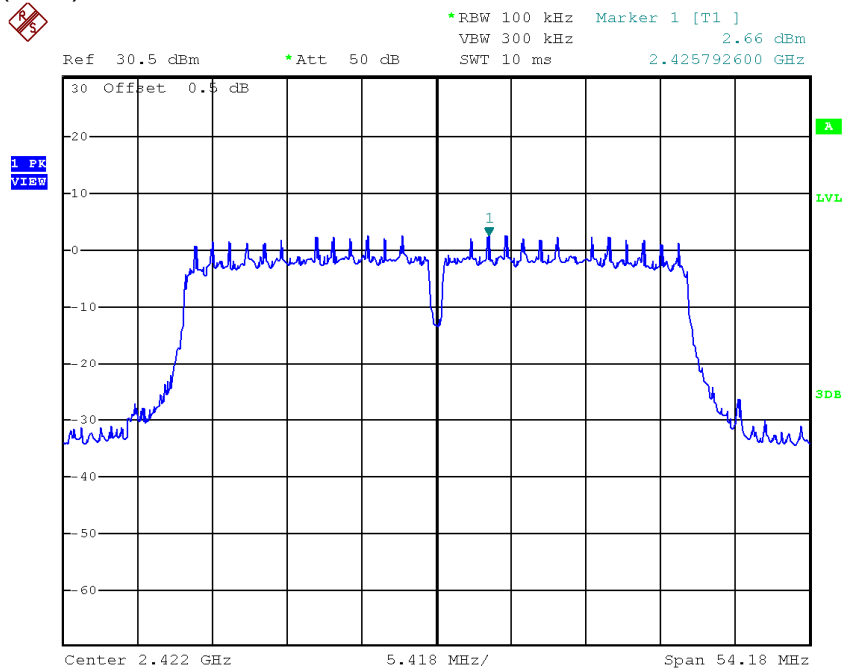

802.11n(40M), Middle channel

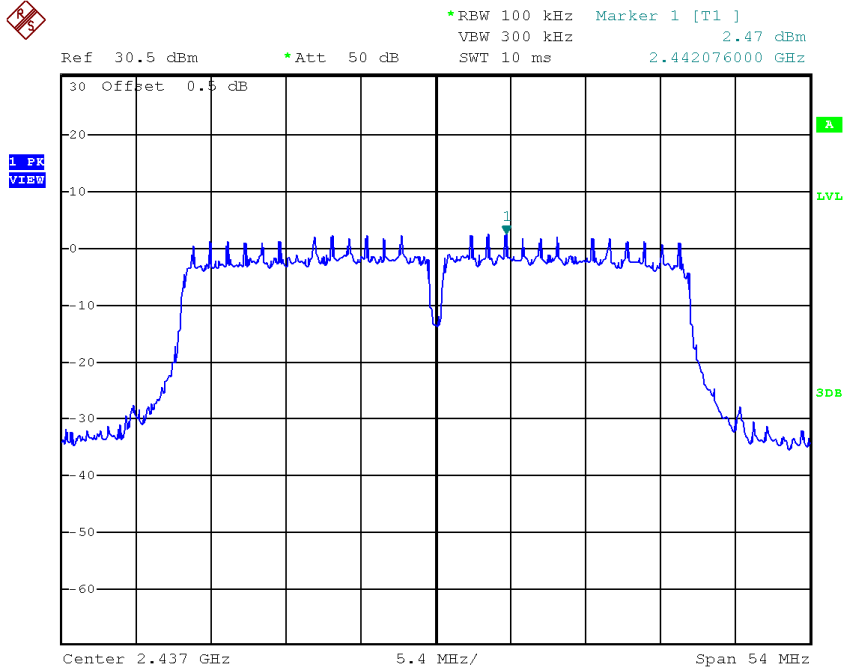

INTERTEK TESTING SERVICES

Plots of power spectral density (Antenna 0)

802.11n(40M), Highest channel

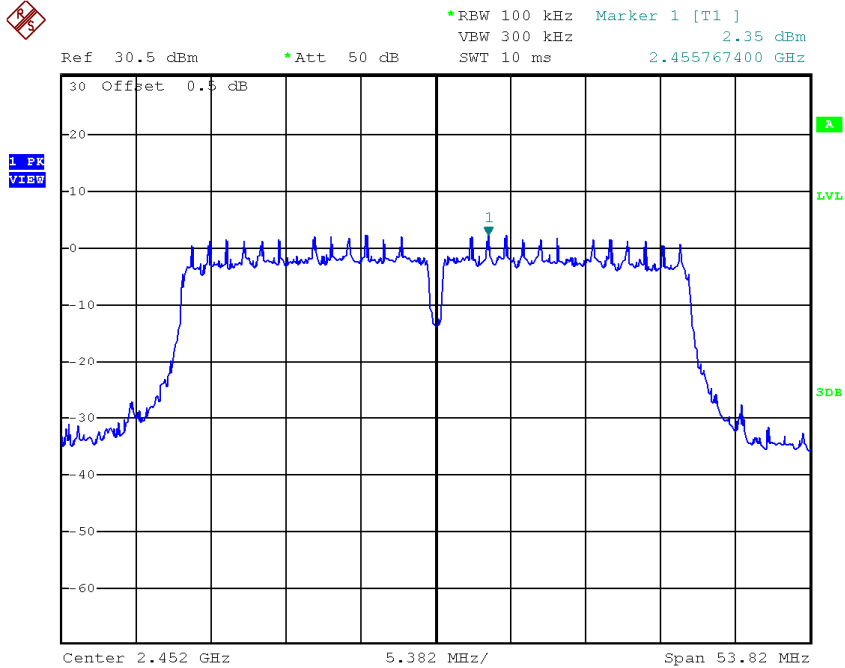

INTERTEK TESTING SERVICES

Plots of power spectral density (Antenna 1)

802.11n(40M), Lowest channel

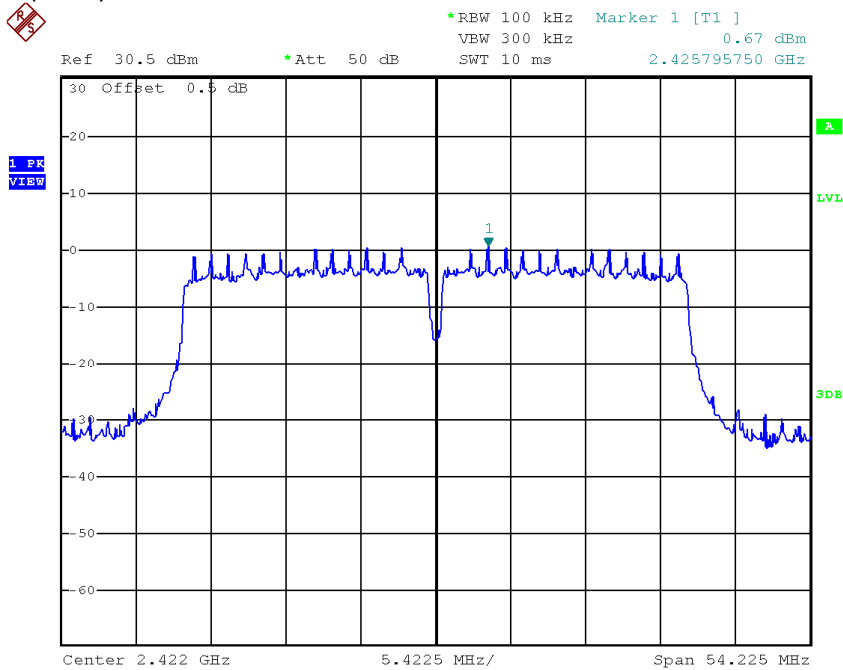

802.11n(40M), Middle channel

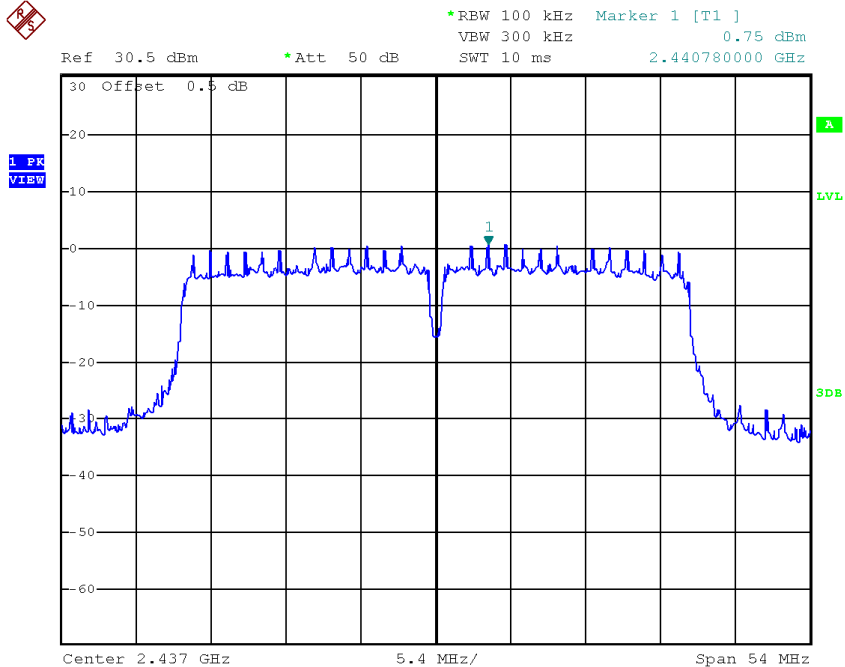

INTERTEK TESTING SERVICES

Plots of power spectral density (Antenna 1)

802.11n(40M), Highest channel

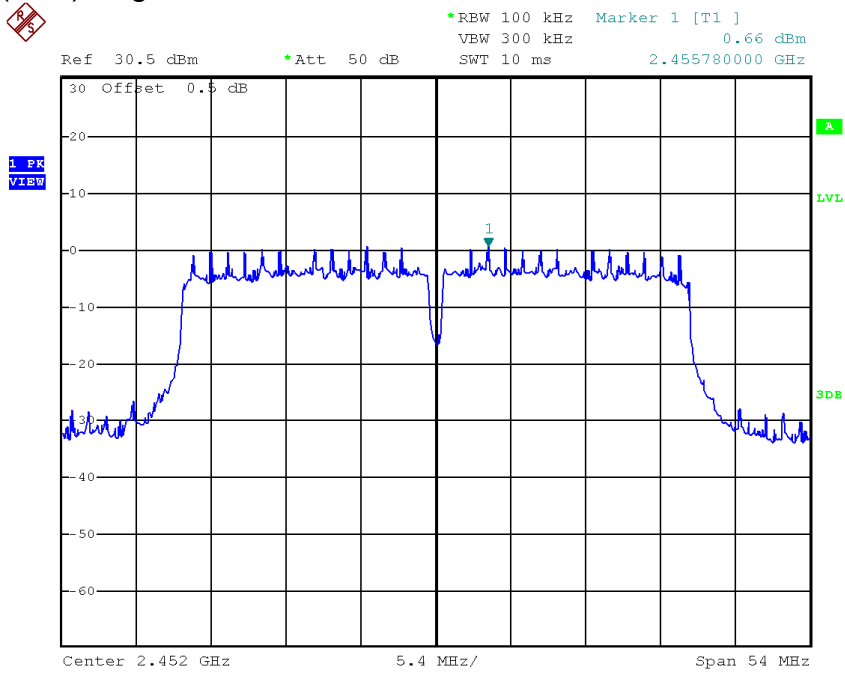

INTERTEK TESTING SERVICES

4.4 Out of Band Conducted Emissions

For 802.11b/g/n20MHz/N40MHz, the maximum conducted (peak) output power was used to demonstrate compliance as described in 9.1. Then the display line (in red) shown in the following plots denotes the limit at 20dB below maximum measured in-band peak PSD level in 100 KHz bandwidth.

The measurement procedures under sections 11 of KDB558074 D01 v03r03 (08-April-2016) were used.

Furthermore, delta measurement technique for measuring bandedge emissions was incorporated in the test of the edge at 2483.5MHz.

Limits:

All spurious emission and up to the tenth harmonic was measured and they were found to be at least 20 dB for 802.11b,g,n20MHz,n40MHz below the maximum measured in-band peak PSD level.

The plots of reference level measurement and out of band conducted emissions are as below.

INTERTEK TESTING SERVICES

Plots of power spectral density in 100KHz (Antenna 0) 802.11b, Lowest channel

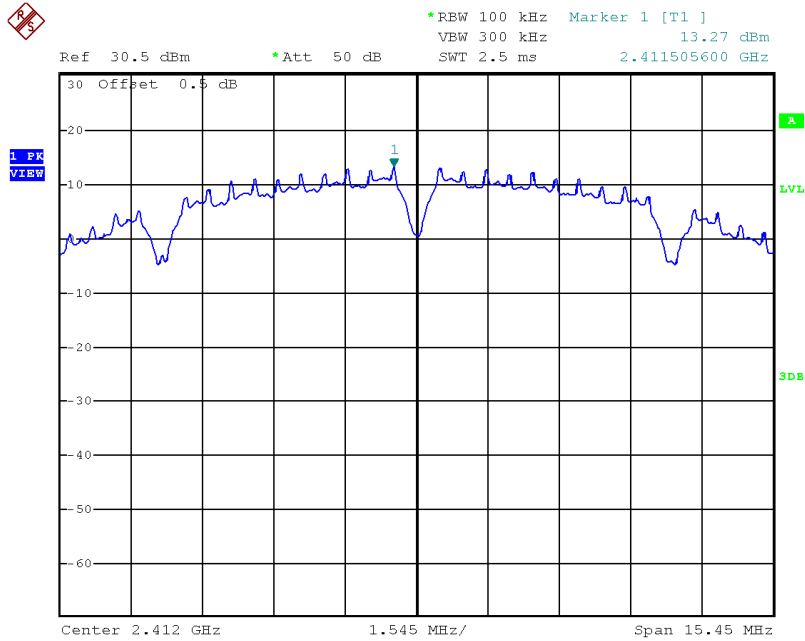

802.11b, Middle channel

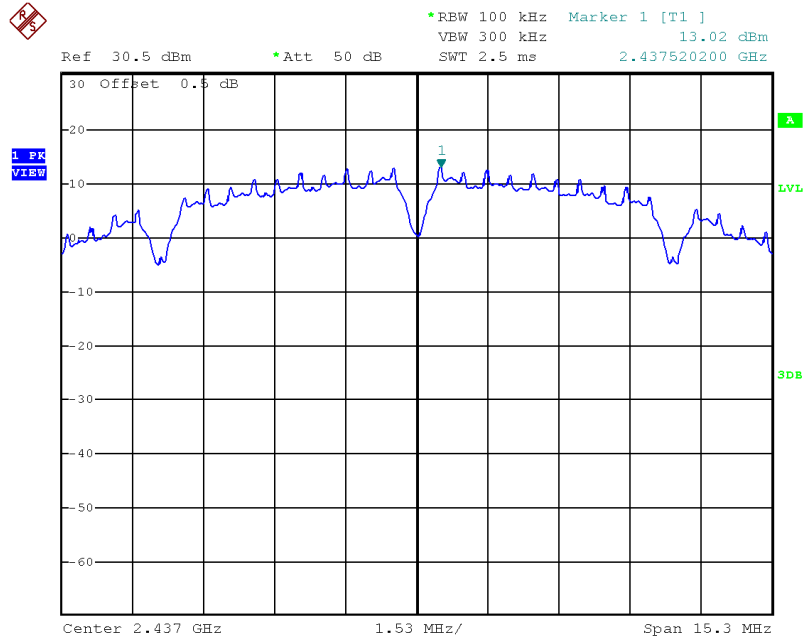

INTERTEK TESTING SERVICES

Plots of power spectral density in 100KHz (Antenna 0)

802.11b, Highest channel

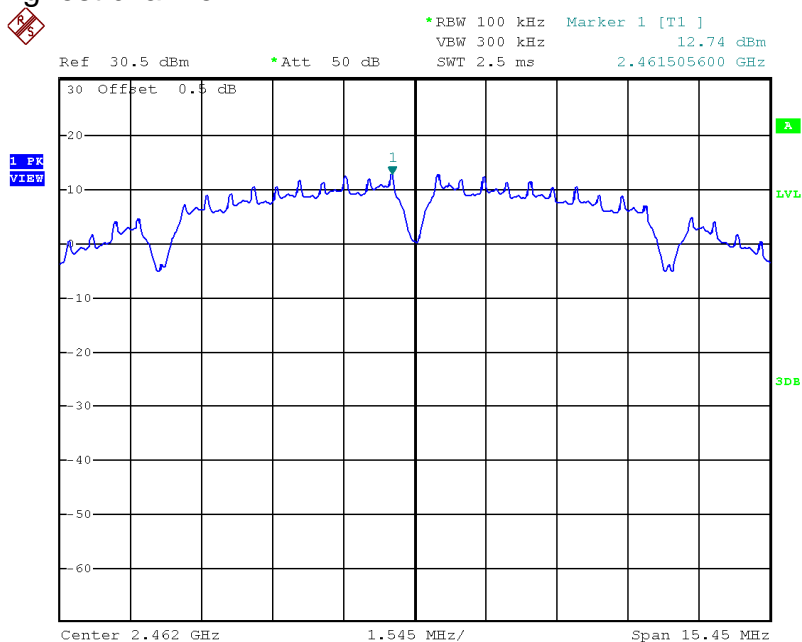

INTERTEK TESTING SERVICES

Plots of out of band conducted emissions (Antenna 0)

802.11b, Lowest Channel, Plot A

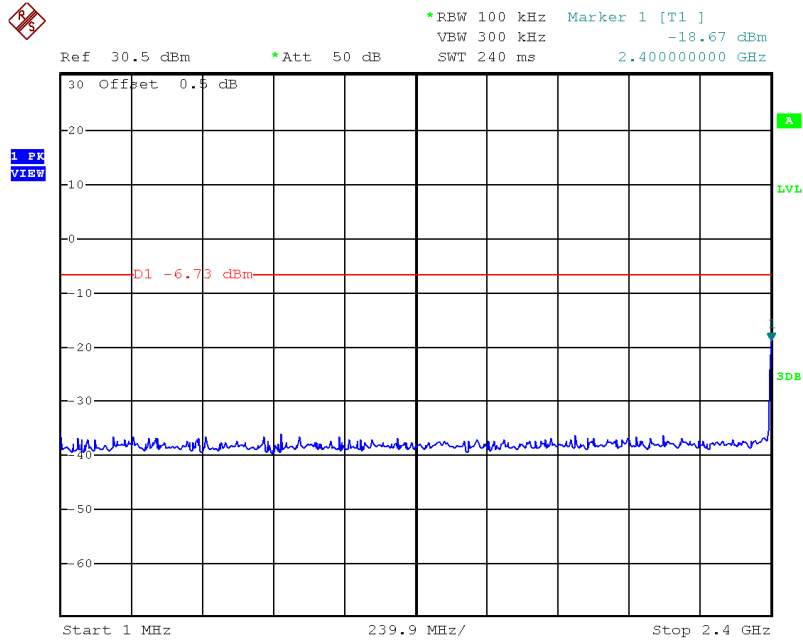

802.11b, Lowest Channel, Plot B

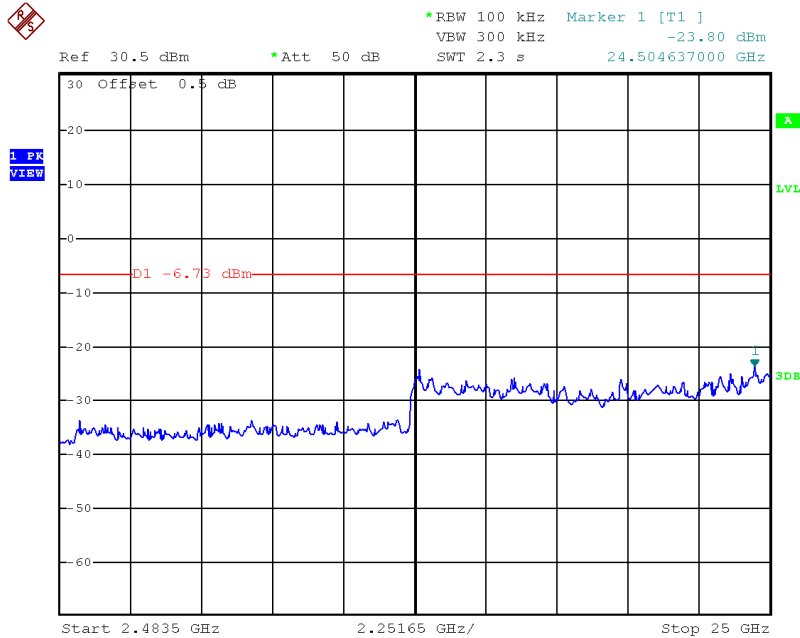

INTERTEK TESTING SERVICES

Plots of out of band conducted emissions (Antenna 0) 802.11b, Middle Channel, Plot A

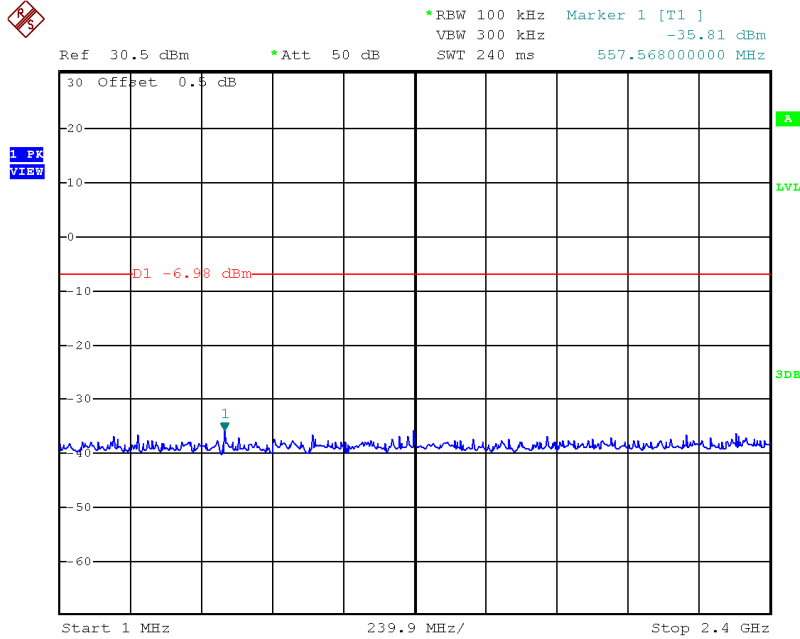

802.11b, Middle Channel, Plot B

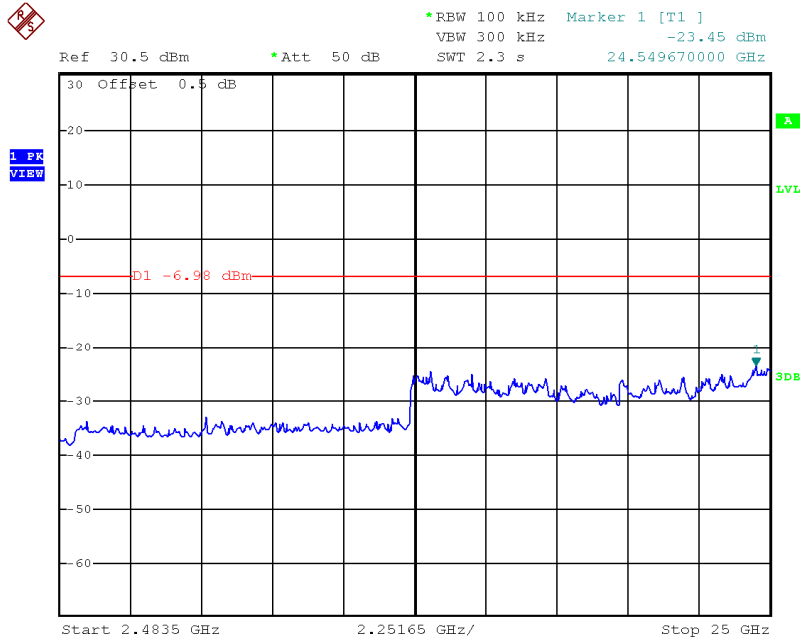

INTERTEK TESTING SERVICES

Plots of out of band conducted emissions (Antenna 0) 802.11b, Highest Channel, Plot A

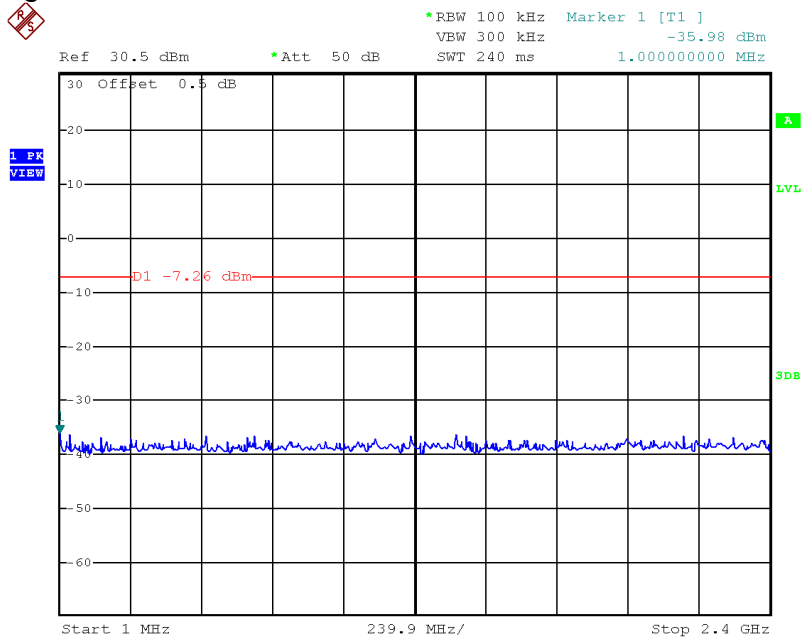

802.11b, Highest Channel, Plot B

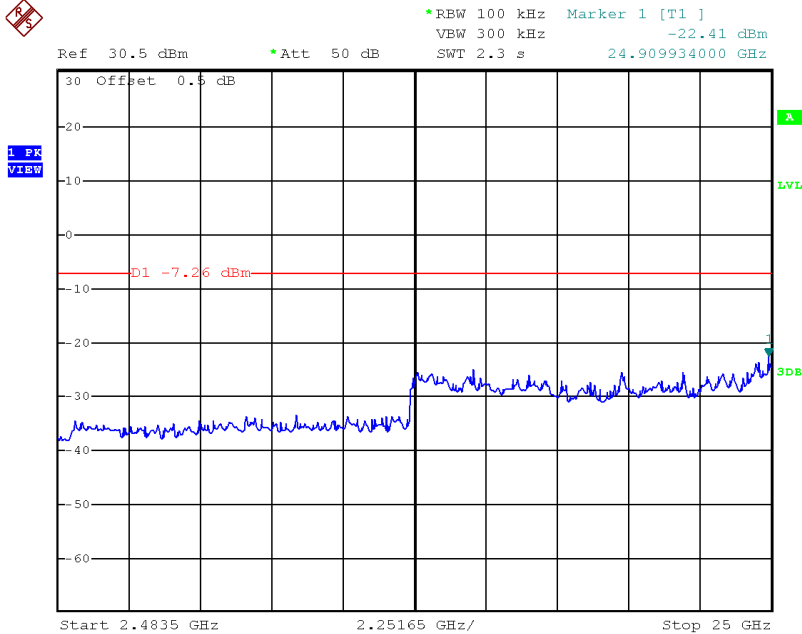

INTERTEK TESTING SERVICES

Plots of power spectral density in 100KHz (Antenna 1) 802.11b, Lowest channel

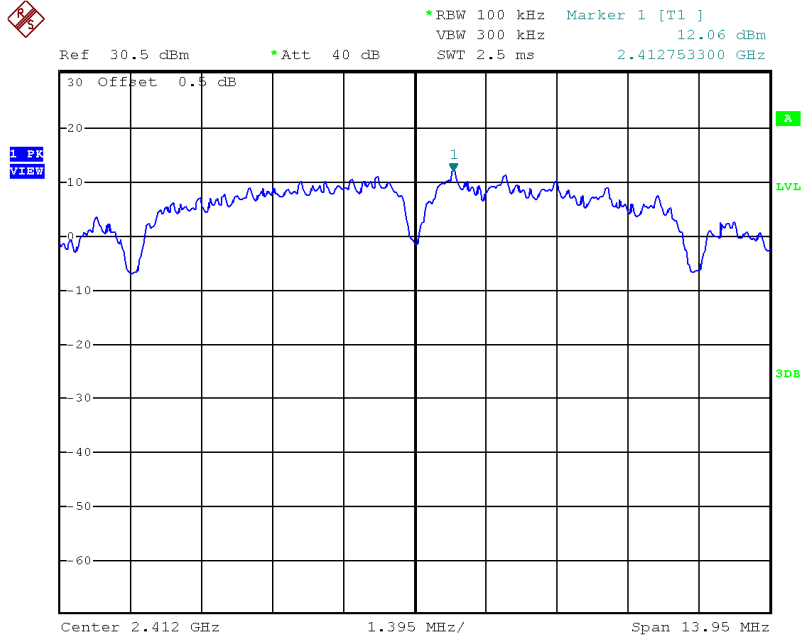

802.11b, Middle channel

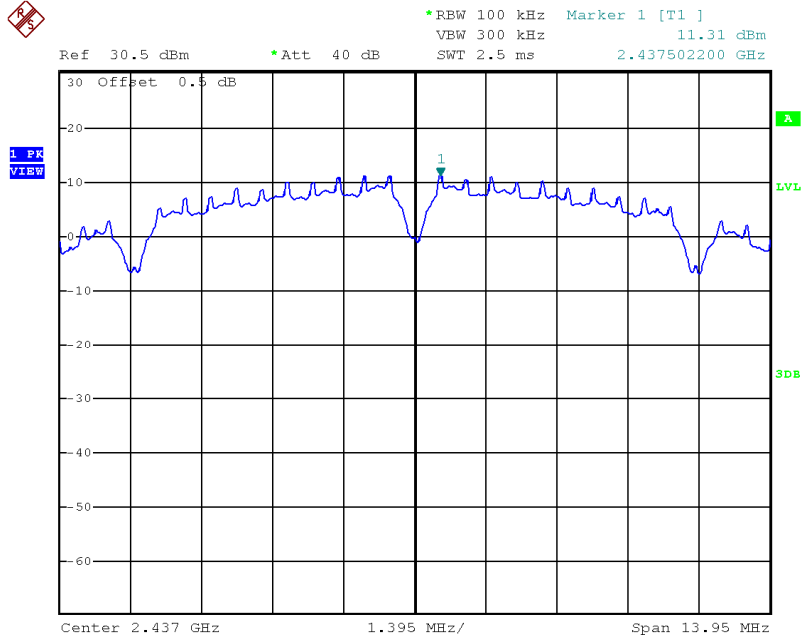

INTERTEK TESTING SERVICES

Plots of power spectral density in 100KHz (Antenna 1)

802.11b, Highest channel

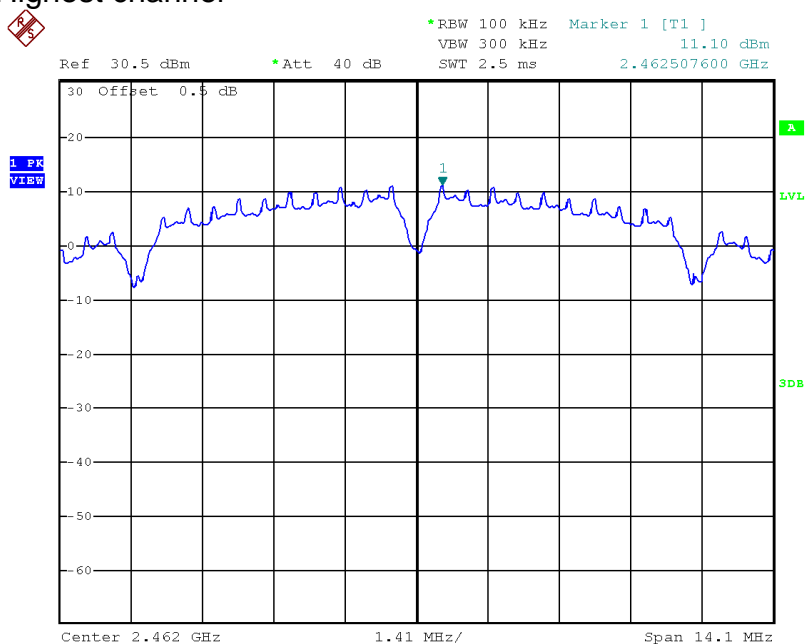

INTERTEK TESTING SERVICES

Plots of out of band conducted emissions (Antenna 1) 802.11b, Lowest Channel, Plot A

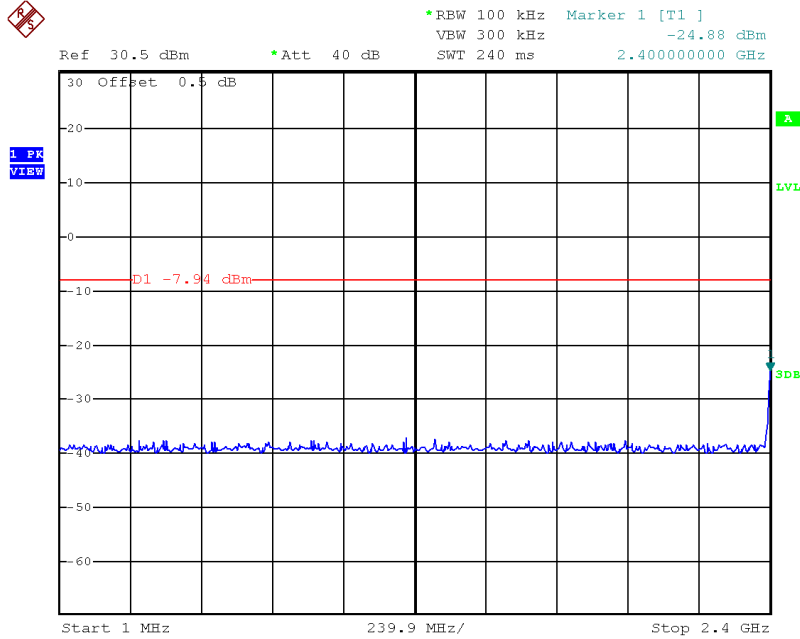

802.11b, Lowest Channel, Plot B

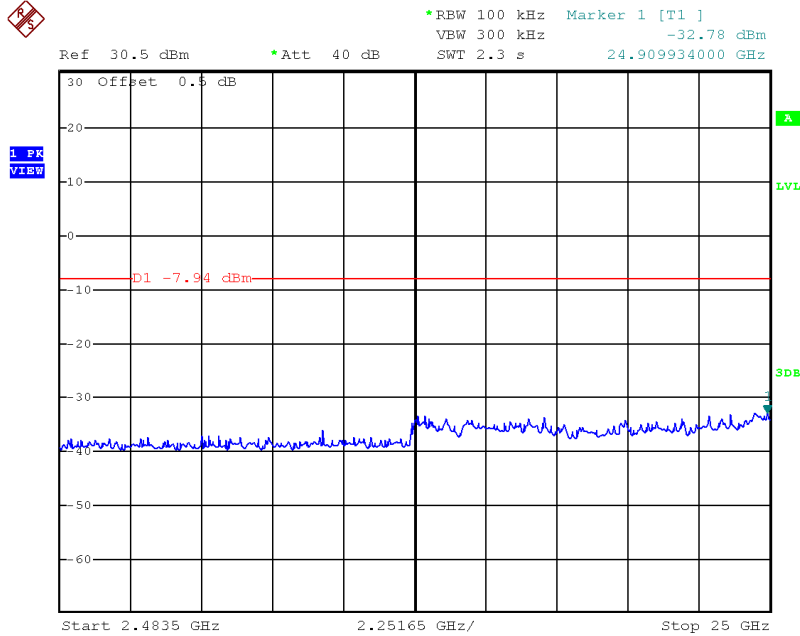

INTERTEK TESTING SERVICES

Plots of out of band conducted emissions (Antenna 1) 802.11b, Middle Channel, Plot A

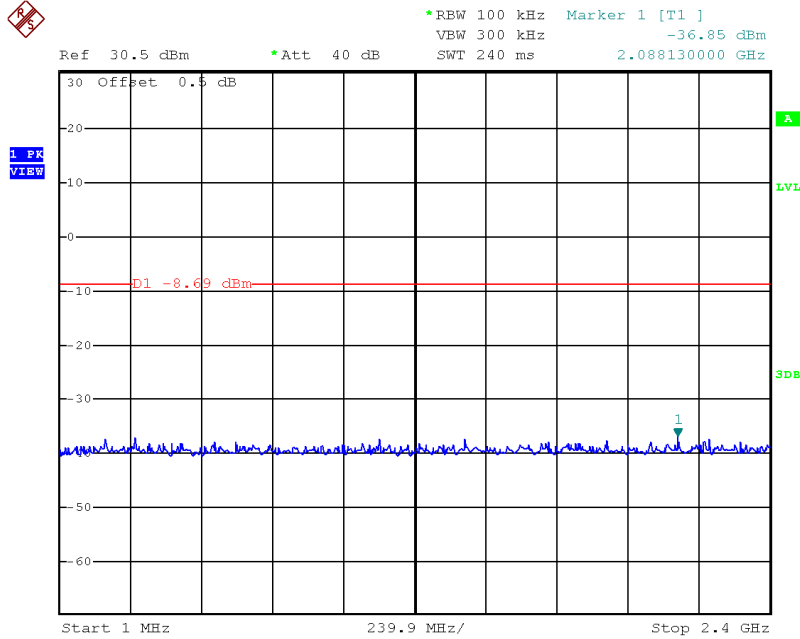

802.11b, Middle Channel, Plot B

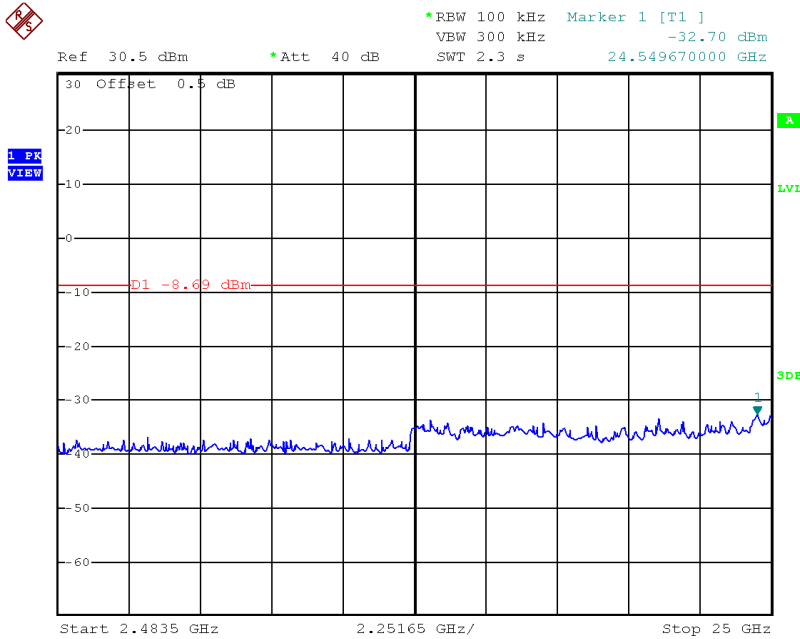

INTERTEK TESTING SERVICES

Plots of out of band conducted emissions (Antenna 1) 802.11b, Highest Channel, Plot A

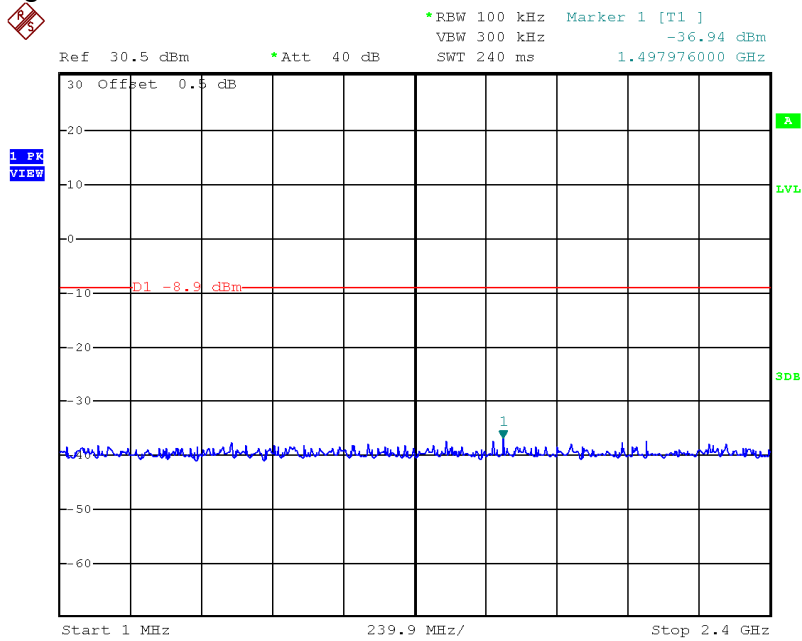

802.11b, Highest Channel, Plot B

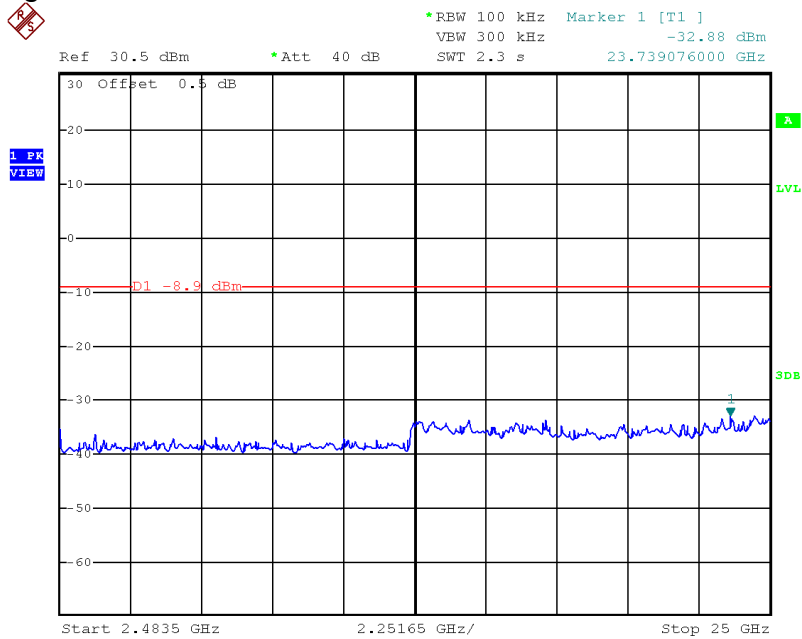

INTERTEK TESTING SERVICES

Plots of out of band conducted emissions (Antenna 0) 802.11g, Lowest Channel, Plot A

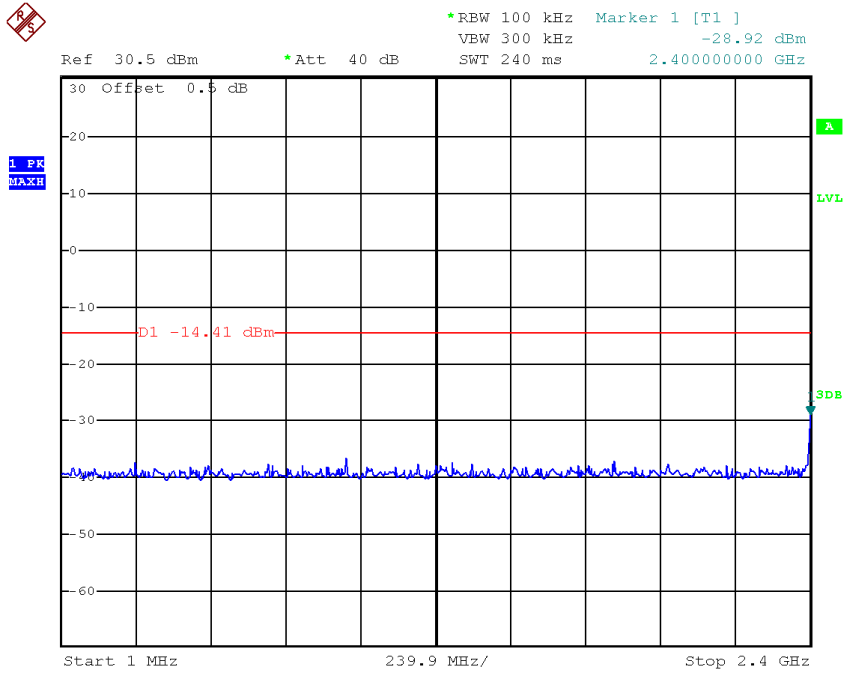

802.11g, Lowest Channel, Plot B

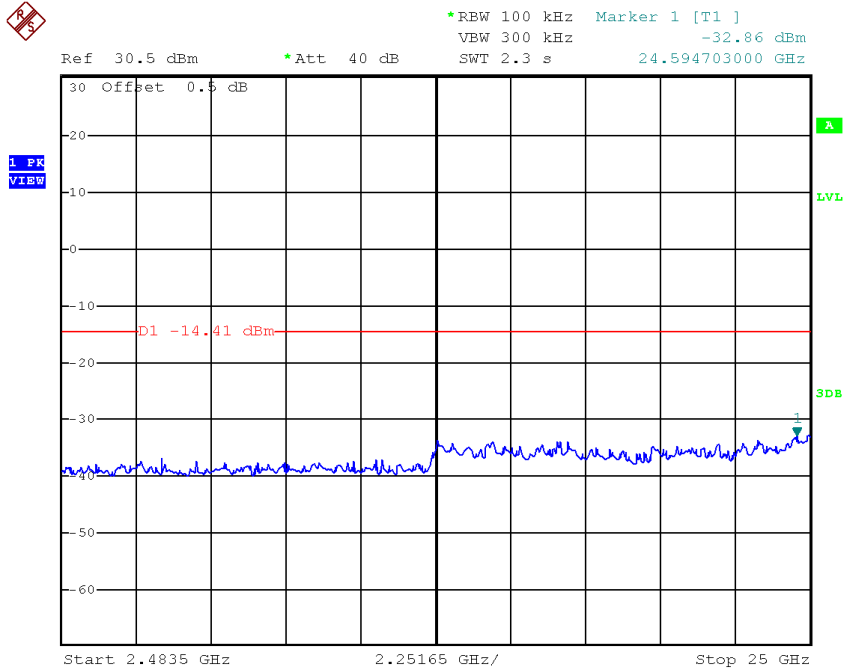

INTERTEK TESTING SERVICES

Plots of out of band conducted emissions (Antenna 0) 802.11g, Middle Channel, Plot A

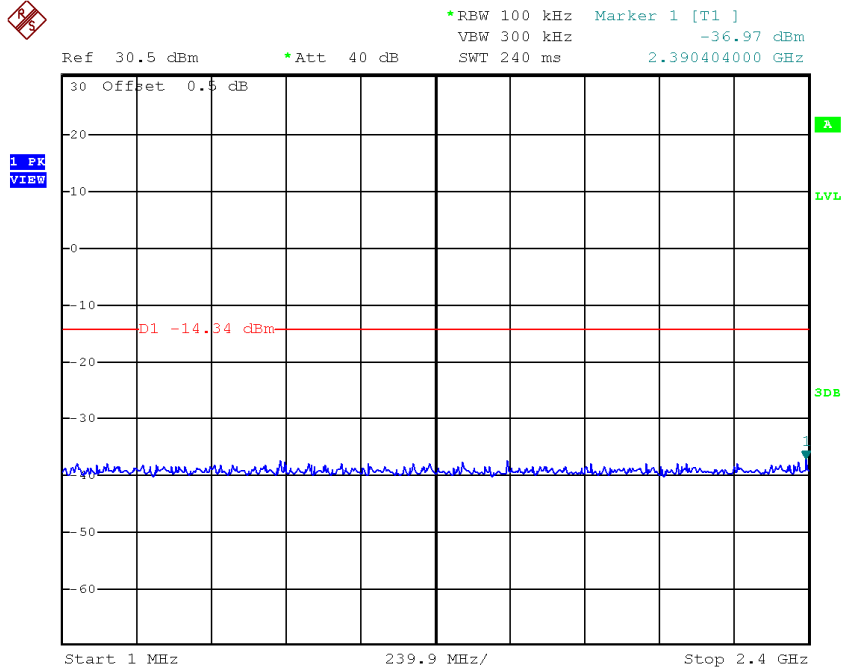

802.11g, Middle Channel, Plot B

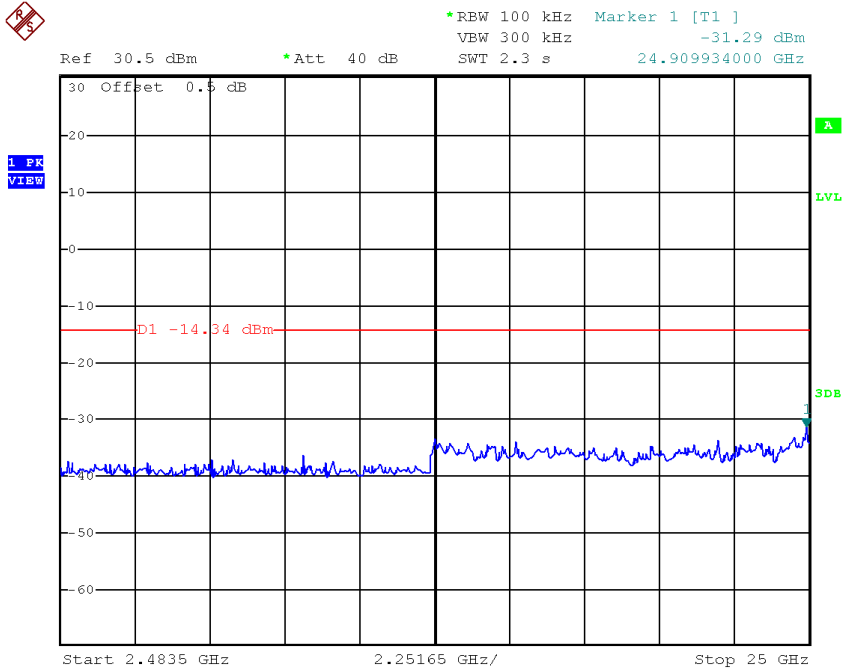

INTERTEK TESTING SERVICES

Plots of out of band conducted emissions (Antenna 0) 802.11g, Highest Channel, Plot A

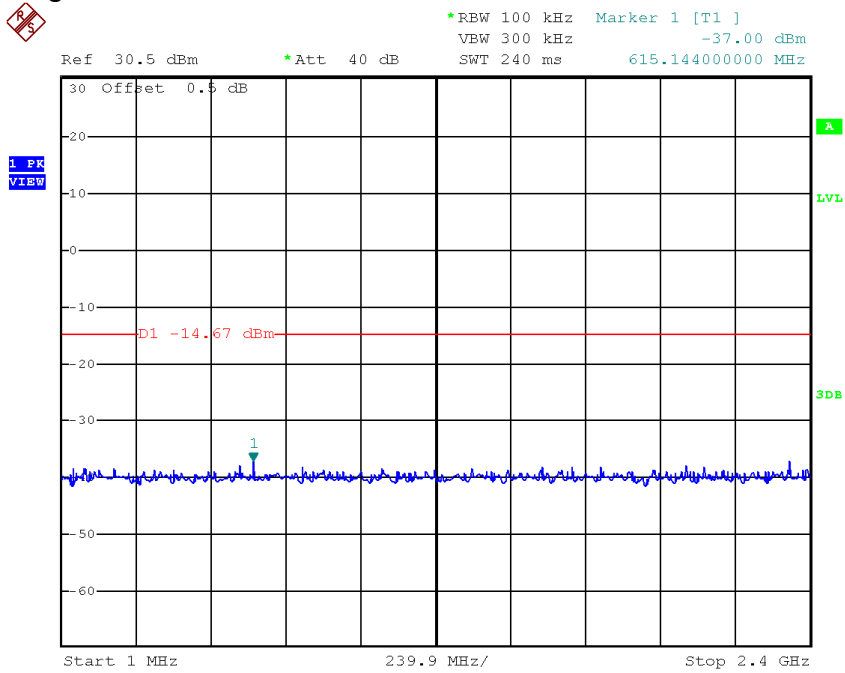

802.11g, Highest Channel, Plot B

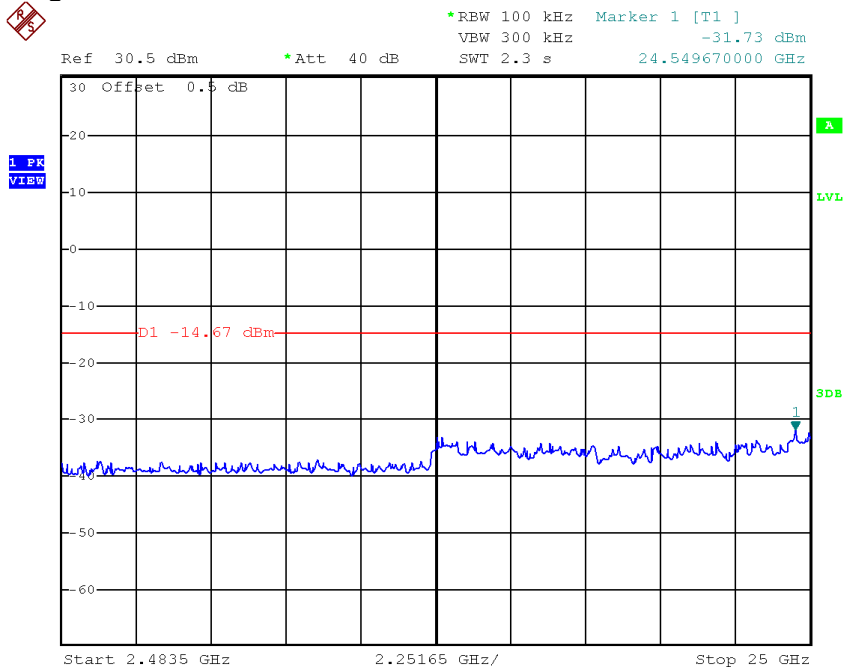

INTERTEK TESTING SERVICES

Plots of out of band conducted emissions (Antenna 1) 802.11g, Lowest Channel, Plot A

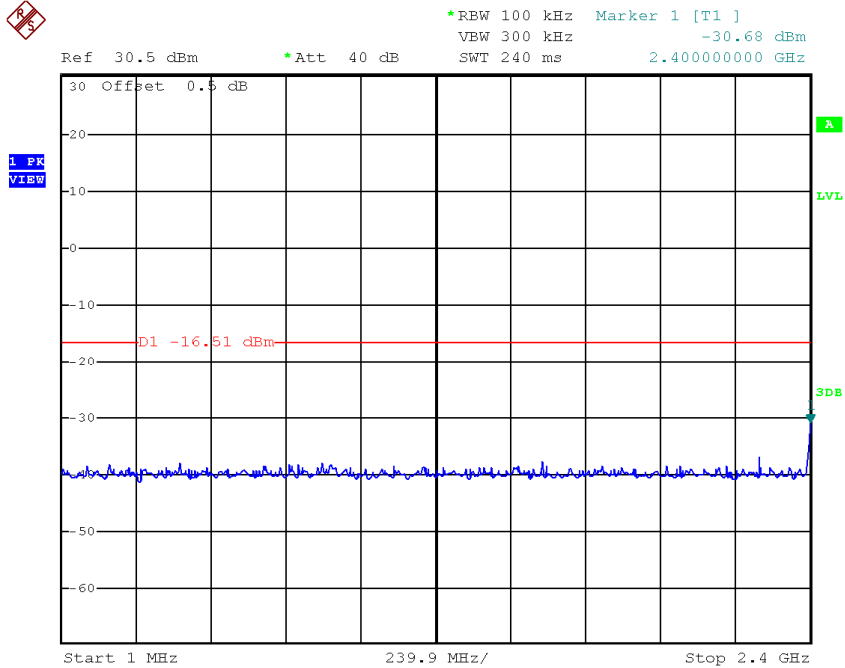

802.11g, Lowest Channel, Plot B

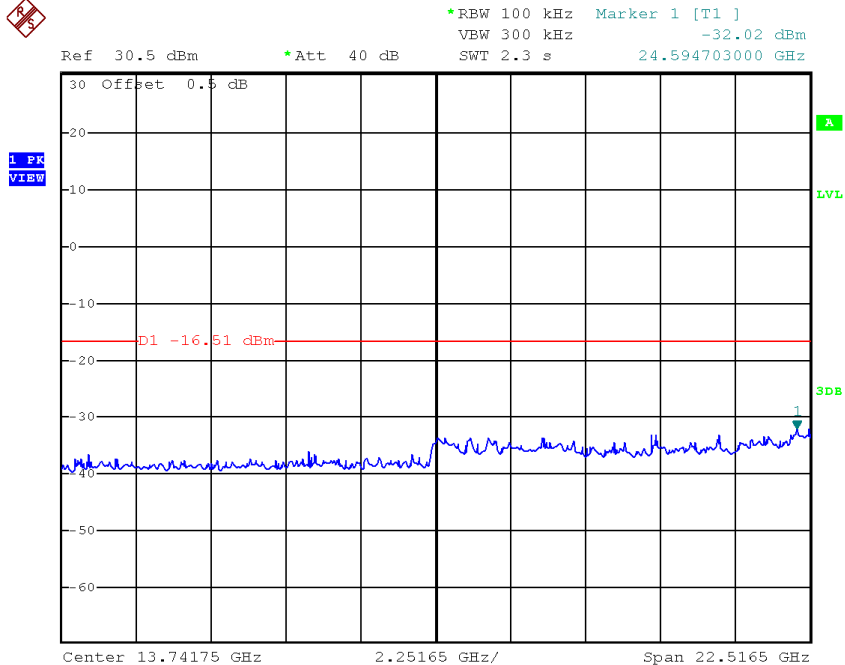

INTERTEK TESTING SERVICES

Plots of out of band conducted emissions (Antenna 1) 802.11g, Middle Channel, Plot A

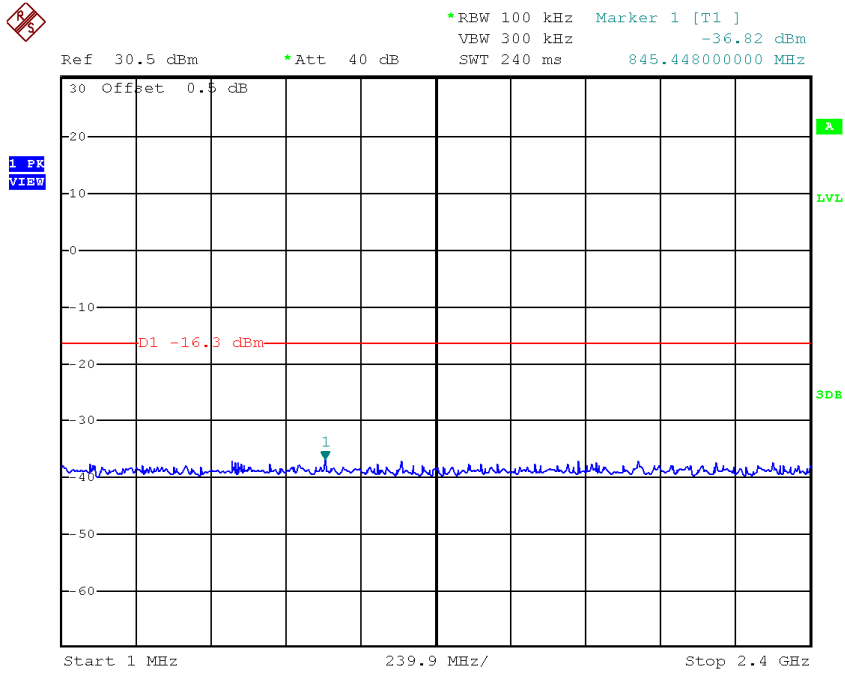

802.11g, Middle Channel, Plot B

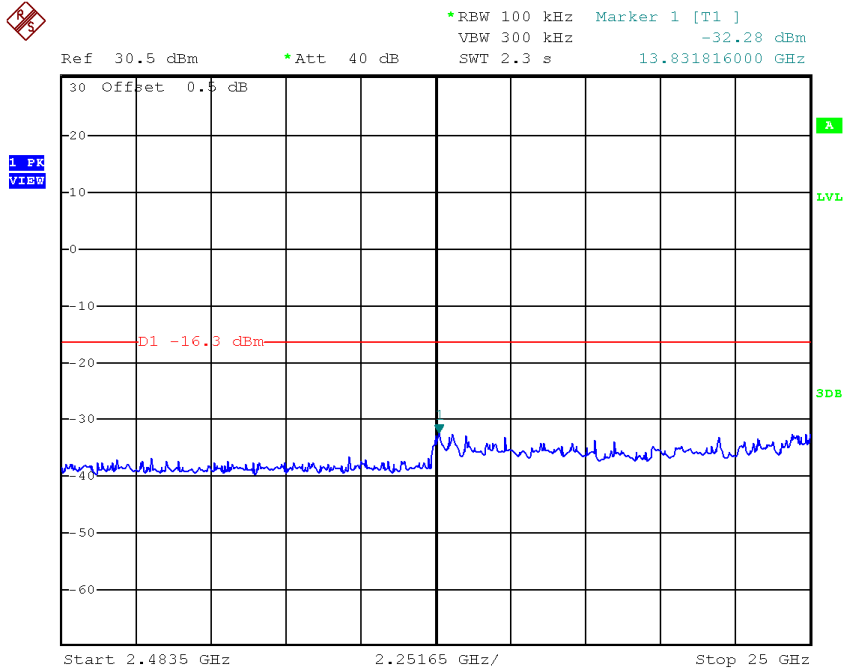

INTERTEK TESTING SERVICES

Plots of out of band conducted emissions (Antenna 1) 802.11g, Highest Channel, Plot A

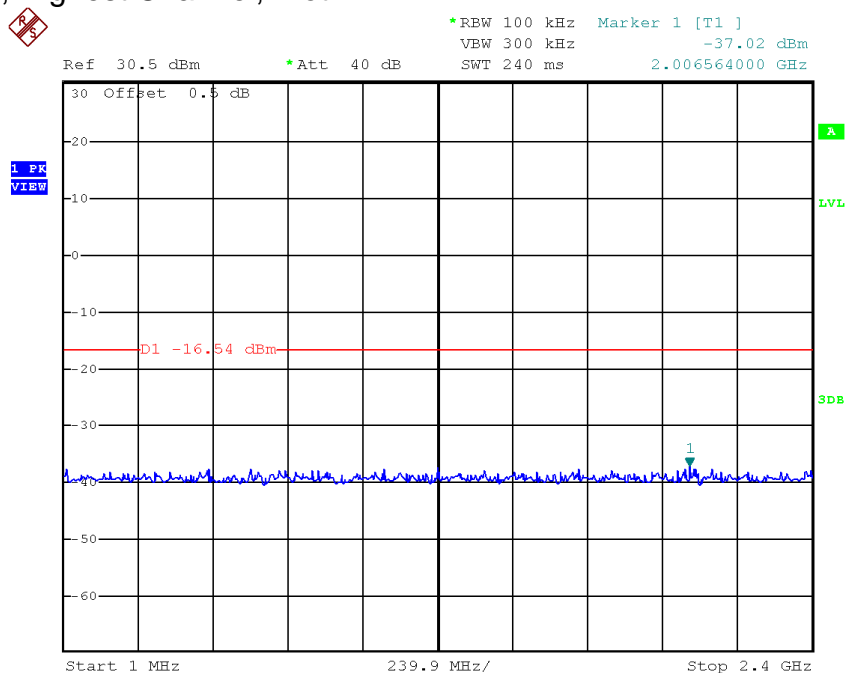

802.11g, Highest Channel, Plot B

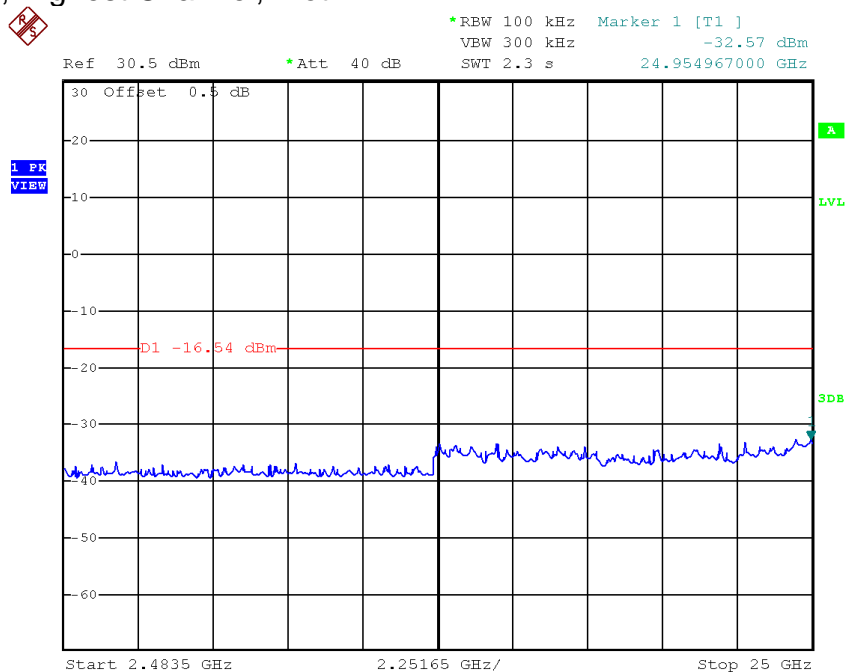

INTERTEK TESTING SERVICES

Plots of out of band conducted emissions (Antenna 0) 802.11n (20m), Lowest Channel, Plot A

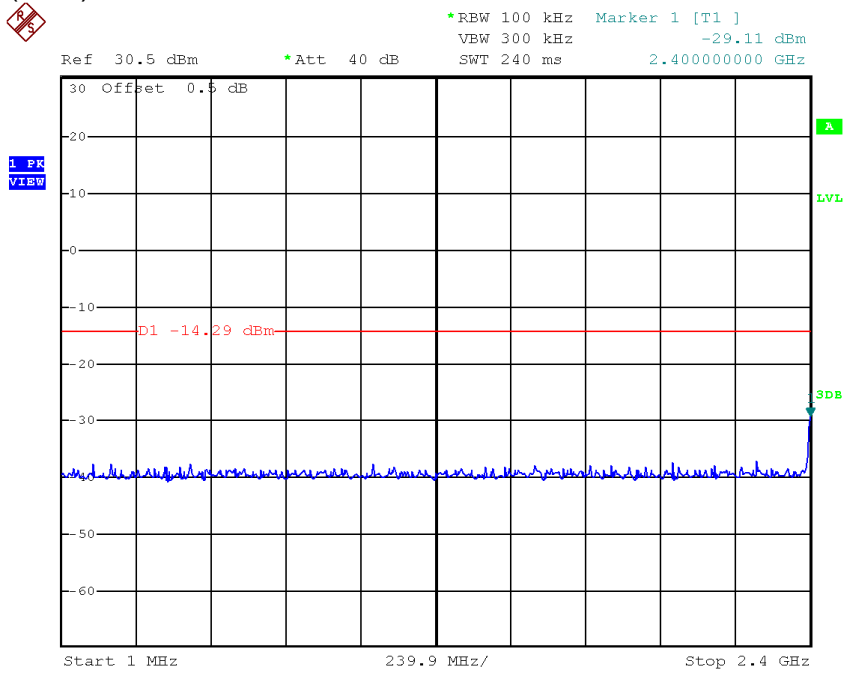

802.11n (20m), Lowest Channel, Plot B

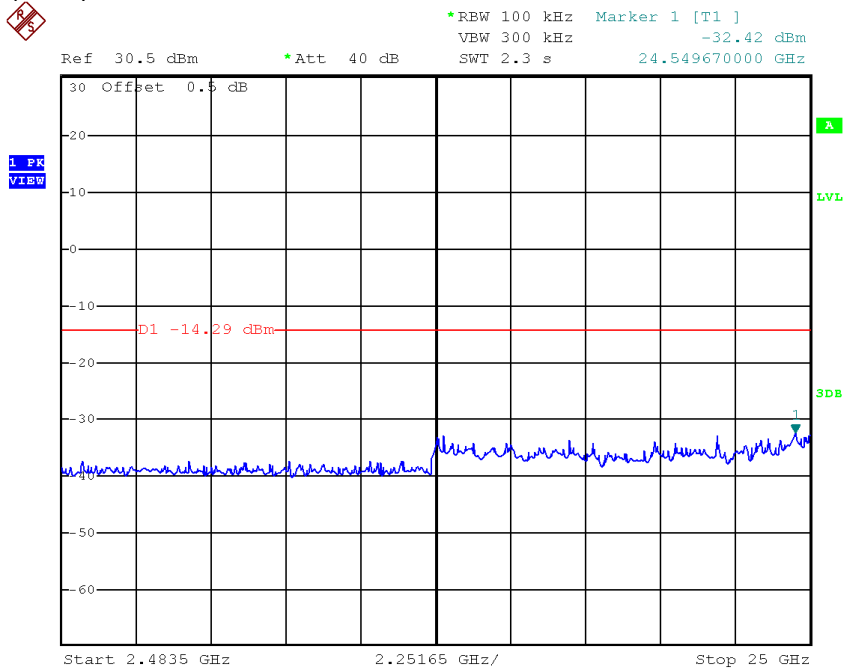

INTERTEK TESTING SERVICES

Plots of out of band conducted emissions (Antenna 0) 802.11n (20m), Middle Channel, Plot A

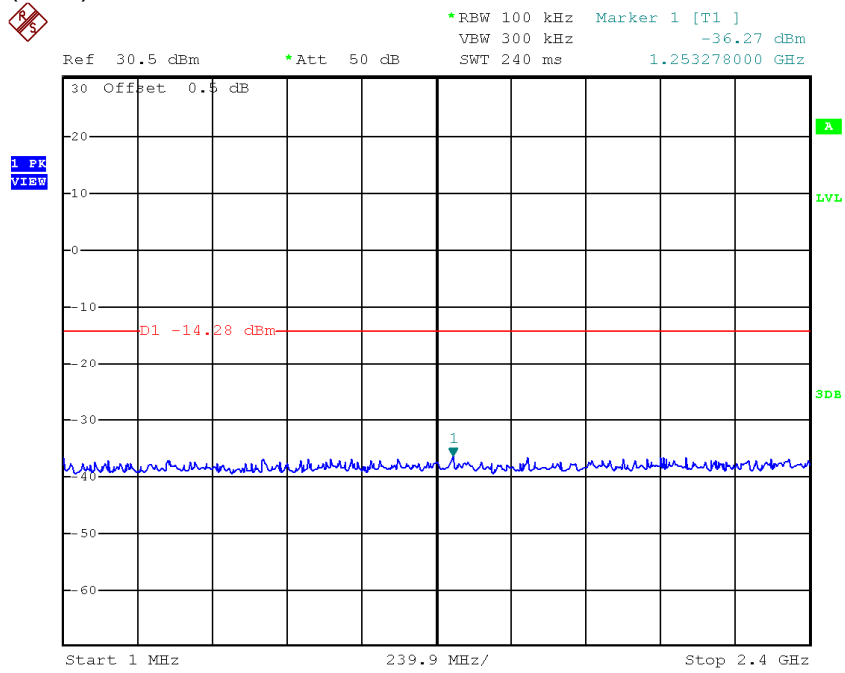

802.11n (20m), Middle Channel, Plot B

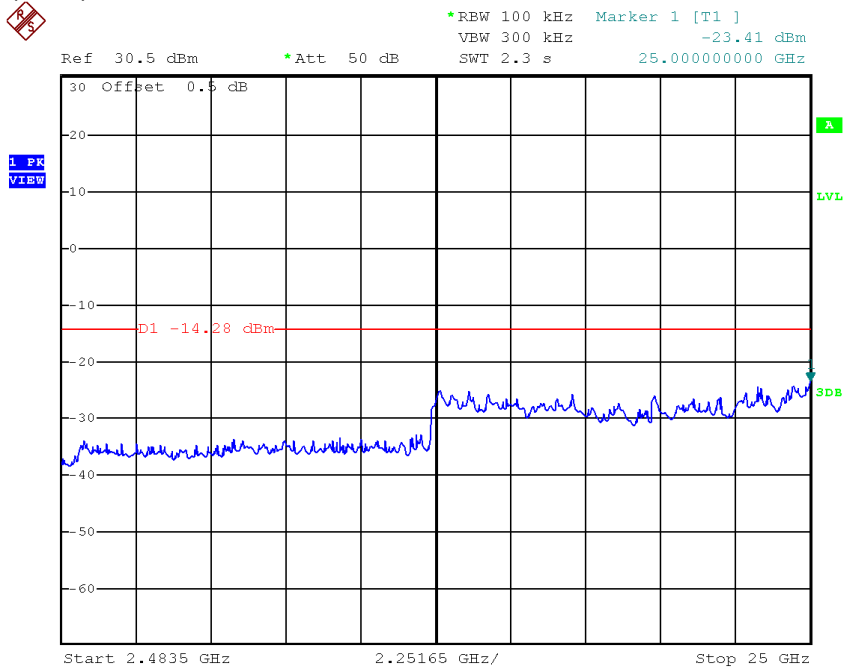

INTERTEK TESTING SERVICES

Plots of out of band conducted emissions (Antenna 0) 802.11n (20m), Highest Channel, Plot A

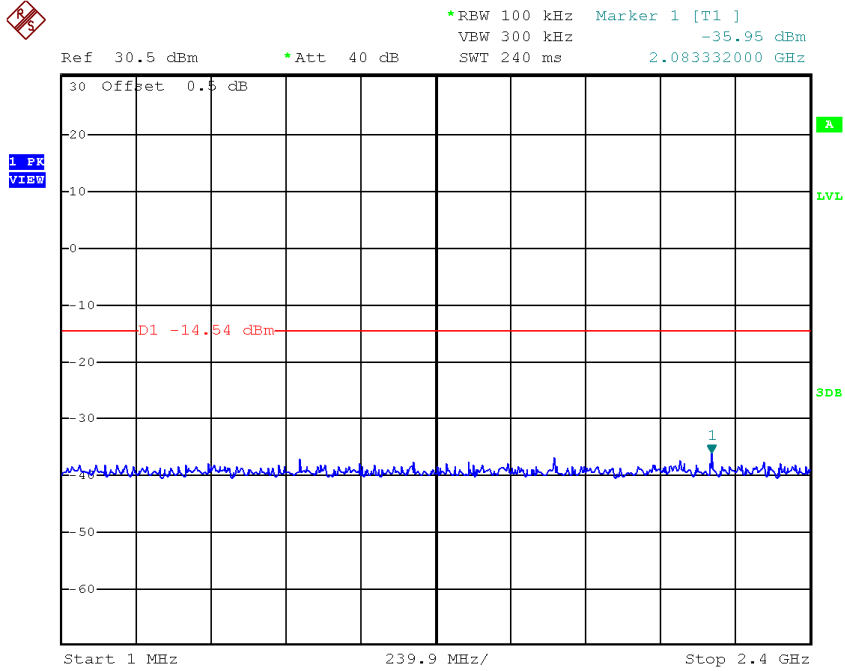

802.11n (20m), Highest Channel, Plot B

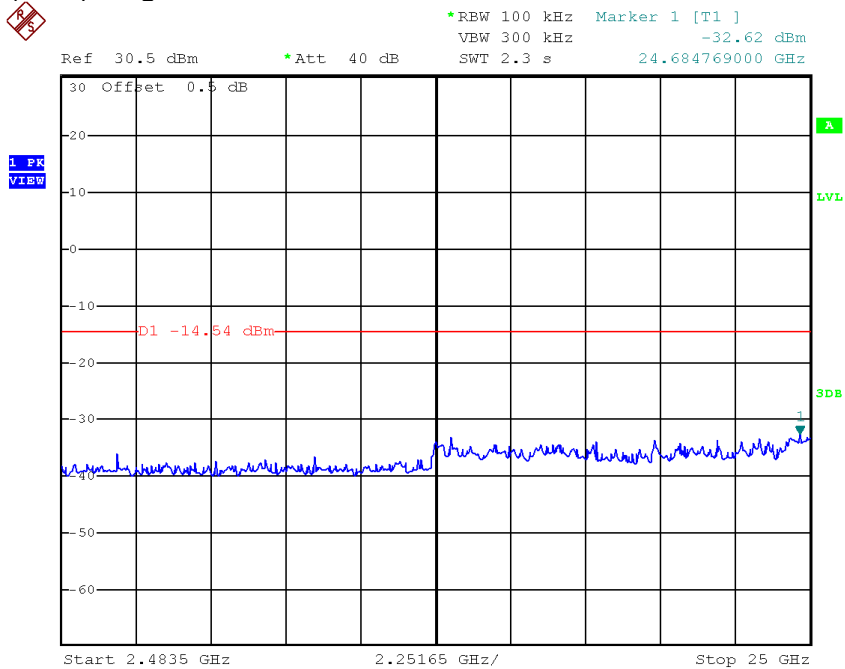

INTERTEK TESTING SERVICES

Plots of out of band conducted emissions (Antenna 1) 802.11n (20m), Lowest Channel, Plot A

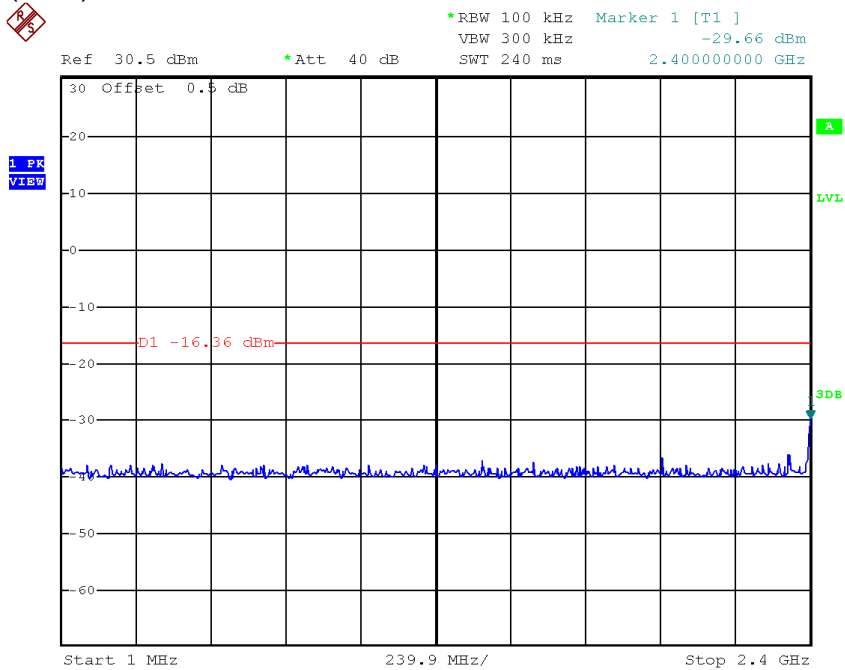

802.11n (20m), Lowest Channel, Plot B

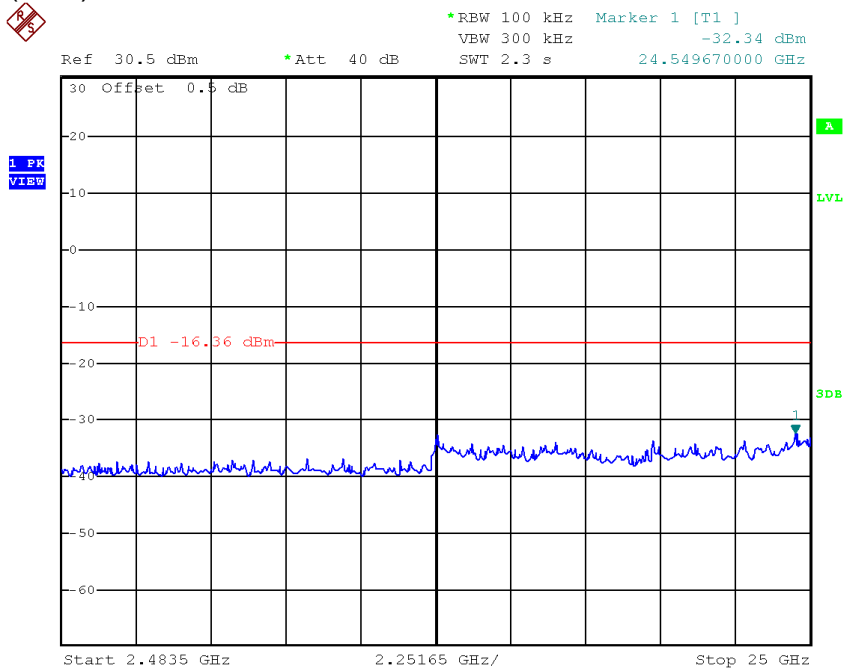

INTERTEK TESTING SERVICES

Plots of out of band conducted emissions (Antenna 1) 802.11n (20m), Middle Channel, Plot A

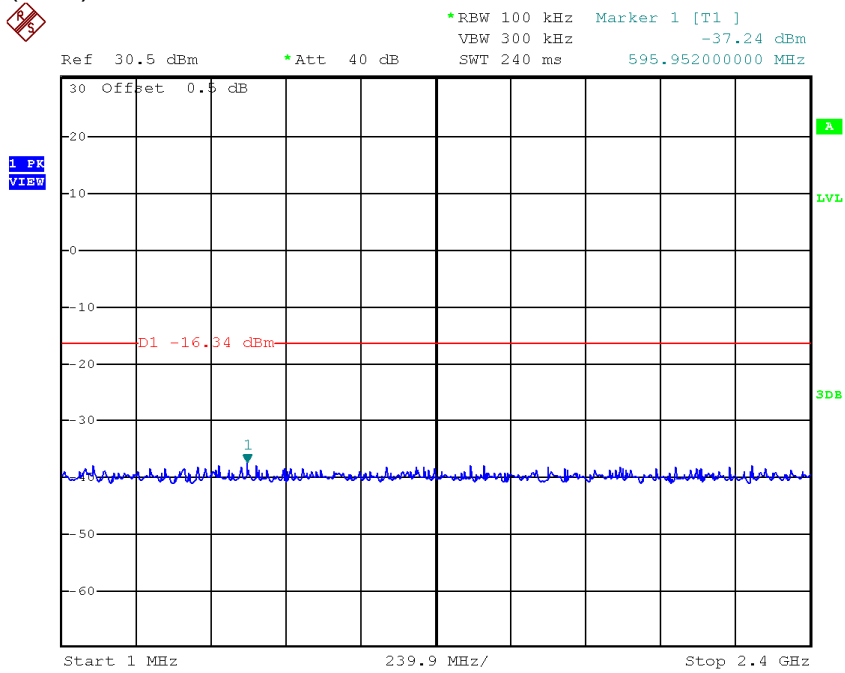

802.11n (20m), Middle Channel, Plot B

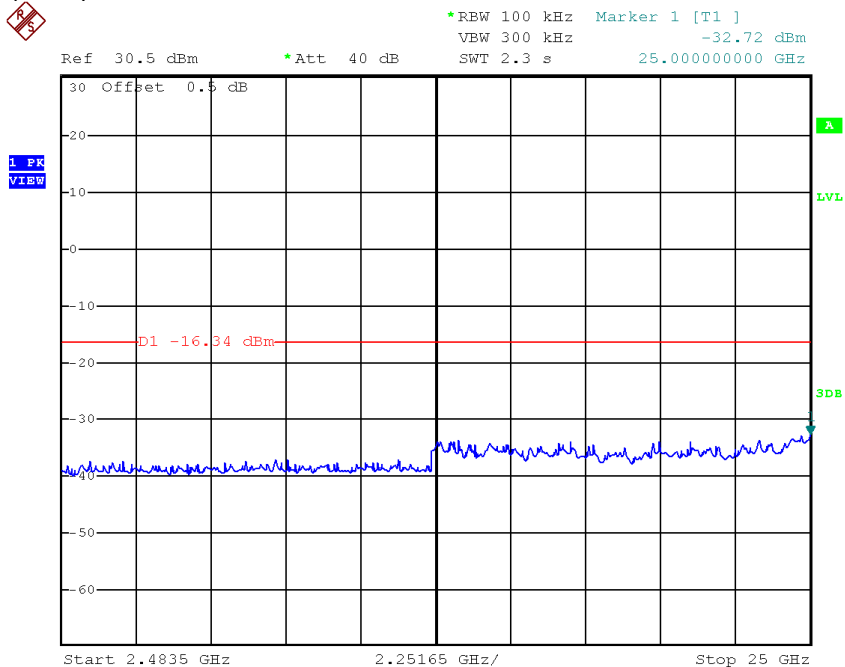

INTERTEK TESTING SERVICES

Plots of out of band conducted emissions (Antenna 0) 802.11n (40m), Lowest Channel, Plot A

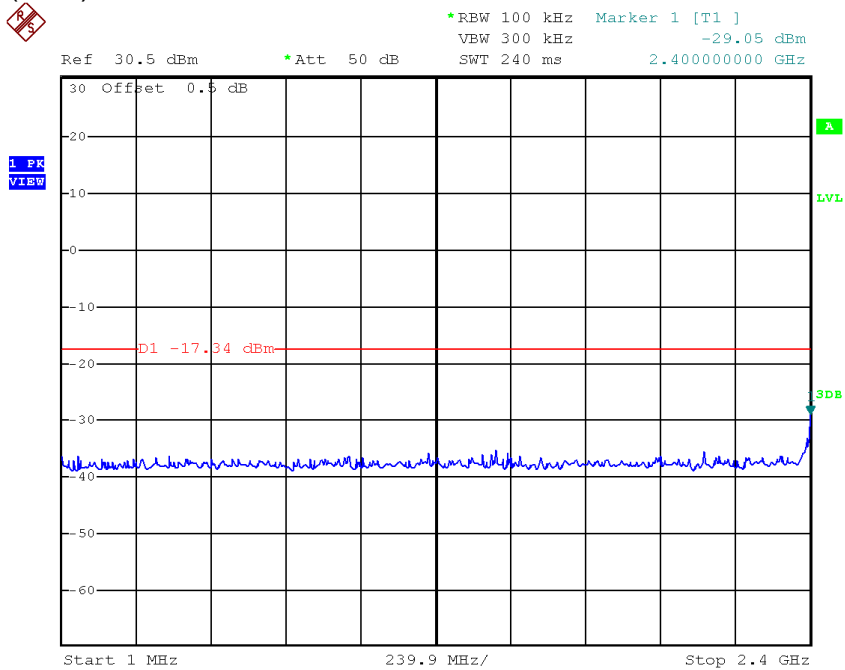

802.11n (40m), Lowest Channel, Plot B

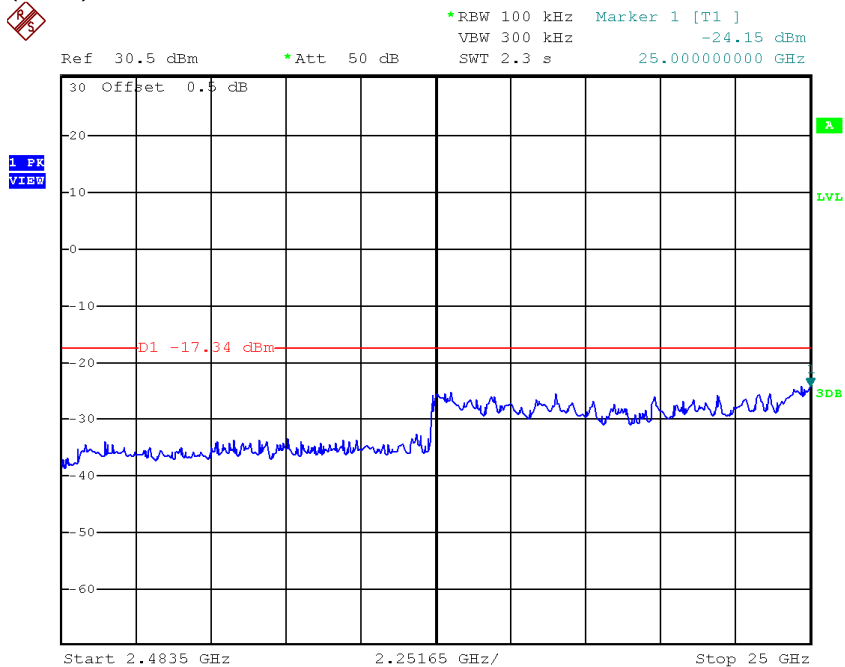

INTERTEK TESTING SERVICES

Plots of out of band conducted emissions (Antenna 0) 802.11n (40m), Middle Channel, Plot A

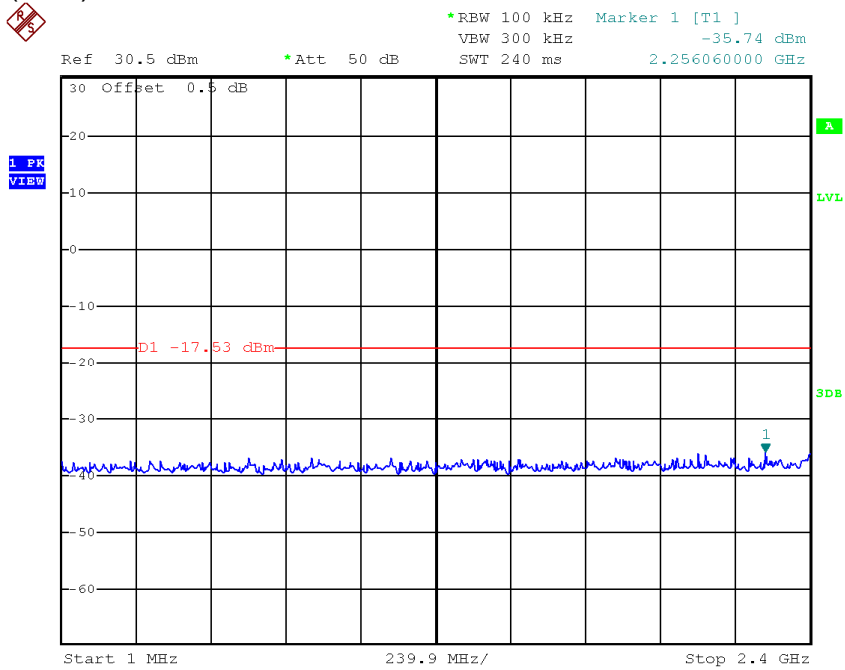

802.11n (40m), Middle Channel, Plot B

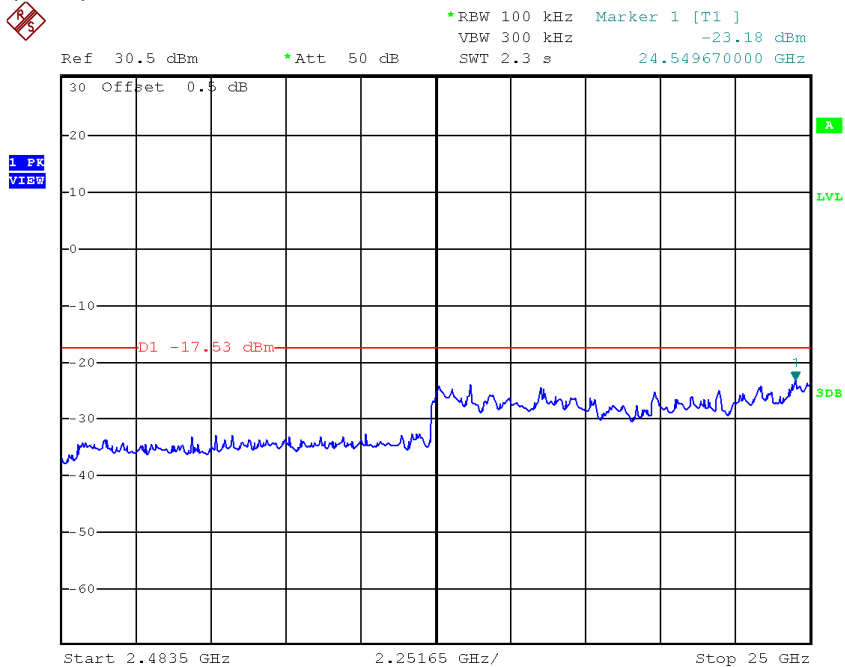

INTERTEK TESTING SERVICES

Plots of out of band conducted emissions (Antenna 0) 802.11n (40m), Highest Channel, Plot A

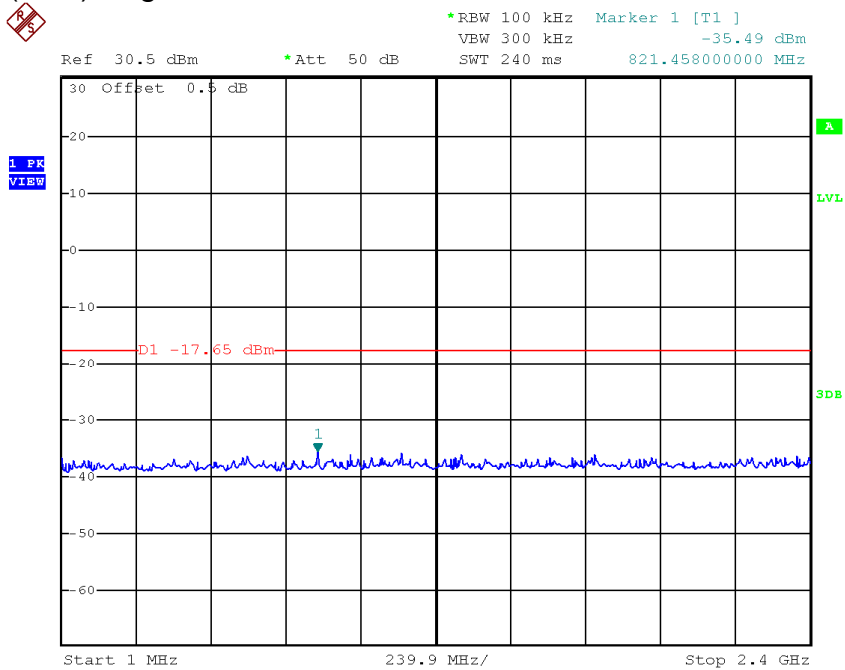

802.11n (40m), Highest Channel, Plot B

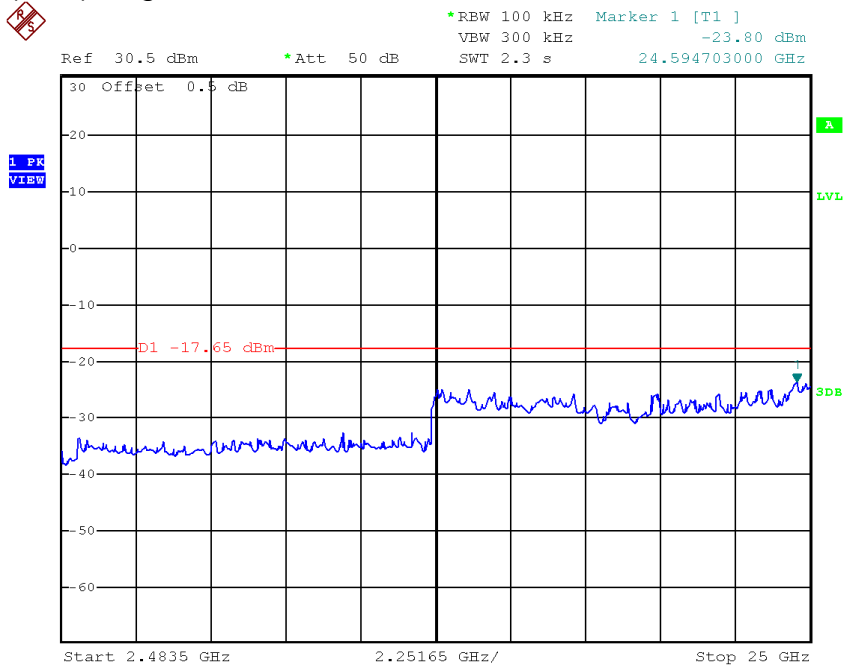

INTERTEK TESTING SERVICES

Plots of out of band conducted emissions (Antenna 1) 802.11n (40m), Lowest Channel, Plot A

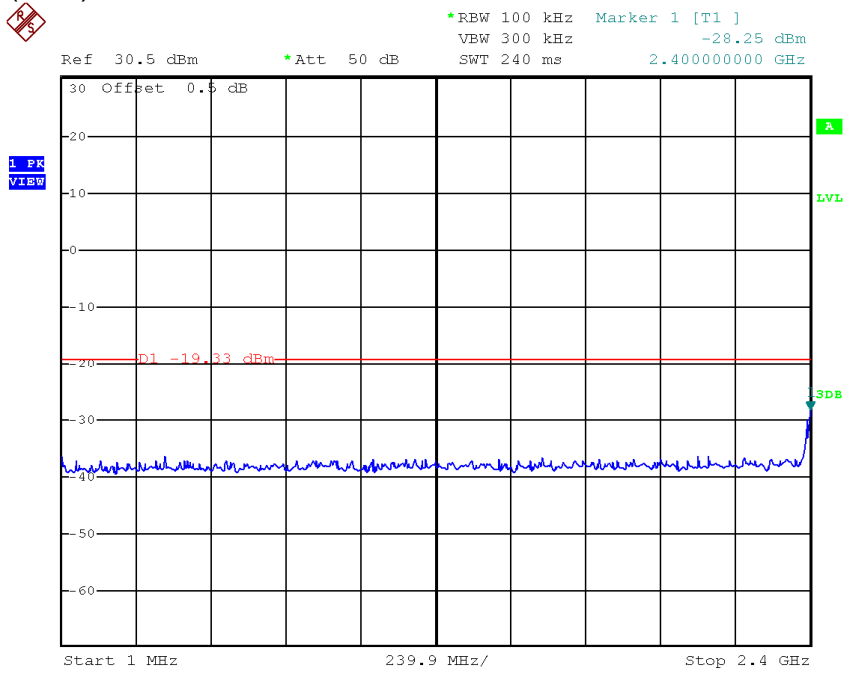

802.11n (40m), Lowest Channel, Plot B

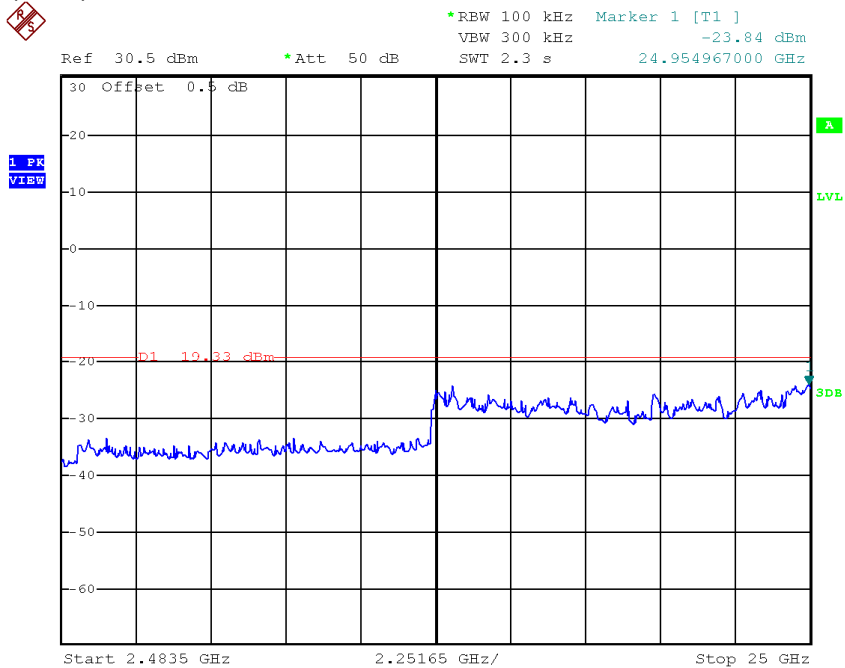

INTERTEK TESTING SERVICES

Plots of out of band conducted emissions (Antenna 1) 802.11n (40m), Middle Channel, Plot A

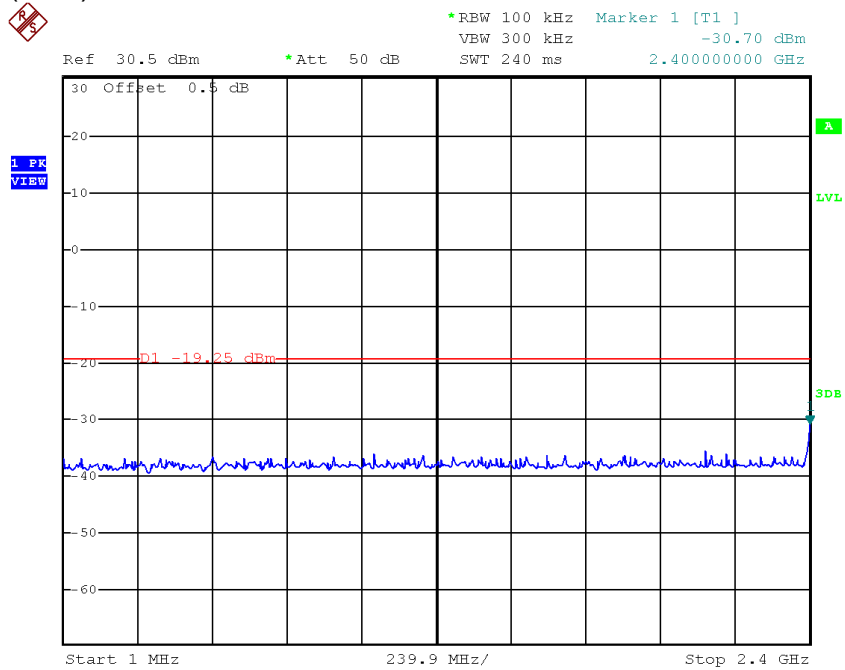

802.11n (40m), Middle Channel, Plot B

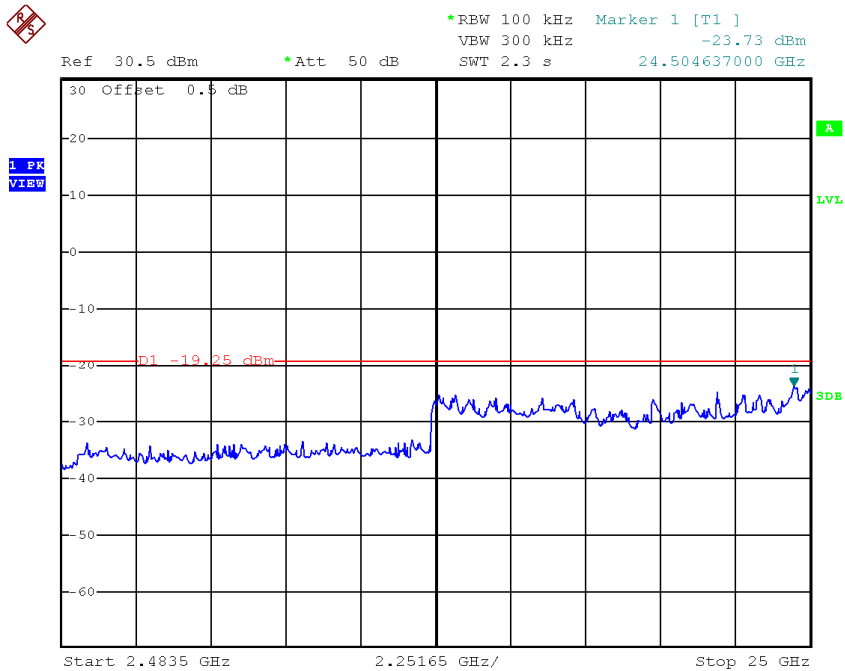

INTERTEK TESTING SERVICES

Plots of out of band conducted emissions (Antenna 1)

802.11n (40m), Highest Channel, Plot A

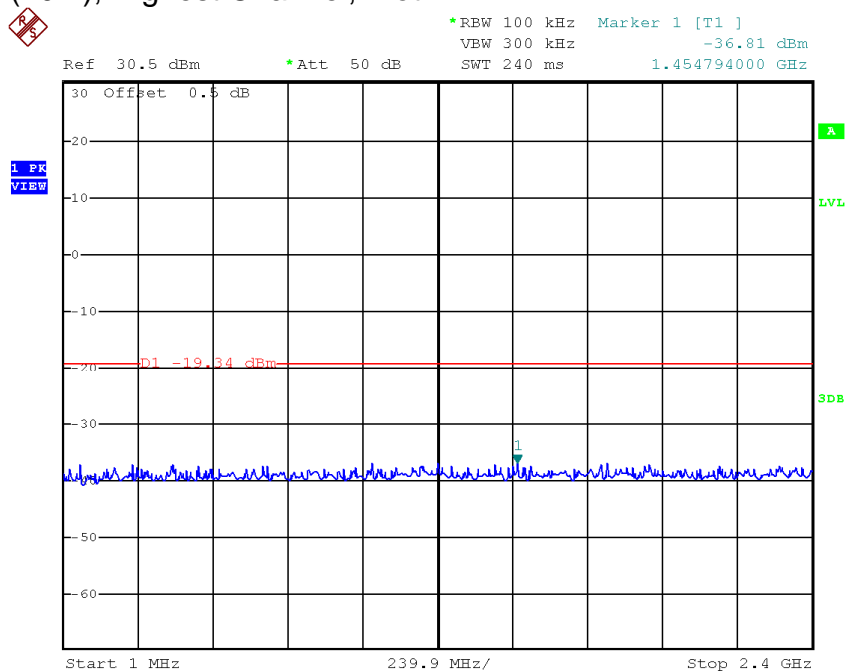

802.11n (40m), Highest Channel, Plot B

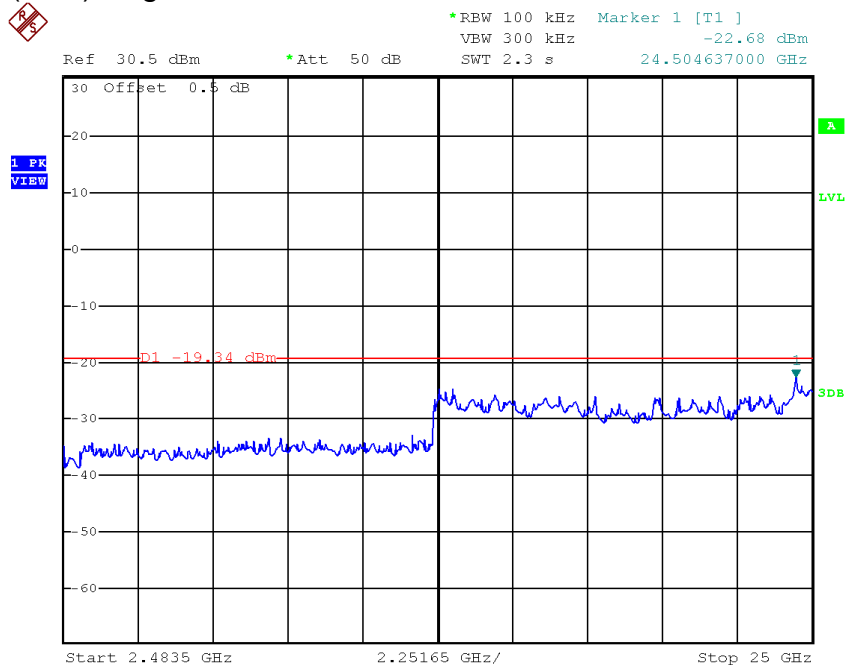

IEEE 802.11n (40MHz)				
Maximum Out of Band Conducted Emissions (dBm)				
Antenna 0	Antenna 1	Antenna 0 + Antenna1	PSD in 100KHz	Limit
-23.18	-22.68	-19.91	4.60	-15.40

INTERTEK TESTING SERVICES

4.5 Field Strength Calculation

The field strength is calculated by adding the reading on the Spectrum Analyzer to the factors associated with preamplifiers (if any), antennas, cables, pulse desensitization and average factors (when specified limit is in average and measurements are made with peak detectors). A sample calculation is included below.

$$FS = RA + AF + CF - AG + PD + AV$$

Where

- FS = Field Strength in dB μ V/m
- RA = Receiver Amplitude (including preamplifier) in dB μ V
- CF = Cable Attenuation Factor in dB
- AF = Antenna Factor in dB
- AG = Amplifier Gain in dB
- PD = Pulse Desensitization in dB
- AV = Average Factor in -dB

In the radiated emission table which follows, the reading shown on the data table may reflect the preamplifier gain. An example of the calculations, where the reading does not reflect the preamplifier gain, follows:

$$FS = RA + AF + CF - AG + PD + AV$$

Example

Assume a receiver reading of 62.0 dB μ V is obtained. The antenna factor of 7.4 dB and cable factor of 1.6 dB is added. The amplifier gain of 29.0 dB is subtracted. The pulse desensitization factor of the spectrum analyzer is 0.0 dB, and the resultant average factor is -10.0 dB. The net field strength for comparison to the appropriate emission limit is 32.0 dB μ V/m. This value in dB μ V/m is converted to its corresponding level in μ V/m.

RA = 62.0 dB μ V
AF = 7.4 dB
CF = 1.6 dB
AG = 29.0 dB
PD = 0.0 dB
AV = -10 dB

$$FS = 62.0 + 7.4 + 1.6 - 29.0 + 0.0 + (-10.0) = 32.0 \text{ dB}\mu\text{V/m}$$

$$\text{Level in } \mu\text{V/m} = \text{Common Antilogarithm} [(32.0 \text{ dB}\mu\text{V/m})/20] = 39.8 \mu\text{V/m}$$

INTERTEK TESTING SERVICES

4.6 Transmitter Radiated Emissions in Restricted Bands and Spurious Emissions

Data is included of the worst case configuration (the configuration which resulted in the highest emission levels). A sample calculation, configuration photographs and data tables of the emissions are included.

The data on the following pages list the significant emission frequencies, the limit and the margin of compliance.

4.6.1 Radiated Emission Configuration Photograph

Worst Case Restricted Band Radiated Emission
at

2390 MHz

The worst case radiated emission configuration photographs are saved with filename:
config photos.pdf

4.6.2 Radiated Emission Data

The data in tables 1-28 list the significant emission frequencies, the limit and the margin of compliance.

Judgement -

Passed by 0.2 dB margin compare with peak limit

INTERTEK TESTING SERVICES

Mode: TX-Channel 01

Table 1
IEEE 802.11b (DSSS, 1 Mbps) (Antenna 0)

Radiated Emission Data

Polarization	Frequency (MHz)	Reading (dB μ V)	Pre-Amp Gain (dB)	Antenna Factor (dB)	Net at 3m (dB μ V/m)	Average Limit at 3m (dB μ V/m)	Margin (dB)
<i>V</i>	<i>2390.000</i>	<i>56.7</i>	<i>33</i>	<i>29.4</i>	<i>53.1</i>	<i>54.0</i>	<i>-0.9</i>
<i>H</i>	<i>4824.000</i>	<i>39.3</i>	<i>33</i>	<i>34.9</i>	<i>41.2</i>	<i>54.0</i>	<i>-12.8</i>
<i>V</i>	<i>12060.000</i>	<i>34.2</i>	<i>33</i>	<i>40.5</i>	<i>41.7</i>	<i>54.0</i>	<i>-12.3</i>
<i>V</i>	<i>14472.000</i>	<i>36.4</i>	<i>33</i>	<i>40.0</i>	<i>43.4</i>	<i>54.0</i>	<i>-10.6</i>

Polarization	Frequency (MHz)	Reading (dB μ V)	Pre-Amp Gain (dB)	Antenna Factor (dB)	Net at 3m - Peak (dB μ V/m)	Peak Limit at 3m (dB μ V/m)	Margin (dB)
<i>V</i>	<i>2390.000</i>	<i>68.3</i>	<i>33</i>	<i>29.4</i>	<i>64.7</i>	<i>74.0</i>	<i>-9.3</i>
<i>H</i>	<i>4824.000</i>	<i>44.4</i>	<i>33</i>	<i>34.9</i>	<i>46.3</i>	<i>74.0</i>	<i>-27.7</i>
<i>V</i>	<i>12060.000</i>	<i>42.3</i>	<i>33</i>	<i>40.5</i>	<i>49.8</i>	<i>74.0</i>	<i>-24.2</i>
<i>V</i>	<i>14472.000</i>	<i>44.0</i>	<i>33</i>	<i>40.0</i>	<i>51.0</i>	<i>74.0</i>	<i>-23.0</i>

- NOTES:
1. Peak detector is used for the peak data of emission measurement.
 2. Average detector is used for the average data of emission measurement.
 3. All measurements were made at 3 meters. Radiated emissions not detected at the 3-meter distance were measured at 0.3-meter and an inverse proportional extrapolation was performed to compare the signal level to the 3-meter limit. No other radiated emissions than those reported were detected at a test distance of 0.3-meter.
 4. Negative value in the margin column shows emission below limit.
 5. Horn antenna is used for the emission over 1000MHz.
 6. Emission (the row indicated by ***bold italic***) within the restricted band meets the requirement of FCC Part 15 Section 15.205
 7. For the measurement of radiated emission, summation method was used which numerical integrating (in terms of linear power) over the transmitter occupied bandwidth.
 8. For the linear power measurement, data in 1MHz spacing was collected by spectrum analyzer with 1MHz resolution bandwidth.

INTERTEK TESTING SERVICES

Mode: TX-Channel 07

Table 2
IEEE 802.11b (DSSS, 1 Mbps) (Antenna 1)

Radiated Emission Data

Polarization	Frequency (MHz)	Reading (dB μ V)	Pre-Amp Gain (dB)	Antenna Factor (dB)	Net at 3m (dB μ V/m)	Average Limit at 3m (dB μ V/m)	Margin (dB)
<i>H</i>	<i>4874.000</i>	<i>38.7</i>	<i>33</i>	<i>34.9</i>	<i>40.6</i>	<i>54.0</i>	<i>-13.4</i>
<i>V</i>	<i>7311.000</i>	<i>36.0</i>	<i>33</i>	<i>37.9</i>	<i>40.9</i>	<i>54.0</i>	<i>-13.1</i>
<i>V</i>	<i>12185.000</i>	<i>33.9</i>	<i>33</i>	<i>40.5</i>	<i>41.4</i>	<i>54.0</i>	<i>-12.6</i>

Polarization	Frequency (MHz)	Reading (dB μ V)	Pre-Amp Gain (dB)	Antenna Factor (dB)	Net at 3m - Peak (dB μ V/m)	Peak Limit at 3m (dB μ V/m)	Margin (dB)
<i>H</i>	<i>4874.000</i>	<i>43.7</i>	<i>33</i>	<i>34.9</i>	<i>45.6</i>	<i>74.0</i>	<i>-28.4</i>
<i>V</i>	<i>7311.000</i>	<i>43.6</i>	<i>33</i>	<i>37.9</i>	<i>48.5</i>	<i>74.0</i>	<i>-25.5</i>
<i>V</i>	<i>12185.000</i>	<i>42.0</i>	<i>33</i>	<i>40.5</i>	<i>49.5</i>	<i>74.0</i>	<i>-24.5</i>

- NOTES:
1. Peak detector is used for the peak data of emission measurement.
 2. Average detector is used for the average data of emission measurement.
 3. All measurements were made at 3 meters. Radiated emissions not detected at the 3-meter distance were measured at 0.3-meter and an inverse proportional extrapolation was performed to compare the signal level to the 3-meter limit. No other radiated emissions than those reported were detected at a test distance of 0.3-meter.
 4. Negative value in the margin column shows emission below limit.
 5. Horn antenna is used for the emission over 1000MHz.
 6. Emission (the row indicated by ***bold italic***) within the restricted band meets the requirement of FCC Part 15 Section 15.205
 7. For the measurement of radiated emission, summation method was used which numerical integrating (in terms of linear power) over the transmitter occupied bandwidth.
 8. For the linear power measurement, data in 1MHz spacing was collected by spectrum analyzer with 1MHz resolution bandwidth.

INTERTEK TESTING SERVICES

Mode: TX-Channel 11

Table 3
IEEE 802.11b (DSSS, 1 Mbps) (Antenna 1)

Radiated Emission Data

Polarization	Frequency (MHz)	Reading (dB μ V)	Pre-Amp Gain (dB)	Antenna Factor (dB)	Net at 3m (dB μ V/m)	Average Limit at 3m (dB μ V/m)	Margin (dB)
<i>V</i>	<i>2483.500</i>	<i>53.7</i>	<i>33</i>	<i>29.4</i>	<i>50.1</i>	<i>54.0</i>	<i>-3.9</i>
<i>H</i>	<i>4924.000</i>	<i>37.8</i>	<i>33</i>	<i>34.9</i>	<i>39.7</i>	<i>54.0</i>	<i>-14.3</i>
<i>V</i>	<i>7386.000</i>	<i>35.3</i>	<i>33</i>	<i>37.9</i>	<i>40.2</i>	<i>54.0</i>	<i>-13.8</i>
<i>V</i>	<i>12310.000</i>	<i>34.2</i>	<i>33</i>	<i>40.5</i>	<i>41.7</i>	<i>54.0</i>	<i>-12.3</i>

Polarization	Frequency (MHz)	Reading (dB μ V)	Pre-Amp Gain (dB)	Antenna Factor (dB)	Net at 3m - Peak (dB μ V/m)	Peak Limit at 3m (dB μ V/m)	Margin (dB)
<i>V</i>	<i>2483.500</i>	<i>65.6</i>	<i>33</i>	<i>29.4</i>	<i>62.0</i>	<i>74.0</i>	<i>-12.0</i>
<i>H</i>	<i>4924.000</i>	<i>43.2</i>	<i>33</i>	<i>34.9</i>	<i>45.1</i>	<i>74.0</i>	<i>-28.9</i>
<i>V</i>	<i>7386.000</i>	<i>42.7</i>	<i>33</i>	<i>37.9</i>	<i>47.6</i>	<i>74.0</i>	<i>-26.4</i>
<i>V</i>	<i>12310.000</i>	<i>41.7</i>	<i>33</i>	<i>40.5</i>	<i>49.2</i>	<i>74.0</i>	<i>-24.8</i>

- NOTES:
1. Peak detector is used for the peak data of emission measurement.
 2. Average detector is used for the average data of emission measurement.
 3. All measurements were made at 3 meters. Radiated emissions not detected at the 3-meter distance were measured at 0.3-meter and an inverse proportional extrapolation was performed to compare the signal level to the 3-meter limit. No other radiated emissions than those reported were detected at a test distance of 0.3-meter.
 4. Negative value in the margin column shows emission below limit.
 5. Horn antenna is used for the emission over 1000MHz.
 6. Emission (the row indicated by ***bold italic***) within the restricted band meets the requirement of FCC Part 15 Section 15.205
 7. For the measurement of radiated emission, summation method was used which numerical integrating (in terms of linear power) over the transmitter occupied bandwidth.
 8. For the linear power measurement, data in 1MHz spacing was collected by spectrum analyzer with 1MHz resolution bandwidth.

INTERTEK TESTING SERVICES

Mode: TX-Channel 01

Table 7
IEEE 802.11g (OFDM, 6 Mbps) (Antenna 0)

Radiated Emission Data

Polarization	Frequency (MHz)	Reading (dBμV)	Pre-Amp Gain (dB)	Antenna Factor (dB)	Net at 3m (dBμV/m)	Average Limit at 3m (dBμV/m)	Margin (dB)
<i>V</i>	<i>2390.000</i>	<i>57.0</i>	<i>33</i>	<i>29.4</i>	<i>53.4</i>	<i>54.0</i>	<i>-0.6</i>
<i>V</i>	<i>4824.000</i>	<i>33.8</i>	<i>33</i>	<i>34.9</i>	<i>35.7</i>	<i>54.0</i>	<i>-18.3</i>
<i>H</i>	<i>12060.000</i>	<i>34.0</i>	<i>33</i>	<i>40.5</i>	<i>41.5</i>	<i>54.0</i>	<i>-12.5</i>
<i>V</i>	<i>14472.000</i>	<i>36.2</i>	<i>33</i>	<i>40.0</i>	<i>43.2</i>	<i>54.0</i>	<i>-10.8</i>

Polarization	Frequency (MHz)	Reading (dBμV)	Pre-Amp Gain (dB)	Antenna Factor (dB)	Net at 3m - Peak (dBμV/m)	Peak Limit at 3m (dBμV/m)	Margin (dB)
<i>V</i>	<i>2390.000</i>	<i>75.1</i>	<i>33</i>	<i>29.4</i>	<i>71.5</i>	<i>74.0</i>	<i>-2.5</i>
<i>V</i>	<i>4824.000</i>	<i>40.4</i>	<i>33</i>	<i>34.9</i>	<i>42.3</i>	<i>74.0</i>	<i>-31.7</i>
<i>H</i>	<i>12060.000</i>	<i>42.1</i>	<i>33</i>	<i>40.5</i>	<i>49.6</i>	<i>74.0</i>	<i>-24.4</i>
<i>V</i>	<i>14472.000</i>	<i>43.9</i>	<i>33</i>	<i>40.0</i>	<i>50.9</i>	<i>74.0</i>	<i>-23.1</i>

- NOTES:
1. Peak detector is used for the peak data of emission measurement.
 2. Average detector is used for the average data of emission measurement.
 3. All measurements were made at 3 meters. Radiated emissions not detected at the 3-meter distance were measured at 0.3-meter and an inverse proportional extrapolation was performed to compare the signal level to the 3-meter limit. No other radiated emissions than those reported were detected at a test distance of 0.3-meter.
 4. Negative value in the margin column shows emission below limit.
 5. Horn antenna is used for the emission over 1000MHz.
 6. Emission (the row indicated by ***bold italic***) within the restricted band meets the requirement of FCC Part 15 Section 15.205
 7. For the measurement of radiated emission, summation method was used which numerical integrating (in terms of linear power) over the transmitter occupied bandwidth.
 8. For the linear power measurement, data in 1MHz spacing was collected by spectrum analyzer with 1MHz resolution bandwidth.

INTERTEK TESTING SERVICES

Mode: TX-Channel 07

Table 8
IEEE 802.11g (OFDM, 6 Mbps) (Antenna 1)

Radiated Emission Data

Polarization	Frequency (MHz)	Reading (dBμV)	Pre-Amp Gain (dB)	Antenna Factor (dB)	Net at 3m (dBμV/m)	Average Limit at 3m (dBμV/m)	Margin (dB)
<i>V</i>	<i>4874.000</i>	<i>33.6</i>	<i>33</i>	<i>34.9</i>	<i>35.5</i>	<i>54.0</i>	<i>-18.5</i>
<i>H</i>	<i>7311.000</i>	<i>33.0</i>	<i>33</i>	<i>37.9</i>	<i>37.9</i>	<i>54.0</i>	<i>-16.1</i>
<i>H</i>	<i>12185.000</i>	<i>34.1</i>	<i>33</i>	<i>40.5</i>	<i>41.6</i>	<i>54.0</i>	<i>-12.4</i>

Polarization	Frequency (MHz)	Reading (dBμV)	Pre-Amp Gain (dB)	Antenna Factor (dB)	Net at 3m - Peak (dBμV/m)	Peak Limit at 3m (dBμV/m)	Margin (dB)
<i>V</i>	<i>4874.000</i>	<i>40.3</i>	<i>33</i>	<i>34.9</i>	<i>42.2</i>	<i>74.0</i>	<i>-31.8</i>
<i>H</i>	<i>7311.000</i>	<i>40.3</i>	<i>33</i>	<i>37.9</i>	<i>45.2</i>	<i>74.0</i>	<i>-28.8</i>
<i>H</i>	<i>12185.000</i>	<i>42.2</i>	<i>33</i>	<i>40.5</i>	<i>49.7</i>	<i>74.0</i>	<i>-24.3</i>

- NOTES:
1. Peak detector is used for the peak data of emission measurement.
 2. Average detector is used for the average data of emission measurement.
 3. All measurements were made at 3 meters. Radiated emissions not detected at the 3-meter distance were measured at 0.3-meter and an inverse proportional extrapolation was performed to compare the signal level to the 3-meter limit. No other radiated emissions than those reported were detected at a test distance of 0.3-meter.
 4. Negative value in the margin column shows emission below limit.
 5. Horn antenna is used for the emission over 1000MHz.
 6. Emission (the row indicated by ***bold italic***) within the restricted band meets the requirement of FCC Part 15 Section 15.205
 7. For the measurement of radiated emission, summation method was used which numerical integrating (in terms of linear power) over the transmitter occupied bandwidth.
 8. For the linear power measurement, data in 1MHz spacing was collected by spectrum analyzer with 1MHz resolution bandwidth.

INTERTEK TESTING SERVICES

Mode: TX-Channel 11

Table 9
IEEE 802.11g (OFDM, 6 Mbps) (Antenna 1)

Radiated Emission Data

Polarization	Frequency (MHz)	Reading (dB μ V)	Pre-Amp Gain (dB)	Antenna Factor (dB)	Net at 3m (dB μ V/m)	Average Limit at 3m (dB μ V/m)	Margin (dB)
<i>V</i>	<i>2483.500</i>	<i>55.6</i>	<i>33</i>	<i>29.4</i>	<i>52.0</i>	<i>54.0</i>	<i>-2.0</i>
<i>V</i>	<i>4924.000</i>	<i>33.4</i>	<i>33</i>	<i>34.9</i>	<i>35.3</i>	<i>54.0</i>	<i>-18.7</i>
<i>H</i>	<i>7386.000</i>	<i>32.8</i>	<i>33</i>	<i>37.9</i>	<i>37.7</i>	<i>54.0</i>	<i>-16.3</i>
<i>H</i>	<i>12310.000</i>	<i>34.2</i>	<i>33</i>	<i>40.5</i>	<i>41.7</i>	<i>54.0</i>	<i>-12.3</i>

Polarization	Frequency (MHz)	Reading (dB μ V)	Pre-Amp Gain (dB)	Antenna Factor (dB)	Net at 3m - Peak (dB μ V/m)	Peak Limit at 3m (dB μ V/m)	Margin (dB)
<i>V</i>	<i>2483.500</i>	<i>74.3</i>	<i>33</i>	<i>29.4</i>	<i>70.7</i>	<i>74.0</i>	<i>-3.3</i>
<i>V</i>	<i>4924.000</i>	<i>40.2</i>	<i>33</i>	<i>34.9</i>	<i>42.1</i>	<i>74.0</i>	<i>-31.9</i>
<i>H</i>	<i>7386.000</i>	<i>40.1</i>	<i>33</i>	<i>37.9</i>	<i>45.0</i>	<i>74.0</i>	<i>-29.0</i>
<i>H</i>	<i>12310.000</i>	<i>42.3</i>	<i>33</i>	<i>40.5</i>	<i>49.8</i>	<i>74.0</i>	<i>-24.2</i>

- NOTES:
1. Peak detector is used for the peak data of emission measurement.
 2. Average detector is used for the average data of emission measurement.
 3. All measurements were made at 3 meters. Radiated emissions not detected at the 3-meter distance were measured at 0.3-meter and an inverse proportional extrapolation was performed to compare the signal level to the 3-meter limit. No other radiated emissions than those reported were detected at a test distance of 0.3-meter.
 4. Negative value in the margin column shows emission below limit.
 5. Horn antenna is used for the emission over 1000MHz.
 6. Emission (the row indicated by ***bold italic***) within the restricted band meets the requirement of FCC Part 15 Section 15.205
 7. For the measurement of radiated emission, summation method was used which numerical integrating (in terms of linear power) over the transmitter occupied bandwidth.
 8. For the linear power measurement, data in 1MHz spacing was collected by spectrum analyzer with 1MHz resolution bandwidth.

INTERTEK TESTING SERVICES

Mode: TX-Channel 01

Table 13
IEEE 802.11n (20MHz) (OFDM, MCS0) (Antenna 0)

Radiated Emission Data

Polarization	Frequency (MHz)	Reading (dB μ V)	Pre-Amp Gain (dB)	Antenna Factor (dB)	Net at 3m (dB μ V/m)	Average Limit at 3m (dB μ V/m)	Margin (dB)
<i>V</i>	<i>2390.000</i>	<i>57.4</i>	<i>33</i>	<i>29.4</i>	<i>53.8</i>	<i>54.0</i>	<i>-0.2</i>
<i>H</i>	<i>4824.000</i>	<i>33.6</i>	<i>33</i>	<i>34.9</i>	<i>35.5</i>	<i>54.0</i>	<i>-18.5</i>
<i>V</i>	<i>12060.000</i>	<i>33.8</i>	<i>33</i>	<i>40.5</i>	<i>41.3</i>	<i>54.0</i>	<i>-12.7</i>
<i>V</i>	<i>14472.000</i>	<i>36.2</i>	<i>33</i>	<i>40.0</i>	<i>43.2</i>	<i>54.0</i>	<i>-10.8</i>

Polarization	Frequency (MHz)	Reading (dB μ V)	Pre-Amp Gain (dB)	Antenna Factor (dB)	Net at 3m - Peak (dB μ V/m)	Peak Limit at 3m (dB μ V/m)	Margin (dB)
<i>V</i>	<i>2390.000</i>	<i>77.1</i>	<i>33</i>	<i>29.4</i>	<i>73.5</i>	<i>74.0</i>	<i>-0.5</i>
<i>H</i>	<i>4824.000</i>	<i>40.3</i>	<i>33</i>	<i>34.9</i>	<i>42.2</i>	<i>74.0</i>	<i>-31.8</i>
<i>V</i>	<i>12060.000</i>	<i>42.0</i>	<i>33</i>	<i>40.5</i>	<i>49.5</i>	<i>74.0</i>	<i>-24.5</i>
<i>V</i>	<i>14472.000</i>	<i>43.8</i>	<i>33</i>	<i>40.0</i>	<i>50.8</i>	<i>74.0</i>	<i>-23.2</i>

- NOTES:
1. Peak detector is used for the peak data of emission measurement.
 2. Average detector is used for the average data of emission measurement.
 3. All measurements were made at 3 meters. Radiated emissions not detected at the 3-meter distance were measured at 0.3-meter and an inverse proportional extrapolation was performed to compare the signal level to the 3-meter limit. No other radiated emissions than those reported were detected at a test distance of 0.3-meter.
 4. Negative value in the margin column shows emission below limit.
 5. Horn antenna is used for the emission over 1000MHz.
 6. Emission (the row indicated by ***bold italic***) within the restricted band meets the requirement of FCC Part 15 Section 15.205
 7. For the measurement of radiated emission, summation method was used which numerical integrating (in terms of linear power) over the transmitter occupied bandwidth.
 8. For the linear power measurement, data in 1MHz spacing was collected by spectrum analyzer with 1MHz resolution bandwidth.

INTERTEK TESTING SERVICES

Mode: TX-Channel 07

Table 14
IEEE 802.11n (20MHz) (OFDM, MCS0) (Antenna 0)

Radiated Emission Data

Polarization	Frequency (MHz)	Reading (dB μ V)	Pre-Amp Gain (dB)	Antenna Factor (dB)	Net at 3m (dB μ V/m)	Average Limit at 3m (dB μ V/m)	Margin (dB)
<i>H</i>	<i>4874.000</i>	<i>33.9</i>	<i>33</i>	<i>34.9</i>	<i>35.8</i>	<i>54.0</i>	<i>-18.2</i>
<i>V</i>	<i>7311.000</i>	<i>32.6</i>	<i>33</i>	<i>37.9</i>	<i>37.5</i>	<i>54.0</i>	<i>-16.5</i>
<i>V</i>	<i>12185.000</i>	<i>34.0</i>	<i>33</i>	<i>40.5</i>	<i>41.5</i>	<i>54.0</i>	<i>-12.5</i>

Polarization	Frequency (MHz)	Reading (dB μ V)	Pre-Amp Gain (dB)	Antenna Factor (dB)	Net at 3m - Peak (dB μ V/m)	Peak Limit at 3m (dB μ V/m)	Margin (dB)
<i>H</i>	<i>4874.000</i>	<i>40.8</i>	<i>33</i>	<i>34.9</i>	<i>42.7</i>	<i>74.0</i>	<i>-31.3</i>
<i>V</i>	<i>7311.000</i>	<i>39.7</i>	<i>33</i>	<i>37.9</i>	<i>44.6</i>	<i>74.0</i>	<i>-29.4</i>
<i>V</i>	<i>12185.000</i>	<i>42.2</i>	<i>33</i>	<i>40.5</i>	<i>49.7</i>	<i>74.0</i>	<i>-24.3</i>

- NOTES:
1. Peak detector is used for the peak data of emission measurement.
 2. Average detector is used for the average data of emission measurement.
 3. All measurements were made at 3 meters. Radiated emissions not detected at the 3-meter distance were measured at 0.3-meter and an inverse proportional extrapolation was performed to compare the signal level to the 3-meter limit. No other radiated emissions than those reported were detected at a test distance of 0.3-meter.
 4. Negative value in the margin column shows emission below limit.
 5. Horn antenna is used for the emission over 1000MHz.
 6. Emission (the row indicated by ***bold italic***) within the restricted band meets the requirement of FCC Part 15 Section 15.205
 7. For the measurement of radiated emission, summation method was used which numerical integrating (in terms of linear power) over the transmitter occupied bandwidth.
 8. For the linear power measurement, data in 1MHz spacing was collected by spectrum analyzer with 1MHz resolution bandwidth.

INTERTEK TESTING SERVICES

Mode: TX-Channel 11

Table 15
IEEE 802.11n (20MHz) (OFDM, MCS0) (Antenna 0)

Radiated Emission Data

Polarization	Frequency (MHz)	Reading (dB μ V)	Pre-Amp Gain (dB)	Antenna Factor (dB)	Net at 3m (dB μ V/m)	Average Limit at 3m (dB μ V/m)	Margin (dB)
<i>V</i>	<i>2483.500</i>	<i>57.0</i>	<i>33</i>	<i>29.4</i>	<i>53.4</i>	<i>54.0</i>	<i>-0.6</i>
<i>H</i>	<i>4924.000</i>	<i>33.7</i>	<i>33</i>	<i>34.9</i>	<i>35.6</i>	<i>54.0</i>	<i>-18.4</i>
<i>V</i>	<i>7386.000</i>	<i>33.5</i>	<i>33</i>	<i>37.9</i>	<i>38.4</i>	<i>54.0</i>	<i>-15.6</i>
<i>V</i>	<i>12310.000</i>	<i>34.2</i>	<i>33</i>	<i>40.5</i>	<i>41.7</i>	<i>54.0</i>	<i>-12.3</i>

Polarization	Frequency (MHz)	Reading (dB μ V)	Pre-Amp Gain (dB)	Antenna Factor (dB)	Net at 3m - Peak (dB μ V/m)	Peak Limit at 3m (dB μ V/m)	Margin (dB)
<i>V</i>	<i>2483.500</i>	<i>76.8</i>	<i>33</i>	<i>29.4</i>	<i>73.2</i>	<i>74.0</i>	<i>-0.8</i>
<i>H</i>	<i>4924.000</i>	<i>40.5</i>	<i>33</i>	<i>34.9</i>	<i>42.4</i>	<i>74.0</i>	<i>-31.6</i>
<i>V</i>	<i>7386.000</i>	<i>40.6</i>	<i>33</i>	<i>37.9</i>	<i>45.5</i>	<i>74.0</i>	<i>-28.5</i>
<i>V</i>	<i>12310.000</i>	<i>42.6</i>	<i>33</i>	<i>40.5</i>	<i>50.1</i>	<i>74.0</i>	<i>-23.9</i>

- NOTES:
1. Peak detector is used for the peak data of emission measurement.
 2. Average detector is used for the average data of emission measurement.
 3. All measurements were made at 3 meters. Radiated emissions not detected at the 3-meter distance were measured at 0.3-meter and an inverse proportional extrapolation was performed to compare the signal level to the 3-meter limit. No other radiated emissions than those reported were detected at a test distance of 0.3-meter.
 4. Negative value in the margin column shows emission below limit.
 5. Horn antenna is used for the emission over 1000MHz.
 6. Emission (the row indicated by ***bold italic***) within the restricted band meets the requirement of FCC Part 15 Section 15.205
 7. For the measurement of radiated emission, summation method was used which numerical integrating (in terms of linear power) over the transmitter occupied bandwidth.
 8. For the linear power measurement, data in 1MHz spacing was collected by spectrum analyzer with 1MHz resolution bandwidth.

INTERTEK TESTING SERVICES

Mode: TX-Channel 01

Table 19
IEEE 802.11n (40MHz) (OFDM, MCS0) (Antenna 0)

Radiated Emission Data

Polarization	Frequency (MHz)	Reading (dB μ V)	Pre-Amp Gain (dB)	Antenna Factor (dB)	Net at 3m (dB μ V/m)	Average Limit at 3m (dB μ V/m)	Margin (dB)
<i>V</i>	<i>2390.000</i>	<i>56.9</i>	<i>33</i>	<i>29.4</i>	<i>53.3</i>	<i>54.0</i>	<i>-0.7</i>
<i>H</i>	<i>4844.000</i>	<i>33.1</i>	<i>33</i>	<i>34.9</i>	<i>35.0</i>	<i>54.0</i>	<i>-19.0</i>
<i>H</i>	<i>7266.000</i>	<i>33.1</i>	<i>33</i>	<i>37.9</i>	<i>38.0</i>	<i>54.0</i>	<i>-16.0</i>
<i>V</i>	<i>12110.000</i>	<i>33.9</i>	<i>33</i>	<i>40.5</i>	<i>41.4</i>	<i>54.0</i>	<i>-12.6</i>

Polarization	Frequency (MHz)	Reading (dB μ V)	Pre-Amp Gain (dB)	Antenna Factor (dB)	Net at 3m - Peak (dB μ V/m)	Peak Limit at 3m (dB μ V/m)	Margin (dB)
<i>V</i>	<i>2390.000</i>	<i>74.7</i>	<i>33</i>	<i>29.4</i>	<i>71.1</i>	<i>74.0</i>	<i>-2.9</i>
<i>H</i>	<i>4844.000</i>	<i>39.9</i>	<i>33</i>	<i>34.9</i>	<i>41.8</i>	<i>74.0</i>	<i>-32.2</i>
<i>H</i>	<i>7266.000</i>	<i>40.2</i>	<i>33</i>	<i>37.9</i>	<i>45.1</i>	<i>74.0</i>	<i>-28.9</i>
<i>V</i>	<i>12110.000</i>	<i>42.1</i>	<i>33</i>	<i>40.5</i>	<i>49.6</i>	<i>74.0</i>	<i>-24.4</i>

- NOTES:
1. Peak detector is used for the peak data of emission measurement.
 2. Average detector is used for the average data of emission measurement.
 3. All measurements were made at 3 meters. Radiated emissions not detected at the 3-meter distance were measured at 0.3-meter and an inverse proportional extrapolation was performed to compare the signal level to the 3-meter limit. No other radiated emissions than those reported were detected at a test distance of 0.3-meter.
 4. Negative value in the margin column shows emission below limit.
 5. Horn antenna is used for the emission over 1000MHz.
 6. Emission (the row indicated by ***bold italic***) within the restricted band meets the requirement of FCC Part 15 Section 15.205
 7. For the measurement of radiated emission, summation method was used which numerical integrating (in terms of linear power) over the transmitter occupied bandwidth.
 8. For the linear power measurement, data in 1MHz spacing was collected by spectrum analyzer with 1MHz resolution bandwidth.

INTERTEK TESTING SERVICES

Mode: TX-Channel 07

Table 20
IEEE 802.11n (40MHz) (OFDM, MCS0) (Antenna 0)

Radiated Emission Data

Polarization	Frequency (MHz)	Reading (dBμV)	Pre-Amp Gain (dB)	Antenna Factor (dB)	Net at 3m (dBμV/m)	Average Limit at 3m (dBμV/m)	Margin (dB)
<i>H</i>	<i>4874.000</i>	<i>33.8</i>	<i>33</i>	<i>34.9</i>	<i>35.7</i>	<i>54.0</i>	<i>-18.3</i>
<i>H</i>	<i>7311.000</i>	<i>32.7</i>	<i>33</i>	<i>37.9</i>	<i>37.6</i>	<i>54.0</i>	<i>-16.4</i>
<i>V</i>	<i>12185.000</i>	<i>34.2</i>	<i>33</i>	<i>40.5</i>	<i>41.7</i>	<i>54.0</i>	<i>-12.3</i>

Polarization	Frequency (MHz)	Reading (dBμV)	Pre-Amp Gain (dB)	Antenna Factor (dB)	Net at 3m - Peak (dBμV/m)	Peak Limit at 3m (dBμV/m)	Margin (dB)
<i>H</i>	<i>4874.000</i>	<i>40.6</i>	<i>33</i>	<i>34.9</i>	<i>42.5</i>	<i>74.0</i>	<i>-31.5</i>
<i>H</i>	<i>7311.000</i>	<i>39.8</i>	<i>33</i>	<i>37.9</i>	<i>44.7</i>	<i>74.0</i>	<i>-29.3</i>
<i>V</i>	<i>12185.000</i>	<i>42.3</i>	<i>33</i>	<i>40.5</i>	<i>49.8</i>	<i>74.0</i>	<i>-24.2</i>

- NOTES:
1. Peak detector is used for the peak data of emission measurement.
 2. Average detector is used for the average data of emission measurement.
 3. All measurements were made at 3 meters. Radiated emissions not detected at the 3-meter distance were measured at 0.3-meter and an inverse proportional extrapolation was performed to compare the signal level to the 3-meter limit. No other radiated emissions than those reported were detected at a test distance of 0.3-meter.
 4. Negative value in the margin column shows emission below limit.
 5. Horn antenna is used for the emission over 1000MHz.
 6. Emission (the row indicated by ***bold italic***) within the restricted band meets the requirement of FCC Part 15 Section 15.205
 7. For the measurement of radiated emission, summation method was used which numerical integrating (in terms of linear power) over the transmitter occupied bandwidth.
 8. For the linear power measurement, data in 1MHz spacing was collected by spectrum analyzer with 1MHz resolution bandwidth.

INTERTEK TESTING SERVICES

Mode: TX-Channel 11

Table 21
IEEE 802.11n (40MHz) (OFDM, MCS0) (Antenna 0)

Radiated Emission Data

Polarization	Frequency (MHz)	Reading (dBμV)	Pre-Amp Gain (dB)	Antenna Factor (dB)	Net at 3m (dBμV/m)	Average Limit at 3m (dBμV/m)	Margin (dB)
<i>V</i>	<i>2483.500</i>	<i>55.3</i>	<i>33</i>	<i>29.4</i>	<i>51.7</i>	<i>54.0</i>	<i>-2.3</i>
<i>H</i>	<i>4904.000</i>	<i>33.4</i>	<i>33</i>	<i>34.9</i>	<i>35.3</i>	<i>54.0</i>	<i>-18.7</i>
<i>H</i>	<i>7356.000</i>	<i>33.1</i>	<i>33</i>	<i>37.9</i>	<i>38.0</i>	<i>54.0</i>	<i>-16.0</i>
<i>V</i>	<i>12260.000</i>	<i>34.3</i>	<i>33</i>	<i>40.5</i>	<i>41.8</i>	<i>54.0</i>	<i>-12.2</i>

Polarization	Frequency (MHz)	Reading (dBμV)	Pre-Amp Gain (dB)	Antenna Factor (dB)	Net at 3m - Peak (dBμV/m)	Peak Limit at 3m (dBμV/m)	Margin (dB)
<i>V</i>	<i>2483.500</i>	<i>72.8</i>	<i>33</i>	<i>29.4</i>	<i>69.2</i>	<i>74.0</i>	<i>-4.8</i>
<i>H</i>	<i>4904.000</i>	<i>40.2</i>	<i>33</i>	<i>34.9</i>	<i>42.1</i>	<i>74.0</i>	<i>-31.9</i>
<i>H</i>	<i>7356.000</i>	<i>40.3</i>	<i>33</i>	<i>37.9</i>	<i>45.2</i>	<i>74.0</i>	<i>-28.8</i>
<i>V</i>	<i>12260.000</i>	<i>42.8</i>	<i>33</i>	<i>40.5</i>	<i>50.3</i>	<i>74.0</i>	<i>-23.7</i>

- NOTES:
1. Peak detector is used for the peak data of emission measurement.
 2. Average detector is used for the average data of emission measurement.
 3. All measurements were made at 3 meters. Radiated emissions not detected at the 3-meter distance were measured at 0.3-meter and an inverse proportional extrapolation was performed to compare the signal level to the 3-meter limit. No other radiated emissions than those reported were detected at a test distance of 0.3-meter.
 4. Negative value in the margin column shows emission below limit.
 5. Horn antenna is used for the emission over 1000MHz.
 6. Emission (the row indicated by ***bold italic***) within the restricted band meets the requirement of FCC Part 15 Section 15.205
 7. For the measurement of radiated emission, summation method was used which numerical integrating (in terms of linear power) over the transmitter occupied bandwidth.
 8. For the linear power measurement, data in 1MHz spacing was collected by spectrum analyzer with 1MHz resolution bandwidth.

INTERTEK TESTING SERVICES

Mode: ANT0 & ANT1

Table 25

Radiated Emission Data

Polarization	Frequency (MHz)	Reading (dB μ V)	Pre-Amp Gain (dB)	Antenna Factor (dB)	Net at 3m (dB μ V/m)	Average Limit at 3m (dB μ V/m)	Margin (dB)
H	2390.000	56.4	33	29.4	52.8	54.0	-1.2
H	2483.500	55.8	33	29.4	52.2	54.0	-1.8

Polarization	Frequency (MHz)	Reading (dB μ V)	Pre-amp (dB)	Antenna Factor (dB)	Net at 3m (dB μ V/m)	Limit at 3m (dB μ V/m)	Margin (dB)
H	31.212	44.8	16	10.0	38.8	40.0	-1.2
H	39.942	37.4	16	10.0	31.4	40.0	-8.6
V	85.412	36.2	16	8.0	28.2	40.0	-11.8
V	99.350	32.0	16	12.0	28.0	43.5	-15.5
H	120.816	27.9	16	14.0	25.9	43.5	-17.6
V	499.950	18.1	16	26.0	28.1	46.0	-17.9
V	599.925	14.5	16	29.0	27.5	46.0	-18.5
H	749.942	14.0	16	30.0	28.0	46.0	-18.0
H	2390.000	75.7	33	29.4	72.1	74.0	-1.9
H	2483.500	72.0	33	29.4	68.4	74.0	-5.6

- NOTES:
1. Peak detector is used for the peak data of emission measurement.
 2. Average detector is used for the average data of emission measurement.
 3. All measurements were made at 3 meters. Radiated emissions not detected at the 3-meter distance were measured at 0.3-meter and an inverse proportional extrapolation was performed to compare the signal level to the 3-meter limit. No other radiated emissions than those reported were detected at a test distance of 0.3-meter.
 4. Negative value in the margin column shows emission below limit.
 5. Horn antenna is used for the emission over 1000MHz.
 6. Emission (the row indicated by **bold italic**) within the restricted band meets the requirement of FCC Part 15 Section 15.205

INTERTEK TESTING SERVICES

Mode: Data transfer via USB with WiFi ON

Table 27

Radiated Emission Data

Polarization	Frequency (MHz)	Reading (dB μ V)	Pre-amp (dB)	Antenna Factor (dB)	Net at 3m (dB μ V/m)	Limit at 3m (dB μ V/m)	Margin (dB)
V	43.458	38.9	16	10.0	32.9	40.0	-7.1
V	50.359	37.0	16	11.0	32.0	40.0	-8.0
V	85.411	38.6	16	8.0	30.6	40.0	-9.4
V	100.931	38.3	16	12.0	34.3	43.5	-9.2
V	118.633	38.9	16	14.0	36.9	43.5	-6.6
H	499.857	23.1	16	26.0	33.1	46.0	-12.9
H	959.538	17.8	16	33.0	34.8	46.0	-11.2

- NOTES: 1. Peak detector is used for the emission measurement.
2. All measurements were made at 3 meters. Radiated emissions not detected at the 3-meter distance were measured at 0.3-meter and an inverse proportional extrapolation was performed to compare the signal level to the 3-meter limit. No other radiated emissions than those reported were detected at a test distance of 0.3-meter.
3. Negative value in the margin column shows emission below limit.
4. Emission (the row indicated by **bold italic**) within the restricted band meets the requirement of FCC Part 15 Section 15.205

INTERTEK TESTING SERVICES

Mode: WiFi ON only

Table 28

Radiated Emission Data

Polarization	Frequency (MHz)	Reading (dB μ V)	Pre-amp (dB)	Antenna Factor (dB)	Net at 3m (dB μ V/m)	Limit at 3m (dB μ V/m)	Margin (dB)
V	50.375	39.7	16	11.0	34.7	40.0	-5.3
V	58.615	40.7	16	11.0	35.7	40.0	-4.3
V	104.690	38.8	16	13.0	35.8	43.5	-7.7
V	116.936	36.2	16	14.0	34.2	43.5	-9.3
V	170.528	26.5	16	18.0	28.5	43.5	-15.0
H	228.486	25.8	16	18.0	27.8	46.0	-18.2
H	499.947	25.1	16	26.0	35.1	46.0	-10.9
H	599.996	18.1	16	29.0	31.1	46.0	-14.9
H	959.980	17.2	16	33.0	34.2	46.0	-11.8

- NOTES:
1. Peak detector is used for the emission measurement.
 2. All measurements were made at 3 meters. Radiated emissions not detected at the 3-meter distance were measured at 0.3-meter and an inverse proportional extrapolation was performed to compare the signal level to the 3-meter limit. No other radiated emissions than those reported were detected at a test distance of 0.3-meter.
 3. Negative value in the margin column shows emission below limit.
 4. Emission (the row indicated by **bold italic**) within the restricted band meets the requirement of FCC Part 15 Section 15.205

INTERTEK TESTING SERVICES

4.6.3 Radiated Emission Test Setup

The figure below shows the test setup, which is utilized to make these measurements.

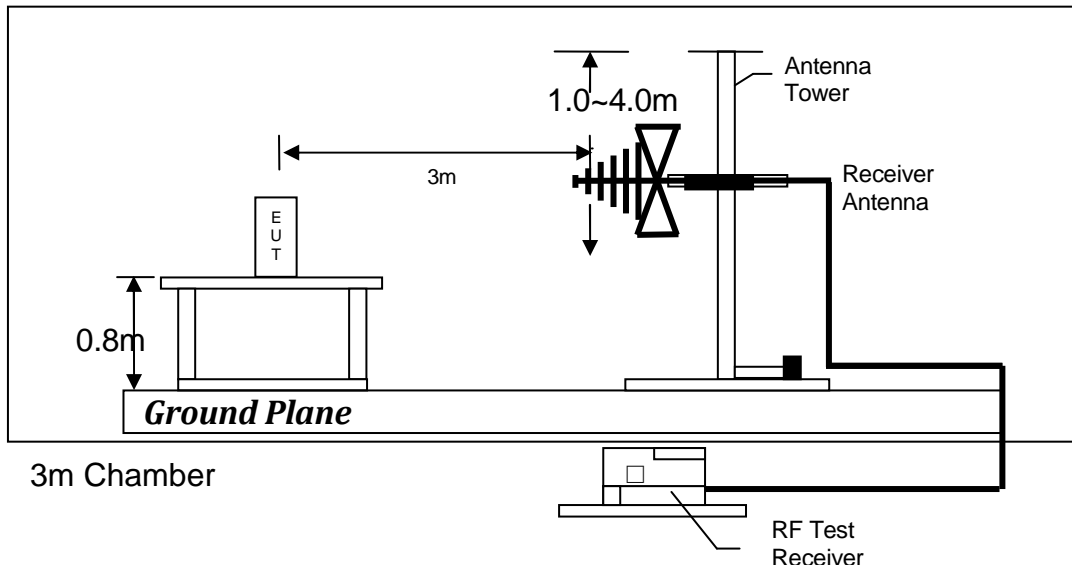

Test setup of radiated emissions up to 1GHz

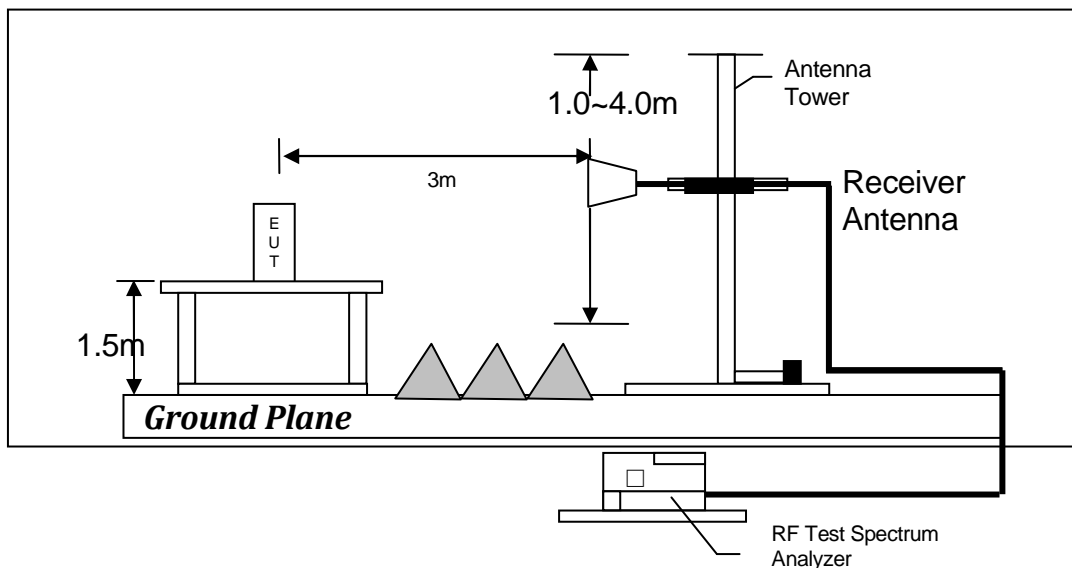

Test setup of radiated emissions above 1GHz

INTERTEK TESTING SERVICES

4.6.4 Transmitter Duty Cycle Calculation

Not applicable – No average factor is required.

INTERTEK TESTING SERVICES

4.7 AC Power Line Conducted Emission

- Not applicable – EUT is only powered by battery for operation.
- EUT connects to AC power line. Emission Data is listed in following pages.

- Base Unit connects to AC power line and has transmission. Handset connects to AC power line but has no transmission. Emission Data of Base Unit is listed in following pages.

4.7.1 AC Power Line Conducted Emission Configuration Photograph

Worst Case Line-Conducted Configuration
at
465 kHz

The worst case line conducted configuration photographs are attached in the Appendix and saved with filename: config photos.pdf

4.7.2 AC Power Line Conducted Emission Data

The plot(s) and data in the following pages list the significant emission frequencies, the limit and the margin of compliance.

Passed by 2.45 dB margin compare with CISPR Average limit

INTERTEK TESTING SERVICES

Worst Case: WiFi Only



RBW 9 kHz
MT 1 s

Att 10 dB AUTO PREAMP OFF

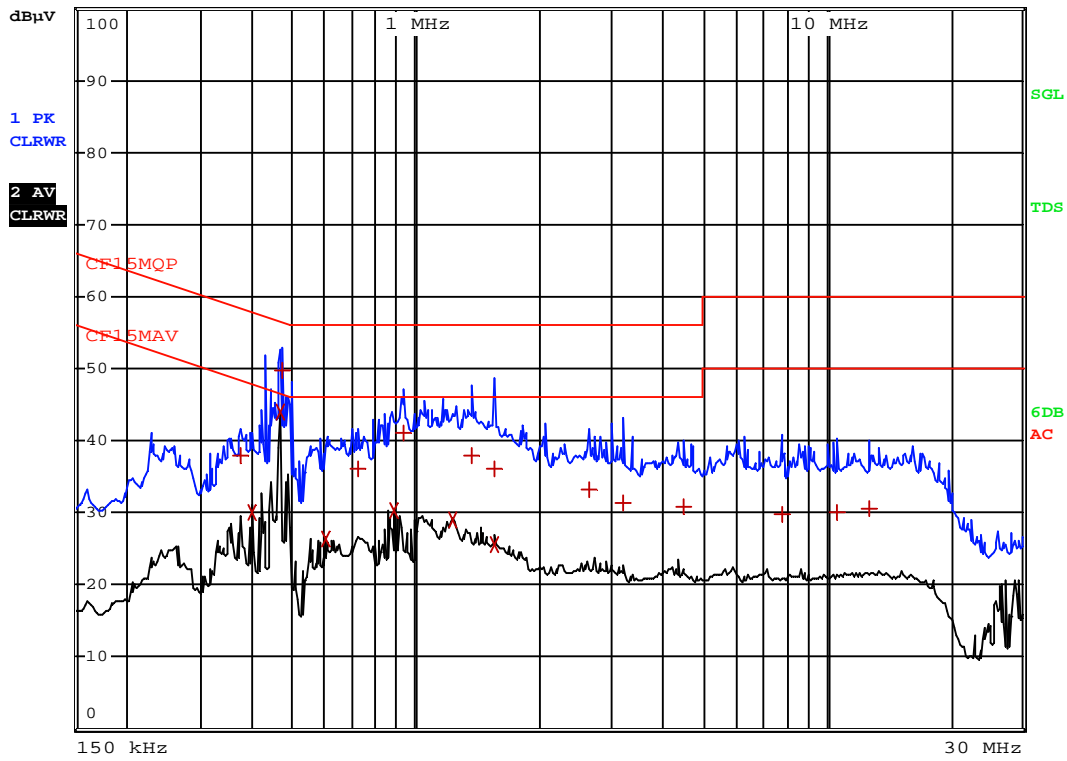

INTERTEK TESTING SERVICES

Worst Case: WiFi Only

EDIT PEAK LIST (Final Measurement Results)

Trace1: CF15MQP

Trace2: CF15MAV

Trace3: ---

	TRACE	FREQUENCY	LEVEL	dB μ V		DELTA	LIMIT	dB
1	Quasi Peak	213 kHz	32.61	N		-30.46		
1	Quasi Peak	393 kHz	38.16	N		-19.83		
2	CISPR Average	402 kHz	28.84	L1		-18.96		
1	Quasi Peak	465 kHz	51.54	L1		-5.06		
2	CISPR Average	465 kHz	44.15	N		-2.45		
1	Quasi Peak	748.5 kHz	36.84	N		-19.15		
2	CISPR Average	753 kHz	26.64	L1		-19.35		
1	Quasi Peak	937.5 kHz	40.16	N		-15.83		
2	CISPR Average	1.0635 MHz	29.75	N		-16.24		
2	CISPR Average	1.221 MHz	29.02	N		-16.97		
1	Quasi Peak	1.338 MHz	39.11	L1		-16.88		
2	CISPR Average	1.5405 MHz	25.37	N		-20.62		
1	Quasi Peak	1.7205 MHz	35.31	N		-20.68		
1	Quasi Peak	2.8905 MHz	33.07	N		-22.92		
1	Quasi Peak	2.9985 MHz	32.45	N		-23.54		
1	Quasi Peak	4.461 MHz	31.94	N		-24.05		
1	Quasi Peak	5.7705 MHz	32.49	L1		-27.50		
1	Quasi Peak	8.9205 MHz	30.59	L1		-29.40		
1	Quasi Peak	13.6005 MHz	33.58	N		-26.41		

INTERTEK TESTING SERVICES

Worst Case: Data transfer via USB with WiFi ON

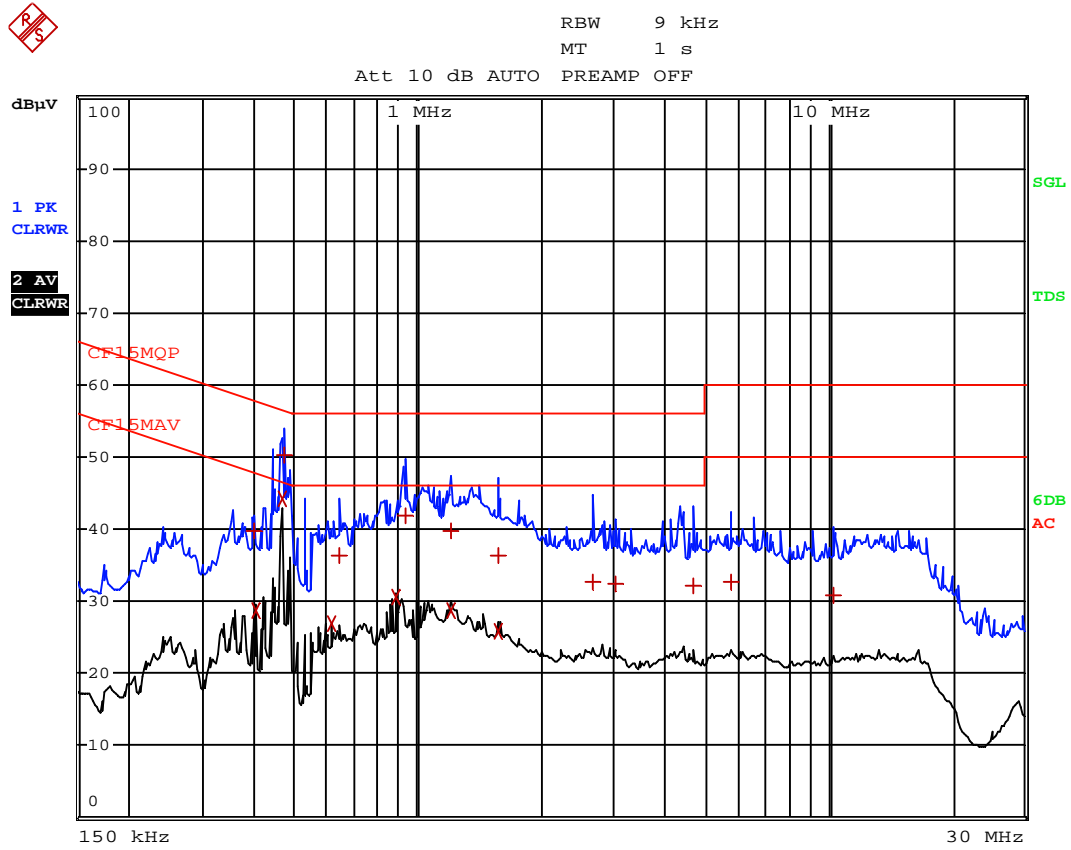

INTERTEK TESTING SERVICES

Worst Case: Data transfer via USB with WiFi ON

EDIT PEAK LIST (Final Measurement Results)

Trace1: CF15MQP

Trace2: CF15MAV

Trace3: ---

	TRACE	FREQUENCY	LEVEL	dB μ V		DELTA	LIMIT	dB
1	Quasi Peak	397.5 kHz	39.83	N		-18.07		
2	CISPR Average	402 kHz	28.72	N		-19.08		
2	CISPR Average	465 kHz	44.11	L1		-2.48		
1	Quasi Peak	469.5 kHz	50.32	N		-6.20		
2	CISPR Average	618 kHz	26.94	N		-19.05		
1	Quasi Peak	645 kHz	36.24	L1		-19.75		
2	CISPR Average	888 kHz	30.70	N		-15.29		
1	Quasi Peak	933 kHz	41.75	L1		-14.24		
1	Quasi Peak	1.2075 MHz	39.70	N		-16.29		
2	CISPR Average	1.2075 MHz	28.83	L1		-17.16		
1	Quasi Peak	1.5675 MHz	36.41	N		-19.58		
2	CISPR Average	1.5675 MHz	25.82	N		-20.18		
1	Quasi Peak	2.6745 MHz	32.73	N		-23.26		
1	Quasi Peak	3.0255 MHz	32.35	N		-23.64		
1	Quasi Peak	4.6905 MHz	32.08	N		-23.91		
1	Quasi Peak	5.7975 MHz	32.60	N		-27.39		
1	Quasi Peak	10.275 MHz	30.82	L1		-29.17		

INTERTEK TESTING SERVICES

4.7.3 Conducted Emission Test Setup

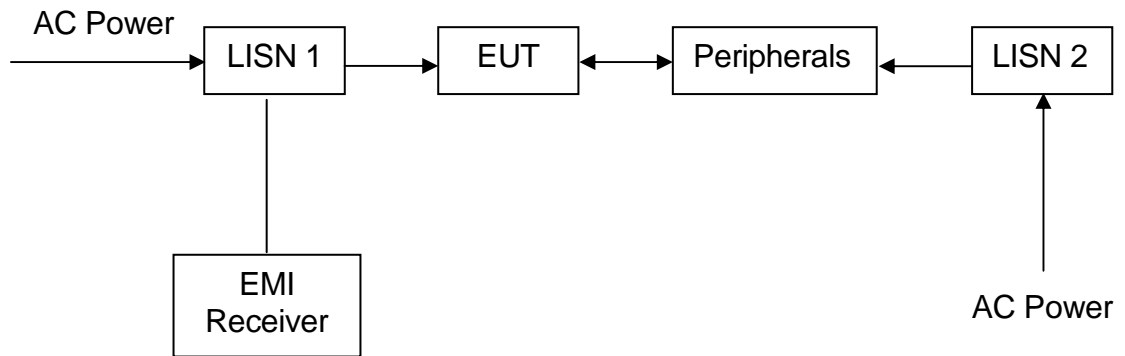

INTERTEK TESTING SERVICES

**EXHIBIT 5
EQUIPMENT LIST**

INTERTEK TESTING SERVICES

5.0 Equipment List

1) Radiated Emissions Test

Equipment	EMI Test Receiver	Spectrum Analyzer
Registration No.	EW-3156	EW-2466
Manufacturer	R&S	R&S
Model No.	ESR26	FSP30
Calibration Date	Nov. 03, 2015	Sep. 16, 2015
Calibration Due Date	Nov. 03, 2016	Aug. 20, 2016

Equipment	Biconical Antenna	Log Periodic Antenna	Double Ridged Guide Antenna
Registration No.	EW-0571	EW-0447	EW-1133
Manufacturer	EMCO	EMCO	EMCO
Model No.	3104C	3146	3115
Calibration Date	Jun. 23, 2015	Mar. 16, 2015	Nov. 05, 2015
Calibration Due Date	Dec. 23, 2016	Sep. 16, 2016	May 05, 2017

2) Conducted Emissions Test

Equipment	EMI Test Receiver	LISN
Registration No.	EW-2500	EW-2501
Manufacturer	R&S	R&S
Model No.	ESCI	ENV-216
Calibration Date	Jan. 28, 2016	Jan. 28, 2016
Calibration Due Date	Jan. 28, 2017	Jan. 28, 2017

3) Conductive Measurement Test

Equipment	RF Power Meter	Power Sensor	Spectrum Analyzer
Registration No.	SZ182-02	SZ182-02-01	EW-2249
Manufacturer	ANRITSU	ANRITSU	R&S
Model No.	ML2496A	MA2411B	FSP30
Calibration Date	May. 23, 2016	May. 23, 2016	Nov. 17, 2015
Calibration Due Date	May. 23, 2017	May. 23, 2017	Nov. 27, 2016

END OF TEST REPORT