

# SAR Test Report

Report No.: AGC05041160303FH01

**FCC ID** : EW780-0380-00

**APPLICATION PURPOSE** : Original Equipment

**PRODUCT DESIGNATION** : DECT cordless phone

**BRAND NAME** : vtech

**MODEL NAME** : DS6722-3 HS, DS6700 HS, DS672Z-XY HS, DS670Z-XY HS, DS6722-3 DS672Z-XY

**CLIENT** : VTech Telecommunications Ltd.

**DATE OF ISSUE** : Apr. 14,2016

**STANDARD(S)** : IEEE Std. 1528:2013;  
FCC 47CFR § 2.1093;  
IEEE/ANSI C95.1:1992

**REPORT VERSION** : V1.0

Attestation of Global Compliance (Shenzhen) Co., Ltd.

**CAUTION:**

This report shall not be reproduced except in full without the written permission of the test laboratory and shall not be quoted out of context.



The results shown in this test report refer only to the sample(s) tested unless otherwise stated and the sample(s) are retained for 30 days only. The document is issued by AGC, this document cannot be reproduced except in full with our prior written permission. The document is available on request and the brief information for its validation can be assessable and confirmed at <http://www.agc-cert.com>

**Report Revise Record**

Report Version	Revise Time	Issued Date	Valid Version	Notes
V1.0	/	Apr. 14,2016	Valid	Original Report

The results shown in this test report refer only to the sample(s) tested unless otherwise stated and the sample(s) are retained for 30 days only. The document is issued by AGC, this document cannot be reproduced except in full with our prior written permission. The document is available on request and the brief information for its validation can be assessable and confirmed at <http://www.agc-cert.com>



## Test Report Certification

Applicant Name	VTech Telecommunications Ltd.
Applicant Address	23/F, Tai Ping Industrial Centre, Block 1, 57 Ting Kok Road, Tai Po, Hong Kong
Manufacturer Name	VTech (Dongguan) Telecommunications Limited
Manufacturer Address	VTech Science Park, Xia Ling Bei Management Zone, Liaobu, Dongguan Guangdong, China
Product Designation	DECT cordless phone
Brand Name	vtech
Model Name	DS6722-3 HS, DS6700 HS, DS672Z-XY HS, DS670Z-XY HS, DS6722-3 DS672Z-XY
Different Description	See Page 7; The test model is DS6722-3 HS.
EUT Voltage	DC2.4V by battery
Applicable Standard	IEEE Std. 1528:2013; FCC 47CFR § 2.1093; IEEE/ANSI C95.1:1992
Test Date	Mar. 31,2016
Performed Location	Attestation of Global Compliance(Shenzhen) Co., Ltd.
	2 F, Building 2, No.1-No.4, Chaxi Sanwei Technical Industrial Park, Gushu, Xixiang Street, Bao'an District, Shenzhen, China
Report Template	AGCRT-US-1.9G/SAR (2016-03-01)

*Summer Li*

Tested By \_\_\_\_\_

Summer Li(Li Jian'e)      Apr. 14,2016

*Angela Li*

Checked By \_\_\_\_\_

Angela Li(Li Jiao)      Apr. 14,2016

*Solger Zhang*

Authorized By \_\_\_\_\_

Solger Zhang(Zhang Hongyi)  
Authorized Officer      Apr. 14,2016

The results shown in this test report refer only to the sample(s) tested unless otherwise stated and the sample(s) are retained for 30 days only. The document is issued by AGC, this document cannot be reproduced except in full with our prior written permission. The document is available on request and the brief information for its validation can be assessable and confirmed at <http://www.agc-cert.com>



**TABLE OF CONTENTS**

<b>1. SUMMARY OF MAXIMUM SAR VALUE .....</b>	<b>5</b>
<b>2. GENERAL INFORMATION .....</b>	<b>6</b>
2.1. EUT DESCRIPTION .....	6
2.2. TEST PROCEDURE .....	8
2.3. TEST ENVIRONMENT .....	8
<b>3. SAR MEASUREMENT SYSTEM .....</b>	<b>9</b>
3.1. SATIMO SYSTEM DESCRIPTION .....	9
3.2. COMOSAR E-FIELD PROBE .....	10
3.3. ROBOT .....	10
3.4. VIDEO POSITIONING SYSTEM .....	11
3.5. DEVICE HOLDER .....	11
3.6. SAM TWIN PHANTOM .....	12
<b>4. SAR MEASUREMENT PROCEDURE .....</b>	<b>13</b>
4.1. SPECIFIC ABSORPTION RATE (SAR) .....	13
4.2. SAR MEASUREMENT PROCEDURE .....	14
4.3. RF EXPOSURE CONDITIONS .....	16
<b>5. TISSUE SIMULATING LIQUID .....</b>	<b>17</b>
5.1. THE COMPOSITION OF THE TISSUE SIMULATING LIQUID(% WEIGHT) .....	17
5.2. TISSUE DIELECTRIC PARAMETERS FOR HEAD AND BODY PHANTOMS .....	17
5.3. TISSUE CALIBRATION RESULT .....	18
<b>6. SAR SYSTEM CHECK&amp;VALIDATION PROCEDURE .....</b>	<b>19</b>
6.1. SAR SYSTEM CHECK PROCEDURES .....	19
6.2. SAR SYSTEM CHECK .....	20
6.3. SAR SYSTEM VALIDATION .....	21
<b>7. EUT TEST POSITION .....</b>	<b>22</b>
7.1. BODY PART POSITION .....	22
<b>8. SAR EXPOSURE LIMITS .....</b>	<b>23</b>
<b>9. TEST EQUIPMENT LIST .....</b>	<b>24</b>
<b>10. MEASUREMENT UNCERTAINTY .....</b>	<b>25</b>
<b>11. CONDUCTED POWER MEASUREMENT .....</b>	<b>27</b>
<b>12. TEST RESULTS .....</b>	<b>28</b>
12.1. SAR TEST RESULTS SUMMARY .....	28
<b>APPENDIX A. SAR SYSTEM CHECK DATA .....</b>	<b>30</b>
<b>APPENDIX B. SAR MEASUREMENT DATA .....</b>	<b>34</b>
<b>APPENDIX C. TEST SETUP PHOTOGRAPHS &amp; EUT PHOTOGRAPHS .....</b>	<b>70</b>
<b>APPENDIX D. CALIBRATION DATA .....</b>	<b>70</b>

The results shown in this test report refer only to the sample(s) tested unless otherwise stated and the sample(s) are retained for 30 days only. The document is issued by AGC, this document cannot be reproduced except in full with our prior written permission. The document is available on request and the brief information for its validation can be assessable and confirmed at <http://www.agc-cert.com>

## 1.SUMMARY OF MAXIMUM SAR VALUE

The maximum results of Specific Absorption Rate (SAR) found during testing for EUT are as follows:

### Highest Reported SAR :

Exposure Position	Frequency Band(MHz)	Highest Reported 1g-SAR(W/Kg)
Head	1924.992	0.052
Body	1924.992	0.056

This device is compliance with Specific Absorption Rate (SAR) for general population/uncontrolled exposure limits (1.6W/Kg) specified in IEEE Std. 1528:2013;FCC 47CFR § 2.1093; IEEE/ANSI C95.1 and the following specific FCC Test Procedures:

- KDB 447498 D01 General RF Exposure Guidance v06
- KDB 865664 D01 SAR measurement 100 MHz to 6 GHz v01r04
- KDB 648474 D04 Handset SAR v01r03

The results shown in this test report refer only to the sample(s) tested unless otherwise stated and the sample(s) are retained for 30 days only. The document is issued by AGC, this document cannot be reproduced except in full with our prior written permission. The document is available on request and the brief information for its validation can be assessable and confirmed at <http://www.agc-cert.com>

## 2. GENERAL INFORMATION

### 2.1. EUT Description

General Information	
Product Designation	DECT cordless phone
Test Model	DS6722-3 HS
Hardware Version	35-200597-000-100
Software Version	N/A
Device Category	Portable
RF Exposure Environment	Uncontrolled
Antenna Type	Internal
Duty Cycle	4%(test mode)
DECT Band	
TX Frequency Range	1921.536-1928.448MHz
RX Frequency Range	1922.400-1929.312MHz
Type of modulation	GFSK
Antenna Gain	0dBi
Max. Peak Power	20.6dBm
Accessories	
Battery One	Brand name: GPI Model No. : BT162342/BT262342 Voltage and Capacitance:2.4V 300mAh
Battery Two	Brand name: Corun Model No. : BT162342/BT262342 Voltage and Capacitance:2.4V 300mAh
Battery Three	Brand name: Coslight Model No. : BT162342/BT262342 Voltage and Capacitance:2.4V 300mAh
Adapter	Brand name. : N/A Model No: N/A Input: AC 100-120V, 60Hz, 150mA    Output: DC 6.0V, 400mA

Product	Type
	<input checked="" type="checkbox"/> Production unit <input type="checkbox"/> Identical Prototype

Note: The sample used for testing is end product.

The results shown in this test report refer only to the sample(s) tested unless otherwise stated and the sample(s) are retained for 30 days only. The document is issued by AGC, this document cannot be reproduced except in full with our prior written permission. The document is available on request and the brief information for its validation can be assessable and confirmed at <http://www.agc-cert.com>

**vtech**

VTech Telecommunications Ltd

April 19, 2016  
To whom it may concern,

**FCC-Multiple Models Confirmation Letter**

I, the undersigned, hereby confirm that the family models are listed in the following table.

These models are **identical** as follows:

- Electrical designs, including software & firmware  
 PCB layout  Construction design/Physical design/Enclosure  
 Others, please specify \_\_\_\_\_

The only **differences** between these models are the follows for marketing purpose:

- Color  Cosmetic details  
 Trade name  Model number  
 Others, please specify \_\_\_\_\_

- Suffix (X, Y, Z<sup>n</sup>) represents  
 Color code  Packing configuration  
 Others, please specify \_\_\_\_\_  
 X=any alphanumeric character or blank is presenting number of Handset and extra Charger.  
 Y=any alphanumeric character or blank is presenting different color of enclosure.  
 Z=any alphanumeric character is presenting different package type (material).

,but models with suffix ("X, Y, Z" ) are identical in:

- Electrical designs, including software & firmware  
 PCB layout  
 Construction design/Physical design/Enclosure  
 Others, please specify \_\_\_\_\_

**For the product subject to authorization under FCC Declaration of Conformity:**

In addition, it is to confirm that all the below information

- 1) The U.S. responsible party,
- 2) FCC label artworks and location,
- 3) FCC required statement in the user manual

Are the same but different in the following model numbers only:

Item #	New Model	Model Number	Trade Name	Remarks
1	<input checked="" type="checkbox"/> YES	DS6722-3	vtech	3HS+1BS+2chargers
2	<input checked="" type="checkbox"/> YES	DS672Z-XY	vtech	XHS+1BS+(X-1)chargers
3	<input checked="" type="checkbox"/> YES	DS6722-3 HS	vtech	3HS+2chargers
4	<input checked="" type="checkbox"/> YES	DS6700 HS	vtech	1 HS + 1 Charger
5	<input checked="" type="checkbox"/> YES	DS672Z-XY HS	vtech	XHS+(X-1)chargers
6	<input checked="" type="checkbox"/> YES	DS670Z-XY HS	vtech	1 HS + 1 Charger

The sample(s) being submitted to Intertek Testing Services for conformity assessment is DS6722-3 HS of the above list.

Regards,



Michael Tsui  
Approval Supervisor

The results shown in this test report refer only to the sample(s) tested unless otherwise stated and the sample(s) are retained for 30 days only. The document is issued by AGC, this document cannot be reproduced except in full with our prior written permission. The document is available on request and the brief information for its validation can be assessable and confirmed at <http://www.agc-cert.com>

## 2.2. Test Procedure

1	Turn on the power of all equipment.
2	EUT Communicate with RTX2012, and test them respectively at DECT bands

## 2.3. Test Environment

Ambient conditions in the laboratory:

Items	Required	Actual
Temperature (°C)	18-25	21± 2
Humidity (%RH)	30-70	55±2

The results shown in this test report refer only to the sample(s) tested unless otherwise stated and the sample(s) are retained for 30 days only. The document is issued by AGC, this document cannot be reproduced except in full with our prior written permission. The document is available on request and the brief information for its validation can be assessable and confirmed at <http://www.agc-cert.com>

### 3. SAR MEASUREMENT SYSTEM

#### 3.1. SATIMO System Description

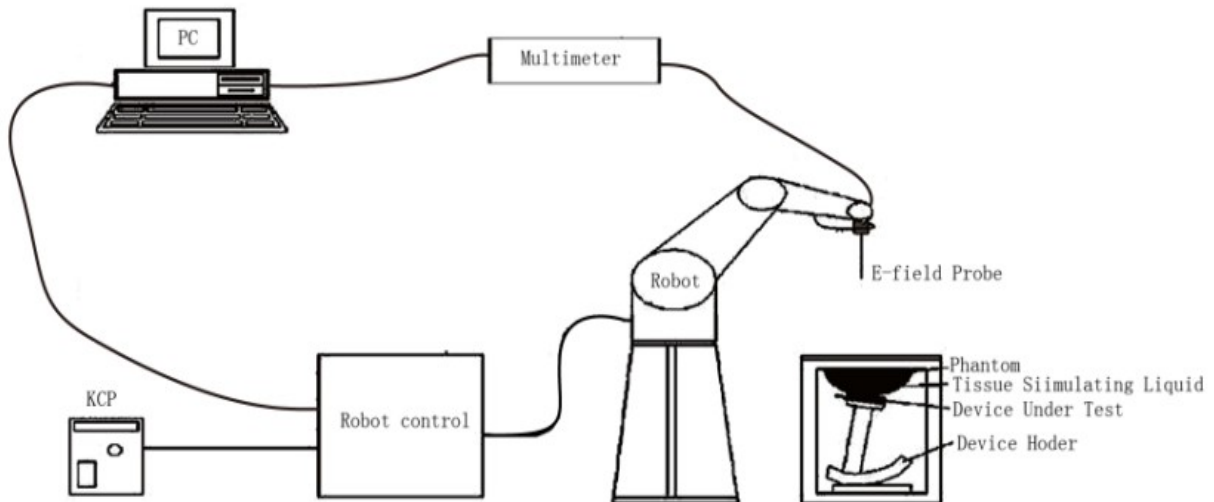

The COMOSAR system for performing compliance tests consists of the following items:

- The PC. It controls most of the bench devices and stores measurement data. A computer running WinXP and the Opensar software
- The E-Field probe. The probe is a 3-axis system made of 3 distinct dipoles. Each dipole returns a voltage in function of the ambient electric field.
- The Keithley multimeter measures each probe dipole voltages.
- The SAM phantom simulates a human head. The measurement of the electric field is made inside the phantom.
- The liquids simulate the dielectric properties of the human head tissues.
- The network emulator controls the mobile phone under test.
- The validation dipoles are used to measure a reference SAR. They are used to periodically check the bench to make sure that there is no drift of the system characteristics over time.
- The phantom, the device holder and other accessories according to the targeted measurement.
- The lower SAR detection threshold of the system is 0.0015 W/Kg.

The results shown in this test report refer only to the sample(s) tested unless otherwise stated and the sample(s) are retained for 30 days only. The document is issued by AGC, this document cannot be reproduced except in full with our prior written permission. The document is available on request and the brief information for its validation can be assessable and confirmed at <http://www.agc-cert.com>

### 3.2. COMOSAR E-Field Probe

The SAR measurement is conducted with the dissymmetric probe manufactured by SATIMO. The probe is specially designed and calibrated for use in liquid with high permittivity. The dissymmetric probe has special calibration in liquid at different frequency. SATIMO conducts the probe calibration in compliance with international and national standards (e.g. IEEE 1528-2013 and relevant KDB files) Under ISO17025. The calibration data are in Appendix D.

#### Isotropic E-Field Probe Specification

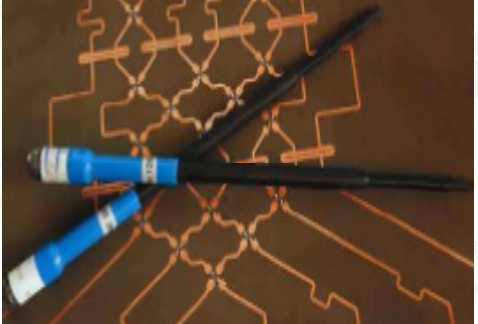
<b>Model</b>	SSE5	
<b>Manufacture</b>	MVG	
<b>Frequency</b>	0.45GHz-3.7GHz Linearity:±0.05dB(450MHz-3.7GHz)	
<b>Dynamic Range</b>	0.01W/Kg-100W/Kg Linearity:±0.05dB	
<b>Dimensions</b>	Overall length:330mm Length of individual dipoles:4.5mm Maximum external diameter:8mm Probe Tip external diameter:5mm Distance between dipoles/ probe extremity:2.7mm	
<b>Application</b>	High precision dosimetric measurements in any exposure scenario (e.g., very strong gradient fields). Only probe which enables compliance testing for frequencies up to 3 GHz with precision of better 30%.	

### 3.3. Robot

The COMOSAR system uses the KUKA robot from SATIMO SA (France). For the 6-axis controller COMOSAR system, the KUKA robot controller version from SATIMO is used.

The XL robot series have many features that are important for our application:

- High precision (repeatability 0.02 mm)
- High reliability (industrial design)
- Jerk-free straight movements
- Low ELF interference (the closed metallic construction shields against motor control fields)
- 6-axis controller



The results shown in this test report refer only to the sample(s) tested unless otherwise stated and the sample(s) are retained for 30 days only. The document is issued by AGC, this document cannot be reproduced except in full with our prior written permission. The document is available on request and the brief information for its validation can be assessable and confirmed at <http://www.agc-cert.com>

### 3.4. Video Positioning System

The video positioning system is used in OpenSAR to check the probe. Which is composed of a camera, LED, mirror and mechanical parts. The camera is piloted by the main computer with firewire link. During the process, the actual position of the probe tip with respect to the robot arm is measured, as well as the probe length and the horizontal probe offset. The software then corrects all movements, such that the robot coordinates are valid for the probe tip. The repeatability of this process is better than 0.1 mm. If a position has been taught with an aligned probe, the same position will be reached with another aligned probe within 0.1 mm, even if the other probe has different dimensions. During probe rotations, the probe tip will keep its actual position.

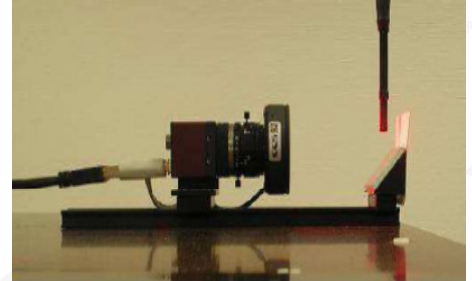

### 3.5. Device Holder

The COMOSAR device holder is designed to cope with different positions given in the standard. It has two scales for the device rotation (with respect to the body axis) and the device inclination (with respect to the line between the ear reference points). The rotation center for both scales is the ear reference point (EPR). Thus the device needs no repositioning when changing the angles. The COMOSAR device holder has been made out of low-loss POM material having the following dielectric parameters: relative permittivity  $\epsilon_r = 3$  and loss tangent  $\delta = 0.02$ . The amount of dielectric material has been reduced in the closest vicinity of the device, since measurements have suggested that the influence of the clamp on the test results could thus be lowered.

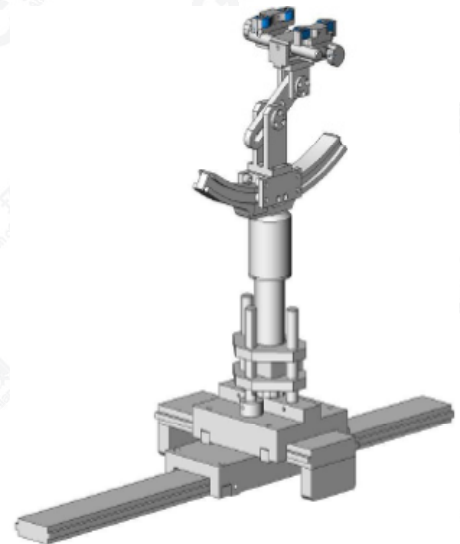

The results shown in this test report refer only to the sample(s) tested unless otherwise stated and the sample(s) are retained for 30 days only. The document is issued by AGC, this document cannot be reproduced except in full with our prior written permission. The document is available on request and the brief information for its validation can be assessable and confirmed at <http://www.agc-cert.com>

### 3.6. SAM Twin Phantom

The SAM twin phantom is a fiberglass shell phantom with 2mm shell thickness (except the ear region where shell thickness increases to 6mm). It has three measurement areas:

- Left head
- Right head
- Flat phantom



The bottom plate contains three pair of bolts for locking the device holder. The device holder positions are adjusted to the standard measurement positions in the three sections. A white cover is provided to tap the phantom during off-periods to prevent water evaporation and changes in the liquid parameters. On the phantom top, three reference markers are provided to identify the phantom position with respect to the robot.

The results shown in this test report refer only to the sample(s) tested unless otherwise stated and the sample(s) are retained for 30 days only. The document is issued by AGC, this document cannot be reproduced except in full with our prior written permission. The document is available on request and the brief information for its validation can be assessable and confirmed at <http://www.agc-cert.com>

## 4. SAR MEASUREMENT PROCEDURE

### 4.1. Specific Absorption Rate (SAR)

SAR is related to the rate at which energy is absorbed per unit mass in object exposed to a radio field. The SAR distribution in a biological body is complicated and is usually carried out by experimental techniques or numerical modeling. The standard recommends limits for two tiers of groups, occupational/controlled and occupational/uncontrolled, based on a person's awareness and ability to exercise control over his or her exposure. In general, occupational/controlled exposure limits are higher than the limits for general population/uncontrolled.

The SAR definition is the time derivative (rate) of the incremental energy (dW) absorbed by (dissipated in) an incremental mass (dm) contained in a volume element(dv) of given mass density (ρ). The equation description is as below:

$$SAR = \frac{d}{dt} \left( \frac{dW}{dm} \right) = \frac{d}{dt} \left( \frac{dW}{\rho dV} \right)$$

SAR is expressed in units of Watts per kilogram (W/Kg)

SAR can be obtained using either of the following equations:

$$SAR = \frac{\sigma E^2}{\rho}$$

$$SAR = c_h \left. \frac{dT}{dt} \right|_{t=0}$$

Where

SAR	is the specific absorption rate in watts per kilogram;
E	is the r.m.s. value of the electric field strength in the tissue in volts per meter;
σ	is the conductivity of the tissue in siemens per metre;
ρ	is the density of the tissue in kilograms per cubic metre;
c <sub>h</sub>	is the heat capacity of the tissue in joules per kilogram and Kelvin;
$\left. \frac{dT}{dt} \right _{t=0}$	is the initial time derivative of temperature in the tissue in kelvins per second

The results shown in this test report refer only to the sample(s) tested unless otherwise stated and the sample(s) are retained for 30 days only. The document is issued by AGC, this document cannot be reproduced except in full with our prior written permission. The document is available on request and the brief information for its validation can be assessable and confirmed at <http://www.agc-cert.com>

## 4.2. SAR Measurement Procedure

### Step 1: Power Reference Measurement

The Power Reference Measurement and Power Drift Measurement are for monitoring the power drift of the device under test in the batch process. The minimum distance of probe sensors to surface is 2.7mm This distance cannot be smaller than the distance os sensor calibration points to probe tip as `defined in the probe properties,

### Step 2: Area Scan

The Area Scan is used as a fast scan in two dimensions to find the area of high field values, before doing a fine measurement around the hot spot. The sophisticated interpolation routines implemented in SATIMO software can find the maximum locations even in relatively coarse grids. When an Area Scan has measured all reachable points, it computes the field maximal found in the scanned area, within a range of the global maximum. The range (in db) is specified in the standards for compliance testing. For example, a 2db range is required in IEEE Standard 1528 and IEC62209 standards, whereby 3db is a requirement when compliance is assessed in accordance with the ARIB standard (Japan) If one Zoom Scan follows the Area Scan, then only the absolute maximum will be taken as reference. For cases where multiple maximum are detected, the number of Zoom Scan has to be increased accordingly.

Area Scan Parameters extracted from KDB 865664 D01 SAR Measurement 100MHz to 6GHz

	≤ 3 GHz	> 3 GHz
Maximum distance from closest measurement point (geometric center of probe sensors) to phantom surface	5 ± 1 mm	$\frac{1}{2} \cdot \delta \cdot \ln(2) \pm 0.5$ mm
Maximum probe angle from probe axis to phantom surface normal at the measurement location	30° ± 1°	20° ± 1°
Maximum area scan spatial resolution: $\Delta x_{Area}$ , $\Delta y_{Area}$	≤ 2 GHz: ≤ 15 mm 2 – 3 GHz: ≤ 12 mm	3 – 4 GHz: ≤ 12 mm 4 – 6 GHz: ≤ 10 mm
	When the x or y dimension of the test device, in the measurement plane orientation, is smaller than the above, the measurement resolution must be ≤ the corresponding x or y dimension of the test device with at least one measurement point on the test device.	

### Step 3: Zoom Scan

Zoom Scan are used to assess the peak spatial SAR value within a cubic average volume containing 1g abd 10g of simulated tissue. The Zoom Scan measures points(refer to table below) within a cube whose base faces are centered on the maxima found in a preceding area scan job within the same procedure. When the measurement is done, the Zoom Scan evaluates the averaged SAR for 1g and 10g and displays these values next to the job's label.

The results shown in this test report refer only to the sample(s) tested unless otherwise stated and the sample(s) are retained for 30 days only. The document is issued by AGC, this document cannot be reproduced except in full with our prior written permission. The document is available on request and the brief information for its validation can be assessable and confirmed at <http://www.agc-cert.com>

## Zoom Scan Parameters extracted from KDB865664 D01 SAR Measurement 100MHz to 6GHz

Maximum zoom scan spatial resolution: $\Delta x_{Zoom}$ , $\Delta y_{Zoom}$		$\leq 2$ GHz: $\leq 8$ mm 2 – 3 GHz: $\leq 5$ mm*	3 – 4 GHz: $\leq 5$ mm* 4 – 6 GHz: $\leq 4$ mm*
Maximum zoom scan spatial resolution, normal to phantom surface	uniform grid: $\Delta z_{Zoom}(n)$	$\leq 5$ mm	3 – 4 GHz: $\leq 4$ mm 4 – 5 GHz: $\leq 3$ mm 5 – 6 GHz: $\leq 2$ mm
	graded grid	$\Delta z_{Zoom}(1)$ : between 1 <sup>st</sup> two points closest to phantom surface	$\leq 4$ mm
		$\Delta z_{Zoom}(n>1)$ : between subsequent points	$\leq 1.5 \cdot \Delta z_{Zoom}(n-1)$
Minimum zoom scan volume	x, y, z	$\geq 30$ mm	3 – 4 GHz: $\geq 28$ mm 4 – 5 GHz: $\geq 25$ mm 5 – 6 GHz: $\geq 22$ mm
Note: $\delta$ is the penetration depth of a plane-wave at normal incidence to the tissue medium; see draft standard IEEE P1528-2011 for details. * When zoom scan is required and the <u>reported</u> SAR from the <u>area scan based 1-g SAR estimation</u> procedures of KDB 447498 is $\leq 1.4$ W/kg, $\leq 8$ mm, $\leq 7$ mm and $\leq 5$ mm zoom scan resolution may be applied, respectively, for 2 GHz to 3 GHz, 3 GHz to 4 GHz and 4 GHz to 6 GHz.			

## Step 4: Power Drift Measurement

The Power Drift Measurement measures the field at the same location as the most recent power reference measurement within the same procedure, and with the same settings. The Power Drift Measurement gives the field difference in dB from the reading conducted within the same settings. This allows a user to monitor the power drift of the device under test within a batch process. The measurement procedure is the same as Step 1.

The results shown in this test report refer only to the sample(s) tested unless otherwise stated and the sample(s) are retained for 30 days only. The document is issued by AGC, this document cannot be reproduced except in full with our prior written permission. The document is available on request and the brief information for its validation can be assessable and confirmed at <http://www.agc-cert.com>

### 4.3. RF Exposure Conditions

Test Configuration and setting:

The EUT is a model of DECT. For DECT SAR testing, the device was controlled through software to set fixed frequency, and then connected with RTX2012.

The distance between the EUT and the antenna is larger than 50cm, and the output power radiated from the antenna is at least 30db smaller than the output power of EUT.

**Antenna Location: (back view)**

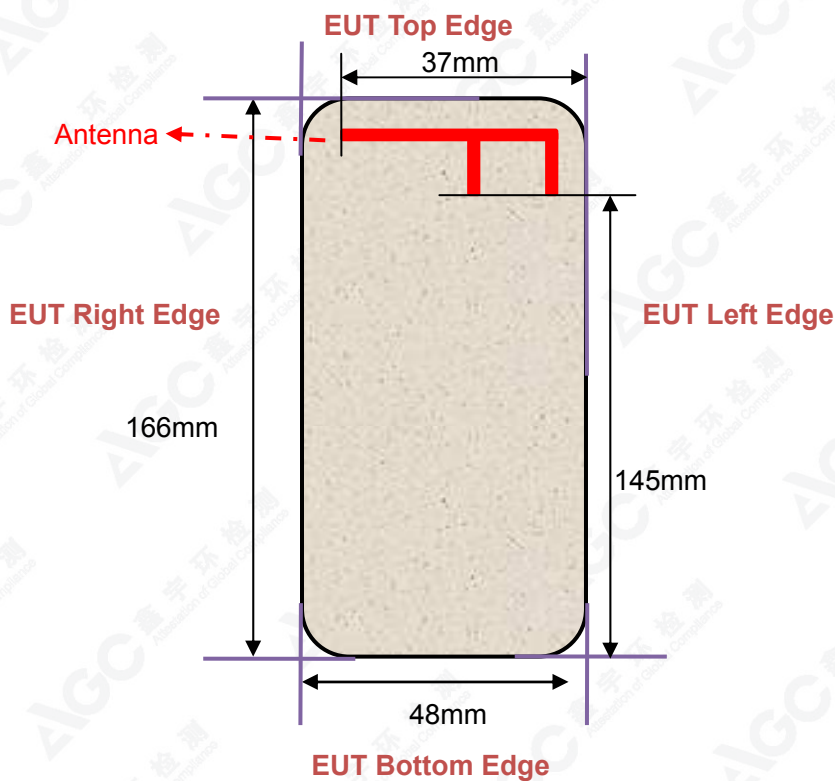

The results shown in this test report refer only to the sample(s) tested unless otherwise stated and the sample(s) are retained for 30 days only. The document is issued by AGC, this document cannot be reproduced except in full with our prior written permission. The document is available on request and the brief information for its validation can be assessed and confirmed at <http://www.agc-cert.com>

## 5. TISSUE SIMULATING LIQUID

For SAR measurement of the field distribution inside the phantom, the phantom must be filled with homogeneous tissue simulating liquid to a depth of at least 15cm. For head SAR testing the liquid height from the ear reference point (ERP) of the phantom to the liquid top surface is larger than 15cm For body SAR testing, the liquid height from the center of the flat phantom to the liquid top surface is larger than 15cm. The nominal dielectric values of the tissue simulating liquids in the phantom and the tolerance of 5% are listed in 5.2

### 5.1. The composition of the tissue simulating liquid(% Weight)

Ingredient (Weight)	1900MHz	1900MHz
	Head (100%)	Body (100%)
<b>Water</b>	54.9	40.4
<b>Salt</b>	0.18	0.5
<b>Sugar</b>	0.0	58.0
<b>HEC</b>	0.0	1.0
<b>Bactericide</b>	0.0	0.1
<b>DGBE</b>	44.92	0.0

### 5.2. Tissue Dielectric Parameters for Head and Body Phantoms

The head tissue dielectric parameters recommended by the IEEE 1528 have been incorporated in the following table. These head parameters are derived from planar layer models simulating the highest expected SAR for the dielectric properties and tissue thickness variations in a human head. Other head and body tissue parameters that have not been specified in IEEE 1528 are derived from the tissue dielectric parameters computed from the 4-Cole-Cole equations described in Reference [12] and extrapolated according to the head parameters specified in IEEE 1528.

Target Frequency (MHz)	head		body	
	$\epsilon_r$	$\sigma$ (S/m)	$\epsilon_r$	$\sigma$ (S/m)
300	45.3	0.87	58.2	0.92
450	43.5	0.87	56.7	0.94
835	41.5	0.90	55.2	0.97
900	41.5	0.97	55.0	1.05
915	41.5	1.01	55.0	1.06
1450	40.5	1.20	54.0	1.30
1610	40.3	1.29	53.8	1.40
<b>1800-2000</b>	<b>40.0</b>	<b>1.40</b>	<b>53.3</b>	<b>1.52</b>
2450	39.2	1.80	52.7	1.95
3000	38.5	2.40	52.0	2.73
5800	35.3	5.27	48.2	6.00

( $\epsilon_r$  = relative permittivity,  $\sigma$  = conductivity and  $\rho = 1000$  kg/m<sup>3</sup>)

The results shown in this test report refer only to the sample(s) tested unless otherwise stated and the sample(s) are retained for 30 days only. The document is issued by AGC, this document cannot be reproduced except in full with our prior written permission. The document is available on request and the brief information for its validation can be assessable and confirmed at <http://www.agc-cert.com>

### 5.3. Tissue Calibration Result

The dielectric parameters of the liquids were verified prior to the SAR evaluation using SATIMO Dielectric Probe Kit and R&S Network Analyzer ZVL6.

Tissue Stimulant Measurement for 1900MHz					
	Fr. (MHz)	Dielectric Parameters ( $\pm 5\%$ )		Tissue Temp [ $^{\circ}\text{C}$ ]	Test time
		$\epsilon_r$ 40.00(38.00-42.00)	$\delta$ [s/m]1.40(1.33-1.47)		
Head	1900	41.06	1.36	20.7	Mar. 31,2016
	1921	40.88	1.38		
	1925	40.73	1.41		
	1928	39.97	1.43		
	Fr. (MHz)	Dielectric Parameters ( $\pm 5\%$ )		Tissue Temp [ $^{\circ}\text{C}$ ]	Test time
		$\epsilon_r$ 53.30(50.635-55.965)	$\delta$ [s/m]1.52(1.444-1.596)		
Body	1900	53.99	1.46	20.7	Mar. 31,2016
	1921	53.67	1.51		
	1925	52.75	1.52		
	1928	52.70	1.52		

The results shown in this test report refer only to the sample(s) tested unless otherwise stated and the sample(s) are retained for 30 days only. The document is issued by AGC, this document cannot be reproduced except in full with our prior written permission. The document is available on request and the brief information for its validation can be assessable and confirmed at <http://www.agc-cert.com>

## 6. SAR SYSTEM CHECK&VALIDATION PROCEDURE

### 6.1. SAR System Check Procedures

SAR system check is required to confirm measurement accuracy, according to the tissue dielectric media, probe calibration points and other system operating parameters required for measuring the SAR of a test device. The system verification must be performed for each frequency band and within the valid range of each probe calibration point required for testing the device. The same SAR probe(s) and tissue-equivalent media combinations used with each specific SAR system for system verification must be used for device testing. When multiple probe calibration points are required to cover substantially large transmission bands, independent system verifications are required for each probe calibration point. A system verification must be performed before each series of SAR measurements using the same probe calibration point and tissue-equivalent medium. Additional system verification should be considered according to the conditions of the tissue-equivalent medium and measured tissue dielectric parameters, typically every three to four days when the liquid parameters are remeasured or sooner when marginal liquid parameters are used at the beginning of a series of measurements.

Each SATIMO system is equipped with one or more system check kits. These units, together with the predefined measurement procedures within the SATIMO software, enable the user to conduct the system check and system validation. System kit includes a dipole, and dipole device holder.

The system check verifies that the system operates within its specifications. It's performed daily or before every SAR measurement. The system check uses normal SAR measurement in the flat section of the phantom with a matched dipole at a specified distance. The system check setup is shown as below.

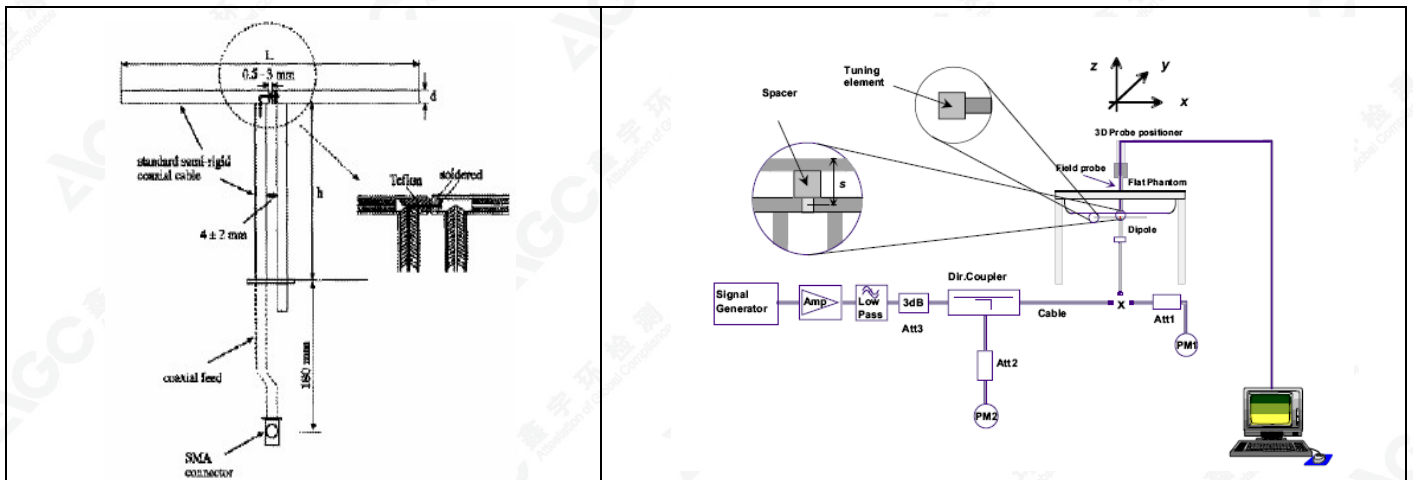

The results shown in this test report refer only to the sample(s) tested unless otherwise stated and the sample(s) are retained for 30 days only. The document is issued by AGC, this document cannot be reproduced except in full with our prior written permission. The document is available on request and the brief information for its validation can be assessable and confirmed at <http://www.agc-cert.com>



**6.2. SAR System Check**  
**6.2.1. Dipoles**

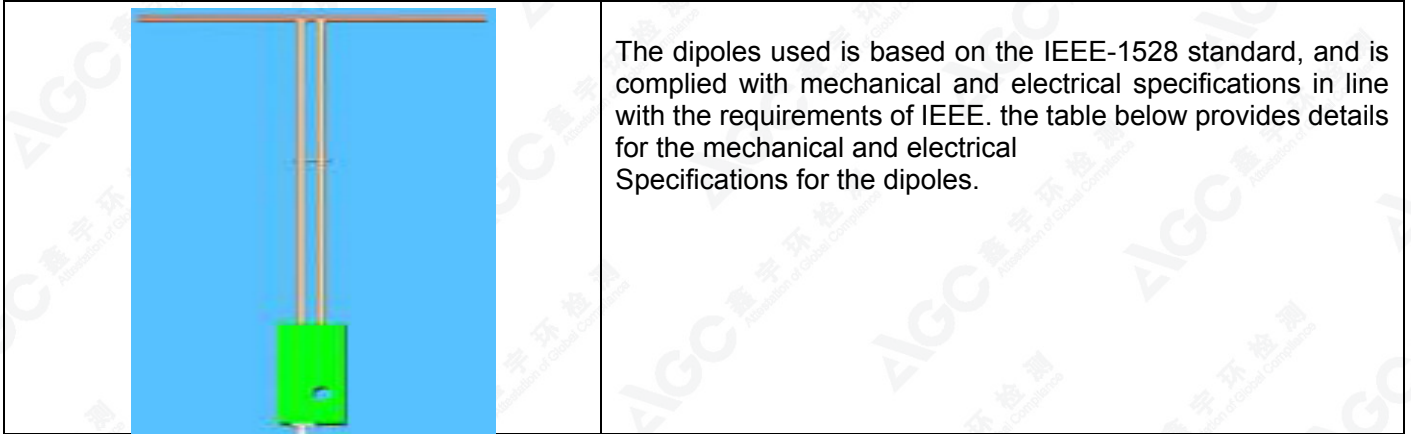

The dipoles used is based on the IEEE-1528 standard, and is complied with mechanical and electrical specifications in line with the requirements of IEEE. the table below provides details for the mechanical and electrical Specifications for the dipoles.

Frequency	L (mm)	h (mm)	d (mm)
1900MHz	68	39.5	3.6

**6.2.2. System Check Result**

System Performance Check at 1900MHz for Body										
Validation Kit: SN 46/11DIP 1G900-187										
Freq. [MHz]	Target Value(W/Kg)		Reference Result (± 10%)		Tested SAR Value(W/Kg) Input Power=18dBm		Normalized to 1W (W/Kg)		Tissue Temp. [°C]	Test time
	1g	10g	1g	10g	1g	10g	1g	10g		
1900 Head	39.65	20.24	35.685-43.615	18.216-22.264	2.260	1.229	35.818	19.478	20.7	Mar. 31,2016
1900 Body	40.74	21.43	36.666-44.814	19.287-23.573	2.498	1.330	39.590	21.079	20.7	Mar. 31,2016

Note:

- (1) We use a CW signal of 18dBm for system check, and then all SAR value are normalized to 1W forward power. The result must be within ± 10% of target value.
- (2) Tested normalized SAR (W/kg) = Tested SAR (W/kg) × [1000/ 10<sup>1.8</sup>]

The results shown in this test report refer only to the sample(s) tested unless otherwise stated and the sample(s) are retained for 30 days only. The document is issued by AGC, this document cannot be reproduced except in full with our prior written permission. The document is available on request and the brief information for its validation can be assessable and confirmed at <http://www.agc-cert.com>



### 6.3. SAR System Validation

The SAR measurement system was validated according to procedures in KDB 865664 D01. SAR probe and tissue dielectric parameters are as shown below.

Test Data	Probe S/N	Tested Freq. (MHz)	Tissue Type	Cond.	Perm	CW validation			Mod. validation		
						Sensitivity	Probe Linearity	Probe Isotropy	Mod. Type	Duty Factor	Peak to average power ratio
12/16/2015	SN 22/12 EP159	1900	head	1.387	39.224	PASS	PASS	PASS	GFSK	PASS	N/A
12/16/2015	SN 22/12 EP159	1900	body	1.565	54.899	PASS	PASS	PASS	GFSK	PASS	N/A

The results shown in this test report refer only to the sample(s) tested unless otherwise stated and the sample(s) are retained for 30 days only. The document is issued by AGC, this document cannot be reproduced except in full with our prior written permission. The document is available on request and the brief information for its validation can be assessable and confirmed at <http://www.agc-cert.com>



## 7. EUT TEST POSITION

This EUT was tested in **Right Cheek, Right Titled, Left Cheek, Left Titled, Body back, Body front**

### 7.1. Body Part Position

- (1) To position the EUT parallel to the phantom surface.
- (2) To adjust the EUT parallel to the flat phantom.
- (3) To adjust the distance between the EUT surface and the flat phantom to **0mm for body back touch and body front.**

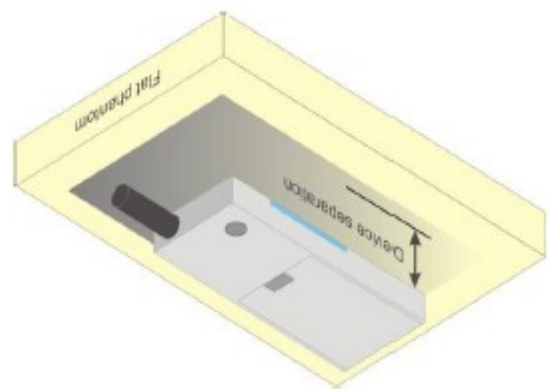
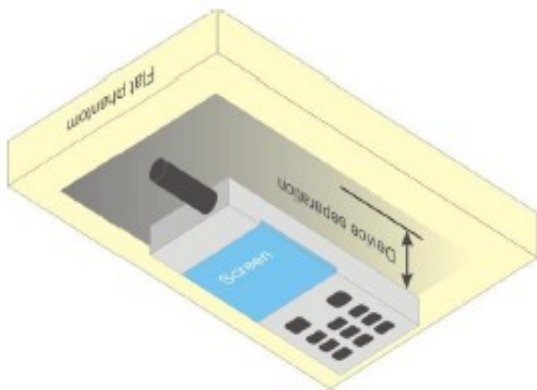

The results shown in this test report refer only to the sample(s) tested unless otherwise stated and the sample(s) are retained for 30 days only. The document is issued by AGC, this document cannot be reproduced except in full with our prior written permission. The document is available on request and the brief information for its validation can be assessable and confirmed at <http://www.agc-cert.com>

## 8. SAR EXPOSURE LIMITS

SAR assessments have been made in line with the requirements of IEEE-1528, and comply with ANSI/IEEE C95.1-1992 "Uncontrolled Environments" limits. These limits apply to a location which is deemed as "Uncontrolled Environment" which can be described as a situation where the general public may be exposed to an RF source with no prior knowledge or control over their exposure.

### Limits for General Population/Uncontrolled Exposure (W/kg)

Type Exposure	Uncontrolled Environment Limit (W/kg)
Spatial Peak SAR (1g cube tissue for brain or body)	1.60
Spatial Average SAR (Whole body)	0.08
Spatial Peak SAR (Limbs)	4.0

The results shown in this test report refer only to the sample(s) tested unless otherwise stated and the sample(s) are retained for 30 days only. The document is issued by AGC, this document cannot be reproduced except in full with our prior written permission. The document is available on request and the brief information for its validation can be assessable and confirmed at <http://www.agc-cert.com>



## 9. TEST EQUIPMENT LIST

Equipment description	Manufacturer/ Model	Identification No.	Current calibration date	Next calibration date
SAR Probe	MVG	SN 22/12 EP159	12/09/2015	12/08/2016
TISSUE Probe	SATIMO	SN 45/11 OCPG45	12/02/2015	12/01/2016
Phantom	SATIMO	SN_4511_SAM90	Validated. No cal required.	Validated. No cal required.
Liquid	SATIMO	-	Validated. No cal required.	Validated. No cal required.
Multimeter	Keithley 2000	1188656	03/10/2016	03/09/2017
Comm Tester	RTX 2012HS-RF	1239-6203	10/20/2015	10/19/2016
Dipole	SATIMO SID1900	SN46/11 DIP 1G900-187	11/14/2013	11/13/2016
Signal Generator	Agilent-E4438C	US41461365	02/29/2016	02/28/2017
Spectrum Analyzer E4440	Agilent	US41421290	07/23/2015	07/22/2016
Network Analyzer	Rhode & Schwarz ZVL6	SN100132	03/01/2016	02/28/2017
Attenuator	Warison /WATT-6SR1211	N/A	N/A	N/A
Attenuator	Mini-circuits / VAT-10+	N/A	N/A	N/A
Amplifier	EM30180	SN060552	03/04/2016	03/03/2017
Directional Couple	Werlatone/ C6026-10	SN99482	07/29/2015	07/28/2016
Power Sensor	NRP-Z21	1137.6000.02	10/20/2015	10/19/2016
Power Sensor	NRP-Z23	US38261498	03/01/2016	02/28/2017
Power Viewer	R&S	V2.3.1.0	N/A	N/A

Note: Per KDB 865664 Dipole SAR Validation, AGC Lab has adopted 3 years calibration intervals. On annual basis, every measurement dipole has been evaluated and is in compliance with the following criteria:

1. There is no physical damage on the dipole;
2. System validation with specific dipole is within 10% of calibrated value;
3. Return-loss is within 20% of calibrated measurement;
4. Impedance is within 5Ω of calibrated measurement.

The results shown in this test report refer only to the sample(s) tested unless otherwise stated and the sample(s) are retained for 30 days only. The document is issued by AGC, this document cannot be reproduced except in full with our prior written permission. The document is available on request and the brief information for its validation can be assessable and confirmed at <http://www.agc-cert.com>

## 10. MEASUREMENT UNCERTAINTY

SATIMO Uncertainty									
Measurement uncertainty for 450 MHz to 3.7 GHz averaged over 1 gram / 10 gram.									
Uncertainty Component	Sec.	Tol (+-%)	Prob. Dist.	Div.	Ci (1g)	Ci (10g)	1g Ui (+-%)	10g Ui (+-%)	Vi
<b>Measurement System</b>									
Probe calibration	E.2.1	5.831	N	1	1	1	5.83	5.83	∞
Axial Isotropy	E.2.2	2.5	R	$\sqrt{3}$	1	1	1.44	1.44	∞
Hemispherical Isotropy	E.2.2	4.0	R	$\sqrt{3}$	1	1	2.31	2.31	∞
Boundary effect	E.2.3	1.0	R	$\sqrt{3}$	1	1	0.58	0.58	∞
Linearity	E.2.4	1.13	R	$\sqrt{3}$	1	1	0.65	0.65	∞
System detection limits	E.2.5	1.0	R	$\sqrt{3}$	1	1	0.58	0.58	∞
Readout Electronics	E.2.6	0.02	N	1	1	1	0.02	0.02	∞
Response Time	E.2.7	3.0	R	$\sqrt{3}$	1	1	1.73	1.73	∞
Integration Time	E.2.8	2.0	R	$\sqrt{3}$	1	1	1.15	1.15	∞
RF ambient Conditions	E.6.1	3.0	R	$\sqrt{3}$	1	1	1.73	1.73	∞
Probe positioner Mechanical Tolerance	E.6.2	2.0	R	$\sqrt{3}$	1	1	1.15	1.15	∞
Probe positioning with respect to Phantom Shell	E.6.3	0.05	R	$\sqrt{3}$	1	1	0.03	0.03	∞
Extrapolation, interpolation and integration Algorithms for Max. SAR Evaluation	E.5.2	5.0	R	$\sqrt{3}$	1	1	2.89	2.89	∞
<b>Test sample Related</b>									
Test sample positioning	E.4.2.1	0.03	N	1	1	1	0.03	0.03	N-1
Device Holder Uncertainty	E.4.1.1	5.00	N	1	1	1	5.00	5.00	∞
Output power Variation - SAR drift measurement	6.6.2	0.65	R	$\sqrt{3}$	1	1	0.38	0.38	∞
<b>Phantom and Tissue Parameters</b>									
Phantom Uncertainty (Shape and thickness tolerances)	E.3.1	0.05	R	$\sqrt{3}$	1	1	0.03	0.03	∞
Liquid conductivity deviation from target value	E.3.2	5.00	R	$\sqrt{3}$	0.64	0.43	1.85	1.24	∞
Liquid conductivity - measurement uncertainty	E.3.3	5.00	N	1	0.64	0.43	3.20	2.15	∞
Liquid permittivity - deviation from target value	E.3.2	0.03	R	$\sqrt{3}$	0.6	0.49	0.01	0.01	∞
Liquid permittivity - measurement uncertainty	E.3.3	10.00	N	1	0.6	0.49	6.00	4.90	M
Combined Standard Uncertainty			RSS				10.27	9.68	∞
Expanded Uncertainty (95% Confidence interval)			k				20.53	19.37	

The results shown in this test report refer only to the sample(s) tested unless otherwise stated and the sample(s) are retained for 30 days only. The document is issued by AGC, this document cannot be reproduced except in full with our prior written permission. The document is available on request and the brief information for its validation can be assessable and confirmed at <http://www.agc-cert.com>

SATIMO Uncertainty									
System uncertainty for 450 MHz to 3.7 GHz averaged over 1 gram / 10 gram.									
Uncertainty Component	Sec.	Tol (+-%)	Prob. Dist.	Div.	Ci (1g)	Ci (10g)	1g Ui (+-%)	10g Ui (+-%)	Vi
<b>Measurement System</b>									
Probe calibration	E.2.1	5.831	N	1	1	1	5.83	5.83	∞
Axial Isotropy	E.2.2	2.5	R	$\sqrt{3}$	1	1	1.44	1.44	∞
Hemispherical Isotropy	E.2.2	4.0	R	$\sqrt{3}$	1	1	2.31	2.31	∞
Boundary Effects	E.2.3	1.0	R	$\sqrt{3}$	1	1	0.58	0.58	∞
Linearity	E.2.4	1.13	R	$\sqrt{3}$	1	1	0.65	0.65	∞
System detection limits	E.2.5	1.0	R	$\sqrt{3}$	1	1	0.58	0.58	∞
Readout Electronics	E.2.6	0.02	N	1	1	1	0.02	0.02	∞
Response Time	E.2.7	3.0	R	$\sqrt{3}$	1	1	1.73	1.73	∞
Integration Time	E.2.8	2.0	R	$\sqrt{3}$	1	1	1.15	1.15	∞
RF ambient Conditions	E.6.1	3.0	R	$\sqrt{3}$	1	1	1.73	1.73	∞
Probe positioner Mechanical Tolerance	E.6.2	2.0	R	$\sqrt{3}$	1	1	1.15	1.15	∞
Probe positioning with respect to Phantom Shell	E.6.3	0.05	R	$\sqrt{3}$	1	1	0.03	0.03	∞
Extrapolation, interpolation and integration Algorithms for Max. SAR Evaluation	E.5.2	5.0	R	$\sqrt{3}$	1	1	2.89	2.89	∞
<b>Dipole</b>									
Dipole axis to liquid Distance	8,E.4.2	1.00	N	$\sqrt{3}$	1	1	0.58	0.58	N-1
Input power and SAR drift measurement	8,6.6.2	0.65	R	$\sqrt{3}$	1	1	0.38	0.38	∞
<b>Phantom and Tissue Parameters</b>									
Phantom Uncertainty (Shape and thickness tolerances)	E.3.1	0.05	R	$\sqrt{3}$	1	1	0.03	0.03	∞
Liquid conductivity - deviation from target value	E.3.2	5.00	R	$\sqrt{3}$	0.64	0.43	1.85	1.24	∞
Liquid conductivity - measurement uncertainty	E.3.3	5.00	N	1	0.64	0.43	3.20	2.15	∞
Liquid permittivity - deviation from target value	E.3.2	0.03	R	$\sqrt{3}$	0.6	0.49	0.01	0.01	∞
Liquid permittivity - measurement uncertainty	E.3.3	10.00	N	1	0.6	0.49	6.00	4.90	M
Combined Standard Uncertainty			RSS				8.99	8.31	
Expanded Uncertainty (95% Confidence interval)			k				17.97	16.62	

The results shown in this test report refer only to the sample(s) tested unless otherwise stated and the sample(s) are retained for 30 days only. The document is issued by AGC, this document cannot be reproduced except in full with our prior written permission. The document is available on request and the brief information for its validation can be assessable and confirmed at <http://www.agc-cert.com>

## 11. CONDUCTED POWER MEASUREMENT

### DECT BAND

#### Battery brand name- GPI

Mode	Frequency (MHz)	Maximum Peak Conducted Power (dBm)
1900MHz	1928.448	20.6
	1924.992	20.5
	1921.536	20.6

#### Battery brand name- Corun

Mode	Frequency (MHz)	Maximum Peak Conducted Power (dBm)
1900MHz	1928.448	20.3
	1924.992	20.3
	1921.536	20.4

#### Battery brand name- Coslight

Mode	Frequency (MHz)	Maximum Peak Conducted Power (dBm)
1900MHz	1928.448	20.6
	1924.992	20.5
	1921.536	20.6

The results shown in this test report refer only to the sample(s) tested unless otherwise stated and the sample(s) are retained for 30 days only. The document is issued by AGC, this document cannot be reproduced except in full with our prior written permission. The document is available on request and the brief information for its validation can be assessable and confirmed at <http://www.agc-cert.com>



## 12. TEST RESULTS

### 12.1. SAR Test Results Summary

#### 12.1.1. Test position and configuration

Head SAR was performed with the device configured in the positions according to IEEE 1528-2013. Body SAR was performed with the device 0mm from the phantom .

#### 12.1.2. Operation Mode

1. Per KDB 447498 D01 v06, for each exposure position, if the highest 1-g SAR is  $\leq 0.8$  W/kg, testing for low and high channel is optional.
2. Per KDB 865664 D01 v01r04, for each frequency band, if the measured SAR is  $\geq 0.8$  W/Kg, testing for repeated SAR measurement is required , that the highest measured SAR is only to be tested. When the SAR results are near the limit, the following procedures are required for each device to verify these types of SAR measurement related variation concerns by repeating the highest measured SAR configuration in each frequency band.
  - (1) When the original highest measured SAR is  $\geq 0.8$  W/Kg, repeat that measurement once.
  - (2) Perform a second repeated measurement only if the ratio of largest to smallest SAR for the original and first repeated measurements is  $> 1.20$  or when the original or repeated measurement is  $\geq 1.45$  W/Kg.
  - (3) Perform a third repeated measurement only if the original, first and second repeated measurement is  $\geq 1.5$  W/Kg and ratio of largest to smallest SAR for the original, first and second measurement is  $\geq 1.20$ .
3. Maximum Scaling SAR in order to calculate the Maximum SAR values to test under the standard Peak Power, Calculation method is as follows:  
Maximum Scaling SAR = tested SAR (Max.)  $\times$  [maximum turn-up power (mw)/ maximum measurement output power(mw) ]
4. DECT has a TDD/TDMA frame structure with a complete frame of 10ms duration with 24 time slots. And under these 24 time slots, the first 12 slots are allocated for the transmission from base station to handsets, and the other 12 slots are for the transmission from handsets to base station. During a call, this product will use one of 24 time slots to transmit under worst case, which gives a duty cycle of 1/24 ( = 4.2%).

The results shown in this test report refer only to the sample(s) tested unless otherwise stated and the sample(s) are retained for 30 days only. The document is issued by AGC, this document cannot be reproduced except in full with our prior written permission. The document is available on request and the brief information for its validation can be assessable and confirmed at <http://www.agc-cert.com>

**12.1.3. Test Result**

SAR MEASUREMENT									
Depth of Liquid (cm):>15					Relative Humidity (%): 59.6				
Product: DECT cordless phone									
Test Model: DS6722-3 HS									
Position	Mode	Ch.	Fr. (MHz)	Power Drift (<math>\pm 5\%</math>)	SAR (1g) (W/kg)	Max. Turn-up Power (dBm)	Meas. output Power (dBm)	Scaled SAR (W/Kg)	Limit W/kg
<b>Battery brand name- GPI</b>									
Left Cheek	voice	2	1924.992	0.56	0.044	21.0	20.5	0.049	1.6
Left Tilt	voice	2	1924.992	-0.32	0.028	21.0	20.5	0.031	1.6
Right Cheek	voice	2	1924.992	1.02	0.033	21.0	20.5	0.037	1.6
Right Tilt	voice	2	1924.992	-0.36	0.017	21.0	20.5	0.019	1.6
Body Back With 0mm	voice	2	1924.992	0.89	0.029	21.0	20.5	0.033	1.6
Body Front With 0mm	voice	2	1924.992	0.26	0.050	21.0	20.5	<b>0.056</b>	1.6
<b>Battery brand name- Corun</b>									
Left Cheek	voice	2	1924.992	-0.12	0.044	21.0	20.3	<b>0.052</b>	1.6
Left Tilt	voice	2	1924.992	-1.02	0.029	21.0	20.3	0.034	1.6
Right Cheek	voice	2	1924.992	0.36	0.036	21.0	20.3	0.042	1.6
Right Tilt	voice	2	1924.992	0.53	0.025	21.0	20.3	0.029	1.6
Body Back With 0mm	voice	2	1924.992	0.19	0.028	21.0	20.3	0.033	1.6
Body Front With 0mm	voice	2	1924.992	-0.22	0.047	21.0	20.3	0.055	1.6
<b>Battery brand name- Coslight</b>									
Left Cheek	voice	2	1924.992	0.01	0.043	21.0	20.5	0.048	1.6
Left Tilt	voice	2	1924.992	-0.10	0.026	21.0	20.5	0.029	1.6
Right Cheek	voice	2	1924.992	0.32	0.037	21.0	20.5	0.042	1.6
Right Tilt	voice	2	1924.992	0.41	0.018	21.0	20.5	0.020	1.6
Body Back With 0mm	voice	2	1924.992	-0.89	0.023	21.0	20.5	0.026	1.6
Body Front With 0mm	voice	2	1924.992	0.07	0.045	21.0	20.5	0.050	1.6

Note:

 (1).When the 1-g Reported SAR is  $\leq 0.8$  W/kg, testing for low and high channel is optional. Refer to KDB 447498.

 The results shown in this test report refer only to the sample(s) tested unless otherwise stated and the sample(s) are retained for 30 days only. The document is issued by AGC, this document cannot be reproduced except in full with our prior written permission. The document is available on request and the brief information for its validation can be assessable and confirmed at <http://www.agc-cert.com>

**APPENDIX A. SAR SYSTEM CHECK DATA**

Test Laboratory: AGC Lab

Date: Mar. 31,2016

System Check Head 1900MHz

DUT: Dipole 1900 MHz; Type: SID 1900

Communication System: CW; Communication System Band: D1900 (1900.0 MHz); Duty Cycle:1:1; Conv.F=6.22;  
Frequency: 1900 MHz; Medium parameters used: f = 1900 MHz;  $\sigma=1.36$  mho/m;  $\epsilon_r=41.06$ ;  $\rho= 1000$  kg/m<sup>3</sup> ;  
Phantom section: Flat Section; Input Power=18dBm  
Ambient temperature (°C)20.7, Liquid temperature (°C):20.7

SATIMO Configuration:

- Probe: SSE5; Calibrated: 12/09/2015; Serial No.: SN 22/12 EP159
- Sensor-Surface: 4mm (Mechanical Surface Detection)
- Phantom: SAM twin phantom
- Measurement SW: OpenSAR V4\_02\_01

Configuration/System Check 1900 Head/Area Scan: Measurement grid: dx=8mm, dy=8mm

Configuration/System Check 1900 Head/Zoom Scan: Measurement grid: dx=8mm,dy=8mm, dz=5mm

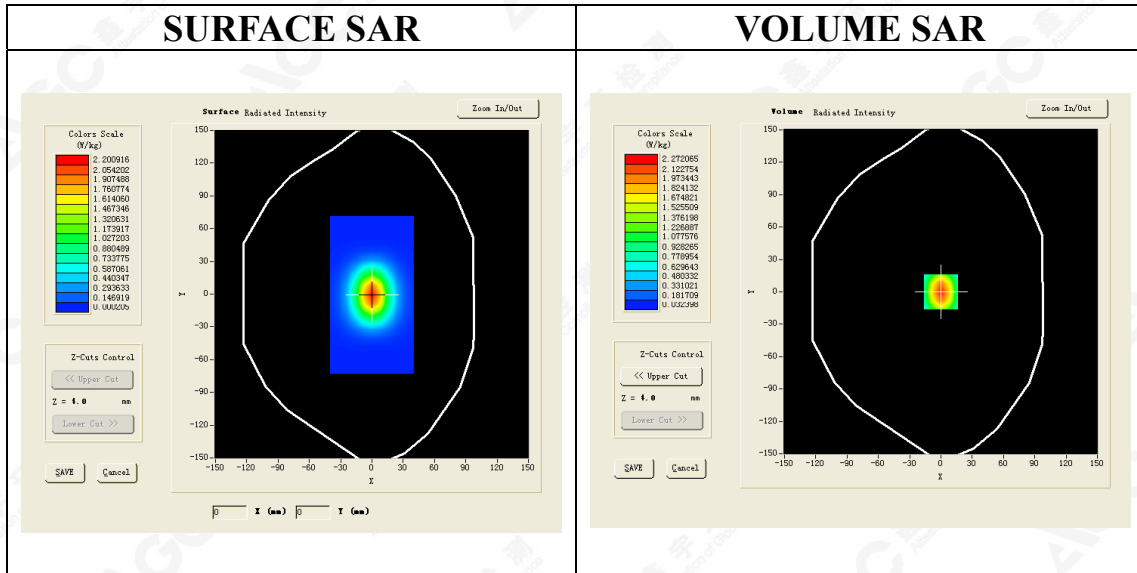

Maximum location: X=0.00, Y=0.00

SAR 10g (W/Kg)	1.228637
SAR 1g (W/Kg)	2.260322

The results shown in this test report refer only to the sample(s) tested unless otherwise stated and the sample(s) are retained for 30 days only. The document is issued by AGC, this document cannot be reproduced except in full with our prior written permission. The document is available on request and the brief information for its validation can be assessable and confirmed at <http://www.agc-cert.com>



Z (mm)	0.00	4.00	9.00	14.00	19.00	24.00	29.00
SAR (W/Kg)	0.0000	2.2721	1.2511	0.7153	0.4101	0.243	0.1396

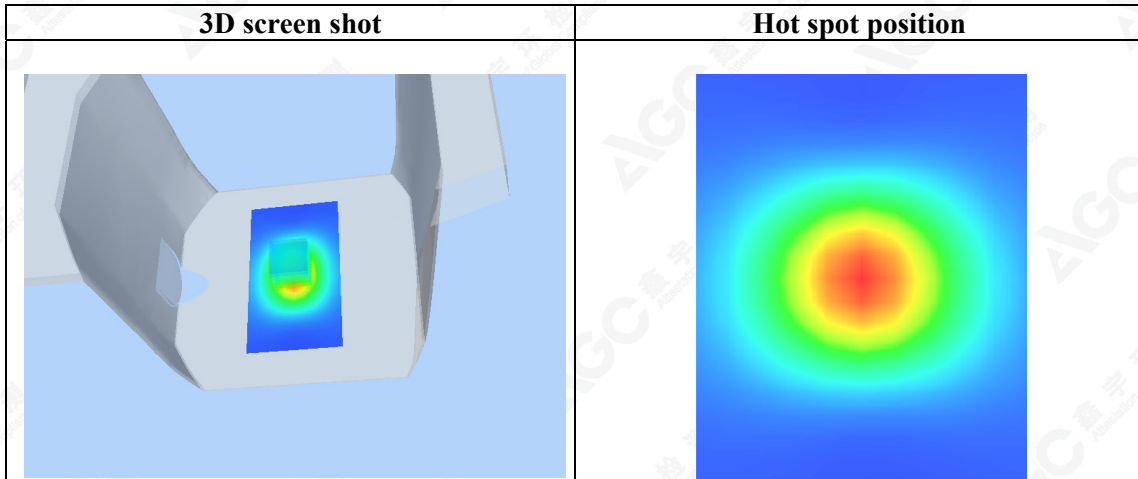
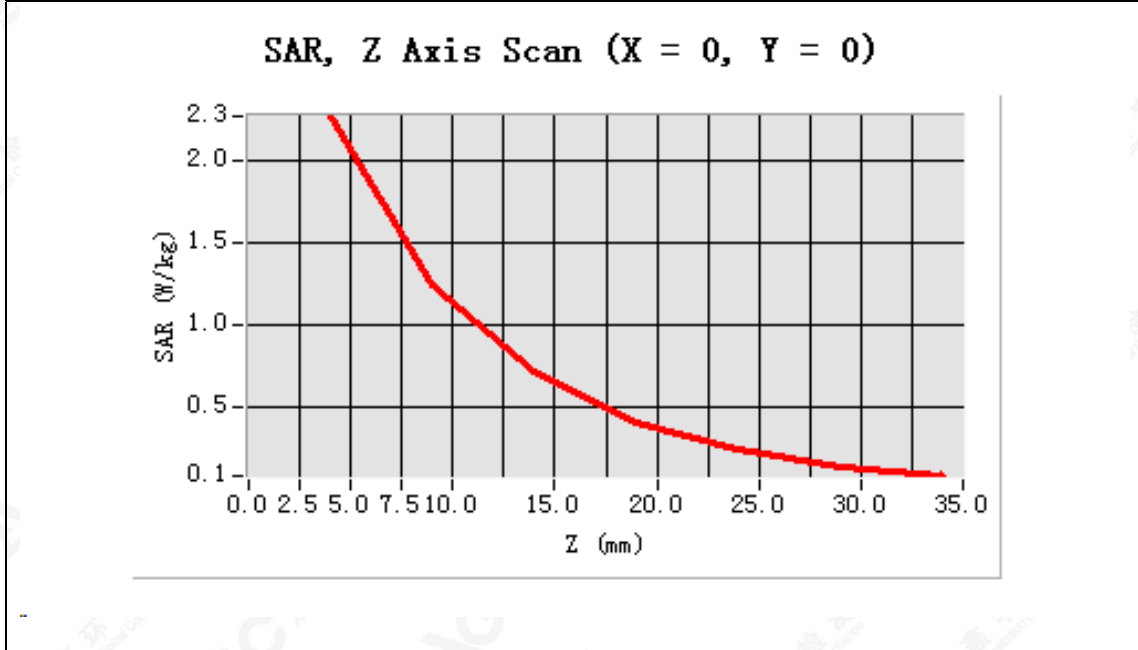

The results shown in this test report refer only to the sample(s) tested unless otherwise stated and the sample(s) are retained for 30 days only. The document is issued by AGC, this document cannot be reproduced except in full with our prior written permission. The document is available on request and the brief information for its validation can be assessable and confirmed at <http://www.agc-cert.com>



**Test Laboratory: AGC Lab**  
**System Check Body 1900MHz**  
**DUT: Dipole 1900 MHz; Type: SID 1900**

**Date: Mar. 31,2016**

Communication System: CW; Communication System Band: D1900 (1900.0 MHz); Duty Cycle:1:1; Conv.F=6.43  
Frequency: 1900 MHz; Medium parameters used:  $f = 1900$  MHz;  $\sigma = 1.46$  mho/m;  $\epsilon_r = 53.99$ ;  $\rho = 1000$  kg/m<sup>3</sup> ;  
Phantom section: Flat Section; Input Power=18dBm  
Ambient temperature (°C):20.7, Liquid temperature (°C): 20.7

**SATIMO Configuration:**

Probe: SSE5; Calibrated: 12/09/2015; Serial No.: SN 22/12 EP159  
Sensor-Surface: 4mm (Mechanical Surface Detection)  
Phantom: SAM twin phantom  
Measurement SW: OpenSAR V4\_02\_01

**Configuration/System Check 1900 Body/Area Scan:** Measurement grid: dx=8mm, dy=8mm  
**Configuration/System Check 1900 Body/Zoom Scan:** Measurement grid: dx=8mm,dy=8mm, dz=5mm

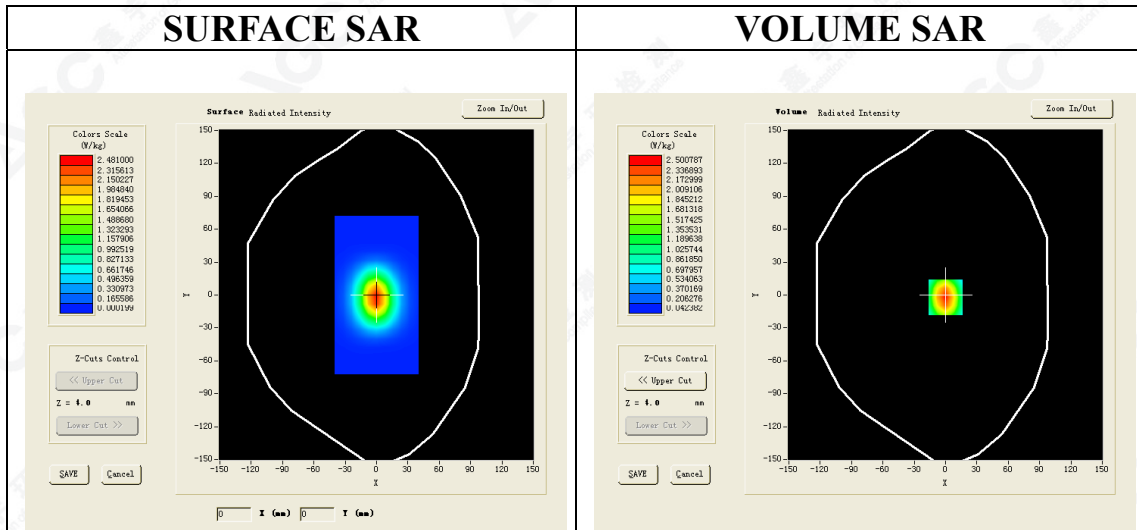

**Maximum location: X=0.00, Y=-2.00**

<b>SAR 10g (W/Kg)</b>	1.330234
<b>SAR 1g (W/Kg)</b>	2.497511

The results shown in this test report refer only to the sample(s) tested unless otherwise stated and the sample(s) are retained for 30 days only. The document is issued by AGC, this document cannot be reproduced except in full with our prior written permission. The document is available on request and the brief information for its validation can be assessable and confirmed at <http://www.agc-cert.com>



Z (mm)	0.00	4.00	9.00	14.00	19.00	24.00	29.00
SAR (W/Kg)	0.0000	2.5008	1.3700	0.7791	0.4465	0.2601	0.1536

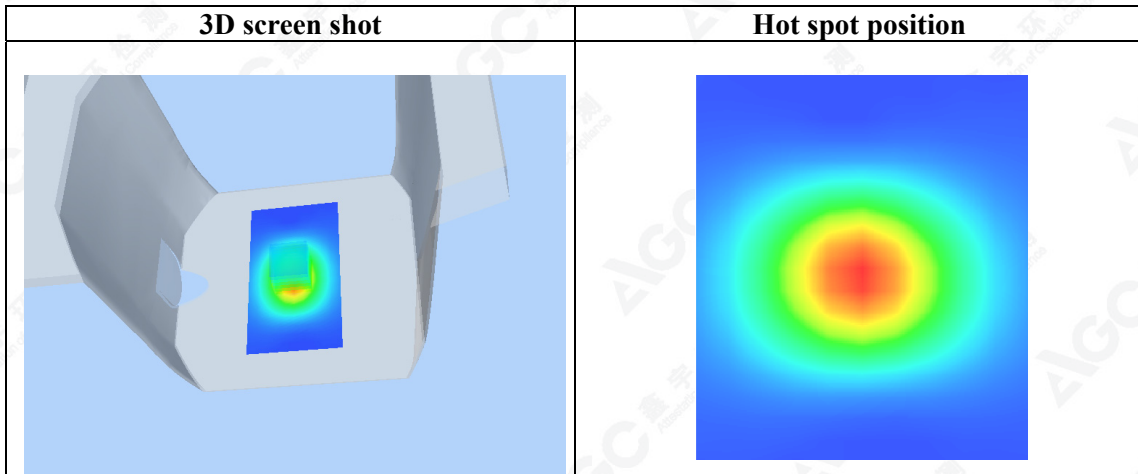
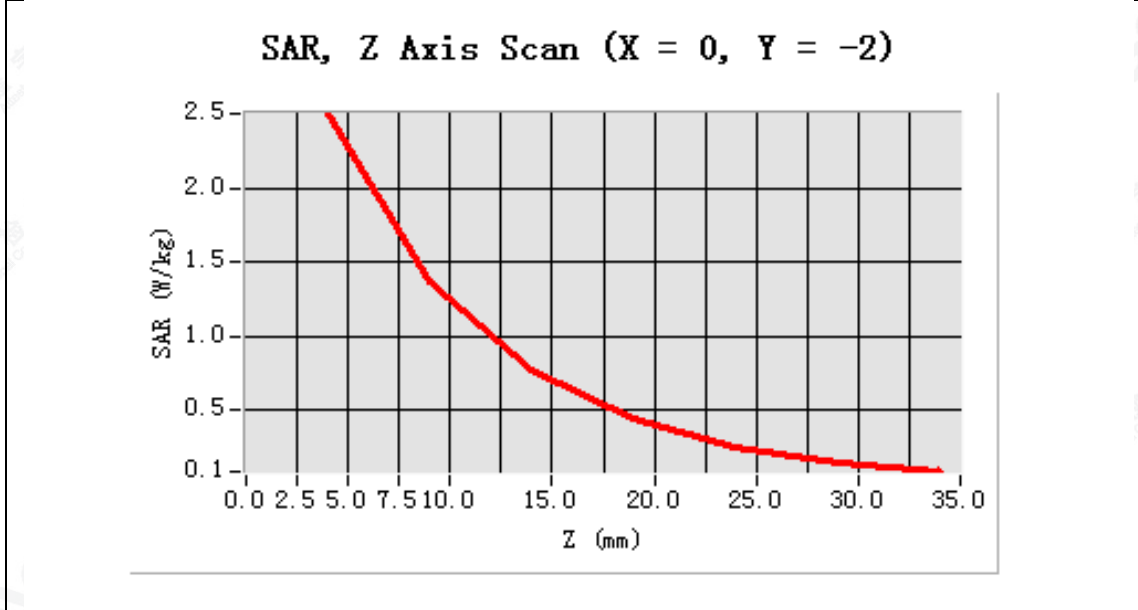

The results shown in this test report refer only to the sample(s) tested unless otherwise stated and the sample(s) are retained for 30 days only. The document is issued by AGC, this document cannot be reproduced except in full with our prior written permission. The document is available on request and the brief information for its validation can be assessable and confirmed at <http://www.agc-cert.com>



**APPENDIX B. SAR MEASUREMENT DATA**

Battery brand name- GPI

Test Laboratory: AGC Lab

DECT 1900 Mid-Touch- Left

DUT: DECT cordless phone; Type: DS6722-3 HS

Date: Mar. 31,2016

Communication System: DECT; Communication System Band: 1900; Duty Cycle: 4%; Conv.F=6.22  
Frequency: 1924.992 MHz; Medium parameters used:  $f = 1900$  MHz;  $\sigma = 1.41$  mho/m;  $\epsilon_r = 40.73$   $\rho = 1000$  kg/m<sup>3</sup> ;  
Phantom section: Left Section  
Ambient temperature (°C)20.7, Liquid temperature (°C):20.7

SATIMO Configuration:

Probe: SSE5; Calibrated: 12/09/2015; Serial No.: SN 22/12 EP159

Sensor-Surface: 4mm (Mechanical Surface Detection)

Phantom: SAM twin phantom

Measurement SW: OpenSAR V4\_02\_01

Configuration/1900 Mid-Touch- Left /Area Scan: Measurement grid: dx=8mm, dy=8mm

Configuration/1900 Mid-Touch- Left t/Zoom Scan: Measurement grid: dx=8mm,dy=8mm, dz=5mm;

<b>Area Scan</b>	sam_direct_droit2_surf8mm.txt
<b>ZoomScan</b>	5x5x7,dx=8mm dy=8mm dz=5mm,Complete
<b>Phantom</b>	Left head
<b>Device Position</b>	Cheek
<b>Band</b>	DECT
<b>Channels</b>	Middle
<b>Signal</b>	Crest factor: 25

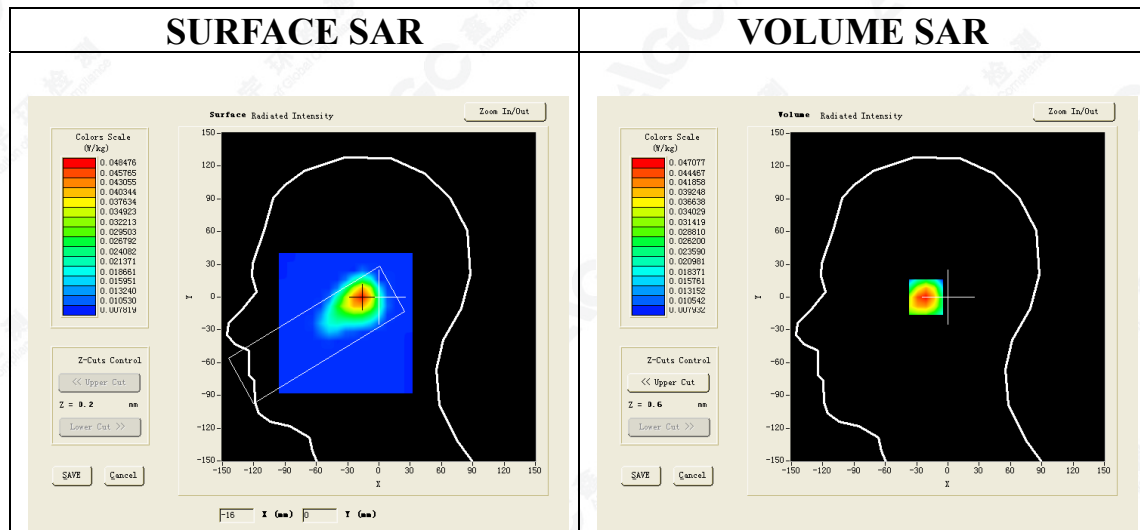

**Maximum location: X=-16.00, Y=0.00**

<b>SAR 10g (W/Kg)</b>	0.025489
<b>SAR 1g (W/Kg)</b>	0.043767

The results shown in this test report refer only to the sample(s) tested unless otherwise stated and the sample(s) are retained for 30 days only. The document is issued by AGC, this document cannot be reproduced except in full with our prior written permission. The document is available on request and the brief information for its validation can be assessable and confirmed at <http://www.agc-cert.com>



Z (mm)	0.00	4.00	9.00	14.00	19.00	24.00	29.00
SAR (W/Kg)	0.0000	0.0471	0.0284	0.0179	0.0102	0.0084	0.0084

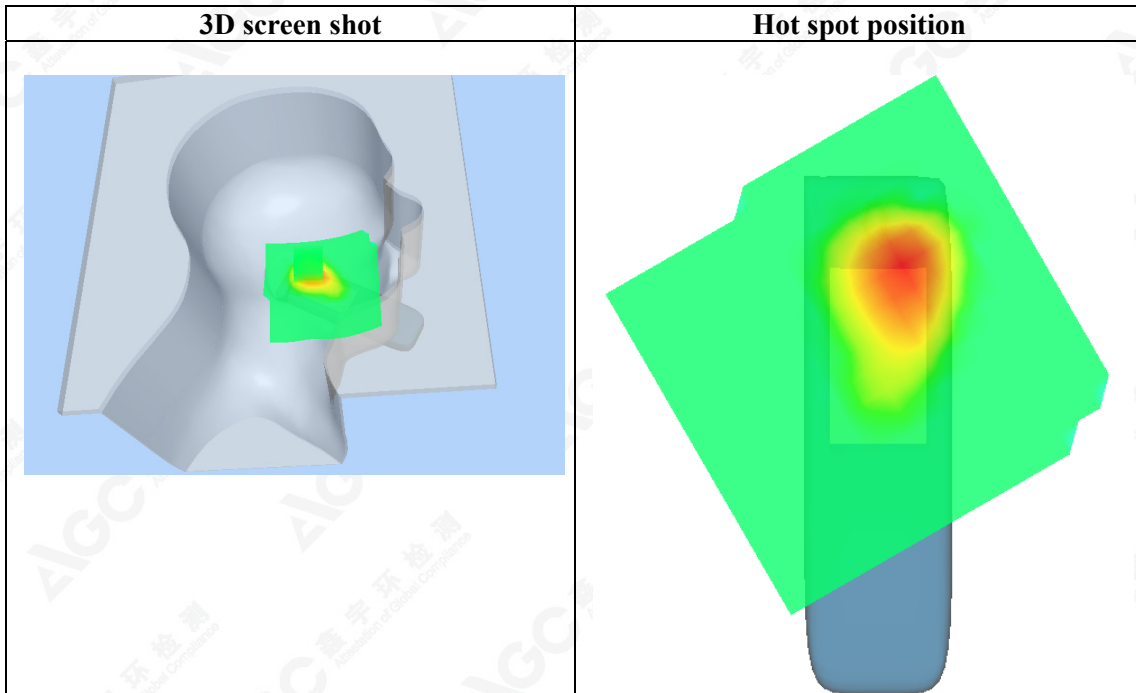
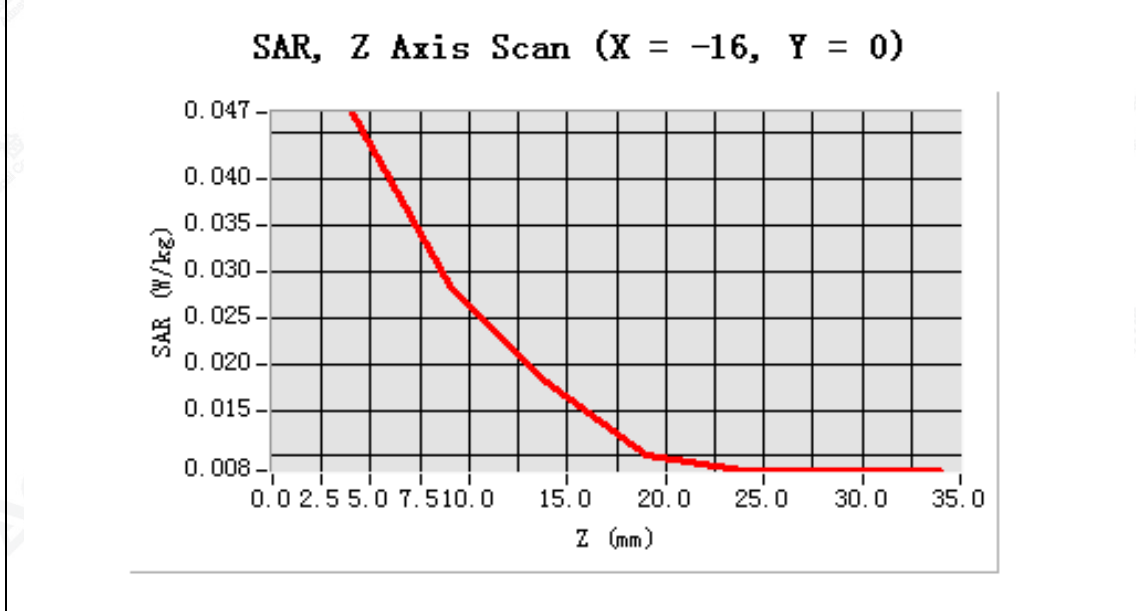

The results shown in this test report refer only to the sample(s) tested unless otherwise stated and the sample(s) are retained for 30 days only. The document is issued by AGC, this document cannot be reproduced except in full with our prior written permission. The document is available on request and the brief information for its validation can be assessable and confirmed at <http://www.agc-cert.com>



**Test Laboratory:** AGC Lab  
**DECT 1900 Mid-Tilt- Left**  
**DUT:** DECT cordless phone; **Type:** DS6722-3 HS

**Date:** Mar. 31,2016

Communication System: DECT; Communication System Band: 1900; Duty Cycle: 4%; Conv.F=6.22  
Frequency: 1924.992 MHz; Medium parameters used:  $f = 1900$  MHz;  $\sigma = 1.41$  mho/m;  $\epsilon_r = 40.73$   $\rho = 1000$  kg/m<sup>3</sup> ;  
Phantom section: Left Section  
Ambient temperature (°C)20.7, Liquid temperature (°C):20.7

**SATIMO Configuration:**

Probe: SSE5; Calibrated: 12/09/2015; Serial No.: SN 22/12 EP159  
Sensor-Surface: 4mm (Mechanical Surface Detection)  
Phantom: SAM twin phantom  
Measurement SW: OpenSAR V4\_02\_01

**Configuration/1900 Mid-Tilt- Left /Area Scan:** Measurement grid: dx=8mm, dy=8mm  
**Configuration/1900 Mid-Tilt- Left t/Zoom Scan:** Measurement grid: dx=8mm,dy=8mm, dz=5mm;

<b>Area Scan</b>	sam_direct_droit2_surf8mm.txt
<b>ZoomScan</b>	5x5x7,dx=8mm dy=8mm dz=5mm,Complete
<b>Phantom</b>	Left head
<b>Device Position</b>	Tilt
<b>Band</b>	DECT
<b>Channels</b>	Middle
<b>Signal</b>	Crest factor: 25

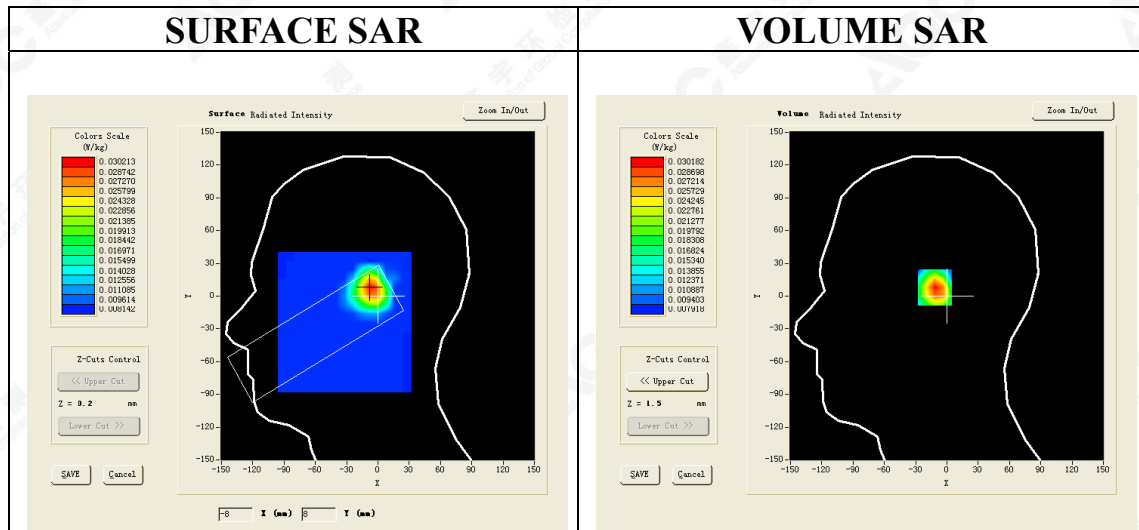

**Maximum location: X=-7.00, Y=8.00**

<b>SAR 10g (W/Kg)</b>	0.016928
<b>SAR 1g (W/Kg)</b>	0.028084

The results shown in this test report refer only to the sample(s) tested unless otherwise stated and the sample(s) are retained for 30 days only. The document is issued by AGC, this document cannot be reproduced except in full with our prior written permission. The document is available on request and the brief information for its validation can be assessable and confirmed at <http://www.agc-cert.com>



Z (mm)	0.00	4.00	9.00	14.00	19.00	24.00	29.00
SAR (W/Kg)	0.0000	0.0302	0.0196	0.0109	0.0084	0.0084	0.0084

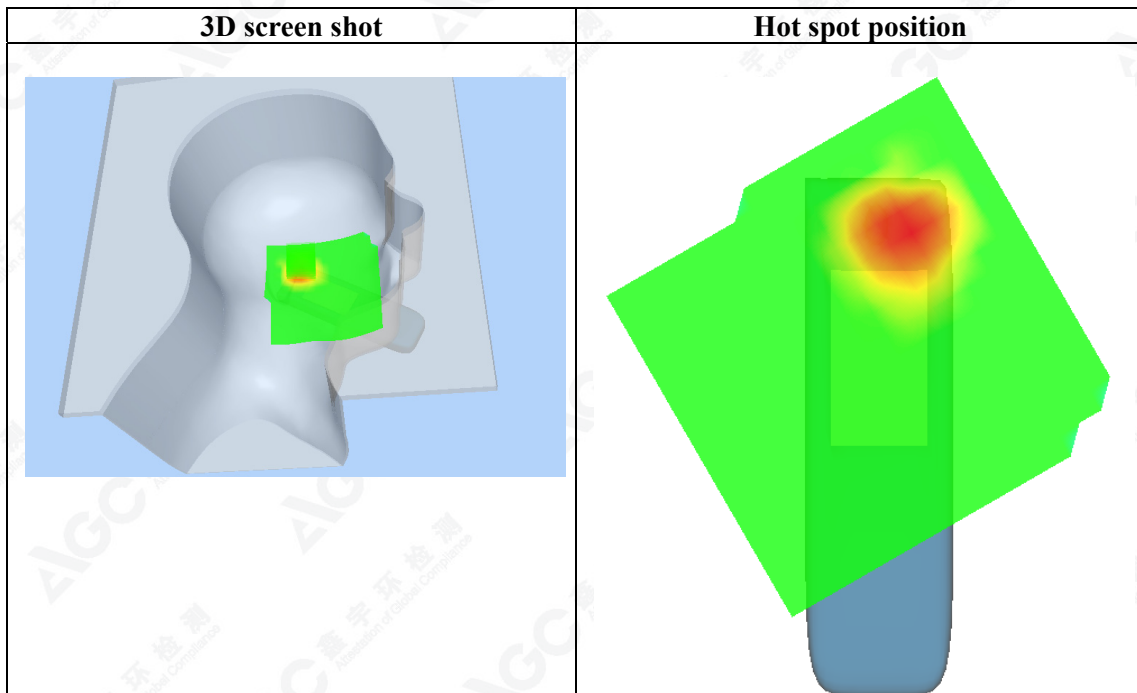
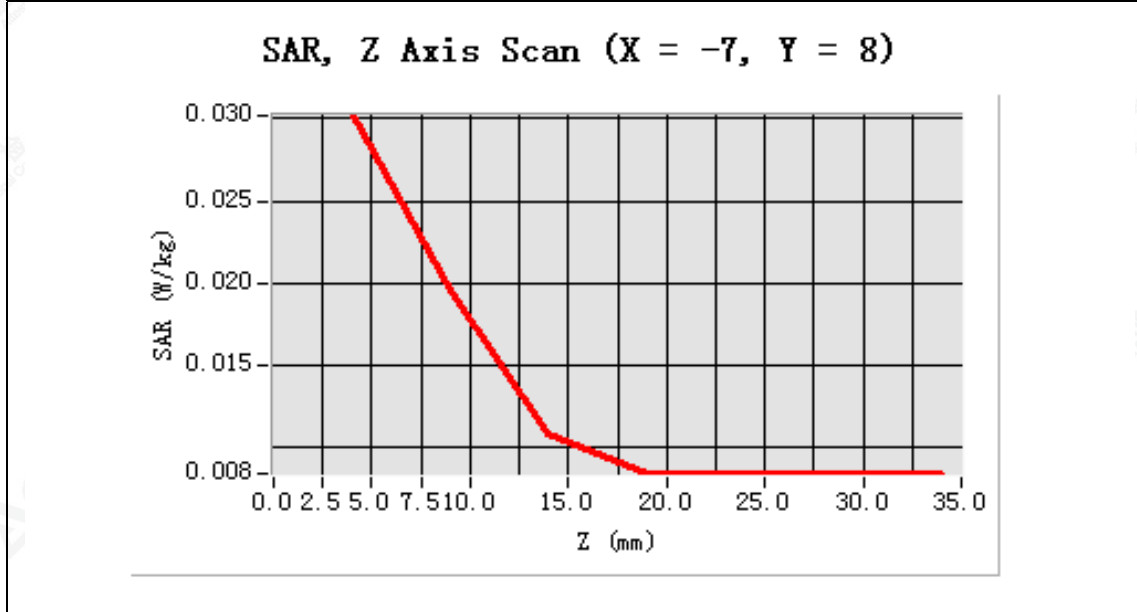

The results shown in this test report refer only to the sample(s) tested unless otherwise stated and the sample(s) are retained for 30 days only. The document is issued by AGC, this document cannot be reproduced except in full with our prior written permission. The document is available on request and the brief information for its validation can be assessable and confirmed at <http://www.agc-cert.com>



**Test Laboratory:** AGC Lab  
**DECT 1900 Mid-Touch- Right**  
**DUT:** DECT cordless phone; **Type:** DS6722-3 HS

**Date:** Mar. 31,2016

Communication System: DECT; Communication System Band: 1900; Duty Cycle: 4%; Conv.F=6.22  
Frequency: 1924.992 MHz; Medium parameters used:  $f = 1900$  MHz;  $\sigma = 1.41$  mho/m;  $\epsilon_r = 40.73$   $\rho = 1000$  kg/m<sup>3</sup> ;  
Phantom section: Right Section  
Ambient temperature (°C)20.7, Liquid temperature (°C):20.7

**SATIMO Configuration:**

Probe: SSE5; Calibrated: 12/09/2015; Serial No.: SN 22/12 EP159  
Sensor-Surface: 4mm (Mechanical Surface Detection)  
Phantom: SAM twin phantom  
Measurement SW: OpenSAR V4\_02\_01

**Configuration/1900 Mid-Touch- Right /Area Scan:** Measurement grid: dx=8mm, dy=8mm  
**Configuration/1900 Mid-Touch- Right t/Zoom Scan:** Measurement grid: dx=8mm,dy=8mm, dz=5mm;

<b>Area Scan</b>	sam_direct_droit2_surf8mm.txt
<b>ZoomScan</b>	5x5x7,dx=8mm dy=8mm dz=5mm,Complete
<b>Phantom</b>	Right head
<b>Device Position</b>	Cheek
<b>Band</b>	DECT
<b>Channels</b>	Middle
<b>Signal</b>	Crest factor: 25

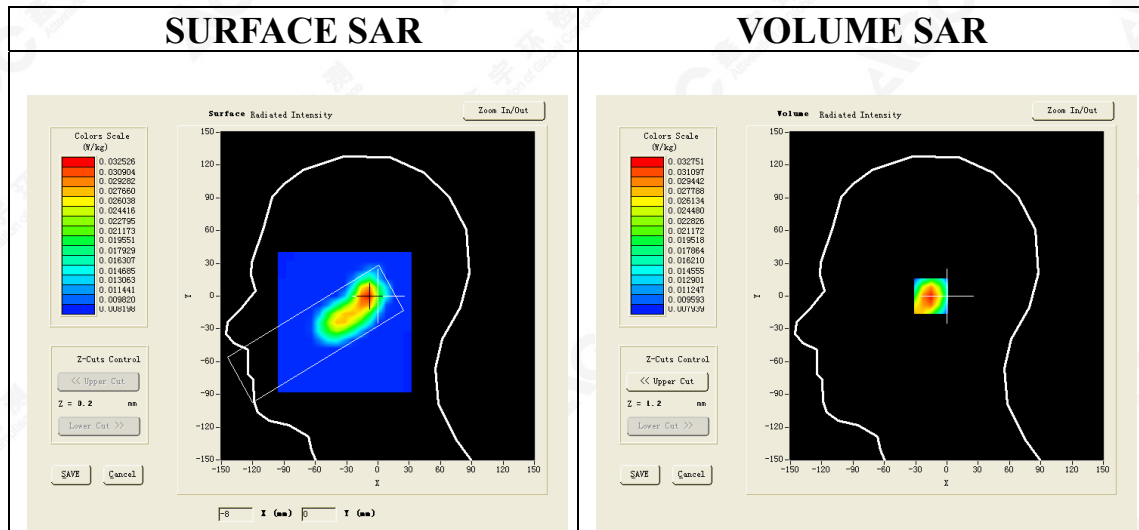

**Maximum location: X=-10.00, Y=0.00**

<b>SAR 10g (W/Kg)</b>	0.018076
<b>SAR 1g (W/Kg)</b>	0.032673

The results shown in this test report refer only to the sample(s) tested unless otherwise stated and the sample(s) are retained for 30 days only. The document is issued by AGC, this document cannot be reproduced except in full with our prior written permission. The document is available on request and the brief information for its validation can be assessable and confirmed at <http://www.agc-cert.com>



Z (mm)	0.00	4.00	9.00	14.00	19.00	24.00	29.00
SAR (W/Kg)	0.0000	0.0328	0.0151	0.0084	0.0084	0.0084	0.0084

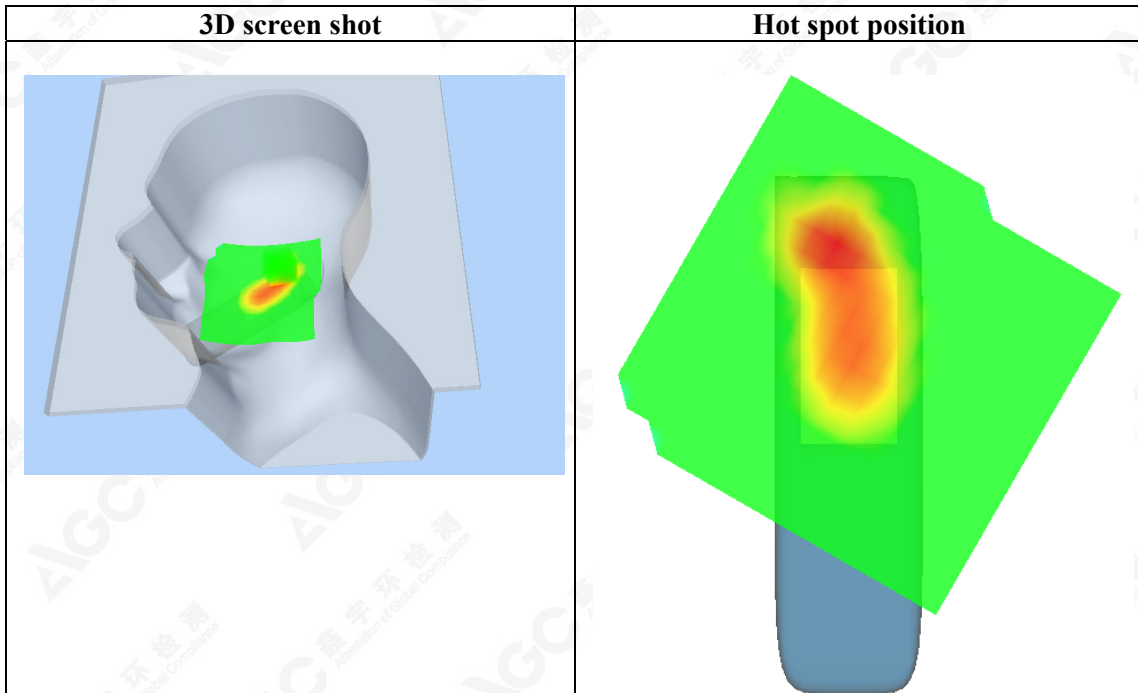
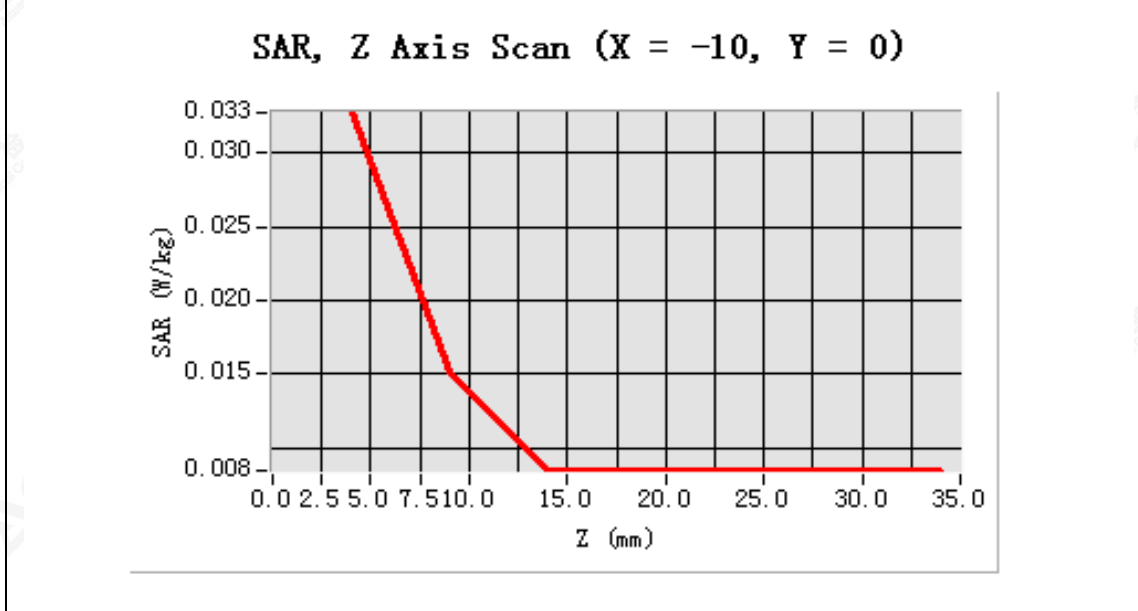

The results shown in this test report refer only to the sample(s) tested unless otherwise stated and the sample(s) are retained for 30 days only. The document is issued by AGC, this document cannot be reproduced except in full with our prior written permission. The document is available on request and the brief information for its validation can be assessable and confirmed at <http://www.agc-cert.com>



**Test Laboratory:** AGC Lab  
**DECT 1900 Mid-Tilt- Right**  
**DUT:** DECT cordless phone; **Type:** DS6722-3 HS

**Date:** Mar. 31,2016

Communication System: DECT; Communication System Band: 1900; Duty Cycle: 4%; Conv.F=6.22  
Frequency: 1924.992 MHz; Medium parameters used:  $f = 1900$  MHz;  $\sigma = 1.41$  mho/m;  $\epsilon_r = 40.73$   $\rho = 1000$  kg/m<sup>3</sup> ;  
Phantom section: Right Section  
Ambient temperature (°C)20.7, Liquid temperature (°C):20.7

**SATIMO Configuration:**

Probe: SSE5; Calibrated: 12/09/2015; Serial No.: SN 22/12 EP159  
Sensor-Surface: 4mm (Mechanical Surface Detection)  
Phantom: SAM twin phantom  
Measurement SW: OpenSAR V4\_02\_01

**Configuration/1900 Mid-Tilt- Right /Area Scan:** Measurement grid: dx=8mm, dy=8mm  
**Configuration/1900 Mid-Tilt- Right t/Zoom Scan:** Measurement grid: dx=8mm,dy=8mm, dz=5mm;

<b>Area Scan</b>	sam_direct_droit2_surf8mm.txt
<b>ZoomScan</b>	5x5x7,dx=8mm dy=8mm dz=5mm,Complete
<b>Phantom</b>	Right head
<b>Device Position</b>	Tilt
<b>Band</b>	DECT
<b>Channels</b>	Middle
<b>Signal</b>	Crest factor: 25

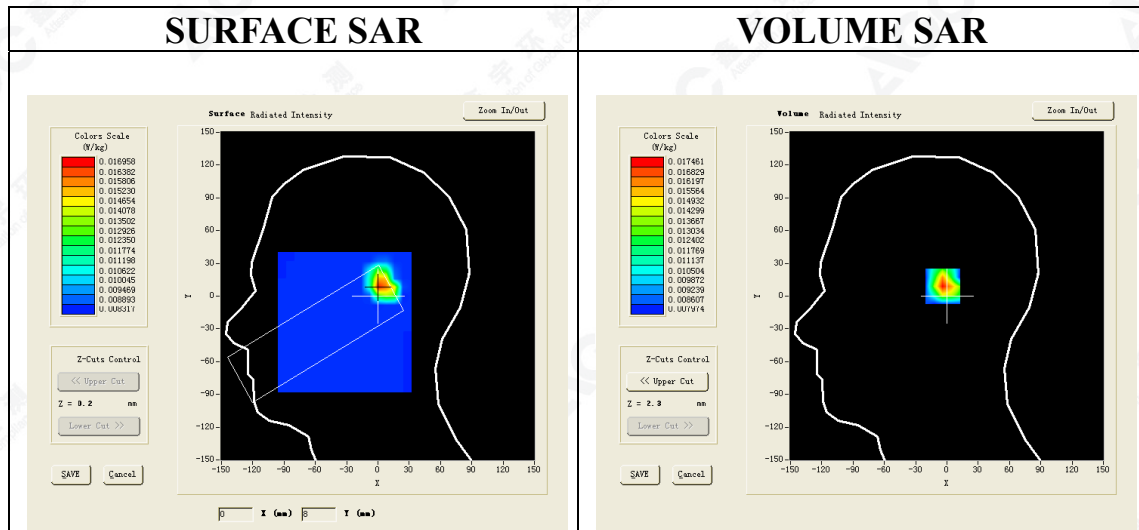

**Maximum location: X=2.00, Y=9.00**

<b>SAR 10g (W/Kg)</b>	0.011316
<b>SAR 1g (W/Kg)</b>	0.017386

The results shown in this test report refer only to the sample(s) tested unless otherwise stated and the sample(s) are retained for 30 days only. The document is issued by AGC, this document cannot be reproduced except in full with our prior written permission. The document is available on request and the brief information for its validation can be assessable and confirmed at <http://www.agc-cert.com>



Z (mm)	0.00	4.00	9.00	14.00	19.00	24.00	29.00
SAR (W/Kg)	0.0000	0.0175	0.0083	0.0084	0.0084	0.0084	0.0084

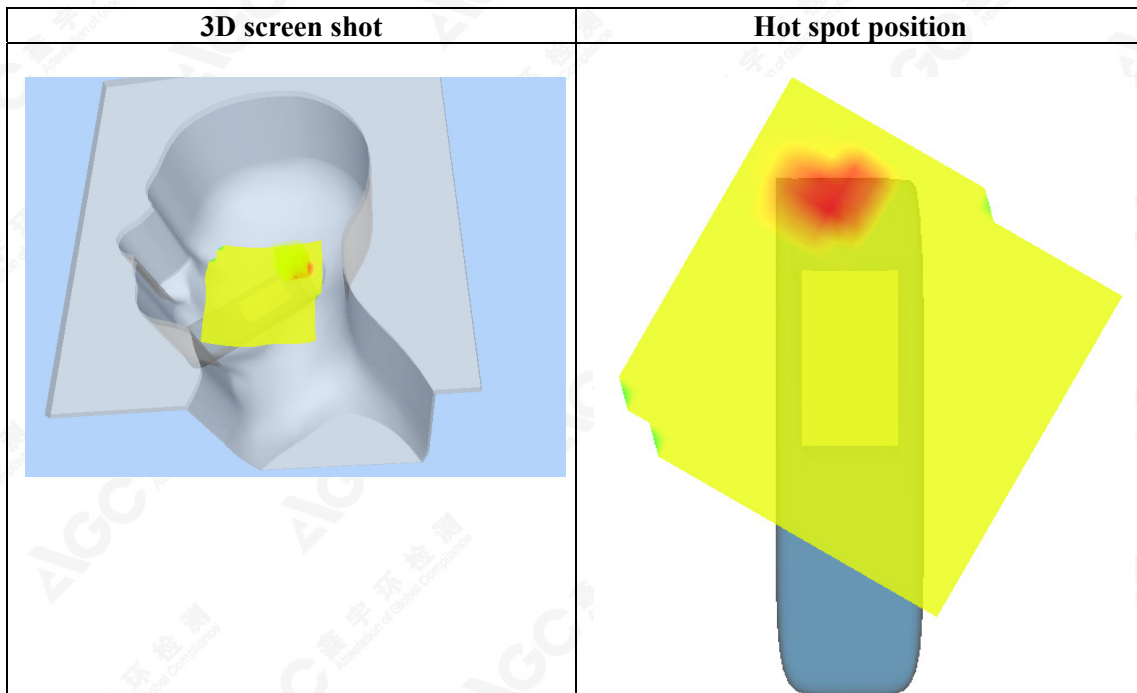
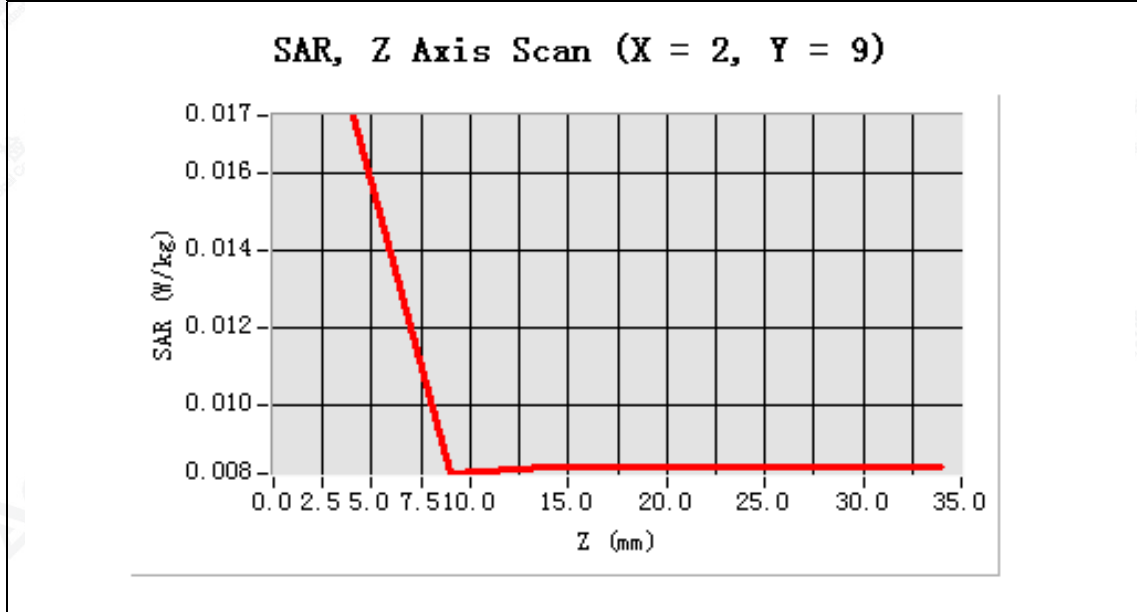

The results shown in this test report refer only to the sample(s) tested unless otherwise stated and the sample(s) are retained for 30 days only. The document is issued by AGC, this document cannot be reproduced except in full with our prior written permission. The document is available on request and the brief information for its validation can be assessable and confirmed at <http://www.agc-cert.com>



**Test Laboratory:** AGC Lab  
**DECT 1900 Mid-Body-Back**  
**DUT:** DECT cordless phone; **Type:** DS6722-3 HS

**Date:** Mar. 31,2016

Communication System: DECT; Communication System Band: 1900; Duty Cycle: 4%; Conv.F=6.43  
Frequency: 1924.992 MHz; Medium parameters used:  $f = 1900$  MHz;  $\sigma = 1.52$  mho/m;  $\epsilon_r = 52.75$ ;  $\rho = 1000$  kg/m<sup>3</sup> ;  
Phantom section: Flat Section  
Ambient temperature (°C):20.7, Liquid temperature (°C):20.7

**SATIMO Configuration:**

Probe: SSE5; Calibrated: 12/09/2015; Serial No.: SN 22/12 EP159  
Sensor-Surface: 4mm (Mechanical Surface Detection)  
Phantom: SAM twin phantom  
Measurement SW: OpenSAR V4\_02\_01

**Configuration1900 Mid-Body- Back/Area Scan:** Measurement grid: dx=8mm, dy=8mm  
**Configuration1900 Mid-Body- Back /Zoom Scan:** Measurement grid: dx=8mm,dy=8mm, dz=5mm;

<b>Area Scan</b>	sam_direct droit2_surf8mm.txt
<b>ZoomScan</b>	5x5x7,dx=8mm dy=8mm dz=5mm,Complete
<b>Phantom</b>	Validation plane
<b>Device Position</b>	Body Back
<b>Band</b>	DECT
<b>Channels</b>	Middle
<b>Signal</b>	Crest factor: 25

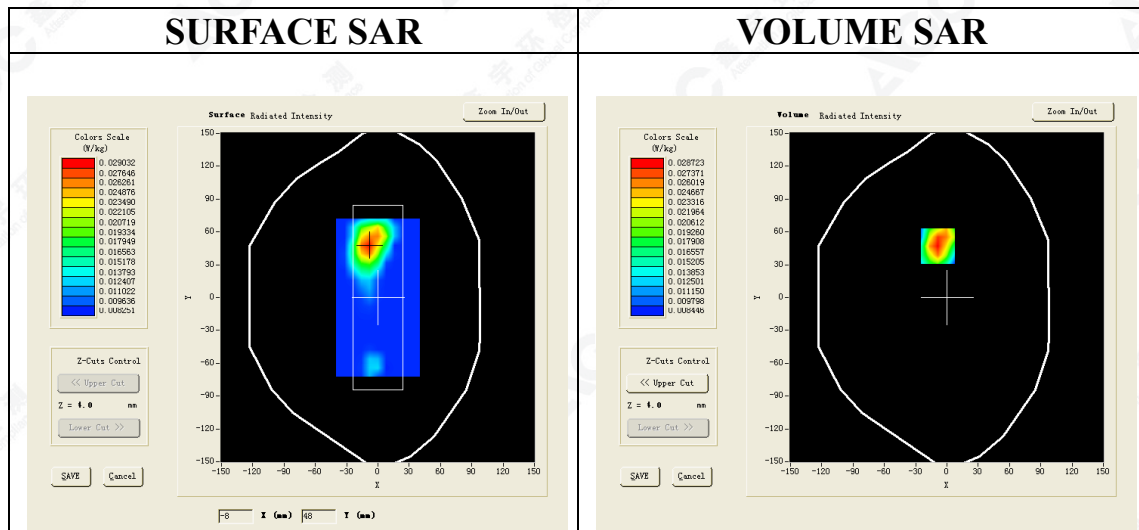

**Maximum location: X=-9.00, Y=47.00**

<b>SAR 10g (W/Kg)</b>	0.016074
<b>SAR 1g (W/Kg)</b>	0.028502

The results shown in this test report refer only to the sample(s) tested unless otherwise stated and the sample(s) are retained for 30 days only. The document is issued by AGC, this document cannot be reproduced except in full with our prior written permission. The document is available on request and the brief information for its validation can be assessable and confirmed at <http://www.agc-cert.com>



Z (mm)	0.00	4.00	9.00	14.00	19.00	24.00	29.00
SAR (W/Kg)	0.0000	0.0287	0.0128	0.0084	0.0084	0.0084	0.0084

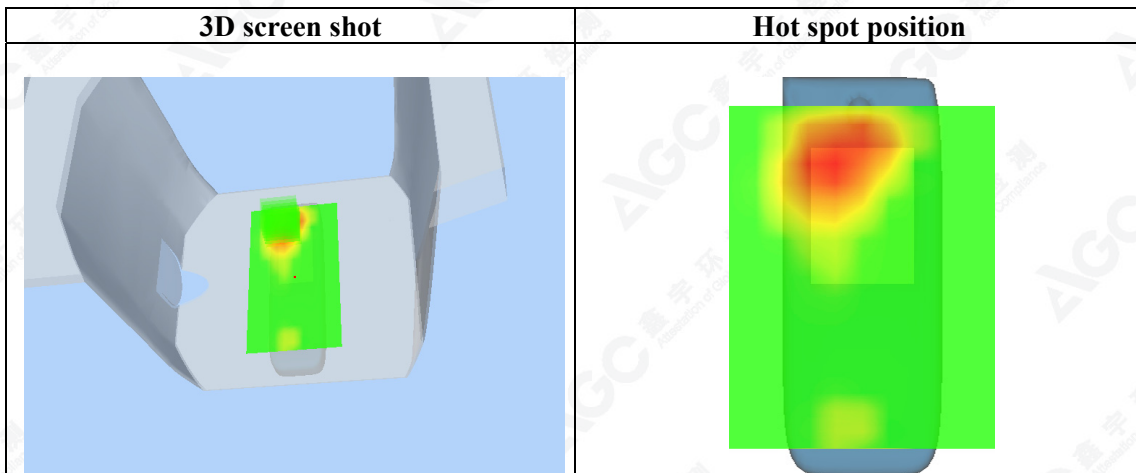
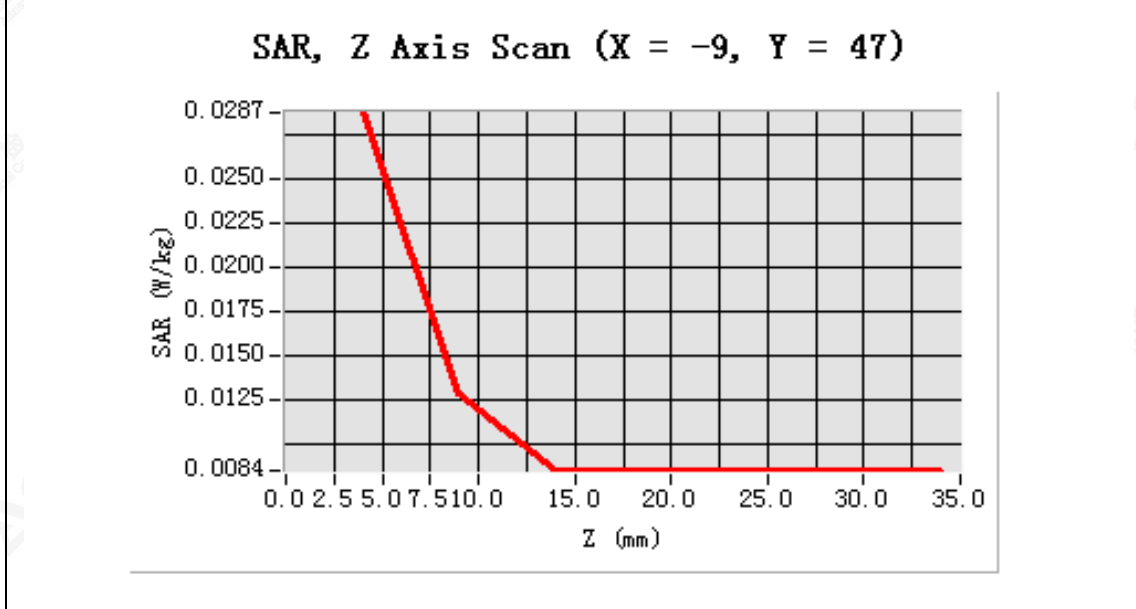

The results shown in this test report refer only to the sample(s) tested unless otherwise stated and the sample(s) are retained for 30 days only. The document is issued by AGC, this document cannot be reproduced except in full with our prior written permission. The document is available on request and the brief information for its validation can be assessable and confirmed at <http://www.agc-cert.com>



**Test Laboratory:** AGC Lab  
**DECT 1900 Mid-Body- Front**  
**DUT:** DECT cordless phone; **Type:** DS6722-3 HS

**Date:** Mar. 31,2016

Communication System: DECT; Communication System Band: 1900; Duty Cycle: 4%; Conv.F=6.43  
Frequency: 1924.992 MHz; Medium parameters used:  $f = 1900$  MHz;  $\sigma = 1.52$  mho/m;  $\epsilon_r = 52.75$ ;  $\rho = 1000$  kg/m<sup>3</sup> ;  
Phantom section: Flat Section  
Ambient temperature (°C):20.7, Liquid temperature (°C):20.7

**SATIMO Configuration:**

Probe: SSE5; Calibrated: 12/09/2015; Serial No.: SN 22/12 EP159  
Sensor-Surface: 4mm (Mechanical Surface Detection)  
Phantom: SAM twin phantom  
Measurement SW: OpenSAR V4\_02\_01

**Configuration1900 Mid-Body- Front /Area Scan:** Measurement grid: dx=8mm, dy=8mm  
**Configuration1900 Mid-Body- Front /Zoom Scan:** Measurement grid: dx=8mm,dy=8mm, dz=5mm;

<b>Area Scan</b>	sam_direct_droit2_surf8mm.txt
<b>ZoomScan</b>	5x5x7,dx=8mm dy=8mm dz=5mm,Complete
<b>Phantom</b>	Validation plane
<b>Device Position</b>	Body Front
<b>Band</b>	DECT
<b>Channels</b>	Middle
<b>Signal</b>	Crest factor: 25

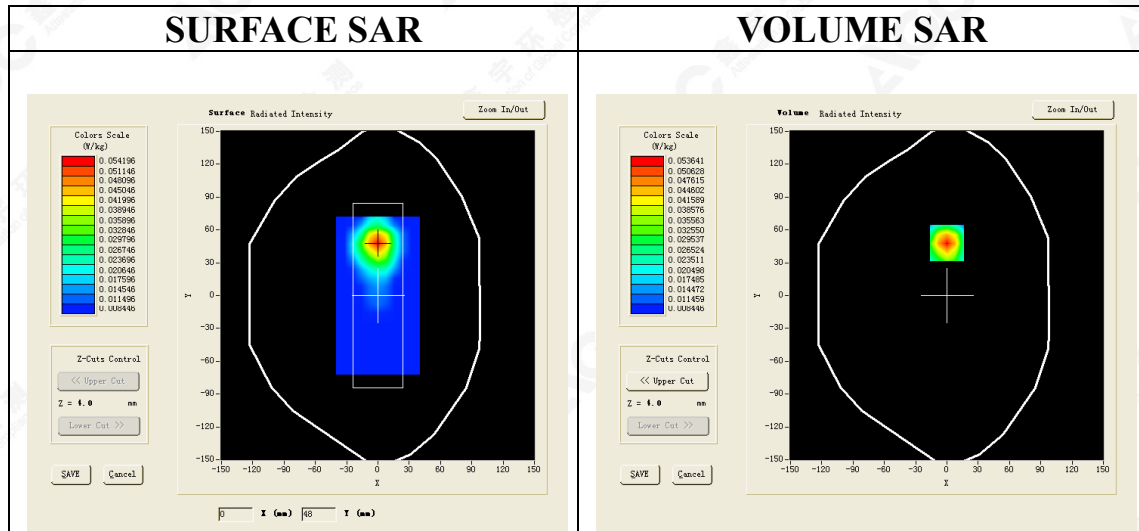

**Maximum location: X=0.00, Y=48.00**

<b>SAR 10g (W/Kg)</b>	0.026902
<b>SAR 1g (W/Kg)</b>	0.049865

The results shown in this test report refer only to the sample(s) tested unless otherwise stated and the sample(s) are retained for 30 days only. The document is issued by AGC, this document cannot be reproduced except in full with our prior written permission. The document is available on request and the brief information for its validation can be assessable and confirmed at <http://www.agc-cert.com>



Z (mm)	0.00	4.00	9.00	14.00	19.00	24.00	29.00
SAR (W/Kg)	0.0000	0.0536	0.0285	0.0174	0.0089	0.0084	0.0084

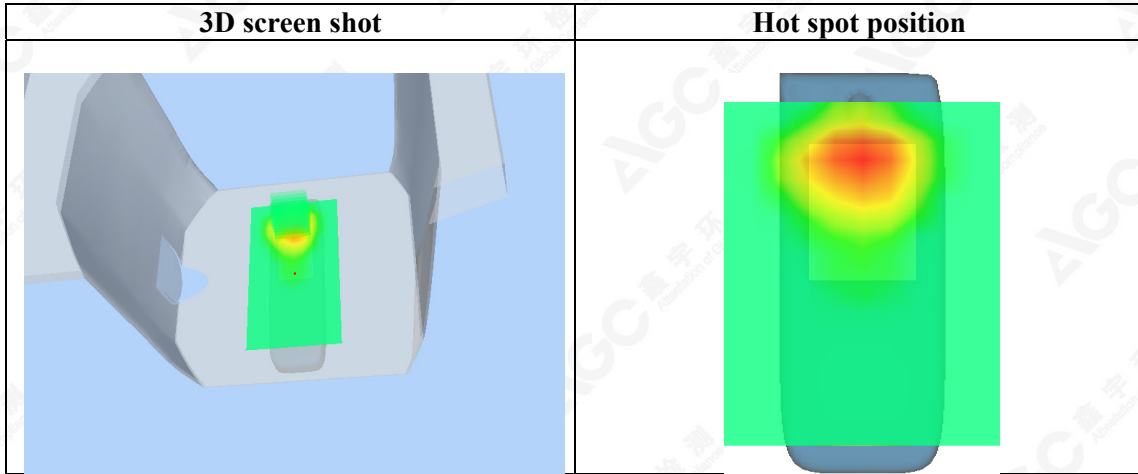
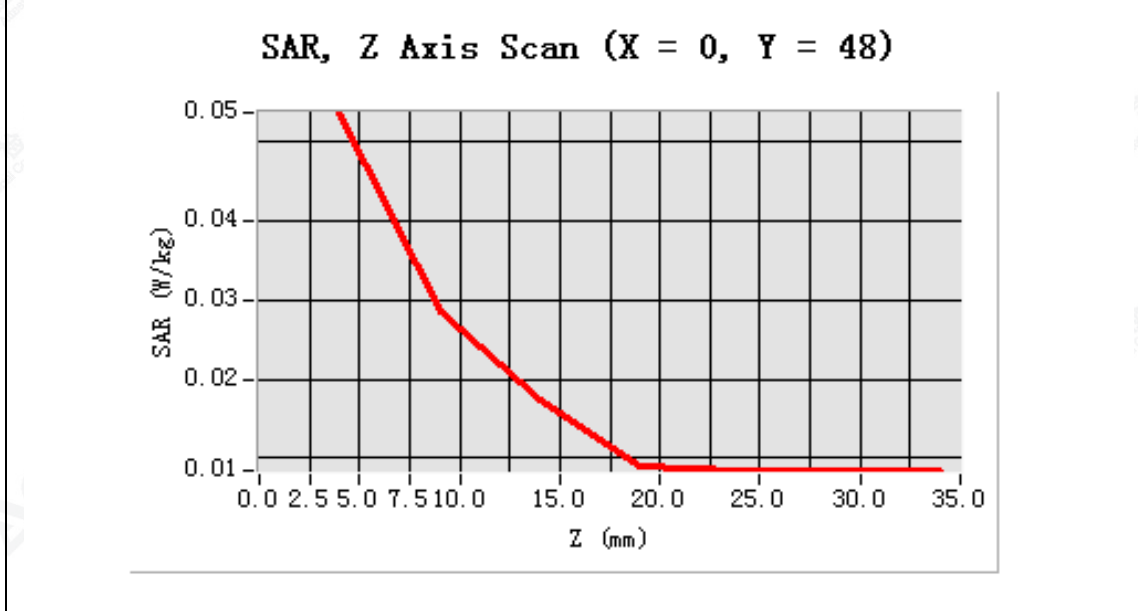

The results shown in this test report refer only to the sample(s) tested unless otherwise stated and the sample(s) are retained for 30 days only. The document is issued by AGC, this document cannot be reproduced except in full with our prior written permission. The document is available on request and the brief information for its validation can be assessable and confirmed at <http://www.agc-cert.com>



**Battery brand name- Corun**  
**Test Laboratory: AGC Lab**  
**DECT 1900 Mid-Touch- Left**  
**DUT: DECT cordless phone; Type: DS6722-3 HS**

**Date: Mar. 31,2016**

Communication System: DECT; Communication System Band: 1900; Duty Cycle: 4%; Conv.F=6.22  
Frequency: 1924.992 MHz; Medium parameters used:  $f = 1900$  MHz;  $\sigma = 1.41$  mho/m;  $\epsilon_r = 40.73$   $\rho = 1000$  kg/m<sup>3</sup> ;  
Phantom section: Left Section  
Ambient temperature (°C)20.7, Liquid temperature (°C):20.7

**SATIMO Configuration:**

Probe: SSE5; Calibrated: 12/09/2015; Serial No.: SN 22/12 EP159  
Sensor-Surface: 4mm (Mechanical Surface Detection)  
Phantom: SAM twin phantom  
Measurement SW: OpenSAR V4\_02\_01

**Configuration/1900 Mid-Touch- Left /Area Scan:** Measurement grid: dx=8mm, dy=8mm  
**Configuration/1900 Mid-Touch- Left t/Zoom Scan:** Measurement grid: dx=8mm,dy=8mm, dz=5mm;

<b>Area Scan</b>	sam_direct_droit2_surf8mm.txt
<b>ZoomScan</b>	5x5x7,dx=8mm dy=8mm dz=5mm,Complete
<b>Phantom</b>	Left head
<b>Device Position</b>	Cheek
<b>Band</b>	DECT
<b>Channels</b>	Middle
<b>Signal</b>	Crest factor: 25

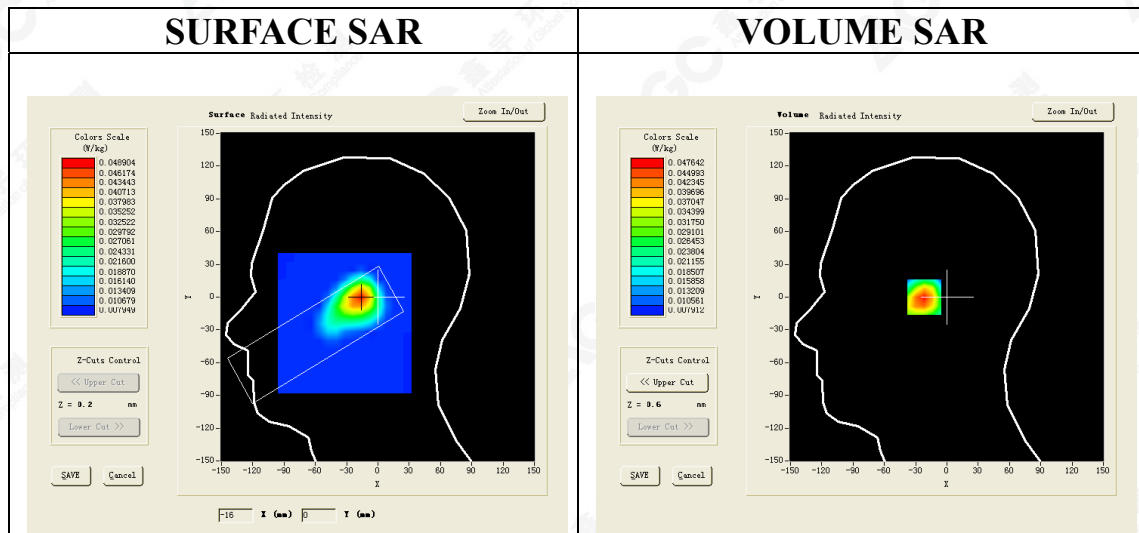

**Maximum location: X=-17.00, Y=0.00**

<b>SAR 10g (W/Kg)</b>	0.025983
<b>SAR 1g (W/Kg)</b>	0.044274

The results shown in this test report refer only to the sample(s) tested unless otherwise stated and the sample(s) are retained for 30 days only. The document is issued by AGC, this document cannot be reproduced except in full with our prior written permission. The document is available on request and the brief information for its validation can be assessable and confirmed at <http://www.agc-cert.com>



Z (mm)	0.00	4.00	9.00	14.00	19.00	24.00	29.00
SAR (W/Kg)	0.0000	0.0476	0.0291	0.0184	0.0103	0.0084	0.0084

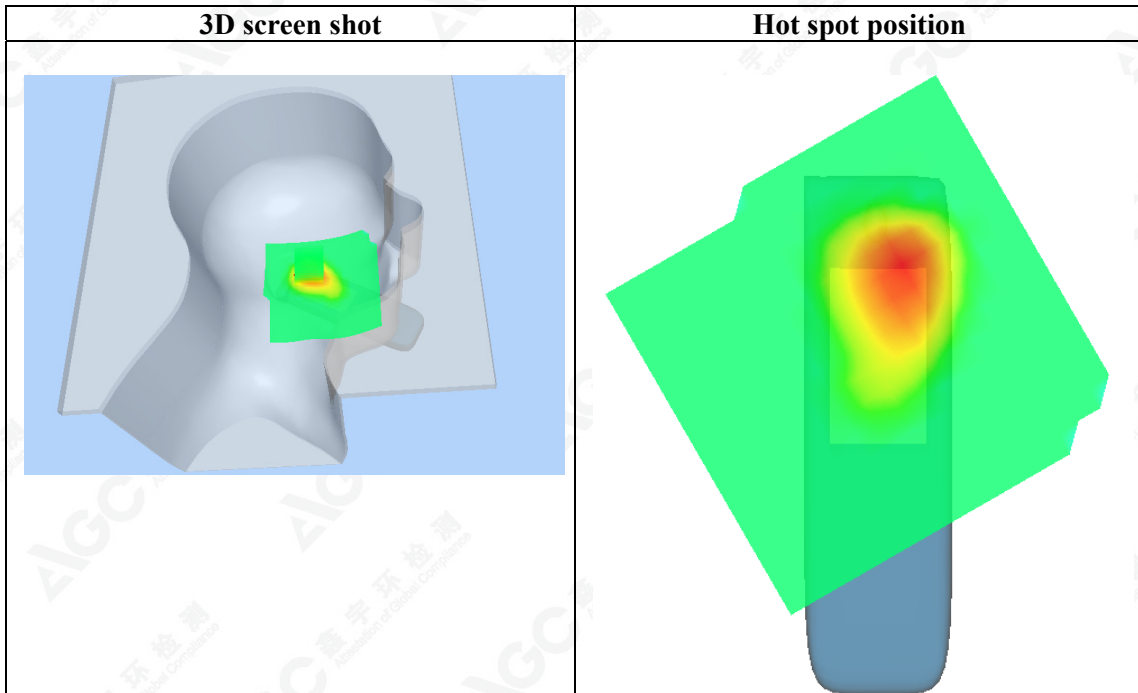
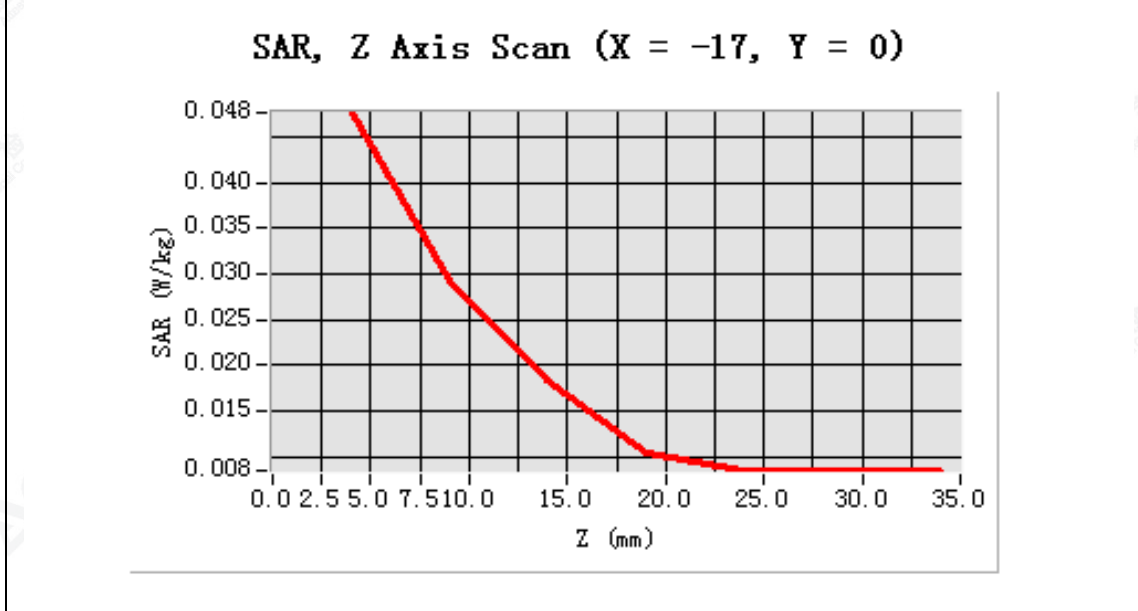

The results shown in this test report refer only to the sample(s) tested unless otherwise stated and the sample(s) are retained for 30 days only. The document is issued by AGC, this document cannot be reproduced except in full with our prior written permission. The document is available on request and the brief information for its validation can be assessable and confirmed at <http://www.agc-cert.com>



**Test Laboratory:** AGC Lab  
**DECT 1900 Mid-Tilt- Left**  
**DUT:** DECT cordless phone; **Type:** DS6722-3 HS

**Date:** Mar. 31,2016

Communication System: DECT; Communication System Band: 1900; Duty Cycle: 4%; Conv.F=6.22  
Frequency: 1924.992 MHz; Medium parameters used:  $f = 1900$  MHz;  $\sigma = 1.41$  mho/m;  $\epsilon_r = 40.73$   $\rho = 1000$  kg/m<sup>3</sup> ;  
Phantom section: Left Section  
Ambient temperature (°C)20.7, Liquid temperature (°C):20.7

**SATIMO Configuration:**

Probe: SSE5; Calibrated: 12/09/2015; Serial No.: SN 22/12 EP159  
Sensor-Surface: 4mm (Mechanical Surface Detection)  
Phantom: SAM twin phantom  
Measurement SW: OpenSAR V4\_02\_01

**Configuration/1900 Mid-Tilt- Left /Area Scan:** Measurement grid: dx=8mm, dy=8mm  
**Configuration/1900 Mid-Tilt- Left t/Zoom Scan:** Measurement grid: dx=8mm,dy=8mm, dz=5mm;

<b>Area Scan</b>	sam_direct_droit2_surf8mm.txt
<b>ZoomScan</b>	5x5x7,dx=8mm dy=8mm dz=5mm,Complete
<b>Phantom</b>	Left head
<b>Device Position</b>	Tilt
<b>Band</b>	DECT
<b>Channels</b>	Middle
<b>Signal</b>	Crest factor: 25

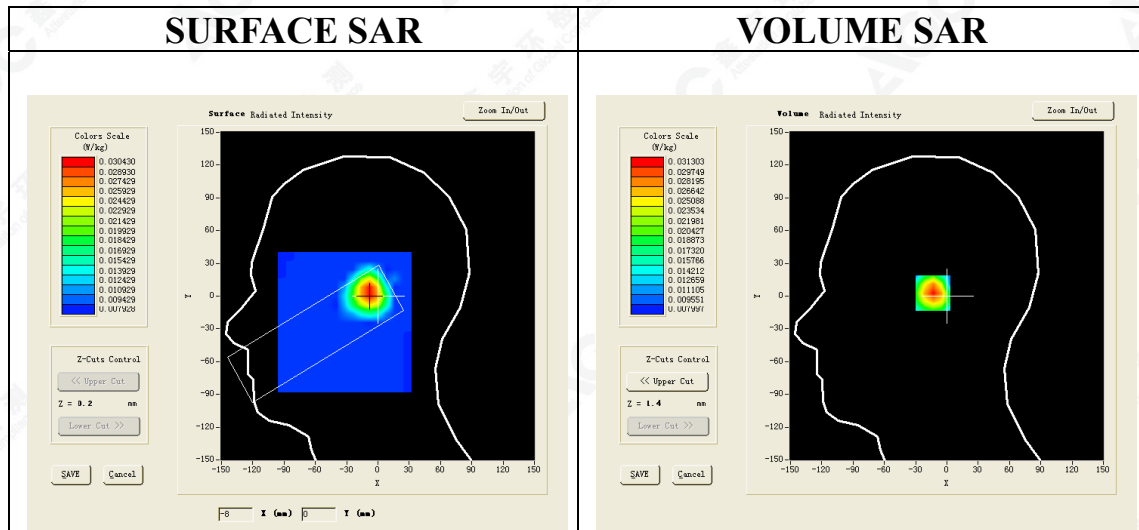

**Maximum location: X=-8.00, Y=3.00**

<b>SAR 10g (W/Kg)</b>	0.017341
<b>SAR 1g (W/Kg)</b>	0.028875

The results shown in this test report refer only to the sample(s) tested unless otherwise stated and the sample(s) are retained for 30 days only. The document is issued by AGC, this document cannot be reproduced except in full with our prior written permission. The document is available on request and the brief information for its validation can be assessable and confirmed at <http://www.agc-cert.com>



Z (mm)	0.00	4.00	9.00	14.00	19.00	24.00	29.00
SAR (W/Kg)	0.0000	0.0313	0.0201	0.0112	0.0084	0.0084	0.0084

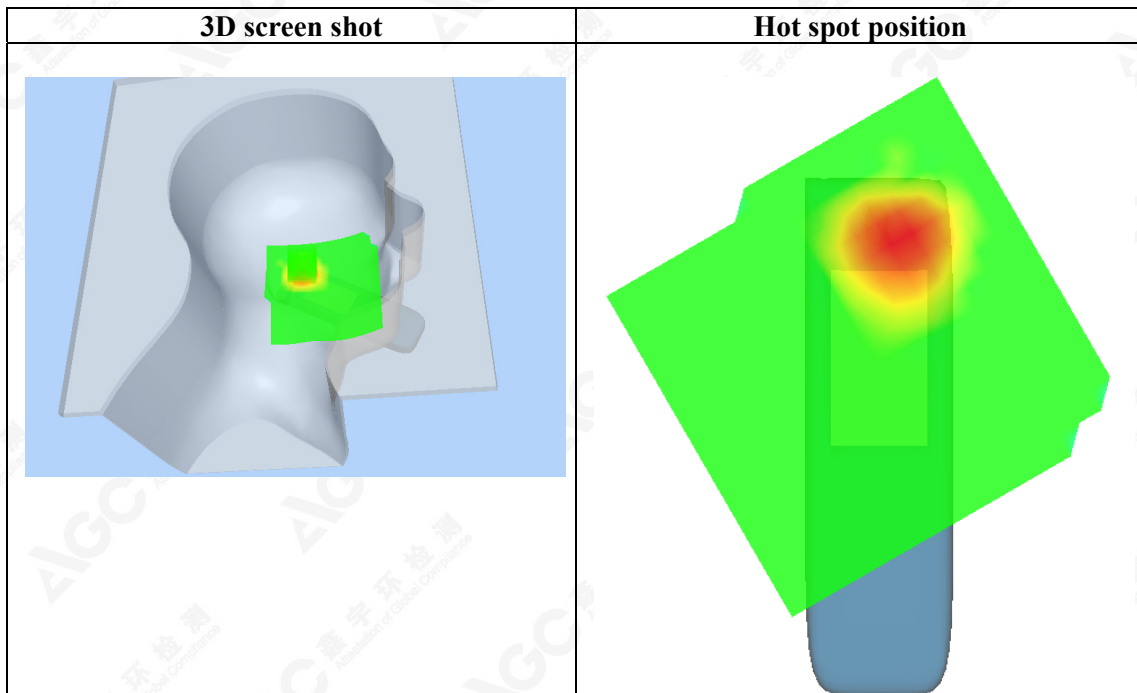
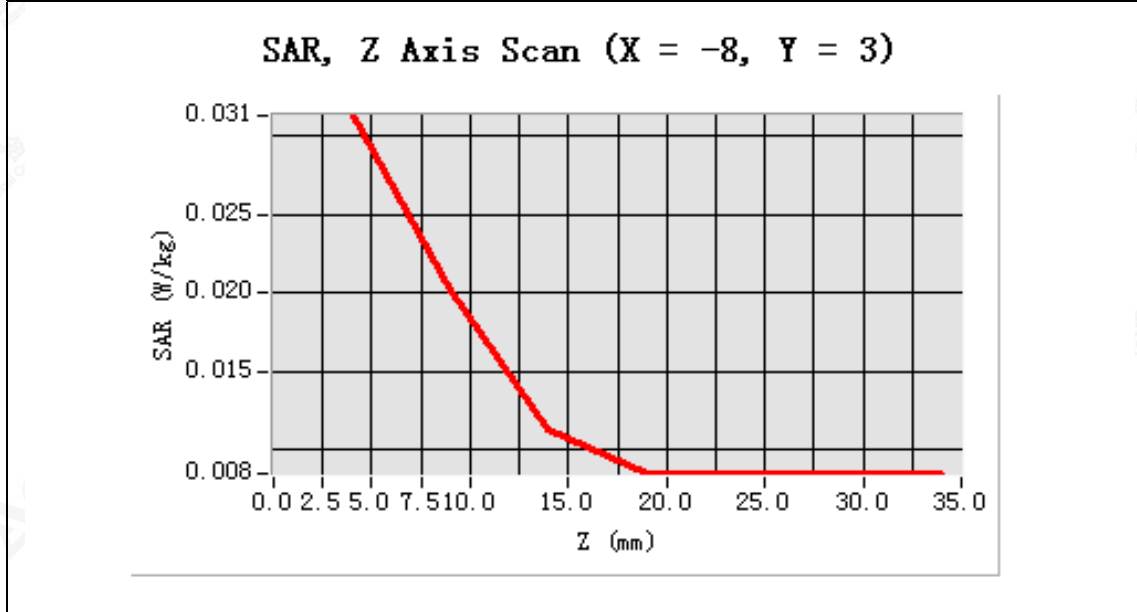

The results shown in this test report refer only to the sample(s) tested unless otherwise stated and the sample(s) are retained for 30 days only. The document is issued by AGC, this document cannot be reproduced except in full with our prior written permission. The document is available on request and the brief information for its validation can be assessable and confirmed at <http://www.agc-cert.com>



**Test Laboratory:** AGC Lab  
**DECT 1900 Mid-Touch- Right**  
**DUT:** DECT cordless phone; **Type:** DS6722-3 HS

**Date:** Mar. 31,2016

Communication System: DECT; Communication System Band: 1900; Duty Cycle: 4%; Conv.F=6.22  
Frequency: 1924.992 MHz; Medium parameters used: f = 1900 MHz;  $\sigma=1.41$  mho/m;  $\epsilon_r=40.73$   $\rho=1000$  kg/m<sup>3</sup> ;  
Phantom section: Right Section  
Ambient temperature (°C)20.7, Liquid temperature (°C):20.7

**SATIMO Configuration:**

Probe: SSE5; Calibrated: 12/09/2015; Serial No.: SN 22/12 EP159  
Sensor-Surface: 4mm (Mechanical Surface Detection)  
Phantom: SAM twin phantom  
Measurement SW: OpenSAR V4\_02\_01

**Configuration/1900 Mid-Touch- Right /Area Scan:** Measurement grid: dx=8mm, dy=8mm  
**Configuration/1900 Mid-Touch- Right t/Zoom Scan:** Measurement grid: dx=8mm,dy=8mm, dz=5mm;

<b>Area Scan</b>	sam_direct_droit2_surf8mm.txt
<b>ZoomScan</b>	5x5x7,dx=8mm dy=8mm dz=5mm,Complete
<b>Phantom</b>	Right head
<b>Device Position</b>	Cheek
<b>Band</b>	DECT
<b>Channels</b>	Middle
<b>Signal</b>	Crest factor: 25

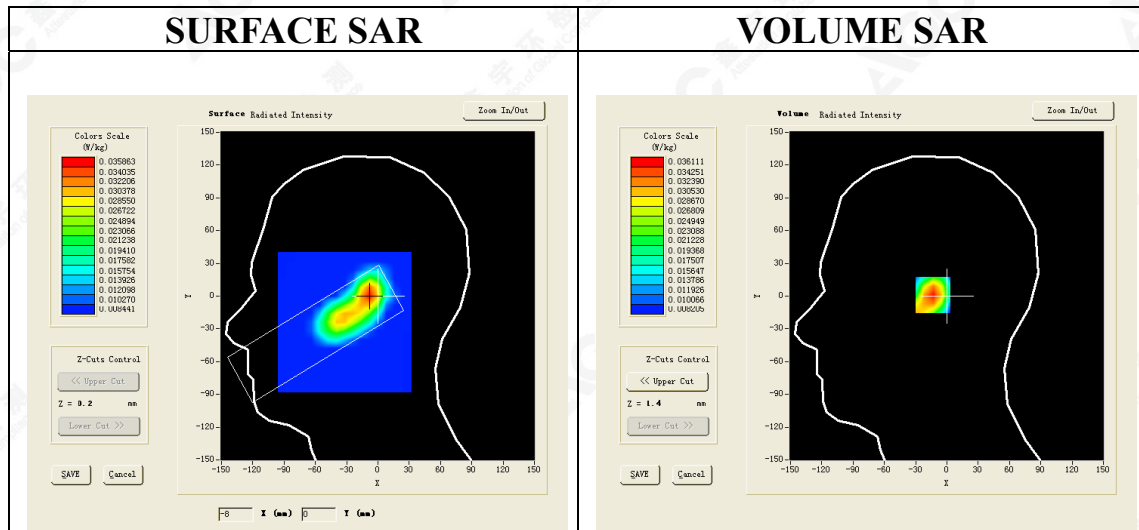

**Maximum location: X=-8.00, Y=1.00**

<b>SAR 10g (W/Kg)</b>	0.019831
<b>SAR 1g (W/Kg)</b>	0.035571

The results shown in this test report refer only to the sample(s) tested unless otherwise stated and the sample(s) are retained for 30 days only. The document is issued by AGC, this document cannot be reproduced except in full with our prior written permission. The document is available on request and the brief information for its validation can be assessable and confirmed at <http://www.agc-cert.com>



Z (mm)	0.00	4.00	9.00	14.00	19.00	24.00	29.00
SAR (W/Kg)	0.0000	0.0361	0.0185	0.0089	0.0084	0.0084	0.0084

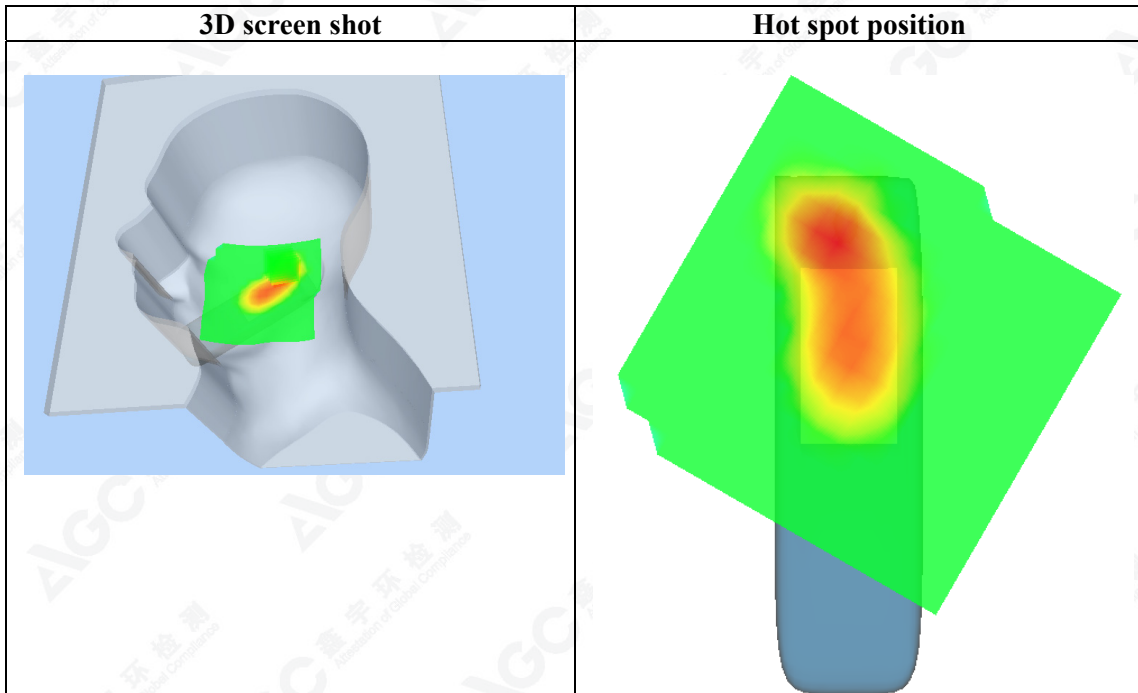
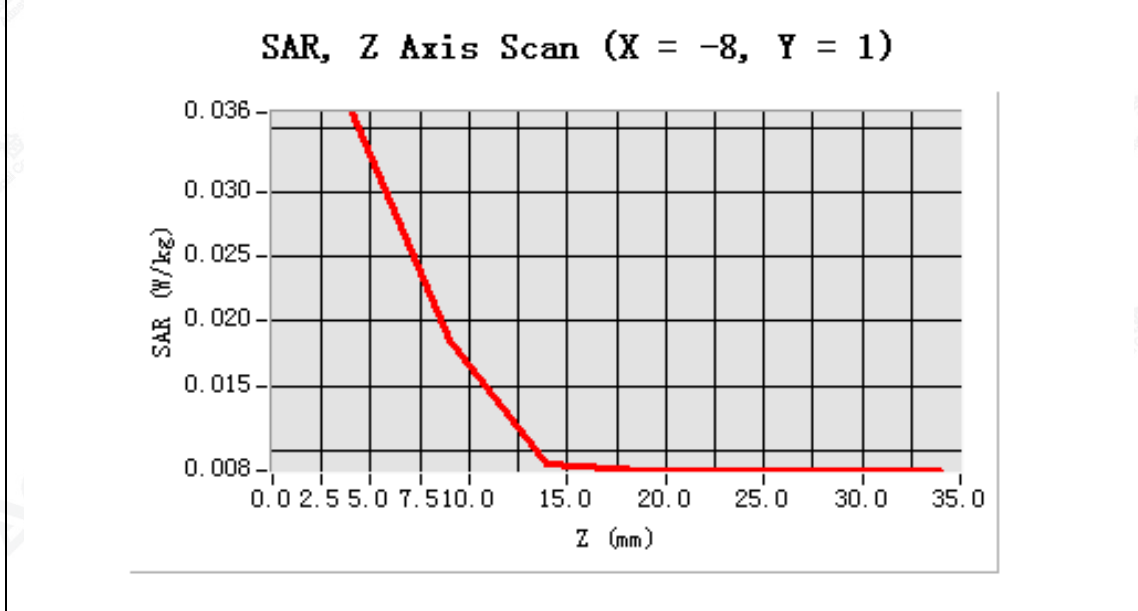

The results shown in this test report refer only to the sample(s) tested unless otherwise stated and the sample(s) are retained for 30 days only. The document is issued by AGC, this document cannot be reproduced except in full with our prior written permission. The document is available on request and the brief information for its validation can be assessable and confirmed at <http://www.agc-cert.com>



**Test Laboratory:** AGC Lab  
**DECT 1900 Mid-Tilt- Right**  
**DUT:** DECT cordless phone; **Type:** DS6722-3 HS

**Date:** Mar. 31,2016

Communication System: DECT; Communication System Band: 1900; Duty Cycle: 4%; Conv.F=6.22  
Frequency: 1924.992 MHz; Medium parameters used:  $f = 1900$  MHz;  $\sigma = 1.41$  mho/m;  $\epsilon_r = 40.73$   $\rho = 1000$  kg/m<sup>3</sup> ;  
Phantom section: Right Section  
Ambient temperature (°C)20.7, Liquid temperature (°C):20.7

**SATIMO Configuration:**

Probe: SSE5; Calibrated: 12/09/2015; Serial No.: SN 22/12 EP159  
Sensor-Surface: 4mm (Mechanical Surface Detection)  
Phantom: SAM twin phantom  
Measurement SW: OpenSAR V4\_02\_01

**Configuration/1900 Mid-Tilt- Right /Area Scan:** Measurement grid: dx=8mm, dy=8mm  
**Configuration/1900 Mid-Tilt- Right t/Zoom Scan:** Measurement grid: dx=8mm,dy=8mm, dz=5mm;

<b>Area Scan</b>	sam_direct_droit2_surf8mm.txt
<b>ZoomScan</b>	5x5x7,dx=8mm dy=8mm dz=5mm,Complete
<b>Phantom</b>	Right head
<b>Device Position</b>	Tilt
<b>Band</b>	DECT
<b>Channels</b>	Middle
<b>Signal</b>	Crest factor: 25

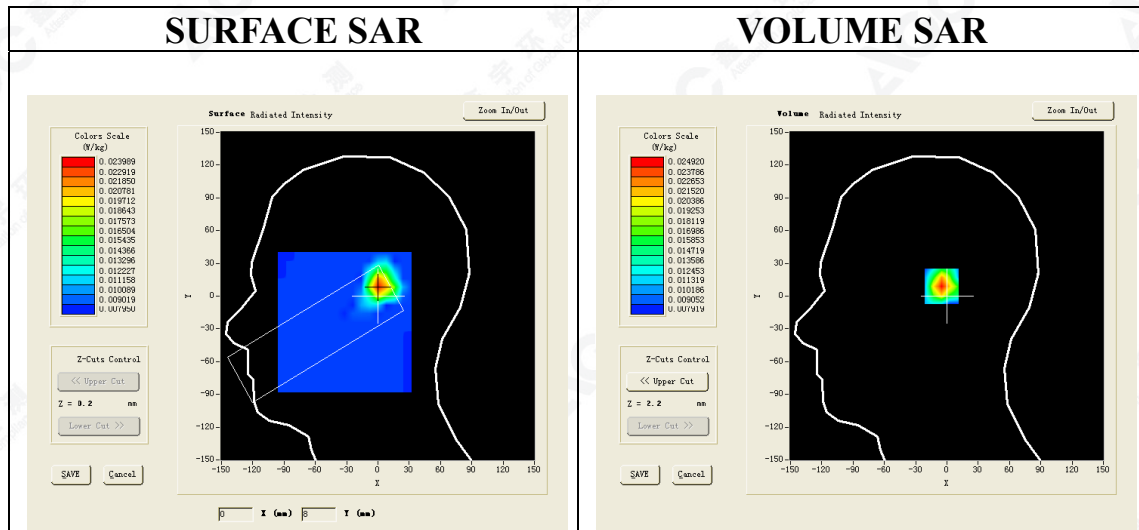

**Maximum location: X=1.00, Y=9.00**

<b>SAR 10g (W/Kg)</b>	0.013924
<b>SAR 1g (W/Kg)</b>	0.024640

The results shown in this test report refer only to the sample(s) tested unless otherwise stated and the sample(s) are retained for 30 days only. The document is issued by AGC, this document cannot be reproduced except in full with our prior written permission. The document is available on request and the brief information for its validation can be assessable and confirmed at <http://www.agc-cert.com>



Z (mm)	0.00	4.00	9.00	14.00	19.00	24.00	29.00
SAR (W/Kg)	0.0000	0.0249	0.0094	0.0084	0.0084	0.0084	0.0084

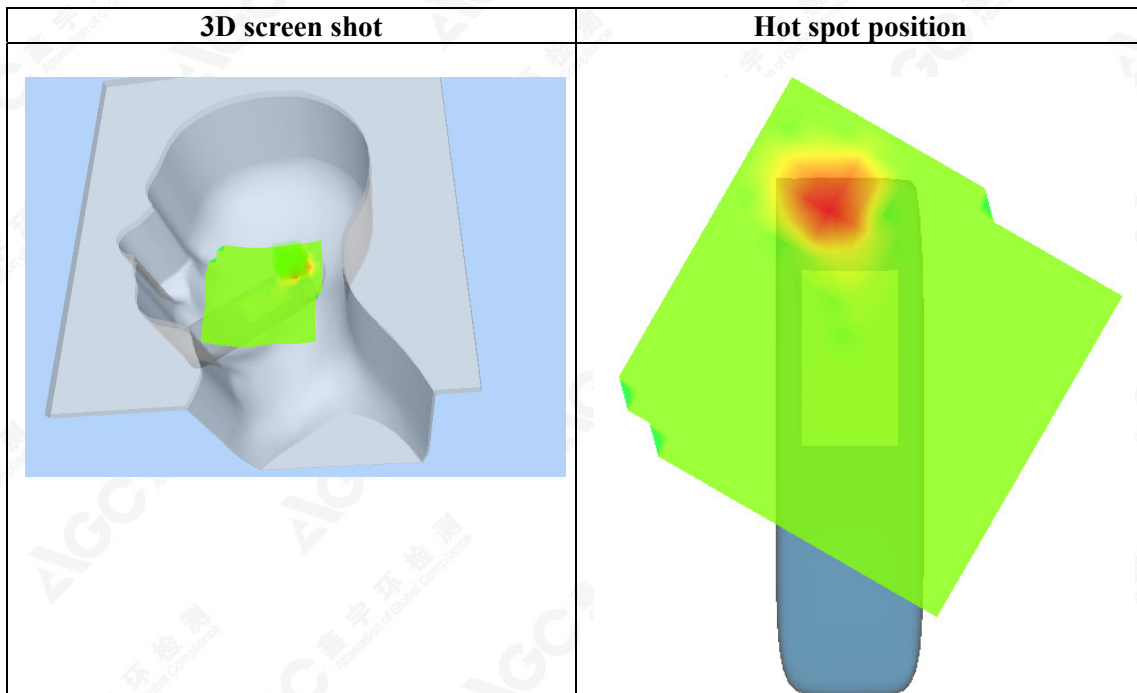
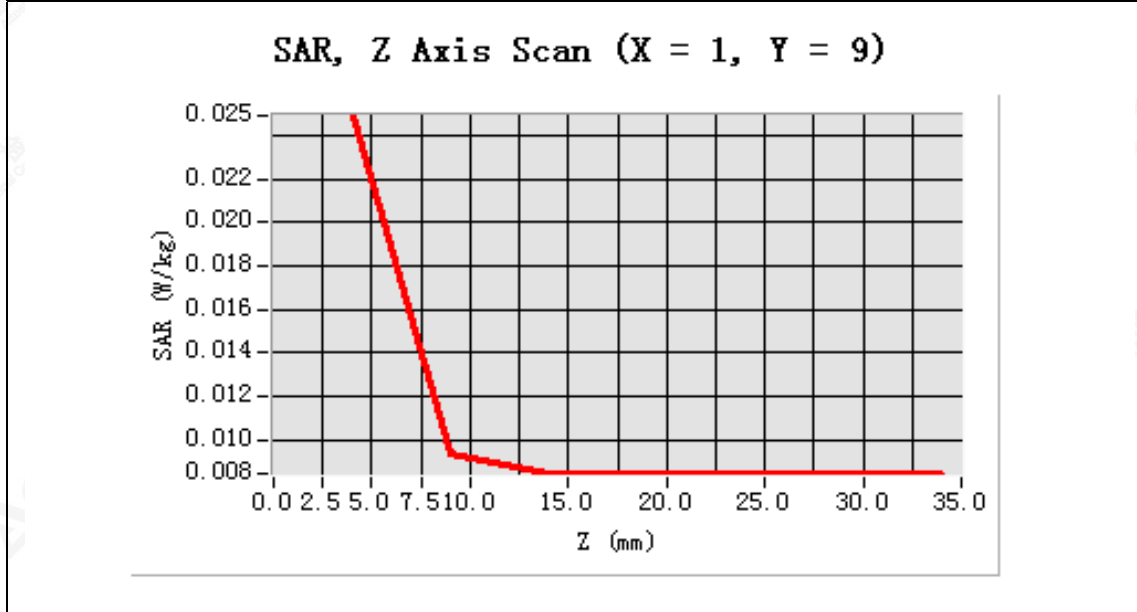

The results shown in this test report refer only to the sample(s) tested unless otherwise stated and the sample(s) are retained for 30 days only. The document is issued by AGC, this document cannot be reproduced except in full with our prior written permission. The document is available on request and the brief information for its validation can be assessable and confirmed at <http://www.agc-cert.com>



**Test Laboratory:** AGC Lab  
**DECT 1900 Mid-Body-Back**  
**DUT:** DECT cordless phone; **Type:** DS6722-3 HS

**Date:** Mar. 31,2016

Communication System: DECT; Communication System Band: 1900; Duty Cycle: 4%; Conv.F=6.43  
Frequency: 1924.992 MHz; Medium parameters used:  $f = 1900$  MHz;  $\sigma = 1.52$  mho/m;  $\epsilon_r = 52.75$ ;  $\rho = 1000$  kg/m<sup>3</sup> ;  
Phantom section: Flat Section  
Ambient temperature (°C):20.7, Liquid temperature (°C):20.7

**SATIMO Configuration:**

Probe: SSE5; Calibrated: 12/09/2015; Serial No.: SN 22/12 EP159  
Sensor-Surface: 4mm (Mechanical Surface Detection)  
Phantom: SAM twin phantom  
Measurement SW: OpenSAR V4\_02\_01

**Configuration1900 Mid-Body- Back/Area Scan:** Measurement grid: dx=8mm, dy=8mm  
**Configuration1900 Mid-Body- Back /Zoom Scan:** Measurement grid: dx=8mm,dy=8mm, dz=5mm;

<b>Area Scan</b>	sam_direct_droit2_surf8mm.txt
<b>ZoomScan</b>	5x5x7,dx=8mm dy=8mm dz=5mm,Complete
<b>Phantom</b>	Validation plane
<b>Device Position</b>	Body Back
<b>Band</b>	DECT
<b>Channels</b>	Middle
<b>Signal</b>	Crest factor: 25

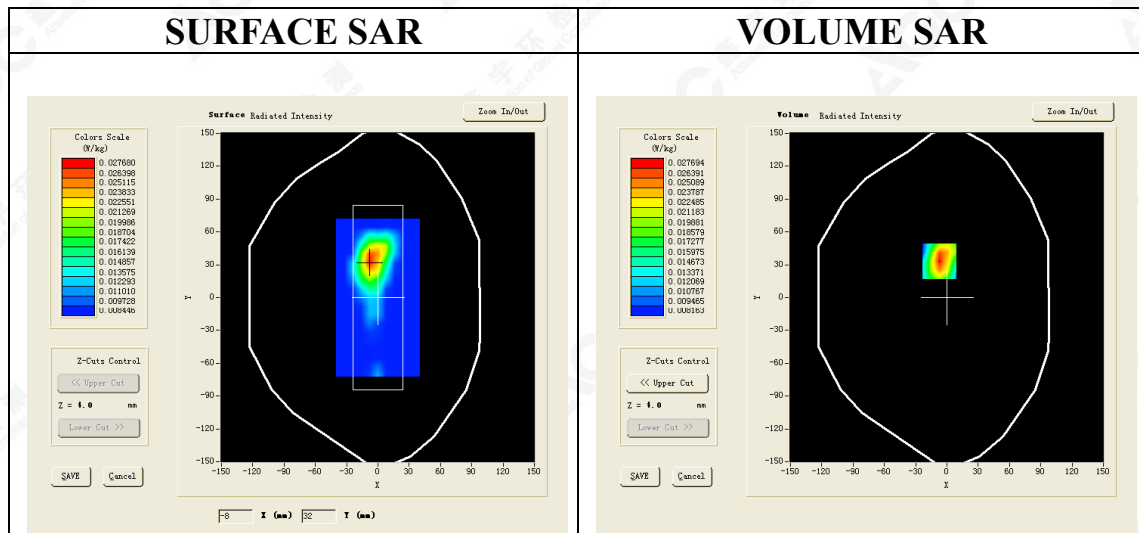

**Maximum location: X=-7.00, Y=33.00**

<b>SAR 10g (W/Kg)</b>	0.015767
<b>SAR 1g (W/Kg)</b>	0.027659

The results shown in this test report refer only to the sample(s) tested unless otherwise stated and the sample(s) are retained for 30 days only. The document is issued by AGC, this document cannot be reproduced except in full with our prior written permission. The document is available on request and the brief information for its validation can be assessable and confirmed at <http://www.agc-cert.com>



Z (mm)	0.00	4.00	9.00	14.00	19.00	24.00	29.00
SAR (W/Kg)	0.0000	0.0277	0.0126	0.0084	0.0084	0.0084	0.0084

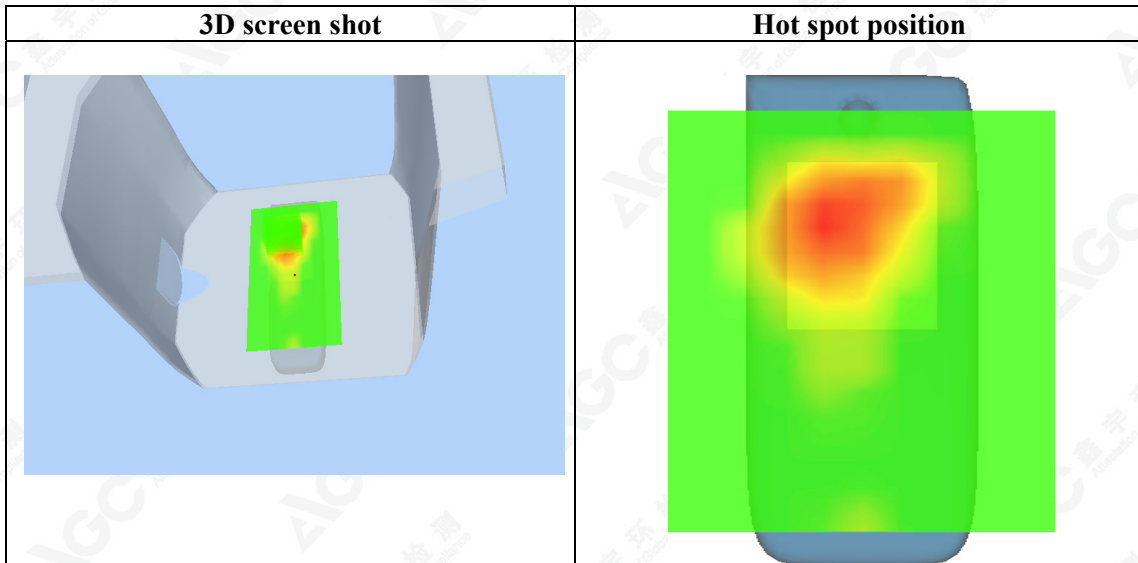
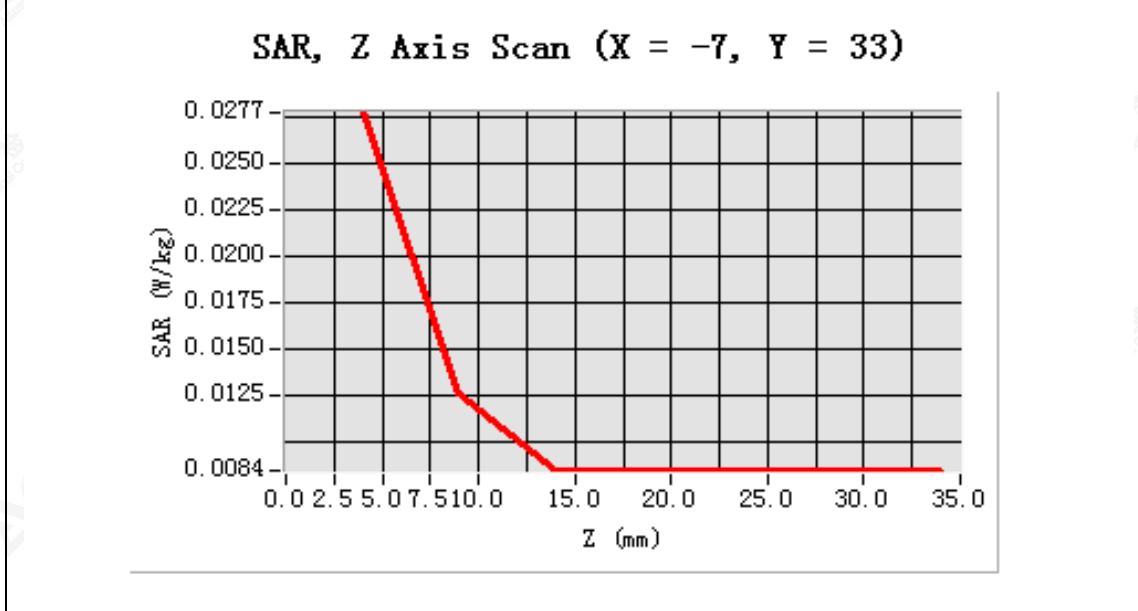

The results shown in this test report refer only to the sample(s) tested unless otherwise stated and the sample(s) are retained for 30 days only. The document is issued by AGC, this document cannot be reproduced except in full with our prior written permission. The document is available on request and the brief information for its validation can be assessable and confirmed at <http://www.agc-cert.com>



**Test Laboratory:** AGC Lab  
**DECT 1900 Mid-Body- Front**  
**DUT:** DECT cordless phone; **Type:** DS6722-3 HS

**Date:** Mar. 31,2016

Communication System: DECT; Communication System Band: 1900; Duty Cycle: 4%; Conv.F=6.43  
Frequency: 1924.992 MHz; Medium parameters used:  $f = 1900$  MHz;  $\sigma = 1.52$  mho/m;  $\epsilon_r = 52.75$ ;  $\rho = 1000$  kg/m<sup>3</sup> ;  
Phantom section: Flat Section  
Ambient temperature (°C):20.7, Liquid temperature (°C):20.7

**SATIMO Configuration:**

Probe: SSE5; Calibrated: 12/09/2015; Serial No.: SN 22/12 EP159  
Sensor-Surface: 4mm (Mechanical Surface Detection)  
Phantom: SAM twin phantom  
Measurement SW: OpenSAR V4\_02\_01

**Configuration1900 Mid-Body- Front /Area Scan:** Measurement grid: dx=8mm, dy=8mm  
**Configuration1900 Mid-Body- Front /Zoom Scan:** Measurement grid: dx=8mm,dy=8mm, dz=5mm;

<b>Area Scan</b>	sam_direct_droit2_surf8mm.txt
<b>ZoomScan</b>	5x5x7,dx=8mm dy=8mm dz=5mm,Complete
<b>Phantom</b>	Validation plane
<b>Device Position</b>	Body Front
<b>Band</b>	DECT
<b>Channels</b>	Middle
<b>Signal</b>	Crest factor: 25

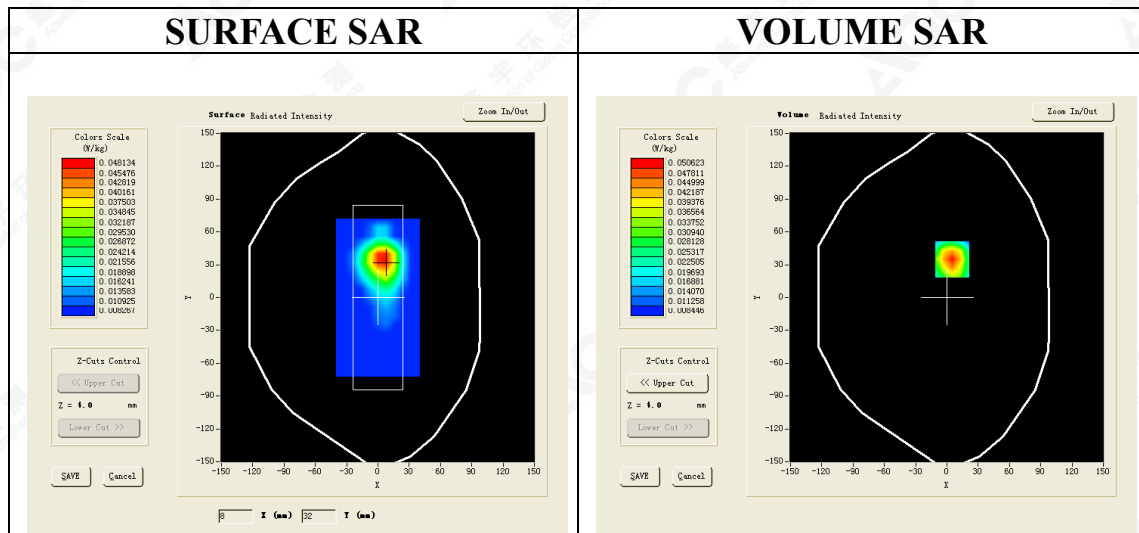

**Maximum location: X=5.00, Y=35.00**

<b>SAR 10g (W/Kg)</b>	0.026023
<b>SAR 1g (W/Kg)</b>	0.046946

The results shown in this test report refer only to the sample(s) tested unless otherwise stated and the sample(s) are retained for 30 days only. The document is issued by AGC, this document cannot be reproduced except in full with our prior written permission. The document is available on request and the brief information for its validation can be assessable and confirmed at <http://www.agc-cert.com>



Z (mm)	0.00	4.00	9.00	14.00	19.00	24.00	29.00
SAR (W/Kg)	0.0000	0.0506	0.0280	0.0172	0.0088	0.0084	0.0084

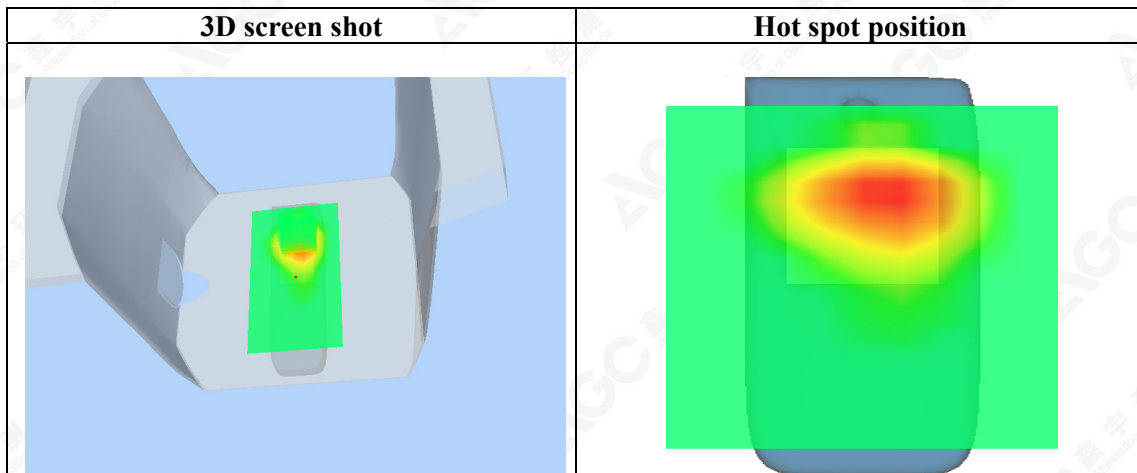
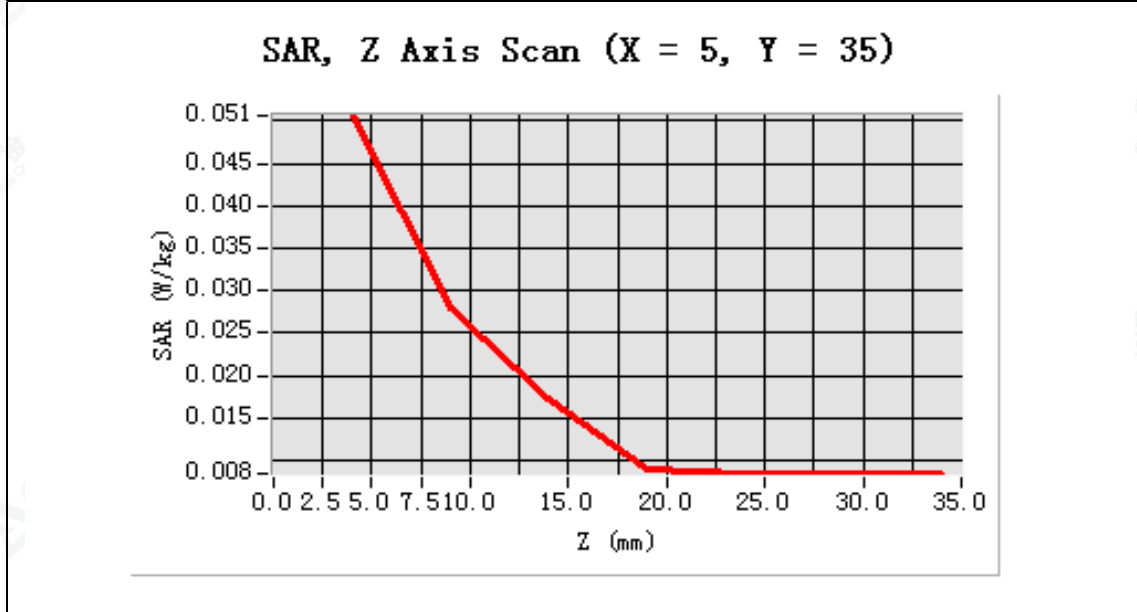

The results shown in this test report refer only to the sample(s) tested unless otherwise stated and the sample(s) are retained for 30 days only. The document is issued by AGC, this document cannot be reproduced except in full with our prior written permission. The document is available on request and the brief information for its validation can be assessable and confirmed at <http://www.agc-cert.com>



**Battery brand name- Coslight**  
**Test Laboratory: AGC Lab**  
**DECT 1900 Mid-Touch- Left**  
**DUT: DECT cordless phone; Type: DS6722-3 HS**

**Date: Mar. 31,2016**

Communication System: DECT; Communication System Band: 1900; Duty Cycle: 4%; Conv.F=6.22  
Frequency: 1924.992 MHz; Medium parameters used:  $f = 1900$  MHz;  $\sigma = 1.41$  mho/m;  $\epsilon_r = 40.73$   $\rho = 1000$  kg/m<sup>3</sup> ;  
Phantom section: Left Section  
Ambient temperature (°C)20.7, Liquid temperature (°C):20.7

**SATIMO Configuration:**

Probe: SSE5; Calibrated: 12/09/2015; Serial No.: SN 22/12 EP159  
Sensor-Surface: 4mm (Mechanical Surface Detection)  
Phantom: SAM twin phantom  
Measurement SW: OpenSAR V4\_02\_01

**Configuration/1900 Mid-Touch- Left /Area Scan:** Measurement grid: dx=8mm, dy=8mm  
**Configuration/1900 Mid-Touch- Left t/Zoom Scan:** Measurement grid: dx=8mm,dy=8mm, dz=5mm;

<b>Area Scan</b>	sam_direct_droit2_surf8mm.txt
<b>ZoomScan</b>	5x5x7,dx=8mm dy=8mm dz=5mm,Complete
<b>Phantom</b>	Left head
<b>Device Position</b>	Cheek
<b>Band</b>	DECT
<b>Channels</b>	Middle
<b>Signal</b>	Crest factor: 25

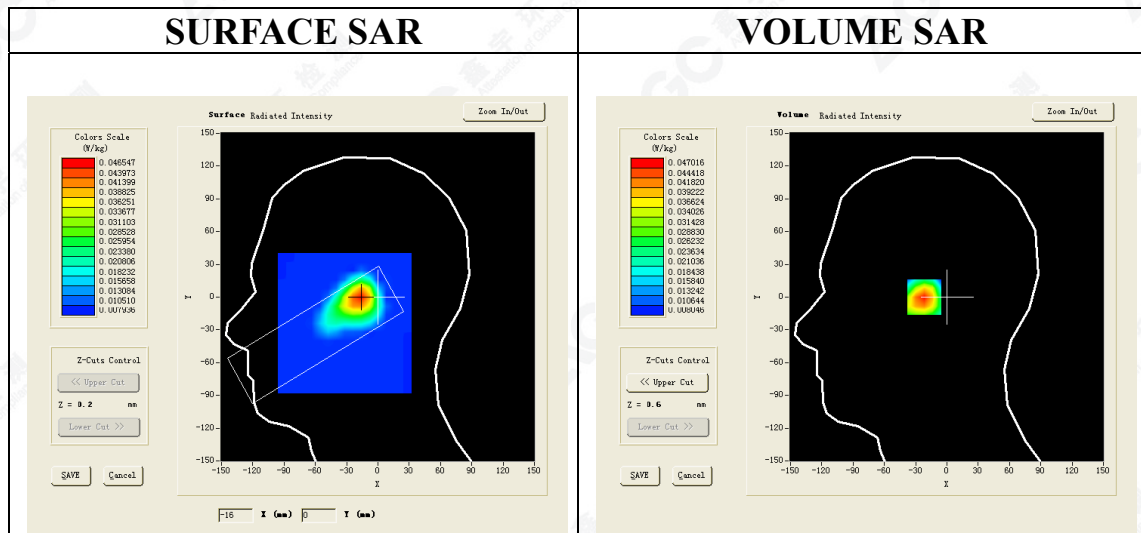

**Maximum location: X=-17.00, Y=0.00**

<b>SAR 10g (W/Kg)</b>	0.025183
<b>SAR 1g (W/Kg)</b>	0.043223

The results shown in this test report refer only to the sample(s) tested unless otherwise stated and the sample(s) are retained for 30 days only. The document is issued by AGC, this document cannot be reproduced except in full with our prior written permission. The document is available on request and the brief information for its validation can be assessable and confirmed at <http://www.agc-cert.com>



Z (mm)	0.00	4.00	9.00	14.00	19.00	24.00	29.00
SAR (W/Kg)	0.0000	0.0470	0.0285	0.0178	0.0100	0.0084	0.0084

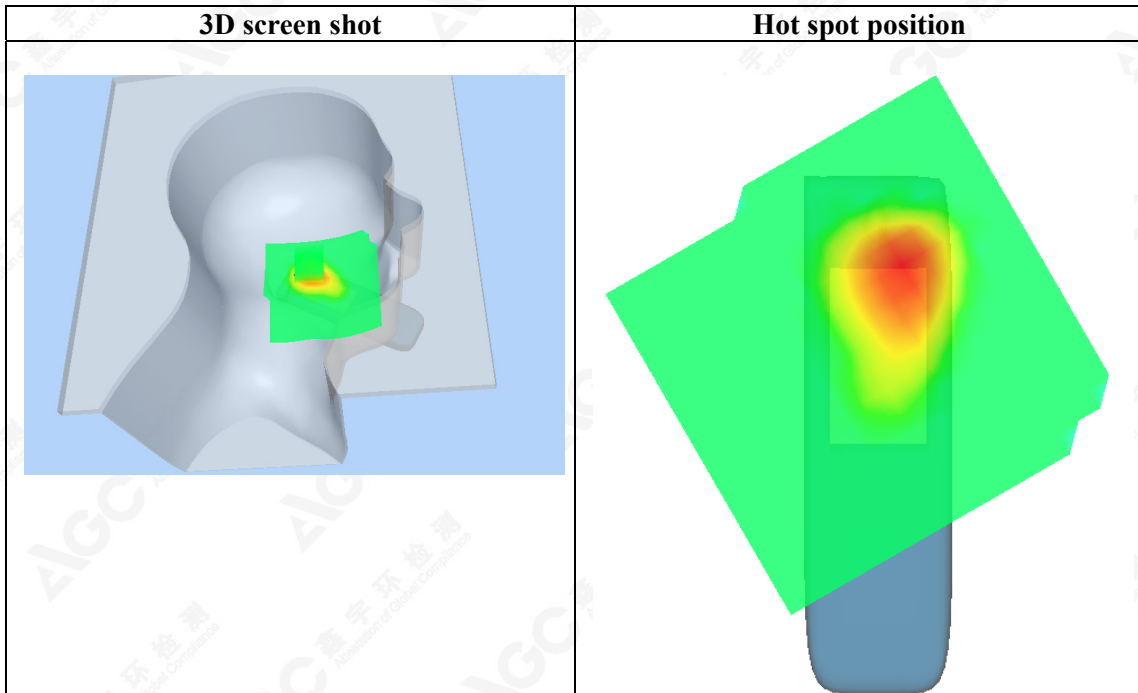
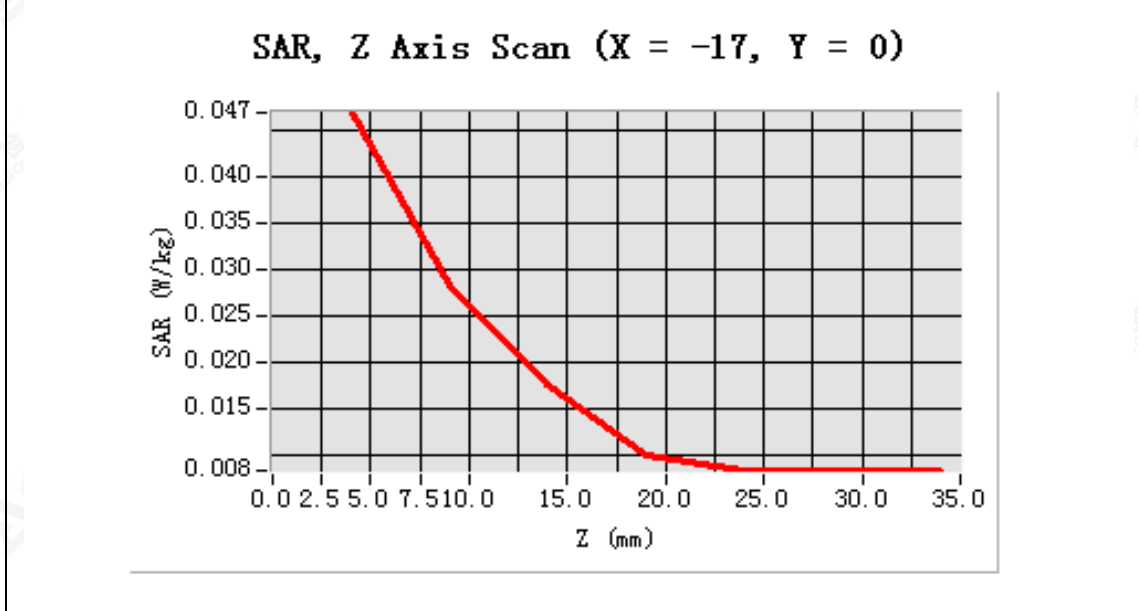

The results shown in this test report refer only to the sample(s) tested unless otherwise stated and the sample(s) are retained for 30 days only. The document is issued by AGC, this document cannot be reproduced except in full with our prior written permission. The document is available on request and the brief information for its validation can be assessable and confirmed at <http://www.agc-cert.com>



**Test Laboratory:** AGC Lab  
**DECT 1900 Mid-Tilt- Left**  
**DUT:** DECT cordless phone; **Type:** DS6722-3 HS

**Date:** Mar. 31,2016

Communication System: DECT; Communication System Band: 1900; Duty Cycle: 4%; Conv.F=6.22  
Frequency: 1924.992 MHz; Medium parameters used:  $f = 1900$  MHz;  $\sigma = 1.41$  mho/m;  $\epsilon_r = 40.73$   $\rho = 1000$  kg/m<sup>3</sup> ;  
Phantom section: Left Section  
Ambient temperature (°C)20.7, Liquid temperature (°C):20.7

**SATIMO Configuration:**

Probe: SSE5; Calibrated: 12/09/2015; Serial No.: SN 22/12 EP159  
Sensor-Surface: 4mm (Mechanical Surface Detection)  
Phantom: SAM twin phantom  
Measurement SW: OpenSAR V4\_02\_01

**Configuration/1900 Mid-Tilt- Left /Area Scan:** Measurement grid: dx=8mm, dy=8mm  
**Configuration/1900 Mid-Tilt- Left t/Zoom Scan:** Measurement grid: dx=8mm,dy=8mm, dz=5mm;

<b>Area Scan</b>	sam_direct_droit2_surf8mm.txt
<b>ZoomScan</b>	5x5x7,dx=8mm dy=8mm dz=5mm,Complete
<b>Phantom</b>	Left head
<b>Device Position</b>	Tilt
<b>Band</b>	DECT
<b>Channels</b>	Middle
<b>Signal</b>	Crest factor: 25

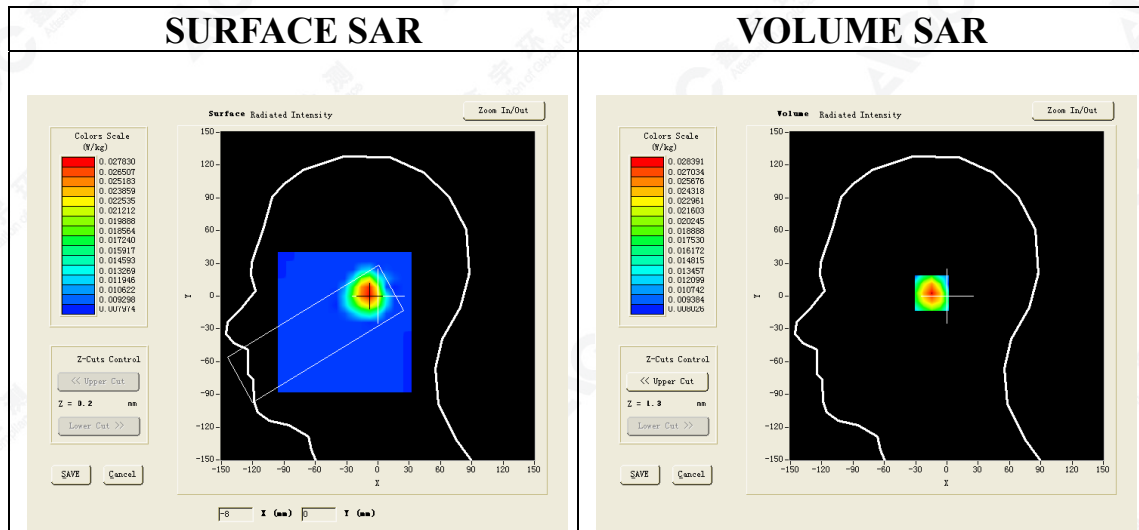

**Maximum location: X=-9.00, Y=3.00**

<b>SAR 10g (W/Kg)</b>	0.015665
<b>SAR 1g (W/Kg)</b>	0.026261

The results shown in this test report refer only to the sample(s) tested unless otherwise stated and the sample(s) are retained for 30 days only. The document is issued by AGC, this document cannot be reproduced except in full with our prior written permission. The document is available on request and the brief information for its validation can be assessable and confirmed at <http://www.agc-cert.com>



Z (mm)	0.00	4.00	9.00	14.00	19.00	24.00	29.00
SAR (W/Kg)	0.0000	0.0284	0.0184	0.0101	0.0084	0.0084	0.0084

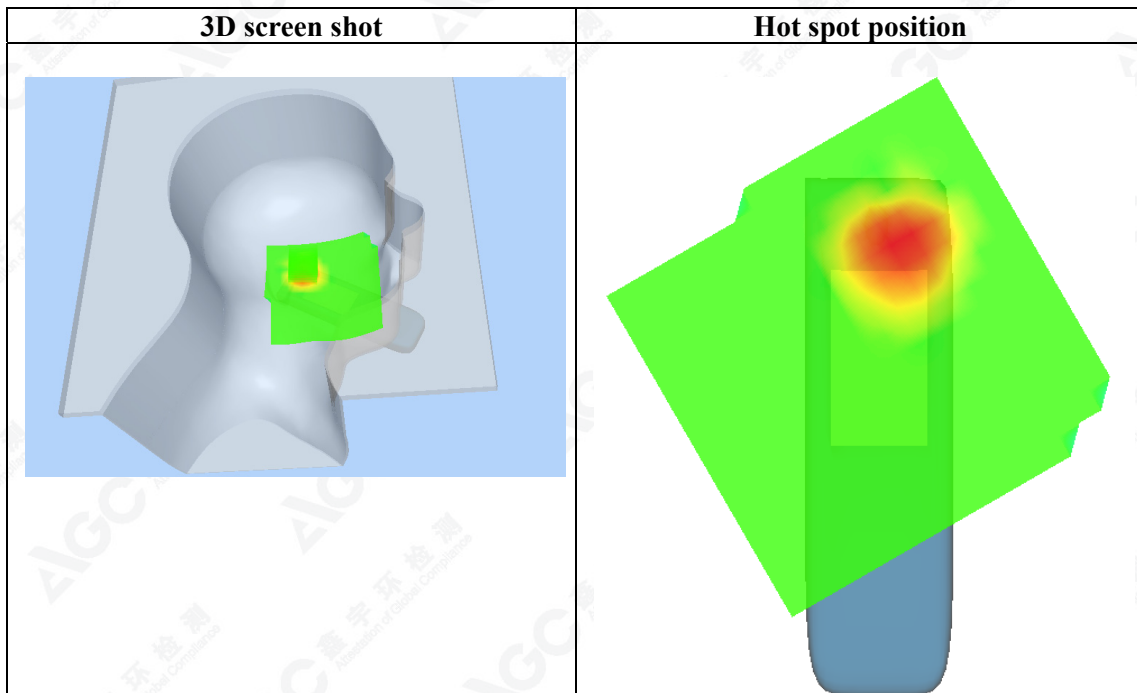
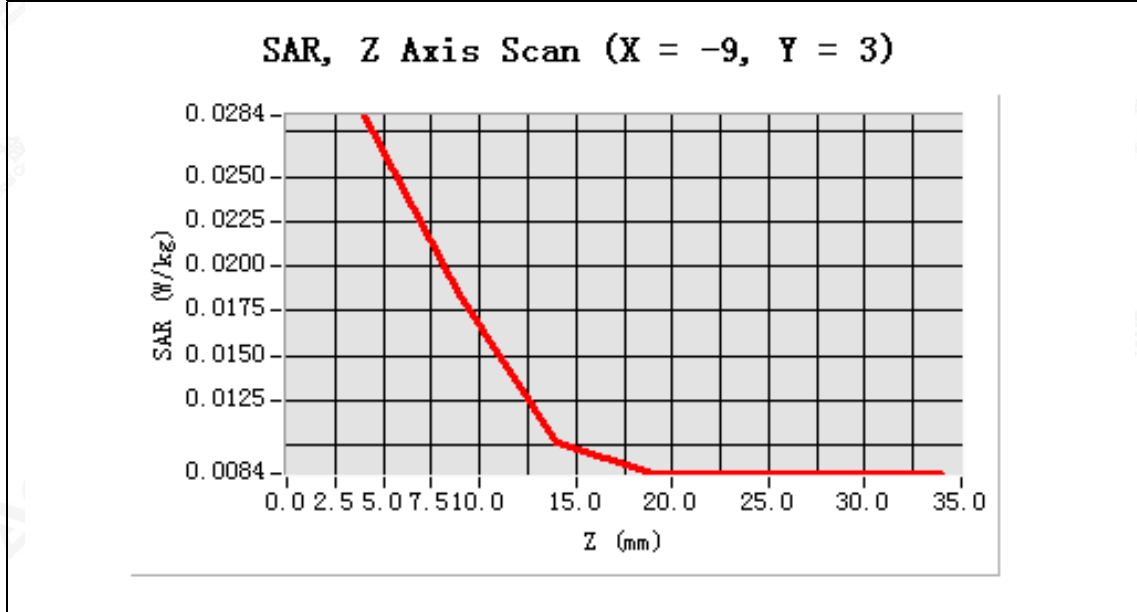

The results shown in this test report refer only to the sample(s) tested unless otherwise stated and the sample(s) are retained for 30 days only. The document is issued by AGC, this document cannot be reproduced except in full with our prior written permission. The document is available on request and the brief information for its validation can be assessable and confirmed at <http://www.agc-cert.com>



**Test Laboratory:** AGC Lab  
**DECT 1900 Mid-Touch- Right**  
**DUT:** DECT cordless phone; **Type:** DS6722-3 HS

**Date:** Mar. 31,2016

Communication System: DECT; Communication System Band: 1900; Duty Cycle: 4%; Conv.F=6.22  
Frequency: 1924.992 MHz; Medium parameters used:  $f = 1900$  MHz;  $\sigma = 1.41$  mho/m;  $\epsilon_r = 40.73$   $\rho = 1000$  kg/m<sup>3</sup> ;  
Phantom section: Right Section  
Ambient temperature (°C)20.7, Liquid temperature (°C):20.7

**SATIMO Configuration:**

Probe: SSE5; Calibrated: 12/09/2015; Serial No.: SN 22/12 EP159  
Sensor-Surface: 4mm (Mechanical Surface Detection)  
Phantom: SAM twin phantom  
Measurement SW: OpenSAR V4\_02\_01

**Configuration/1900 Mid-Touch- Right /Area Scan:** Measurement grid: dx=8mm, dy=8mm  
**Configuration/1900 Mid-Touch- Right t/Zoom Scan:** Measurement grid: dx=8mm,dy=8mm, dz=5mm;

<b>Area Scan</b>	sam_direct_droit2_surf8mm.txt
<b>ZoomScan</b>	5x5x7,dx=8mm dy=8mm dz=5mm,Complete
<b>Phantom</b>	Right head
<b>Device Position</b>	Cheek
<b>Band</b>	DECT
<b>Channels</b>	Middle
<b>Signal</b>	Crest factor: 25

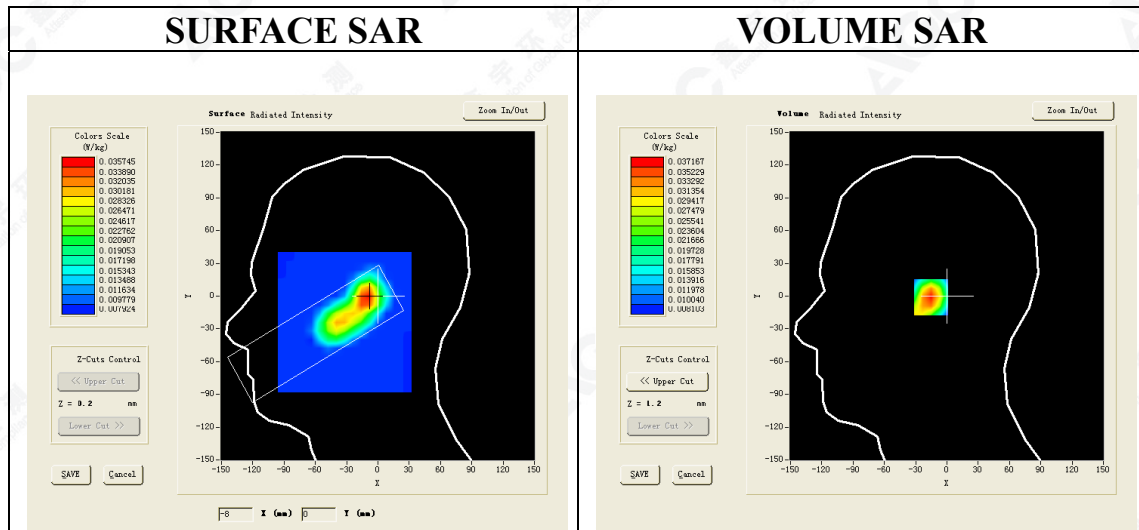

**Maximum location: X=-10.00, Y=-1.00**

<b>SAR 10g (W/Kg)</b>	0.019820
<b>SAR 1g (W/Kg)</b>	0.036758

The results shown in this test report refer only to the sample(s) tested unless otherwise stated and the sample(s) are retained for 30 days only. The document is issued by AGC, this document cannot be reproduced except in full with our prior written permission. The document is available on request and the brief information for its validation can be assessable and confirmed at <http://www.agc-cert.com>



Z (mm)	0.00	4.00	9.00	14.00	19.00	24.00	29.00
SAR (W/Kg)	0.0000	0.0372	0.0177	0.0083	0.0084	0.0084	0.0084

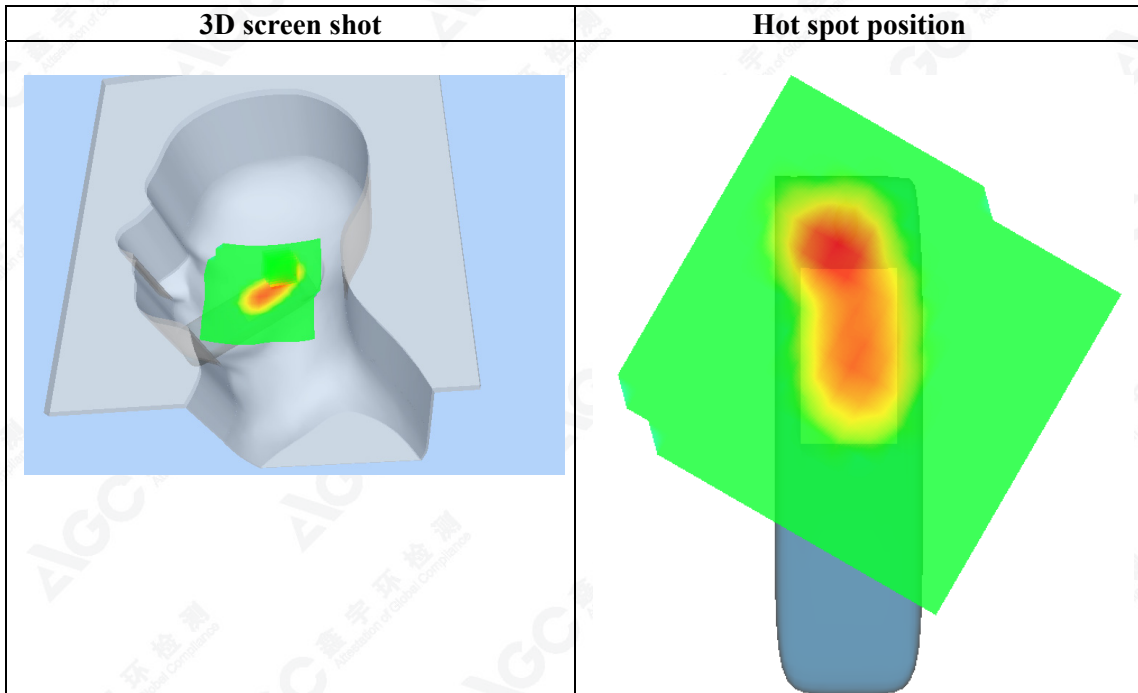
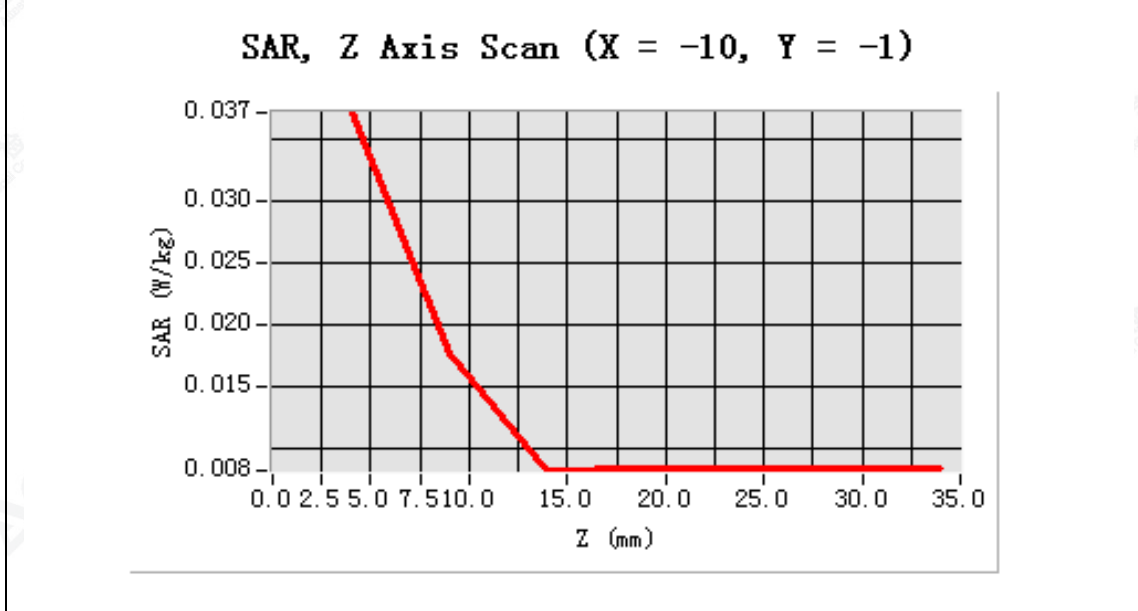

The results shown in this test report refer only to the sample(s) tested unless otherwise stated and the sample(s) are retained for 30 days only. The document is issued by AGC, this document cannot be reproduced except in full with our prior written permission. The document is available on request and the brief information for its validation can be assessable and confirmed at <http://www.agc-cert.com>



**Test Laboratory:** AGC Lab  
**DECT 1900 Mid-Tilt- Right**  
**DUT:** DECT cordless phone; **Type:** DS6722-3 HS

**Date:** Mar. 31,2016

Communication System: DECT; Communication System Band: 1900; Duty Cycle: 4%; Conv.F=6.22  
Frequency: 1924.992 MHz; Medium parameters used:  $f = 1900$  MHz;  $\sigma = 1.41$  mho/m;  $\epsilon_r = 40.73$   $\rho = 1000$  kg/m<sup>3</sup> ;  
Phantom section: Right Section  
Ambient temperature (°C)20.7, Liquid temperature (°C):20.7

**SATIMO Configuration:**

Probe: SSE5; Calibrated: 12/09/2015; Serial No.: SN 22/12 EP159  
Sensor-Surface: 4mm (Mechanical Surface Detection)  
Phantom: SAM twin phantom  
Measurement SW: OpenSAR V4\_02\_01

**Configuration/1900 Mid-Tilt- Right /Area Scan:** Measurement grid: dx=8mm, dy=8mm  
**Configuration/1900 Mid-Tilt- Right t/Zoom Scan:** Measurement grid: dx=8mm,dy=8mm, dz=5mm;

<b>Area Scan</b>	sam_direct_droit2_surf8mm.txt
<b>ZoomScan</b>	5x5x7,dx=8mm dy=8mm dz=5mm,Complete
<b>Phantom</b>	Right head
<b>Device Position</b>	Tilt
<b>Band</b>	DECT
<b>Channels</b>	Middle
<b>Signal</b>	Crest factor: 25

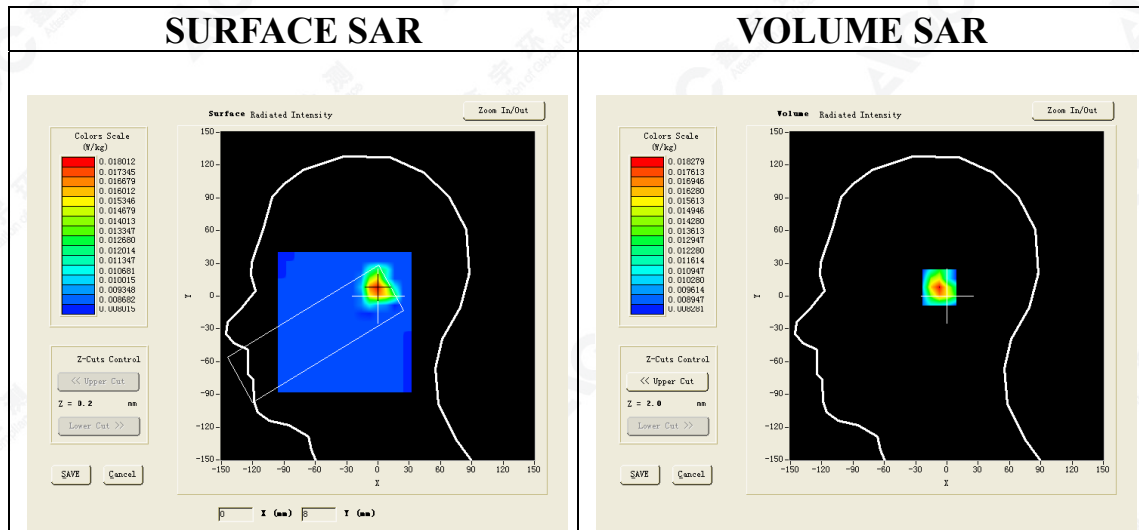

**Maximum location: X=-1.00, Y=8.00**

<b>SAR 10g (W/Kg)</b>	0.011729
<b>SAR 1g (W/Kg)</b>	0.018136

The results shown in this test report refer only to the sample(s) tested unless otherwise stated and the sample(s) are retained for 30 days only. The document is issued by AGC, this document cannot be reproduced except in full with our prior written permission. The document is available on request and the brief information for its validation can be assessable and confirmed at <http://www.agc-cert.com>



Z (mm)	0.00	4.00	9.00	14.00	19.00	24.00	29.00
SAR (W/Kg)	0.0000	0.0183	0.0084	0.0084	0.0084	0.0084	0.0084

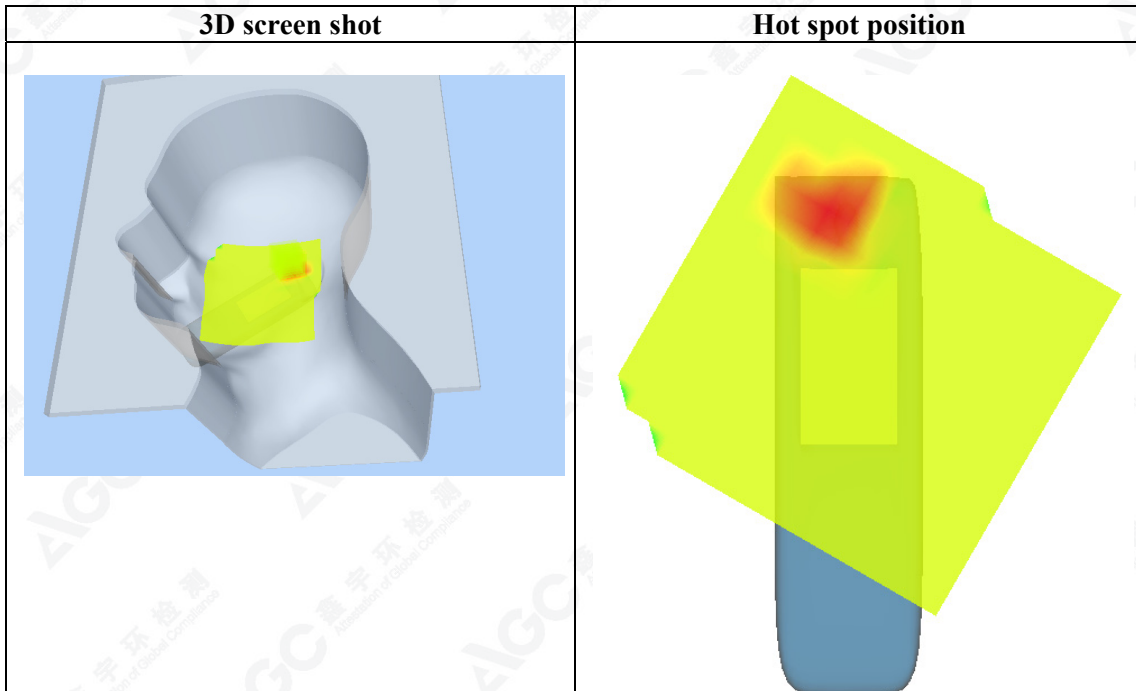
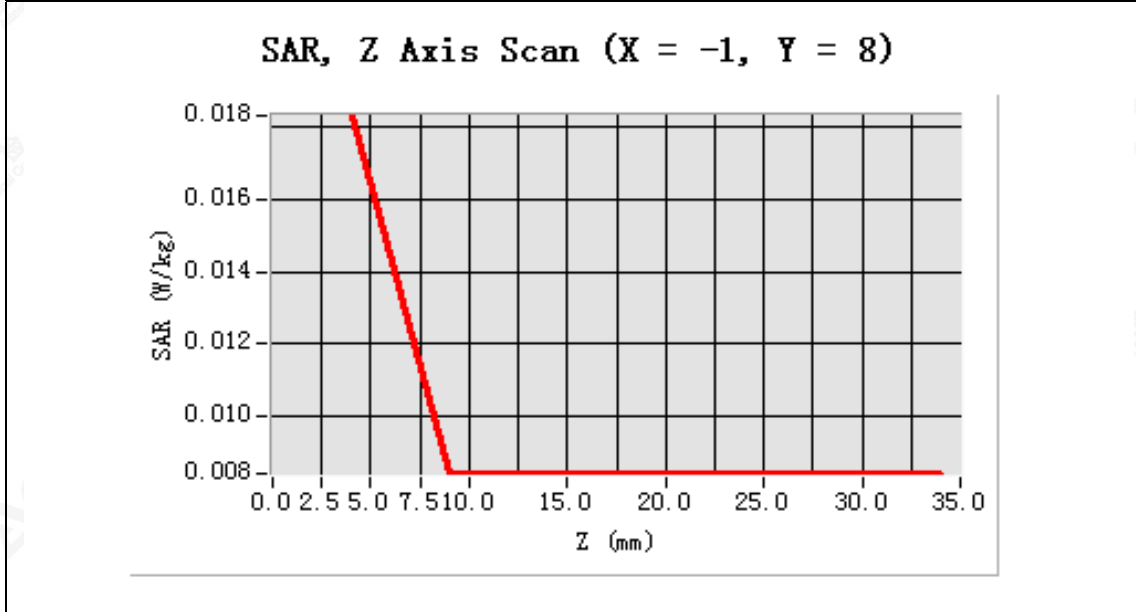

The results shown in this test report refer only to the sample(s) tested unless otherwise stated and the sample(s) are retained for 30 days only. The document is issued by AGC, this document cannot be reproduced except in full with our prior written permission. The document is available on request and the brief information for its validation can be assessable and confirmed at <http://www.agc-cert.com>



**Test Laboratory:** AGC Lab  
**DECT 1900 Mid-Body-Back**  
**DUT:** DECT cordless phone; **Type:** DS6722-3 HS

**Date:** Mar. 31,2016

Communication System: DECT; Communication System Band: 1900; Duty Cycle: 4%; Conv.F=6.43  
Frequency: 1924.992 MHz; Medium parameters used:  $f = 1900$  MHz;  $\sigma = 1.52$  mho/m;  $\epsilon_r = 52.75$ ;  $\rho = 1000$  kg/m<sup>3</sup> ;  
Phantom section: Flat Section  
Ambient temperature (°C):20.7, Liquid temperature (°C):20.7

**SATIMO Configuration:**

Probe: SSE5; Calibrated: 12/09/2015; Serial No.: SN 22/12 EP159  
Sensor-Surface: 4mm (Mechanical Surface Detection)  
Phantom: SAM twin phantom  
Measurement SW: OpenSAR V4\_02\_01

**Configuration1900 Mid-Body- Back/Area Scan:** Measurement grid: dx=8mm, dy=8mm  
**Configuration1900 Mid-Body- Back /Zoom Scan:** Measurement grid: dx=8mm,dy=8mm, dz=5mm;

<b>Area Scan</b>	sam_direct_droit2_surf8mm.txt
<b>ZoomScan</b>	5x5x7,dx=8mm dy=8mm dz=5mm,Complete
<b>Phantom</b>	Validation plane
<b>Device Position</b>	Body Back
<b>Band</b>	DECT
<b>Channels</b>	Middle
<b>Signal</b>	Crest factor: 25

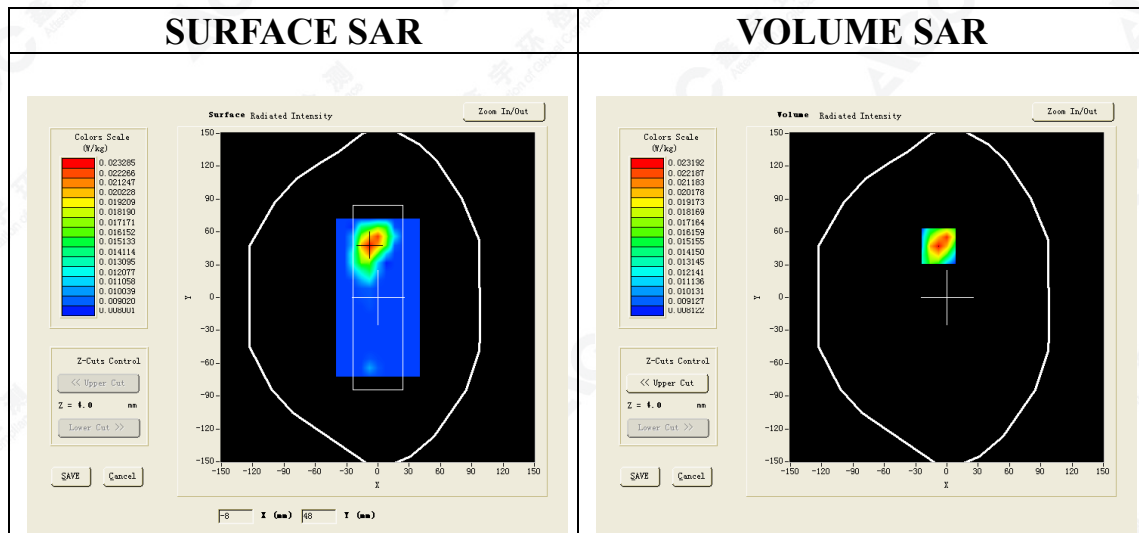

**Maximum location: X=-8.00, Y=47.00**

<b>SAR 10g (W/Kg)</b>	0.013599
<b>SAR 1g (W/Kg)</b>	0.023001

The results shown in this test report refer only to the sample(s) tested unless otherwise stated and the sample(s) are retained for 30 days only. The document is issued by AGC, this document cannot be reproduced except in full with our prior written permission. The document is available on request and the brief information for its validation can be assessable and confirmed at <http://www.agc-cert.com>



Z (mm)	0.00	4.00	9.00	14.00	19.00	24.00	29.00
SAR (W/Kg)	0.0000	0.0232	0.0090	0.0084	0.0084	0.0084	0.0084

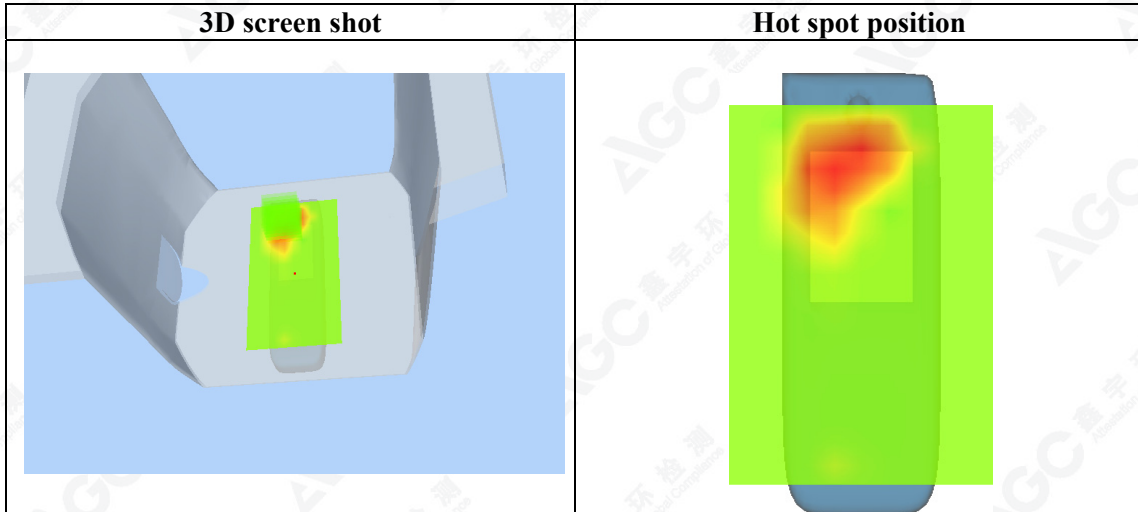
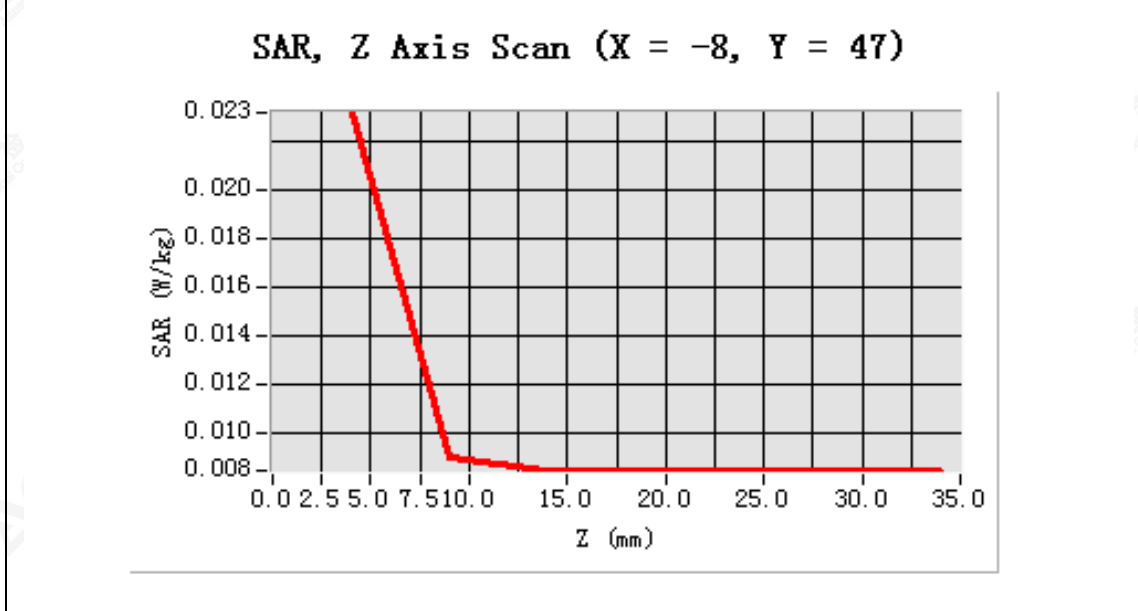

The results shown in this test report refer only to the sample(s) tested unless otherwise stated and the sample(s) are retained for 30 days only. The document is issued by AGC, this document cannot be reproduced except in full with our prior written permission. The document is available on request and the brief information for its validation can be assessable and confirmed at <http://www.agc-cert.com>



**Test Laboratory:** AGC Lab  
**DECT 1900 Mid-Body- Front**  
**DUT:** DECT cordless phone; **Type:** DS6722-3 HS

**Date:** Mar. 31,2016

Communication System: DECT; Communication System Band: 1900; Duty Cycle: 4%; Conv.F=6.43  
Frequency: 1924.992 MHz; Medium parameters used:  $f = 1900$  MHz;  $\sigma = 1.52$  mho/m;  $\epsilon_r = 52.75$ ;  $\rho = 1000$  kg/m<sup>3</sup> ;  
Phantom section: Flat Section  
Ambient temperature (°C):20.7, Liquid temperature (°C):20.7

**SATIMO Configuration:**

Probe: SSE5; Calibrated: 12/09/2015; Serial No.: SN 22/12 EP159  
Sensor-Surface: 4mm (Mechanical Surface Detection)  
Phantom: SAM twin phantom  
Measurement SW: OpenSAR V4\_02\_01

**Configuration1900 Mid-Body- Front /Area Scan:** Measurement grid: dx=8mm, dy=8mm  
**Configuration1900 Mid-Body- Front /Zoom Scan:** Measurement grid: dx=8mm,dy=8mm, dz=5mm;

<b>Area Scan</b>	sam_direct droit2_surf8mm.txt
<b>ZoomScan</b>	5x5x7,dx=8mm dy=8mm dz=5mm,Complete
<b>Phantom</b>	Validation plane
<b>Device Position</b>	Body Front
<b>Band</b>	DECT
<b>Channels</b>	Middle
<b>Signal</b>	Crest factor: 25

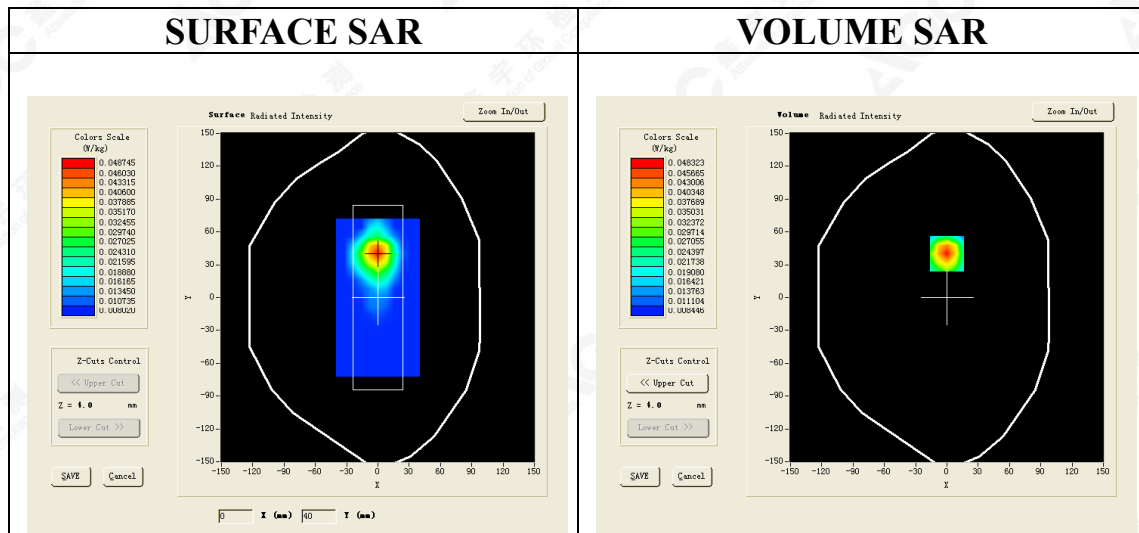

**Maximum location: X=0.00, Y=40.00**

<b>SAR 10g (W/Kg)</b>	0.024795
<b>SAR 1g (W/Kg)</b>	0.045445

The results shown in this test report refer only to the sample(s) tested unless otherwise stated and the sample(s) are retained for 30 days only. The document is issued by AGC, this document cannot be reproduced except in full with our prior written permission. The document is available on request and the brief information for its validation can be assessable and confirmed at <http://www.agc-cert.com>



Z (mm)	0.00	4.00	9.00	14.00	19.00	24.00	29.00
SAR (W/Kg)	0.0000	0.0483	0.0262	0.0164	0.0087	0.0084	0.0084

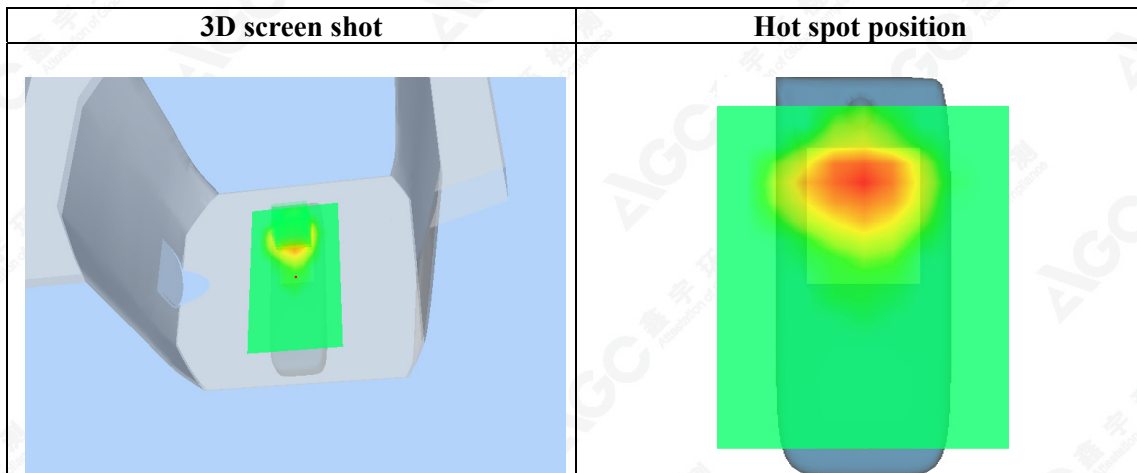
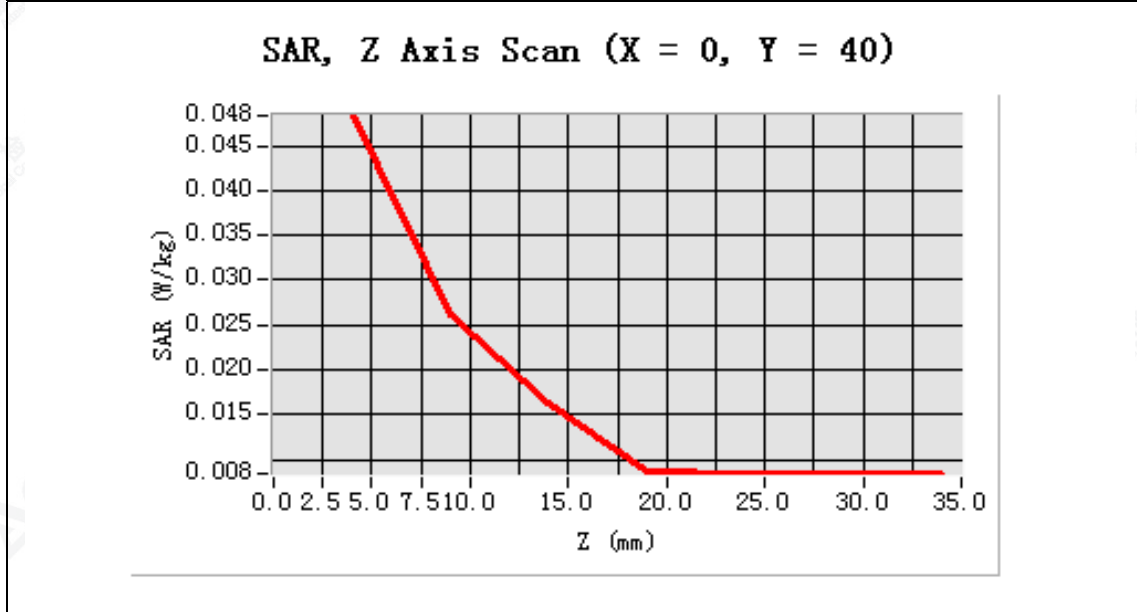

The results shown in this test report refer only to the sample(s) tested unless otherwise stated and the sample(s) are retained for 30 days only. The document is issued by AGC, this document cannot be reproduced except in full with our prior written permission. The document is available on request and the brief information for its validation can be assessable and confirmed at <http://www.agc-cert.com>



## APPENDIX C. TEST SETUP PHOTOGRAPHS & EUT PHOTOGRAPHS

Refer to Attached files.

## APPENDIX D. CALIBRATION DATA

Refer to Attached files.

The results shown in this test report refer only to the sample(s) tested unless otherwise stated and the sample(s) are retained for 30 days only. The document is issued by AGC, this document cannot be reproduced except in full with our prior written permission. The document is available on request and the brief information for its validation can be assessable and confirmed at <http://www.agc-cert.com>