

**Paragon<sup>PD+</sup>**  
**Data Base Station**  
**Technical Manual**  
**Version 1.00**

**PRELIMINARY, For Internal Use Only**

The entire contents of this manual and the Radio Installation Software described in this manual are copyright 2003 by DATARADIO Inc.

Copyright DATARADIO Inc.  
December 2002

Part no.: 120 20180-100a Preliminary

# Table of Contents

<b>1. PRODUCT OVERVIEW .....</b>	<b>3</b>
1.1 INTENDED AUDIENCE .....	3
1.2 GENERAL DESCRIPTION.....	3
1.2.1 Features:.....	3
1.3 FACTORY TECHNICAL SUPPORT.....	4
1.4.....	5
1.4 PRODUCT WARRANTY.....	5
1.5 REPLACEMENT PARTS .....	5
1.5.1 Factory Repair.....	5
1.6 PACKAGING.....	5
<b>2.....</b>	<b>4</b>
<b>2. INSTALLATION.....</b>	<b>4</b>
2.1 OVERVIEW.....	4
2.2 LOCATION.....	4
2.3 ELECTRICAL .....	4
2.3.1 Radio Assembly Power .....	6
2.3.2 BDLC <sup>PD+</sup> assembly Power .....	7
2.4 ANTENNA .....	7
2.4.1 Overview.....	7
2.4.2 Cabling and Connection.....	7
2.5 COMPLETING THE PHYSICAL INSTALLATION.....	8
2.6 CHECKING OUT NORMAL OPERATION.....	8
<b>3. OPERATING DESCRIPTION.....</b>	<b>9</b>
3.1 RADIO ASSEMBLY .....	9
3.1.1 Front panels.....	9
Receiver module .....	9
3.1.1.2 Exciter module.....	10
3.1.1.3 Power Amp module .....	10
3.1.1.4 Speaker panel.....	11
3.1.1.5 Dual Power Supply module.....	11
3.1.1.5.1 Rear Connections.....	12
3.1.2 Radio Assembly, rear panel.....	12
3.1.2.1 Backplane PCB.....	12
3.2 BDLC <sup>PD+</sup> .....	12
3.2.1 BDLC <sup>PD+</sup> Front panel .....	12
3.2.1.1 Front Switches .....	13
3.2.1.1.1 Reset .....	13
3.2.1.1.2 PF 1.....	13
3.2.1.2 Clearing Errors .....	13
3.2.1.3 Test Transmissions .....	13
3.2.1.4 RS-232 LED Function Selection .....	15
3.2.1.5 LEDs and Indications .....	15
3.2.1.5.1 Radio Network Indicators .....	16
3.2.1.5.2 RS-232 Port Indicators .....	16
3.2.1.5.3 Check and Power LEDs .....	16
3.2.1.5.4 Alarm Indicators .....	17
3.2.2 BDLC <sup>PD+</sup> Rear panel.....	17
3.2.2.1 RS-232 Signal Levels .....	18
3.2.2.2 Pin Functions.....	18
<b>4. TROUBLE-SHOOTING AND TESTING.....</b>	<b>20</b>

4.1	EQUIPMENT REQUIRED .....	20
4.2	.....	21
4.2	RECOMMENDED CHECKS.....	21
4.3	ADDITIONAL TEST DETAILS .....	25
4.3.1	RF Data Link Test.....	25
4.3.2	Carrier deviations.....	26
<b>5.</b>	<b>RADIO PROGRAMMING AND ADJUSTMENTS.....</b>	<b>27</b>
5.1	SERIES II RADIO PROGRAMMING.....	27
5.1.1	Recommended Items.....	27
5.1.2	Module Programming.....	27
5.1.3	Channel Selection via DIP Switches.....	31
5.2	SERIES II RADIO TUNING.....	32
5.2.1	Test Equipment .....	32
5.2.2	Receiver module (T885-xx-0200, T855-xx-0250 & T835-xx-0200).....	33
5.2.2.1	Initial Setup .....	33
5.2.2.2	Synthesizer Alignment.....	33
5.2.2.3	Front-End Alignment.....	34
5.2.2.4	SINAD and Linearity Check.....	34
5.2.2.5	RSSI Adjustment .....	35
	Exciter Module (T881-xx-0200, T857-xx-0250 or T837-xx-0200).....	36
5.2.3.1	Initial Setup .....	36
5.2.3.2	Synthesizer Alignment.....	36
5.2.3.3	TX Frequency Error Adjustment .....	37
5.2.3.4	Low-Frequency Balance Adjustment.....	37
5.2.3.5	Exciter Power Output .....	38
5.2.4	Power Amplifier Module (T889 (800-870 MHz only), T859 or T839).....	38
5.2.4.1	Power Amplifier Power Output.....	38
5.2.4.2	Forward Power Alarm Level (Optional setting) .....	39
5.2.4.3	Reverse Power Alarm Level (Optional setting) .....	39
5.2.4.4	Tait T859 (UHF) Standard Tuning Procedure.....	39
5.2.4.5	Tait T859 Tuning for Best Efficiency.....	39
5.2.5	(TPL) LMS series Power amplifier (PA8-2BF-LMS) (890-960 MHz) .....	40
5.2.5.1	Power Output alignment (from TPL Communications).....	40
5.2.5.2	Forward Power Alarm Level.....	40
5.2.5.3	Amplifier Activation.....	40
5.2.5.4	RF Input (Relative Reading).....	40
5.2.5.5	Forward Power meter calibration.....	40
5.2.5.6	Reverse Power meter calibration .....	40
5.2.5.7	Reverse Power Alarm Level .....	41
<b>6.</b>	<b>SPECIFICATIONS.....</b>	<b>49</b>
<b>APPENDIX 1 - PARAGON<sup>PD+</sup> DEVIATION ADJUST .....</b>		<b>48</b>
FIGURE 1 - TYPICAL RADIO AND POWER SUPPLY ASSEMBLIES, FRONT VIEW .....		4
FIGURE 2 - BDLC <sup>PD+</sup> , FRONT VIEW .....		4
FIGURE 3 - TYPICAL RADIO AND POWER SUPPLIES ASSEMBLY, REAR VIEW .....		5
FIGURE 4 - BDLC <sup>PD+</sup> , REAR VIEW .....		5
FIGURE 5 - BDLC <sup>PD+</sup> 'S REAR CONNECTION, SWITCH, AND FUSE.....		7
FIGURE 6 - RECEIVER MODULE FRONT PANEL.....		9
FIGURE 7 - EXCITER MODULE, FRONT PANEL.....		10
FIGURE 8 - POWER AMP MODULE, FRONT PANEL.....		10
FIGURE 9 - SPEAKER PANEL.....		11
FIGURE 10 - DUAL POWER SUPPLY REAR CONNECTIONS .....		12
FIGURE 11 - BDLC <sup>PD+</sup> MEMBRANE SWITCHES .....		13

FIGURE 12 - RF INDICATORS .....	16
FIGURE 13 - RS-232 LED PORT INDICATORS .....	16
FIGURE 14 - ALARMS LED INDICATORS .....	17
FIGURE 15 - BDLC <sup>PD+</sup> Y CABLE AND PINOUT .....	19
FIGURE 16 - CARRIER DEVIATIONS FOR TONE OR DATA MODULATION.....	26
FIGURE 17 - RECEIVER SYSTEM INFORMATION .....	29
FIGURE 18 - RECEIVER CHANNEL INFORMATION SCREEN.....	29
FIGURE 19 - EXCITER SYSTEM INFORMATION SCREEN.....	30
FIGURE 20 - EXCITER CHANNEL INFORMATION SCREEN .....	30
FIGURE 21 - BACKPLANE DIP SWITCHES EXAMPLE - CHANNEL 5 SELECTED .....	31
FIGURE 22 - T855 AND T885, TYPICAL RSSI CURVE: VOLT TO DBM .....	35
FIGURE 23 - T835, TYPICAL RSSI CURVE: VOLT TO DBM.....	35
FIGURE 24 - T800-50-0001 BACKPLANE .....	36
FIGURE 25 - T859 TUNING SETTINGS .....	39
FIGURE 26 - (TPL) LMS REAR PANEL .....	41
FIGURE 27 - T885-0020 RECEIVER TUNING CONTROLS LOCATION .....	42
FIGURE 28 - T881-0200 EXCITER TUNING CONTROLS LOCATIONS .....	43
FIGURE 29 - T855 RECEIVER TUNING CONTROLS LOCATION .....	44
FIGURE 30 - T857 EXCITER TUNING CONTROLS LOCATIONS.....	45
FIGURE 31 - T835 RECEIVER TUNING CONTROLS LOCATION .....	46
FIGURE 32 - T837 EXCITER TUNING CONTROLS LOCATION .....	47
TABLE 1 - ON-AIR DATA SPEEDS AND MODULATION TYPES .....	4
TABLE 2 - POWER SUPPLY LEDs INDICATIONS .....	6
TABLE 3 - TX MODE SELECTION LEDs INDICATIONS.....	14
TABLE 4 - TEST TRANSMISSIONS .....	14
TABLE 5 - RS-232 LED FUNCTION SELECTION SEQUENCE .....	15
TABLE 6 - RS-232 SIGNAL LEVELS .....	18
TABLE 7 - DTE PORT 9-PIN FUNCTIONS.....	18
TABLE 8 - DTE PORT 25-PIN FUNCTIONS .....	18
TABLE 9 - CHECKLIST A (AFTER INSTALLATION) .....	22
TABLE 10 - CHECKLIST B (GENERAL) .....	23

## WHAT'S NEW

### History

Version 1.00a (preliminary): January 2003

- Appended data for 8-FSK modulation on transmit side

Version 1.0: December 2002

- First released version

## Definitions

The following terms are used throughout this document.

<b>Asynchronous</b>	Information that can be sent at random times, and not synchronized to a clock. Transmission characters begin with a “start” bit and end with a “stop” bit.
<b>AVL</b>	Automatic Vehicle Location. Optional feature that involves using GPS (Global Positioning System) signals from the mobile unit by the Host PC.
<b>BDLC<sup>PD+</sup></b>	Base Station Data Link Controller (PD = Parallel decode). An async radiomodem designed to control the base station in mobile systems. A component of Paragon <sup>PD+</sup> .
<b>DBA</b>	Dataradio’s Dynamic Bandwidth Allocation protocol designed for short-inquiry/long response applications such as dispatch systems. Latest enhancements include support for occasional long messages inbound, and for Out-of-Band data for AVL reports with no extra overhead.
<b>DCE</b>	Data Communications Equipment. This designation defines the direction (input or output) of the various RS-232 interface signals. Modems are always wired as DCE.
<b>DTE</b>	Data Terminal Equipment. This designation defines the direction (input or output) of the various RS-232 interface signals. Most user equipment, as well as PCs, are wired as DTE.
<b>Gemini<sup>PD</sup></b>	High specs mobile radiomodem. (PD = Parallel Decode)
<b>Gemini<sup>PD+</sup></b>	On-air compatible with Gemini <sup>PD</sup> . Runs up to 32 kb/s
<b>Network Speed</b>	This is the <i>bit rate</i> on the RF link between units. Could be different from COM port <i>baud rate</i> .
<b>Paragon<sup>PD</sup></b>	Factory-integrated industrial-grade data base station using Parallel Decode technology. Used in VIS mobile networks.
<b>Paragon<sup>PD+</sup></b>	Higher performance model.
<b>Parallel Decode</b>	Technology featuring dual receivers for added data decode sensitivity in multi-path and fading environments.
<b>Radio Assembly</b>	Radio modules used in Paragon <sup>PD</sup> and Paragon <sup>PD+</sup> and available in two distinct series depending on radio’s frequency band.
<b>RS-232</b>	Industry–standard interface for serial data transfer.
<b>VIS</b>	Vehicular Information Solutions. Dataradio’s name for a series of products specially designed for mobile data.
<b>WinRIS</b>	Windows Radio Installation Software. This software allows basic tests, unit configuration, and troubleshooting.

# 1. PRODUCT OVERVIEW

This document provides information required for the setting up, operation, testing and trouble-shooting of the DATARADIO Paragon<sup>PD+</sup> radio-modem base station.

## 1.1 Intended Audience

This document is intended for engineering, installation, and maintenance personnel.

## 1.2 General Description

Paragon<sup>PD+</sup> product is a factory-integrated industrial-grade data base station used in mobile networks and is designed specifically to fit the needs of vehicular applications. It features dual receivers for added data decode sensitivity in multi-path and fading environments.

When used with Dataradio's state-of-the-art Gemini<sup>PD/PD+</sup> mobile data solution, the system delivers unequalled high-speed data performance and unmatched effective throughput.

All Paragon<sup>PD+</sup> models are supplied in a rack-mount configuration that includes:

- A Paragon<sup>PD+</sup> full-duplex Radio assembly.
- A contemporary, high-speed Dataradio "Base Station Data Link Controller" (BDLC<sup>PD+</sup>).

In Paragon<sup>PD+</sup> units:

- Duplexer and backup power units are custom furnished items.
- Wire line modem(s) are optional items.
- Laptop PC and its application software are user-supplied items.

### 1.2.1 Features:

- Parallel Decode (PD) technology featuring dual receivers for added decode sensitivity in multi-path and fading environments.
- Sophisticated DSP-based modem design provides added system performance, fewer retries and more effective throughput.
- Models with on-air data speeds and modulation types as listed in Table 1
- Available in 800 MHz, 900 MHz, UHF, and VHF
- Power output of 20W to 70W for ParagonPD's 800 MHz, of 65W to 100W for 900 MHz, and of 20W to 100W for UHF and for VHF
- Supports high-efficiency Dataradio DBA over-the-air protocol
- Over-the-air compatible with MobilPac/R, GeminiPD, and PD+ mobile products
- Modular design in a rugged die-cast aluminum chassis
- ParagonPD+ units are factory-configured based on each customer's network system requirements

- EEPROM Flash programmable firmwares

Table 1 - on-air data speeds and modulation types

Modulation type	Channel spacing		
	12.5 kHz	NPSAC& 900MHz	25 kHz
DGMSK <sup>1</sup>	9.6 kb/s	9.6 kb/s	9.6 kb/s
	8.0 kb/s	8.0 kb/s	19.2 kb/s
xRC4FSK <sup>1</sup>	16 kb/s	19.2 kb/s	32 kb/s <sup>2</sup>
	14.4 kb/s	16 kb/s	25.6 kb/s
xRC8FSK <sup>1, 2</sup>	21.6 kb/s	24.0 kb/s	43.2 kb/s
	24.0 kb/s	28.8 kb/s	48.0 kb/s

### 1.3 Factory Technical Support

The Technical Support departments of DATARADIO provide customer assistance on technical problems and serve as an interface with factory repair facilities. They can be reached in the following ways:

For Canada and International customers:

DATARADIO Inc.  
5500 Royalmount Ave, suite 200  
Town of Mount Royal  
Quebec, Canada H4P 1H7

Technical support hours: Monday to Friday 9:00 AM to 5:00 PM, Eastern Time

phone: +1 514 737-0020  
fax: +1 514 737-7883

Email address: [support@dataradio.com](mailto:support@dataradio.com)

or

For U.S. customers:

DATARADIO Corp.  
6160 Peachtree Dunwoody RD., suite C-200  
Atlanta, Georgia 30328

Technical support hours: Monday to Friday 8:30 AM to 5:30 PM, Eastern Time

phone: 1 770 392-0002  
fax: 1 770 392-9199

Email address: [drctech@dataradio.com](mailto:drctech@dataradio.com)

---

1 Networks must use common modulation, bit and baud rates.

2 Available with Gemini <sup>PD+</sup> **only**



## 1.4 Product Warranty

Warranty information may be obtained by contacting your sales representative.

## 1.5 Replacement Parts

This product is usually not field-serviceable, except by the replacement of individual radio modules. Specialized equipment and training is required to repair logic, modem boards, and radio modules.

Contact Technical Support for service information before returning equipment. A Technical Support representative may suggest a solution eliminating the need to return equipment.

### 1.5.1 Factory Repair

When returning equipment for repair, you must request an RMA (Returned Material Authorization) number. The Tech Support representative will ask you several questions to clearly identify the problem. Please give the representative the name of a contact person, who is familiar with the problem, should a question arise during servicing of the unit.

Customers are responsible for shipping charges for returned units. Units in warranty will be repaired free of charge unless there is evidence of abuse or damage beyond the terms of the warranty. Units out of warranty will be subject to service charges. Information about these charges is available from Technical Support.

## 1.6 Packaging

Each Paragon<sup>PD</sup> product normally leaves the factory packaged as follows:

- A Series II Dataradio base station "Radio assembly"
- A dual power supply assembly
- A Dataradio BDLC<sup>PD+</sup> model
- A Radio Interface Cable to link the Radio assembly to the BDLC<sup>PD+</sup>:  
18-inch long "Y" cable; DB-25 female to dual DB-25 female (p/n 730 03374-102) for connection between backplane PCBs and BDLC<sup>PD+</sup>.
- One standard seven-foot 120VAC power cord
- Two DC power cables to connect the radio assembly to the dual power supply assembly.
- Courtesy small parts kit

Frequently, Paragon<sup>PD+</sup> product components are field-assembled prior to customer delivery. The cabinetry may then be supplied in one of several custom rack-mount configurations that may also include fan, backhaul modems, duplexer/filters/combiners, and ancillary equipment.

If damage has occurred to the equipment during shipment, file a claim with the carrier immediately.

## 2. Installation

### 2.1 Overview

The cabinet and rack-mount housing the Paragon<sup>PD+</sup>'s radio assembly and the BDLC<sup>PD+</sup> is generally installed in a sheltered facility. Occasionally located adjacent to the nerve center of the user's network, it is often located near tower sites or at remote locations where it operates unattended.

Furnishings needed include power, cabling, and installation of antenna, landline or microwave modem, and host PC or portable computer. Details of these are outside the scope of this manual. This manual covers the radio assembly and the BDLC<sup>PD+</sup> that includes the modem.

### 2.2 Location

Be sure to place the Paragon<sup>PD+</sup> in such a way that:

- The LEDs can be seen (as an aid in troubleshooting)
- Access to the antenna connector and to the back connectors is possible without removing the unit
- Sufficient air may flow around the unit to provide adequate cooling.

### 2.3 Electrical

Standard 120 VAC electrical power is required. It should be capable of providing at least 10A to power Paragon<sup>PD+</sup> (<6A) and ancillary equipment.

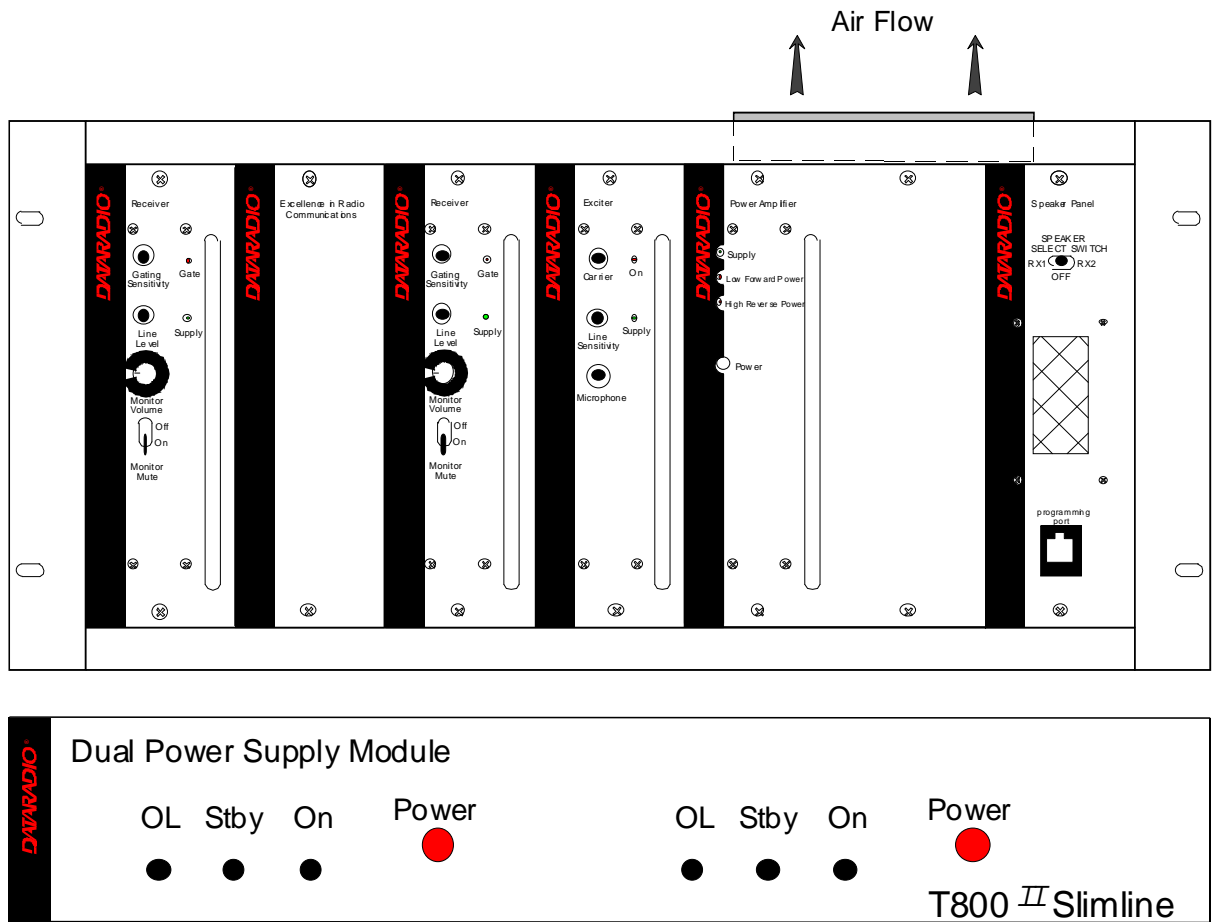

Figure 1 - Typical radio and power supply assemblies, front view

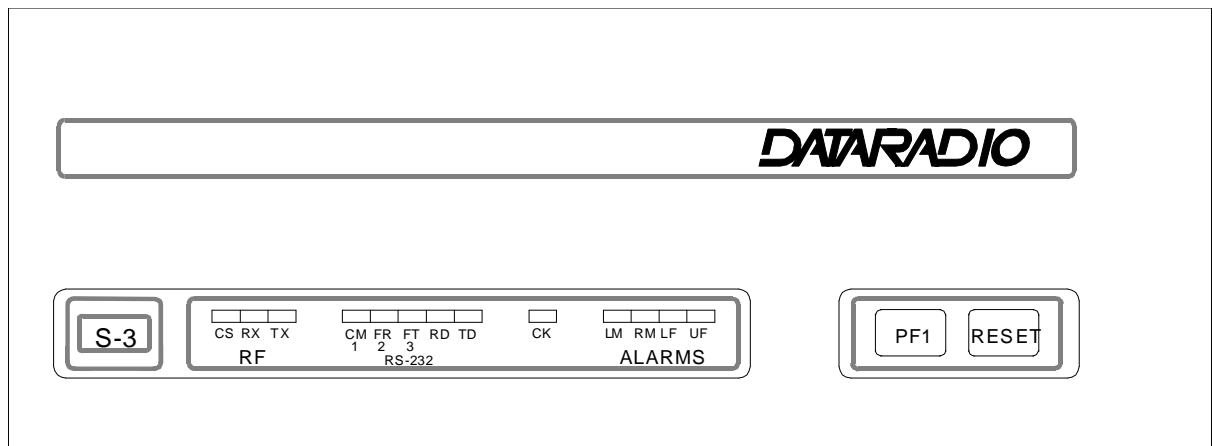

Figure 2 - BDLC<sup>PD+</sup>, front view

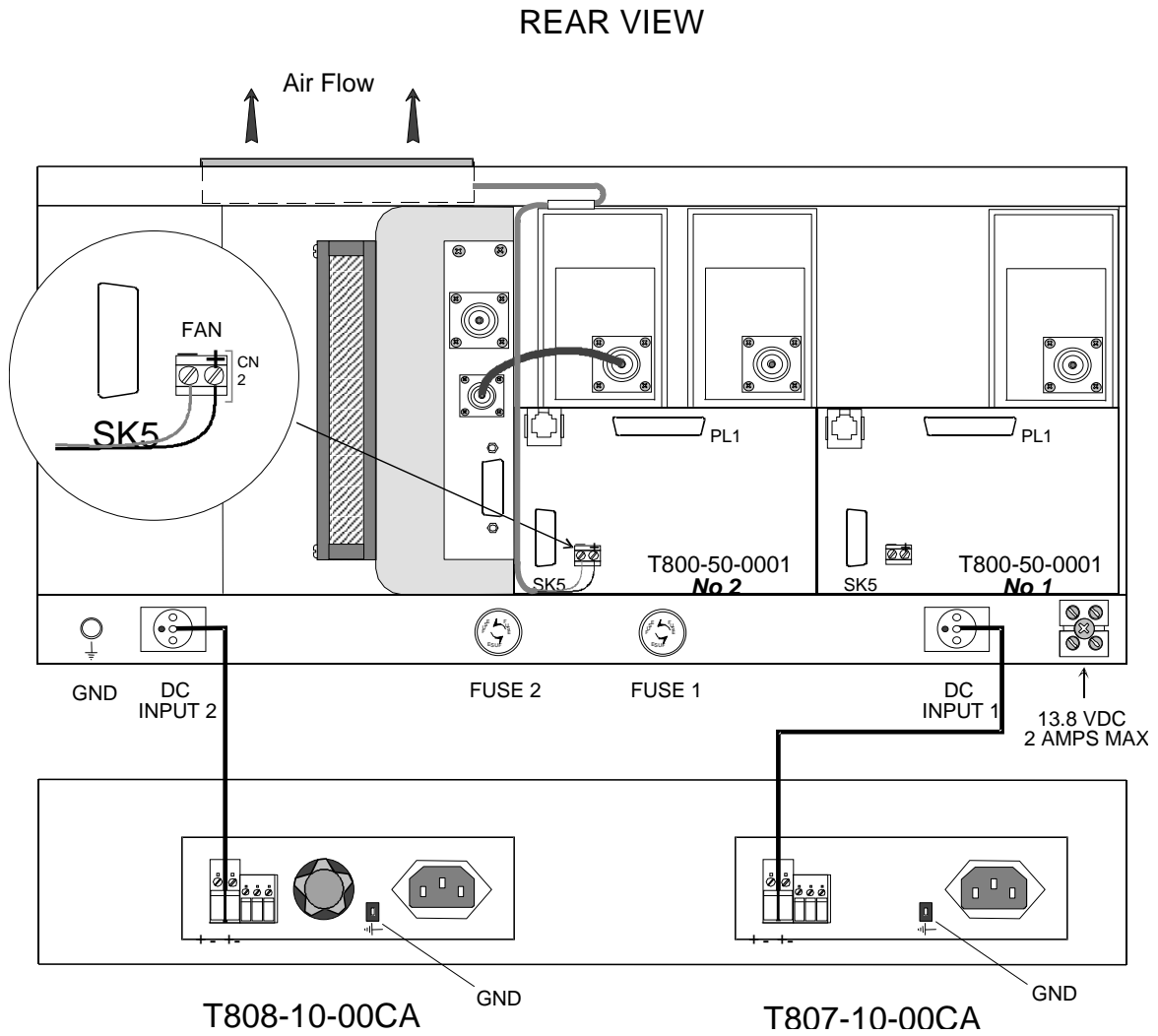

Figure 3 - Typical radio and power supplies assembly, rear view

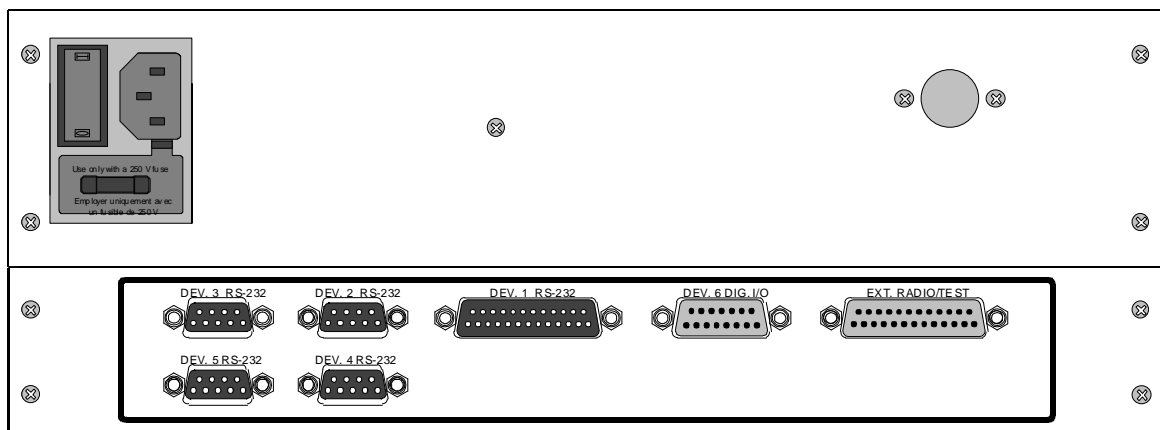

Figure 4 - BDLC<sup>PD+</sup>, rear view

### 2.3.1 Radio Assembly Power

Referring to Figure 3, the Radio assembly unit receives two separate 13.8 VDC power inputs from a “T800 Slimline” dual power supply typically rack-mounted right below the main assembly radio chassis.

The T800 is made up of two separate power supply units joined in a single chassis:

- A T807 using convection cooling is rated up to 15A at 13.8VDC. It supplies all the radio modules other than the Power Amplifier.
- A T808 using convection and fan cooling is rated up to 25A at 13.8VDC. It supplies only the Power Amplifier module.

Normally used at room ambient temperatures, they can operate within their specifications over a range of -10 to +60 °C.

*Note: Internal over-temperature protection shuts down the main transformer above 105 degrees Celsius.*

Both power supply modules are internally connected to ground via their individual, rear-connected, seven-foot standard 120 VAC power cords. Nevertheless, each requires a separate secure electrical ground connection. Individual grounding tabs are provided next to the power connectors.

Similarly, the Radio Assembly chassis requires a secure ground connection. A threaded grounding binding post fitted with a knurled binding-nut is provided on the chassis next to DC input 2. Separate grounding leads with appropriate connectors are supplied (either in the courtesy small-parts kit or with one end fastened to the equipment).

For each of the power supply modules:

1. Fit one end of the grounding lead’s push-on connector onto the grounding tab.

For the Radio Assembly chassis:

1. Install the grounding lead’s lug over the binding post and firmly hand-tighten the binding-nut.

For both A and B

2. Fit the slotted connector (on the other end of each of the grounding connector) under a conveniently located screw on the rack frame or other support surface. Scrape away paint if needed to ensure clean contact.
3. Apply anti-corrosion compound where paint scraping was done.
4. Ensure by testing continuity that a secure electrical and mechanical connection is achieved.

If a -DC rail (0V) is installed as part of the system, the grounding leads may alternatively be fitted to the rail terminal.

*Caution:*

*Improper grounding between power supply case and rack frame may result in harmful voltage potentials and/or miscellaneous power supply switching noise problems in both receivers and transmitter.*

Press both red power buttons located on the front of the module to have complete power distribution to the Radio assembly. The power supply front panel LEDs indications are:

Table 2 - Power Supply LEDs Indications

LED	Color	Indication
On	Green	Power enabled *
Stby	Red	Power disabled *
OL	Steady Red	Current Overload
On & OL	Flashing green and red respectively	Over voltage

\* To remove voltage from the power supply PCB, disconnect the main power cords.

For LEDs descriptions, see section 3.2.1.5

The Radio assembly is fused at the rear of the chassis:

- Fuse 1 is a 32-volt MDL (slow-blow) 10A
- Fuse 2 is a 32-volt MDL (slow-blow) 30A

Note: the fuses form factor and their locations may differ from Figure 3.

### 2.3.2 BDLC<sup>PD+</sup> assembly Power

The BDLC<sup>PD+</sup> assembly uses a standard 120 VAC power cord. Plug this cord to the rear power outlet shown in Figure 4 and Figure 5.

To check or install a fuse:

1. Open the slide-out fuse drawer located below the power connector by using a fine bladed screwdriver or a knife blade and gently pry open.
2. Hold the fuse support in one hand and with the other, lift the center plastic retainer until it releases the fuse sliding base.
3. Replace or install a 250V, 2A fuse.
4. To complete the procedure, push the sliding fuse base until it snaps under the retainer.
5. Re-insert the fuse drawer in its housing and push until it is fully seated and closed.

When ready to apply power, use the ON-OFF toggle power switch adjacent to the power connector.

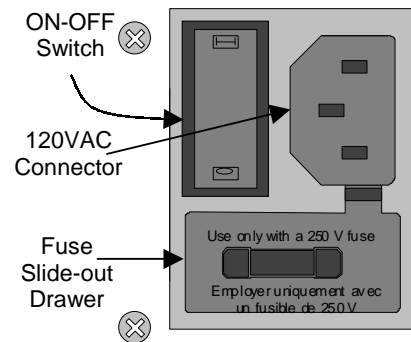

Figure 5 - BDLC<sup>PD+</sup>'s rear connection, switch, and fuse

## 2.4 Antenna

### 2.4.1 Overview

Paragon<sup>PD+</sup> commonly uses three antennas (one transmit and two receive) unless a duplexer is used with one of the receive antennas; then only two antennas would be needed. They should be mounted according to any guidelines supplied with the antennas. For antennas placement and spacing, consult System Engineering.

### 2.4.2 Cabling and Connection

- 1- Route good quality 50-ohm double-shielded coaxial cable(s) (e.g. RG-214 or Helix) from the selected antenna position(s) to the Paragon<sup>PD+</sup> Radio assembly.
- 2- Terminate the RX-1 and RX-2 cable ends at the Receiver modules rear position with an N-type connector.
- 3- Similarly, terminate the TX cable end at the Power Amp's module rear position with an N-type connector.

#### **Caution:**

*When terminating RF cables use brand-name crimping tools (such as AMP, Jensen, CrimpMaster, etc...) of the correct size for the cable and type of connector used.*

*Common pliers are NOT acceptable.*

## 2.5 Completing the physical Installation.

Paragon<sup>PD+</sup> products are factory-configured to user's requirements and are shipped ready to run.

After new installations:

- Re-check that all connections are secure on radio and BDLC<sup>PD+</sup> assemblies (antennas, PC, power cords etc.)
- Check that fuses are inserted.
- Turn both BDLC<sup>PD+</sup> and radio power ON.

You are now ready to check for normal operation (as per paragraph 2.6) and to run the Dataradio Windows Radio Installation Software (WinRIS) program for testing or trouble-shooting.

Any change(s) to the settings must be done via files saved on diskette and loaded into the unit using the WinRIS program.

## 2.6 Checking out Normal Operation

- 1- Check that power is applied.
- 2- Check Radio assembly lights for proper operation as per section 3.1.1
- 3- Check for proper operation of the BDLC<sup>PD+</sup>'s LEDs as per section 3.2.1.5.
- 4- Using the WinRIS program and an in-line wattmeter, check forward & reverse power to confirm main antenna installation (as per section 4)
- 5- Using WinRIS, check the RF Data Link with a mobile that can be heard (as per section 4.3.1)

If user application and mobiles are available, test the installation by going through a normal sequence of transmitting and receiving messages.

## 3. Operating Description

### 3.1 Radio Assembly

The Radio assembly component of each Paragon product is made up of high performance synthesized radio base station designed for single operation. Referring to Figure 1 on page 4, the Radio Assembly's modules are commonly installed in a standard, 19-inch wide rack frame.

#### 3.1.1 Front panels

The complement of modules is identical for Series II *VHF, UHF, and 800/900 MHz models*:

- 2 x Receivers
- 1 x Exciter
- 1 x Power Amplifier
- 1 x Speaker panel
- 1 x Dual Power Supply

##### 3.1.1.1 Receiver module

The RX1 and RX2 receivers' use identical front panel controls and indicators. These are:

- Gating Sensitivity - sets the RF signal level required to open the mute gate and allow audio to pass to the speaker<sup>1</sup>.
- Gate LED - indicates the status of the mute circuit. It is lit when a signal above the mute threshold is received<sup>1</sup>.
- Supply LED - is lit when DC power is applied. Fast Flashes when linked with PGM800Win. Slow Flashes indicates VCO (synthesizer) out of lock. Unequal Flashes indicates internal communication error.
- Line Level - Not used
- Monitor Volume - The audio output delivers up to 1 watt to the speaker. Always set volume knob to minimum when not in use to reduce current consumption.
- Monitor Mute Switch - opens the mute, allowing continuous monitoring of the audio signal. On = audio muted

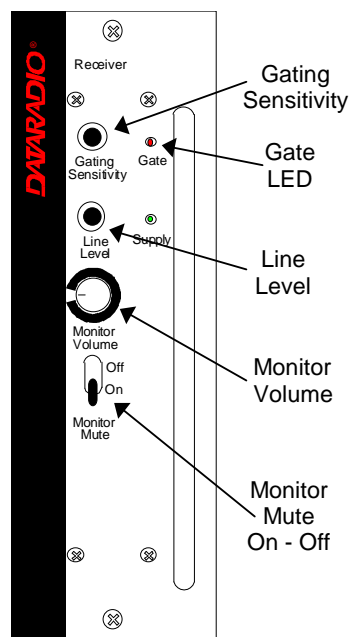

Figure 6 - Receiver module front panel

<sup>1</sup> "Gating Sensitivity" and "Gate LED" are not functionally used except to allow listening to incoming receptions as a trouble-shooting aid. Depending on the sensitivity adjustment, the Gate LED lights and a relay can be heard on incoming RF signals.



### 3.1.1.2 Exciter module

The Exciter's front panel controls and indicators are:

- Carrier Switch - momentarily keys the transmitter ON while pressed (used for test purposes only).
- On LED - is lit when transmitting
- Line Sensitivity – not used.
- Supply LED - is lit when DC power is applied. Fast Flashes when linked with PGM800Win. Slow Flashes indicates VCO (synthesizer) out of lock. Unequal Flashes indicates internal communication error.
- Microphone Socket – not used.

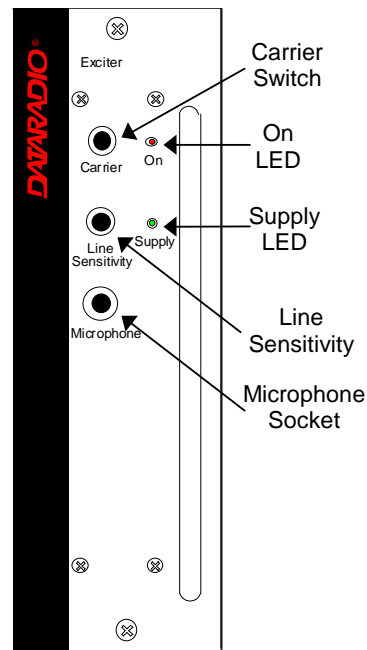

Figure 7 - Exciter module, front panel

### 3.1.1.3 Power Amp module

The Power Amp front panel and indicators are:

- Supply LED - is lit when DC power is applied.
- Low Forward Power LED - is lit when forward power is below the level set, normally 80% of nominal forward power.
- High Reverse Power LED - is lit when high reverse power is detected (e.g. VSWR= 3:1).
- Power - sets the PA output power:
  - VHF & UHF models: 20 - 100 Watts
  - 800 model: 20-70 Watts

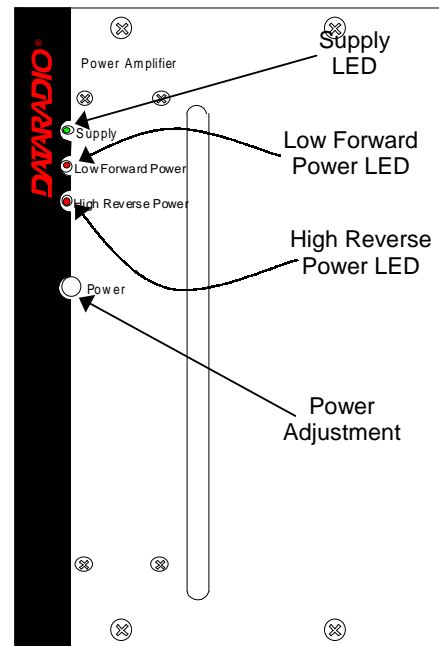

Figure 8 - Power Amp module, front panel

### 3.1.1.4 Speaker panel

The speaker panel is fitted with a four-Ω speaker.

Both series of radio assemblies share the same front panel fitted with an RJ11 connector. This connector is used to allow programming the radio from the front of the unit via a programming lead. This feature is exclusive to the Series II modules.

If the speaker panel needs to be removed, a mirror programming port connector is provided on the backplane.

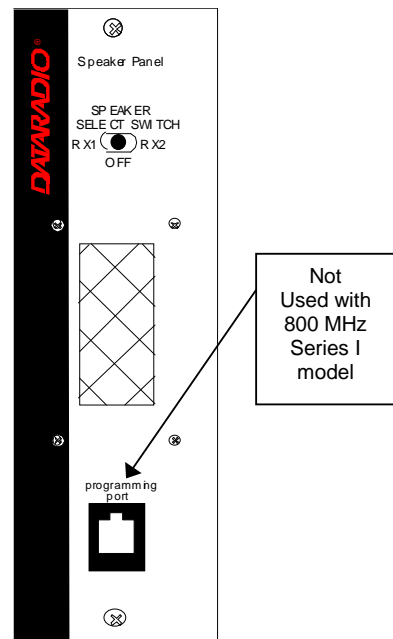

Figure 9 - Speaker panel

### 3.1.1.5 Dual Power Supply module

The Dual Power Supply module is made up of two separate power supply units coupled in a single chassis.

Refer to Table 2 on page 6 for tabular listing of power supply LEDs indicators. Refer to Figure 1 for the front panel LED layout.

This module has:

- Two ‘Power’ red-colored pushbutton switches - Push in for ON and release out for OFF. Control complete power distribution to the Radio assembly
- Two ‘ON’ LEDs - light green when push button(s) is (are) ON; DC power is distributed to radio modules. Flash green in conjunction with the ‘OL’ LED (flashing red) when an over voltage condition is present.
- Two ‘Stby’- Standby voltage LED, lights red when push button is off; AC power is applied but DC is not distributed to radio modules. To remove presence of voltage, disconnect both power cords.
- Two ‘OL’ LEDs - Monitor current overload, light steady red when supply exceeds current limit set; nominally 25Amps (T808 model). Flashes red in conjunction with the ON LED (flashing green) when an over voltage condition is present.

### 3.1.1.5.1 Rear Connections

The rear connections (convection-cooled model shown; fan-cooled model not illustrated) for each of the power supply are:

#### Fail Alarm –

Off: Power supply OK; approx. +Vout (via 1k resistor - typ. 13.8V).

ON: Power supply failure; approx. -Vout (via 11k resistors - typ. 0V)

+ **Remote** – Not used for Paragon

- **Sense** – Not used for Paragon

-**VE** – main ground (0V)

+**13.8V** – Mains DC output supply

*Note: more power supply installation details are covered in section 1.1.1*

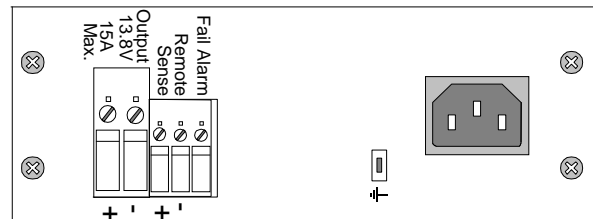

Figure 10 - Dual Power Supply rear connections

## 3.1.2 Radio Assembly, rear panel

### 3.1.2.1 Backplane PCB

Referring to Figure 3, two main backplanes are used. Their main components are:

- RJ11 connector – Mirrors the one on the front of the Speaker panel (series connected to both backplanes). Used for programming the Radio Assembly whenever the speaker panel has been removed.
- DB-25M plug at PL1 (one side of the “Y” cable on each PCB) – used to supply the receive signal to the BDLC<sup>PD+</sup>'s single ‘EXT.RADIO/TEST’ DB-25F plug.
- Two channel-select DIP switches (SW1 and SW2)

*This feature is exclusive to the Series II model.*

- Cooling fan driver – CN2 located on backplane connects to the horizontally-mounted fan on top of the Radio assembly and activated by BDLC's *PTT* signal.
- Coaxial relay driver – not used.

## 3.2 BDLC<sup>PD+</sup>

The rack-mounted BDLC<sup>PD+</sup> is housed in a steel case. It has no user serviceable parts. Unit's configuration is stored in flash memory (EEPROM).

### 3.2.1 BDLC<sup>PD+</sup> Front panel

Referring to Figure 2, the front panel of the BDLC<sup>PD+</sup> has two cutouts across its length.

A- The *left* cutout groups the unit's type label and ten LED indicators:

- The S3 label designates the BDLC<sup>PD+</sup> as a ‘three Serial-port’ model (*Ports 4 and 5 are reserved for future use*)
- The RF group of 3 LEDs
- The RS-232 group of 5 LEDs
- A single CK LED

- The ALARMS group of 4 LEDs

B- The *right* cutout groups two tactile (membrane) switches (PF1 and RESET).

### 3.2.1.1 Front Switches

The BDLC<sup>PD+</sup> uses two membrane-type switches labeled:

- RESET
- PF 1

These switches indicate contact by emitting a short BEEP tone when pressed.

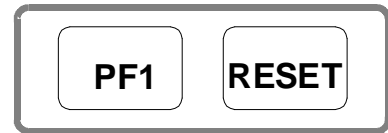

Figure 11 - BDLC<sup>PD+</sup> membrane switches

#### 3.2.1.1.1 Reset

Pressing Reset produces the same result as powering OFF and ON again. It restarts the microprocessor, the peripherals and invokes the on-board diagnostics. BDLC<sup>PD+</sup>'s radio modules' internal flash-memories are read and their values are loaded in system SRAM CPU flash-memory.

Normally, pressing Reset results in one short BEEP tone followed by all LEDs coming ON for about four seconds. Then, the LEDs flash in a 'ripple' pattern for close to two seconds indicating diagnostics are in progress. At the end of this period, all LEDs should be OFF except CK that should flash about six to eight times per second.

Expect an additional two seconds delay for CK to start flashing and the UF indicator to come ON if the radio assembly is not connected or not powered (see section 3.2.1.5.4 for Alarm details).

#### 3.2.1.1.2 PF 1

PF 1 is a multi-function switch:

- It clears LED error indications
- It initiates test transmissions
- It sets the function of the RS-232 LEDs

#### 3.2.1.2 Clearing Errors

Major and minor error LED indications remain lit on the front panel until:

- The unit is RESET
- The unit is powered OFF and ON again
- PF 1 is pressed

The PF 1 switch can be pressed at any time to clear an error display without affecting normal operations.

#### 3.2.1.3 Test Transmissions

To select a pattern and begin transmission, start by pressing and holding PF1. It beeps once, all five RS232 LEDs light; listen for a second beep followed by a third beep. After two seconds, the unit beeps and goes in "TX Select" mode with only the three rightmost RS-232 LEDs now used as selection indicators. Only release PF1 after the third beep.

Following release:

- Start of selection must be made within two seconds. If not, the unit will default to pattern one and start test transmitting.

- PF1 may be pressed more than once. The number of times it is pressed determines the type of pattern that will be transmitted according to Table 4.
- Each pressing of PF1 extends the two-second timer.
- The three rightmost RS-232 LEDs are used to indicate TX mode selection as shown in Table 3.

Table 3 - TX mode selection LEDs indications

TX pattern selected	Binary TX mode LED indications		
	FT LED	RD LED	TD LED
1	Off	Off	On
2	Off	On	Off
3	Off	On	On
4	On	Off	Off
5	On	Off	On
6	On	On	Off
7	On	On	On

Table 4 - Test Transmissions

# times PF1 is pressed	DGMSK Paragon <sup>PD+</sup>		
	8000 b/s	9600 b/s	19200 b/s
1	2000 Hz Dotting	2400 Hz Dotting	4800 Hz Dotting
2	4000 Hz	4800 Hz	9600 Hz
3	100 Hz Square wave		
4	Random data	Random data	Random data
5	Unmod	Unmod	Unmod
6	1000 Hz sine beacon mode	1000 Hz sine beacon mode	1000 Hz sine beacon mode
7	1000 Hz sine wave Adjustment tone		

# times PF1 is pressed	xRC4FSK Paragon <sup>PD+</sup> / xRC8FSK Paragon <sup>PD+</sup>				
	32000 b/s / 48000 b/s	25600 b/s / 43200 b/s	19200 b/s / 28800 b/s	16000 b/s / 24000 b/s	14400 b/s / 21600 b/s
1	4000 Hz Dotting*	3200 Hz / 3600 Hz Dotting*	2400 Hz Dotting*	2000 Hz Dotting*	1800 Hz Dotting*
2	Do not use	Do not use	Do not use	Do not use	Do not use
3	100 Hz Square wave	100 Hz Square wave	100 Hz Square wave	100 Hz Square wave	100 Hz Square wave
4	Random data	Random data	Random data	Random data	Random data
5	Unmod	Unmod	Unmod	Unmod	Unmod
6	1000 Hz sine beacon mode	1000 Hz sine beacon mode	1000 Hz sine beacon mode	1000 Hz sine beacon mode	1000 Hz sine beacon mode
7	1000 Hz sine wave Adj. tone	1000 Hz sine wave Adj. tone	1000 Hz sine wave Adj. tone	1000 Hz sine wave Adj. tone	1000 Hz sine wave Adj. tone

\* Dotting with reduced amplitude

Notes:

- For DGMSK models, a dotting pattern consists of an alternating series of bits.
- For the xRC4FSK models, a dotting pattern consists of an alternating series of bits where only the lowest-level symbol's modulation is used.
- The square wave is used to check transmitter low frequency balance..
- Pattern 6 produces a transmission of approximately 55 seconds followed by about 55 seconds of silence. Initial transmission in a sequence may be shorter than 55 seconds. TX LED stays steadily red for duration of the test. Press PF1 to terminate beacon mode.

Once the type of transmission is selected, stop pressing PF1, allow the two-seconds timer to run down. Automatically, the BDLC<sup>PD+</sup> turns its transmitter ON, sends the selected "test pattern" for 55 seconds,

and turns its transmitter OFF. The TX LED in the RF group of indicators lights in red while test transmitting. Pressing PF1 while the 55 seconds test is in progress stops the test. At the end of test transmission, BDLC<sup>PD+</sup> operation returns to normal and the RX LED lights in green (monitoring normal transmitter activity).

### 3.2.1.4 RS-232 LED Function Selection

The PF 1 button is used to select the RS-232 display mode as follows:

- If pressed *ONCE* (do not hold pressed):
  - Clears Alarm indications
  - CK LED stops flashing for 2 seconds
  - During this time, one or all of the RS-232 numbered LEDs (see Figure 13) will light. If one LED lights, it denotes the port to which the subsequent display applies. If all numbered LEDs light, it denotes that the normal 3-port display mode is active.

The selected display remains active until manually changed or until RESET is pressed or until power up.

Table 5 - RS-232 LED Function Selection Sequence

RS-232 LED Function Selection Sequence	
ALL	TX LED in RF group lights with any and all transmission
1	
2	
3	
4 (reserved)	
5 (reserved)	
ALL	TX LED in RF group only lights with an ACK or DATA transmission
1	
2	
3	
4 (reserved)	
5 (reserved)	

- If, during the 2 seconds period that CK is not flashing, PF 1 is pressed a second time, the LED functions will advance one step from top to bottom through the available options in the order shown in Table 5.
- PF 1 may be pressed repeatedly during the 2 second period (extended with each press) to advance to the desired numbered LED function option.

Once the desired RS-232 LED function is selected, stop pressing PF1, allow the two-seconds timer to run down. The BDLC<sup>PD+</sup> returns to normal operation using the newly selected display.

### 3.2.1.5 LEDs and Indications

LEDs are used to indicate the operation status of the BDLC<sup>PD+</sup>. Although capable of displaying three colors, only the green and red colors are used for the BDLC<sup>PD+</sup>. They are grouped by their function:

- RF Group, displays radio channel status in green
- RS-232 Group, displays serial port status in green except the TX LED that also uses red
- ALARM Group, displays fault status in red

### 3.2.1.5.1 Radio Network Indicators

The Radio Network LEDs are useful when troubleshooting as an indication of network activity. It can help isolate transmission problems.

**CS** Carrier Sense - Steady light indicates that an incoming radio data signal is being detected by the DSP modem. CS signal is not user-adjustable.

**RX** Receive Data – Flashing light indicates unit is internally receiving data from the radio network.

**TX** Transmitter ON – blinks green indicates (depending on display mode selected):

- That a data packet or ACK (packet acknowledgment) is being transmitted.
- That an idle packet, data packet or ACK is being sent. *Test transmission display is done in red.*

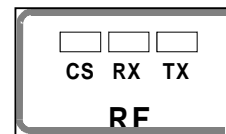

Figure 12 - RF indicators

### 3.2.1.5.2 RS-232 Port Indicators

The RS-232 LEDs normally indicate port activity on the port selected. See section 3.2.1.4 above for instructions for selecting display mode.

**CM** Command Mode - LED lights and remains lit while the selected port is accessing the Command Processor. It lights ON and OFF while being configured.

**FR** Flow Control on Receive - the BDLC<sup>PD+</sup> has received a flow control signal from the device connected to it. When it lights, BDLC<sup>PD+</sup> has stopped sending data to the DTE. When LED goes out, the port terminal is again ready to receive data.

**FT** Flow Control on Transmit - the BDLC<sup>PD+</sup> has sent a flow control signal to the DTE asking it to stop sending data. The LED remains lit as long as the terminal is being held off.

**RD** Receive Data - when lit, it shows that the Receive Data pin 3 on the RS-232 interface connector is active. Since all BDLC<sup>PD+</sup> are configured as DCE, it means that the DTE is receiving data from the BDLC<sup>PD+</sup>.

**TD** Transmit Data - shows the status of Transmit Data pin 2 of the RS-232 interface. When lit, the DTE is sending data to the BDLC<sup>PD+</sup>.

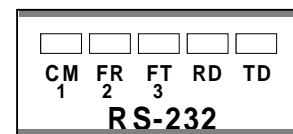

Figure 13 - RS-232 LED Port indicators

### 3.2.1.5.3 Check and Power LEDs

**CK** Check:

Normally flashing rapidly (about 6 cps), indicates microprocessors are working correctly and power is applied.

Not flashing indicates unit is not functioning.

Blinking slowly (1 cps), indicates the parameters contents of the flash memory have been corrupted. The unit automatically loads its set of factory default parameters and starts beeping at 20 seconds intervals.

May also indicate DSP-modem re-initialization has occurred

#### 3.2.1.5.4 Alarm Indicators

All alarm conditions will cause the BDLC<sup>PD+</sup> to light one or more of the LED indicators. LEDs remain ON when lit until cleared by either pressing PF 1 (without affecting operation of the unit) or RESET (cycling unit OFF and ON).

**LM** Local Minor Alarm - when lit, indicates the presence of any of the following minor faults:

- Parity, framing or overrun error at any RS-232 port.
- Out of buffers. No memory available to accept data from a local terminal device. Usually denotes a flow control problem.
- Flash memory error. At power-up or reset, the unit detected a change in non-volatile memory.

**RM** Remote Minor Alarm - when lit, indicates any of the Local Minor Alarm listed above have taken place at the remote end of the link (i.e. the mobile the local base station is currently communicating with). It will also light when a protocol error has been detected on the network.

In a network using the "Host Link Active" (MSC) feature, the RM LED, flashing in-sync with the CK LED, indicates that the link is down.

**LF** Link Failure - when lit, indicates that the base station fails to receive an ACK for a packet sent and for all subsequent retries. Some data has possibly been lost. LF is not functional if all active ports are set to NAR mode.

Link fails are inevitable during normal operation (mobiles temporarily out of range, in a tunnel, parked in a dead spot, etc.). A lit LF LED is not normally cause for concern.

**UF** Unit Failure - when lit, the unit requires attention:

- The BDLC<sup>PD+</sup> is not operable;

It may indicate detection of a system software error trap.

- The BDLC<sup>PD+</sup> is operable;

Indicates that on power-up, invalid data was detected in the serial EEPROM chip (located in the radio modules). It may also indicate that connection to the radio modules is incorrect or that radio power is not applied.

The **LM**, **RM** and **UF** alarms also sound a beep when a fault occurs. The **LF** alarm is silent.

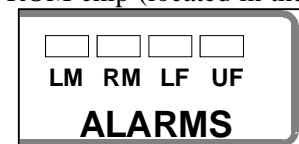

Figure 14 - ALARMS LED indicators

#### 3.2.2 BDLC<sup>PD+</sup> Rear panel

Referring to Figure 4, the rear panel of the BDLC<sup>PD+</sup> has the following set of chassis connectors:

- One DB-25F connector
  - DEV1 - Connects to user's application.
    - a) DMP 19200 or 38400 baud for single-site installations
    - b) MSCP 19200 or 38400 baud for multi-site installations
- Four DE-9F connectors:
  - DEV2 - usually connected to Dataradio's WinRIS program (Dedicated or DMP at 19200 baud).
  - DEV3 - Dedicated (up-to 9600 baud)
  - DEV4 and DEV5 - not used
- One DA-15M connector:



- DEV6 Digital I/O - not used
- One DB-25M connector:
  - EXT RADIO/TEST - connects to the Radio assembly through the radio interface cable (see Figure 15)

### 3.2.2.1 RS-232 Signal Levels

In the description of data signals in Table 8, the following conventions are used:

Table 6 - RS-232 Signal levels

Term	Alternates	Signal level
ON	Asserted, spacing	+3 to +15 V
OFF	Dropped, marking	-3 to -15 V

### 3.2.2.2 Pin Functions

Table 7 - DTE Port 9-pin functions

DE-9 F pin #	Function (RS-232 signal levels)
1	DCD – from Paragon <sup>PD+</sup> , normally asserted
2	RXD – data from Paragon <sup>PD+</sup>
3	TXD – data to Paragon <sup>PD+</sup>
4	DTR – to Paragon <sup>PD+</sup> , handshaking
5	Ground
6	DSR – from Paragon <sup>PD+</sup> , tied to VCC through current limiting resistor
7	RTS - to Paragon <sup>PD+</sup> , handshaking
8	CTS – from Paragon <sup>PD+</sup> , handshaking
9	Reserved

Table 8 - DTE Port 25-pin functions

DB-25F pin #	Function (RS-232 signal levels)
1 and 7	Ground
2	TXD – data to BDLC <sup>PD+</sup>
3	RXD – data from BDLC <sup>PD+</sup>
4	RTS – to BDLC <sup>PD+</sup> , must be asserted
5	CTS – from BDLC <sup>PD+</sup> , handshaking
6	DSR – from BDLC <sup>PD+</sup> , always +8V
8	DCD – from BDLC <sup>PD+</sup> , always asserted
9	RI - from BDLC <sup>PD+</sup> , always -8V
20	DTR – to BDLC <sup>PD+</sup> , handshaking

We recommend the use of shielded 9-wire or 25-wire cables with all pins connected.

Dataradio recommends the use of secure (i.e. password protected and/or dial-back) modems in any installation where dialup access is provided.

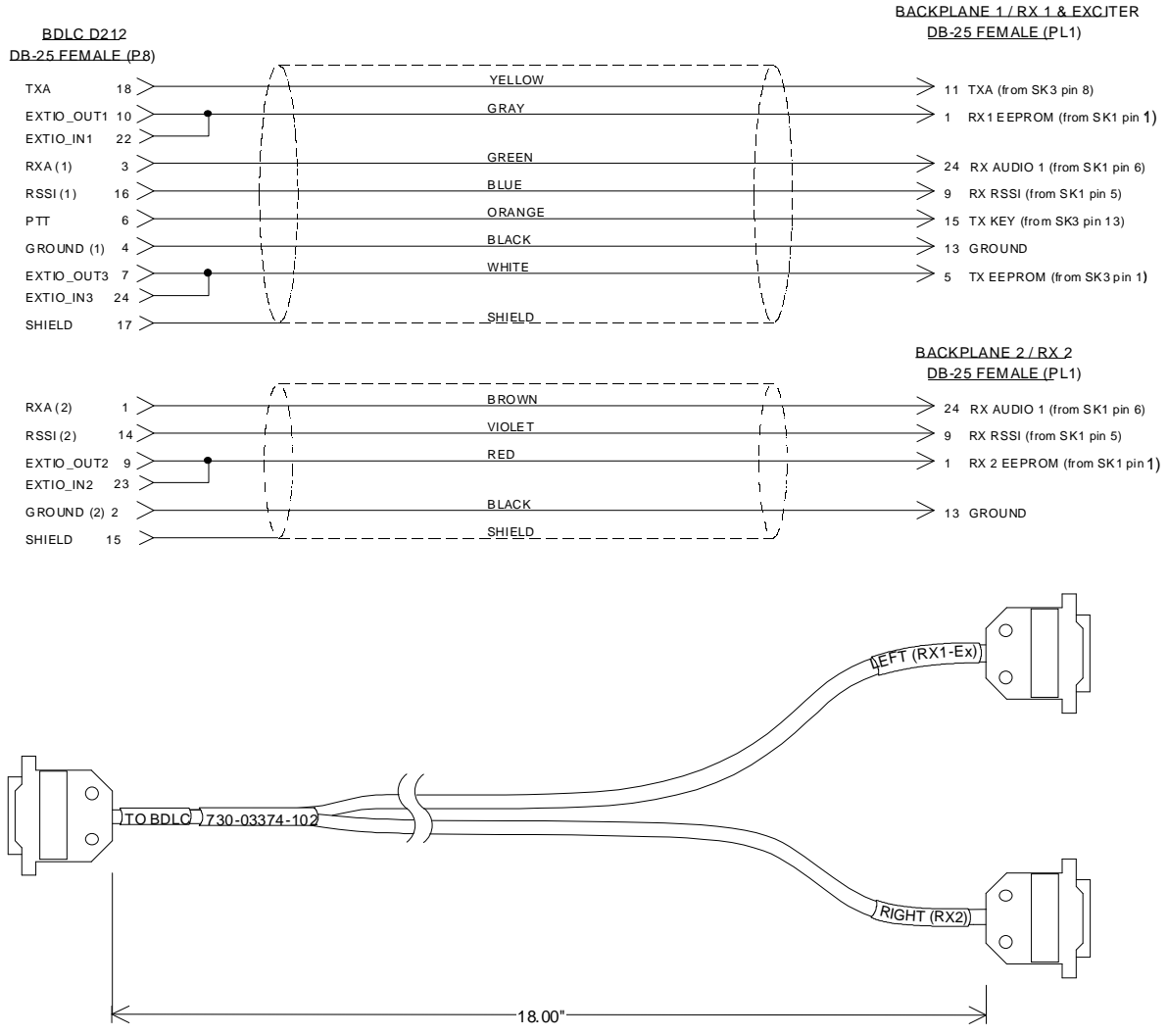

Figure 15 - BDL C<sup>PD+</sup> Y cable and pinout

## 4. Trouble-Shooting and Testing

The checks described below should be done at time of installation, annual intervals, or whenever deterioration in performance is noted.

### 4.1 Equipment Required

- In-line watt meter (150W & 10 W ranges)
- Radio service monitor (IFR-120B with option 03: 30KHz IF filter or equivalent).
- RG-214 or RG-223 cable with N-Type male connector to connect Paragon<sup>PD+</sup> to the service monitor.
- WinRIS 3.11 or later<sup>1</sup>

***Important note: Before proceeding make sure that the service monitor has been calibrated recently and has warmed up for at least the time specified by its manufacturer.***

*Some reported frequency and deviation problems have actually been erroneous indications from service monitors that have not adequately warmed up. This is particularly likely when field service is done during winter months.*

---

<sup>1</sup> To learn how to launch the Windows-based software alignment and system-testing tool **WinRIS**, please refer to the readme.txt file on the application's installation diskette.

For functional details of the numerous buttons and menu-selectable items available, please refer to the program's context sensitive help. It is also possible to access the help information via the F1 key.

## 4.2 Recommended Checks

### A) After an installation

1. LED Indications
2. Using WinRIS, Save "unit config" to a file
3. Transmitter Output Power
4. Transmitter Reflected Power
5. RF Link test between Paragon<sup>PD+</sup> and mobile unit(s)

### B) For annual maintenance & trouble-shooting

Same checks as A) plus:

6. Carrier Frequency Error
7. TX Deviation
8. Low Frequency Balance
9. 12 dB SINAD
10. Receiver distortion
11. RSSI check

Transmissions for some of the tests above can be initiated by pressing the PF1 membrane button located on the front of the BDLC<sup>PD+</sup>. For details on its use, refer to Table 4 and section 3.2.1.3 on page 14.

Table 9 - Checklist A (after installation)

<b>CHECKLIST A</b> <b>(Paragon<sup>PD+</sup>)</b> Recommended Check out after Installation				
Step	ACTION	EXPECTED RESULTS at 25°C	MEASURE WITH	IF NOT?
1	<b>Normal Power-up Sequence</b>	BDLC <sup>PD+</sup> beeps once, all LEDs come ON for about four seconds, the green LEDs then flash in a “ripple” pattern for close to two seconds. All LEDs go OFF except the CK that should flash 6 to 8 times per second. For functions, see section 3.2.1.5		
2	<b>Connect and save unit config</b> Press WinRIS <b>Get</b> button	as per WinRIS Help content		
3	<b>Transmitter Output Power</b> Press <b>TXON (Unmod)</b>	<b>VHF/UHF:</b> 20 - 100 watts <b>800 MHz:</b> 20 - 70 watts <b>900 MHz:</b> 65 - 100 watts +10%, -10%	Service monitor set to read power or 150W in-line wattmeter installed as close as possible to the unit antenna connector.	<sup>1</sup> Check for bad connections, damaged coax cable, etc.
4	<b>Transmitter Reflected Power</b> Press <b>TXON (Unmod)</b>	< 5% of forward power or as specified by System Engineering.	10W in-line wattmeter	Check for bad connections, damaged coax cable, etc.
5	<b>RF Link test</b> Use the mobile address function and “Send” button to dynamically test the link	Look for “Delivery confirmed” on the Status bar	Refer to 4.3.1 and to WinRIS Help content.	Mobile is out of range Refer to factory technical support.

<sup>1</sup> (unless unit has been set a lower value). Note that readings less than 100 watts for VHF/UHF or 70 watts for 800 MHz models, may be due to losses in cables used for testing. Check also your wattmeter frequency calibration curve. Do not be too ready to condemn the transmitter or the RF feedline & antenna installation.

Table 10 - Checklist B (General)

CHECKLIST B (Paragon <sup>PD+</sup> ) General Check out (part1 of 2)				
<p>Paragon<sup>PD+</sup> units are set and characterized at the factory to optimize performances. It is <b>not recommended</b> to try readjusting units unless it is really required. Misadjusting a unit may result in significant performance losses.</p> <p><b>The proposed adjustments in the "IF NOT?" column below, should be tried ONLY if system data performance degradation is noticed combined with out-of-tolerance items.</b></p>				
Step	ACTION	Expected Results at 25°C	MEASURE WITH	IF NOT?
1	<b>Normal Power-up Sequence</b>	BDLC <sup>PD+</sup> beeps once, all LEDs come ON for about four seconds, the green LEDs then flash in a "ripple" pattern for close to two seconds. All LEDs go OFF except the CK that should flash 6 to 8 times per second. For functions, see section 3.2.1.5		
2	<b>Connect and save unit config</b> Press WinRIS <b>Get</b> button	as per WinRIS Help content		
3	<b>Transmitter Output Power</b> Press <b>TX ON (Unmod)</b>	<b>VHF/UHF:</b> 20 - 100 watts <b>800 MHz:</b> 20 - 70 watts <b>900 MHz:</b> 65 - 100 watts +10%, -10%	Service monitor set to read power or 150W in-line wattmeter installed as close as possible to the unit antenna connector.	Adjust "Power" on the front panel of the "Power Amp" ( see Figure 8)
4	<b>Transmitter Reflected Power</b> Press <b>TXON (Unmod)</b>	< 5% of forward power or as specified by System Engineering.	10 W in-line wattmeter	Check for bad connections, damaged coax cable, etc.
5	<b>Carrier Frequency Error</b> Press <b>TX (Unmod)</b>	< ±300 Hz	Service monitor set to read frequency error	Adjust TCXO (IC700) (see inside Exciter module at, Figure 28 (800), Figure 30 (UHF), Figure 32 (VHF) )
6	<b>TX Deviation (KHz)</b> Press <b>TX (Unmod)</b> Carrier will be modulated with a 1 kHz tone.	Refer to " <i>Figure 16 - Carrier deviations for Tone or Data Modulation</i> " per bit rates <b>Tolerance is +5%, -10% for all bit rates.</b>	Service monitor set to read deviation. (IF filter set to Mid or 30 kHz position)	Adjust according to <b>Appendix 1 - ParagonPD+ Deviation adjust</b> on page 48
7	<b>Low Frequency Balance</b> Initiate a <b>TX Random data test</b> via BDLC <sup>PD+</sup> 's PF1 (See Table 4)	a) Record deviation level read from step 6 b) Record deviation read from <b>TX Random test</b> c) Difference between a) and b) should be: < 600 Hz (DGMSK) < 1.5 kHz (xRC4FSK, xRC8FSK, HC) < 2.0 kHz (xRC4FSK, xRC8FSK, FC/NPSPAC)	Service monitor set to read deviation (IF filter set to Mid or 30 kHz position, all audio filtering disabled )	Refer to Section 5.2.3.4

CHECKLIST B (Paragon <sup>PD+</sup> )				
General Check out (part2 of 2)				
<p>Paragon<sup>PD+</sup> units are set and characterized at the factory to optimize performances.  It is <b>not recommended</b> to try readjusting units unless it is really required.  Misadjusting unit may result in significant performance losses.</p> <p><b>The proposed adjustments in the "IF NOT?" column below, should be tried ONLY if system data performance degradation is noticed combined with out of tolerance items.</b></p>				
Step	ACTION	EXPECTED RESULTS at 25°C	MEASURE WITH	IF NOT?
Set the service monitor to generate on the selected receive frequency. Verify alternately for both receivers. The carrier should be modulated with a 1.0 kHz tone at deviation level specified below:				
8	<b>12 dB SINAD</b> (Dataradio wide band measurement method: no audio filtering) - For Full channel unit, set deviation to ±3 kHz. - For Half & NPSPAC channel unit, set deviation to ±1.5 kHz	Better than -108 dBm including cable loss (Typically -109 to -110 dBm)	- Backplane corresponding to the receiver being verified: SK1, Pin 6 (see Figure 24) - Service monitor (IFR) set to SINAD - IFR IF filter set to MID position or 30 kHz wide filter.	Refer to section 5.2.2
9	<b>Receiver distortion</b> (Dataradio wide band measurement method: no audio filtering) - Set service monitor RF Gen output to – 70 dBm - Deviation level as per SINAD above.	≤ 5.5 % (Typically < 3.5 %)	- Backplane corresponding to the receiver being verified: SK1, Pin 6 (see Figure 24) - Service monitor (IFR) set to SINAD - IFR IF filter set to MID position or 30 kHz wide filter.	Refer to section 5.2.2
10	<b>RSSI</b> Apply to each receiver input the following RF level UHF & 800/900Mhz: -110dBm VHF: -100 dBm	<b>UHF &amp; 800 MHz:</b> 2.0 VDC (+/- 0.3VDC) <b>VHF:</b> 4.0 VDC (+/- 0.35VDC) Note: BDLC must be connected to the radio during the measurements	- Backplane corresponding to the receiver being verified: SK1, Pin 5 (see Figure 24) - DC Voltmeter measurement	Refer to section 5.2.2.5 for all models. Refer to factory technical support only if RX data performance degradation is noticed combined with out of tolerance RSSI readings.

## 4.3 Additional test details

### 4.3.1 RF Data Link Test

A link test between a mobile and a known base station can be done using the WinRIS "Address" and "Send" functions. The "Address" and "Device" fields, the "Send" button and the "Chat" message screen are used to send messages to specific mobile or base or to carry out RF test. Start by entering the address of the mobile (or base station) you wish to send a test message to or test:

1- Specify the address:

Addresses may be entered by typing directly in the "Address" field in two ways:

- Numerically, the valid address range is 1-126.
- As an "Alpha-Mapped-Nibble" (AMN) address , consisting of upper case letters in the range A-P.  
The valid address range is A to GN.
- The base address is usually: 1.
- The program may display one of the following messages on the status bar:
  - **For Paragon<sup>PD+</sup> products:**  
"address is not in AMN or number fo rmat"
  - **For mobile products:**  
"address is not in the range A – GN"

In either case, check that the address entered is within the acceptable range, is of a valid format and correctly typed.

2- Enter the Device number for mobile (or base station).

3- Press the Send button.

The Chat window reports "Sent to xx m obile" (*where xx is mobile name*).

**If test is successful:**

Status line reports "Delivery confirmed."

**If test unsuccessful:**

Chat window reports "Wating",

Then the Status line reports "Delivery Failed".



### 4.3.2 Carrier deviations

Carrier Modulation								
DGMSK			xRC4FSK			xRC8FSK		
	Tone	Data		Tone	Data		Tone	Data
Network Speed (b/s)	Typical deviation in kHz (1000Hz test tone)	Maximum deviation in kHz	Network Speed (b/s)	Typical deviation in kHz (1000Hz test tone)	Maximum* deviation in kHz	Network Speed (b/s)	Typical deviation in kHz (1000Hz test tone)	Maximum* deviation in kHz
<b>Full Channel (800MHz)</b>								
19200	± 4.0	± 4.6	32000	± 3.6	± 5.6	48000	± 3.9	± 4.8
9600	± 3.0	± 3.6	25600	± 3.7	± 5.7	43200	± 4.5	± 5.7
<b>Full Channel (VHF/UHF)</b>								
19200	± 4.0	± 4.6	32000	± 4.3	± 6.3	48000	± 4.5	± 6.2
9600	± 3.0	± 3.6	25600	± 4.0	± 6.0	43200	± 4.3	± 6.0
<b>NPSPAC Channel (800MHz - U.S. only)</b>								
8000	± 2.5	± 3.1	16000	± 2.4	± 3.9	28800	± 3.5	± 3.2
9600	± 2.5	± 3.1	19200	± 2.1	± 3.6	24000	± 3.3	± 4.6
<b>900MHz Channel ( U.S. only)</b>								
8000	± 2.8	± 3.4	16000	± 2.4	± 3.9	28800	± 3.0	± 4.2
9600	± 3.2	± 3.9	19200	± 2.4	± 3.8	24000	± 3.2	± 4.6
						21600	± 3.5	± 5.0
<b>Half-Channel (VHF/UHF &amp; 800MHz)</b>								
8000	± 1.5	± 2.1	14400	± 2.0	± 3.6	24000	± 2.5	± 3.3
9600	± 2.5	± 3.1	16000	± 1.6	± 3.2	21600	± 2.8	± 3.8
* Data deviation shown may seem higher than tone deviation, however they fall within the appropriate FCC / IC's masks limits								

Figure 16 - Carrier deviations for Tone or Data Modulation

## 5. Radio Programming and Adjustments

All receiver procedures detailed in this section should be done twice: once for the ‘Main’ (or RX1) receiver module and a second time for the ‘Auxiliary’ (or RX2) receiver module. Connect to the relevant module and its corresponding backplane PCB as required.

### 5.1 Series II Radio Programming

This procedure describes the steps needed to program the Paragon<sup>PD+</sup> base station UHF, VHF & 800MHz radios (half & full channels).

#### 5.1.1 Recommended Items

- 486 PC or better, MS-Windows 3.1 © or later
- T800win programming kit for Series II:
- PGM800Win programming software user's manual
- PGM800Win Windows based programming software
- T800-01-0002 programming cable (DB-25 to RJ-45 cable)
- Standard 25-pin parallel cable (terminated Male/Female)

#### 5.1.2 Module Programming

Before starting programming, have a PC running MS-Windows © and the Tait PGM800Win software for Series II Base station.

This program supports the use of a mouse but may be used without one if required. Keyboard access follows the conventional MS-Windows © method as briefly described below:

- Press and hold the ‘Alt’ key while pressing at the same time the relevant hotkey as indicated by an underlined letter on the menu command.
- On a drop-down menu, press only the hotkey without pressing the ‘Alt’ key.
- Use the ‘Tab’ key to cycle available fields and the ‘Enter’ key to validate entries. *E.g. Pressing ‘Alt’+F opens the File drop-down menu and pressing ‘A’ opens the Save As directory service box.*

**Receiver VCO and front-end alignment** will be required when new receiver frequency is programmed outside the radio tuning range:

800/900 =  $\pm 3.0$  MHz from previous center frequency

UHF =  $\pm 2.5$  MHz from previous center frequency.

VHF =  $\pm 1.5$  MHz from previous center frequency.

**Exciter and PA alignment** will be required when new transmitter frequency is programmed outside the radio tuning range:  $\pm 4$  MHz from previous center frequency.

1. Connect the PC, via the supplied programming lead, to the speaker panel's front-mounted RJ11 connector.
2. Run Tait PGM800Win program and follow instructions found in the T800 Programming Software User's Manual to select the proper module to be programmed.
3. Program required channel's frequencies.
  - Do not program any CTCSS tones on channels.
  - Do not change any other parameters.
  - Refer to Figure 17, Figure 18, Figure 19 and Figure 20 for screen program examples.
4. Save the base station programming info to a file for further reference.
- 5.

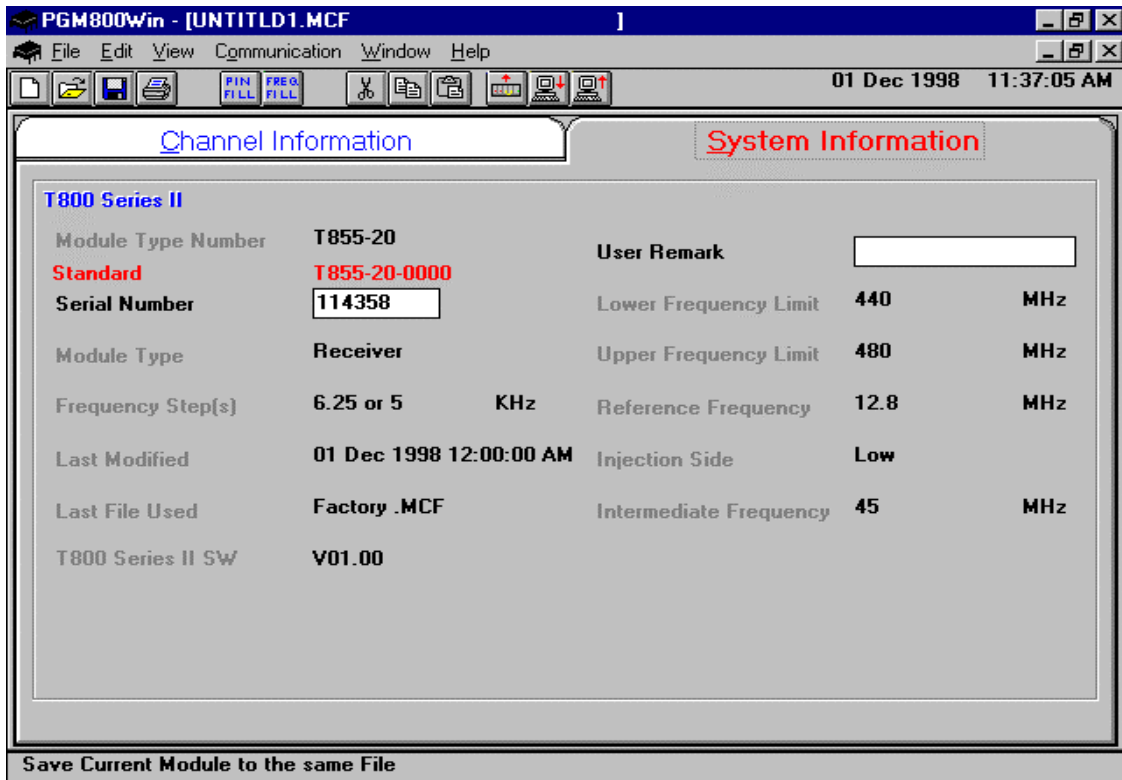

Figure 17 - Receiver System Information

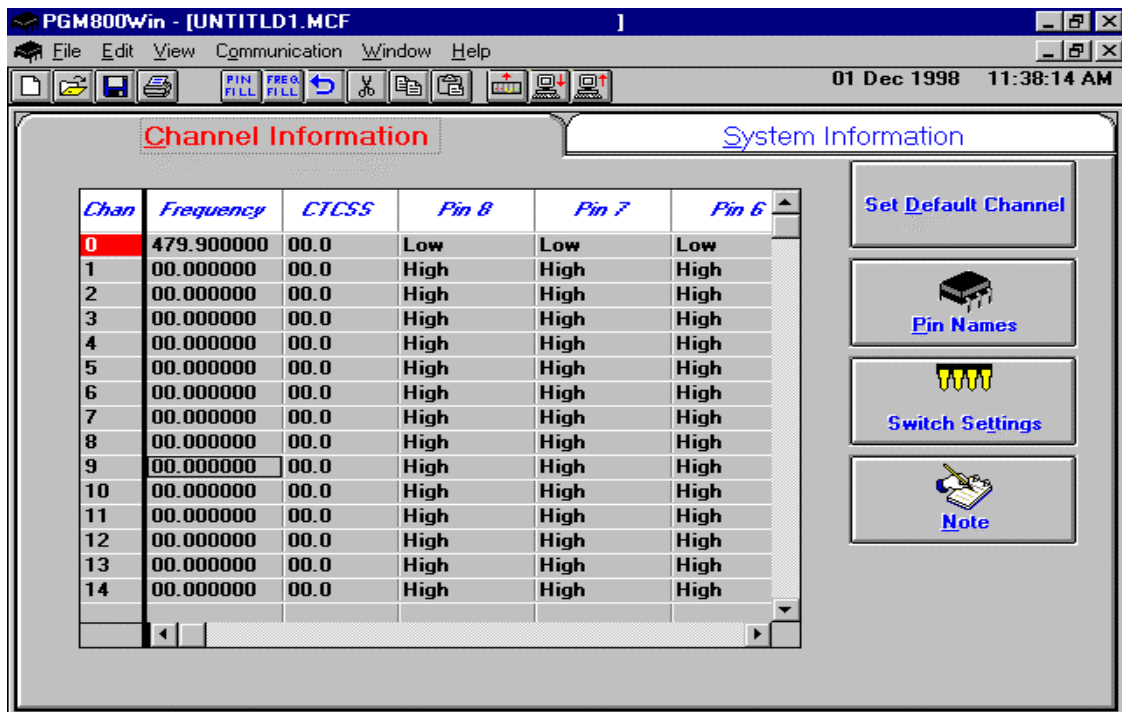

Figure 18 - Receiver Channel Information screen

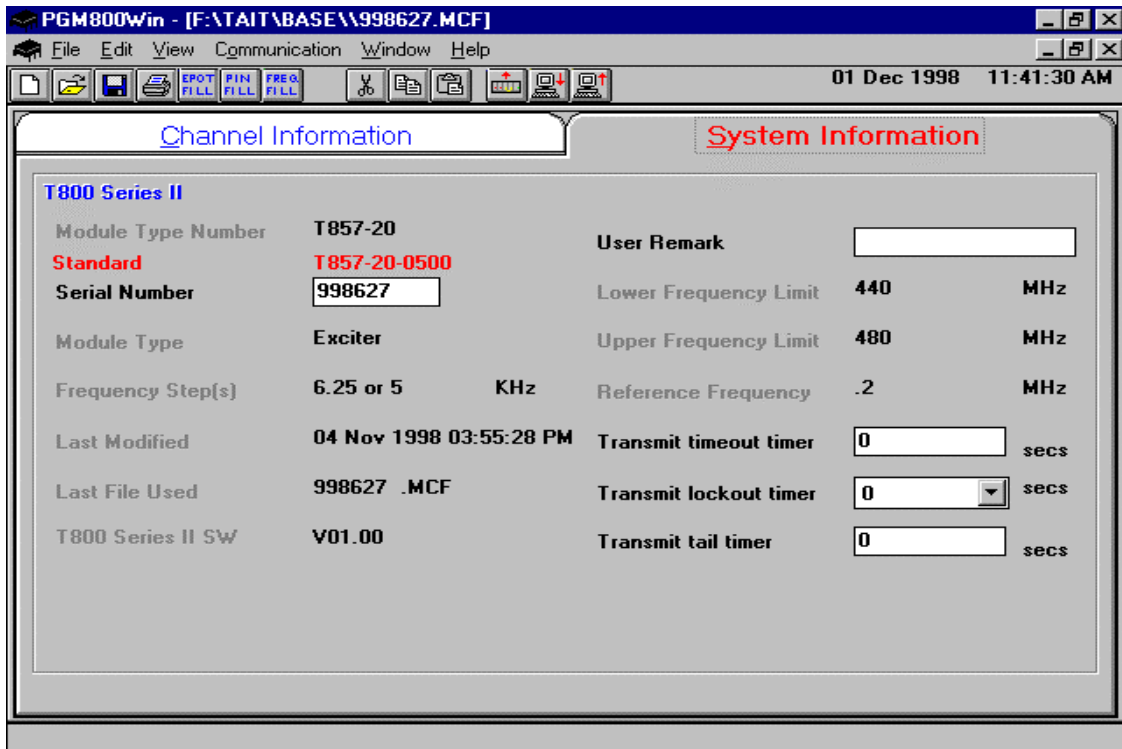

Figure 19 - Exciter System Information screen

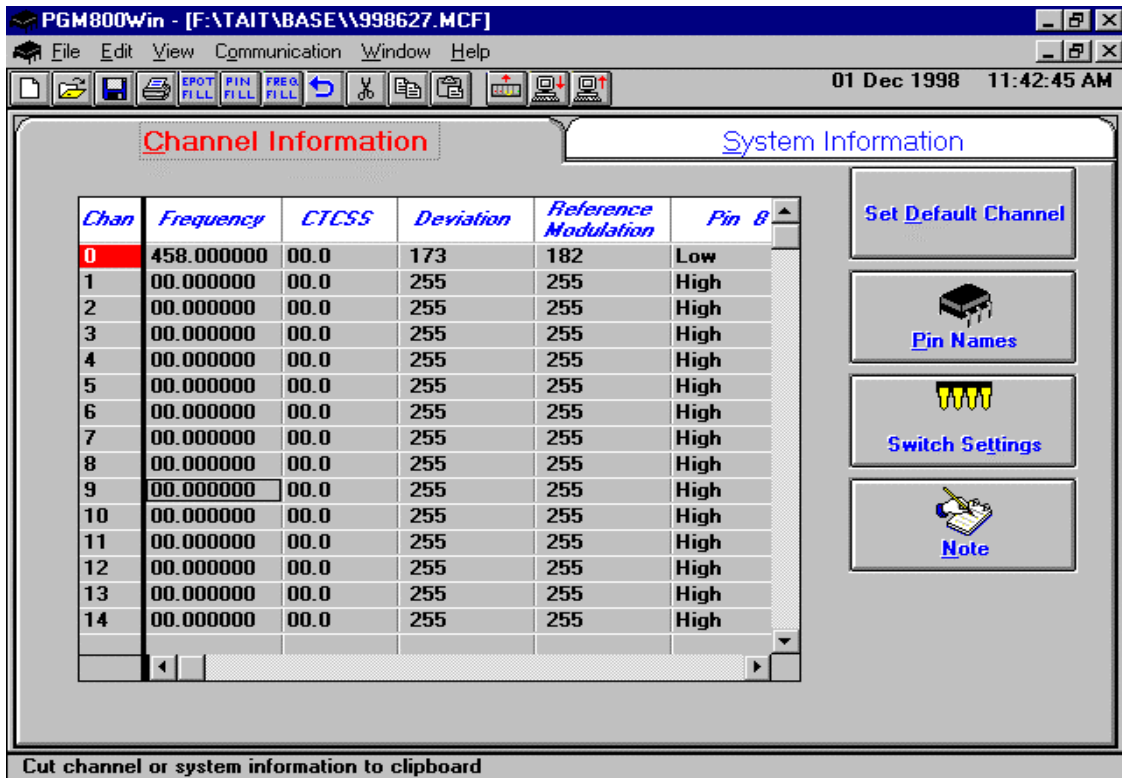

Figure 20 - Exciter Channel Information screen

### 5.1.3 Channel Selection via DIP Switches

The backplane-mounted DIP switch settings override the default channel programmed by PGM800Win.

To set a default channel via the software, all DIP switches must be set to ‘OFF’ (i.e. 00000000).

When a switch is ‘Off’, its binary count is active; when a switch is ‘ON’ its binary count is inactive. The various DIP switch combinations of ON or OFF make up a binary total, which identifies the channel number.

To select a channel, set the appropriate DIP switch or switches to ‘OFF’ to make the binary count total the channel number you want. Set all other switches to ‘ON’.

It is recommended to set both SW1 (RX) and SW2 (TX) to the same settings on both back plane boards.

Example: To select channel 5, set the DIP switches as shown below:

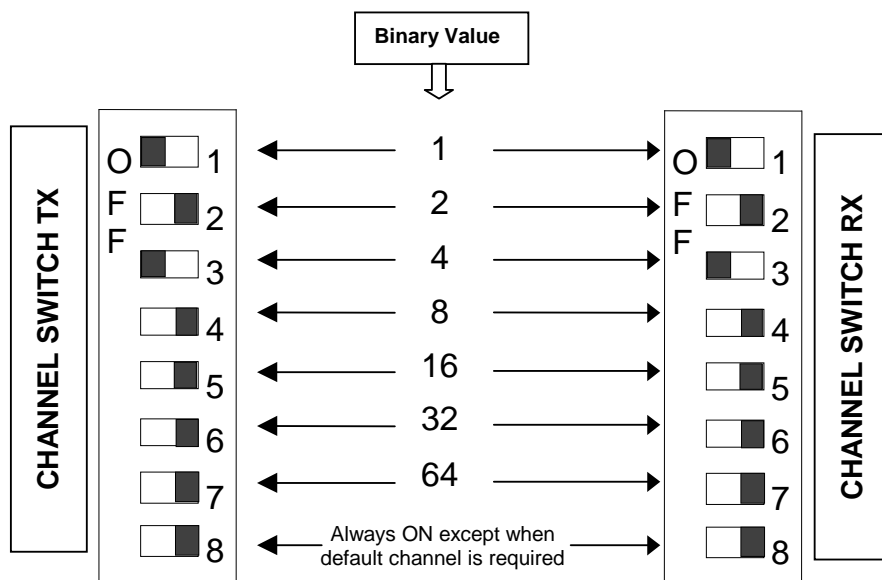

Figure 21 - Backplane DIP switches example - Channel 5 selected

## 5.2 Series II Radio Tuning

This section covers some basic Series II base station modules radio tuning and verification for:

- VHF (T83x-xx-0200),
- UHF (T85x-xx-0250) and
- 800 MHz/900 MHz (T88x-xx-0200).

**Note: Usually, this section is not done unless called for in section 5.1 “Series II - Radio Programming” or in Table 10 “Checklist B” (General).**

To identify the radio modules, check the part number on the manufacturer’s label at the back of the Receiver, Exciter and Power Amplifier modules:

RX	TX	PA
T885-10-0200 (800-870 MHz, 25kHz) T885-15-0200 (800-870 MHz, 12.5kHz & NPSPAC) T885-30-0200 (890-960 MHz, 25kHz) T885-35-0200 (890-960 MHz, 12.5kHz)	T881-1x-0200 (800-870 MHz) T881-1x-0200 (800-870 MHz) T881-3x-0200 (890-960 MHz) T881-3x-0200 (890-960 MHz)	T889-10 (850-870 MHz) TPL- PA8-2BF-LMS (890-960)
T855-10-0250 (400 - 440 MHz, 25kHz) T855-15-0250 (400 - 440 MHz, 12.5kHz) T855-20-0250 (440 - 480 MHz, 25kHz) T855-25-0250 (440 - 480 MHz, 12.5kHz) T855-30-0250 (480 - 530 MHz, 25kHz) T855-35-0250 (480 - 530 MHz, 12.5kHz)	T857-1x-0250 (400 - 440 MHz) T857-2x-0250 (440 - 480 MHz) T857-3x-0250 (480 - 520 MHz)	T859-10-0000 (400 - 440 MHz) T859-20-0000 (440 - 480 MHz) T859-30-0000 (480 - 520 MHz)
T835-10-0200 (136 - 156 MHz, 25kHz) T835-15-0200 (136 - 156 MHz, 12.5kHz) T835-20-0200 (148 - 174 MHz, 25kHz) T835-25-0200 (148 - 174 MHz, 12.5kHz)	T837-1x-0200 (136 - 156 MHz) T837-2x-0200 (148 - 174 MHz)	T839-10-0000 (136 - 156 MHz) T839-20-0000 (148 - 174 MHz)

### 5.2.1 Test Equipment

- Digital Multimeter & probes (e.g. Fluke 77)
- 1 HP 34330A Shunt 30A (UHF only, used for transmitter current measurement)
- Digital or Analog calibrated Oscilloscope & scope probes (X1, X10 selectable)
- Calibrated COM-120B (.001ppm OCXO and 30kHz IF options)
- 3-foot length of double-shielded N-M to BNC-M cable (RG-214 or RG-223)
- 2x ' BNC' to ' N' type adapters (e.g. Amphenol, Greenpar).
- Bird RF power meter with 150W / 50 ohm dummy load (optional)
- 3dB 150-watt attenuator
- 1x Torx screwdriver #T-10 and #T-20
- Pozidriv screwdriver #1 & #2
- 1x Six-inch adjustable wrench
- RF tuning/trimming tools.
- Extender Rail Kit for Series II chassis (T800-13-0000)
- 1x 6" coax cable N-M to BNC-M (comes with the radio to connect the exciter to the PA)

## 5.2.2 Receiver module (T885-xx-0200, T855-xx-0250 & T835-xx-0200)

Note 1: Refer to Figure 27 (T885), Figure 29 (T855) and to Figure 31 (T835) for locating tuning controls.

Note 2: When the synthesizer is unlocked, the front panel green LED called "Supply" will flash indicating that it needs re-tuning.

*Warning,*

*The LED will also flash when the unit is in setup mode while connected to the PGM800win program.*

### 5.2.2.1 Initial Setup

**This initial setup will be used during all receiver alignment procedures described below:**

1. Remove the receiver (T885, T855 or T835) module from the Paragon<sup>PD+</sup> rack frame
2. Remove the receiver top cover (nearest the handle).
3. Connect the Paragon<sup>PD+</sup> Extender Rail Kit for Series II to the empty chassis receiver slot.
4. Prepare the Multimeter to DC Volts.
5. Apply power to the Paragon<sup>PD+</sup>.

### 5.2.2.2 Synthesizer Alignment

Single channel: Connect the Multimeter to either side of L504 (T885) or the long lead of L1 (T855 and T835) in the VCO (this measures the synthesizer loop voltage).

1. T885 (800/900 MHz) Tune VCO trimmer CV500 for a synthesizer loop voltage of 10VDC.
2. T855 (UHF) Tune VCO trimmer C6 for a synthesizer loop voltage of 10V DC.
3. T835 (VHF). Tune VCO trimmer CV1 for a synthesizer loop voltage of 9VDC.

Multiple channels (adjusting as shown for single channel above):

1. T885 (800/900 MHz) Adjust the VCO loop to 10V using the middle frequency channel.
2. T855 (UHF) Adjust the VCO loop to 10V using the middle frequency channel.
3. T835 (VHF) Adjust the VCO loop to 9V using the middle frequency channel.
4. All channels should lie within the upper and lower limits of respectively

All channels should lie within the upper and lower limits of 16V and 3V respectively for the T885 and T855 or within 13V and 5V for the T835.



### 5.2.2.3 Front-End Alignment

1. IFR COM120B settings:
  - a) Connect a 3 feet long double shielded cable (N-M to BNC-M) between the IFR T/R output and the receiver antenna connector.
  - b) Select the generator mode (GEN button) and set to the main receiver channel frequency
  - c) Select and turn on GEN2
  - d) Set the FM Deviation to  $\pm 3\text{kHz}$  (full channel) or  $\pm 1.5\text{kHz}$  (half channel) using 1KHz sine
  - e) Select SINAD meter
  - f) Use a X1 scope probe connected to SINAD input and monitor the Discriminator O/P on the backplane at SK1 pin 6 (RX-audio1). Alternately, it is also possible to monitor at the receiver I/O Pad P207 (T885), the receiver TP314 (T855) or at the receiver IC350 pin 7 (T835).
2. Adjust the helical resonators for best SINAD: #H400, #H401 and #H900 (T885); #FL410 and #FL420 (T855) or L410, L420, L460 and L470 (T835).
3. Continually decrease the RF level to reach 12dB SINAD, then re-do step 2) & 3) again. The absolute minimum requirement level to reach is -108dBm (typical level is -109 to -110 dBm)
4. Perform the SINAD linearity tests described in paragraph 5.2.2.4. If it fails to pass the requirement, contact your Dataradio technical support.

#### ***WARNING: Do NOT attempt to re-tune the IF stages***

***(I.e. L300 and L301 for T885, L310 to L390 for T855 or L330 to L360 and CV318 for T835).***

***These adjustments do not need to be re-adjusted after frequency re-programming. Touching these coils will have a direct impact on the modem DSP ISI coefficient settings and may reduce significantly the radio performances over data.***

### 5.2.2.4 SINAD and Linearity Check

1. Apply the following settings to the IFR COM-120:
  - a) Generator mode, Output T/R, TX frequency to match the main radio RX frequency
  - b) Filter set to wide band (no audio filter)
  - c) Select Gen2 (Modulating tone fixed to 1KHz). All other Gen must be off.
  - d) Set deviation to  $\pm 3.0\text{KHz}$  for full channel or  $\pm 1.5\text{KHz}$  for half channel radios.
  - e) Use a X1 scope probe connected to the IFR SINAD input and monitor the Discriminator O/P on the radio backplane at SK1 pin 6 (RX-audio1). Alternately, it is also possible to monitor at the receiver I/O Pad P207 (T885), the receiver TP314 (T855) or at the receiver IC350 pin 7 (T835).
2. Lower the RF level to get a 12dB SINAD reading. Level should be better than -108dBm (including cable loss).
3. Offset the IFR TX frequency 2kHz (full channel) or 1kHz (half / NPSPAC channel) *above* the main radio RX frequency, record the SINAD reading. It should remain within 1.5 dB from the on frequency SINAD reading. For T885 and T855, use above values, for T835 use 1.5kHz (full channel) or 0.8kHz (half channel).
4. Offset the IFR TX frequency 2KHz (full channel) or 1kHz (half / NPSPAC channel) *below* the main radio RX frequency, record the SINAD reading. It should remain within 1.5 dB from the on-frequency SINAD reading. For T885 and T855, use above values, for T835 use 1.5kHz (full channel) or 0.8kHz (half channel).

*Note: If one of the above requirements is not met, try to re-tune the front-end. If still failed, contact your Dataradio technical support.*

### 5.2.2.5 RSSI Adjustment

- Caution: mis-adjusting RSSI may reduce the Paragon<sup>PD+</sup>'s Parallel Decode (PD) performance.
  - BDLC<sup>PD+</sup> must be connected to the radio backplane during this process.
1. T885-xx-0200 (800/900 MHz) and T855-xx-0250 (UHF) receivers:
    - Apply an on-channel signal from the RF generator at a level of -110 dBm modulated by a 1 kHz tone at a deviation of  $\pm 3$ kHz (full channel) or  $\pm 1.5$ kHz (half / NPSPAC channel).
    - Adjust RV 345 (RSSI level) for T885, RV320 (RSSI level) for T855 to give 2.0V RSSI output at SK330 pin 2 (T855) or on backplane SK1 pin 5 when measured with a voltmeter (See Figure 24 for test point location).
  2. T835-xx-0200 (VHF) receivers:
    - Apply an on-channel signal from the RF generator at a level of -100 dBm with deviation of  $\pm 3$ kHz (full channel) or  $\pm 1.5$ kHz (half channel) at 1kHz tone.
    - Adjust RV320 (RSSI level) to give 4.5V RSSI output at RSSI test point (near quad. Coil L360) or on backplane SK1 pin 5 when measured with a voltmeter (Figure 24 - T800-50-0001) for test point location).

The following RSSI graphics are given as general information only. Refer to factory technical support *only* if RX data performance degradation is noticed combined with something that does not look like those RSSI curves.

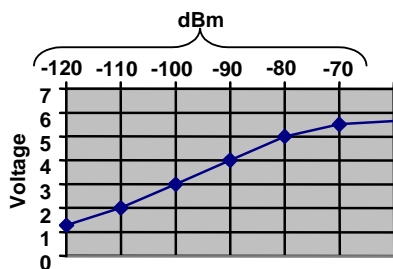

Figure 22 - T855 and T885, Typical RSSI Curve: volt to dBm

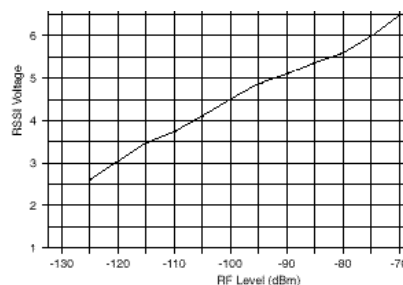

Figure 23 - T835, Typical RSSI Curve: volt to dBm

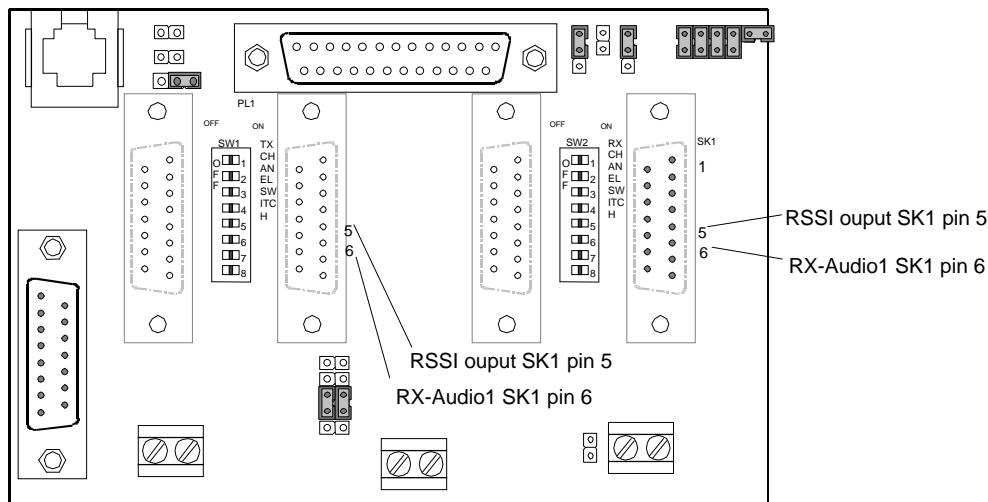

Figure 24 - T800-50-0001 Backplane

### 5.2.3 Exciter Module (T881-xx-0200, T857-xx-0250 or T837-xx-0200)

Note 1: Refer to Figure 28 (T881), Figure 30 (T857) and to Figure 32 (T837) for locating tuning controls and components.

Note 2: When the synthesizer is unlocked, the front panel green LED called "Supply" will flash indicating that it needs re-tuning.

*Warning:*

*The LED will also flash when the unit is in setup mode while connected to the PGM800win program.*

#### 5.2.3.1 Initial Setup

1. Shut down power to the base station.
2. Prepare the Multimeter to DC Volts.
3. Remove the exciter (T881, T857 or T837) module from the base station rack frame.
4. Remove the exciter top cover (nearest the handle).
5. Connect a 3 feet long double shielded cable (N-M to BNC-M) between the IFR T/R output and the exciter antenna connector.
6. Connect the Paragon<sup>PD+</sup> Extender Rail Kit to the empty chassis exciter slot.
7. Apply power to the base station.

#### 5.2.3.2 Synthesizer Alignment

Single channel: Connect the Multimeter to either side of L309 (T881) or the long lead of L1 in the VCO (T857 and T835) (this measures the synthesizer loop voltage).

1. T881 (800/900 MHz) Tune VCO trimmer CV300 for a synthesizer loop voltage of 10V DC.
2. T857 (UHF) Tune VCO trimmer C6 for a synthesizer loop voltage of 10V DC.
3. T837 (VHF). Tune VCO trimmer CV1 for a synthesizer loop voltage of 9VDC.

Multiple channels (adjusting as shown for single channel above):

1. T881 (800/900 MHz) Adjust the VCO loop to 10V using the middle frequency channel.
2. T857 (UHF) Adjust the VCO loop to 10V using the middle frequency channel.
3. T837 (VHF) Adjust the VCO loop to 9V using the middle frequency channel.

All channels should lie within the upper and lower limits of 16V and 3V respectively for the T881 and T857 or within 13V and 5V for the T837.

*Note:*

*Normally, the fast TX key option is installed and the synthesizer is always energized. In the case where that option was not fitted, key the transmitter by pressing the front panel Carrier button to make the above adjustment possible.*

### **5.2.3.3 TX Frequency Error Adjustment**

1. Apply the following settings to the IFR:
  - Receiver mode
  - IFR RX frequency to match the main radio TX frequency
  - IF Filter set to 30KHz
  - Zoom the RF Error window: select 10Khz range
2. Key the transmitter by pressing the front panel TX-Key button and measure the carrier output frequency. It should be within  $\pm 300$  Hz. If it is not, adjust the TCXO (IC700) to trim to meet the requirement, preferably within 100Hz.

### **5.2.3.4 Low-Frequency Balance Adjustment**

*Note:*

- *PGM800Win version 3.00 or later must be used for T881 adjustments and can also be used to adjust T857 and T837 units. Electronic potentiometer (256 step) is used to allow channel adjustment of two-point modulation (Low freq. balance).*
- *PGM800Win version 3.00 or later must be used, if the unit serial number is longer than 6 digits.*

1. Apply the following settings to the IFR:
  - Receiver mode and Oscilloscope display (Source Demod out connector, DC coupled).
  - IFR RX frequency to match the radio transmit frequency
  - IF Filter set to 30KHz
  - Zoom the Deviation window: select 10kHz Range and DC coupling.
2. Select the active or, the lowest (in the case of multi-channel base) frequency channel (via dip switch)
3. Transmit a square wave by pressing the BDLC<sup>PD+</sup>'s PF1 button and following the procedure outlined in section 3.2.1.3 or run the Dataradio WinRIS program on the same computer if two serial COM ports are available.
4. Press EPOTs button. Adjust IC220 via PGM800Win "reference modulation" to obtain the best square wave, no damping, no overshoot. (You can use either the mouse or up and down arrow keys). Record the deviation read.
5. If transmission has not ended by itself, press BDLC<sup>PD+</sup> PF1 to stop it. For single-channel unit, proceed to step 8.

6. For multi-channel unit, select the highest frequency channel. Transmit a square wave by pressing the BDLC<sup>PD+</sup>'s PF1 button and following the procedure outlined in section 3.2.1.3. Record deviation again.
7. The difference in deviation between the two channels should be less than  $\pm 300\text{Hz}$ . If not, re-adjust IC220 to "average" the square wave shape on both channels until the spec is met.
8. To confirm the adjustment, select the active, or the lowest frequency channel. Compare the deviation produced between 1000 Hz sine wave test tone and Random data test pattern

The difference between the test tone and the test pattern should be:

- < 600 Hz (DGMSK)
- < 1.5 kHz (xRC4FSK, xRC8FSK, HC)
- < 2.0 kHz (xRC4FSK, xRC8FSK, FC/NPSPAC).

For multi-channel unit, repeat this step on the highest frequency channel.

9. Select the active channel. Transmit a TX ON (Modulated) adjustment tone by pressing the BDLC<sup>PD+</sup>'s PF1 button and following the procedure outlined in section 3.2.1.3. Make sure that deviation level read on the IFR correspond to model and bit rate in use (see Figure 16). Re-adjust deviation as necessary referring to Checklist B at step 6, page 23.

### 5.2.3.5 Exciter Power Output

1. Apply the following settings to the IFR:
  - Receiver mode, Output T/R
  - IFR RX frequency to match the main radio TX frequency
  - IF Filter set to 30KHz
  - Select auto range in the *Power reading* window
  - Connect the coaxial cable from the IFR T/R to the Exciter output connector
2. Key the Exciter by pressing the module PTT button. The output power at the coaxial cable end connecting to the power amplifier should be:
  - VHF (T837) = 800 mW  $\pm 200\text{mW}$  (no adjustment provided)
  - UHF (T857) = 1W  $\pm 300\text{mW}$  (no adjustment provided)
  - 800/900 MHz (T881) = 4W  $\pm 300\text{mW}$  (RV502, Figure 28)

### 5.2.4 Power Amplifier Module (T889 (800-870 MHz only), T859 or T839)

- Re-install the exciter module into the Paragon<sup>PD+</sup> rack frame.
- Connect the Exciter module to the Power Amplifier.
- Connect the Power Amplifier output to the IFR T/R connector or to a stand-alone BIRD style power meter, terminated with a 150W dummy load.
- Forward and reverse power alarm set (control) are identified on the PA cover.

**Note: For the TPL Communications Power Amplifier (PA8-2BF-LMS) adjustment, see section 5.2.5**

#### 5.2.4.1 Power Amplifier Power Output

- Key the transmitter on the exciter and adjust the PA output for required output (max 100W for VHF and UHF and max 70W for 800) using the front panel power control

If power cannot be reached, refer to section 5.2.4.4 for T859 UHF model, or factory technical support for T839 and T889 models. Cable loss should be included in the reading.

#### 5.2.4.2 Forward Power Alarm Level (Optional setting)

1. Power up the PA and adjust front panel power control so that the output power is at the alarm level required, usually 20% lower than nominal value (e.g. 40W if the PA normally operates at 50W).
2. Adjust the forward power alarm set (T889 or T839: RV101 and T859: RV48) so that the forward power alarm LED lights.
3. Adjust front panel power control for the normal operating power level

#### 5.2.4.3 Reverse Power Alarm Level (Optional setting)

1. Power up the PA and adjust the front panel power control for the normal operating power level.
2. Connect an unterminated 3dB 150 W pad to the PA output (e.g. 3:1 VSWR) and adjust the reverse power alarm set (T889 or T839: RV105 and T859: RV52) so that the reverse power alarm LED lights.

#### 5.2.4.4 Tait T859 (UHF) Standard Tuning Procedure

1. For sets with serial numbers following 217262, set RV69 (driver power level) fully clockwise.
2. For all units, preset the tuning controls as shown in Figure 25

	450MHz	485MHz	520MHz
CV32, CV51, CV57			
CV34, CV35			
CV8, CV1			

Figure 25 - T859 Tuning Settings

3. Set RV63 (front panel power control) fully clockwise.
4. Key on the exciter (press PTT button).
5. Adjust CV1 for maximum output.
6. Adjust CV8 for maximum output.
7. Adjust CV32 for maximum output.
8. Adjust CV51 and CV57 for maximum output.
9. Adjust CV34 and CV35 for maximum output.
10. Recheck all settings. The power output should exceed 110W.
11. For sets with serial numbers following 217262, adjust RV69 (driver power level) until the output power drops to 110W.
12. For all units, adjust RV63 (front panel power control) to reduce the power output to the required level (normally 100W).

#### 5.2.4.5 Tait T859 Tuning for Best Efficiency

1. Insert a Shunt current device (HP 34330A Shunt 30A ) between the power supply red wire and its 13.8Vdc output, then connect the shunt to the multimeter (VDC scale)
2. While transmitting, monitor the current. It should remain under 22A.

3. Retune CV32, CV51 and CV57 towards maximum capacitance to obtain minimum supply current, but do not exceed a maximum drop of 0.5A per control.
4. Check that the supply current is <22A for 100W output power.

*Note:*

*These control settings are normally very close to minimum supply current. If the current is reduced too far, maximum power output will drop and 2f rejection may degrade.*

## 5.2.5 (TPL) LMS series Power amplifier (PA8-2BF-LMS) (890-960 MHz)

*Note:*

*Refer to Figure 26 for parts location.*

- Do not re-install the Exciter module back in the Paragon<sup>PD+</sup> rack frame.
- Connect the Exciter module to the Power Amplifier using the 18" coax cable N-M to BNC-M (727-03353-101)
- Connect the Power Amplifier output to the IFR T/R connector or to a stand-alone BIRD style power meter, terminated with a 150W dummy load.

### 5.2.5.1 Power Output alignment (from TPL Communications)

- a) Key the transmitter using the Exciter Carrier button.
- b) Adjust VR 1 (LMS rear panel) and reduce power output to its nominal value (100W, max 125W) or lower as required.

**Warning:**

*Do not drop the power to less than 65 Watts. Setting a lower value may create spurious emissions that can create interference with adjacent channels.*

### 5.2.5.2 Forward Power Alarm Level

- a) Key the transmitter using the Exciter Carrier button
- b) Adjust T881' s RV50~~Exciter~~ **output** power to drop the RF power amplifier output to 65 Watts.
- c) Adjust TPL' s VR5 until the front panel LED begins to flash.
- d) Adjust T881' s RV502~~Exciter~~ **output** level to the normal operating power level.

### 5.2.5.3 Amplifier Activation

- a) Key the transmitter using the Exciter Carrier button
- b) Set T881' s RV50~~Exciter~~ **output** power to a level 6 dB below the normal drive level. (*e.g. divide by 4 the Exciter nominal output power*) Refer to 5.2.3.5 Exciter Power Output.
- c) Adjust TPL' s VR4 to activate the amplifier and its fans at this threshold.
- d) Adjust T881' s RV50~~Exciter~~ **output** level for the normal operating power level.

### 5.2.5.4 RF Input (Relative Reading)

- a) Toggle the front panel switch until the top line of the display reads **RF INPUT**.
- b) Key the transmitter from the T881' s Exciter Carrier button
- c) Adjust TPL' s VR8 to a nominal 10 units at nominal input drive

### 5.2.5.5 Forward Power meter calibration

- a) Toggle the front panel switch until the top line of the display reads **FWD PWR**.
- b) Key the transmitter from the T881' s Exciter Carrier button.
- c) Adjust TPL' s VR6 so that the front panel meter is in agreement with the calibrated power meter.

### 5.2.5.6 Reverse Power meter calibration

- a) Connect an unterminated 3dB pad to the PA output (*e.g. 3:1 VSWR*).

- b) Toggle the front panel switch until the top line of the display reads **RFL PWR**.
- c) Key the transmitter T881' s Exciter Carrier **button**.
- d) Adjust TPL' s VR7 so that the front panel meter is in agreement with the calibrated power meter.

### 5.2.5.7 Reverse Power Alarm Level

- a) Connect an unterminated 3dB pad to the PA output (*e.g. 3:1 VSWR*).
- e) Key the transmitter T881' s Exciter Carrier **button**.
- b) Adjust TPL' s VR3 until the front panel SWR LED begins to flash

*Note: The LED should extinguish when the normal load is connected (connected to IFR).*

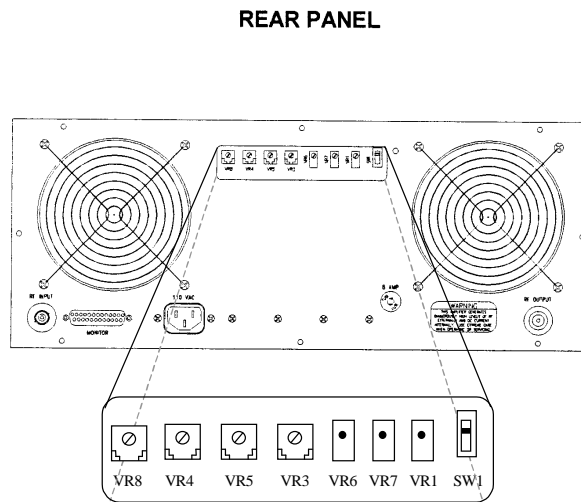

Figure 26 - (TPL) LMS Rear Panel





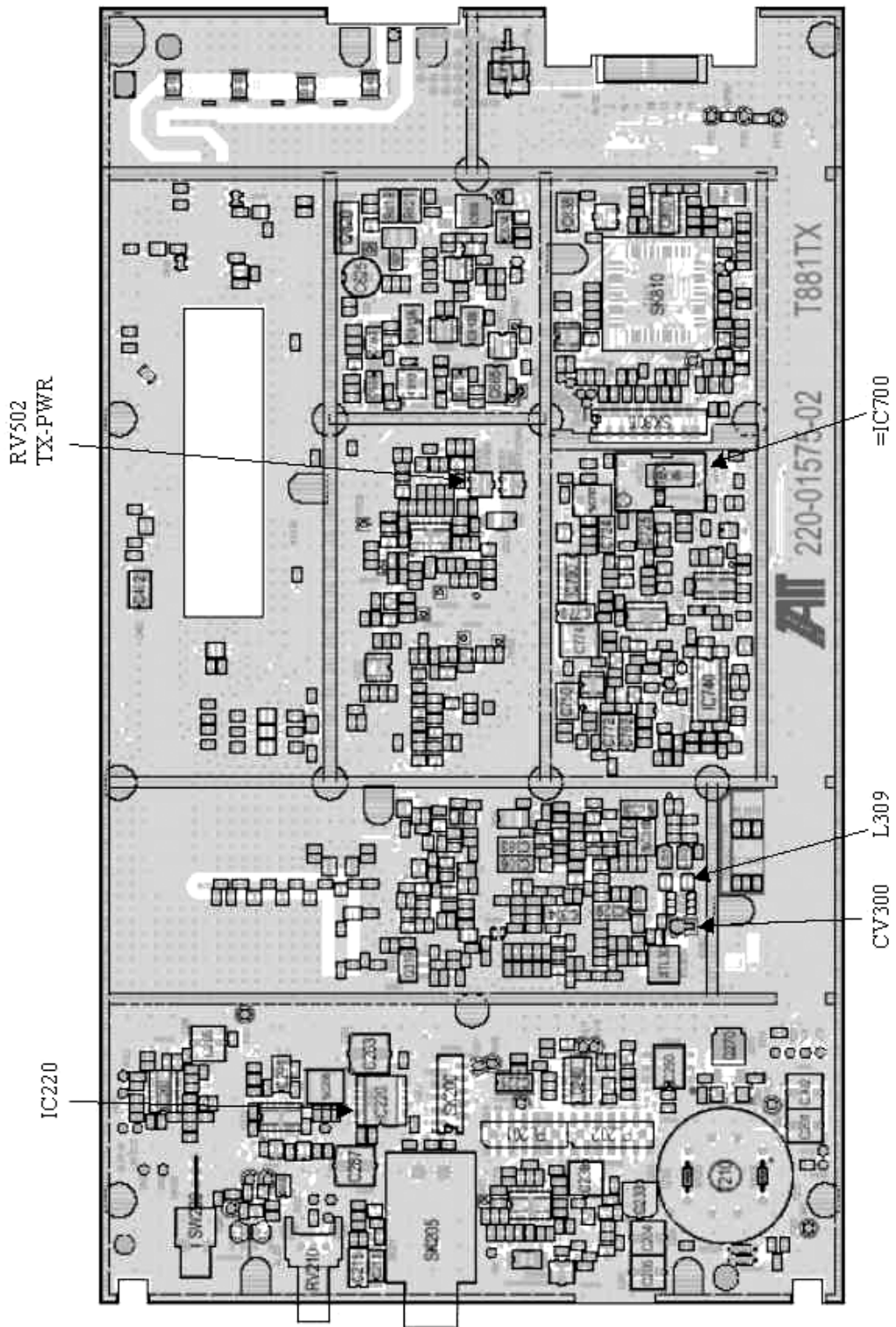

Figure 28 - T881-0200 Exciter Tuning Controls Locations

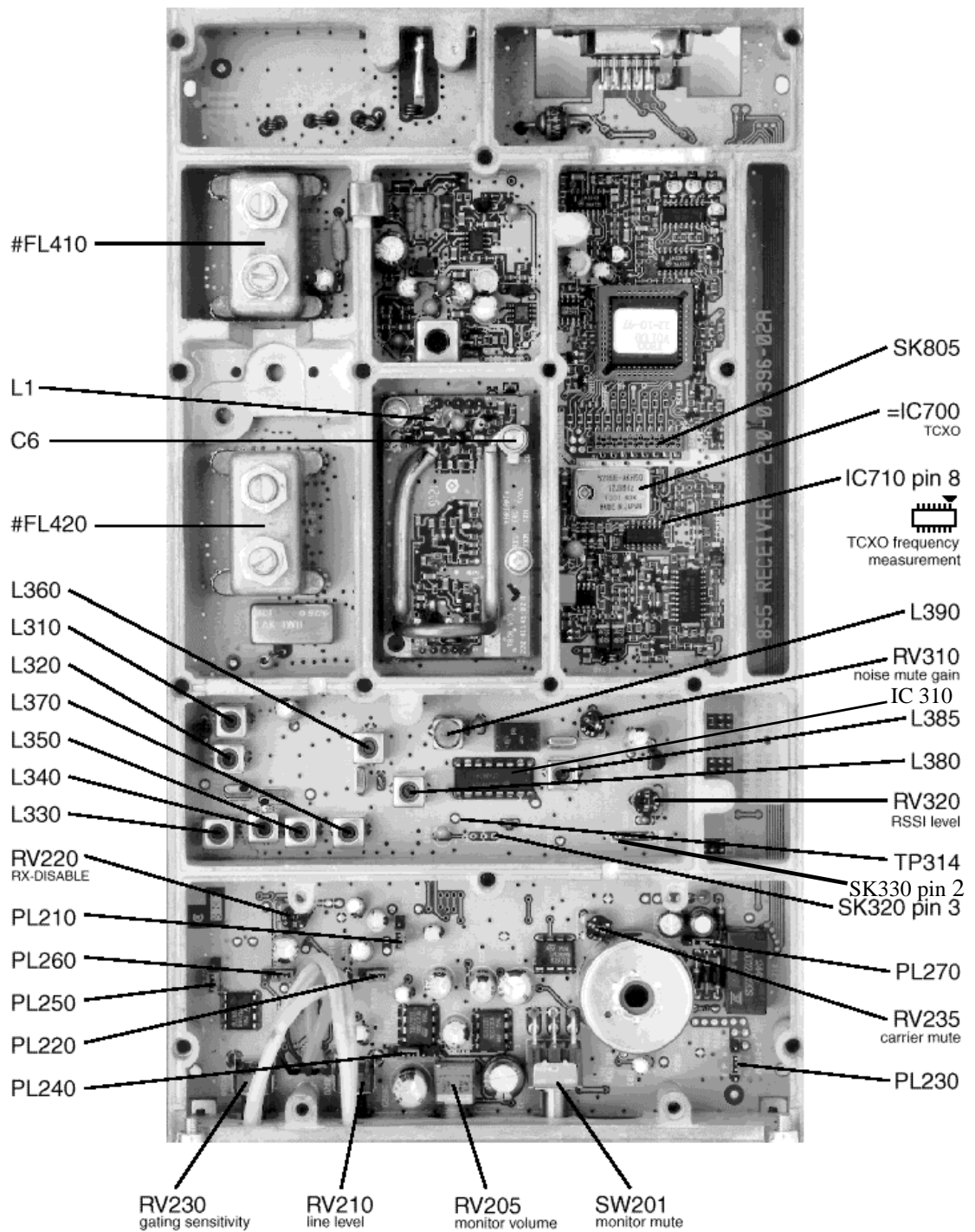

Figure 29 - T855 Receiver Tuning Controls Location

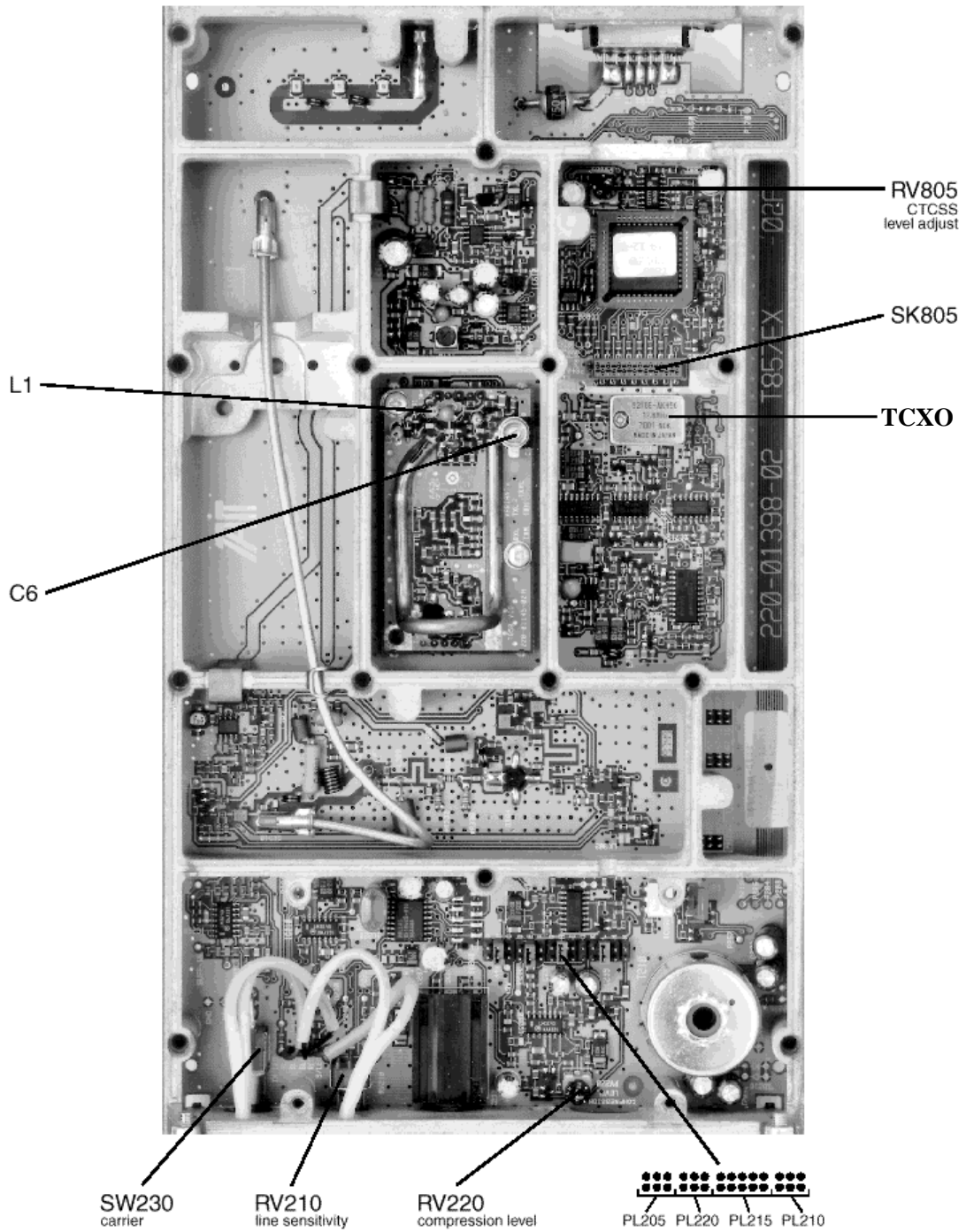

Figure 30 - T857 Exciter Tuning Controls Locations

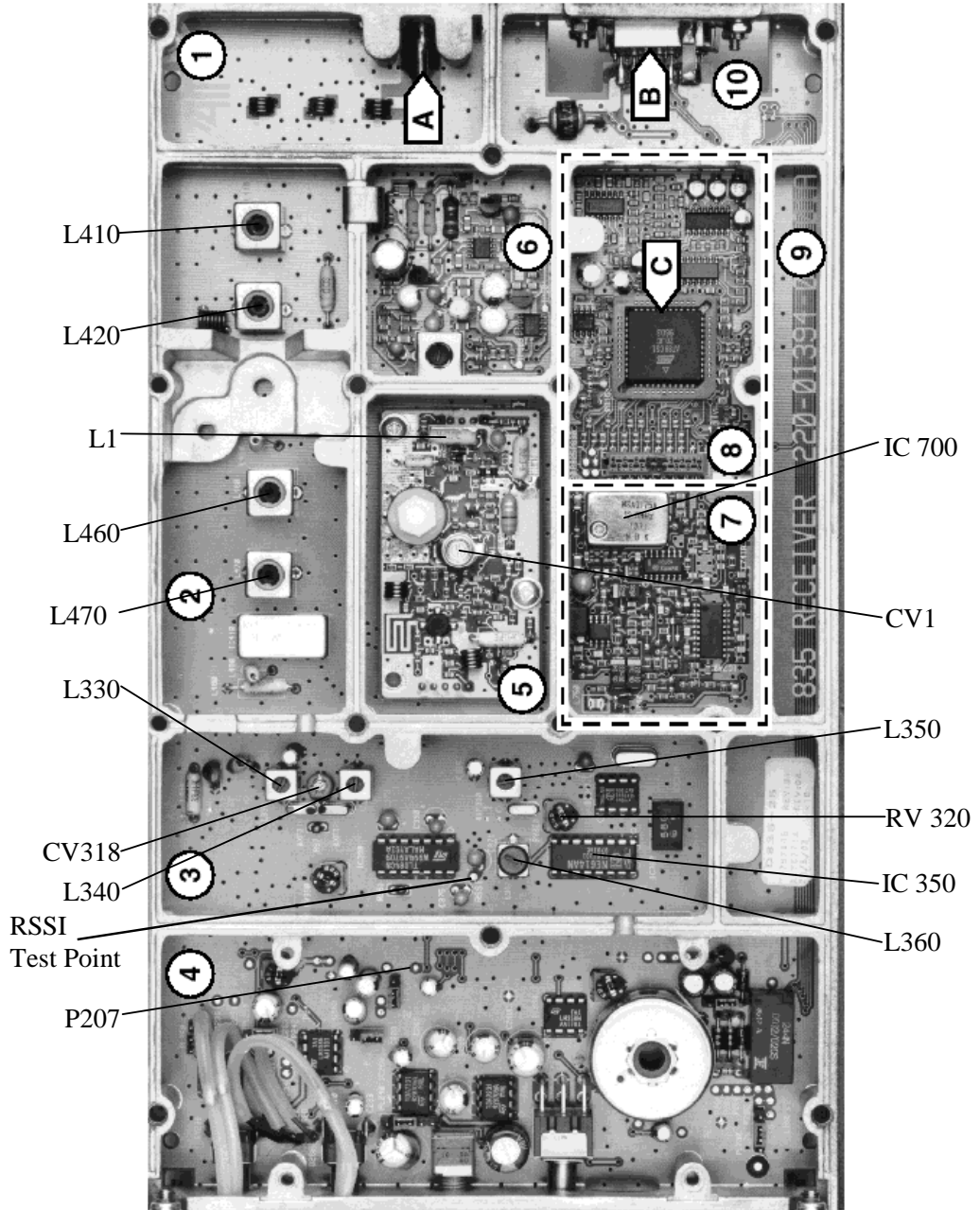

Figure 31 - T835 Receiver Tuning Controls Location

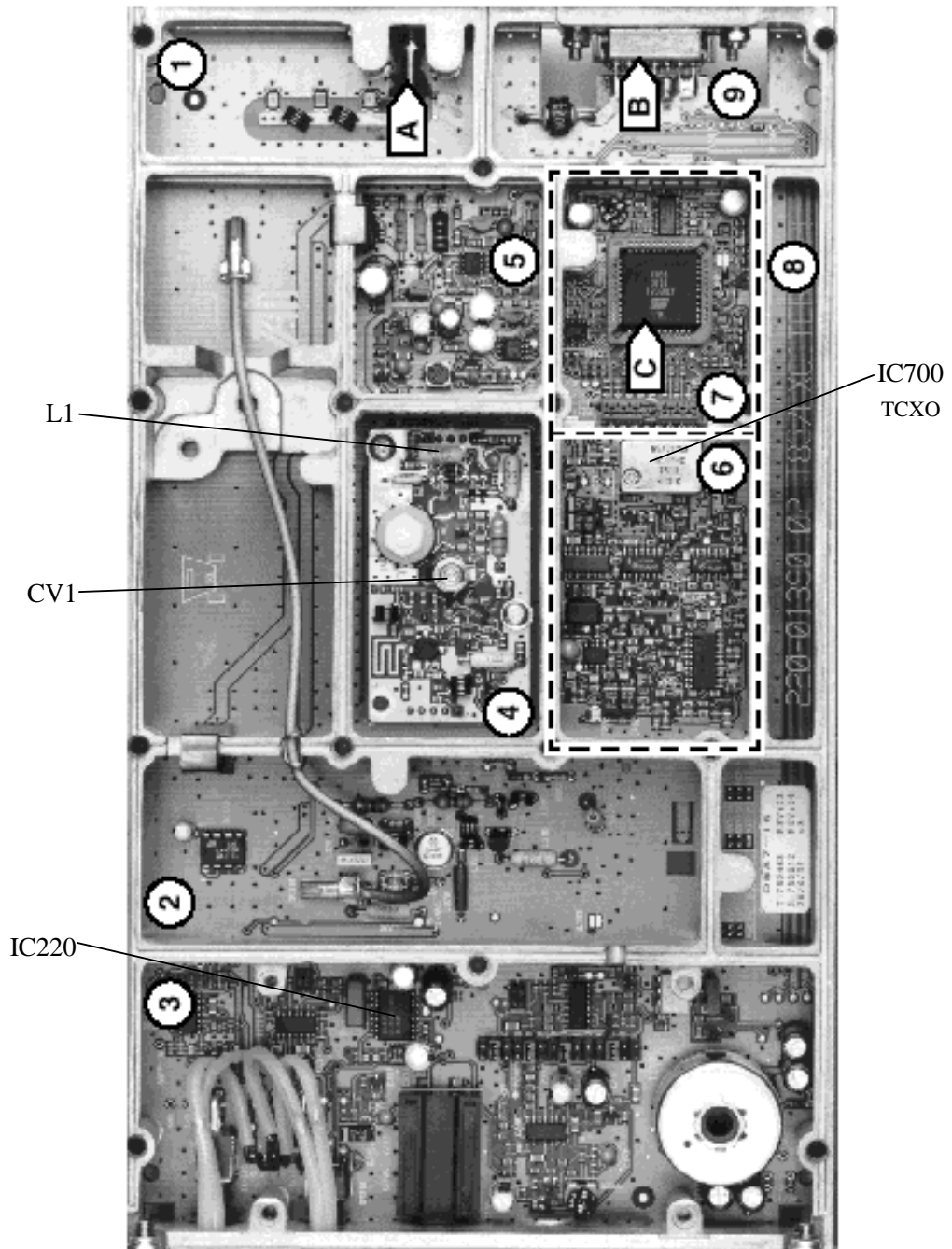

Figure 32 - T837 Exciter Tuning Controls Location

### ***Appendix 1 - Paragon<sup>PD+</sup> Deviation adjust***

1. Using the WinRIS, press *TX ON (Modulated)* and record deviation level as read on the IFR.
2. Using Windows Notepad, Edit the .bp2 file named with the corresponding BDLC<sup>PD+</sup> serial number (e.g. abcd.bp2). ‘Save as’ to another file name and keep it in case something goes wrong while changing a parameter.
3. Locate the line labeled ‘Dev0 Par85=’ and record the value beside the ‘=’ sign. This is the corresponding parameter value to the deviation read in step 1.
4. Apply the following formula to determine the new parameter value to be set:  
(New Par85 value) = [(initial Par85 value) X (target deviation) / (deviation read)] + 2
5. Change the value in the file, ‘Save as’ using the BDLC<sup>PD+</sup> serial number file name.
6. Run the WinRIS again and do a ‘Put From’. From the opened window, select the file that you just made the change to and then press ‘OK’
7. Again, check deviation level while pressing *TX ON (Modulated)*.
  - If the level is now correct, press *StationReset* to make the change permanent.
  - Otherwise do step 5 again, changing the value entered in the file by 1 or 2 digit(s) up or down, fine-tuning directly the Par85 (DSP deviation) parameter. Do steps 6 and 7 again to confirm acceptance.

*This last step may have to be repeated once or twice while varying the entered value up or down. If unable to obtain the correct level after editing up and/or down by no more than 2, contact System Engineering.*

## 6. Specifications

### GENERAL

	VHF	UHF	800	900
Frequency	136 -156 MHz 148 -174 MHz	400 - 440 MHz <sup>1</sup> 440 - 480 MHz 480 - 520 MHz	RX 800 - 870 MHz TX 850 - 870 MHz	RX 890 - 960 MHz TX 890 - 960 MHz
RF/Modem Assembly Size	19.0" W x 17.5.0" H x 12.5" D + 2.0" connector allowance			
Frequency Stability	2.5 ppm (-30 to +60°C)	1.0 ppm (-20 to +60°C)		
Supply Voltage	13.8 VDC nominal (negative ground), 10.8 - 16 VDC or 115 VAC			
Circuit protection	Fuse 1: 32-volt MDL (slow-blow) 10A Fuse 2: 32-volt MDL (slow-blow) 30A Crowbar diodes for reverse polarity protection			
RX Current Consumption @ 13.8 VDC	1.5A max. (Two receivers with speaker monitoring)			
TX Current Consumption @ 13.8 VDC	20A (16A typical @ 156MHz for 100W)	24A (22A DC typical @ 450MHz for 100W)	28A (23A DC typical @ 850MHz for 70W)	
Base Station Power Consumption @ 115 VAC	6A max.			
Channel spacing	25 kHz and 12.5 kHz			
Operating Temperature Range	-30° C to +60° C (deleted power supply, catalog number ending with a 0) -10° C to +60° C (with standard Dual Power Supply assembly, catalog number ending with a 2)			

### RECEIVER

Selectivity @ 25 kHz @ 12.5 kHz	92 dB min, 95 dB (Typical) 86 dB min, 89 dB (Typical)	87 dB min, 90 dB (Typical) 83 dB min, 85 dB (Typical)	85 dB min, 88 dB (Typical) 79 dB min, 80 dB (Typical)
Sensitivity @ 12 dB SINAD	-117 dBm*		
Spurious Response Rejection	100 dB (Typical)		
Intermodulation Rejection - EIA (25 kHz) - EIA 300-096 (12.5 kHz)	85 dB (Typical) 80 dB (Typical)	85 dB (Typical) 80 dB (Typical)	80 dB (Typical) 75 dB (Typical)
Hum and Noise - EIA (25 kHz) - ETS 300-096 (12.5 kHz)	55 dB* 50 dB*		47 dB* 45 dB*

\* Psophometrically weighted (De-emphasis response)

### TRANSMITTER

Rated Continuous RF Power	100W	100W	70W	
Range of Adjustment	20 – 100 W	20 – 100 W	20 – 70 W	65 - 100 W
Spurious Emissions: - transmit - standby	-36 dBm to 1GHz, -30 dBm to 4 GHz (to 3.2GHz for 800/900 model) -57 dBm to 1GHz, -47 dBm to 4 GHz ((to 3.2GHz for 800/900 model))			
VSWR Stability	5:1 mismatch			
Transmitter Sideband Noise @ +/-25 kHz @ +/- 1 MHz	-95 dBc -105 dBc	-95 dBc -105 dBc	-88 dBc -100 dBc	

<sup>1</sup> **WARNING:** The frequency band 406 to 406.1 MHz is reserved for use by distress beacons and should not be programmed into the unit.



		Data rates and Modulation type*						
Packet Error Rate ( $< 1\%$ error, at $F_c$ , with Parallel Decode)	Channel type	32 kb/s (RC4FSK) Gemini <sup>PD+</sup> only	25.6 kb/s (SRRC4FSK) Gemini <sup>PD+</sup> only	19.2 kb/s (SRRC4FSK)	19.2 kb/s (DGMSK)	16 kb/s (SRRC4FSK)	14.4 kb/s (SRRC4FSK)	
	VHF (25 kHz)	TBD	TBD	N/A	-113 dBm	N/A	N/A	
	VHF (12.5kHz)	N/A	N/A	N/A	N/A	TBD	TBD	
	UHF (25 kHz)	-107 dBm	-110 dBm	N/A	-113 dBm	N/A	N/A	
	UHF (12.5kHz)	N/A	N/A	N/A	N/A	-109 dBm	-112 dBm	
	800 (25 kHz)	-108 dBm	-109 dBm	N/A	-113 dBm	N/A	N/A	
	800 (NPSPAC)	N/A	N/A	-108 dBm	-108 dBm	-112 dBm	N/A	
	800 (12.5kHz)	N/A	N/A	N/A	N/A	-110 dBm	-113 dBm	
	900 (12.5kHz)	N/A	N/A	TBD	TBD	TBD	TBD	
	Channel type	48 kb/s (xRC8FSK) Gemini <sup>PD+</sup> only	43.2 kb/s (xRC8FSK) Gemini <sup>PD+</sup> only	28.8 kb/s (xRC8FSK) Gemini <sup>PD+</sup> only	24.0 kb/s (xRC8FSK) Gemini <sup>PD+</sup> only	21.6 kb/s (xRC8FSK) Gemini <sup>PD+</sup> only		
	UHF (25 kHz)	-TBD dBm	- TBD dBm	N/A	N/A	N/A		
	UHF (12.5kHz)	N/A	N/A	N/A	-TBD dBm	-TBD dBm		
	800 (25 kHz)	-TBD dBm	-TBD dBm	N/A	N/A	N/A		
	800 (NPSPAC)	N/A	N/A	-TBD dBm	-TBD dBm	N/A		
800 (12.5kHz)	N/A	N/A	N/A	-TBD dBm	-TBD dBm			
900 (12.5kHz)	N/A	N/A	-TBD dBm	-TBD dBm	-TBD dBm			

Protocol	Dataradio Proprietary DBA
Operation	Full duplex

\* Networks must use common modulation, bit, and baud rates. Different types are not on-air compatible

#### FCC / IC CERTIFICATIONS

		FCC	IC (DOC) *
VHF	136 - 156 MHz	CASTEL0007	737195375A
	148 - 174 MHz	EOTBDD4T83-2	737195376A
UHF	400 - 440 MHz	EOTBDD4T85-1	
	440 - 480 MHz	EOTBDD4T85-2	3993195401A
	480 - 520 MHz	EOTBDD4T85-3	N/A
800 MHz <b>Series II</b>	800 - 870 MHz	EOTBDD4T881S2 (4Watts) EOTBDD4T889 (100 Watts)	737194358
900 MHz <b>Series II</b>	890 - 960 MHz	EOTBD4T881-3 (4 Watts) BBD8-2BF-L (100 Watts, TPL)	737194358

\* Operating under Class II permissive change

**EMISSION DESIGNATORS\***

Bit rate	Baud rate	Modulation	VHF	UHF	800MHz	900MHz
32000	16000	RC4FSK	15K2F1D	16K5F1D	15K9F1D	-
25600	12800	SRRC4FSK	14K7F1D	14K3F1D	14K3F1D	-
19200	9600	SRRC4FSK	-	15K9F1D	15K9F1D	9K58F1D
16000	8000	SRRC4FSK	7K67F1D	7K17F1D <sup>1)</sup>	9K50F1D	9K75F1D
14400	7200	SRRC4FSK	8K25F1D	8K00F1D <sup>1)</sup>	11K0F1D	10K9F1D
48000	16000	xRC8FSK <sup>1)</sup>	-	16K7F1D <sup>1)</sup>	13K7F1D <sup>1)</sup>	-
43200	14400	xRC8FSK <sup>1)</sup>	-	14K9F1D <sup>1)</sup>	14K9F1D <sup>1)</sup>	-
28800	9600	xRC8FSK <sup>1)</sup>	-	-	9K17F1D <sup>1)</sup>	9K50F1D <sup>1)</sup>
24000	8000	xRC8FSK <sup>1)</sup>	-	8K00F1D <sup>1)</sup>	11K9F1D <sup>1)</sup>	9K42F1D <sup>1)</sup>
21600	7200	xRC8FSK <sup>1)</sup>	-	8K33F1D <sup>1)</sup>	-	10K5F1D <sup>1)</sup>

\* Emission designators for legacy DGMSK modulations are available on certificates

<sup>1)</sup> Ver 1.00a-Preliminary; Subject to Class II Permissive Change Approval