

FCC Test Report

Product Name	Bluetooth Wireless Keyboard
Model No.	FOLIO KEY
FCC ID.	E8HKT1253

Applicant	Chicony Electronics Co., Ltd.
Address	No.25 Wu-Gong 6th Rd. Wugu Dist., New Taipei City 248, Taiwan, R.O.C.

Date of Receipt	Feb. 05, 2013
Issued Date	Feb. 20, 2013
Report No.	132133R-RFUSP43V01
Report Version	V1.0



The Test Results relate only to the samples tested.

The test report shall not be reproduced except in full without the written approval of Quietek Corporation.

This report must not be used to claim product endorsement by NVLAP any agency of the U.S. Government

Test Report Certification

Issued Date: Feb. 20, 2013

Report No.: 132133R-RFUSP43V01



Product Name	Bluetooth Wireless Keyboard
Applicant	Chicony Electronics Co., Ltd.
Address	No.25 Wu-Gong 6th Rd. Wugu Dist., New Taipei City 248, Taiwan, R.O.C.
Manufacturer	Chicony Electronics Co., Ltd.
Model No.	FOLIO KEY
FCC ID.	E8HKT1253
EUT Rated Voltage	DC 3.7V (Power by Battery)
EUT Test Voltage	AC 120V/60Hz
Trade Name	ASUS
Applicable Standard	FCC CFR Title 47 Part 15 Subpart C: 2012 ANSI C63.4: 2003, ANSI C63.10: 2009
Test Result	Complied

The Test Results relate only to the samples tested.

The test report shall not be reproduced except in full without the written approval of Quietek Corporation.

This report must not be used to claim product endorsement by NVLAP any agency of the U.S. Government

Documented By :



(Senior Adm. Specialist / Leven Huang)

Tested By :



(Assistant Engineer / Nowal Kuo)

Approved By :



(Manager / Vincent Lin)

TABLE OF CONTENTS

Description	Page
1. GENERAL INFORMATION	5
1.1. EUT Description.....	5
1.2. Operational Description	7
1.3. Tested System Details.....	8
1.4. Configuration of Tested System	8
1.5. EUT Exercise Software	8
1.6. Test Facility	9
2. CONDUCTED EMISSION	10
2.1. Test Equipment.....	10
2.2. Test Setup	10
2.3. Limits	11
2.4. Test Procedure	11
2.5. Uncertainty	11
2.6. Test Result of Conducted Emission.....	12
3. PEAK POWER OUTPUT	14
3.1. Test Equipment.....	14
3.2. Test Setup	14
3.3. Limit	14
3.4. Test Procedure	14
3.5. Uncertainty	14
3.6. Test Result of Peak Power Output.....	15
4. RADIATED EMISSION	16
4.1. Test Equipment.....	16
4.2. Test Setup	16
4.3. Limits	17
4.4. Test Procedure	18
4.5. Uncertainty	18
4.6. Test Result of Radiated Emission.....	19
5. RF ANTENNA CONDUCTED TEST	23
5.1. Test Equipment.....	23
5.2. Test Setup	23
5.3. Limits	23
5.4. Test Procedure	23
5.5. Uncertainty	23
5.6. Test Result of RF Antenna Conducted Test.....	24
6. BAND EDGE	30
6.1. Test Equipment.....	30
6.2. Test Setup	31
6.3. Limit	32
6.4. Test Procedure	32
6.5. Uncertainty	32
6.6. Test Result of Band Edge	33
7. CHANNEL NUMBER.....	37
7.1. Test Equipment.....	37
7.2. Test Setup	37
7.3. Limit	37
7.4. Test Procedure	37
7.5. Uncertainty	37
7.6. Test Result of Channel Number	38
8. CHANNEL SEPARATION.....	39
8.1. Test Equipment.....	39
8.2. Test Setup	39
8.3. Limit	39
8.4. Test Procedure	39
8.5. Uncertainty	39
8.6. Test Result of Channel Separation	40
9. DWELL TIME.....	42
9.1. Test Equipment.....	42

9.2.	Test Setup	42
9.3.	Limit	42
9.4.	Test Procedure	42
9.5.	Uncertainty	42
9.6.	Test Result of Dwell Time	43
10.	OCCUPIED BANDWIDTH	45
10.1.	Test Equipment	45
10.2.	Test Setup	45
10.3.	Limits	45
10.4.	Test Procedure	45
10.5.	Uncertainty	45
10.6.	Test Result of Occupied Bandwidth	46
11.	EMI REDUCTION METHOD DURING COMPLIANCE TESTING	49
Attachment 1: EUT Test Photographs		
Attachment 2: EUT Detailed Photographs		

1. GENERAL INFORMATION

1.1. EUT Description

Product Name	Bluetooth Wireless Keyboard
Trade Name	ASUS
Model No.	FOLIO KEY
FCC ID.	E8HKT1253
Frequency Range	2402 – 2480MHz
Channel Number	79
Type of Modulation	FHSS: GFSK(1Mbps)
Antenna Type	Printed Antenna
Channel Control	Auto
Antenna Gain	Refer to the table “Antenna List”
USB Cable	Shielded, 0.4m

Antenna List (Bluetooth):

No.	Manufacturer	Part No.	Peak Gain
1	N/A	N/A	-0.99dBi in 2.4 GHz

Note: The antenna of EUT is conform to FCC 15.203.

Frequency of Each Channel:

Channel	Frequency	Channel	Frequency	Channel	Frequency	Channel	Frequency
Channel 00:	2402 MHz	Channel 20:	2422 MHz	Channel 40:	2442 MHz	Channel 60:	2462 MHz
Channel 01:	2403 MHz	Channel 21:	2423 MHz	Channel 41:	2443 MHz	Channel 61:	2463 MHz
Channel 02:	2404 MHz	Channel 22:	2424 MHz	Channel 42:	2444 MHz	Channel 62:	2464 MHz
Channel 03:	2405 MHz	Channel 23:	2425 MHz	Channel 43:	2445 MHz	Channel 63:	2465 MHz
Channel 04:	2406 MHz	Channel 24:	2426 MHz	Channel 44:	2446 MHz	Channel 64:	2466 MHz
Channel 05:	2407 MHz	Channel 25:	2427 MHz	Channel 45:	2447 MHz	Channel 65:	2467 MHz
Channel 06:	2408 MHz	Channel 26:	2428 MHz	Channel 46:	2448 MHz	Channel 66:	2468 MHz
Channel 07:	2409 MHz	Channel 27:	2429 MHz	Channel 47:	2449 MHz	Channel 67:	2469 MHz
Channel 08:	2410 MHz	Channel 28:	2430 MHz	Channel 48:	2450 MHz	Channel 68:	2470 MHz
Channel 09:	2411 MHz	Channel 29:	2431 MHz	Channel 49:	2451 MHz	Channel 69:	2471 MHz
Channel 10:	2412 MHz	Channel 30:	2432 MHz	Channel 50:	2452 MHz	Channel 70:	2472 MHz
Channel 11:	2413 MHz	Channel 31:	2433 MHz	Channel 51:	2453 MHz	Channel 71:	2473 MHz
Channel 12:	2414 MHz	Channel 32:	2434 MHz	Channel 52:	2454 MHz	Channel 72:	2474 MHz
Channel 13:	2415 MHz	Channel 33:	2435 MHz	Channel 53:	2455 MHz	Channel 73:	2475 MHz
Channel 14:	2416 MHz	Channel 34:	2436 MHz	Channel 54:	2456 MHz	Channel 74:	2476 MHz
Channel 15:	2417 MHz	Channel 35:	2437 MHz	Channel 55:	2457 MHz	Channel 75:	2477 MHz
Channel 16:	2418 MHz	Channel 36:	2438 MHz	Channel 56:	2458 MHz	Channel 76:	2478 MHz
Channel 17:	2419 MHz	Channel 37:	2439 MHz	Channel 57:	2459 MHz	Channel 77:	2479 MHz
Channel 18:	2420 MHz	Channel 38:	2440 MHz	Channel 58:	2460 MHz	Channel 78:	2480 MHz
Channel 19:	2421 MHz	Channel 39:	2441 MHz	Channel 59:	2461 MHz		

Note:

1. The EUT is a Bluetooth Wireless Keyboard with a built-in Bluetooth transceiver.
2. These tests were conducted on a sample for the purpose of demonstrating compliance of Bluetooth transmitter with Part 15 Subpart C Paragraph 15.247 for spread spectrum devices.
3. Regarding to the operation frequency, the lowest, middle and highest frequency are selected to perform the test

Test Mode	Mode 1: Transmit - 1Mbps (GFSK)
-----------	---------------------------------

1.3. Tested System Details

The types for all equipment, plus descriptions of all cables used in the tested system (including inserted cards) are:

Product	Manufacturer	Model No.	Serial No.	Power Cord	
1	Notebook PC	DELL	PPT	N/A	Non-Shielded, 0.8m
2	Test Fixture	ASUS	N/A	N/A	N/A

Signal Cable Type	Signal cable Description
A	USB Cable Shielded, 0.4m
B	USB Cable Shielded, 1.2m
C	Test Fixture Cable Shielded, 1.8m
D	Signal Cable Non-Shielded, 0.1m

1.4. Configuration of Tested System

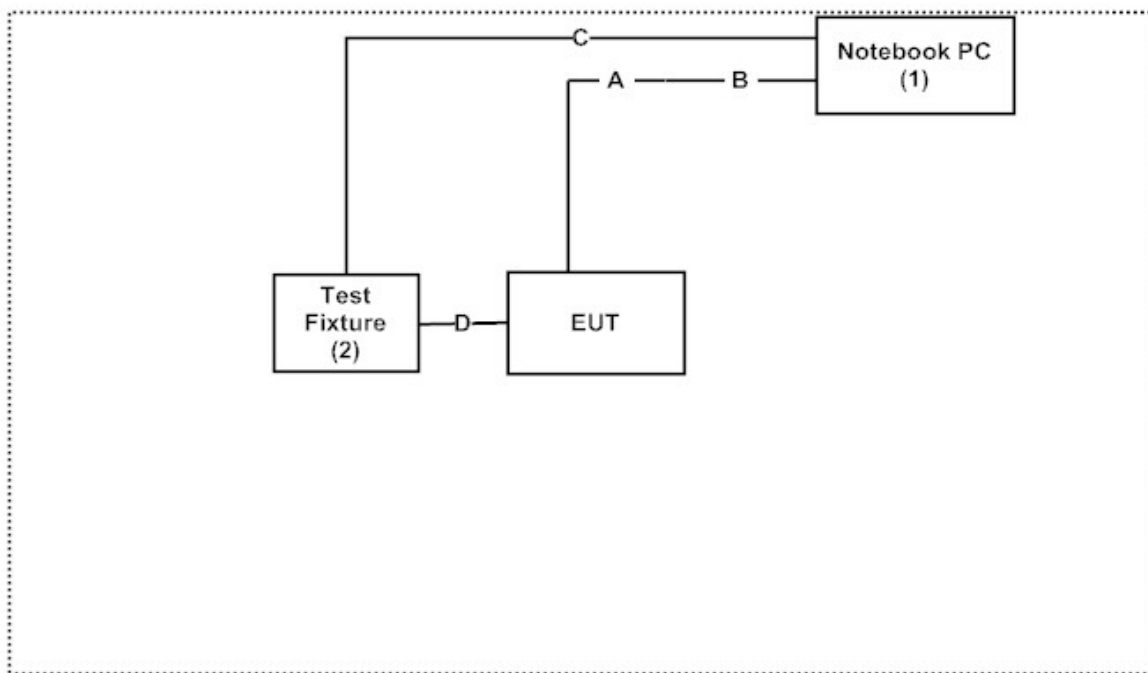

1.5. EUT Exercise Software

- (1) Setup the EUT as shown in Section 1.4
- (2) Execute program "Tiny MT-1160U ver.1.0" on the Notebook PC.
- (3) Configure the test mode, the test channel, and the data rate.
- (4) Start transmits continually.
- (5) Verify that the EUT works properly.

1.6. Test Facility

Ambient conditions in the laboratory:

Items	Required (IEC 68-1)	Actual
Temperature (°C)	15-35	20-35
Humidity (%RH)	25-75	30-65
Barometric pressure (mbar)	860-1060	950-1000

The related certificate for our laboratories about the test site and management system can be downloaded from Quietek Corporation's Web Site: <http://www.quietek.com/tw/ctg/cts/accreditations.htm>

The address and introduction of Quietek Corporation's laboratories can be founded in our Web site: <http://www.quietek.com/>

Site Description: File on
 Federal Communications Commission
 FCC Engineering Laboratory
 7435 Oakland Mills Road
 Columbia, MD 21046
 Registration Number: 92195

Accreditation on NVLAP
 NVLAP Lab Code: 200533-0

Site Name: Quietek Corporation
 Site Address: No.5-22, Ruishukeng,
 Linkou Dist. New Taipei City 24451,
 Taiwan, R.O.C.
 TEL: 886-2-8601-3788 / FAX : 886-2-8601-3789
 E-Mail : service@quietek.com

FCC Accreditation Number: TW1014

2. Conducted Emission

2.1. Test Equipment

	Equipment	Manufacturer	Model No. / Serial No.	Last Cal.	Remark
X	Test Receiver	R & S	ESCS 30 / 825442/018	Sep., 2013	
X	Artificial Mains Network	R & S	ENV4200 / 848411/10	Feb., 2014	Peripherals
X	LISN	R & S	ESH3-Z5 / 825562/002	Feb., 2014	EUT
	DC LISN	Schwarzbeck	8226 / 176	Mar, 2013	EUT
X	Pulse Limiter	R & S	ESH3-Z2 / 357.8810.52	Feb., 2014	
	No.1 Shielded Room				

Note:

1. All equipments are calibrated every one year.
2. The test instruments marked by “X” are used to measure the final test results.

2.2. Test Setup

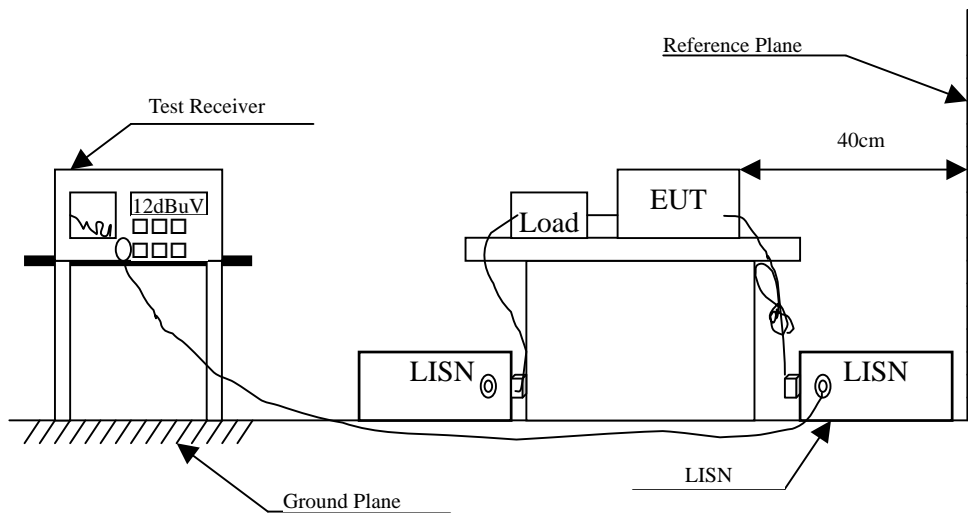

2.3. Limits

FCC Part 15 Subpart C Paragraph 15.207 (dBuV) Limit		
Frequency MHz	Limits	
	QP	AV
0.15 - 0.50	66-56	56-46
0.50-5.0	56	46
5.0 - 30	60	50

Remarks: In the above table, the tighter limit applies at the band edges.

2.4. Test Procedure

The EUT and Peripherals are connected to the main power through a line impedance stabilization network (L.I.S.N.). This provides a 50 ohm /50uH coupling impedance for the measuring equipment. The peripheral devices are also connected to the main power through a LISN that provides a 50ohm /50uH coupling impedance with 50ohm termination. (Please refer to the block diagram of the test setup and photographs.)

Both sides of A.C. line are checked for maximum conducted interference. In order to find the maximum emission, the relative positions of equipment and all the interface cables must be changed according to ANSI C63.10: 2009 on conducted measurement.

Conducted emissions were investigated over the frequency range from 0.15MHz to 30MHz using a receiver bandwidth of 9kHz.

The EUT was setup to ANSI C63.10: 2009; tested to FHSS test procedure of FCC Public Notice DA 00-705 for compliance to FCC 47CFR 15.247 requirements.

2.5. Uncertainty

± 2.26 dB

2.6. Test Result of Conducted Emission

Product : Bluetooth Wireless Keyboard
 Test Item : Conducted Emission Test
 Power Line : Line 1
 Test Mode : Mode 1: Transmit - 1Mbps (GFSK) (2441MHz)

Frequency MHz	Correct Factor dB	Reading Level dBuV	Measurement Level dBuV	Margin dB	Limit dBuV
LINE 1					
Quasi-Peak					
0.166	9.710	36.560	46.270	-19.273	65.543
0.185	9.696	33.510	43.206	-21.794	65.000
0.205	9.683	33.570	43.253	-21.176	64.429
0.298	9.640	31.830	41.470	-20.301	61.771
0.369	9.640	19.120	28.760	-30.983	59.743
0.435	9.640	24.330	33.970	-23.887	57.857
Average					
0.166	9.710	16.280	25.990	-29.553	55.543
0.185	9.696	16.710	26.406	-28.594	55.000
0.205	9.683	14.800	24.483	-29.946	54.429
0.298	9.640	27.690	37.330	-14.441	51.771
0.369	9.640	7.440	17.080	-32.663	49.743
0.435	9.640	16.580	26.220	-21.637	47.857

Note:

1. All Reading Levels are Quasi-Peak and average value.
2. "█" means the worst emission level.
3. Measurement Level = Reading Level + Correct Factor

Product : Bluetooth Wireless Keyboard
 Test Item : Conducted Emission Test
 Power Line : Line 2
 Test Mode : Mode 1: Transmit - 1Mbps (GFSK) (2441MHz)

Frequency MHz	Correct Factor dB	Reading Level dBuV	Measurement Level dBuV	Margin dB	Limit dBuV
LINE 2					
Quasi-Peak					
0.267	9.651	29.860	39.511	-23.146	62.657
0.291	9.647	32.440	42.086	-19.885	61.971
0.310	9.650	26.860	36.510	-24.919	61.429
0.447	9.650	26.140	35.790	-21.724	57.514
0.494	9.650	23.250	32.900	-23.271	56.171
0.521	9.650	19.900	29.550	-26.450	56.000
Average					
0.267	9.651	26.680	36.331	-16.326	52.657
0.291	9.647	30.180	39.826	-12.145	51.971
0.310	9.650	22.610	32.260	-19.169	51.429
0.447	9.650	17.930	27.580	-19.934	47.514
0.494	9.650	14.610	24.260	-21.911	46.171
0.521	9.650	12.620	22.270	-23.730	46.000

Note:

1. All Reading Levels are Quasi-Peak and average value.
2. "█" means the worst emission level.
3. Measurement Level = Reading Level + Correct Factor

3. Peak Power Output

3.1. Test Equipment

	Equipment	Manufacturer	Model No./Serial No.	Last Cal.
X	Power Meter	Anritsu	ML2495A/6K00003357	May, 2013
X	Power Sensor	Anritsu	MA2411B/0738448	Jun., 2013

Note: 1. All equipments are calibrated every one year.
 2. The test instruments marked by “X” are used to measure the final test results.

3.2. Test Setup

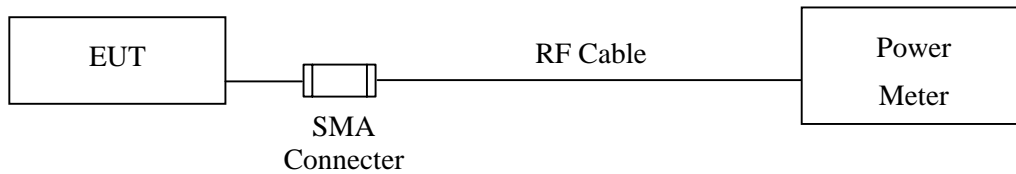

3.3. Limit

The maximum peak power shall be less 1Watt.

3.4. Test Procedure

The EUT was setup to ANSI C63.10: 2009; tested to FHSS test procedure of FCC Public Notice DA 00-705 for compliance to FCC 47CFR 15.247 requirements.

3.5. Uncertainty

± 1.27 dB

3.6. Test Result of Peak Power Output

Product : Bluetooth Wireless Keyboard
Test Item : Peak Power Output
Test Site : No.3 OATS
Test Mode : Mode 1: Transmit - 1Mbps (GFSK)

Channel No.	Frequency (MHz)	Measurement (dBm)	Required Limit	Result
Channel 00	2402.00	2.23	1 Watt= 30 dBm	Pass
Channel 39	2441.00	2.31	1 Watt= 30 dBm	Pass
Channel 78	2480.00	2.39	1 Watt= 30 dBm	Pass

4. Radiated Emission

4.1. Test Equipment

The following test equipments are used during the radiated emission test:

Test Site		Equipment	Manufacturer	Model No./Serial No.	Last Cal.
☒ Site # 3	X	Bilog Antenna	Schaffner Chase	CBL6112B/2673	Sep., 2013
	X	Horn Antenna	Schwarzbeck	BBHA9120D/D305	Sep., 2013
	X	Horn Antenna	Schwarzbeck	BBHA9170/208	Jul., 2013
	X	Pre-Amplifier	Agilent	8447D/2944A09549	Sep., 2013
	X	Spectrum Analyzer	Agilent	E4407B / US39440758	May, 2013
	X	Test Receiver	R & S	ESCS 30/ 825442/018	Sep., 2013
	X	Coaxial Cable	QuieTek	QTK-CABLE / CAB5	Feb., 2014
	X	Controller	QuieTek	QTK-CONTROLLER/ CTRL3	N/A
	X	Coaxial Switch	Anritsu	MP59B/6200265729	N/A

- Note: 1. All equipments are calibrated every one year.
 2. The test instruments marked by "X" are used to measure the final test results.

4.2. Test Setup

Below 1GHz

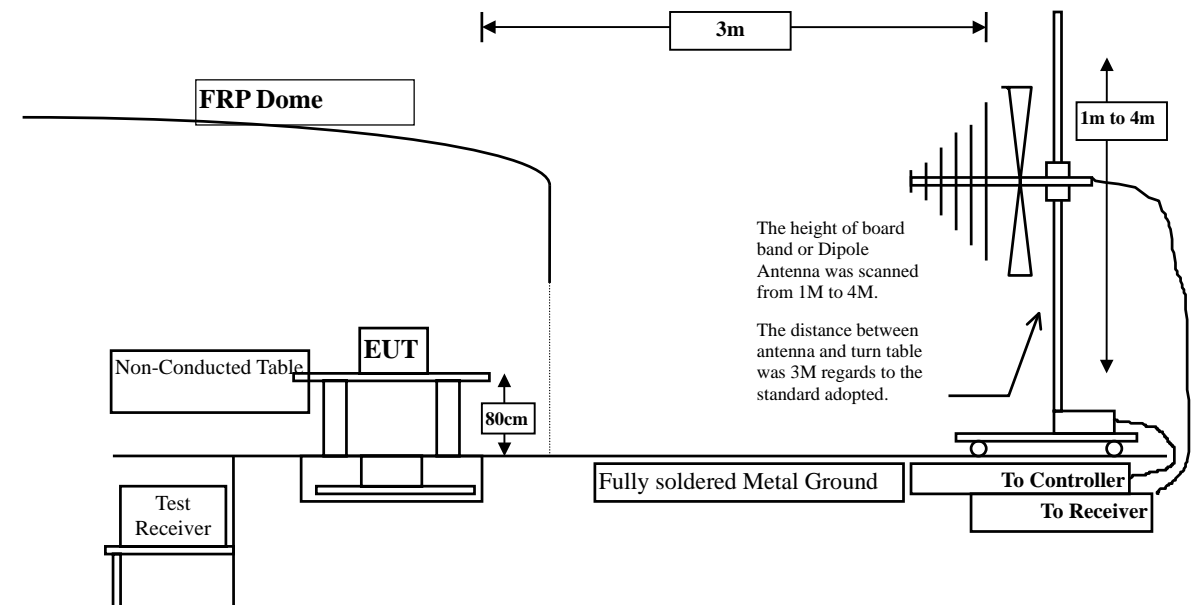

Above 1GHz

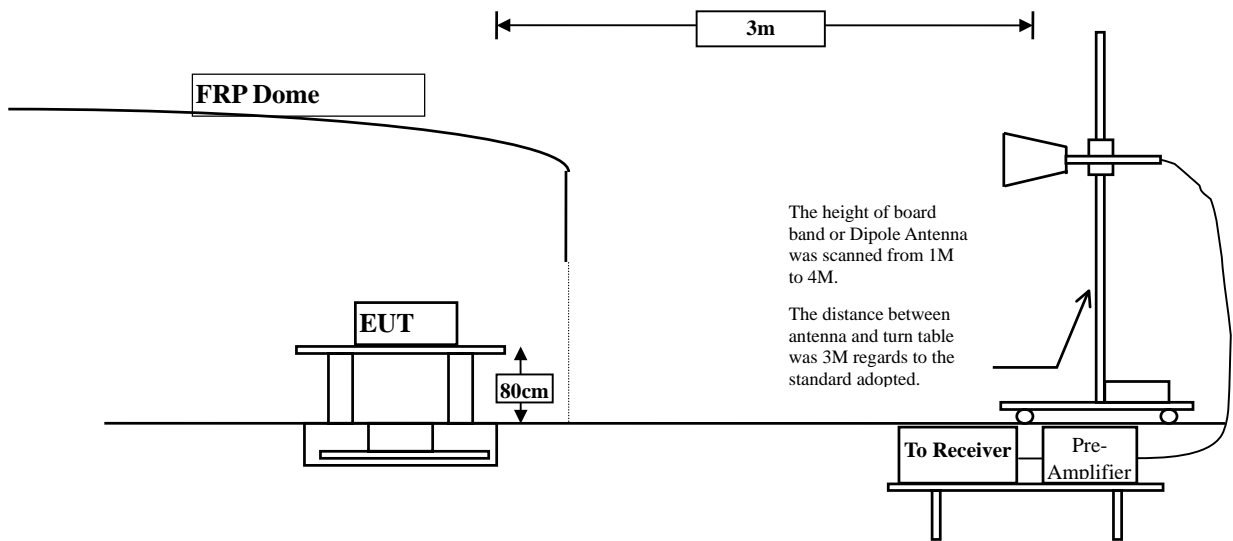

4.3. Limits

➤ General Radiated Emission Limits

Emissions radiated outside of the specified frequency bands, except for harmonics, shall be attenuated by at least 20dB below the level of the fundamental or to the general radiated emission limits in paragraph 15.209, whichever is the lesser attenuation.

FCC Part 15 Subpart C Paragraph 15.209 Limits		
Frequency MHz	uV/m @3m	dBuV/m@3m
30-88	100	40
88-216	150	43.5
216-960	200	46
Above 960	500	54

- Remarks:
1. RF Voltage (dBuV) = 20 log RF Voltage (uV)
 2. In the Above Table, the tighter limit applies at the band edges.
 3. Distance refers to the distance in meters between the measuring instrument antenna and the closed point of any part of the device or system.

4.4. Test Procedure

The EUT was setup according to ANSI C63.10, 2009 and tested according to FHSS test procedure of FCC Public Notice DA 00-705 for compliance to FCC 47CFR 15.247 requirements.

The EUT is placed on a turn table which is 0.8 meter above ground. The turn table is rotated 360 degrees to determine the position of the maximum emission level. The EUT was positioned such that the distance from antenna to the EUT was 3 meters.

The antenna is scanned from 1 meter to 4 meters to find out the maximum emission level. This is repeated for both horizontal and vertical polarization of the antenna. In order to find the maximum emission, all of the interface cables were manipulated according to ANSI C63.10, 2009 on radiated measurement.

The resolution bandwidth below 1GHz setting on the field strength meter is 120 kHz and above 1GHz is 1MHz.

Radiated emission measurements below 1GHz are made using broadband Bilog antenna and above 1GHz are made using Horn Antennas.

The measurement is divided into the Preliminary Measurement and the Final Measurement.

The suspected frequencies are searched for in Preliminary Measurement with the measurement antenna kept pointed at the source of the emission both in azimuth and elevation, with the polarization of the antenna oriented for maximum response. The antenna is pointed at an angle towards the source of the emission, and the EUT is rotated in both height and polarization to maximize the measured emission. The emission is kept within the illumination area of the 3 dB bandwidth of the antenna.

The worst radiated emission is measured on the Final Measurement.

The measurement frequency range form 30MHz - 10th Harmonic of fundamental was investigated.

4.5. Uncertainty

± 3.9 dB above 1GHz

± 3.8 dB below 1GHz

4.6. Test Result of Radiated Emission

Product : Bluetooth Wireless Keyboard
 Test Item : Harmonic Radiated Emission
 Test Site : No.3 OATS
 Test Mode : Mode 1: Transmit - 1Mbps (GFSK) (2402MHz)

Frequency MHz	Correct Factor dB	Reading Level dBuV	Measurement Level dBuV/m	Margin dB	Limit dBuV/m
Horizontal					
Peak Detector:					
4804.000	3.327	45.240	48.567	-25.433	74.000
7206.000	10.136	40.100	50.236	-23.764	74.000
9608.000	13.706	45.840	59.546	-7.238	66.784
12010.000	16.843	43.040	59.883	-14.117	74.000
Average					
Detector:					
9608.000	13.706	35.450	49.156	-8.008	57.164
12010.000	16.843	31.020	47.863	-6.137	54.000
Vertical					
Peak Detector:					
4804.000	6.638	42.770	49.407	-24.593	74.000
7206.000	11.005	42.240	53.245	-20.755	74.000
9608.000	14.103	48.680	62.783	-4.574	67.357
12010.000	17.659	42.490	60.149	-13.851	74.000
Average					
Detector:					
9608.000	14.103	38.410	52.513	-5.014	57.527
12010.000	17.659	30.870	48.529	-5.471	54.000

Note:

- All Readings below 1GHz are Quasi-Peak, above 1GHz are performed with peak and/or average measurements as necessary.
- Peak measurements: RBW = 1MHz, VBW = 3 MHz, Sweep: Auto.
- Average measurements: RBW = 1MHz, VBW = 10 Hz, Sweep: Auto.
- Measurement Level = Reading Level + Correct Factor.
- Correct Factor = Antenna factor + Cable loss – Amplifier gain.
- The average measurement was not performed when the peak measured data under the limit of average detection.
- The emission levels of other frequencies are very lower than the limit and not show in test report.
- “”, means non-restricted bands, limit=fundamental level down 20dBc.

Product : Bluetooth Wireless Keyboard
 Test Item : Harmonic Radiated Emission
 Test Site : No.3 OATS
 Test Mode : Mode 1: Transmit - 1Mbps (GFSK) (2441MHz)

Frequency MHz	Correct Factor dB	Reading Level dBuV	Measurement Level dBuV/m	Margin dB	Limit dBuV/m
Horizontal					
Peak Detector:					
4882.000	3.001	41.350	44.351	-29.649	74.000
7323.000	11.846	38.760	50.607	-23.393	74.000
9764.000	12.563	43.510	56.073	-17.927	74.000
12205.000	16.651	37.870	54.520	-19.480	74.000
Average					
Detector:					
9764.000	12.563	32.510	45.073	-8.927	54.000
12205.000	16.651	25.050	41.700	-12.300	54.000
Vertical					
Peak Detector:					
4882.000	5.713	42.860	48.574	-25.426	74.000
7323.000	12.727	38.980	51.708	-22.292	74.000
9764.000	13.028	47.930	60.958	-13.042	74.000
12205.000	16.886	41.970	58.856	-15.144	74.000
Average					
Detector:					
9764.000	13.028	36.890	49.918	-4.082	54.000
12205.000	16.886	30.340	47.226	-6.774	54.000

Note:

1. All Readings below 1GHz are Quasi-Peak, above 1GHz are performed with peak and/or average measurements as necessary.
2. Peak measurements: RBW = 1MHz, VBW = 3 MHz, Sweep: Auto.
3. Average measurements: RBW = 1MHz, VBW = 10 Hz, Sweep: Auto.
4. Measurement Level = Reading Level + Correct Factor.
5. Correct Factor = Antenna factor + Cable loss – Amplifier gain.
6. The average measurement was not performed when the peak measured data under the limit of average detection.
7. The emission levels of other frequencies are very lower than the limit and not show in test report.

Product : Bluetooth Wireless Keyboard
 Test Item : Harmonic Radiated Emission
 Test Site : No.3 OATS
 Test Mode : Mode 1: Transmit - 1Mbps (GFSK) (2480MHz)

Frequency MHz	Correct Factor dB	Reading Level dBuV	Measurement Level dBuV/m	Margin dB	Limit dBuV/m
Horizontal					
Peak Detector:					
4960.000	2.760	41.670	44.430	-29.570	74.000
7440.000	12.567	37.140	49.706	-24.294	74.000
9920.000	13.456	47.110	60.566	-7.740	68.306
12400.000	16.886	36.350	53.237	-20.763	74.000
Average Detector:					
9920.000	13.456	36.460	49.916	-8.480	58.396
Vertical					
Peak Detector:					
4960.000	5.557	43.700	49.257	-24.743	74.000
7440.000	13.426	38.600	52.025	-21.975	74.000
9920.000	13.958	50.010	63.968	-4.584	68.552
12400.000	17.155	38.790	55.945	-18.055	74.000
Average Detector:					
9920.000	13.958	39.670	53.628	-5.144	58.772
12400.000	17.155	26.420	43.575	-10.425	54.000

Note:

1. All Readings below 1GHz are Quasi-Peak, above 1GHz are performed with peak and/or average measurements as necessary.
2. Peak measurements: RBW = 1MHz, VBW = 3 MHz, Sweep: Auto.
3. Average measurements: RBW = 1MHz, VBW = 10 Hz, Sweep: Auto.
4. Measurement Level = Reading Level + Correct Factor.
5. Correct Factor = Antenna factor + Cable loss – Amplifier gain.
6. The average measurement was not performed when the peak measured data under the limit of average detection.
7. The emission levels of other frequencies are very lower than the limit and not show in test report.
8. “■”, means non-restricted bands, limit=fundamental level down 20dBc.

Product : Bluetooth Wireless Keyboard
 Test Item : General Radiated Emission
 Test Site : No.3 OATS
 Test Mode : Mode 1: Transmit - 1Mbps (GFSK) (2441MHz)

Frequency MHz	Correct Factor dB	Reading Level dBuV	Measurement Level dBuV/m	Margin dB	Limit dBuV/m
Horizontal					
291.900	-4.174	36.013	31.838	-14.162	46.000
388.900	-1.684	32.892	31.208	-14.792	46.000
518.880	1.714	35.224	36.938	-9.062	46.000
780.780	4.230	31.730	35.960	-10.040	46.000
813.760	5.098	29.836	34.934	-11.066	46.000
988.360	7.110	25.592	32.702	-21.298	54.000
Vertical					
41.640	-1.809	33.426	31.617	-8.383	40.000
291.900	-8.004	39.595	31.590	-14.410	46.000
388.900	-3.064	29.899	26.835	-19.165	46.000
518.880	-0.546	32.138	31.592	-14.408	46.000
691.540	2.421	29.678	32.099	-13.901	46.000
780.780	3.060	31.379	34.439	-11.561	46.000

Note:

1. All Readings below 1GHz are Quasi-Peak, above 1GHz are performed with peak and/or average measurements as necessary.
2. Peak measurements: RBW = 1MHz, VBW = 3 MHz, Sweep: Auto.
3. Average measurements: RBW = 1MHz, VBW = 10 Hz, Sweep: Auto.
4. Measurement Level = Reading Level + Correct Factor.
5. Correct Factor = Antenna factor + Cable loss – Amplifier gain.
6. The average measurement was not performed when the peak measured data under the limit of average detection.
7. The emission levels of other frequencies are very lower than the limit and not show in test report.

5. RF Antenna Conducted Test

5.1. Test Equipment

	Equipment	Manufacturer	Model No./Serial No.	Last Cal.
	Spectrum Analyzer	R&S	FSP40 / 100170	Jun., 2013
	Spectrum Analyzer	Agilent	E4407B / US39440758	Jun., 2013
X	Spectrum Analyzer	Agilent	N9010A / MY48030495	Apr., 2013

Note: 1. All equipments are calibrated every one year.
 2. The test instruments Marked “X” are used to measure the final test results.

5.2. Test Setup

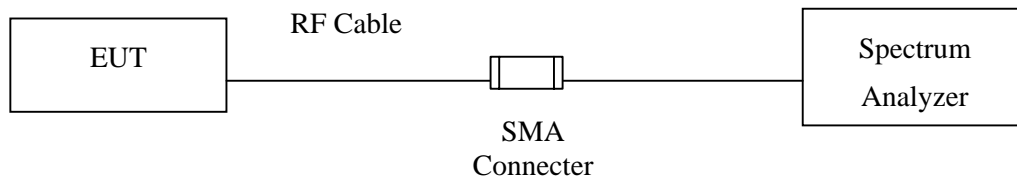

5.3. Limits

According to FCC Section 15.247(d). In any 100 kHz bandwidth outside the frequency band in which the spread spectrum or digitally modulated intentional radiator is operating, the radio frequency power that is produced by the intentional radiator shall be at least 20 dB below that in the 100 kHz bandwidth within the band that contains the highest level of the desired power, based on either an RF conducted or measurement, provided the transmitter demonstrates compliance with the peak conducted power limits. If the transmitter complies with the conducted power limits based on the use of RMS averaging over a time interval, the attenuation required under this paragraph shall be 30 dB instead of 20 dB.

5.4. Test Procedure

The EUT was setup to ANSI C63.10, 2009; tested to FHSS test procedure of FCC Public Notice DA 00-705 for compliance to FCC 47CFR 15.247 requirements.

5.5. Uncertainty

± 150Hz

5.6. Test Result of RF Antenna Conducted Test

Product : Bluetooth Wireless Keyboard
 Test Item : RF Antenna Conducted Test
 Test Site : No.3 OATS
 Test Mode : Mode 1: Transmit - 1Mbps (GFSK) (2402MHz)

Figure Channel 00:

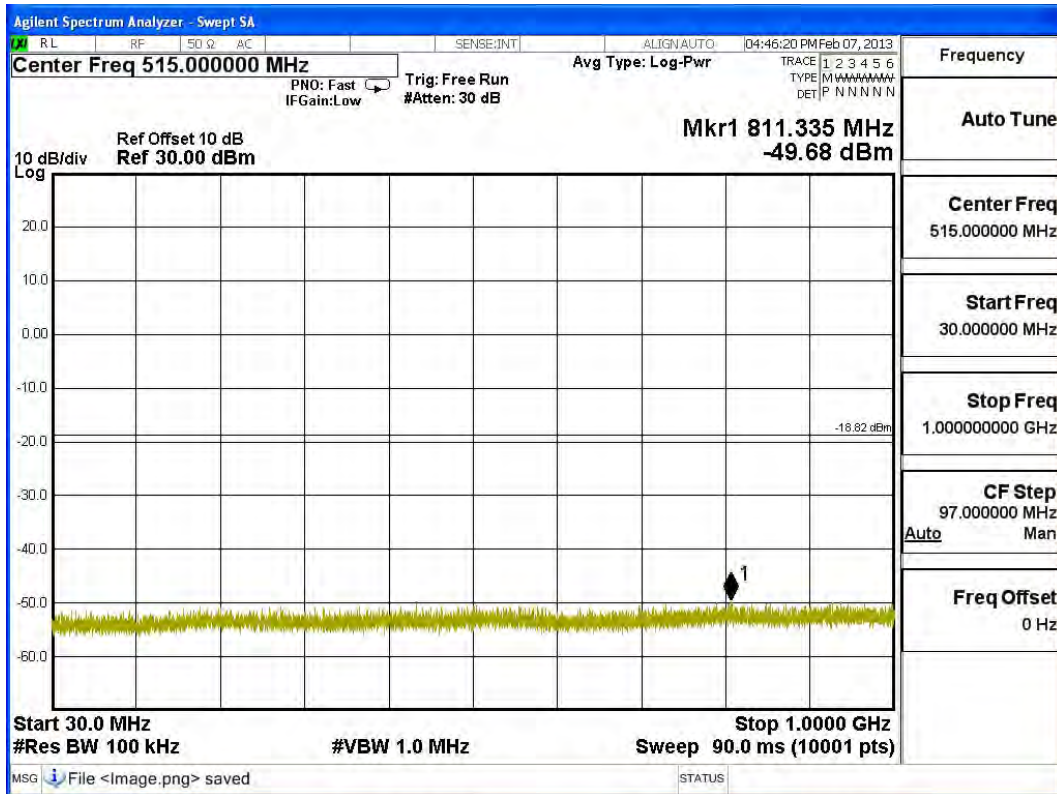

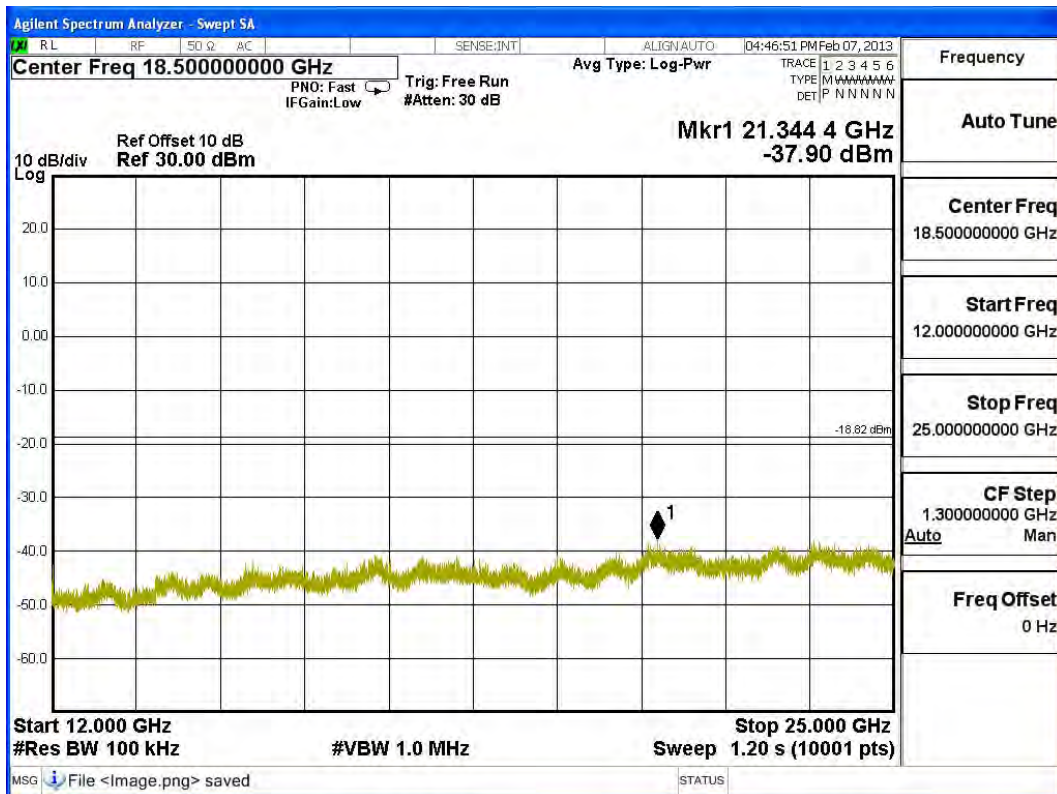
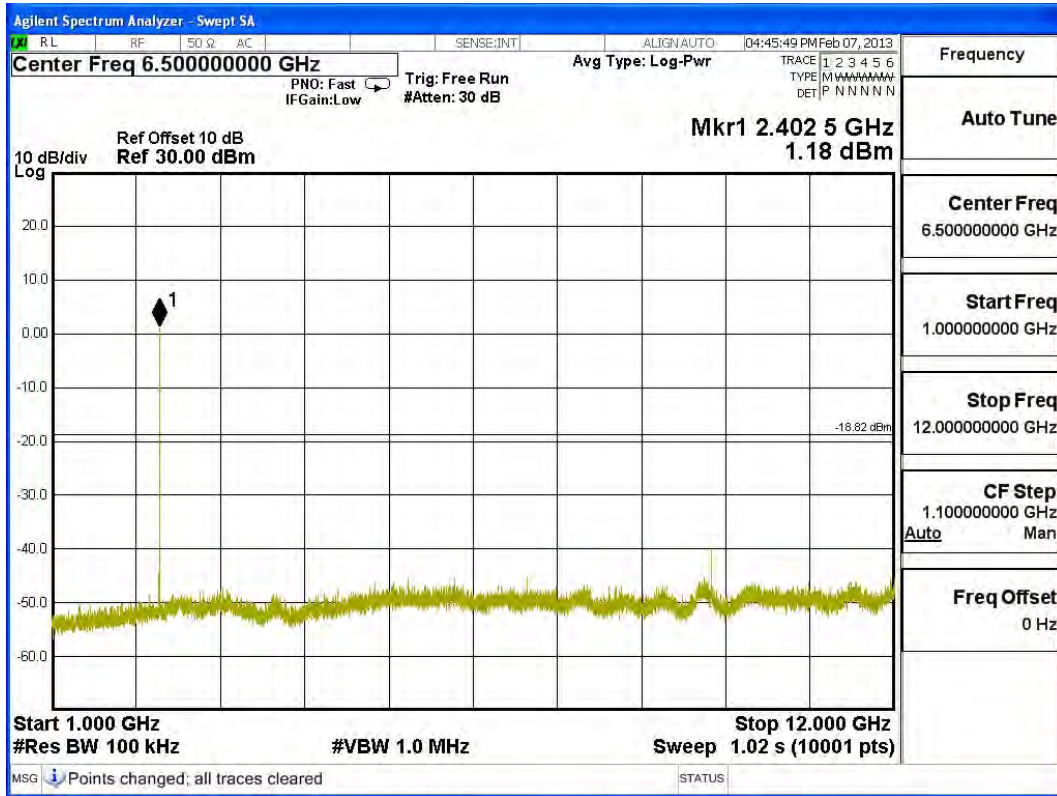

Product : Bluetooth Wireless Keyboard
 Test Item : RF Antenna Conducted Test
 Test Site : No.3 OATS
 Test Mode : Mode 1: Transmit - 1Mbps (GFSK) (2441MHz)

Figure Channel 39:

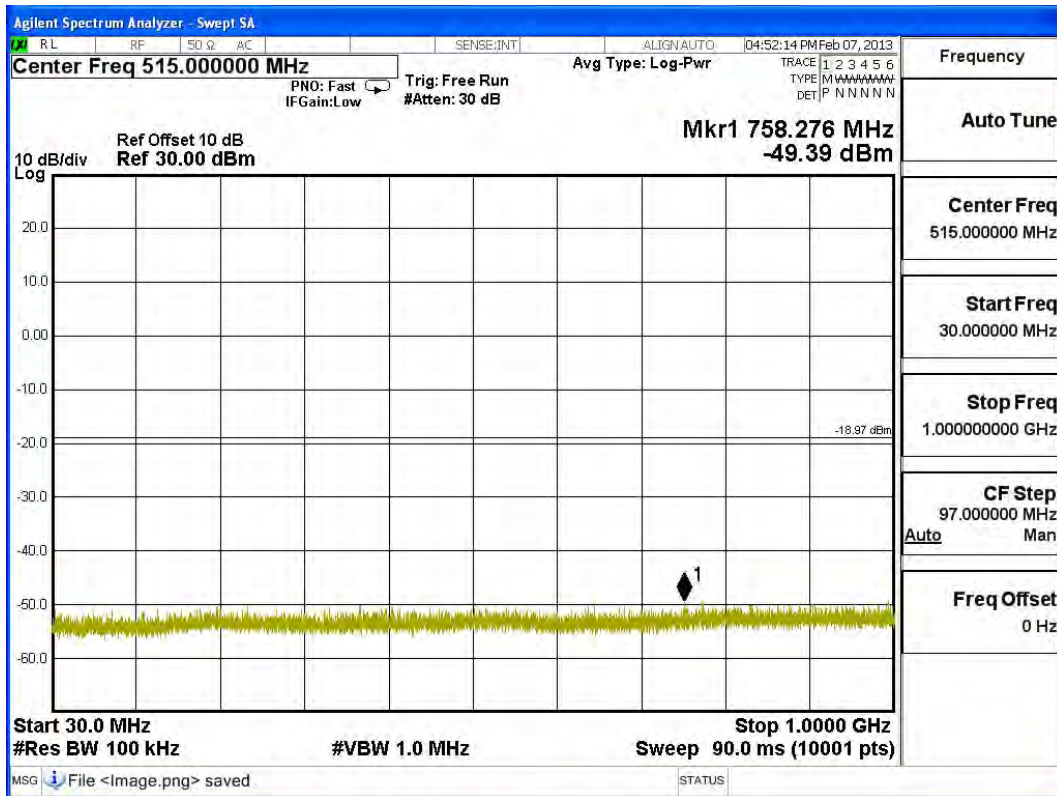

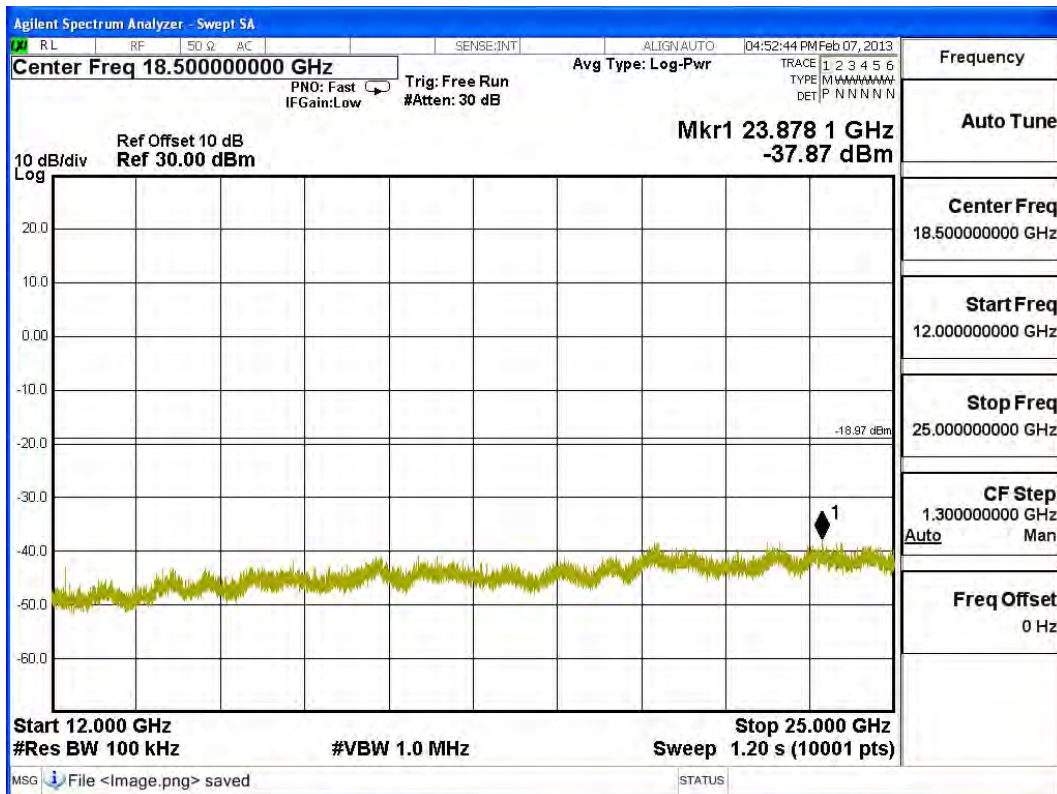
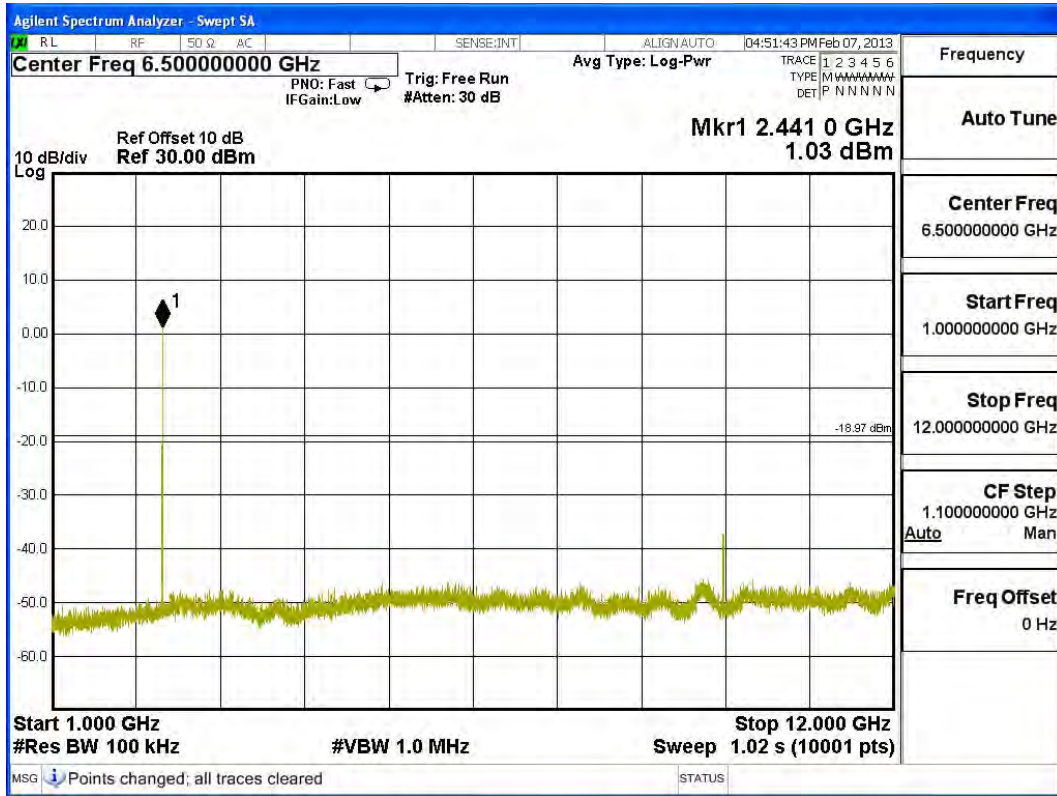

Product : Bluetooth Wireless Keyboard
 Test Item : RF Antenna Conducted Test
 Test Site : No.3 OATS
 Test Mode : Mode 1: Transmit - 1Mbps (GFSK) (2480MHz)

Figure Channel 78:

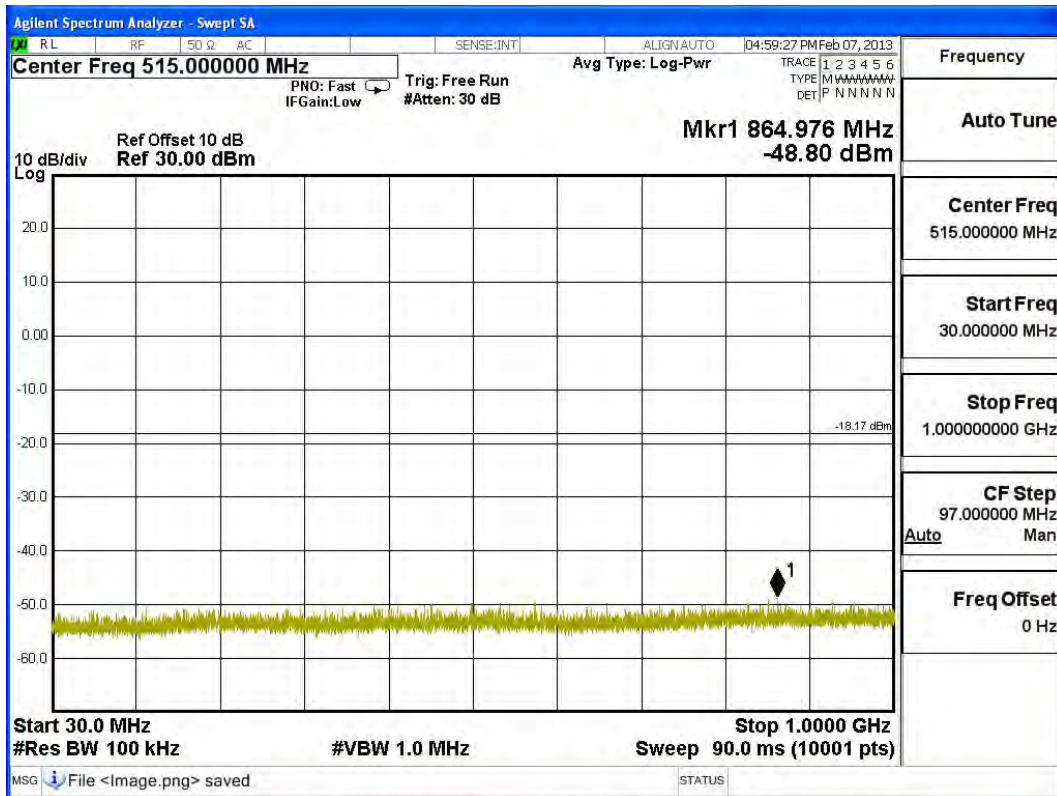

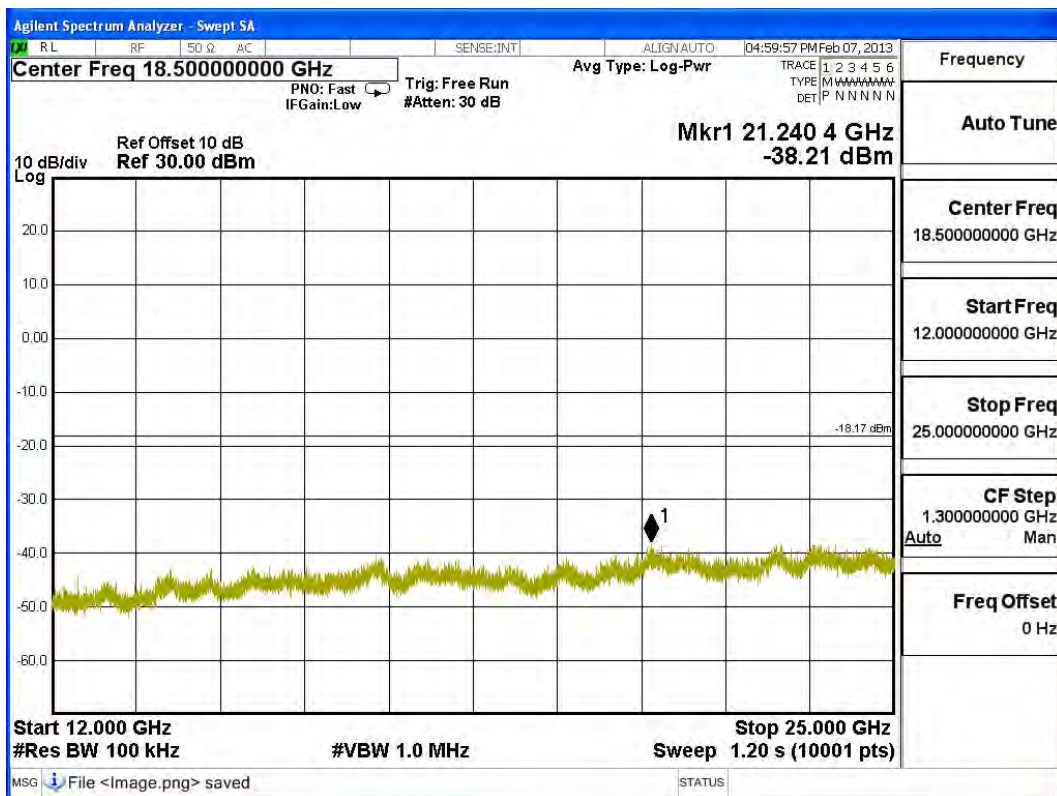
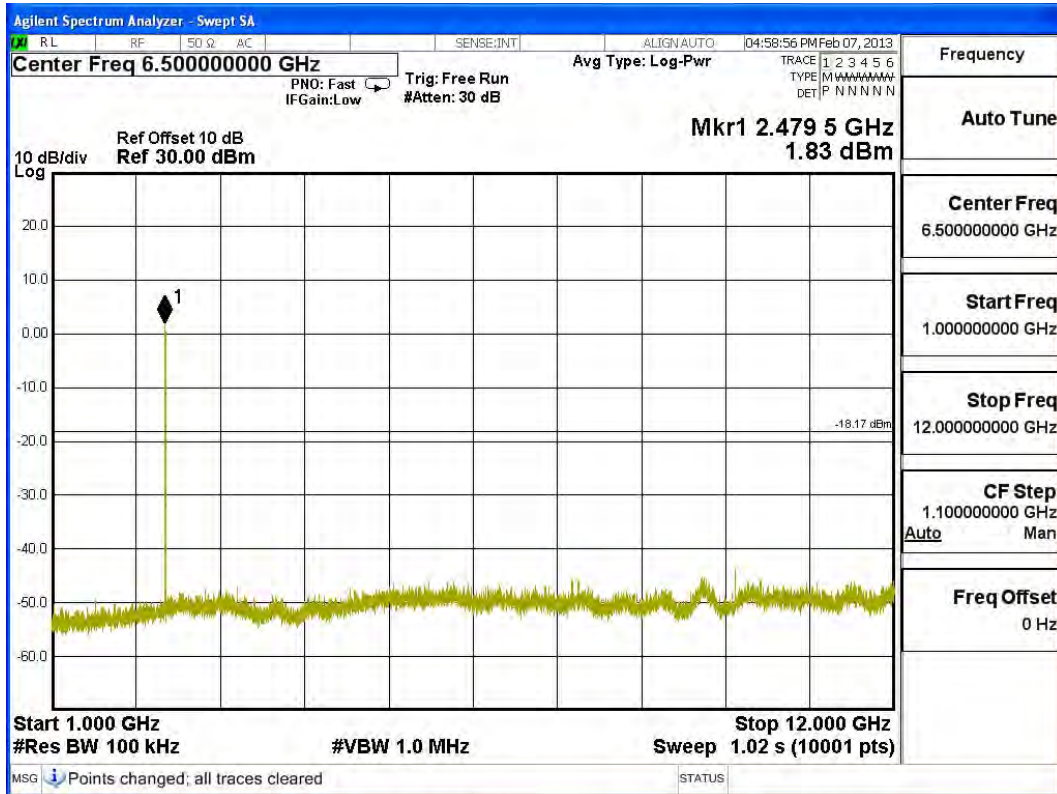

6. Band Edge

6.1. Test Equipment

RF Conducted Measurement

The following test equipments are used during the band edge tests:

	Equipment	Manufacturer	Model No./Serial No.	Last Cal.
	Spectrum Analyzer	R&S	FSP40 / 100170	Jun, 2013
	Spectrum Analyzer	Agilent	E4407B / US39440758	Jun, 2013
X	Spectrum Analyzer	Agilent	N9010A / MY48030495	Apr., 2013

RF Radiated Measurement:

The following test equipments are used during the band edge tests:

Test Site		Equipment	Manufacturer	Model No./Serial No.	Last Cal.
☒ Site # 3		Bilog Antenna	Schaffner Chase	CBL6112B/2673	Sep., 2013
	X	Horn Antenna	Schwarzbeck	BBHA9120D/D305	Sep., 2013
		Horn Antenna	Schwarzbeck	BBHA9170/208	Jul., 2013
	X	Pre-Amplifier	Agilent	8447D/2944A09549	Sep., 2013
	X	Spectrum Analyzer	Agilent	E4407B / US39440758	May, 2013
		Test Receiver	R & S	ESCS 30/ 825442/018	Sep., 2013
	X	Coaxial Cable	Quietek	QTK-CABLE/ CAB5	Feb., 2014
	X	Controller	Quietek	QTK-CONTROLLER/ CTRL3	N/A
	X	Coaxial Switch	Anritsu	MP59B/6200265729	N/A

- Note:
1. All equipments are calibrated every one year.
 2. The test instruments marked by "X" are used to measure the final test results.

6.2. Test Setup

RF Conducted Measurement

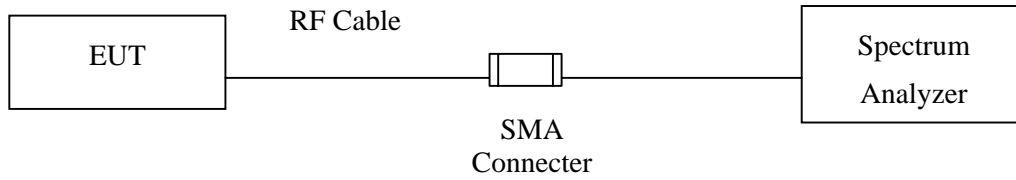

RF Radiated Measurement:

Above 1GHz

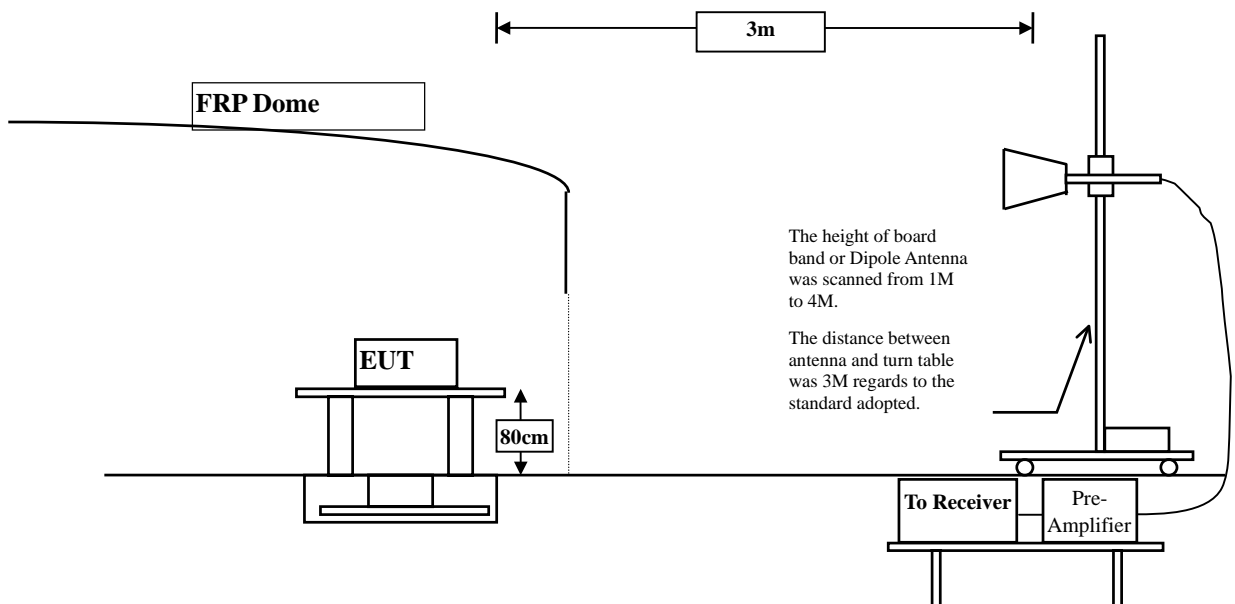

6.3. Limit

In any 100 kHz bandwidth outside the frequency band in which the spread spectrum intentional radiator is operating, the radio frequency power that is produced by the intentional radiator shall be at least 20 dB below that in the 100 kHz bandwidth within the band that contains the highest level of the desired power, based on either an RF conducted or a radiated measurement. Attenuation below the general limits specified in Section 15.209(a) is not required. In addition, radiated emissions which fall in the restricted bands, as defined in Section 15.205(a), must also comply with the radiated emission limits specified in Section 15.209(a) (see Section 15.205(c)).

6.4. Test Procedure

The EUT and its simulators are placed on a turn table which is 0.8 meter above ground. The turn table can rotate 360 degrees to determine the position of the maximum emission level. The EUT was positioned such that the distance from antenna to the EUT was 3 meters.

The antenna can move up and down between 1 meter and 4 meters to find out the maximum emission level.

Both horizontal and vertical polarization of the antenna are set on measurement. In order to find the maximum emission, all of the interface cables must be manipulated according to ANSI C63.4:2003 on radiated measurement.

The bandwidth below 1GHz setting on the field strength meter is 120 kHz, above 1GHz are 1 MHz. The EUT was setup to ANSI C63.10, 2009; tested to FHSS test procedure of FCC Public Notice DA 00-705 for compliance to FCC 47CFR 15.247 requirements.

6.5. Uncertainty

± 3.9 dB above 1GHz

± 3.8 dB below 1GHz

6.6. Test Result of Band Edge

Product : Bluetooth Wireless Keyboard
 Test Item : Band Edge
 Test Site : No.3 OATS
 Test Mode : Mode 1: Transmit - 1Mbps (GFSK)

Fundamental Filed Strength

Antenna Pole	Frequency [MHz]	Correction Factor [dB/m]	Reading Level [dBuV]	Emission Level [dBuV/m]	Detector
Horizontal	2402	31.573	55.21	86.784	Peak
Horizontal	2402	31.573	45.59	77.164	Average
Vertical	2402	30.917	56.44	87.357	Peak
Vertical	2402	30.917	46.61	77.527	Average

Note: 1: Spectrum Analyzer setting:

Peak detector: RBW=1MHz, VBW=1MHz

Average detector: RBW=1MHz, VBW=10Hz

Band Edge Test Data

Antenna Pole	Test Frequency (MHz)	Fundamental (dBuV/m)	Δ (dB)	Band Edge Field Strength (dBuV/m)	Limit (dBuV/m)	Detector
Horizontal	2388.1	86.784	47.78	39.004	74.000	Peak
Horizontal	2354	77.164	51.8	25.364	54.000	Average
Vertical	2388.1	87.357	47.78	39.577	74.000	Peak
Vertical	2354	77.527	51.8	25.727	54.000	Average

Note:

The Band Edge Field Strength was calculated using the Fundamental and Conducted Band Edge measurements per the Marker-Delta Method with the following formula:

Band Edge field Strength = F - Δ

F = Fundamental field Strength (Peak or Average)

Δ = Conducted Band Edge Delta (Peak or Average)

Peak Detector of conducted Band Edge Delta

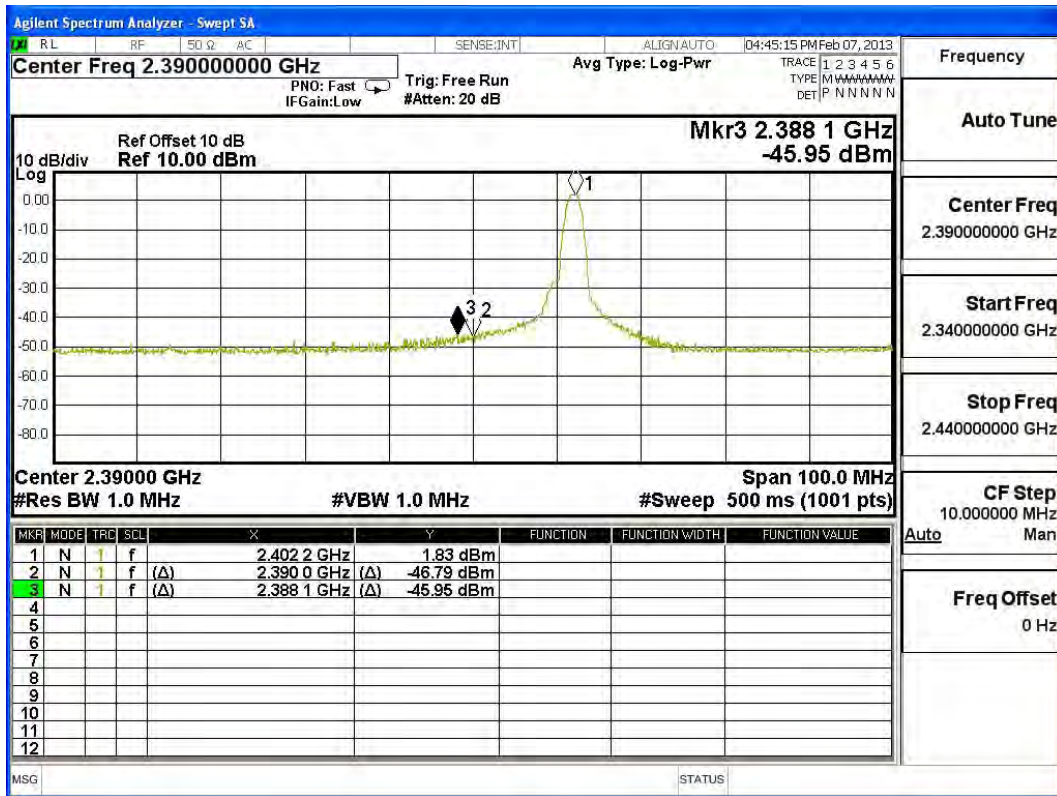

Average Detector of conducted Band Edge Delta

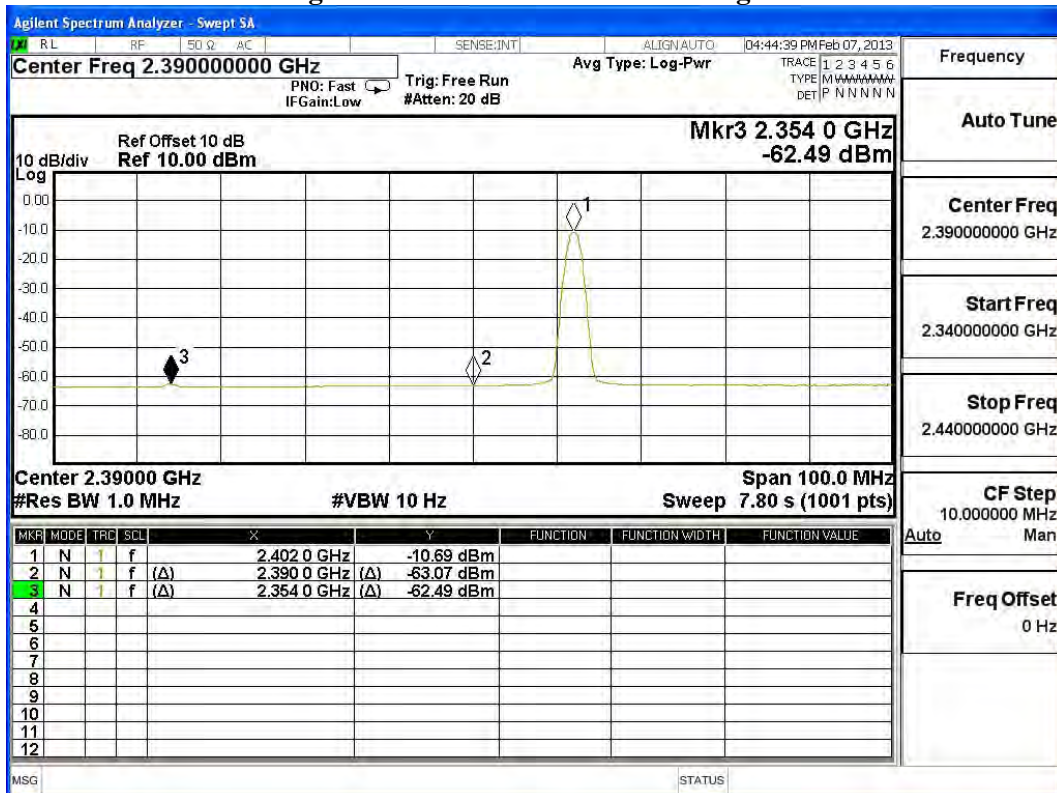

Product : Bluetooth Wireless Keyboard
 Test Item : Band Edge
 Test Site : No.3 OATS
 Test Mode : Mode 1: Transmit - 1Mbps (GFSK)

Fundamental Filed Strength

Antenna Pole	Frequency [MHz]	Correction Factor [dB/m]	Reading Level [dBuV]	Emission Level [dB(uV/m)]	Detector
Horizontal	2480	32.155	56.15	88.306	Peak
Horizontal	2480	32.155	46.24	78.396	Average
Vertical	2480	31.412	57.14	88.552	Peak
Vertical	2480	31.412	47.36	78.772	Average

Note: 1:Spectrum Analyzer setting:

Peak detector: RBW=1MHz, VBW=1MHz

Average detector: RBW=1MHz, VBW=10Hz

Band Edge Test Data

Antenna Pole	Test Frequency (MHz)	Fundamental (dBuV/m)	Δ (dB)	Band Edge Field Strength (dBuV/m)	Limit (dBuV/m)	Detector
Horizontal	2483.6	88.306	40.1	48.206	74.000	Peak
Horizontal	2483.5	78.396	51.32	27.076	54.000	Average
Vertical	2483.6	88.552	40.1	48.452	74.000	Peak
Vertical	2483.5	78.772	51.32	27.452	54.000	Average

Note:

The Band Edge Field Strength was calculated using the Fundamental and Conducted Band Edge measurements per the Marker-Delta Method with the following formula:

Band Edge field Strength = F - Δ

F = Fundamental field Strength (Peak or Average)

Δ = Conducted Band Edge Delta (Peak or Average)

Peak Detector of conducted Band Edge Delta

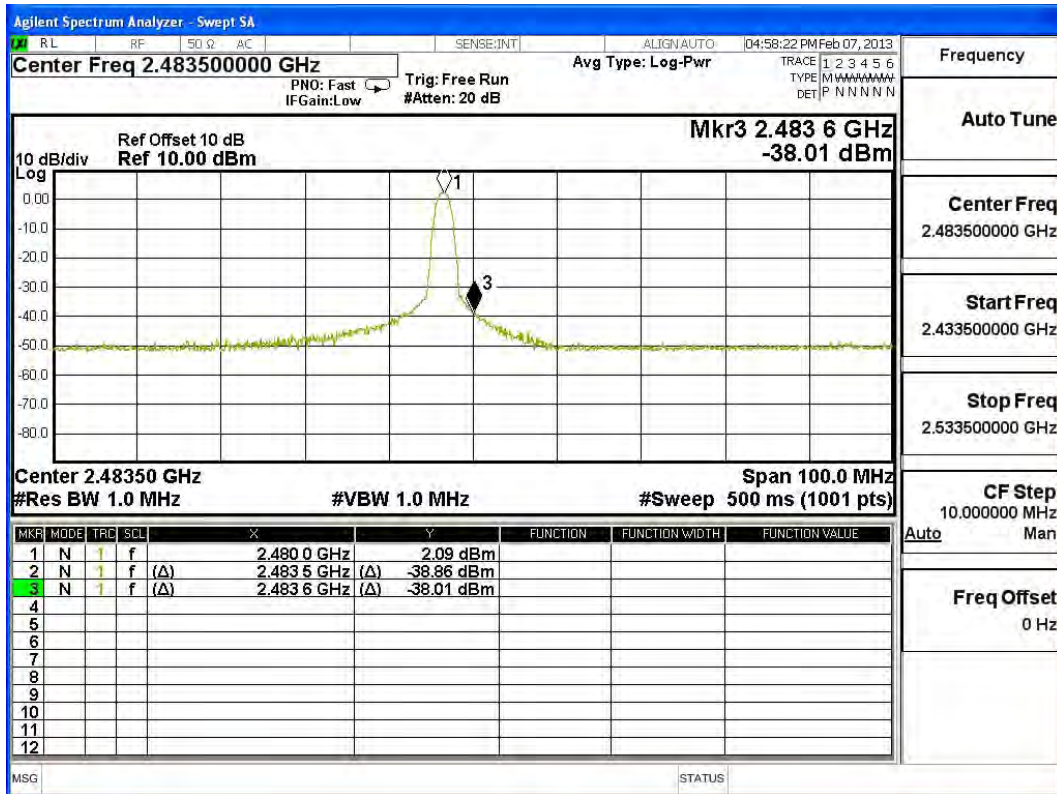

Average Detector of conducted Band Edge Delta

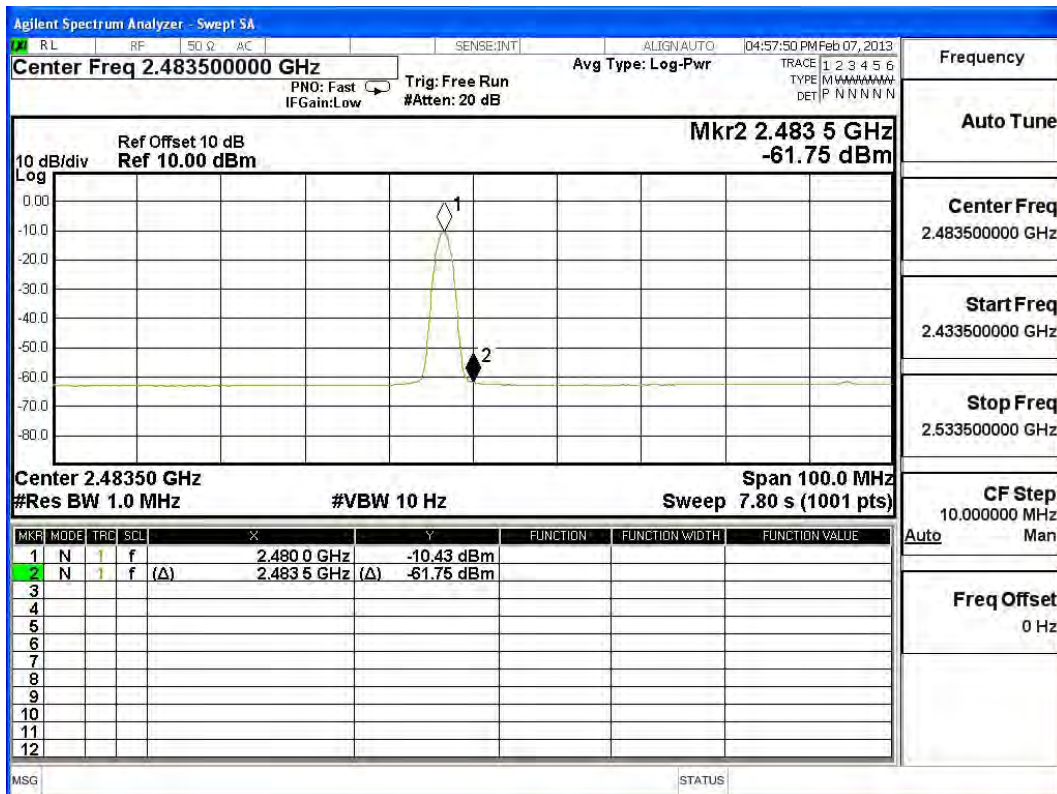

7. Channel Number

7.1. Test Equipment

	Equipment	Manufacturer	Model No./Serial No.	Last Cal.
	Spectrum Analyzer	R&S	FSP40 / 100170	Jun., 2013
	Spectrum Analyzer	Agilent	E4407B / US39440758	Jun., 2013
X	Spectrum Analyzer	Agilent	N9010A / MY48030495	Apr., 2013

Note: 1. All equipments are calibrated every one year.
 2. The test instruments marked by “X” are used to measure the final test results.

7.2. Test Setup

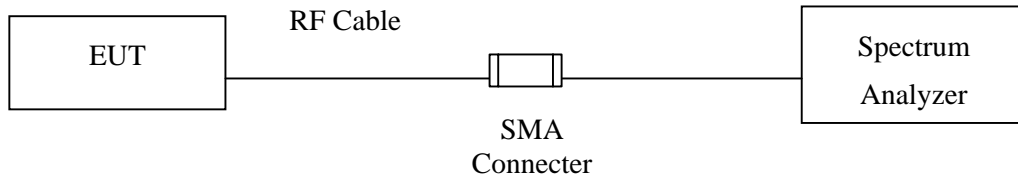

7.3. Limit

Frequency hopping systems operating in the 2400-2483.5 MHz bands shall use at least 75 hopping frequencies.

7.4. Test Procedure

The EUT was setup to ANSI C63.10, 2009; tested to FHSS test procedure of FCC Public Notice DA 00-705 for compliance to FCC 47CFR 15.247 requirements.

7.5. Uncertainty

N/A

7.6. Test Result of Channel Number

Product : Bluetooth Wireless Keyboard
 Test Item : Channel Number
 Test Site : No.3 OATS
 Test Mode : Mode 1: Transmit - 1Mbps (GFSK)

Frequency Range (MHz)	Measurement (Hopping Channel)	Required Limit (Hopping Channel)	Result
2402 ~ 2480	79	>75	Pass

2402-2421MHz

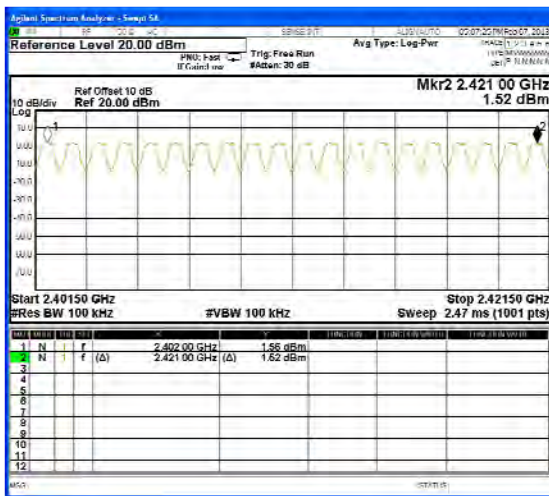

2422-2441MHz

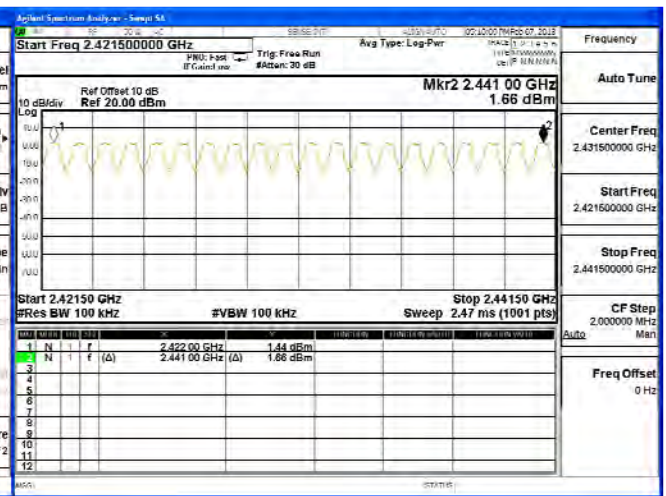

2442-2461MHz

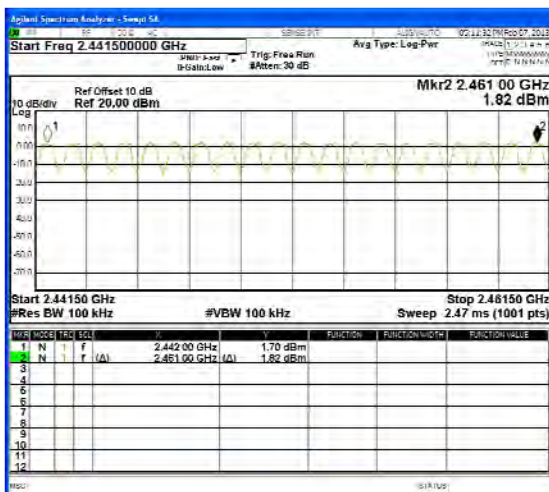

2462-2480MHz

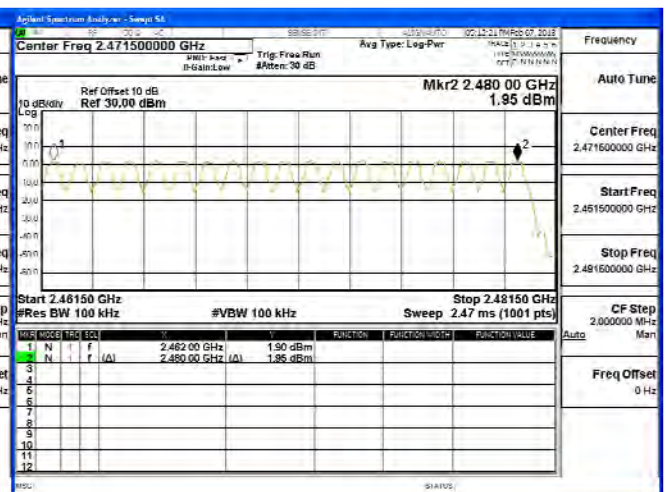

8. Channel Separation

8.1. Test Equipment

	Equipment	Manufacturer	Model No./Serial No.	Last Cal.
	Spectrum Analyzer	R&S	FSP40 / 100170	Jun., 2013
	Spectrum Analyzer	Agilent	E4407B / US39440758	Jun., 2013
X	Spectrum Analyzer	Agilent	N9010A / MY48030495	Apr., 2013

Note: 1. All equipments are calibrated every one year.
 2. The test instruments mark by "X" are used to measure the final test results.

8.2. Test Setup

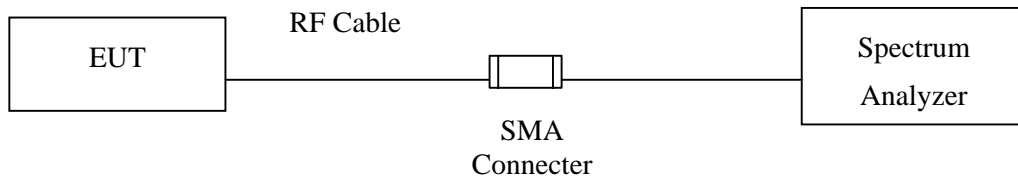

8.3. Limit

Frequency hopping systems shall have hopping channel carrier frequencies separated by a minimum of 25 kHz or the 20 dB bandwidth of the hopping channel, whichever is greater.

8.4. Test Procedure

The EUT was setup to ANSI C63.10, 2009; tested to FHSS test procedure of FCC Public Notice DA 00-705 for compliance to FCC 47CFR 15.247 requirements.

8.5. Uncertainty

± 150Hz

8.6. Test Result of Channel Separation

Product : Bluetooth Wireless Keyboard
 Test Item : Channel Separation
 Test Site : No.3 OATS
 Test Mode : Mode 1: Transmit - 1Mbps (GFSK)

Channel No.	Frequency (MHz)	Measurement Level (kHz)	Limit (kHz)	Limit of (2/3)*20dB Bandwidth (kHz)	Result
00	2402	1000	>25 kHz	766.7	Pass
39	2441	1000	>25 kHz	766.7	Pass
78	2480	1000	>25 kHz	766.7	Pass

NOTE: The 20dB Bandwidth is refer to section 10.

Channel 00 2402MHz

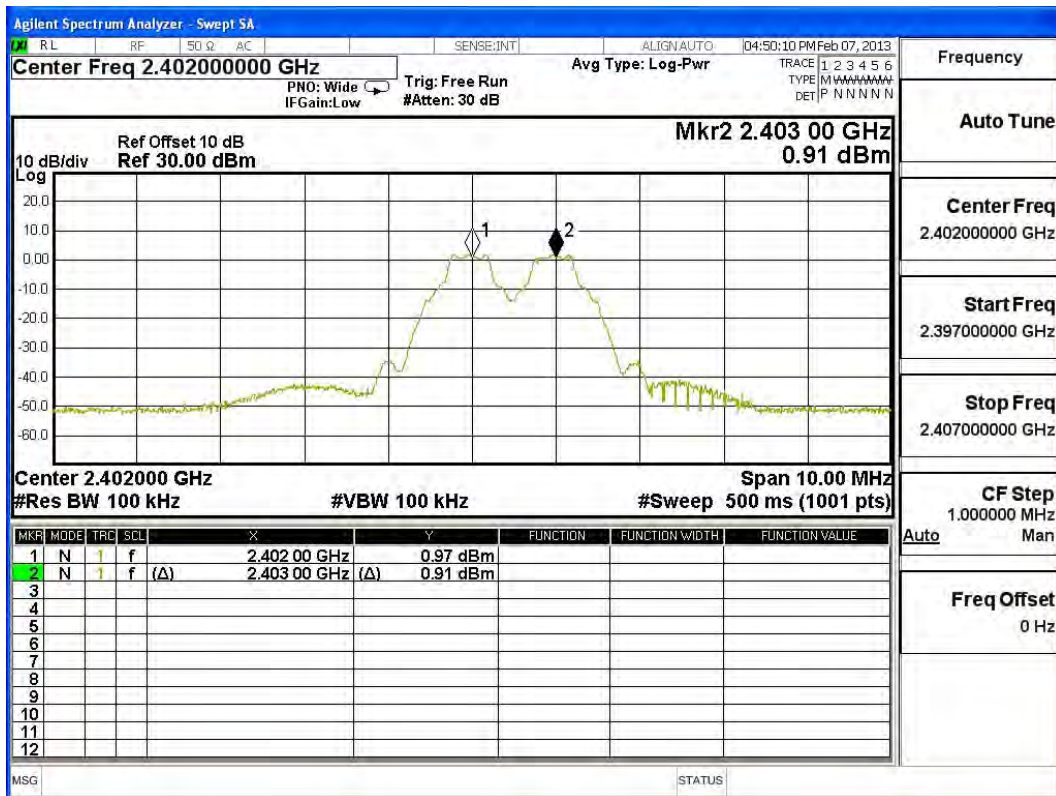

Channel 39 2441MHz

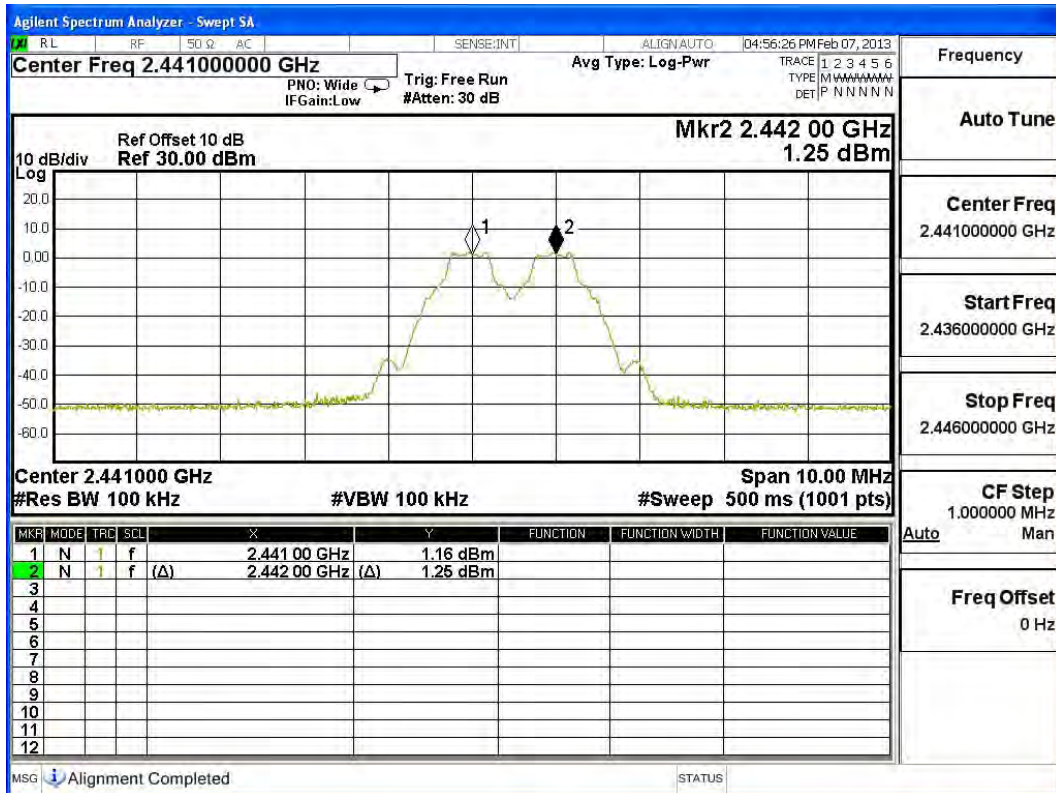

Channel 78 2480 MHz

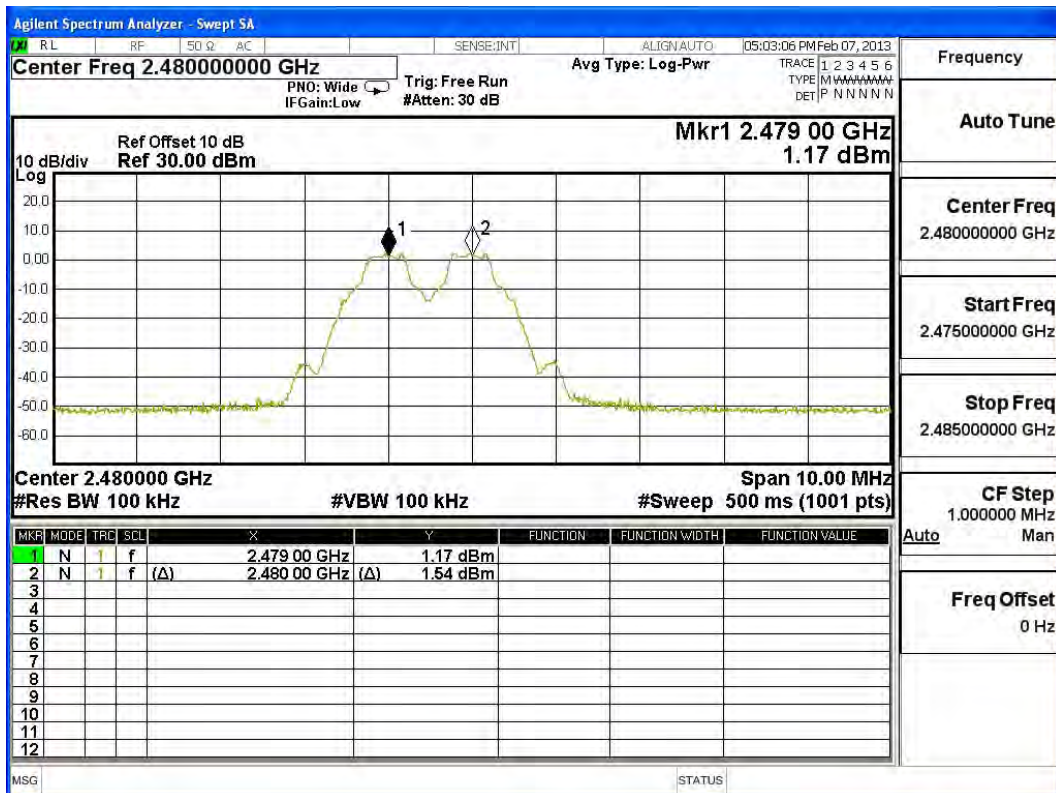

9. Dwell Time

9.1. Test Equipment

	Equipment	Manufacturer	Model No./Serial No.	Last Cal.
	Spectrum Analyzer	R&S	FSP40 / 100170	Jun., 2013
	Spectrum Analyzer	Agilent	E4407B / US39440758	Jun., 2013
X	Spectrum Analyzer	Agilent	N9010A / MY48030495	Apr., 2013

Note: 1. All equipments are calibrated every one year.
 2. The test instruments marked by “X” are used to measure the final test results.

9.2. Test Setup

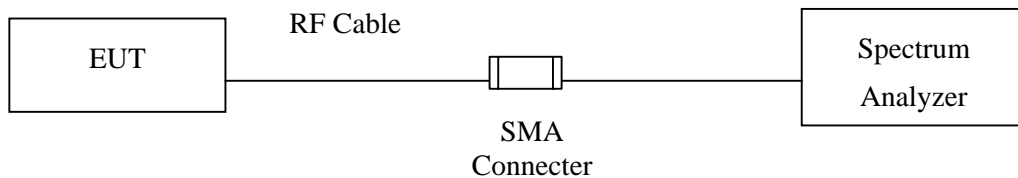

9.3. Limit

The dwell time shall be the average time of occupancy on any frequency shall not be greater than 0.4 seconds within a 30 second period.

9.4. Test Procedure

The EUT was setup to ANSI C63.10, 2009; tested to FHSS test procedure of FCC Public Notice DA 00-705 for compliance to FCC 47CFR 15.247 requirements.

9.5. Uncertainty

± 25msec

9.6. Test Result of Dwell Time

Product : Bluetooth Wireless Keyboard
 Test Item : Dwell Time
 Test Site : No.3 OATS
 Test Mode : Mode 1: Transmit - 1Mbps (GFSK) (Channel 00,39,78 –DH5)

Frequency (MHz)	Time slot length (ms)	Hopping of Number	Sweep time (ms)	Duty cycle	Dwell Time (Sec)	Limit (Sec)	Result
2402	2.930	13	50	0.76	0.305	0.4	Pass
2441	2.920	13	50	0.76	0.304	0.4	Pass
2480	2.930	13	50	0.76	0.305	0.4	Pass

Duty cycle = ((Time slot length(ms)*Hopping of Number) / Sweep time (ms))

Dwell time = (Duty cycle / 79) * (79*0.4)

CH 00 Time Interval between hops

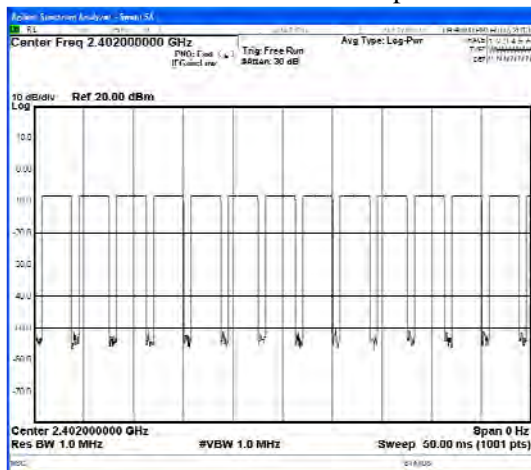

CH 00 Transmission Time

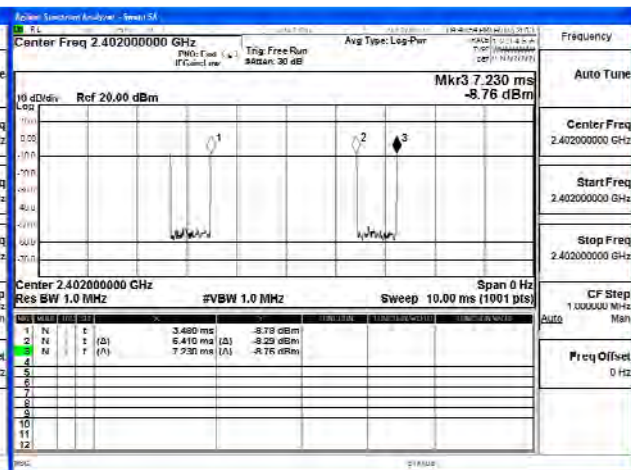

CH39 Time Interval between hops

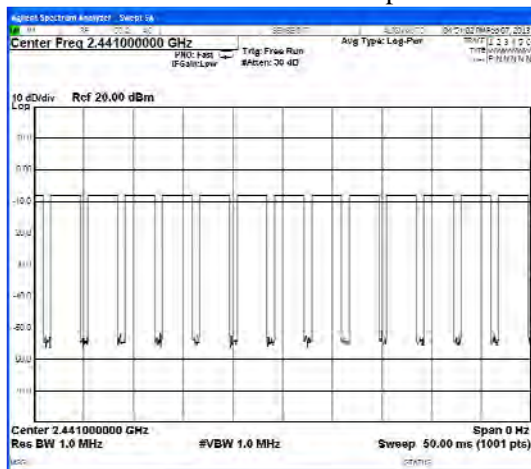

CH 39 Transmission Time

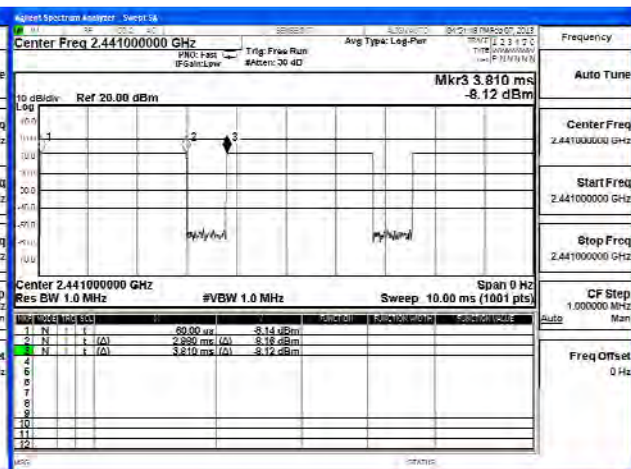

CH 78 Time Interval between hops

CH 78 Transmission Time

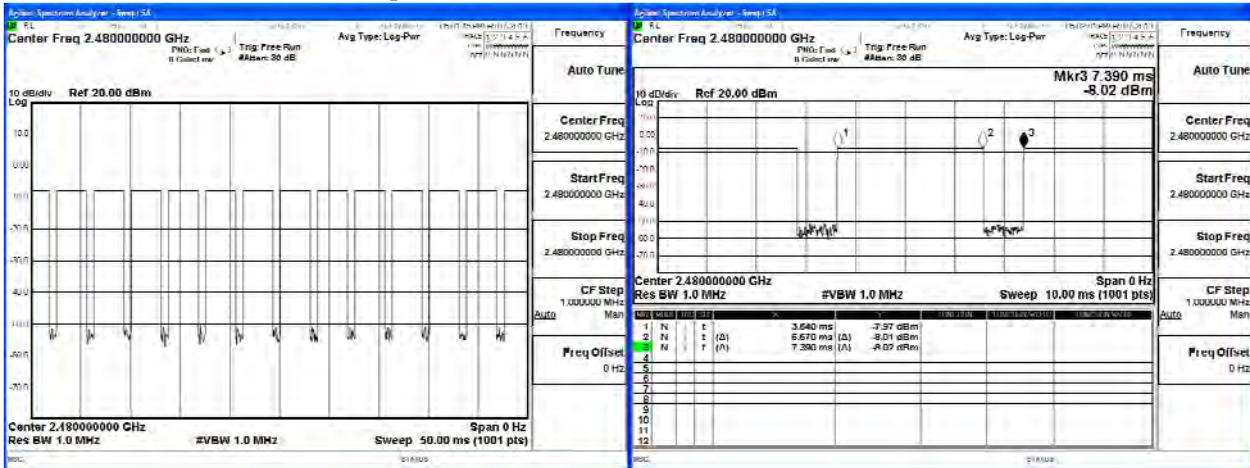

Note:

The dwell times of the packet type of DH1, DH3, and DH5 are tested. Only the worst case is shown on the report.

10. Occupied Bandwidth

10.1. Test Equipment

Equipment	Manufacturer	Model No./Serial No.	Last Cal.
Spectrum Analyzer	R&S	FSP40 / 100170	Jun., 2013
Spectrum Analyzer	Agilent	E4407B / US39440758	Jun., 2013
X Spectrum Analyzer	Agilent	N9010A / MY48030495	Apr., 2013

- Note: 1. All equipments are calibrated every one year.
 2. The test instruments marked by “X” are used to measure the final test results.

10.2. Test Setup

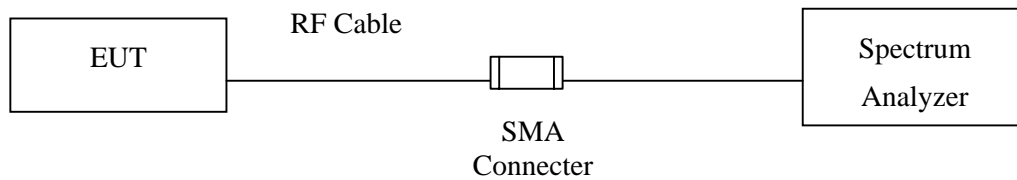

10.3. Limits

N/A

10.4. Test Procedure

The EUT was setup to ANSI C63.10, 2009; tested to FHSS test procedure of FCC Public Notice DA 00-705 for compliance to FCC 47CFR 15.247 requirements.

10.5. Uncertainty

± 150Hz

10.6. Test Result of Occupied Bandwidth

Product : Bluetooth Wireless Keyboard
 Test Item : Occupied Bandwidth Data
 Test Site : No.3 OATS
 Test Mode : Mode 1: Transmit - 1Mbps (GFSK) (2402MHz)

Channel No.	Frequency (MHz)	Measurement Level (kHz)	Required Limit (kHz)	Result
00	2402	1150	--	NA

Figure Channel 00:

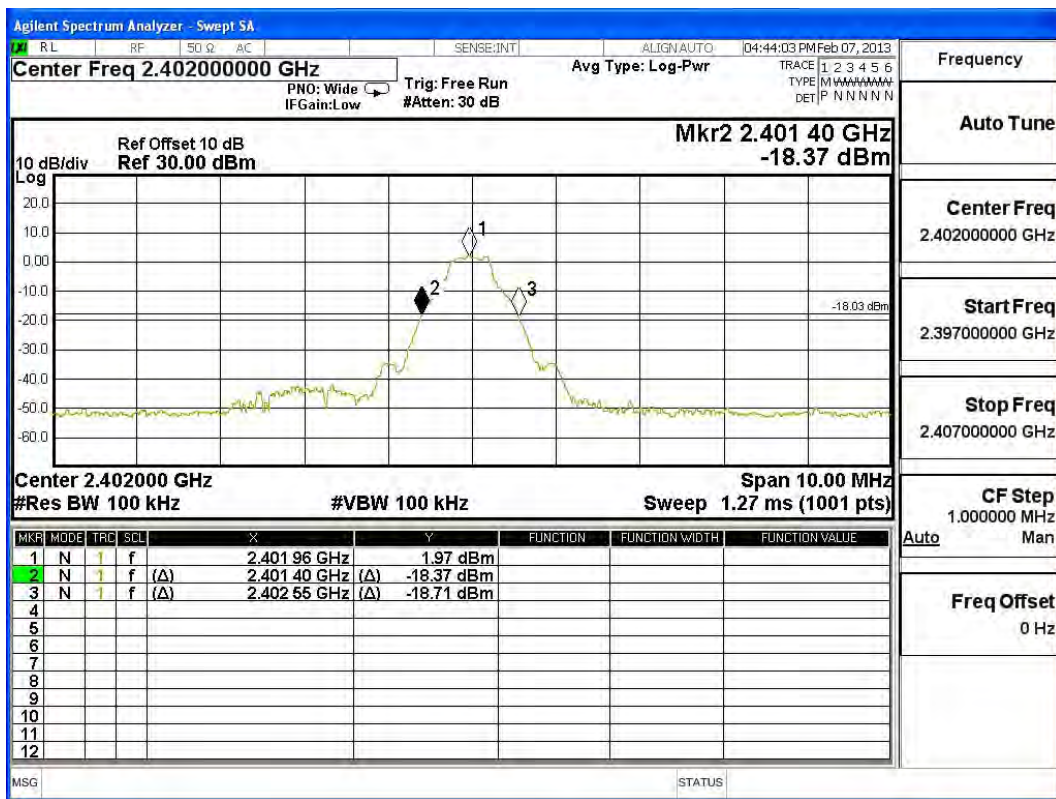

Product : Bluetooth Wireless Keyboard
 Test Item : Occupied Bandwidth Data
 Test Site : No.3 OATS
 Test Mode : Mode 1: Transmit - 1Mbps (GFSK) (2441MHz)

Channel No.	Frequency (MHz)	Measurement Level (kHz)	Required Limit (kHz)	Result
39	2441	1150	--	NA

Figure Channel 39:

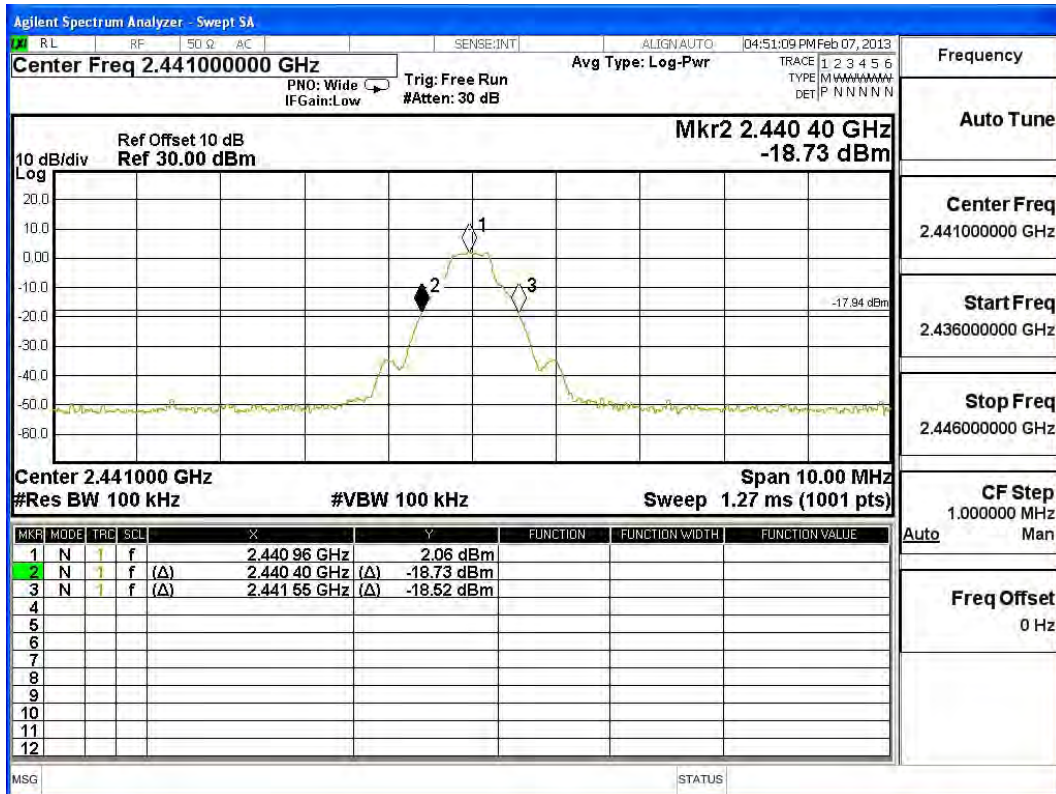

Product : Bluetooth Wireless Keyboard
 Test Item : Occupied Bandwidth Data
 Test Site : No.3 OATS
 Test Mode : Mode 1: Transmit - 1Mbps (GFSK) (2480MHz)

Channel No.	Frequency (MHz)	Measurement Level (kHz)	Required Limit (kHz)	Result
78	2480	1150	--	NA

Figure Channel 78:

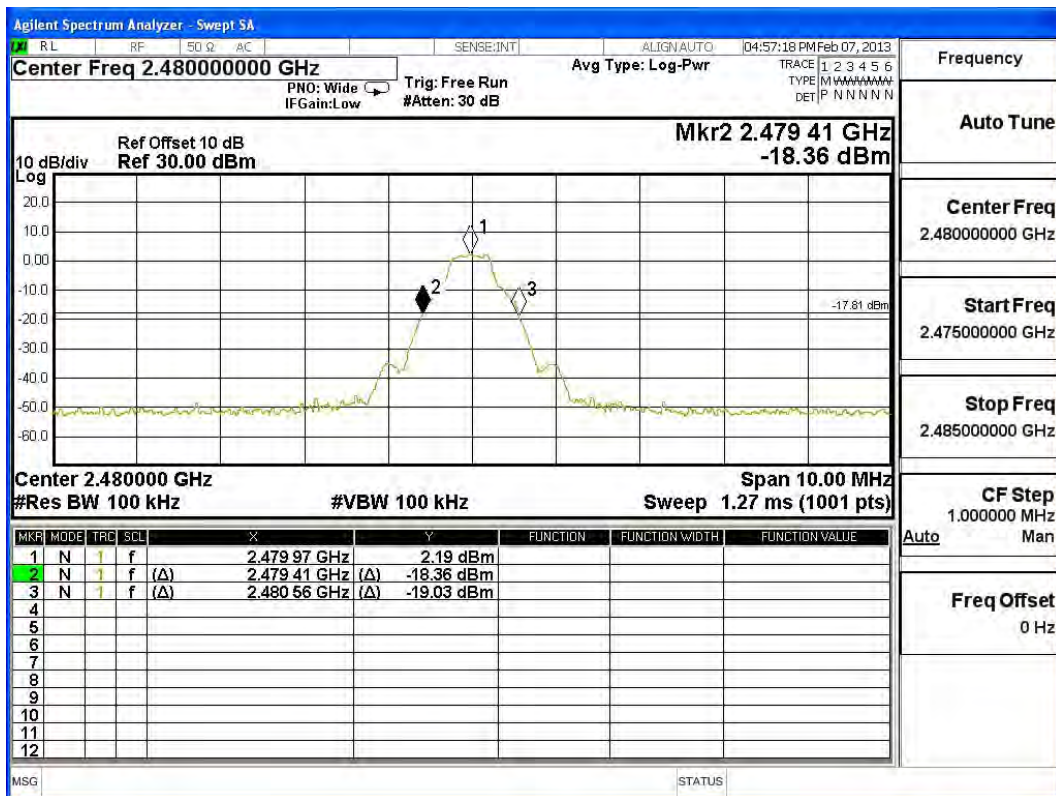

11. EMI Reduction Method During Compliance Testing

No modification was made during testing.