

INSPIRON™

SETUP GUIDE



INSPIRON™

SETUP GUIDE

Regulatory model: P08T

Regulatory type: P08T001

Notes, Cautions, and Warnings

 **NOTE:** A NOTE indicates important information that helps you make better use of your computer.

 **CAUTION:** A CAUTION indicates either potential damage to hardware or loss of data and tells you how to avoid the problem.

 **WARNING:** A WARNING indicates a potential for property damage, personal injury, or death.

Information in this document is subject to change without notice.

© 2010 Dell Inc. All rights reserved.

Reproduction of these materials in any manner whatsoever without the written permission of Dell Inc. is strictly forbidden.

Trademarks used in this text: *Dell*, the *DELL* logo, *Inspiron*, *YOURS IS HERE*, *Solution Station*, and *DellConnect* are trademarks of Dell Inc.; *Intel* is a registered trademark and *Atom* is a trademark of Intel Corporation in the U.S. and other countries; *Microsoft*, *Windows*, and the *Windows* start button logo are either trademarks or registered trademarks of Microsoft Corporation in the United States and/or other countries; *Bluetooth* is a registered trademark owned by Bluetooth SIG, Inc. and is used by Dell under license; *Blu-ray Disc* is a trademark of the Blu-ray Disc Association.

Other trademarks and trade names may be used in this document to refer to either the entities claiming the marks and names or their products. Dell Inc. disclaims any proprietary interest in trademarks and trade names other than its own.

October 2010

P/N KFPFD

Rev. A00

Contents

Setting Up Your Laptop	5	Disabling Battery Charging.	27
Before Setting Up Your Computer	5	Computer Base and Keyboard Features . . .	28
Connect the AC Adapter	6	Touch Pad Gestures.	30
Press the Power Button	7	Multimedia Control Keys.	32
Set Up Microsoft Windows.	8	Display Features	34
Create System Recovery Media (Recommended).	9	Using the Touch Screen	36
Install the SIM Card (Optional).	10	Software Features	40
Enable or Disable Wireless (Optional).	14	Dell DataSafe Online Backup	41
Connect to the Internet (Optional)	17	Free Fall Sensor	41
User Interface Modes	19	Solving Problems	42
Set Up the Tablet Mode.	20	Beep Codes	42
Right View Features.	22	Touch Screen Problems	43
Using Your Inspiron Laptop	22	Network Problems.	44
Left View Features.	24	Power Problems.	44
Status Lights and Indicators.	26	Memory Problems	46
		Lockups and Software Problems	46

Using Support Tools	49	Returning Items for Repair Under Warranty or for Credit	70
Dell Support Center	49	Before You Call	72
My Dell Downloads	50	Contacting Dell	74
System Messages	50		
Hardware Troubleshooter	53	Finding More Information and Resources	76
Dell Diagnostics	53	Specifications	78
Restoring Your Operating System	58	Appendix	84
System Restore	59	Macrovision Product Notice	84
Dell DataSafe Local Backup	60	Information for NOM, or Official Mexican Standard (Only for Mexico)	85
System Recovery Media	63	Index	86
Dell Factory Image Restore	64		
Getting Help	66		
Technical Support and Customer Service	67		
DellConnect	67		
Online Services	68		
Automated Order-Status Service	69		
Product Information	69		

Setting Up Your Laptop

This section provides information about setting up your Dell™ Inspiron™ laptop.

Before Setting Up Your Computer

When positioning your computer, ensure that you allow easy access to a power source, adequate ventilation, and a level surface to place your computer.

Restricting airflow around your laptop may cause it to overheat. To prevent overheating ensure that you leave at least 10.2 cm (4 inches) at the back of the computer and a minimum of 5.1 cm (2 inches) on all other sides. You should never place your computer in an enclosed space, such as a cabinet or drawer when it is powered on.

 **WARNING: Do not block, push objects into, or allow dust to accumulate in the air vents. Do not place your Dell computer in a low-airflow environment, such as a closed briefcase, or on fabric surfaces, such as carpets or rugs, while it is powered on. Restricting the airflow can damage the computer, deteriorate the computer performance, or cause a fire. The computer turns on the fan when the computer gets hot. Fan noise is normal and does not indicate a problem with the fan or the computer.**

 **CAUTION: Placing or stacking heavy or sharp objects on the computer may result in permanent damage to the computer.**

Connect the AC Adapter

Connect the AC adapter to the computer and then plug it into an electrical outlet or surge protector.

⚠ WARNING: The AC adapter works with electrical outlets worldwide. However, power connectors and power strips vary among countries. Using an incompatible cable or improperly connecting the cable to a power strip or electrical outlet may cause fire or permanent damage to your computer.

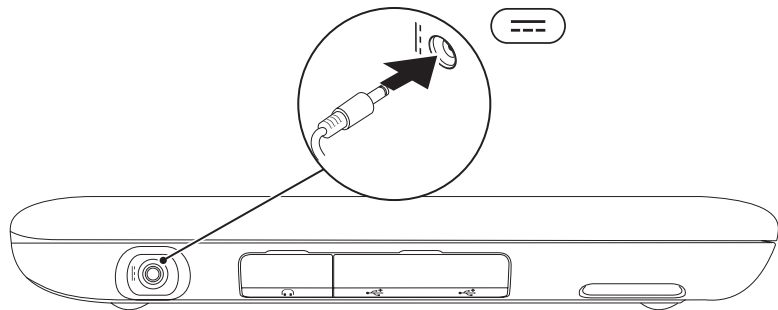

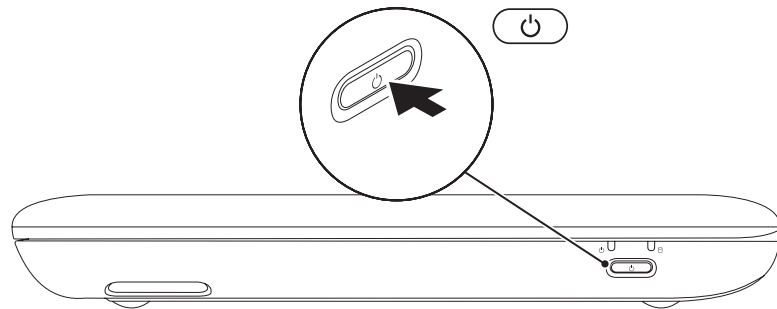

Press the Power Button



Set Up Microsoft Windows

To set up Microsoft® Windows® for the first time, follow the instructions on the screen. These steps are mandatory and may take some time to complete. The Windows setup screens will take you through several procedures including accepting license agreements, setting preferences, and setting up an Internet connection.

 **CAUTION:** Do not interrupt the operating system's setup process. Doing so may render your computer unusable and you will need to reinstall the operating system.

 **NOTE:** For optimal performance of your computer, it is recommended that you download and install the latest BIOS and drivers for your computer available at support.dell.com.

 **NOTE:** For more information on the operating system and features, go to support.dell.com/MyNewDell.

Create System Recovery Media (Recommended)

 **NOTE:** It is recommended that you create system recovery media as soon as you set up Microsoft Windows.

 **NOTE:** Your computer does not have an internal optical drive. Use an optional external optical drive or any external storage device for procedures that involve discs.

The system recovery media can be used to restore your computer to the operating state it was in when you purchased the computer, while preserving data files (without the need of the *Operating System* disc). You can use the system recovery media if changes to the hardware, software, drivers, or other system settings have left the computer in an undesirable operating state.

You will require the following to create the system recovery media:

- Dell DataSafe Local Backup
- USB key with a minimum capacity of 8 GB or DVD-R/DVD+R/Blu-ray Disc™

 **NOTE:** Dell DataSafe Local Backup does not support rewritable discs.

To create system recovery media:

1. Ensure that the AC adapter is connected (see “Connect the AC Adapter” on page 6).
2. Insert the disc or USB key in the computer.
3. Click **Start**  → **All Programs** → **Dell DataSafe Local Backup**.
4. Click **Create Recovery Media**.
5. Follow the instructions on the screen.

 **NOTE:** For information on restoring your operating system using the system recovery media, see “System Recovery Media” on page 63.

Install the SIM Card (Optional)

Installing a Subscriber Identity Module (SIM) card in your computer allows you to connect to the Internet. To access the Internet, you must be within the network of your cellular service provider.

To install the SIM card:

1. Turn off your computer.
2. Slide the label door off the computer base.

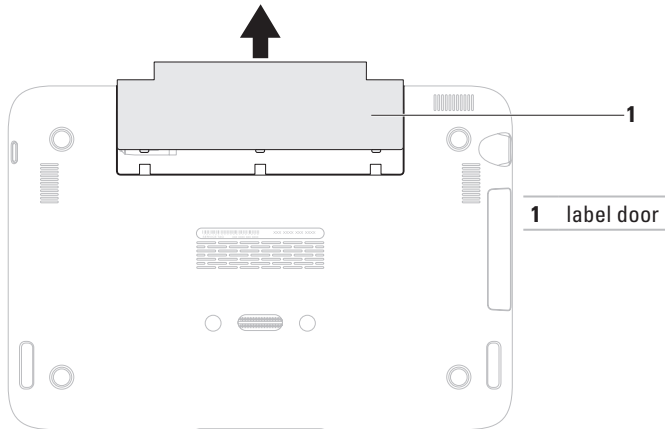

3. Slide the SIM card into the SIM card slot.
4. Replace the label door.
5. Turn on your computer.

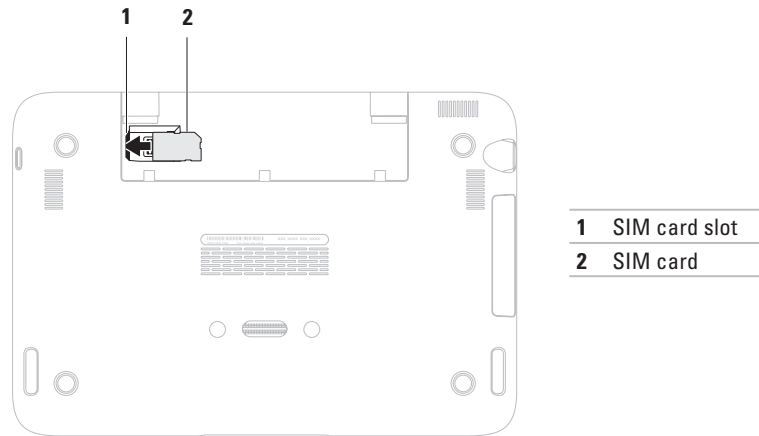

To remove the SIM card, press the release notch and slide the SIM card out of the SIM card slot.

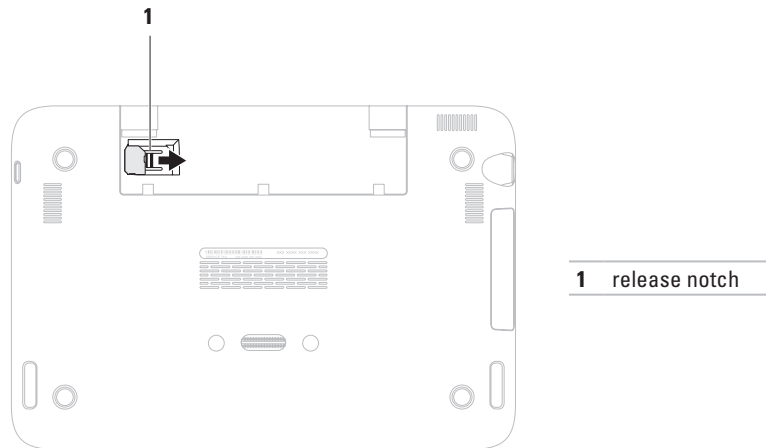

Enable or Disable Wireless (Optional)

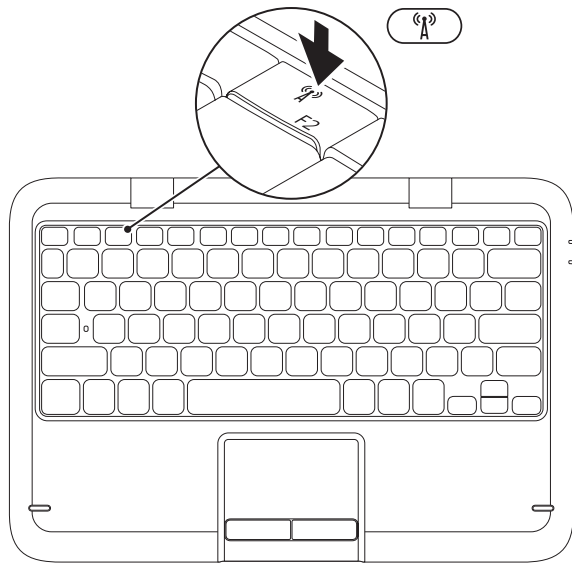

To enable or disable wireless:

1. Ensure that your computer is turned on.
2. Press the wireless key  on the function key row on the keyboard.
The current status of the wireless radios appears on the screen.

Wireless enabled

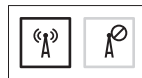

Wireless disabled

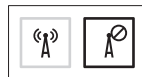

3. Press the wireless key  again to switch between the wireless enabled or disabled states.

 **NOTE:** The wireless key allows you to quickly turn off wireless radios (Wi-Fi and Bluetooth®), such as when you are asked to disable all wireless radios on an airplane flight.

CAUTION: Blocking the wireless antennas may affect the performance of the wireless connection.

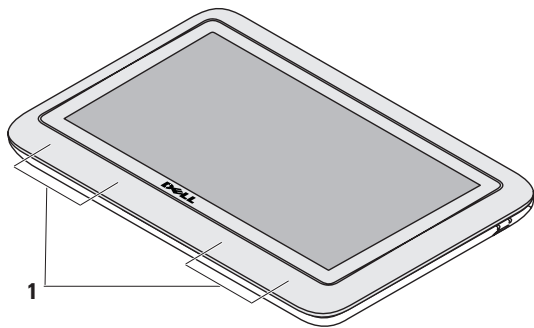

1 wireless antenna location

Connect to the Internet (Optional)

NOTE: Your laptop does not have an integrated network connector.

Setting Up a Wired Connection

- If you are using a dial-up connection, connect the telephone line to the optional external USB modem and to the telephone wall connector before you set up your Internet connection.
- If you are using a DSL or cable/satellite modem connection, contact your ISP or cellular telephone service for setup instructions.

To complete setting up your wired Internet connection, follow the instructions in “Setting Up Your Internet Connection” on page 18.

Setting Up a Wireless Connection

NOTE: To set up your wireless router, see the documentation that shipped with your router.

Before you can use your wireless Internet connection, you need to connect to your wireless router.

To set up your connection to a wireless router:

1. Ensure that wireless is enabled on your computer (see “Enable or Disable Wireless” on page 14).
2. Save and close any open files, and exit any open programs.
3. Click **Start** → **Control Panel**.
4. In the search box, type *network*, and then click **Network and Sharing Center** → **Connect to a network**.
5. Follow the instructions on the screen to complete the setup.

Setting Up Your Internet Connection

ISPs and ISP offerings vary by country. Contact your ISP for offerings available in your country.

If you cannot connect to the Internet but have successfully connected in the past, the ISP might have a service outage. Contact your ISP to check the service status, or try connecting again later.

Have your ISP information ready. If you do not have an ISP, the **Connect to the Internet** wizard can help you get one.

To set up your Internet connection:

1. Save and close any open files, and exit any open programs.
2. Click **Start**  → **Control Panel**.
3. In the search box, type `network`, and then click **Network and Sharing Center** → **Set up a new connection or network** → **Connect to the Internet**.

The **Connect to the Internet** window appears.

 **NOTE:** If you do not know which type of connection to select, click **Help me choose** or contact your ISP.

4. Follow the instructions on the screen and use the setup information provided by your ISP to complete the setup.

User Interface Modes

Your Inspiron laptop can be used in three different modes. Each mode has a different user interface that changes automatically.

Standard Mode — This is the default mode. In this mode, the laptop displays the Microsoft Windows desktop.

Tablet Mode — In this mode, the Dell Stage user interface launches (see “Dell Stage” on page 36). For more information on Tablet Mode, Dell Stage, and how to access the Windows desktop in Tablet Mode, see the *Inspiron Mini Duo Tablet Mode Quick Reference Guide* at support.dell.com/manuals. To set up your laptop in Tablet Mode, see “Set Up the Tablet Mode” on page 20.

Docked Mode — In this mode the docked tablet launches the Dell Stage user interface. For more information, see the *Inspiron Mini Duo Sound Station User's Guide* at support.dell.com/manuals. To set up your laptop in Docked Mode, first set the laptop to Tablet Mode and then dock the tablet on the Inspiron Mini Duo Sound Station.

Set Up the Tablet Mode

Your Inspiron laptop can also be set to work in Tablet Mode.

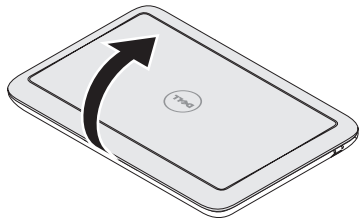

1. Open the display.

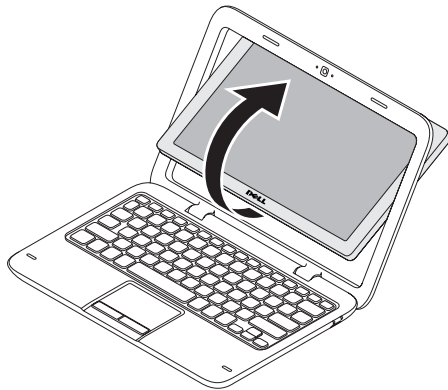

2. Push the display panel from the top and rotate it clockwise 180 degrees.

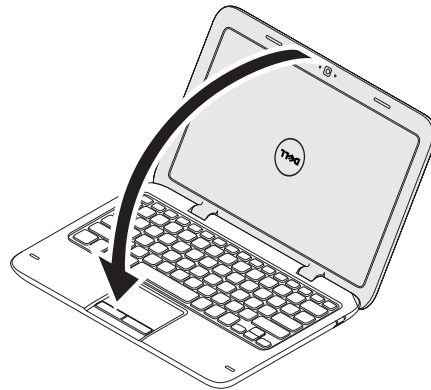

3. Close the display.

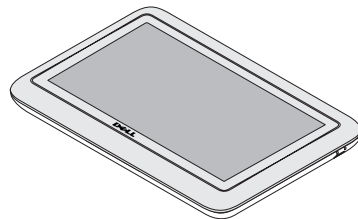



The Dell Stage user interface will be activated automatically in Tablet Mode. For more information on Tablet Mode, see the *Inspiron Mini Duo Tablet Mode Quick Reference Guide* at support.dell.com/manuals.

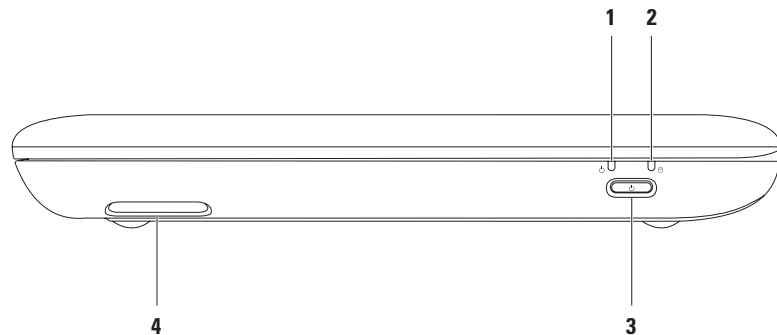

Using Your Inspiron Laptop

This section provides information about the features available on your Inspiron laptop.

Right View Features





- 1  **Power/battery status light** — Indicates the power and the battery charge status. For more information on the power/battery status light, see “Status Lights and Indicators” on page 26.
- 2  **Hard drive activity light** — Turns on when the computer reads or writes data. A solid white light indicates hard drive activity.

 **CAUTION: To avoid loss of data, never turn off the computer when the hard drive activity light is on.**
- 3  **Power button** — Turns the computer on or off when pressed.
- 4 **Right Speaker** — Provides stereo quality sound.

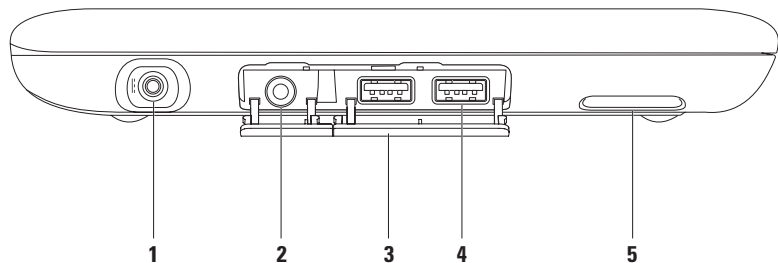
Left View Features



-  **AC adapter connector** — Connects to the AC adapter to power the computer and charge the battery.
-  **Audio-out/Headphone connector** — Connects to a pair of headphones or to a powered speaker or sound system.
- Connector covers (2)** — Covers the USB connectors and the audio-out/headphone connector.
-  **USB 2.0 connectors (2)** — Connect to USB devices, such as a mouse, keyboard, printer, external drive, or MP3 player.
- Left speaker** — Provides stereo quality sound.

Status Lights and Indicators

Power/Battery Status Light

	Indicator light status	Computer state(s)	Battery charge level
AC adapter	solid white	on standby/off/hibernate	0-100% <= 98%
	breathing white	standby	> 98%
	off	off/hibernate	> 98%
Battery	solid white	on	>= 10%
	solid amber	on/standby	< 10%
	breathing white	standby	>= 10%
	off	off/hibernate	0-100%

 **NOTE:** The battery is charging when the computer is powered using the AC adapter.

 **NOTE:** For information on power problems, see “Power Problems” on page 44.

Disabling Battery Charging





You may be required to disable the battery charging feature while on an airplane flight. To quickly disable the battery charging feature:

1. Ensure that your computer is turned on.
2. Press the battery health meter key  on the function key row on the keyboard.
3. In the **Battery Life** tab, select the **Disable battery charging** check box.

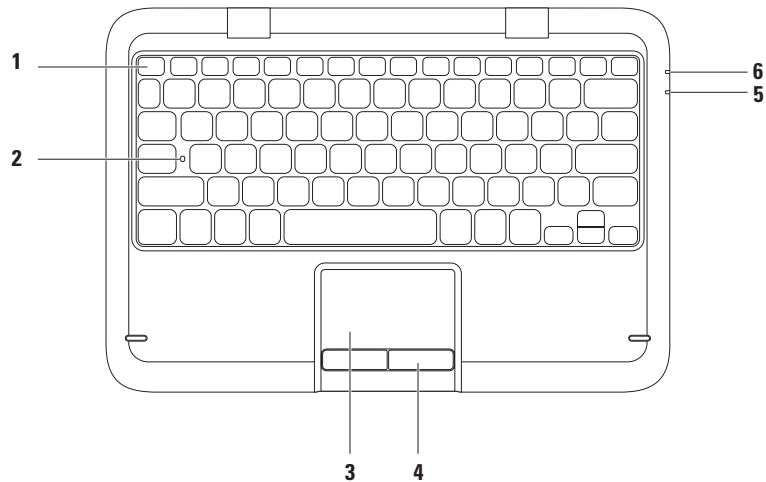
 **NOTE:** Battery charging can also be disabled in the System Setup (BIOS) utility.

Computer Base and Keyboard Features



1 Function key row — The wireless enable or disable key , brightness increase  and decrease  keys, multimedia keys, and the touch pad enable or disable key , are located in this row.

For more information on the multimedia keys, see “Multimedia Control Keys” on page 32.

2 Caps Lock status light — Turns on when Caps Lock is enabled. A solid white light indicates that Caps Lock is enabled.

3 Touch pad — Provides the functionality of a mouse to move the cursor, drag or move selected items, and left-click by tapping the surface.

The touch pad supports the **Scroll**, **Flick**, **Zoom**, and **Rotate** features. To change the touch pad settings, double-click the **Dell Touch pad** icon in the notification area of your desktop. For more information, see “Touch Pad Gestures” on page 30.

NOTE: To enable or disable the touch pad, press the  key on the function key row on the keyboard.

4 Touch pad buttons — Provide left-click and right-click functions like those on a mouse.

5 Power/Battery status light — Indicates the power and the battery charge status. For more information on the power/battery status light, see “Status Lights and Indicators” on page 26.

6 Hard drive activity light — Turns on when the computer reads or writes data. A solid white light indicates hard drive activity.

 **CAUTION:** To avoid loss of data, never turn off the computer when the hard drive activity light is on.

Touch Pad Gestures

Scroll

Allows you to scroll through content. The scroll feature includes:

Auto Scroll Vertical — Allows you to scroll up or down on the active window.

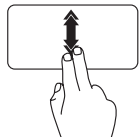

Move two fingers up or down at a fast pace to activate vertical auto scrolling.

Tap on the touch pad to stop auto scrolling.

Auto Scroll Horizontal — Allows you to scroll left or right on the active window.

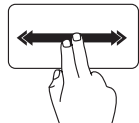

Move two fingers to your left or right at a fast pace to activate horizontal auto scrolling.

Tap on the touch pad to stop auto scrolling.

Flick

Allows you to flip content forward or backward based on the direction of the flick.

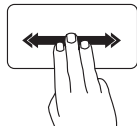

Move three fingers quickly in the desired direction to flip content in the active window.

Zoom

Allows you to increase or decrease the magnification of the screen content. The zoom feature includes:

Pinch — Allows you to zoom in or zoom out by moving two fingers apart or bringing them closer together on the touch pad.

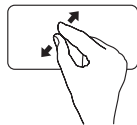

To zoom in:
Move two fingers apart to enlarge the view of the active window.

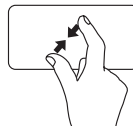

To zoom out:
Move two fingers close together to reduce the view of the active window.

Rotate

Allows you to rotate the active content on the screen. The rotate feature includes:

Twist — Allows you to rotate the active content using two fingers where one finger is anchored and the other rotates.

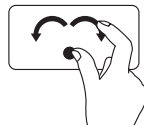

Keeping the thumb in place, move the index finger in an arced direction right or left to rotate the selected item clockwise or counterclockwise.

Multimedia Control Keys

The multimedia control keys are located on the function key row on the keyboard. To use the multimedia controls, press the required key. You can configure the multimedia control keys on the keyboard using the **System Setup** (BIOS) utility or the **Windows Mobility Center**.

System Setup

1. Press <F2> during POST (Power On Self Test) to enter the System Setup (BIOS) utility.
2. In the **Function Key Behavior**, select **Multimedia Key First** or **Function Key First**.

Multimedia Key First — This is the default option. Press any multimedia key to perform the associated multimedia action. For function, press <Fn> + the required function key.

Function Key First — Press any function key to perform the associated function. For multimedia action, press <Fn> + the required multimedia key.

 **NOTE:** The **Multimedia Key First** option is active only in the operating system.

Windows Mobility Center

1. Press the <Windows><X> keys to launch the Windows Mobility Center.
2. In the **Function Key Row**, select **Function Key** or **Multimedia Key**.

Multimedia Control Keys



 Mute the sound

 Decrease the volume level

 Increase the volume level

 Play the previous track or chapter

 Play or pause

 Play the next track or chapter

Display Features

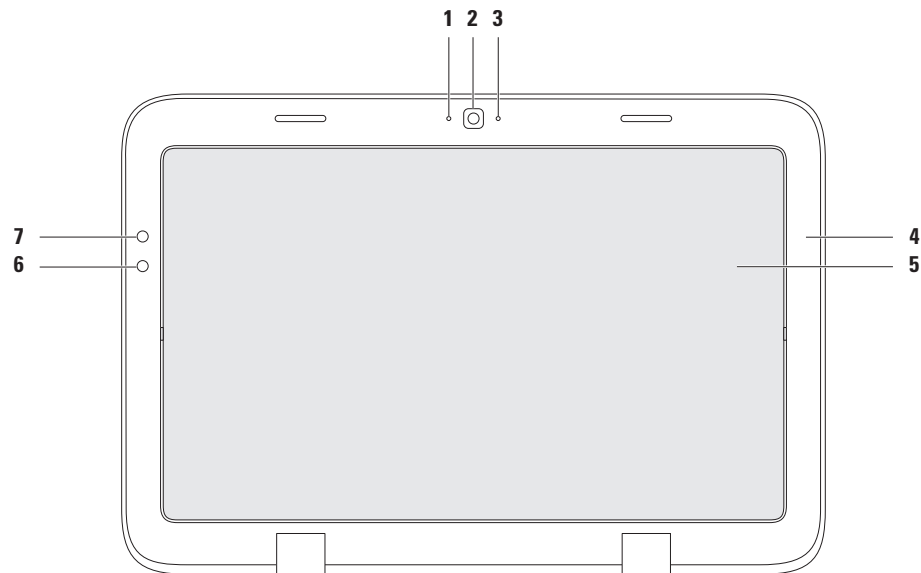

-
- 1 Microphone** — Provides quality sound for video chatting and voice recording.

 - 2 Camera** — Built-in camera for video capture, conferencing, and chat.

 - 3 Camera indicator light** — Indicates if the camera is on or off.

 - 4 Display bezel** — Outer frame which holds the display panel.

 - 5 Display panel** — Rotate the display panel to set your laptop to the tablet mode. For more information, see “Set Up the Tablet Mode” on page 20.

 - 6 Infrared sensor** — Turns on when the proximity sensor is enabled.

 - 7 Ambient light/Proximity sensor** — Ambient light sensor detects the available environment light and adjusts the brightness of the display backlighting. Proximity sensor detects the presence of a user in front of the computer and turns the display on or off. The display turns off if you are away from your computer for specified period of time and turns on when you are about 0.75 meters or closer to your laptop. Press F6 to turn on/off the proximity sensor.

Using the Touch Screen

The touch screen feature on your laptop converts your computer into an interactive display.

Dell Stage

The Dell Stage software installed on your computer provides access to your favorite media and multi-touch applications.

To launch Dell Stage, click **Start**  → **All Programs** → **Dell Stage** → **Dell Stage**.

 **NOTE:** Some of the applications on Dell Stage can also be launched from the **All Programs** menu.

You can customize Dell Stage as follows:

- Rearrange an application shortcut — Select and hold the application shortcut until it blinks and then drag the application shortcut to a desired location on Dell Stage.
- Minimize — Drag the Dell Stage window to the bottom of the screen.

- Personalize — Select the settings icon and then choose the desired option.

The following are the applications available on Dell Stage:

-  **NOTE:** Some of the applications may not be available based on the selections you made while purchasing your computer.
- MUSIC — Play music or browse through your music files by album, artist, or song title. You can also listen to radio stations from across the globe. The optional Napster application allows you to download songs when connected to the Internet.
- YOUPAINT — Draw and edit pictures.
- GAMES — Play touch-enabled games.
- DOCUMENTS — Provides quick access to the Documents folder on your computer.

- PHOTO — View, organize, or edit your pictures. You can create slideshows and collections of your pictures and upload them to **Facebook** or **Flickr** when connected to the Internet.
- DELL WEB — Provides a preview of up to four of your favorite web pages. Click or tap the web page preview to open it in the web browser.
- VIDEO — View videos. The optional CinemaNow application allows you to purchase or rent movies and TV shows when connected to the Internet.
- SHORTCUTS — Provides quick access to your frequently-used programs.
- BOOKS — Launches E Reader which allows you to download and read e-books in PDF and EPUB formats.
- Web Tile — Provides a preview of up to four of your favorite web pages. The tile allows you to add, edit, or delete a web page preview.

Click or tap the web page preview to open it in the web browser. You can also create multiple Web Tiles through the Apps Gallery.

Touch Screen Gestures

 **NOTE:** Some of these gestures may not work outside the Dell Touch Zone software.

Zoom

Allows you to increase or decrease the magnification of the screen content.

Pinch — Allows you to zoom in or zoom out by moving two fingers apart or bringing them closer together on the screen.



To zoom in:

Move two fingers apart to enlarge the view of the active window.

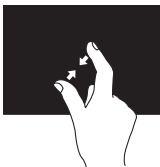

To zoom out:

Move two fingers close together to reduce the view of the active window.

Dwell

Allows you to access additional information by simulating a right-click.

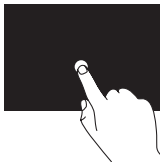

Press and hold a finger on the touch screen, to open context-sensitive menus.

Flick

Allows you to flip content forward or backward based on the direction of the flick.

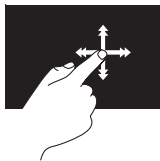

Move a finger quickly in the desired direction to flip through content in the active window like pages in a book. Flick also works vertically when navigating content such as images or songs in a playlist.

Scroll

Allows you to scroll through content. The scroll features include:

Pan — Allows you to move the focus on the selected object when the entire object is not visible.

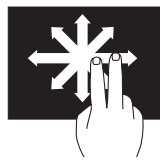

Move two fingers in the desired direction to pan scroll the selected object.

Scroll Vertical — Allows you to scroll up or scroll down on the active window.

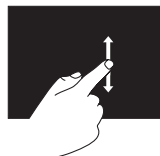

Move a finger up or down to activate vertical scrolling.

Scroll Horizontal — Allows you to scroll left or right on the active window.

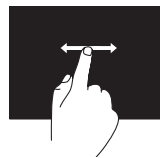

Move a finger to the left or right to activate horizontal scrolling.

Rotate

Allows you to rotate the active content on the screen.

Twist — Allows you to rotate the active content using two fingers.



Keeping a finger or thumb in place, move the other finger in an arced direction right or left. You can also rotate the active content by moving both the fingers in a circular motion.

Software Features

Productivity and Communication

You can use your computer to create presentations, brochures, greeting cards, fliers, and spreadsheets. You can also edit and view digital photographs and images. Check your purchase order for software installed on your computer.

After connecting to the Internet, you can access websites, setup an e-mail account, and upload or download files.

Entertainment and Multimedia

 **NOTE:** Your computer does not have an internal optical drive. Use an external optical drive or any external storage device for procedures that involve discs.

You can use your computer to watch videos, play games, create your own CDs/DVDs, listen to music and Internet radio stations.

You can download or copy pictures and video files from portable devices, such as digital cameras and cell phones. Optional software applications enable you to organize and create music and video files that can be recorded to disc, saved on portable products such as MP3 players and handheld entertainment devices, or played and viewed directly on connected TVs, projectors, and home theater equipment.

Dell DataSafe Online Backup

 **NOTE:** Dell DataSafe Online is supported only on Windows operating systems.

 **NOTE:** A broadband connection is recommended for fast upload/download speeds.

Dell DataSafe Online is an automated backup and recovery service that helps protect your data and other important files from catastrophic incidents like theft, fire, or natural disasters. You can access the service on your computer using a password-protected account.

For more information, go to DellDataSafe.com.

To schedule backups:

1. Double-click the Dell DataSafe Online icon  in the notification area of your desktop.
2. Follow the instructions on the screen.

Free Fall Sensor

Free fall sensor protects your computer hard drive from possible damage, by detecting a free fall state caused by accidentally dropping the computer. When a free fall state is detected, the hard drive is placed in a *safe state* to protect against damage to the read/write head and possible data loss. Your hard drive returns to normal operation, when the free fall state is no longer detected.

 **NOTE:** This feature detects free fall events from 4 inches or higher and places the hard drive in a *safe state* within 145 ms. The hard disk is still limited by its own reliability specification. It can sustain operating shock of 225 G and non-operating shock of 800 G.

Solving Problems

This section provides troubleshooting information for your computer. If you cannot solve your problem using the following guidelines, see “Using Support Tools” on page 49 or “Contacting Dell” on page 74.

 **WARNING:** Only trained service personnel should remove the computer cover. See the *Service Manual* at support.dell.com/manuals for advanced service instructions.

Beep Codes

Your computer might emit a series of beeps during start-up if there are errors or problems. This series of beeps, called a beep code, identifies a problem. If this occurs, note down the beep code and contact Dell (see “Contacting Dell” on page 74) for assistance.

 **NOTE:** To replace parts, see the *Service Manual* at support.dell.com.

Beep Code	Possible Problem
One	Possible system board failure — BIOS ROM checksum failure
Two	No RAM detected NOTE: If you installed or replaced the memory module, ensure that the memory module is seated properly.
Three	Possible system board failure — Chipset error
Four	RAM read/write failure
Five	Real Time Clock failure
Six	Video card or chip failure
Seven	Processor failure
Eight	Display failure

Touch Screen Problems

Some or all multi-touch features are not working —

- Certain touch and multi-touch features may be disabled. To enable them, double-click the **Flicks**  icon in the notification area of your desktop. In the **Pen and Touch** window, select the **Touch** tab and ensure that **Use your finger as an input device** and **Enable multi-touch gestures and inking** options are selected.
- The multi-touch feature may not be supported by the application.
- The touch screen is calibrated at the factory, and does not require re-calibration.

If the touch screen starts losing its sensitivity —

- The touch screen may have foreign particles (such as sticky notes) that are blocking the touch sensors. To remove these particles:
 - a. Turn off the computer.
 - b. Disconnect the AC adapter cable from the wall outlet.
-  **CAUTION:** Do not use water or a cleaning liquid to wipe the touch screen.
- c. Use a clean, lint-free cloth (you may spray mild, non-abrasive cleaner or water on the cloth if needed, but not on the screen) and wipe the surface and sides of the touch screen to remove any dirt or fingerprints.

Network Problems

If the wireless network connection is lost — The wireless router is offline or wireless has been disabled on the computer.

- Check your wireless router to ensure it is powered on and connected to your data source (cable modem or network hub).
- Check if wireless is enabled on the computer (see “Enable or Disable Wireless” on page 14).
- Re-establish your connection to the wireless router (see “Setting Up a Wireless Connection” on page 17).
- Interference may be blocking or interrupting your wireless connection. Try moving the computer closer to your wireless router.
- Ensure that the wireless antennas are not blocked. For location of wireless antennas, see page 16.

Power Problems

If the power light is off — The computer is either turned off, in hibernate mode, or is not receiving power.

- Press the power button. The computer resumes normal operation if it is off or in hibernate mode.
- Reseat the AC adapter cable into the power connector on the computer, into the AC adapter, and to the electrical outlet.
- If the AC adapter cable is plugged into a power strip, ensure that the power strip is plugged into an electrical outlet and that the power strip is turned on. Also bypass power protection devices, power strips, and power extension cables to verify that the computer turns on properly.
- Ensure that the electrical outlet is working by testing it with another device, such as a lamp.

- Check the AC adapter cable connections. If the AC adapter has a light, ensure that the light on the AC adapter is on.

If the power light is solid white and the computer is not responding — The display may not be responding.

- Press the power button until the computer turns off and then turn it back on.
- If the problem persists, contact Dell (see “Contacting Dell” on page 74).

If the power light is breathing white — The computer is in standby mode or the display may not be responding.

- Press a key on the keyboard, move the connected mouse or a finger on the touch pad, or press the power button to resume normal operation.
- If the display is not responding, press the power button until the computer turns off and then turn it back on.

- If the problem persists, contact Dell (see “Contacting Dell” on page 74).

If you encounter interference that hinders reception on your computer — An unwanted signal is creating interference by interrupting or blocking other signals. Some possible causes of interference are:

- Power, keyboard, and mouse extension cables.
- Too many devices connected to a power strip.
- Multiple power strips connected to the same electrical outlet.

Memory Problems

If you receive an insufficient memory message —

- Save and close any open files and exit any open programs you are not using to see if that resolves the problem.
- See the software documentation for minimum memory requirements.
- If the problem persists, contact Dell (see “Contacting Dell” on page 74).

If you experience other memory problems —

- Run Dell Diagnostics (see “Dell Diagnostics” on page 53).
- If the problem persists, contact Dell (see “Contacting Dell” on page 74).

Lockups and Software Problems



If the computer does not start up — Ensure that the AC adapter cable is firmly connected to the computer and to the electrical outlet.

If a program stops responding —

End the program:

1. Press <Ctrl><Shift><Esc> simultaneously.
2. Click **Applications**.
3. Select the program that is no longer responding
4. Click **End Task**.

If a program crashes repeatedly — Check the software documentation. If necessary, uninstall and then reinstall the program.

-  **NOTE:** Software usually includes installation instructions in its documentation or on the CD.
-  **NOTE:** Your computer does not have an internal optical drive. Use an external optical drive or any external storage device for procedures that involve discs.

If the computer stops responding or a solid blue screen appears —

 **CAUTION:** You might lose data if you are unable to perform an operating system shutdown.

If you are unable to get a response by pressing a key on your keyboard, or by moving the connected mouse or a finger on the touch pad, press the power button for at least 8 to 10 seconds until the computer turns off and then restart your computer.

If a program is designed for an earlier Microsoft® Windows® operating system —

Run the Program Compatibility Wizard. The Program Compatibility Wizard configures a program so that it runs in an environment similar to an earlier version of Microsoft Windows operating system.

Solving Problems

To run the Program Compatibility Wizard:

1. Click **Start**  → **Control Panel** → **Programs** → **Run programs made for previous versions of Windows**.
2. In the welcome screen, click **Next**.
3. Follow the instructions on the screen.

If you have other software problems —

- Back up your files immediately.
- Use a virus-scanning program to check the hard drive or CDs.
- Save and close any open files or programs and shut down your computer through the **Start**  menu.
- Check the software documentation or contact the software manufacturer for troubleshooting information:
 - Ensure that the program is compatible with the operating system installed on your computer.

- Ensure that your computer meets the minimum hardware requirements needed to run the software. See the software documentation for information.
- Ensure that the program is installed and configured properly.
- Verify that the device drivers do not conflict with the program.
- If necessary, uninstall and then reinstall the program.
- Write down any error message that is displayed to help in troubleshooting when contacting Dell.

Using Support Tools

Dell Support Center

The **Dell Support Center** helps you find the service, support, and system-specific information you need.

To launch the application, click the  icon in the notification area of your desktop.

The **Dell Support Center** home page displays your computer's model number, service tag, express service code, and service contact information.

The home page also provides links to access:



Self Help (Troubleshooting, Security, System Performance, Network/Internet, Backup/Recovery, and Windows operating system)



Alerts (technical support alerts relevant to your computer)



Assistance from Dell (Technical Support with DellConnect™, Customer Service, Training and Tutorials, How-To Help with Solution Station™, and Online Scan with PC CheckUp)



About Your System (System Documentation, Warranty Information, System Information, Upgrades & Accessories)

For more information about **Dell Support Center** and available support tools, go to **DellSupportCenter.com**.

My Dell Downloads

 **NOTE:** My Dell Downloads may not be available in all regions.

Some of the software pre-installed on your new Dell computer do not include a backup CD or DVD. This software is available on the My Dell Downloads website. From this website you can download available software for reinstallation or create your own backup media.

To register and use My Dell Downloads:

1. Go to **DownloadStore.dell.com/media**.
2. Follow the instructions on the screen to register and download the software.
3. Reinstall the software or create a backup media for future use.

System Messages

If your computer has an issue or error, it may display a system message that will help you identify the cause and action needed to resolve the issue.

 **NOTE:** If the message that appeared is not listed in the following examples, see the documentation for either the operating system or the program that was running when the message appeared. Alternatively you could contact Dell (see “Contacting Dell” on page 74) for assistance.

Alert! Previous attempts at booting this system have failed at checkpoint [nnnn]. For help in resolving this problem, please note this checkpoint and contact Dell Technical Support — The computer failed to complete the boot routine three consecutive times for the same error. Contact Dell (see “Contacting Dell” on page 74) for assistance.

CMOS checksum error — Possible system board failure or RTC battery low. Replace the battery (see the *Service Manual* at support.dell.com/manuals) or Contact Dell (see “Contacting Dell” on page 74) for assistance.

CMOS checksum error — Possible system board failure or RTC battery low. Replace the battery (see the *Service Manual* at support.dell.com/manuals) or Contact Dell (see “Contacting Dell” on page 74) for assistance.

CPU fan failure — CPU fan has failed. Replace the CPU fan (see the *Service Manual* at support.dell.com/manuals).

Hard-disk drive failure — Possible hard-disk drive failure during POST. Contact Dell (see “Contacting Dell” on page 74) for assistance.

Hard-disk drive read failure — Possible hard-disk drive failure during HDD boot test. Contact Dell (see “Contacting Dell” on page 74) for assistance.

Keyboard failure — Keyboard failure or loose cable.

To replace the keyboard, see the *Service Manual* at support.dell.com/manuals.

No boot device available — No bootable partition on hard drive, the hard drive cable is loose, or no bootable device exists.

- Enter the System Setup (BIOS) utility and ensure that the boot sequence information is correct. To enter the System Setup (BIOS) utility, press <F2> during POST (Power On Self Test).

No timer tick interrupt — A chip on the system board might be malfunctioning or there might be a system board failure. Contact Dell (see “Contacting Dell” on page 74) for assistance.

USB over current error — Disconnect the USB device. Your USB device needs more power for it to function properly. Use an external power source to connect the USB device, or if your device has two USB cables, connect both of them.

CAUTION - Hard Drive SELF MONITORING SYSTEM has reported that a parameter has exceeded its normal operating range. Dell recommends that you back up your data regularly. A parameter out of range may or may not indicate a potential hard drive problem — S.M.A.R.T error, possible hard drive failure. Contact Dell (see “Contacting Dell” on page 74) for assistance.

Hardware Troubleshooter

If a device is either not detected during the operating system setup or is detected but incorrectly configured, you can use the **Hardware Troubleshooter** to resolve the incompatibility.

To start the Hardware Troubleshooter:

1. Click **Start**  → **Help and Support**.
2. Type `hardware troubleshooter` in the search field and press <Enter> to start the search.
3. In the search results, select the option that best describes the problem and follow the remaining troubleshooting steps.

Dell Diagnostics

If you experience a problem with your computer, perform the checks in “Lockups and Software Problems” on page 46 and run Dell Diagnostics before you contact Dell for technical assistance.

 **NOTE:** Dell Diagnostics works only on Dell computers.

 **NOTE:** The *Drivers and Utilities* disc may not ship with your computer.

Ensure that the device that you want to test displays in the system setup program and is active. Press <F2> during POST (Power On Self Test) to enter the System Setup (BIOS) utility.

Start Dell Diagnostics from your hard drive or from the *Drivers and Utilities* disc.

Starting Dell Diagnostics From Your Hard Drive

Dell Diagnostics is located on a hidden diagnostic utility partition on your hard drive.

 **NOTE:** If your computer cannot display a screen image, contact Dell (see “Contacting Dell” on page 74) for assistance.

1. Ensure that the computer is connected to an electrical outlet that is known to be working properly.
2. Turn on (or restart) your computer.
3. When the DELL™ logo appears, press <F12> immediately. Select **Diagnostics** from the boot menu and press <Enter>. This may invoke the Pre-Boot System Assessment (PSA) on your computer.

 **NOTE:** If you wait too long and the operating system logo appears, continue to wait until you see the Microsoft® Windows® desktop; then, shut down your computer and try again.

 **NOTE:** If you see a message stating that no diagnostics utility partition has been found, run Dell Diagnostics from the *Drivers and Utilities* disc.

If PSA is invoked:

- a. The PSA will start running tests.
- b. If the PSA completes successfully, the following message appears: “No problems have been found with this system so far. Do you want to run the remaining memory tests? This will take about 30 minutes or more. Do you want to continue? (Recommended).”

- c. If you are experiencing memory issues, press <y>, otherwise press <n>. The following message appears: “Booting Dell Diagnostic Utility Partition. Press any key to continue.”
- d. Press any key to go to the **Choose An Option** window.

If PSA is not invoked:

Press any key to start Dell Diagnostics from the diagnostic utility partition on your hard drive and to go to the **Choose An Option** window.

4. Select the test you want to run.
5. If a problem is encountered during a test, a message with an error code and a description of the problem appears on your screen. Write down the error code and problem description and contact Dell (see “Contacting Dell” on page 74) for assistance.

 **NOTE:** The Service Tag for your computer is displayed at the top of each test screen. The Service Tag helps you identify your computer when you contact Dell.

6. When the tests complete, close the test screen to return to the **Choose An Option** window.
7. To exit Dell Diagnostics and restart the computer, click **Exit**.

Starting Dell Diagnostics From the Drivers and Utilities Disc

 **NOTE:** The *Drivers and Utilities* disc may not ship with your computer.

 **NOTE:** Your computer does not have an internal optical drive. Use an external optical drive or any external storage device for procedures that involve discs.

1. Insert the *Drivers and Utilities* disc.
2. Shut down and restart the computer. When the DELL™ logo appears, press <F12> immediately.

 **NOTE:** If you wait too long and the operating system logo appears, continue to wait until you see the Microsoft Windows desktop; then, shut down your computer and try again.

 **NOTE:** The next steps change the boot sequence for one time only. On the next start-up, the computer boots according to the devices specified in the system setup program.

3. When the boot device list appears, highlight **CD/DVD/CD-RW** and press <Enter>.
4. Select the **Boot from CD-ROM** option from the menu that appears and press <Enter>.
5. Type 1 to start the CD menu and press <Enter> to proceed.
6. Select **Run the 32 Bit Dell Diagnostics** from the numbered list. If multiple versions are listed, select the version appropriate for your computer.
7. Select the test you want to run.
8. If a problem is encountered during a test, a message with an error code and a description of the problem appears on your screen. Write down the error code and

problem description and contact Dell (see “Contacting Dell” on page 74) for assistance.

 **NOTE:** The Service Tag for your computer is displayed at the top of each test screen. The Service Tag helps you identify your computer when you contact Dell.

9. When the tests complete, close the test screen to return to the **Choose An Option** window.
10. To exit Dell Diagnostics and restart the computer, click **Exit**.
11. Remove the *Drivers and Utilities* disc.

Restoring Your Operating System

You can restore the operating system on your computer using any of the following options:

CAUTION: Using Dell Factory Image Restore or the *Operating System* disc to restore your operating system permanently deletes all data files on your computer. If possible, backup your data files before using these options.

Option	Use
System Restore	as the first solution
Dell DataSafe Local Backup	when System Restore does not resolve your problem
System recovery media	when operating system failure prevents the use of System Restore and Dell DataSafe Local Backup when installing the Dell factory-installed software on a newly installed hard drive
Dell Factory Image Restore	to restore your computer to the operating state it was in when you received your computer
<i>Operating System</i> disc	to reinstall only the operating system on your computer

NOTE: The *Operating System* disc may not ship with your computer.

System Restore

The Microsoft® Windows® operating systems provide a System Restore option which allows you to return your computer to an earlier operating state (without affecting data files) if changes to the hardware, software, or other system settings have left the computer in an undesirable operating state. Any changes that System Restore makes to your computer are completely reversible.

CAUTION: Make regular backups of your data files. System Restore does not monitor your data files or recover them.

Starting System Restore

1. Click **Start** .
2. In the search box, type *System Restore* and press <Enter>.
 - NOTE:** The **User Account Control** window may appear. If you are an administrator on the computer, click **Continue**; otherwise, contact your administrator to continue the desired action.
3. Click **Next** and follow the instructions on the screen.

In the event that System Restore did not resolve the issue, you may undo the last system restore.

Undoing the Last System Restore

 **NOTE:** Before you undo the last system restore, save and close all open files and exit any open programs. Do not alter, open, or delete any files or programs until the system restoration is complete.

1. Click **Start** .
2. In the search box, type `System Restore` and press <Enter>.
3. Click **Undo my last restoration** and click **Next**.

Dell DataSafe Local Backup

 **CAUTION:** Using Dell DataSafe Local Backup to restore your operating system permanently removes any programs or drivers installed after you received your computer. Create backup media of applications you need to install on your computer before using Dell DataSafe Local Backup. Use Dell DataSafe Local Backup only if System Restore did not resolve your operating system problem.

 **CAUTION:** Although Dell DataSafe Local Backup is designed to preserve the data files on your computer, it is recommended that you backup your data files before using Dell DataSafe Local Backup.

 **NOTE:** Dell DataSafe Local Backup may not be available in all regions.

 **NOTE:** If Dell DataSafe Local Backup is not available on your computer, use Dell Factory Image Restore (see “Dell Factory Image Restore” on page 64) to restore your operating system.

You can use Dell DataSafe Local Backup to restore your hard drive to the operating state it was in when you purchased your computer, while preserving the data files.

Dell DataSafe Local Backup allows you to:

- Backup and restore your computer to an earlier operating state
- Create system recovery media

Dell DataSafe Local Backup Basic

To restore the Dell factory-installed software while preserving the data files:

1. Turn off your computer.
2. Disconnect all the devices (USB drive, printer, and so on) connected to the computer and remove any newly added internal hardware.

 **NOTE:** Do not disconnect the AC adapter.

3. Turn on your computer.
4. When the DELL™ logo appears, press <F8> several times to access the **Advanced Boot Options** window.

 **NOTE:** If you wait too long and the operating system logo appears, continue to wait until you see the Microsoft Windows desktop; then, shut down your computer and try again.

5. Select **Repair Your Computer**.

6. Select **Dell DataSafe Restore and Emergency Backup** from the **System Recovery Options** menu and follow the instructions on the screen.

 **NOTE:** The restoration process may take an hour or more depending on the size of the data to be restored.

 **NOTE:** For more information, see knowledge base article 353560 at support.dell.com.

Upgrading to Dell DataSafe Local Backup Professional

 **NOTE:** Dell DataSafe Local Backup Professional may be installed on your computer, if you ordered it at the time of purchase.

Dell DataSafe Local Backup Professional provides additional features that allow you to:

- Backup and restore your computer based on file types
- Backup files to a local storage device
- Schedule automated backups

To upgrade to Dell DataSafe Local Backup Professional:

1. Double-click the Dell DataSafe Local Backup icon  in the notification area of your desktop.
2. Click **UPGRADE NOW!**
3. Follow the instructions on the screen.

System Recovery Media

 **CAUTION:** Although the system recovery media is designed to preserve the data files on your computer, it is recommended that you backup your data files before using the system recovery media.

 **NOTE:** Your computer does not have an internal optical drive. Use an external optical drive or any external storage device for procedures that involve discs.

You can use the system recovery media, created using Dell DataSafe Local Backup, to return your hard drive to the operating state it was in when you purchased the computer while preserving the data files on your computer.

Use the system recovery media in case of:

- Operating system failure that prevents the use of the recovery options installed on your computer.
- Hard drive failure that prevents data from being recovered.

To restore the Dell factory-installed software of your computer using the system recovery media:

1. Insert the system recovery disc or USB key and restart the computer.
2. When the DELL™ logo appears, press <F12> immediately.

 **NOTE:** If you wait too long and the operating system logo appears, continue to wait until you see the Microsoft Windows desktop; then, shut down your computer and try again.

3. Select the appropriate boot device from the list and press <Enter>.
4. Follow the instructions on the screen.

Dell Factory Image Restore

 **CAUTION:** Using Dell Factory Image Restore to restore your operating system permanently deletes all data on the hard drive and removes any programs or drivers installed after you received your computer. If possible, back up the data before using this option. Use Dell Factory Image Restore only if System Restore did not resolve your operating system problem.

 **NOTE:** Dell Factory Image Restore may not be available in certain countries or on certain computers.

 **NOTE:** If Dell Factory Image Restore is not available on your computer, use Dell DataSafe Local Backup (see “Dell DataSafe Local Backup” on page 60) to restore your operating system.

Use Dell Factory Image Restore only as the last method to restore your operating system. This option restores your hard drive to the

operating state it was in when you purchased the computer. Any programs or files added since you received your computer—including data files—are permanently deleted from the hard drive. Data files include documents, spreadsheets, e-mail messages, digital photos, music files, and so on. If possible, back up all data before using Dell Factory Image Restore.

Starting Dell Factory Image Restore

1. Turn on the computer.
2. When the DELL™ logo appears, press <F8> several times to access the **Advanced Boot Options** window.

 **NOTE:** If you wait too long and the operating system logo appears, continue to wait until you see the Microsoft Windows desktop; then, shut down your computer and try again.
3. Select **Repair Your Computer**. The **System Recovery Options** window appears.

4. Select a keyboard layout and click **Next**.
5. To access the recovery options, log on as a local user. To access the command prompt, type `administrator` in the **User name** field, then click **OK**.
6. Click **Dell Factory Image Restore**. The **Dell Factory Image Restore** welcome screen appears.

 **NOTE:** Depending upon your configuration, you may need to select **Dell Factory Tools**, then **Dell Factory Image Restore**.
7. Click **Next**. The **Confirm Data Deletion** screen appears.

 **NOTE:** If you do not want to proceed with the Factory Image Restore, click **Cancel**.

8. Select the check box to confirm that you want to continue to reformat the hard drive and restore the system software to the factory condition, then click **Next**.

The restore process begins and may take five or more minutes to complete. A message appears when the operating system and factory-installed applications have been restored to factory condition.

9. Click **Finish** to restart the computer.

Getting Help

If you experience a problem with your computer, you can complete the following steps to diagnose and troubleshoot the problem:

1. See “Solving Problems” on page 42 for information and procedures that pertain to the problem your computer is experiencing.
2. See “Dell Diagnostics” on page 53 for procedures on how to run Dell Diagnostics.
3. Fill out the “Diagnostic Checklist” on page 73.
4. Use Dell’s extensive suite of online services available at Dell Support (support.dell.com) for help with installation and troubleshooting procedures. See “Online Services” on page 68 for a more extensive list of Dell Support online.
5. If the preceding steps have not resolved the problem, see “Before You Call” on page 72.

 **NOTE:** Call Dell Support from a telephone near or at the computer so that the support staff can assist you with any necessary procedures.

 **NOTE:** Dell’s Express Service Code system may not be available in all countries.

When prompted by Dell’s automated telephone system, enter your Express Service Code to route the call directly to the proper support personnel. If you do not have an Express Service Code, open the **Dell Accessories** folder, double-click the **Express Service Code** icon, and follow the directions.

 **NOTE:** Some of the services are not always available in all locations outside the continental U.S. Call your local Dell representative for information on availability.

Technical Support and Customer Service

Dell’s support service is available to answer your questions about Dell hardware. Our support staff use computer-based diagnostics to provide fast, accurate answers.

To contact Dell’s support service, see “Before You Call” on page 72 and then see the contact information for your region or go to support.dell.com.

DellConnect

DellConnect™ is a simple online access tool that allows a Dell service and support associate to access your computer through a broadband connection, diagnose your problem and repair it all under your supervision. For more information, go to www.dell.com/DellConnect.

Online Services

You can learn about Dell products and services on the following websites:

- www.dell.com
- www.dell.com/ap (Asian/Pacific countries only)
- www.dell.com/jp (Japan only)
- www.euro.dell.com (Europe only)
- www.dell.com/la (Latin American and Caribbean countries)
- www.dell.ca (Canada only)

You can access Dell Support through the following websites and e-mail addresses:

Dell Support Websites

- support.dell.com
- support.jp.dell.com (Japan only)
- support.euro.dell.com (Europe only)
- supportapj.dell.com (Asia Pacific only)

Dell Support E-mail Addresses

- mobile_support@us.dell.com
- support@us.dell.com
- la-techsupport@dell.com (Latin America and Caribbean countries only)
- apsupport@dell.com (Asian/Pacific countries only)

Dell Marketing and Sales E-mail Addresses

- apmarketing@dell.com (Asian/Pacific countries only)
- sales_canada@dell.com (Canada only)

Anonymous File Transfer Protocol (FTP)

- ftp.dell.com
Log in as user: `anonymous`, and use your e-mail address as your password.

Automated Order-Status Service

To check on the status of any Dell products that you have ordered, you can go to support.dell.com, or you can call the automated order-status service. A recording prompts you for the information needed to locate and report on your order.

If you have a problem with your order, such as missing parts, wrong parts, or incorrect billing, contact Dell for customer assistance. Have your invoice or packing slip handy when you call.

For the telephone number to call for your region, see “Contacting Dell” on page 74.

Product Information

If you need information about additional products available from Dell, or if you would like to place an order, go to the Dell website at www.dell.com. For the telephone number to call for your region or to speak to a sales specialist, see “Contacting Dell” on page 74.

Returning Items for Repair Under Warranty or for Credit

Prepare all items being returned, whether for repair or credit, as follows:

 **NOTE:** Before you return the product to Dell, ensure that you back up any data on the hard drive(s) and on any other storage device in the product. Remove any and all confidential, proprietary and personal information, as well as removable media, such as CDs and media cards. Dell is not responsible for any of your confidential, proprietary or personal information; lost or corrupted data; or damaged or lost removable media that may be included with your return.

1. Call Dell to obtain a Return Material Authorization Number, and write it clearly and prominently on the outside of the box. For the telephone number to call for your region, see “Contacting Dell” on page 74.
2. Include a copy of the invoice and a letter describing the reason for the return.
3. Include a copy of the Diagnostics Checklist (see “Diagnostic Checklist” on page 73), indicating the tests that you have run and any error messages reported by Dell Diagnostics (see “Dell Diagnostics” on page 53).
4. Include any accessories that belong with the item(s) being returned (AC adapter cable, software, guides, and so on) if the return is for credit.

5. Pack the equipment to be returned in the original (or equivalent) packing materials.

 **NOTE:** You are responsible for paying shipping expenses. You are also responsible for insuring any product returned, and you assume the risk of loss during shipment to Dell. Collect On Delivery (C.O.D.) packages are not accepted.

 **NOTE:** Returns that are missing any of the preceding requirements will be refused at Dell’s receiving dock and returned to you.

Before You Call

NOTE: Have your Express Service Code ready when you call. The code helps Dell's automated-support telephone system direct your call more efficiently. You may also be asked for your Service Tag.

Locating Your Service Tag and Express Service Code

The Service Tag and Express Service Code for your computer can be found on a label at the bottom of your computer.

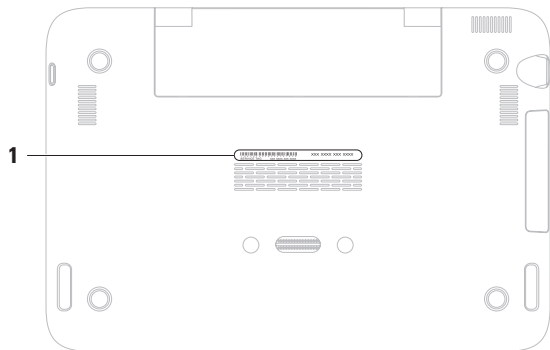

1 Service Tag and Express Service Code

Remember to fill out the following Diagnostic Checklist. If possible, turn on your computer before you call Dell for assistance and call from a telephone at or near the computer. You may be asked to type some commands at the keyboard, relay detailed information during operations, or try other troubleshooting steps possible only at the computer itself. Ensure that the computer documentation is available.

Diagnostic Checklist

- Name:
- Date:
- Address:
- Phone number:
- Service Tag (bar code on the bottom of the computer):
- Express Service Code:
- Return Material Authorization Number (if provided by Dell support technician):
- Operating system and version:
- Devices:
- Expansion cards:
- Are you connected to a network? Yes/No
- Network, version, and network adapter:
- Programs and versions:

See your operating system documentation to determine the contents of the computer's start-up files. If the computer is connected to a printer, print each file. Otherwise, record the contents of each file before calling Dell.

- Error message, beep code, or diagnostic code:
- Description of problem and troubleshooting procedures you performed:

Contacting Dell

For customers in the United States, call 800-WWW-DELL (800-999-3355).

 **NOTE:** If you do not have an active Internet connection, you can find contact information on your purchase invoice, packing slip, bill, or Dell product catalog.

Dell provides several online and telephone-based support and service options. Availability varies by country and product, and some services may not be available in your area.

To contact Dell for sales, technical support, or customer service issues:

1. Go to **www.dell.com/ContactDell**.
2. Select your country or region.
3. Select the appropriate service or support link based on your requirement.
4. Choose the method of contacting Dell that is convenient for you.

Finding More Information and Resources

If you need to:

See:

reinstall your operating system

“System Recovery Media” on page 63

run a diagnostic program for your computer

“Dell Diagnostics” on page 53

reinstall system software

“My Dell Downloads” on page 50

for more information about the Microsoft® Windows® operating system and features

support.dell.com

upgrade your computer with new or additional components like a new hard drive

the *Service Manual* at **support.dell.com/manuals**

reinstall or replace a worn or defective part

 **NOTE:** In some countries, opening and replacing parts of your computer may void your warranty. Check your warranty and return policies before working inside your computer.

If you need to:

See:

find safety best practices information for your computer

the safety and regulatory documents that shipped with your computer and also see the Regulatory Compliance Homepage at **www.dell.com/regulatory_compliance**

review Warranty information, Terms and Conditions (U.S. only), Safety instructions, Regulatory information, Ergonomics information, and End User License Agreement

find your Service Tag/Express Service Code — You must use the service tag to identify your computer on **support.dell.com** or to contact technical support

the bottom of your computer the **Dell Support Center**. To launch the **Dell Support Center**, click the  icon in the notification area of your desktop.



find drivers and downloads; readme files
access technical support and product help
check on your order status for new purchases
find solutions and answers to common questions

support.dell.com

locate information for last-minute updates about technical changes to your computer or advanced technical-reference material for technicians or experienced users

Specifications

This section provides information that you may need when setting up, updating drivers for, and upgrading your computer.

 **NOTE:** Offerings may vary by region. For more information regarding the configuration of your computer, see the **About Your System** section in the **Dell Support Center**. To launch the **Dell Support Center**, click the  icon in the notification area of your desktop.

Computer Model

Dell™ Inspiron 1090

Computer Information

System chipset Intel® NM10 Express

Processor type Intel Atom™ dual core N550

Memory

Memory module connector one internal SODIMM connector

Memory module capacities 2 GB

Minimum memory 2 GB

Maximum memory 2 GB

Memory type 1333 MHz SODIMM DDR3

Memory

 **NOTE:** For instructions on upgrading the memory, see the *Service Manual* at support.dell.com/manuals.

Connectors

Audio one audio-out/headphone connector

Mini-Card one half Mini-Card slot and one full Mini-Card slot

USB two 4-pin USB 2.0-compliant connectors

Communications

Wireless WLAN
Optional: WWAN, WiMax/Wi-Fi abgn/agn, and WPAN with Bluetooth® wireless technology

Video

Video controller Intel NM10

Video memory 8 MB system memory (minimum)
256 MB (maximum)

Audio

Audio controller Conexant Audio CX20671

Speakers 2 x 1.5 Watt (peak) /1 Watt (Average RMS)

Audio

Volume controls	software program menus and media controls
-----------------	---

Camera

Camera resolution	1.3 megapixel
Video resolution	640 x 480 at 30 fps (maximum)

Keyboard

Number of keys	86 (U.S. and Canada); 87 (Europe and Brazil); 90 (Japan)
----------------	--

Display

Type	Multi-touch 10.1 inch High Definition
------	---------------------------------------

Dimensions:

Display

Height	125.22 mm (4.93 inches)
Width	222.73 mm (8.77 inches)
Diagonal	10.06 inches
Maximum resolution	1366 x 768
Refresh rate	60 Hz
Operating angle	0° (closed) to 135°
Horizontal viewing angle	40/40
Vertical viewing angle	15/30 (H/L)
Pixel pitch	0.163 mm x 0.163 mm

Touch Pad

X/Y position resolution (graphics table mode)	240 cpi
Size:	
Width	67.0 mm (2.64 inches) sensor-active area
Height	37.0 mm (1.46 inches) rectangle

Battery

4-cell "smart" lithium ion:	
Height	12.0 mm (0.47 inches)
Width	56.0 mm (2.20 inches)
Length	220.4 mm (8.68 inches)
Weight	0.22 kg (0.48 lb)
Operating time	battery operating time varies depending on operating conditions
Coin-cell battery	CR-2032

Physical

Height	26.2 mm (1.03 inches)
Width	285.0 mm (11.22 inches)
Depth	194.5 mm (7.66 inches)
Weight	configurable to less than 1.54 kg (3.39 lb)

AC Adapter

 **NOTE:** Use only AC adapters specified for use with your computer. See the safety information that shipped with your computer.

Input voltage	100-240 VAC
Input current (maximum)	1.0 A
Input frequency	50-60 Hz
Output power	30 W
Output current:	
30 W	1.58 A (maximum)
Rated output voltage	19.0 VDC
Temperature range:	
Operating	0° to 40°C (32° to 104°F)

AC Adapter

Storage	-40° to 70°C (-40° to 158°F)
---------	---------------------------------

Computer Environment

Temperature range:

Operating	0° to 35°C (32° to 95°F)
Storage	-40° to 65°C (-40° to 149°F)

Relative humidity (maximum):

Operating	10% to 90% (noncondensing)
Storage	5% to 95% (noncondensing)

Maximum vibration (using a random vibration spectrum that simulates user environment):

Operating	0.66 G
-----------	--------

Computer Environment

Non-Operating	1.30 G
---------------	--------

Maximum shock (for operating — measured with Dell Diagnostics running on the hard drive and a 2-ms half-sine pulse; for non-operating — measured with the hard drive in head-parked position and a 2-ms half-sine pulse):

Operating	110 G
Non-Operating	160 G

Altitude (maximum):

Operating	-15.2 to 3048 m (-50 to 10,000 ft)
Storage	-15.2 to 10,668 m (-50 to 35,000 ft)

Airborne contaminant level	G2 or lower as defined by ISA-S71.04-1985
----------------------------	---

Appendix

Macrovision Product Notice

This product incorporates copyright protection technology that is protected by method claims of certain U.S. patents and other intellectual property rights owned by Macrovision Corporation and other rights owners. Use of this copyright protection technology must be authorized by Macrovision Corporation, and is intended for home and other limited viewing uses only unless otherwise authorized by Macrovision Corporation. Reverse engineering or disassembly is prohibited.

Information for NOM, or Official Mexican Standard (Only for Mexico)

The following information is provided in the device(s) described in this document in accordance with the requirements of the Official Mexican Standard (NOM):

Importer:

Dell México S.A. de C.V.

Paseo de la Reforma 2620 – Flat 11°

Col. Lomas Altas

11950 México, D.F.

Regulatory model number	Voltage	Frequency	Electricity consumption	Output voltage	Output intensity
P08T	100-240 VAC	50-60 Hz	1.0 A	19.0 VDC	1.58 A

For details, read the safety information that shipped with your computer.

For additional safety best practices information, see the Regulatory Compliance Homepage at www.dell.com/regulatory_compliance.

Index

A

airflow, allowing **5**

B

backup and recovery **41**

C

calling Dell **72**

CDs, playing and creating **40**

computer capabilities **40**

computer, setting up **5**

Contacting Dell online **74**

customer service **67**

D

DataSafe Local Backup

Basic **61**

Professional **62**

DellConnect **67**

Dell Diagnostics **53**

Dell Factory Image Restore **64**

Dell Support Center **49**

Diagnostic Checklist **73**

drivers and downloads **77**

DVDs, playing and creating **40**

E

E-mail addresses

for technical support **68**

F

finding more information **76**

flick **38**

Free Fall sensor **41**

FTP login, anonymous **68**

G

gestures

Touch Pad **30**

touch screen **38**

H

hard drive activity light **23, 29**

hardware problems

diagnosing **53**

Hardware Troubleshooter **53**

help

getting assistance and support **66**

I

Internet connection **17**

M

memory problems

solving **46**

P

power problems, solving **44**

power strips, using **6**

problems, solving **42**

products

information and purchasing **69**

R

resources, finding more **76**

restoring factory image **64**

S

Service Tag

locating **72**

setup, before you begin **5**

Index

shipping products

for return or repair **70**

SIM card **10**

software features **40**

software problems **46**

solving problems **42**

specifications **78**

support e-mail addresses **68**

support sites

worldwide **67**

System Messages **50**

System Recovery Media **63**

system reinstall options **58**

System Restore **59**

T

Tablet Mode **20**

touch screen **36**

U

User Interface Modes **19**

V

ventilation, ensuring **5**

W

warranty returns **70**

Windows

Program Compatibility Wizard **47**

wireless network

connecting **14**

problems **44**



Printed in the U.S.A.

www.dell.com | support.dell.com



OKFPFDA00