



FCC TEST REPORT

REPORT NO.: RF140922C25

MODEL NO.: TR 195 (Refer to item 3.1 for more details)

FCC ID: DMOTR195

RECEIVED: Sep. 22, 2014

TESTED: Sep. 25 ~ Sep. 30, 2014

ISSUED: Oct. 06, 2014

APPLICANT: Sennheiser electronic GmbH & Co.KG.

ADDRESS: Am Labor 1 D-30900 Wedemark, Germany

ISSUED BY: Bureau Veritas Consumer Products Services
(H.K.) Ltd., Taoyuan Branch

LAB ADDRESS: No. 47-2, 14th Ling, Chia Pau Vil., Lin Kou Dist.,
New Taipei City, Taiwan, R.O.C.

TEST LOCATION: No. 19, Hwa Ya 2nd Rd, Wen Hwa Tsuen, Kwei
Shan Hsiang, Taoyuan Hsien 333, Taiwan, R.O.C.

This report should not be used by the client to claim product certification, approval, or endorsement by TAF or any government agencies.



This report is for your exclusive use. Any copying or replication of this report to or for any other person or entity, or use of our name or trademark, is permitted only with our prior written permission. This report sets forth our findings solely with respect to the test samples identified herein. The results set forth in this report are not indicative or representative of the quality or characteristics of the lot from which a test sample was taken or any similar or identical product unless specifically and expressly noted. Our report includes all of the tests requested by you and the results thereof based upon the information that you provided to us. You have 60 days from date of issuance of this report to notify us of any material error or omission caused by our negligence, provided, however, that such notice shall be in writing and shall specifically address the issue you wish to raise. A failure to raise such issue within the prescribed time shall constitute your unqualified acceptance of the completeness of this report, the tests conducted and the correctness of the report contents. Unless specific mention, the uncertainty of measurement has been explicitly taken into account to declare the compliance or non-compliance to the specification

Table of Contents

RELEASE CONTROL RECORD.....	4
1. CERTIFICATION.....	5
2. SUMMARY OF TEST RESULTS	6
2.1 MEASUREMENT UNCERTAINTY.....	6
3. GENERAL INFORMATION.....	7
3.1 GENERAL DESCRIPTION OF EUT	7
3.2 DESCRIPTION OF TEST MODES	9
3.2.1 TEST MODE APPLICABILITY AND TESTED CHANNEL DETAIL	10
3.3 DESCRIPTION OF SUPPORT UNITS	12
3.3.1 CONFIGURATION OF SYSTEM UNDER TEST	12
3.4 GENERAL DESCRIPTION OF APPLIED STANDARDS	13
4. TEST TYPES AND RESULTS	14
4.1 RADIATED EMISSION AND BANDEDGE MEASUREMENT	14
4.1.1 LIMITS OF RADIATED EMISSION AND BANDEDGE MEASUREMENT	14
4.1.2 TEST INSTRUMENTS.....	15
4.1.3 TEST PROCEDURES	16
4.1.4 DEVIATION FROM TEST STANDARD.....	16
4.1.5 TEST SETUP.....	17
4.1.6 EUT OPERATING CONDITIONS	17
4.1.7 TEST RESULTS	18
4.2 6dB BANDWIDTH MEASUREMENT.....	26
4.2.1 LIMITS OF 6dB BANDWIDTH MEASUREMENT	26
4.2.2 TEST SETUP.....	26
4.2.3 TEST INSTRUMENTS.....	26
4.2.4 TEST PROCEDURE.....	26
4.2.5 DEVIATION FROM TEST STANDARD.....	26
4.2.6 EUT OPERATING CONDITIONS	26
4.2.7 TEST RESULTS	27
4.3 CONDUCTED OUTPUT POWER.....	28
4.3.1 LIMITS OF CONDUCTED OUTPUT POWER MEASUREMENT	28
4.3.2 TEST SETUP.....	28
4.3.3 TEST INSTRUMENTS.....	28
4.3.4 TEST PROCEDURES	28
4.3.5 DEVIATION FROM TEST STANDARD.....	28
4.3.6 EUT OPERATING CONDITIONS	28
4.3.7 TEST RESULTS	28



4.4	POWER SPECTRAL DENSITY MEASUREMENT	29
4.4.1	LIMITS OF POWER SPECTRAL DENSITY MEASUREMENT	29
4.4.2	TEST SETUP	29
4.4.3	TEST INSTRUMENTS.....	29
4.4.4	TEST PROCEDURE.....	29
4.4.5	DEVIATION FROM TEST STANDARD.....	29
4.4.6	EUT OPERATING CONDITION.....	29
4.4.7	TEST RESULTS	30
4.5	CONDUCTED OUT OF BAND EMISSION MEASUREMENT	31
4.5.1	LIMITS OF OUT OF BAND EMISSION MEASUREMENT	31
4.5.2	TEST SETUP	31
4.5.3	TEST INSTRUMENTS.....	31
4.5.4	TEST PROCEDURE.....	32
4.5.5	DEVIATION FROM TEST STANDARD.....	32
4.5.6	EUT OPERATING CONDITION.....	32
4.5.7	TEST RESULTS	32
4.5.8	TEST RESULTS	33
5.	PHOTOGRAPHS OF THE TEST CONFIGURATION.....	34
6.	INFORMATION ON THE TESTING LABORATORIES	35
7.	APPENDIX A - MODIFICATIONS RECORDERS FOR ENGINEERING CHANGES TO THE EUT BY THE LAB	36



A D T

RELEASE CONTROL RECORD

ISSUE NO.	REASON FOR CHANGE	DATE ISSUED
RF140922C25	Original release	Oct. 06, 2014

1. CERTIFICATION

PRODUCT: Digital Wireless Headphone System (RS 175/185/195)
MODEL NO.: TR 195 (Refer to item 3.1 for more details)
BRAND: SENNHEISER
APPLICANT: Sennheiser electronic GmbH & Co.KG.
TESTED: Sep. 25 ~ Sep. 30, 2014
TEST SAMPLE: ENGINEERING SAMPLE
STANDARDS: FCC Part 15, Subpart C (Section 15.247)

The above equipment (model: TR 195) has been tested by **Bureau Veritas Consumer Products Services (H.K.) Ltd., Taoyuan Branch**, and found compliance with the requirement of the above standards. The test record, data evaluation & Equipment Under Test (EUT) configurations represented herein are true and accurate accounts of the measurements of the sample's EMC characteristics under the conditions specified in this report.

PREPARED BY :  , **DATE** : Oct. 06, 2014
Ivy Lin / Specialist

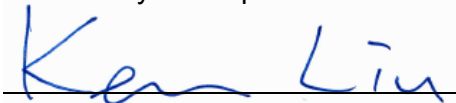
APPROVED BY :  , **DATE** : Oct. 06, 2014
Ken Liu / Senior Manager

2. SUMMARY OF TEST RESULTS

The EUT has been tested according to the following specifications:

APPLIED STANDARD: FCC PART 15, SUBPART C (SECTION 15.247)			
STANDARD SECTION	TEST TYPE AND LIMIT	RESULT	REMARK
15.207	AC Power Conducted Emission	PASS	Meet the requirement of limit. Minimum passing margin is -22.08dB at 0.48594MHz.
15.205 & 209	Radiated Emissions	PASS	Meet the requirement of limit. Minimum passing margin is -5.1dB at 2390.00MHz.
15.247(d)	Band Edge Measurement	PASS	Meet the requirement of limit. Minimum passing margin is -5.5dB at 2483.50MHz.
15.247(d)	Antenna Port Emission	PASS	Meet the requirement of limit.
15.247(a)(2)	6dB bandwidth	PASS	Meet the requirement of limit.
15.247(b)	Conducted power	PASS	Meet the requirement of limit.
15.247(e)	Power Spectral Density	PASS	Meet the requirement of limit.
15.203	Antenna Requirement	PASS	No antenna connector is used.

2.1 MEASUREMENT UNCERTAINTY

Where relevant, the following measurement uncertainty levels have been estimated for tests performed on the EUT as specified in CISPR 16-4-2:

MEASUREMENT	FREQUENCY	UNCERTAINTY
Conducted emissions	150kHz~30MHz	2.44dB
Radiated emissions	30MHz ~ 200MHz	3.63 dB
	200MHz ~1000MHz	3.64 dB
	1GHz ~ 18GHz	2.29 dB
	18GHz ~ 40GHz	2.29 dB

This uncertainty represents an expanded uncertainty expressed at approximately the 95% confidence level using a coverage factor of k=2.

3. GENERAL INFORMATION

3.1 GENERAL DESCRIPTION OF EUT

EUT	Digital Wireless Headphone System (RS 175/185/195)
MODEL NO.	TR 195 (Refer to Note for more details)
POWER SUPPLY	9Vdc (Adapter)
MODULATION TYPE	8-FSK Digital
TRANSFER RATE	5Mb/s
OPERATING FREQUENCY	2406 ~ 2474MHz
NUMBER OF CHANNEL	18
CHANNEL SPACING	4MHz
OUTPUT POWER	2.673mW
ANTENNA TYPE	Refer to Note 2 as below
ANTENNA CONNECTOR	Refer to Note 2 as below
DATA CABLE	Refer to Note 4 as below
I/O PORTS	Refer to user's manual
ACCESSORY DEVICES	Adapter

NOTE:

1. All models are listed as below. Model: TR 195 is chosen for final test.

BRAND	MODEL	REMARK
SENNHEISER	TR 175	1. Same PCB 2. With an RF Frontend 3. has one analog audio input with automatic level control and one optical digital audio input 4. With Microcontroller
	TR 185	1. Same PCB 2. With an RF Frontend 3. has one analog audio input with selectable automatic or manual level control and one optical digital audio input 4. With Microcontroller
	TR 195	1. Same PCB 2. With an RF Frontend 3. has one analog audio input with automatic level control and one optical digital audio input. 4. has an additional DSP for special audiology sound processing for hearing impaired people 5. With Microcontroller

2. The antenna used in this EUT are listed as below table:

TYPE	CONNECTOR	GAIN (dBi)
Inverted F	NA	4.98

3. The EUT consumes power from the following adapter.

BRAND:	SENNHEISER
MODEL:	NT9-3W (Type: 15.3916)
INPUT:	100-240Vac, 50-60Hz, 80mA
OUTPUT:	9Vdc, 300mA
POWER LINE:	DC 1.8m cable without core

4. The following data cables are provided to the EUT.

MODEL	DATA CABLE
TR 175	2.0m Stereo audio cable with 3.5mm jack plugs without core 1.5m Optical digital cable without core
TR 185	1.5m Optical digital cable without core 1.2m Stero RCA cable without core
TR 195	2.0m Stereo audio cable with 3.5mm jack plugs without core 1.5m Optical digital cable without core

5. The above EUT information is declared by the manufacturer and for more detailed features description, please refer to the manufacturer's specifications or User's Manual.

3.2 DESCRIPTION OF TEST MODES

18 channels are provided to this EUT:

CHANNEL	FREQ. (MHz)	CHANNEL	FREQ. (MHz)
1	2406	10	2442
2	2410	11	2446
3	2414	12	2450
4	2418	13	2454
5	2422	14	2458
6	2426	15	2462
7	2430	16	2466
8	2434	17	2470
9	2438	18	2474

3.2.1 TEST MODE APPLICABILITY AND TESTED CHANNEL DETAIL

EUT CONFIGURE MODE	APPLICABLE TO				DESCRIPTION
	RE≥1G	RE<1G	PLC	APCM	
-	√	√	√	√	-

Where **RE≥1G**: Radiated Emission above 1GHz **RE<1G**: Radiated Emission below 1GHz
PLC: Power Line Conducted Emission **APCM**: Antenna Port Conducted Measurement

RADIATED EMISSION TEST (ABOVE 1GHz):

- Pre-Scan has been conducted to determine the worst-case mode from all possible combinations between available modulations and antenna ports (if EUT with antenna diversity architecture).
- Following channel(s) was (were) selected for the final test as listed below.

EUT CONFIGURE MODE	AVAILABLE CHANNEL	TESTED CHANNEL	MODULATION TYPE
-	1 to 18	1, 9, 18	8-FSK Digital

RADIATED EMISSION TEST (BELOW 1GHz):

- Pre-Scan has been conducted to determine the worst-case mode from all possible combinations between available modulations and antenna ports (if EUT with antenna diversity architecture).
- Following channel(s) was (were) selected for the final test as listed below.

EUT CONFIGURE MODE	AVAILABLE CHANNEL	TESTED CHANNEL	MODULATION TYPE
-	1 to 18	1	8-FSK Digital

POWER LINE CONDUCTED EMISSION TEST:

- Pre-Scan has been conducted to determine the worst-case mode from all possible combinations between available modulations, data rates and antenna ports (if EUT with antenna diversity architecture).
- Following channel(s) was (were) selected for the final test as listed below.

EUT CONFIGURE MODE	AVAILABLE CHANNEL	TESTED CHANNEL	MODULATION TYPE
-	1 to 18	1	8-FSK Digital

ANTENNA PORT CONDUCTED MEASUREMENT:

- Pre-Scan has been conducted to determine the worst-case mode from all possible combinations between available modulations, data rates and antenna ports (if EUT with antenna diversity architecture).
- Following channel(s) was (were) selected for the final test as listed below.

EUT CONFIGURE MODE	AVAILABLE CHANNEL	TESTED CHANNEL	MODULATION TYPE
-	1 to 18	1, 9, 18	8-FSK Digital

TEST CONDITION:

APPLICABLE TO	ENVIRONMENTAL CONDITIONS	INPUT POWER	TESTED BY
RE \geq 1G	25deg. C, 60%RH	120Vac, 60Hz	Tank Wu
RE $<$ 1G	25deg. C, 60%RH	120Vac, 60Hz	Tank Wu
PLC	24deg. C, 64%RH	120Vac, 60Hz	Match Tsui
APCM	24deg. C, 64%RH	120Vac, 60Hz	Match Tsui

3.3 DESCRIPTION OF SUPPORT UNITS

The EUT has been tested as an independent unit.

3.3.1 CONFIGURATION OF SYSTEM UNDER TEST

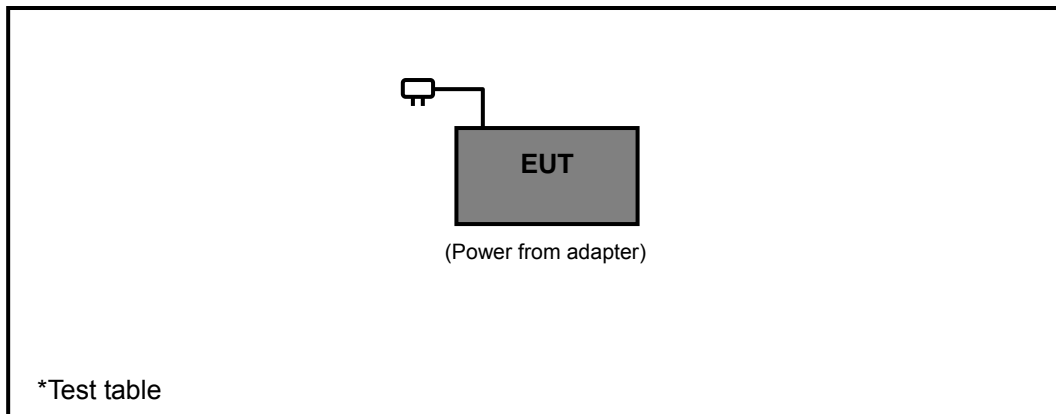

3.4 GENERAL DESCRIPTION OF APPLIED STANDARDS

The EUT is a RF Product. According to the specifications of the manufacturer, it must comply with the requirements of the following standards:

FCC Part 15, Subpart C (15.247)
558074 D01 DTS Meas Guidance v03r02
ANSI C63.10-2009

All test items have been performed and recorded as per the above standards.

NOTE: The EUT is also considered as a kind of computer peripheral, because the connection to computer is necessary for typical use. It has been verified to comply with the requirements of FCC Part 15, Subpart B, Class B (DoC). The test report has been issued separately.

4. TEST TYPES AND RESULTS

4.1 RADIATED EMISSION AND BANDEDGE MEASUREMENT

4.1.1 LIMITS OF RADIATED EMISSION AND BANDEDGE MEASUREMENT

Radiated emissions which fall in the restricted bands must comply with the radiated emission limits specified as below table. Other emissions shall be at least 20dB below the highest level of the desired power:

FREQUENCIES (MHz)	FIELD STRENGTH (microvolts/meter)	MEASUREMENT DISTANCE (meters)
0.009 ~ 0.490	2400/F(kHz)	300
0.490 ~ 1.705	24000/F(kHz)	30
1.705 ~ 30.0	30	30
30 ~ 88	100	3
88 ~ 216	150	3
216 ~ 960	200	3
Above 960	500	3

NOTE:

1. The lower limit shall apply at the transition frequencies.
2. Emission level (dBuV/m) = 20 log Emission level (uV/m).
3. For frequencies above 1000MHz, the field strength limits are based on average detector, however, the peak field strength of any emission shall not exceed the maximum permitted average limits, specified above by more than 20dB under any condition of modulation.

4.1.2 TEST INSTRUMENTS

DESCRIPTION & MANUFACTURER	MODEL NO.	SERIAL NO.	DATE OF CALIBRATION	DUE DATE OF CALIBRATION
Test Receiver ROHDE & SCHWARZ	ESCS30	100289	Nov. 29, 2013	Nov. 28, 2014
Spectrum Analyzer ROHDE & SCHWARZ	FSP40	100269	Feb. 11, 2014	Feb. 10, 2015
BILOG Antenna SCHWARZBECK	VULB9168	9168-156	Feb. 25, 2014	Feb. 24, 2015
HORN Antenna SCHWARZBECK	BBHA 9120 D	9120D-209	Aug. 25, 2014	Aug. 24, 2015
HORN Antenna SCHWARZBECK	BBHA 9170	BBHA9170241	Feb. 17, 2014	Feb. 16, 2015
Preamplifier Agilent	8449B	3008A01911	Aug. 09, 2014	Aug. 08, 2015
Preamplifier Agilent	8447D	2944A10638	Oct. 18, 2013	Oct. 17, 2014
RF signal cable HUBER+SUHNNER	SUCOFLEX 104	248780/4 309222/4 274092/4	Aug. 09, 2014	Aug. 08, 2015
RF signal cable Worken	8D-FB	Cable-CH9-01	Aug. 11, 2014	Aug. 10, 2015
Software BV ADT	ADT_Radiated_ V7.6.15.9.4	NA	NA	NA
Antenna Tower EMCO	2070/2080	512.835.4684	NA	NA
Turn Table EMCO	2087-2.03	NA	NA	NA
Antenna Tower & Turn Table Controller EMCO	2090	NA	NA	NA
High Speed Peak Power Meter	ML2495A	0824011	Jul. 26, 2014	Jul. 25, 2015
Power Sensor	MA2411B	0738171	Jul. 26, 2014	Jul. 25, 2015

- NOTE:**
1. The calibration interval of the above test instruments is 12 months and the calibrations are traceable to NML/ROC and NIST/USA.
 2. The test was performed in HwaYa Chamber 9.
 3. The horn antenna and HP preamplifier (model: 8449B) are used only for the measurement of emission frequency above 1GHz if tested.
 4. The FCC Site Registration No. is 215374.
 5. The IC Site Registration No. is IC 7450F-9.

4.1.3 TEST PROCEDURES

- a. The EUT was placed on the top of a rotating table 0.8 meters above the ground at a 3 meter semi-anechoic chamber. The table was rotated 360 degrees to determine the position of the highest radiation.
- b. The EUT was set 3 meters away from the interference-receiving antenna, which was mounted on the top of a variable-height antenna tower.
- c. The antenna is a broadband antenna, and its height is varied from one meter to four meters above the ground to determine the maximum value of the field strength. Both horizontal and vertical polarizations of the antenna are set to make the measurement.
- d. For each suspected emission, the EUT was arranged to its worst case and then the antenna was tuned to heights from 1 meter to 4 meters and the rotatable table was turned from 0 degrees to 360 degrees to find the maximum reading.
- e. The test-receiver system was set to Peak Detect Function and Specified Bandwidth with Maximum Hold Mode.
- f. If the emission level of the EUT in peak mode was lower than the limit specified, then testing could be stopped and the peak values of the EUT would be reported. Otherwise the emissions would be re-tested one by one using peak, quasi-peak or average method as specified and then reported in a data sheet.

NOTE:

1. The resolution bandwidth and video bandwidth of test receiver/spectrum analyzer is 120kHz for Quasi-peak detection at frequency below 1GHz.
2. The resolution bandwidth of test receiver/spectrum analyzer is 1 MHz and video bandwidth is 3MHz for Peak detection at frequency above 1GHz.
3. The resolution bandwidth of test receiver/spectrum analyzer is 1MHz and the video bandwidth is $\geq 1/T$ (Duty cycle < 98%) or 10Hz (Duty cycle > 98%) for Average detection (AV) at frequency above 1GHz.
4. All modes of operation were investigated and the worst-case emissions are reported.

4.1.4 DEVIATION FROM TEST STANDARD

No deviation.

4.1.5 TEST SETUP

Frequency range 30MHz~1GHz

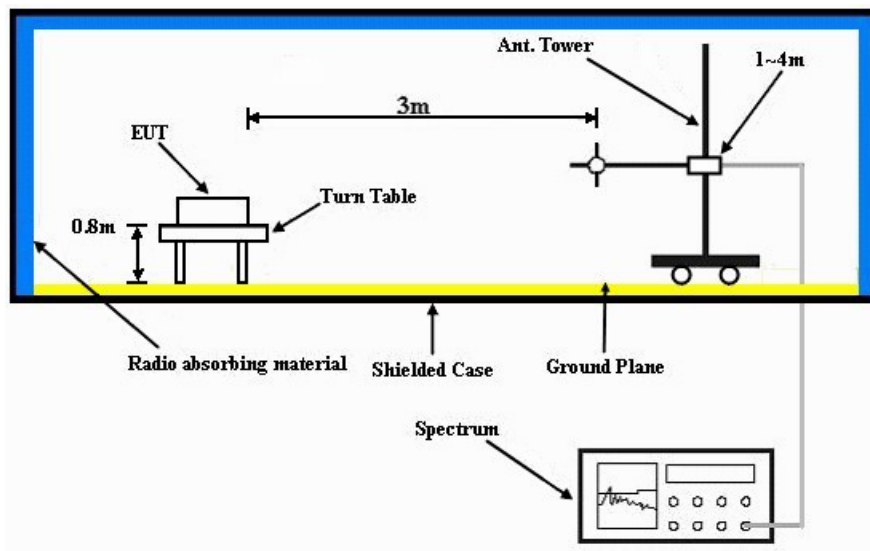

Frequency range above 1GHz

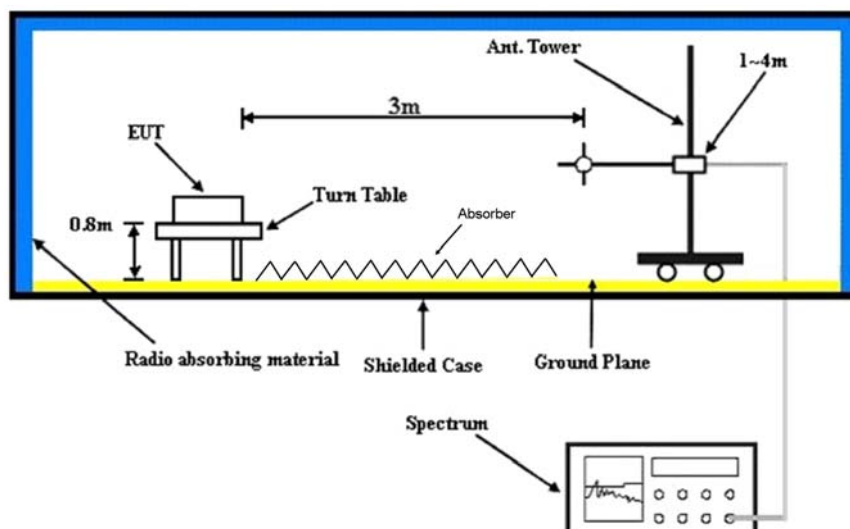

For the actual test configuration, please refer to the attached file (Test Setup Photo).

4.1.6 EUT OPERATING CONDITIONS

Set the EUT under transmission condition continuously at specific channel frequency.

4.1.7 TEST RESULTS

ABOVE 1GHz WORST-CASE DATA :

CHANNEL	TX Channel 1	DETECTOR FUNCTION	Peak (PK)
FREQUENCY RANGE	1GHz ~ 25GHz		Average (AV)

ANTENNA POLARITY & TEST DISTANCE: HORIZONTAL AT 3 M								
NO.	FREQ. (MHz)	EMISSION LEVEL (dBuV/m)	LIMIT (dBuV/m)	MARGIN (dB)	ANTENNA HEIGHT (m)	TABLE ANGLE (Degree)	RAW VALUE (dBuV)	CORRECTION FACTOR (dB/m)
1	2390.00	60.5 PK	74.0	-13.5	1.66 H	250	27.50	33.00
2	2390.00	48.1 AV	54.0	-5.9	1.66 H	250	15.10	33.00
3	*2406.00	102.7 PK			1.66 H	250	69.60	33.10
4	*2406.00	96.4 AV			1.66 H	250	63.30	33.10
5	4812.00	46.6 PK	74.0	-27.4	1.16 H	110	45.10	1.50
6	4812.00	37.7 AV	54.0	-16.3	1.16 H	110	36.20	1.50
ANTENNA POLARITY & TEST DISTANCE: VERTICAL AT 3 M								
NO.	FREQ. (MHz)	EMISSION LEVEL (dBuV/m)	LIMIT (dBuV/m)	MARGIN (dB)	ANTENNA HEIGHT (m)	TABLE ANGLE (Degree)	RAW VALUE (dBuV)	CORRECTION FACTOR (dB/m)
1	2390.00	62.2 PK	74.0	-11.8	1.00 V	256	28.40	33.80
2	2390.00	48.9 AV	54.0	-5.1	1.00 V	256	15.10	33.80
3	*2406.00	107.0 PK			1.00 V	256	73.00	34.00
4	*2406.00	101.4 AV			1.00 V	256	67.40	34.00
5	4812.00	48.1 PK	74.0	-25.9	1.00 V	123	46.80	1.30
6	4812.00	34.7 AV	54.0	-19.3	1.00 V	123	33.40	1.30

REMARKS:

1. Emission Level(dBuV/m) = Raw Value(dBuV) + Correction Factor(dB/m)
2. Correction Factor(dB/m) = Antenna Factor(dB/m) + Cable Factor(dB)
– Pre-Amplifier Factor(dB)
3. The other emission levels were very low against the limit.
4. Margin value = Emission Level – Limit value
5. “ * “: Fundamental frequency.



CHANNEL	TX Channel 9	DETECTOR FUNCTION	Peak (PK)
FREQUENCY RANGE	1GHz ~ 25GHz		Average (AV)

ANTENNA POLARITY & TEST DISTANCE: HORIZONTAL AT 3 M								
NO.	FREQ. (MHz)	EMISSION LEVEL (dBuV/m)	LIMIT (dBuV/m)	MARGIN (dB)	ANTENNA HEIGHT (m)	TABLE ANGLE (Degree)	RAW VALUE (dBuV)	CORRECTION FACTOR (dB/m)
1	*2438.00	100.9 PK			1.66 H	245	67.60	33.30
2	*2438.00	95.3 AV			1.66 H	245	62.00	33.30
3	4876.00	47.5 PK	74.0	-26.5	1.15 H	129	46.00	1.50
4	4876.00	38.6 AV	54.0	-15.4	1.15 H	129	37.10	1.50

ANTENNA POLARITY & TEST DISTANCE: VERTICAL AT 3 M								
NO.	FREQ. (MHz)	EMISSION LEVEL (dBuV/m)	LIMIT (dBuV/m)	MARGIN (dB)	ANTENNA HEIGHT (m)	TABLE ANGLE (Degree)	RAW VALUE (dBuV)	CORRECTION FACTOR (dB/m)
1	*2438.00	102.1 PK			1.00 V	255	68.80	33.30
2	*2438.00	96.1 AV			1.00 V	255	62.80	33.30
3	4876.00	45.7 PK	74.0	-28.3	1.00 V	84	44.20	1.50
4	4876.00	35.2 AV	54.0	-18.8	1.00 V	84	33.70	1.50

REMARKS:

1. Emission Level(dBuV/m) = Raw Value(dBuV) + Correction Factor(dB/m)
2. Correction Factor(dB/m) = Antenna Factor(dB/m) + Cable Factor(dB)
– Pre-Amplifier Factor(dB)
3. The other emission levels were very low against the limit.
4. Margin value = Emission Level – Limit value
5. “ * ”: Fundamental frequency.



CHANNEL	TX Channel 18	DETECTOR FUNCTION	Peak (PK)
FREQUENCY RANGE	1GHz ~ 25GHz		Average (AV)

ANTENNA POLARITY & TEST DISTANCE: HORIZONTAL AT 3 M								
NO.	FREQ. (MHz)	EMISSION LEVEL (dBuV/m)	LIMIT (dBuV/m)	MARGIN (dB)	ANTENNA HEIGHT (m)	TABLE ANGLE (Degree)	RAW VALUE (dBuV)	CORRECTION FACTOR (dB/m)
1	*2474.00	98.9 PK			1.43 H	239	65.50	33.40
2	*2474.00	92.9 AV			1.43 H	239	59.50	33.40
3	2483.50	60.6 PK	74.0	-13.4	1.43 H	239	27.20	33.40
4	2483.50	48.4 AV	54.0	-5.6	1.43 H	239	15.00	33.40
5	4948.00	47.7 PK	74.0	-26.3	1.14 H	119	46.00	1.70
6	4948.00	39.2 AV	54.0	-14.8	1.14 H	119	37.50	1.70
ANTENNA POLARITY & TEST DISTANCE: VERTICAL AT 3 M								
NO.	FREQ. (MHz)	EMISSION LEVEL (dBuV/m)	LIMIT (dBuV/m)	MARGIN (dB)	ANTENNA HEIGHT (m)	TABLE ANGLE (Degree)	RAW VALUE (dBuV)	CORRECTION FACTOR (dB/m)
1	*2474.00	99.5 PK			1.00 V	252	66.10	33.40
2	*2474.00	93.3 AV			1.00 V	252	59.90	33.40
3	2483.50	61.2 PK	74.0	-12.8	1.00 V	252	27.80	33.40
4	2483.50	48.5 AV	54.0	-5.5	1.00 V	252	15.10	33.40
5	4948.00	46.2 PK	74.0	-27.8	1.00 V	82	44.50	1.70
6	4948.00	36.8 AV	54.0	-17.2	1.00 V	82	35.10	1.70

REMARKS:

1. Emission Level(dBuV/m) = Raw Value(dBuV) + Correction Factor(dB/m)
2. Correction Factor(dB/m) = Antenna Factor(dB/m) + Cable Factor(dB)
– Pre-Amplifier Factor(dB)
3. The other emission levels were very low against the limit.
4. Margin value = Emission Level – Limit value
5. “ * “: Fundamental frequency.

BELOW 1GHz WORST-CASE DATA :

CHANNEL	TX Channel 1	DETECTOR FUNCTION	Quasi-Peak (QP)
FREQUENCY RANGE	30MHz ~ 1GHz		

ANTENNA POLARITY & TEST DISTANCE: HORIZONTAL AT 3 M								
NO.	FREQ. (MHz)	EMISSION LEVEL (dBuV/m)	LIMIT (dBuV/m)	MARGIN (dB)	ANTENNA HEIGHT (m)	TABLE ANGLE (Degree)	RAW VALUE (dBuV)	CORRECTION FACTOR (dB/m)
1	53.32	20.2 QP	40.0	-19.8	2.00 H	72	34.30	-14.10
2	70.42	26.1 QP	40.0	-13.9	2.00 H	201	42.40	-16.30
3	134.15	35.9 QP	43.5	-7.6	2.00 H	281	51.20	-15.30
4	250.74	29.9 QP	46.0	-16.1	1.01 H	112	44.30	-14.40
5	903.62	40.7 QP	46.0	-5.3	1.25 H	226	42.00	-1.30
6	981.35	32.0 QP	54.0	-22.0	1.25 H	36	31.90	0.10
ANTENNA POLARITY & TEST DISTANCE: VERTICAL AT 3 M								
NO.	FREQ. (MHz)	EMISSION LEVEL (dBuV/m)	LIMIT (dBuV/m)	MARGIN (dB)	ANTENNA HEIGHT (m)	TABLE ANGLE (Degree)	RAW VALUE (dBuV)	CORRECTION FACTOR (dB/m)
1	34.66	31.7 QP	40.0	-8.3	1.24 V	118	47.50	-15.80
2	51.76	30.7 QP	40.0	-9.3	1.00 V	335	44.60	-13.90
3	132.60	35.3 QP	43.5	-8.2	1.00 V	213	50.70	-15.40
4	188.56	28.1 QP	43.5	-15.4	1.49 V	181	44.30	-16.20
5	242.96	26.3 QP	46.0	-19.7	1.24 V	192	40.90	-14.60
6	990.67	32.3 QP	54.0	-21.7	1.00 V	167	32.10	0.20

REMARKS:

1. Emission Level(dBuV/m) = Raw Value(dBuV) + Correction Factor(dB/m)
2. Correction Factor(dB/m) = Antenna Factor(dB/m) + Cable Factor(dB)
– Pre-Amplifier Factor(dB)
3. The other emission levels were very low against the limit.
4. Margin value = Emission Level – Limit value

4.2 CONDUCTED EMISSION MEASUREMENT

4.2.1 LIMITS OF CONDUCTED EMISSION MEASUREMENT

FREQUENCY OF EMISSION (MHz)	CONDUCTED LIMIT (dB μ V)	
	Quasi-peak	Average
0.15 ~ 0.5	66 to 56	56 to 46
0.5 ~ 5	56	46
5 ~ 30	60	50

- NOTE:**
1. The lower limit shall apply at the transition frequencies.
 2. The limit decreases in line with the logarithm of the frequency in the range of 0.15 to 0.50MHz.
 3. All emanations from a class A/B digital device or system, including any network of conductors and apparatus connected thereto, shall not exceed the level of field strengths specified above.

4.2.2 TEST INSTRUMENTS

DESCRIPTION & MANUFACTURER	MODEL NO.	SERIAL NO.	DATE OF CALIBRATION	DUE DATE OF CALIBRATION
Test Receiver ROHDE & SCHWARZ	ESCS30	100288	Apr. 24, 2014	Apr. 23, 2015
RF signal cable Woken	5D-FB	Cable-HYCO2-01	Dec. 27, 2013	Dec. 26, 2014
LISN ROHDE & SCHWARZ (EUT)	ESH2-Z5	100100	Dec. 23, 2013	Dec. 22, 2014
LISN ROHDE & SCHWARZ (Peripheral)	ESH3-Z5	100312	Jul. 10, 2014	Jul. 09, 2015
Software ADT	BV ADT_Cond_ V7.3.7.3	NA	NA	NA

- Notes:
1. The calibration interval of the above test instruments is 12 months and the calibrations are traceable to NML/ROC and NIST/USA.
 2. The test was performed in HwaYa Shielded Room 2.
 3. The VCCI Site Registration No. is C-2047.

4.2.3 TEST PROCEDURES

- a. The EUT was placed 0.4 meters from the conducting wall of the shielded room with EUT being connected to the power mains through a line impedance stabilization network (LISN). Other support units were connected to the power mains through another LISN. The two LISNs provide 50 ohm/ 50uH of coupling impedance for the measuring instrument.
- b. Both lines of the power mains connected to the EUT were checked for maximum conducted interference.
- c. The frequency range from 150kHz to 30MHz was searched. Emission levels under (Limit - 20dB) was not recorded.

NOTE: All modes of operation were investigated and the worst-case emissions are reported.

4.2.4 DEVIATION FROM TEST STANDARD

No deviation.

4.2.5 TEST SETUP

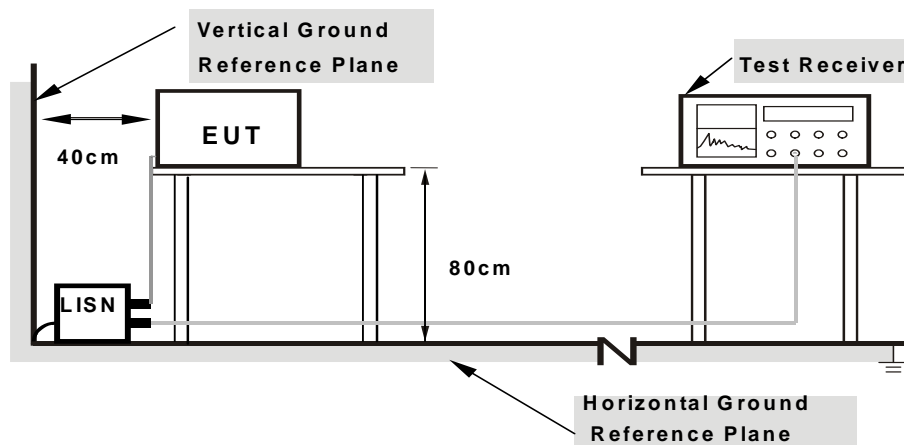

- Note:**
1. Support units were connected to second LISN.
 2. Both of LISNs (AMN) are 80 cm from EUT and at least 80 from other units and other metal planes

For the actual test configuration, please refer to the attached file (Test Setup Photo).

4.2.6 EUT OPERATING CONDITIONS

Same as 4.1.6.

4.2.7 TEST RESULTS

PHASE	Line 1	6dB BANDWIDTH	9kHz
--------------	--------	----------------------	------

No	Freq. [MHz]	Corr. Factor (dB)	Reading Value		Emission Level		Limit		Margin	
			[dB (uV)]		[dB (uV)]		[dB (uV)]		(dB)	
			Q.P.	AV.	Q.P.	AV.	Q.P.	AV.	Q.P.	AV.
1	0.18125	0.27	22.31	11.16	22.58	11.43	64.43	54.43	-41.84	-42.99
2	0.48594	0.31	29.13	23.85	29.44	24.16	56.24	46.24	-26.80	-22.08
3	1.68359	0.35	24.20	14.33	24.55	14.68	56.00	46.00	-31.45	-31.32
4	2.32813	0.37	26.40	16.55	26.77	16.92	56.00	46.00	-29.23	-29.08
5	3.17969	0.40	24.35	12.90	24.75	13.30	56.00	46.00	-31.25	-32.70
6	11.96484	0.51	11.74	3.78	12.25	4.29	60.00	50.00	-47.75	-45.71

REMARKS:

1. Q.P. and AV. are abbreviations of quasi-peak and average individually.
2. The emission levels of other frequencies were very low against the limit.
3. Margin value = Emission level - Limit value
4. Correction factor = Insertion loss + Cable loss
5. Emission Level = Correction Factor + Reading Value.

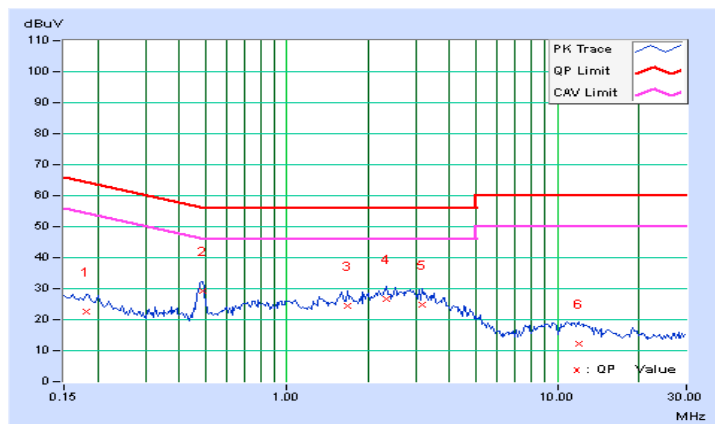

PHASE	Line 2	6dB BANDWIDTH	9kHz
-------	--------	---------------	------

No	Freq. [MHz]	Corr. Factor (dB)	Reading Value [dB (uV)]		Emission Level [dB (uV)]		Limit [dB (uV)]		Margin (dB)	
			Q.P.	AV.	Q.P.	AV.	Q.P.	AV.	Q.P.	AV.
			1	0.16172	0.27	25.39	8.40	25.66	8.67	65.38
2	0.48203	0.31	23.09	16.64	23.40	16.95	56.30	46.30	-32.91	-29.36
3	1.08984	0.34	16.84	9.45	17.18	9.79	56.00	46.00	-38.82	-36.21
4	2.10156	0.37	21.53	14.00	21.90	14.37	56.00	46.00	-34.10	-31.63
5	2.77734	0.40	22.10	14.40	22.50	14.80	56.00	46.00	-33.50	-31.20
6	11.92578	0.54	8.76	0.32	9.30	0.86	60.00	50.00	-50.70	-49.14

REMARKS:

1. Q.P. and AV. are abbreviations of quasi-peak and average individually.
2. The emission levels of other frequencies were very low against the limit.
3. Margin value = Emission level - Limit value
4. Correction factor = Insertion loss + Cable loss
5. Emission Level = Correction Factor + Reading Value.

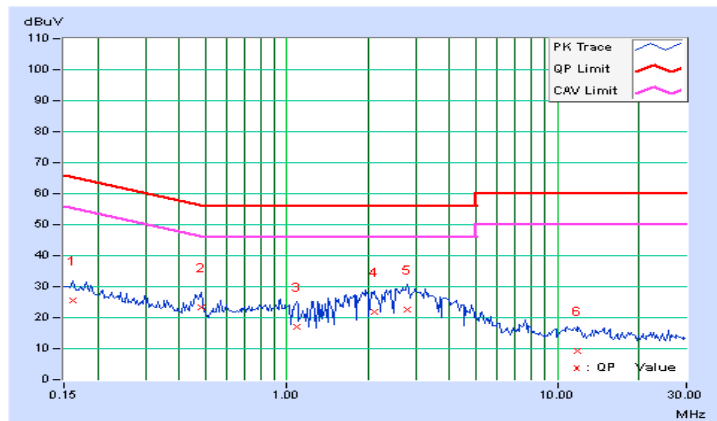

4.3 6dB BANDWIDTH MEASUREMENT

4.3.1 LIMITS OF 6dB BANDWIDTH MEASUREMENT

The minimum of 6dB Bandwidth Measurement is 0.5 MHz.

4.3.2 TEST SETUP

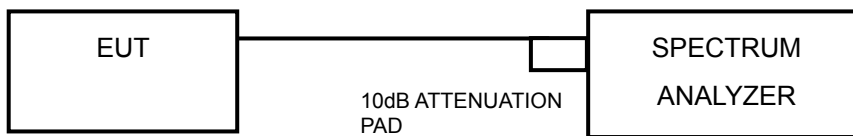

4.3.3 TEST INSTRUMENTS

Refer to section 4.1.2 to get information of above instrument.

4.3.4 TEST PROCEDURE

1. Set resolution bandwidth (RBW) = 100kHz
2. Set the video bandwidth (VBW) $\geq 3 \times$ RBW, Detector = Peak.
3. Trace mode = max hold.
4. Sweep = auto couple.
5. Measure the maximum width of the emission that is constrained by the frequencies associated with the two amplitude points (upper and lower) that are attenuated by 6 dB relative to the maximum level measured in the fundamental emission.

4.3.5 DEVIATION FROM TEST STANDARD

No deviation.

4.3.6 EUT OPERATING CONDITIONS

The software provided by client to enable the EUT under transmission condition continuously at lowest, middle and highest channel frequencies individually.

4.3.7 TEST RESULTS

CHANNEL	FREQUENCY (MHz)	6dB BANDWIDTH (MHz)	MINIMUM LIMIT (MHz)	PASS / FAIL
1	2406	2.30	0.5	PASS
9	2438	2.26	0.5	PASS
18	2474	2.16	0.5	PASS

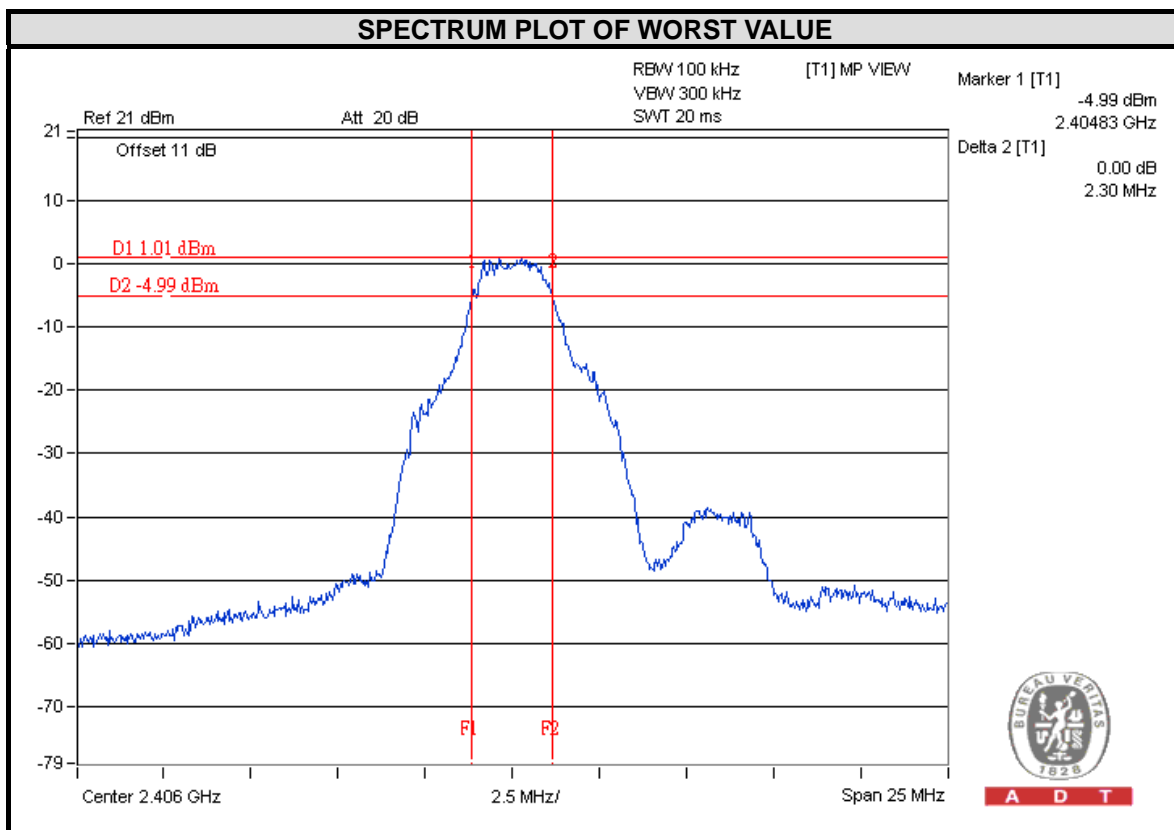

4.4 CONDUCTED OUTPUT POWER

4.4.1 LIMITS OF CONDUCTED OUTPUT POWER MEASUREMENT

For systems using digital modulation in the 2400–2483.5 MHz: 1 Watt (30dBm)

4.4.2 TEST SETUP

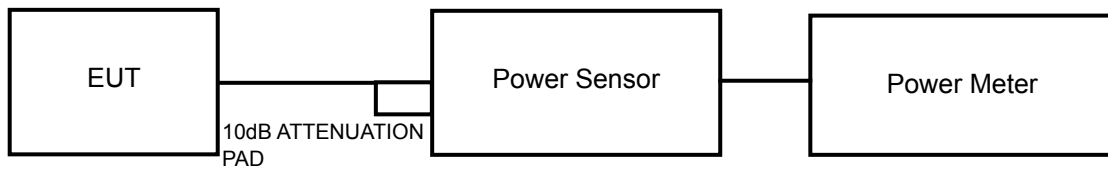

4.4.3 TEST INSTRUMENTS

Refer to section 4.1.2 to get information of above instrument.

4.4.4 TEST PROCEDURES

A peak power sensor was used on the output port of the EUT. A power meter was used to read the response of the peak power sensor. Record the peak power level.

4.4.5 DEVIATION FROM TEST STANDARD

No deviation.

4.4.6 EUT OPERATING CONDITIONS

Same as Item 4.3.6.

4.4.7 TEST RESULTS

CHANNEL	FREQUENCY (MHz)	PEAK POWER (mW)	PEAK POWER (dBm)	LIMIT (dBm)	PASS/FAIL
1	2406	2.673	4.27	30	PASS
9	2438	2.056	3.13	30	PASS
18	2474	1.648	2.17	30	PASS

4.5 POWER SPECTRAL DENSITY MEASUREMENT

4.5.1 LIMITS OF POWER SPECTRAL DENSITY MEASUREMENT

The Maximum of Power Spectral Density Measurement is 8dBm.

4.5.2 TEST SETUP

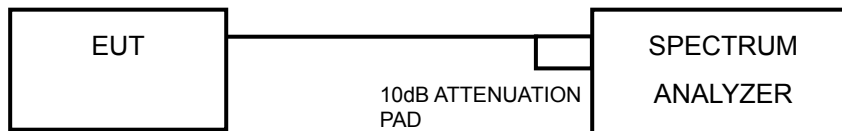

4.5.3 TEST INSTRUMENTS

Refer to section 4.1.2 to get information of above instrument.

4.5.4 TEST PROCEDURE

- a. Set resolution bandwidth (RBW) = approximately 1% of the emission bandwidth
- b. Set the video bandwidth (VBW) $\geq 3 \times$ RBW, Detector = Peak.
- c. Trace mode = max hold.
- d. Sweep = auto couple.
- e. Measure the maximum width of the emission that is constrained by the frequencies associated with the two amplitude points (upper and lower) that are attenuated by 6 dB relative to the maximum level measured in the fundamental emission

4.5.5 DEVIATION FROM TEST STANDARD

No deviation.

4.5.6 EUT OPERATING CONDITION

Same as Item 4.3.6

4.5.7 TEST RESULTS

Channel	FREQ. (MHz)	PSD (dBm/3kHz)	Limit (dBm/3kHz)	PASS /FAIL
1	2406	-13.06	8	PASS
9	2438	-13.99	8	PASS
18	2474	-16.04	8	PASS

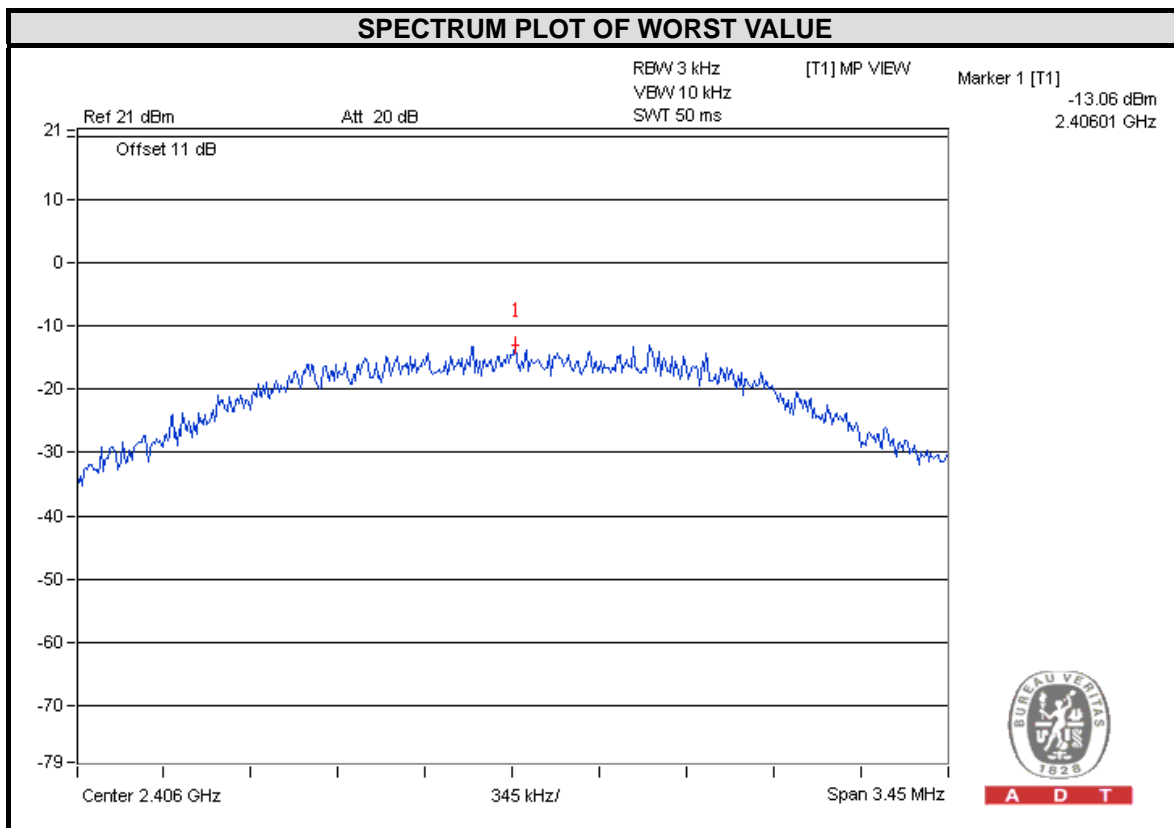

4.6 CONDUCTED OUT OF BAND EMISSION MEASUREMENT

4.6.1 LIMITS OF OUT OF BAND EMISSION MEASUREMENT

Below -20dB of the highest emission level of operating band (in 100kHz Resolution Bandwidth).

4.6.2 TEST SETUP

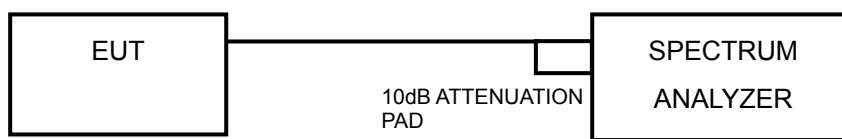

4.6.3 TEST INSTRUMENTS

Refer to section 4.1.2 to get information of above instrument.

4.6.4 TEST PROCEDURE

MEASUREMENT PROCEDURE REF

1. Set the RBW = 100 kHz.
2. Set the VBW \geq 300 kHz.
3. Detector = peak.
4. Sweep time = auto couple.
5. Trace mode = max hold.
6. Allow trace to fully stabilize.
7. Use the peak marker function to determine the maximum power level in any 100 kHz band segment within the fundamental EBW.

MEASUREMENT PROCEDURE OOB

1. Set RBW = 100 kHz.
2. Set VBW \geq 300 kHz.
3. Detector = peak.
4. Sweep = auto couple.
5. Trace Mode = max hold.
6. Allow trace to fully stabilize.
7. Use the peak marker function to determine the maximum amplitude level.

4.6.5 DEVIATION FROM TEST STANDARD

No deviation.

4.6.6 EUT OPERATING CONDITION

Same as Item 4.3.6

4.6.7 TEST RESULTS

The spectrum plots are attached on the following pages. D1 line indicates the highest level, and D2 line indicates the 20dB offset below D1. It shows compliance with the requirement.

4.6.8 TEST RESULTS

CH 1

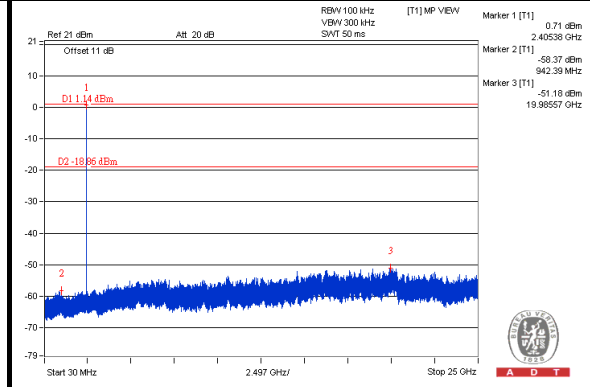
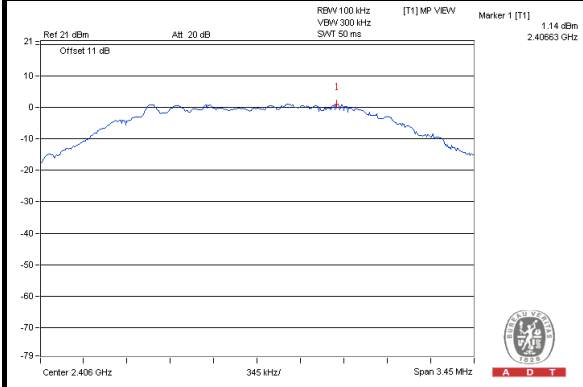

CH 9

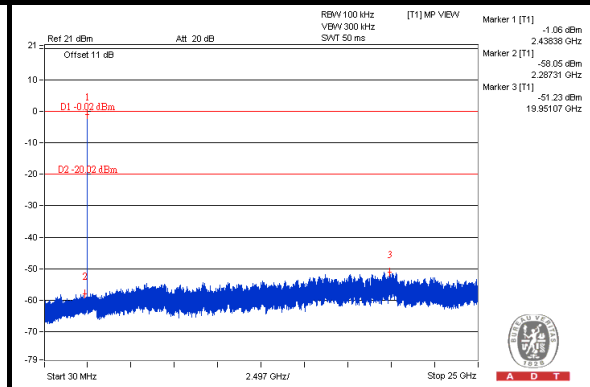
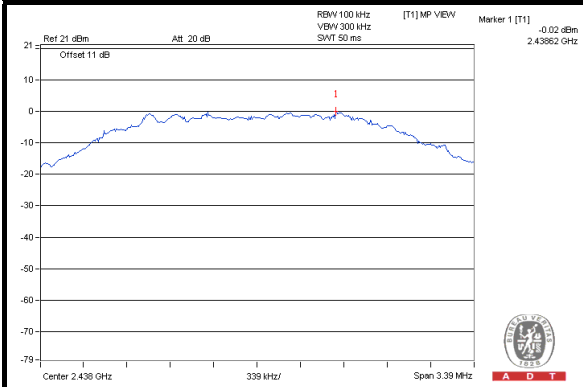

CH 18

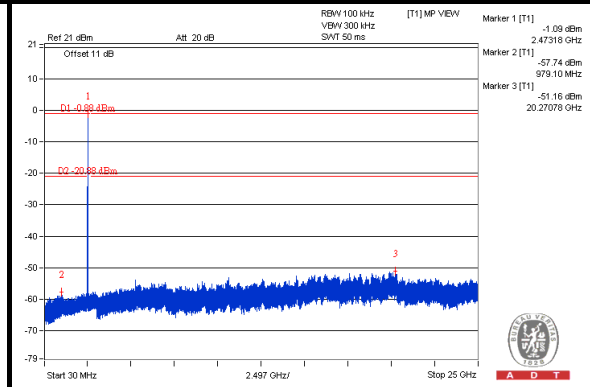
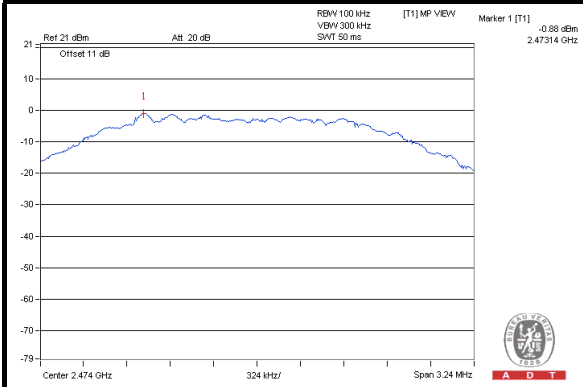

CH 1 Band edge

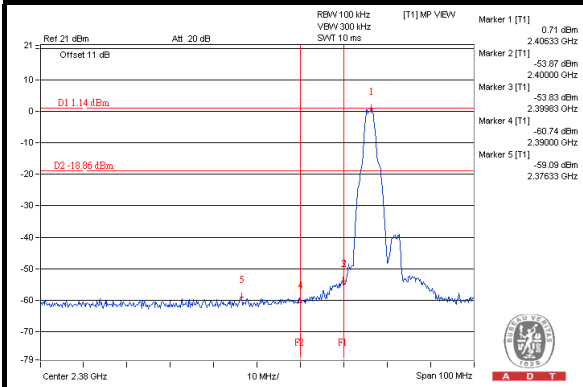

CH 18 Band edge

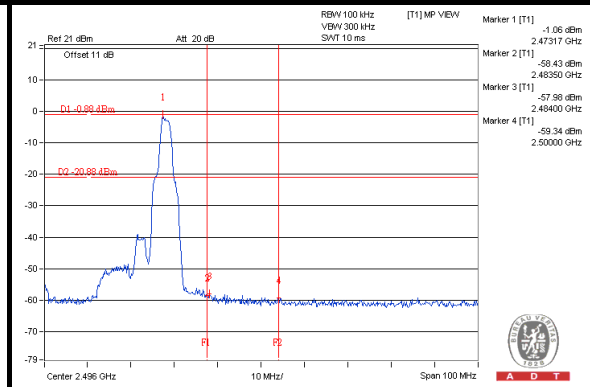



5. PHOTOGRAPHS OF THE TEST CONFIGURATION

Please refer to the attached file (Test Setup Photo).





6. INFORMATION ON THE TESTING LABORATORIES

We, Bureau Veritas Consumer Products Services (H.K.) Ltd., Taoyuan Branch, were founded in 1988 to provide our best service in EMC, Radio, Telecom and Safety consultation. Our laboratories are accredited and approved according to ISO/IEC 17025.

If you have any comments, please feel free to contact us at the following:

Linko EMC/RF Lab:

Tel: 886-2-26052180

Fax: 886-2-26051924

Hsin Chu EMC/RF/Telecom Lab:

Tel: 886-3-5935343

Fax: 886-3-5935342

Hwa Ya EMC/RF/Safety Lab:

Tel: 886-3-3183232

Fax: 886-3-3270892

Email: service.adt@tw.bureauveritas.com

Web Site: www.bureauveritas-adt.com

The address and road map of all our labs can be found in our web site also.

7. APPENDIX A - MODIFICATIONS RECORDERS FOR ENGINEERING CHANGES TO THE EUT BY THE LAB

No modifications were made to the EUT by the lab during the test.

--- END ---