



**FCC CFR47 PART 15 SUBPART C
CERTIFICATION**

TEST REPORT

**FOR
802.11B/G MINI-PCI CARD**

MODEL NUMBER: PA3362U-1MPC

FCC ID: CJ6UPA3362WL

REPORT NUMBER: 03U2392-1

ISSUE DATE: DECEMBER 8, 2003

Prepared for
**TOSHIBA CORPORATION DIGITAL MEDIA NETWORK COMPANY
2-9 SUEHIRO-CHO, OME
TOKYO, 198-8710, JAPAN**

Prepared by
**COMPLIANCE CERTIFICATION SERVICES
561F MONTEREY ROAD,
MORGAN HILL, CA 95037, USA
TEL: (408) 463-0885
FAX: (408) 463-0888**



TABLE OF CONTENTS

1. TEST RESULT CERTIFICATION.....	3
2. EUT DESCRIPTION.....	4
3. TEST METHODOLOGY.....	5
4. FACILITIES AND ACCREDITATION.....	5
5. CALIBRATION AND UNCERTAINTY.....	6
5.1. MEASURING INSTRUMENT CALIBRATION.....	6
5.2. MEASUREMENT UNCERTAINTY.....	6
5.3. TEST AND MEASUREMENT EQUIPMENT.....	7
6. SETUP OF EQUIPMENT UNDER TEST.....	8
7. APPLICABLE LIMITS AND TEST RESULTS.....	10
7.1. 6 dB BANDWIDTH.....	10
7.2. 99% BANDWIDTH.....	17
7.3. PEAK OUTPUT POWER.....	24
7.4. MAXIMUM PERMISSIBLE EXPOSURE.....	32
7.5. AVERAGE POWER.....	35
7.6. PEAK POWER SPECTRAL DENSITY.....	36
7.7. CONDUCTED SPURIOUS EMISSIONS.....	43
7.8. RADIATED EMISSIONS LIMITS AND PROCEDURES.....	56
7.8.1. TRANSMITTER RADIATED SPURIOUS EMISSIONS.....	56
7.8.2. CO-LOCATED TRANSMITTER RADIATED EMISSIONS.....	58
7.9. RADIATED EMISSIONS RESULTS WITH HTL017 ANTENNA.....	59
7.9.1. TRANSMITTER RADIATED EMISSIONS ABOVE 1 GHz.....	59
7.9.2. CO-LOCATED TRANSMITTER EMISSIONS ABOVE 1 GHz.....	77
7.9.3. WORST-CASE RADIATED EMISSIONS BELOW 1 GHz.....	86
7.10. RADIATED EMISSIONS RESULTS WITH TIAN01 ANTENNA.....	90
7.10.1. TRANSMITTER RADIATED EMISSIONS ABOVE 1 GHz.....	90
7.10.2. CO-LOCATED TRANSMITTER EMISSIONS ABOVE 1 GHz.....	108
7.10.3. WORST-CASE RADIATED EMISSIONS BELOW 1 GHz.....	117
7.11. POWERLINE CONDUCTED EMISSIONS.....	121
8. SETUP PHOTOS.....	124

1. TEST RESULT CERTIFICATION

COMPANY NAME: TOSHIBA CORPORATION DIGITAL MEDIA NETWORK COMPANY
2-9 SUEHIRO-CHO, OME
TOKYO, 198-8710, JAPAN

EUT DESCRIPTION: 802.11b/g Mini-PCI Card

MODEL: PA3362U-1MPC

DATE TESTED: NOVEMBER 25 – DECEMBER 8, 2003

APPLICABLE STANDARDS	
STANDARD	TEST RESULTS
FCC PART 15 SUBPART C	NO NON-COMPLIANCE NOTED

Compliance Certification Services, Inc. tested the above equipment in accordance with the requirements set forth in the above standards. The test results show that the equipment tested is capable of demonstrating compliance with the requirements as documented in this report.

Note: This document reports conditions under which testing was conducted and results of tests performed. This document may not be altered or revised in any way unless done so by Compliance Certification Services and all revisions are duly noted in the revisions section. Any alteration of this document not carried out by Compliance Certification Services will constitute fraud and shall nullify the document.

Approved & Released For CCS By:

Tested By:



MIKE HECKROTTE
CHIEF ENGINEER
COMPLIANCE CERTIFICATION SERVICES

YAN ZHENG
EMC ENGINEER
COMPLIANCE CERTIFICATION SERVICES

2. EUT DESCRIPTION

The EUT is an 802.11b/g transceiver. It is installed in a Toshiba Tablet PC host computer, model Portege M200, including co-location with the Toshiba PA3232U-1BTM Bluetooth radio card.

The WLAN transmitter has a maximum peak conducted output power as follows:

Frequency Band (MHz)	Mode	Output Power (dBm)	Output Power (mW)
2412 - 2462	802.11b	17.77	59.84
2412 - 2462	802.11g	16.84	48.31

The WLAN radio utilizes two identical internal antennas for diversity. Additionally three antenna models in two antenna types are specified. One pair of a particular model is used in each particular installation.

One type is a Monopole antenna, model HTL017, with a maximum gain of 2.2 dBi.

The other type is a Planar Inverted F antenna, with two models: the highest gain model is TIAN01, with a maximum gain of 2.0dBi; the other model is HTL008, with a maximum gain of 0.5 dBi.

The Bluetooth radio card has a modular approval, FCC ID: CJ6UPA3232BT. The Bluetooth radio utilizes a film antenna with a maximum gain of 1.22 dBi.

3. TEST METHODOLOGY

The tests documented in this report were performed in accordance with ANSI C63.4/2001, FCC CFR 47 Part 2 and FCC CFR 47 Part 15.

4. FACILITIES AND ACCREDITATION

The test sites and measurement facilities used to collect data are located at 561F Monterey Road, Morgan Hill, California, USA. The sites are constructed in conformance with the requirements of ANSI C63.4, ANSI C63.7 and CISPR Publication 22. All receiving equipment conforms to CISPR Publication 16-1, "Radio Interference Measuring Apparatus and Measurement Methods."

CCS is accredited by NVLAP, Laboratory Code 200065-0. The full scope of accreditation can be viewed at <http://www.ccsemc.com>.



No part of this report may be used to claim or imply product endorsement by NVLAP or any agency of the US Government.

5. CALIBRATION AND UNCERTAINTY

5.1. MEASURING INSTRUMENT CALIBRATION

The measuring equipment utilized to perform the tests documented in this report has been calibrated in accordance with the manufacturer's recommendations, and is traceable to recognized national standards.

5.2. MEASUREMENT UNCERTAINTY

Where relevant, the following measurement uncertainty levels have been estimated for tests performed on the apparatus:

PARAMETER	UNCERTAINTY
Radiated Emission, 30 to 200 MHz	+/- 3.3 dB
Radiated Emission, 200 to 1000 MHz	+4.5 / -2.9 dB
Radiated Emission, 1000 to 2000 MHz	+4.5 / -2.9 dB
Power Line Conducted Emission	+/- 2.9 dB

Uncertainty figures are valid to a confidence level of 95%.

5.3. TEST AND MEASUREMENT EQUIPMENT

The following test and measurement equipment was utilized for the tests documented in this report:

TEST AND MEASUREMENT EQUIPMENT LIST				
Name of Equipment	Manufacturer	Model	Serial Number	Calibration Due Date
EMI Test Receiver	R & S	ESHS 20	827129/006	7/17/2004
LISN, 10 kHz ~ 30 MHz	FCC	LISN-50/250-25-2	2023	10/13/2004
LISN, 10 kHz ~ 30 MHz	Solar	8012-50-R-24-BNC	8379443	10/13/2004
Line Filter	Lindgren	LMF-3489	497	CNR
EMI Receiver, 9 kHz ~ 2.9 GHz	HP	8542E	3942A00286	11/21/2004
RF Filter Section	HP	85420E	3705A00256	11/21/2004
Antenna, Bicon/Log, 25 ~ 2000 MHz	ARA	LPB-2520/A	1185	3/6/2004
Antenna, Horn 1 ~ 18 GHz	EMCO	3115	6717	2/4/2004
Antenna, Horn, 18 ~ 26 GHz	ARA	MWH-1826/B	1013	2/2/2004
Amplifier 1-26GHz	MITEQ	NSP2600-SP	924342	4/25/2004
Peak / Average Power Sensor	Agilent	E9327A	US40440755	11/7/2004
Power Meter	Agilent	E4416A	GB41291160	11/7/2004
Spectrum Analyzer	HP	E4446A	US42510266	7/23/2004
Band Reject 2.4GHz	Micro-Tronics	BRM50702	003	N.C.R.

6. SETUP OF EQUIPMENT UNDER TEST

SUPPORT EQUIPMENT

PERIPHERAL SUPPORT EQUIPMENT LIST				
Device Type	Manufacturer	Model	Serial Number	FCC ID
LapTop	Toshiba	M200	93070085JU	N/A
AC/DC Adapter	Toshiba	ADP-60RHA	G71C0002S110	N/A

I/O CABLES

Cable No.	Port	# of Identical Ports	Connector Type	Cable Type	Cable Length	Remarks
1	AC	1	US115	Unshielded	2m	N/A
2	DC	1	DC	Unshielded	2m	N/A

TEST SETUP

The EUT is installed in a host laptop computer. Test software exercised the radio card.

SETUP DIAGRAM

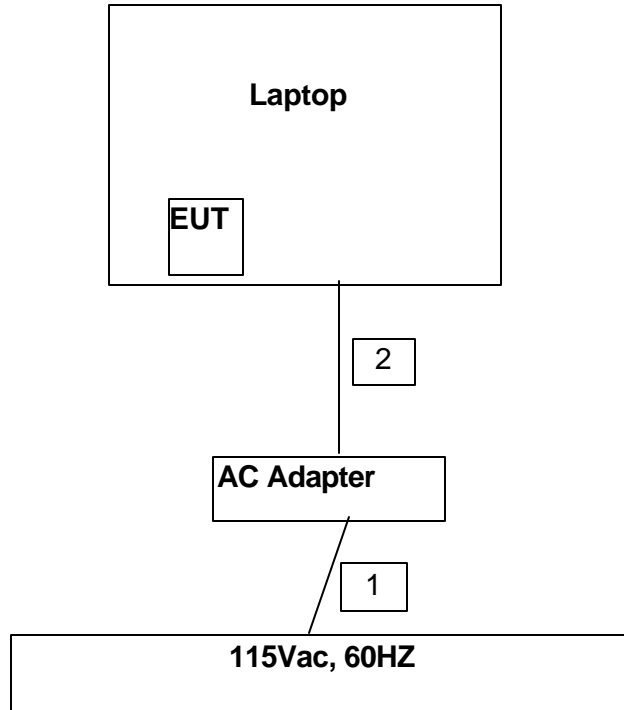

7. APPLICABLE LIMITS AND TEST RESULTS

7.1. 6 dB BANDWIDTH

LIMIT

§15.247 (a) (2) For direct sequence systems, the minimum 6 dB bandwidth shall be at least 500 kHz.

TEST PROCEDURE

The transmitter output is connected to a spectrum analyzer. The RBW is set to 100 kHz and the VBW is set to 100 kHz. The sweep time is coupled.

RESULTS

No non-compliance noted:

802.11b Mode

Channel	Frequency (MHz)	6 dB Bandwidth (kHz)	Minimum Limit (kHz)	Margin (kHz)
Low	2412	9070	500	8570
Middle	2437	9100	500	8600
High	2462	9130	500	8630

802.11g Mode

Channel	Frequency (MHz)	6 dB Bandwidth (kHz)	Minimum Limit (kHz)	Margin (kHz)
Low	2412	16430	500	15930
Middle	2437	16430	500	15930
High	2462	16370	500	15870

6 DB BANDWIDTH (802.11b MODE)

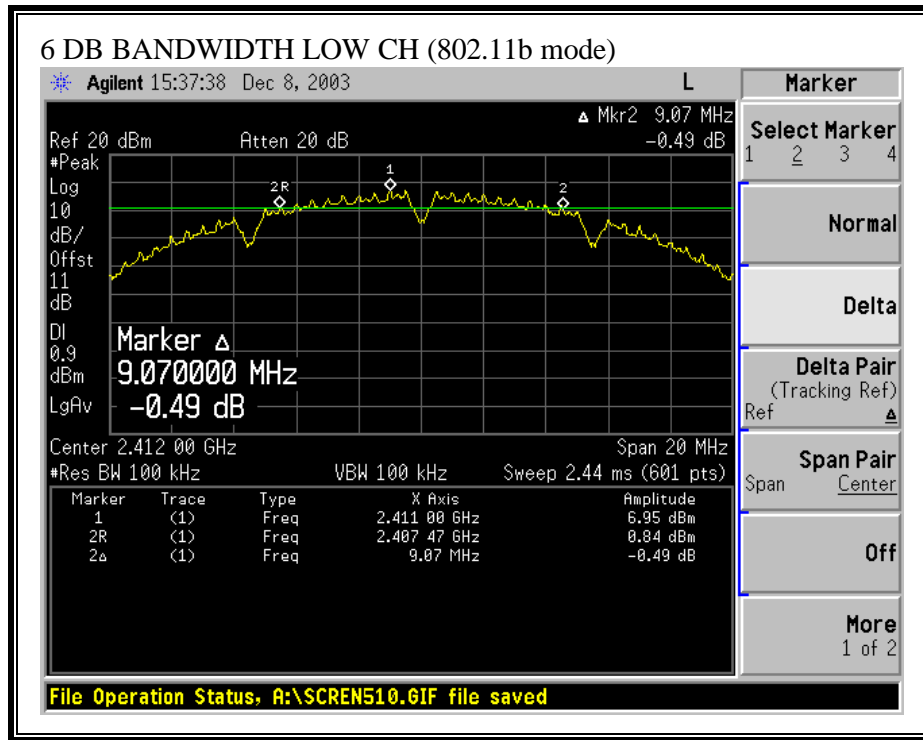

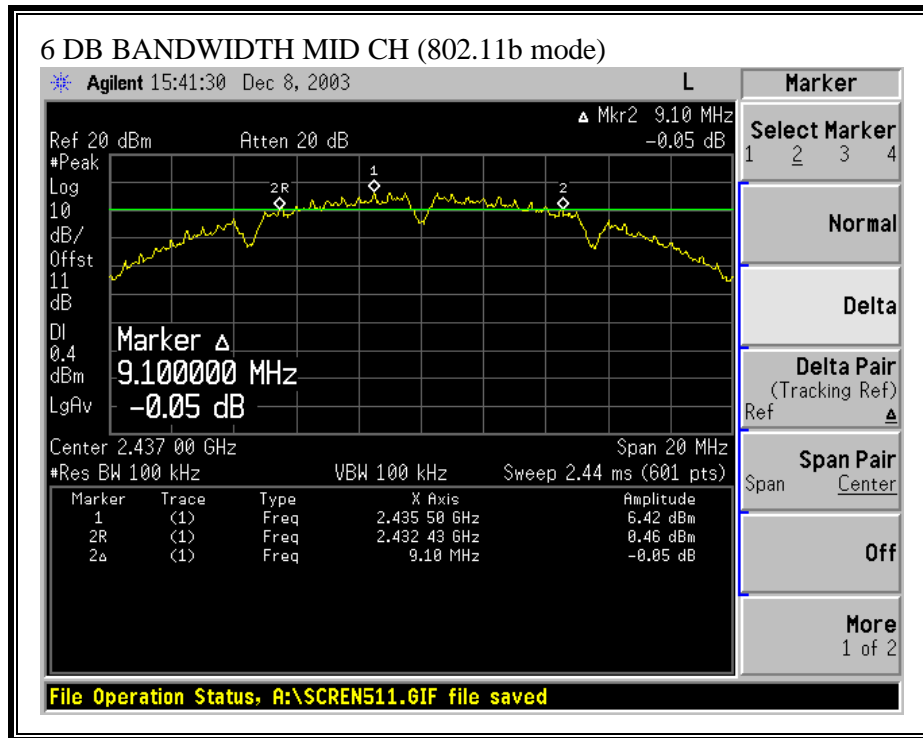

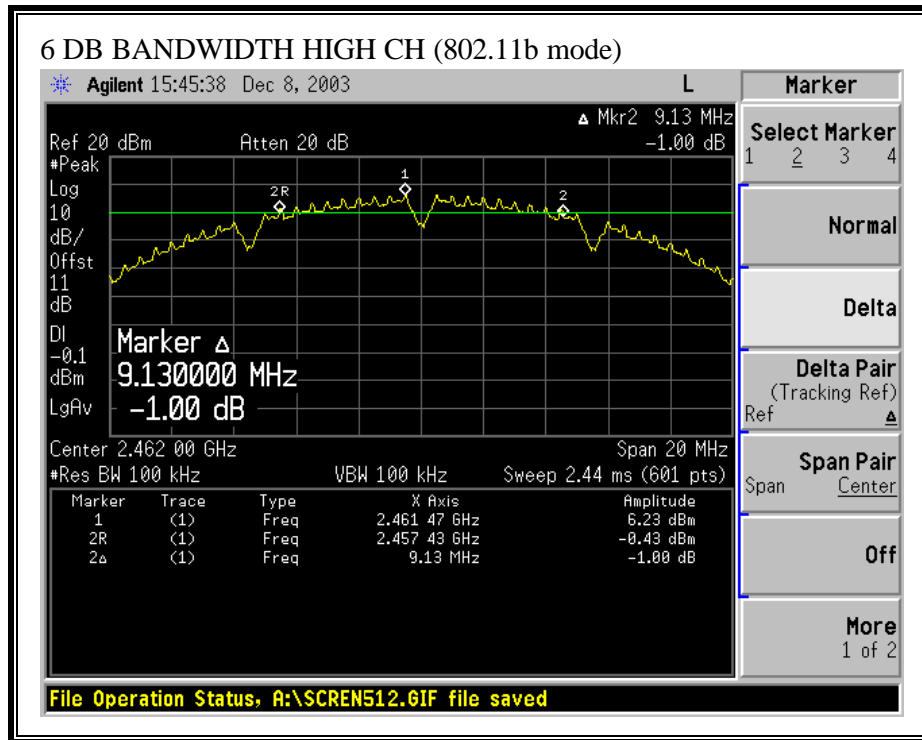

6 DB BANDWIDTH (802.11g MODE)

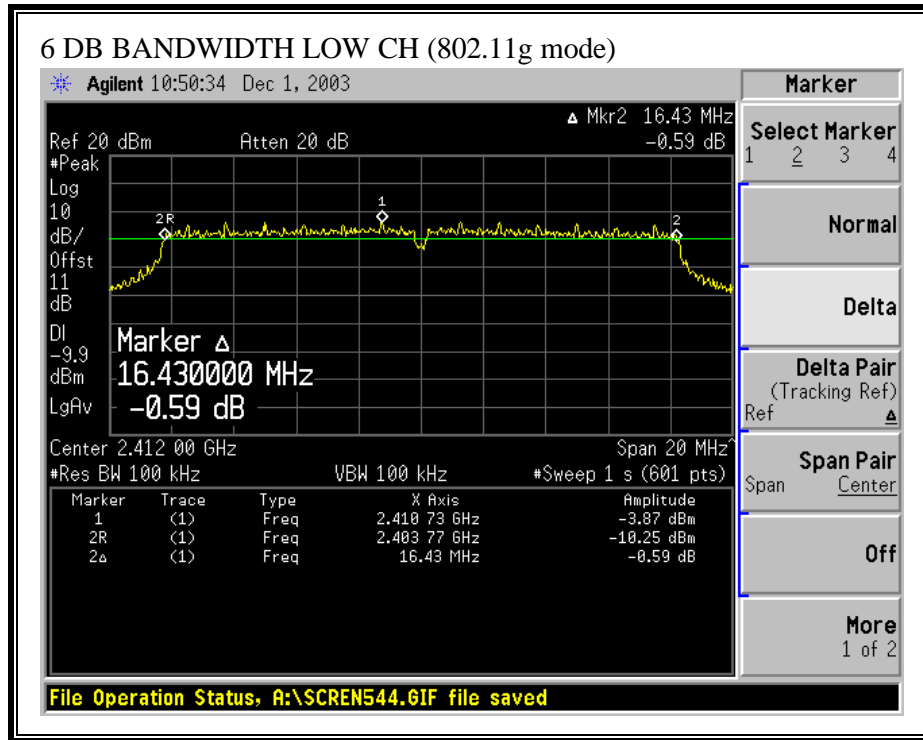

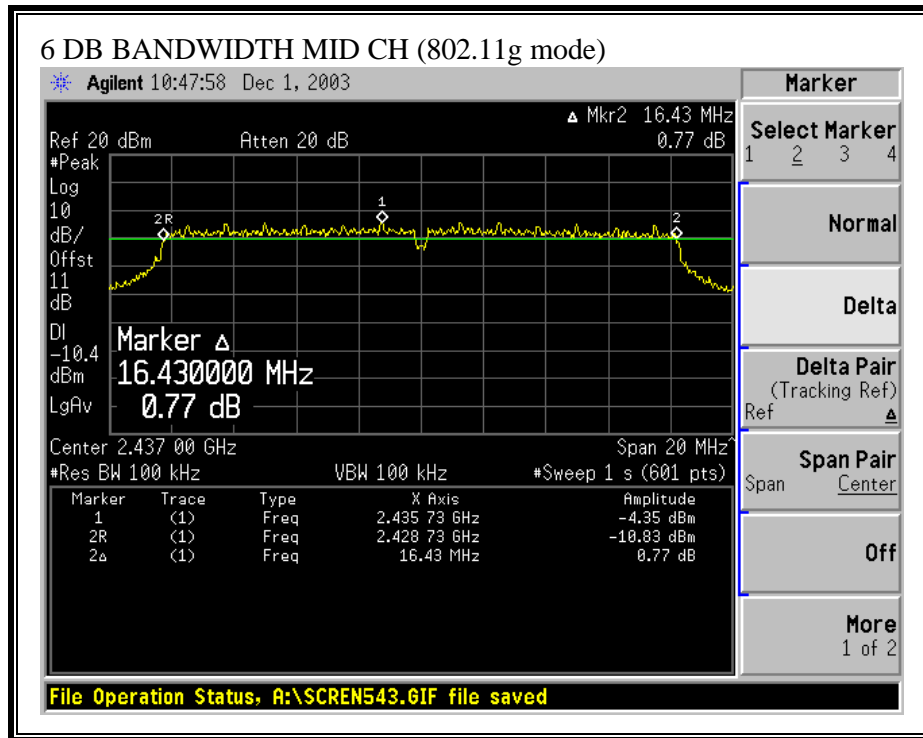

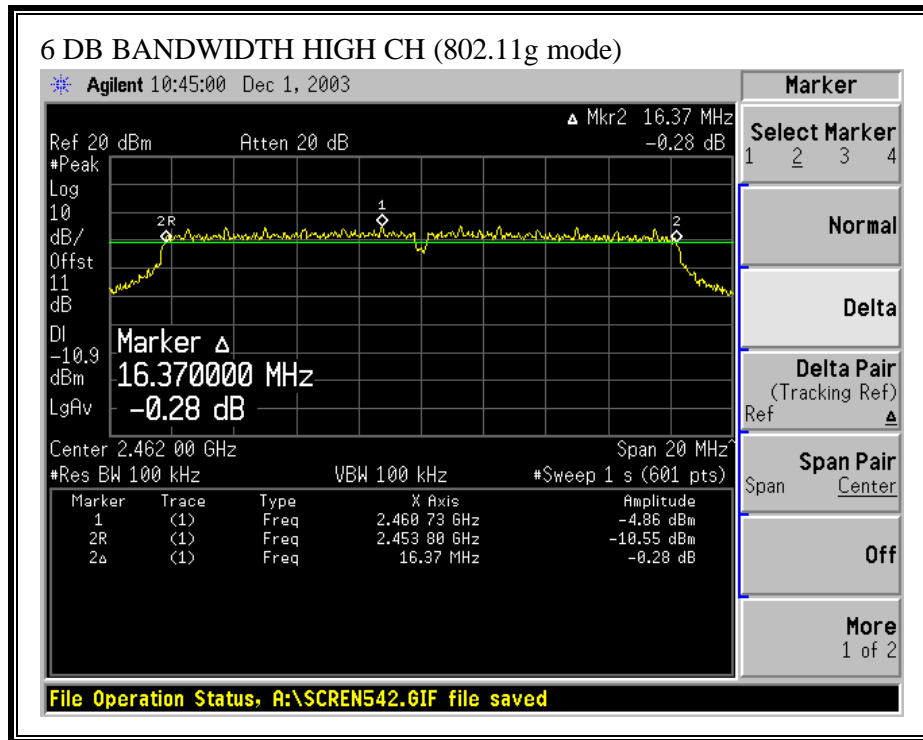

7.2. 99% BANDWIDTH

LIMIT

None; for reporting purposes only.

TEST PROCEDURE

The transmitter output is connected to the spectrum analyzer. The RBW is set to 1% to 3% of the 99 % bandwidth. The VBW is set to 3 times the RBW. The sweep time is coupled. The spectrum analyzer internal 99% bandwidth function is utilized.

RESULTS

No non-compliance noted:

802.11b Mode

Channel	Frequency (MHz)	99% Bandwidth (MHz)
Low	2412	14.9332
Middle	2437	15.1227
High	2462	14.8068

802.11g Mode

Channel	Frequency (MHz)	99% Bandwidth (MHz)
Low	2412	16.6415
Middle	2437	16.5314
High	2462	16.6165

99% BANDWIDTH (802.11b MODE)

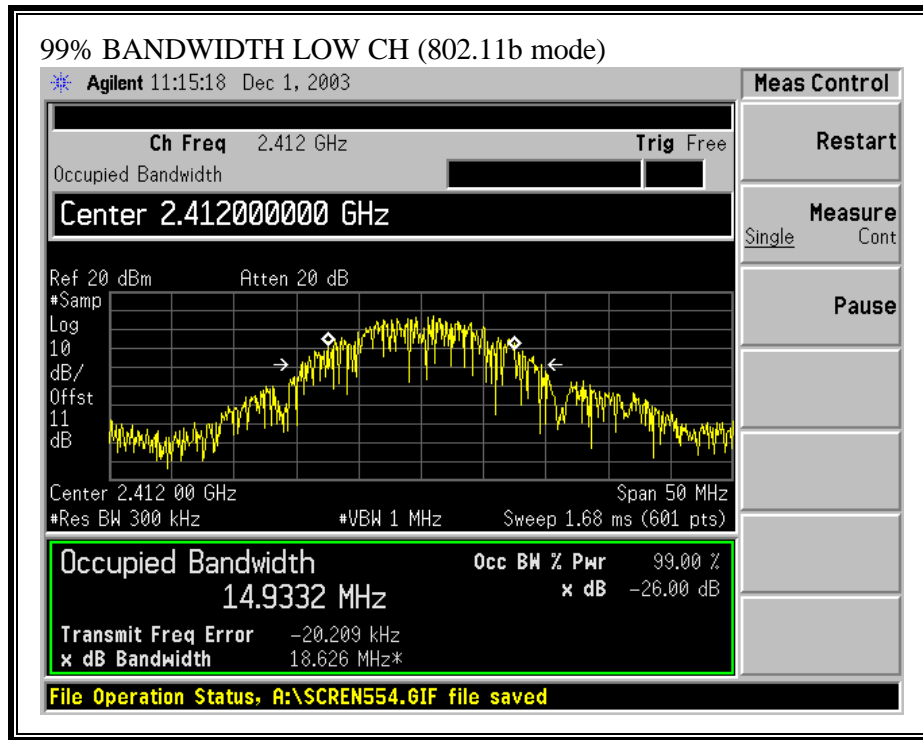

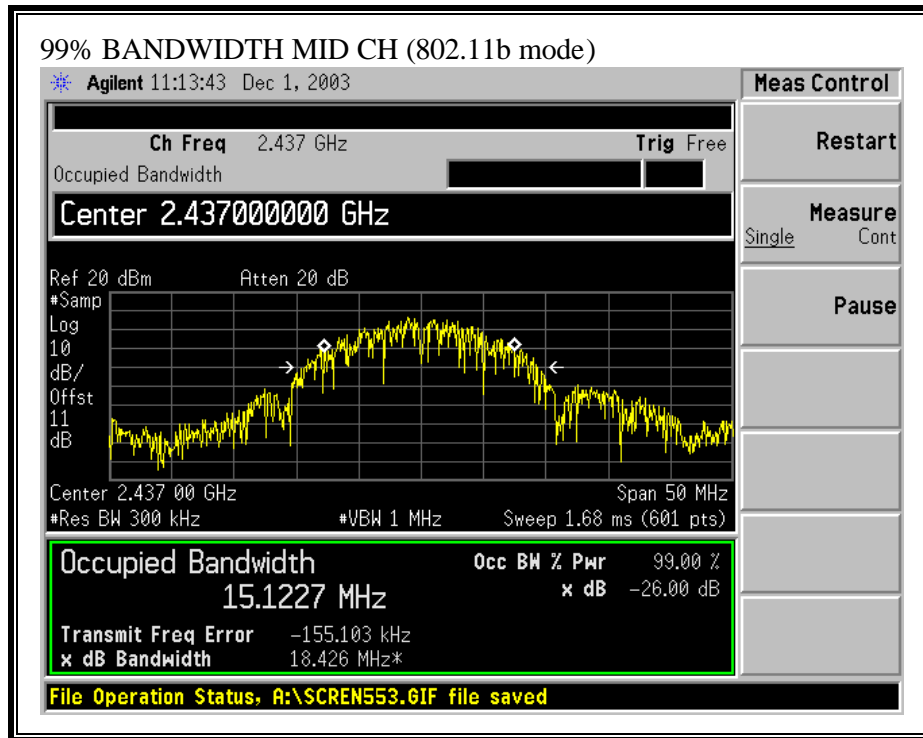

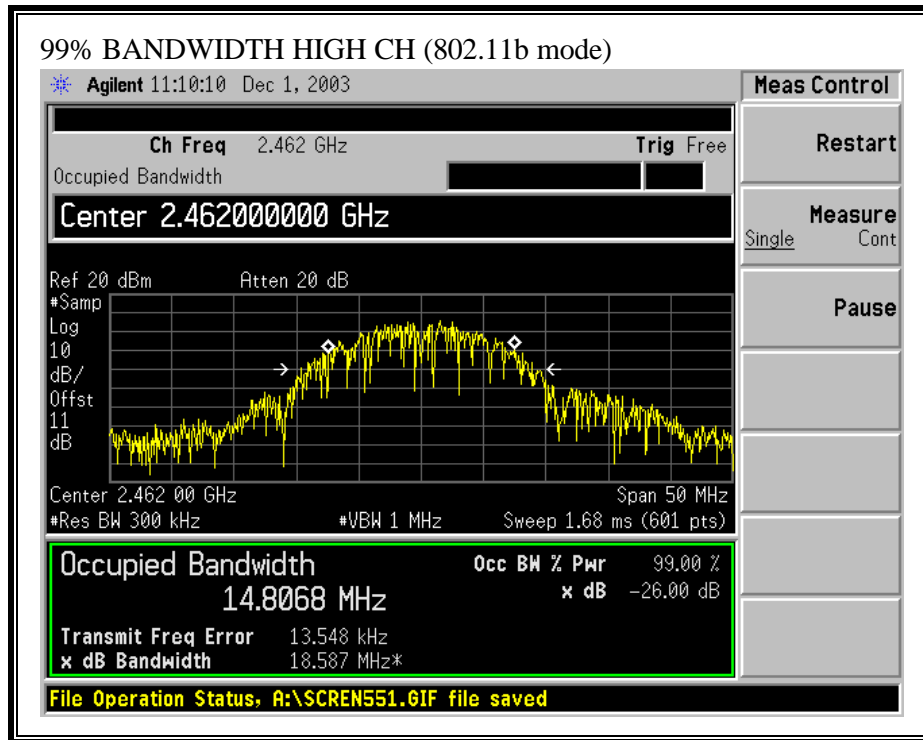

99% BANDWIDTH (802.11g MODE)

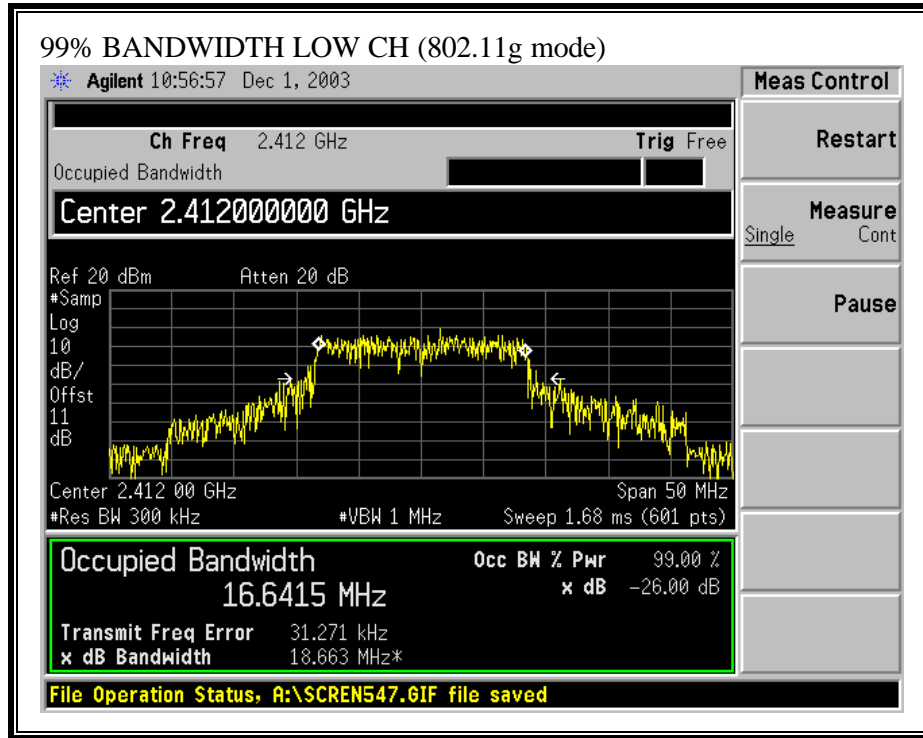

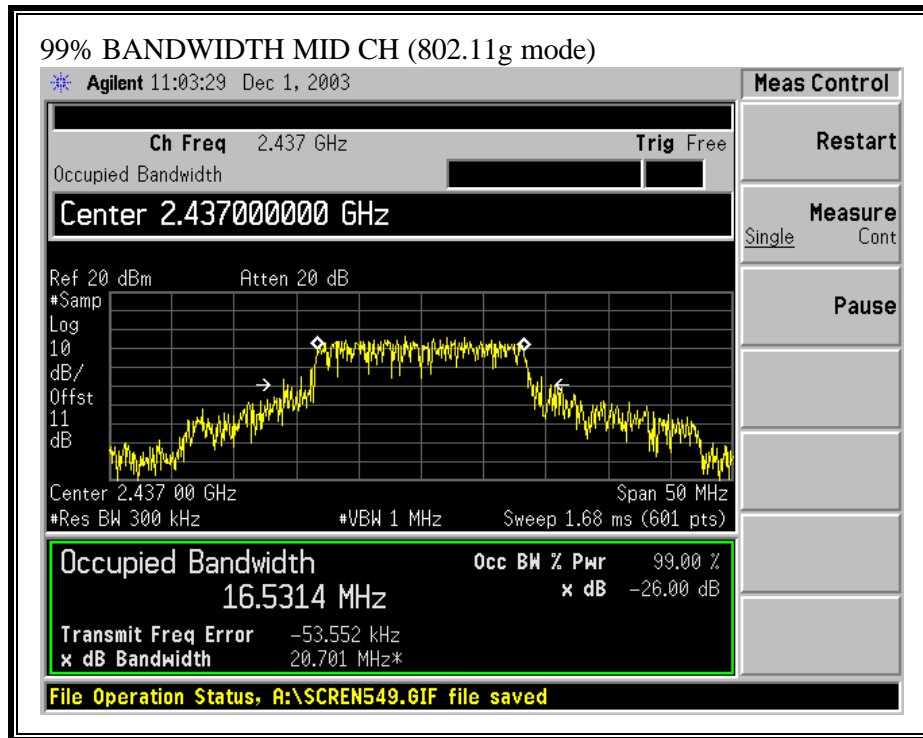

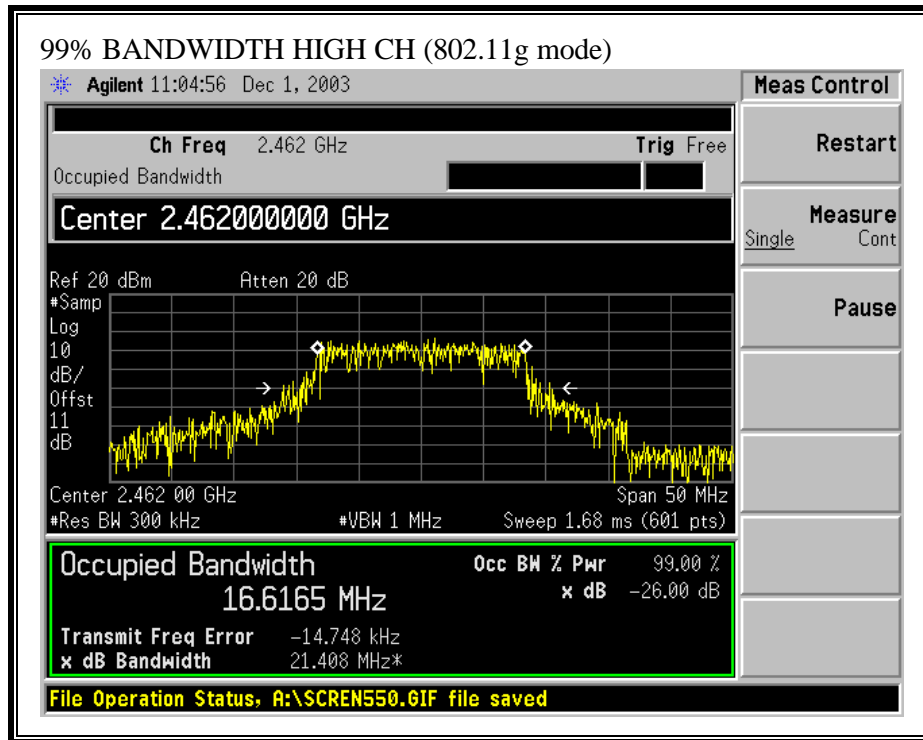

7.3. PEAK OUTPUT POWER

PEAK POWER LIMIT

§15.247 (b) The maximum peak output power of the intentional radiator shall not exceed the following:

§15.247 (b) (3) For systems using digital modulation in the 902-928 MHz, 2400-2483.5 MHz , and 5725-5850 MHz bands: 1 watt.

§15.247 (b) (4) Except as shown in paragraphs (b)(3) (i), (ii) and (iii) of this section, if transmitting antennas of directional gain greater than 6 dBi are used the peak output power from the intentional radiator shall be reduced below the stated values in paragraphs (b)(1) or (b)(2) of this section, as appropriate, by the amount in dB that the directional gain of the antenna exceeds 6 dBi.

The maximum antenna gain is 2.2 dBi, therefore the limit is 30 dBm.

TEST PROCEDURE

The transmitter output is connected to a spectrum analyzer and the analyzer's internal channel power integration function is used to integrate the power over a bandwidth greater than or equal to the 99% bandwidth.

RESULTS

No non-compliance noted:

802.11b Mode

Channel	Frequency (MHz)	Peak Power (dBm)	Limit (dBm)	Margin (dB)
Low	2412	17.74	30	-12.26
Middle	2437	17.62	30	-12.38
High	2462	17.77	30	-12.23

802.11g Mode

Channel	Frequency (MHz)	Peak Power (dBm)	Limit (dBm)	Margin (dB)
Low	2412	16.84	30	-13.16
Middle	2437	16.39	30	-13.61
High	2462	16.46	30	-13.54

OUTPUT POWER (802.11b MODE)

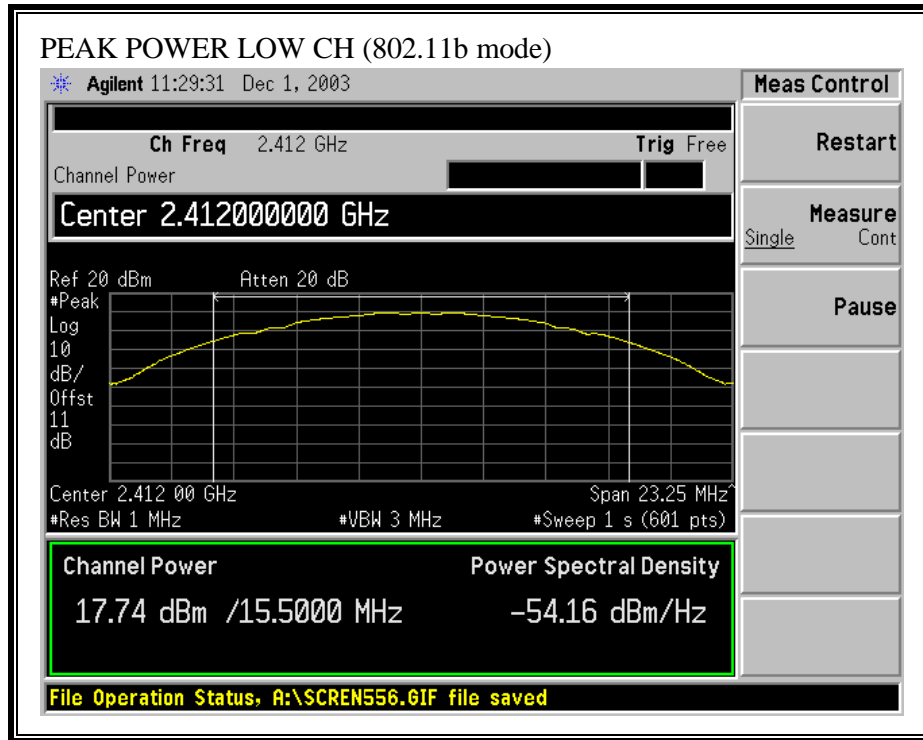

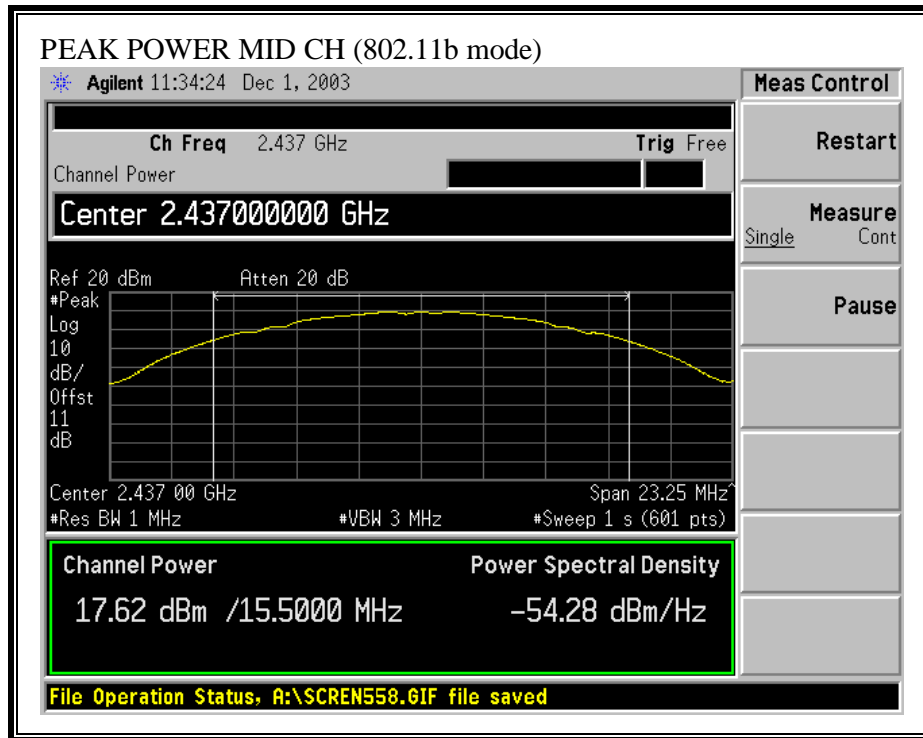

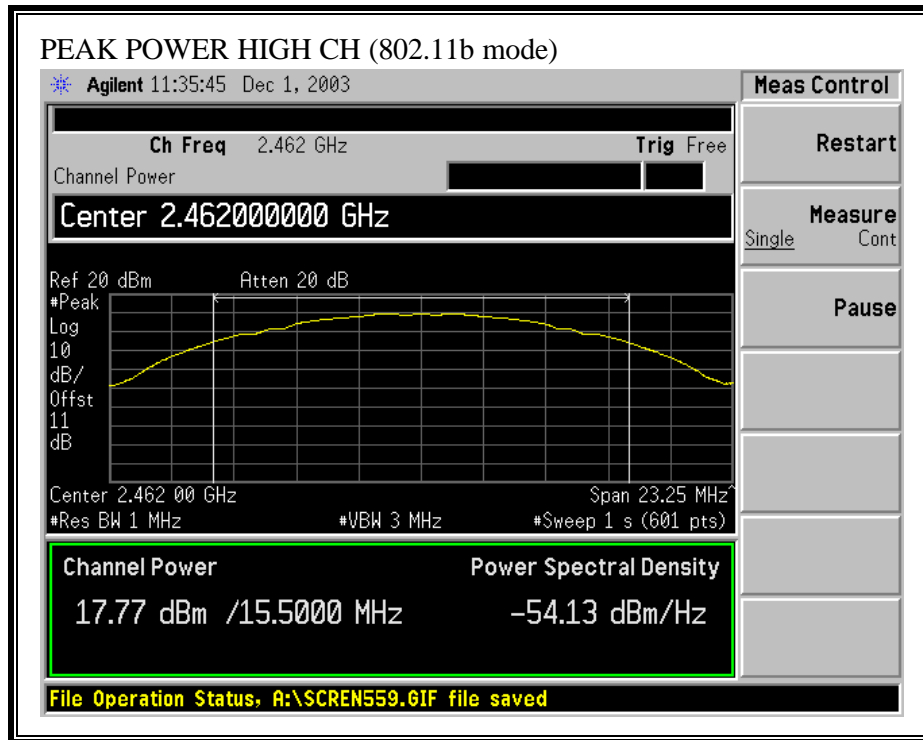

OUTPUT POWER (802.11g MODE)

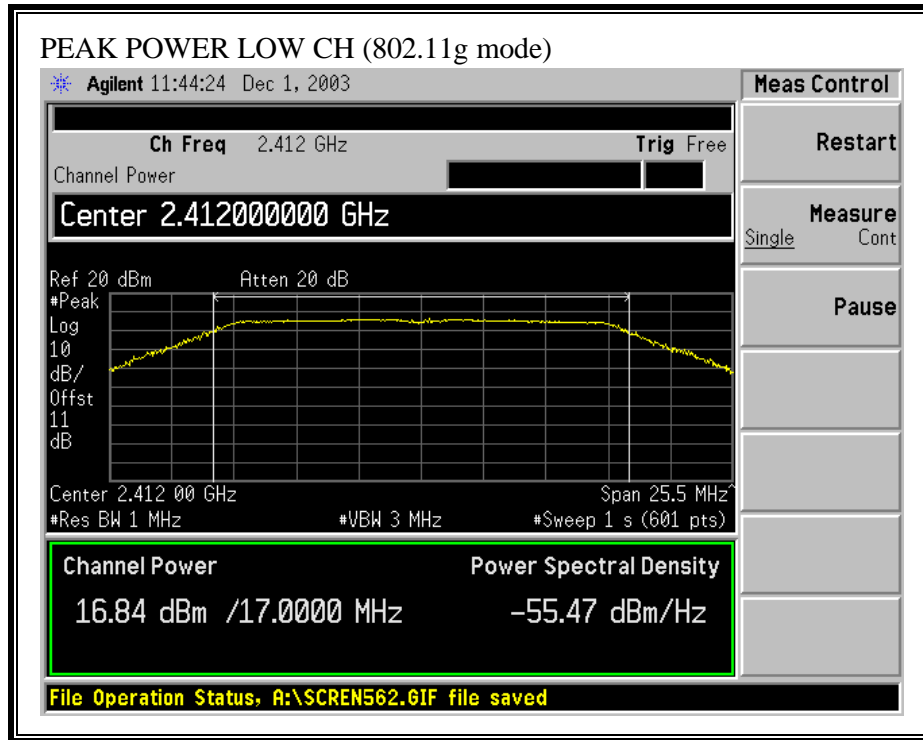

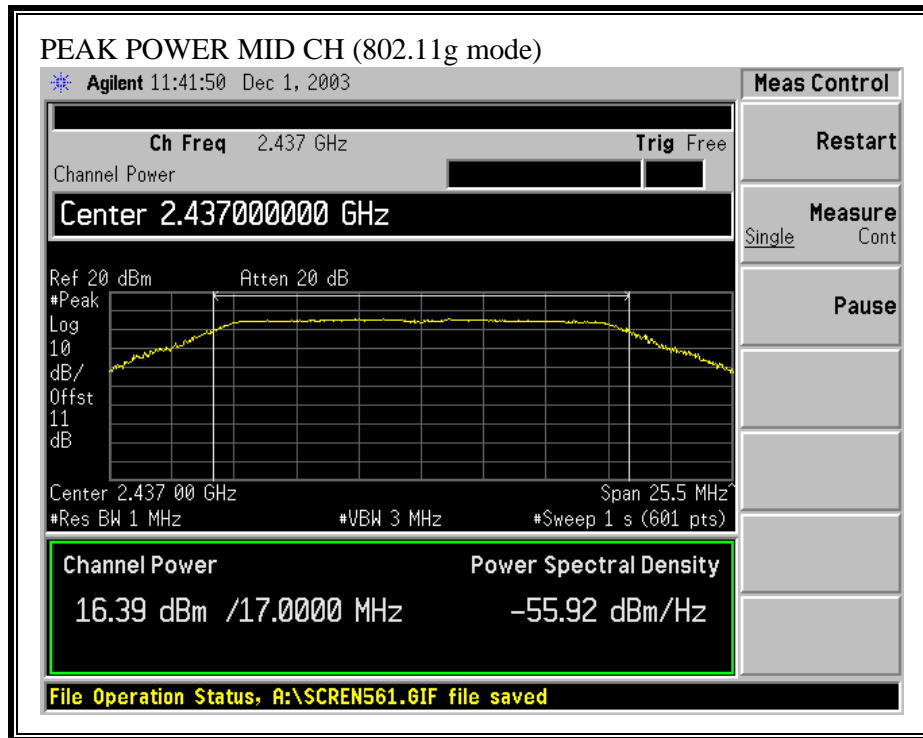

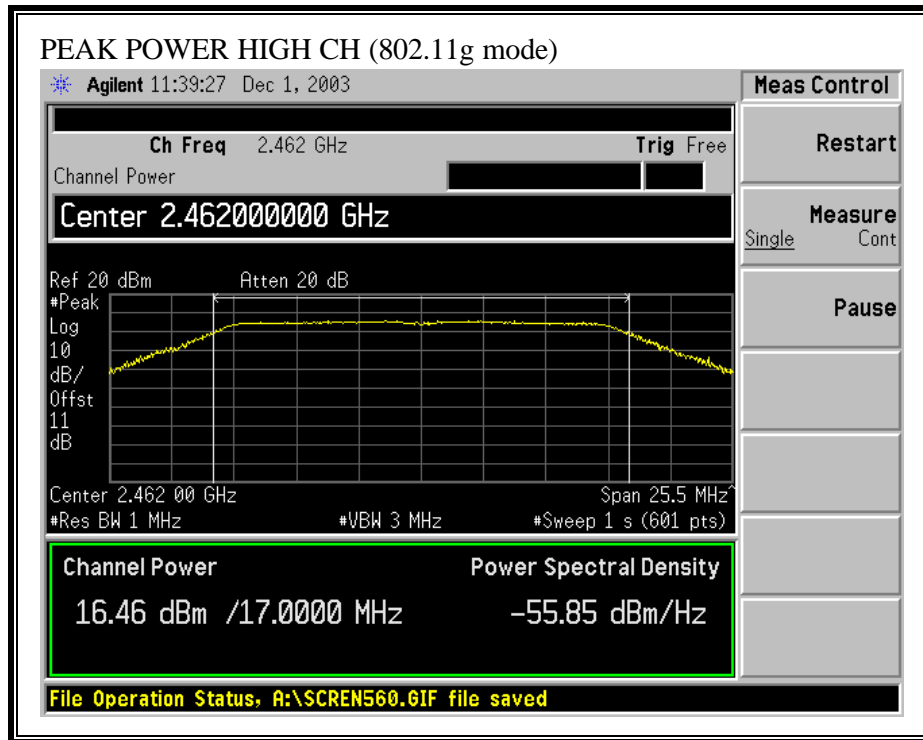

7.4. MAXIMUM PERMISSIBLE EXPOSURE

LIMITS

§1.1310 The criteria listed in Table 1 shall be used to evaluate the environmental impact of human exposure to radio-frequency (RF) radiation as specified in §1.1307(b), except in the case of portable devices which shall be evaluated according to the provisions of §2.1093 of this chapter.

TABLE 1—LIMITS FOR MAXIMUM PERMISSIBLE EXPOSURE (MPE)

Frequency range (MHz)	Electric field strength (V/m)	Magnetic field strength (A/m)	Power density (mW/cm ²)	Averaging time (minutes)
(A) Limits for Occupational/Controlled Exposures				
0.3–3.0	614	1.63	*(100)	6
3.0–30	1842/f	4.89/f	*(900/f ²)	6
30–300	61.4	0.163	1.0	6
300–1500	f/300	6
1500–100,000	5	6
(B) Limits for General Population/Uncontrolled Exposure				
0.3–1.34	614	1.63	*(100)	30
1.34–30	824/f	2.19/f	*(180/f ²)	30

TABLE 1—LIMITS FOR MAXIMUM PERMISSIBLE EXPOSURE (MPE)—Continued

Frequency range (MHz)	Electric field strength (V/m)	Magnetic field strength (A/m)	Power density (mW/cm ²)	Averaging time (minutes)
30–300	27.5	0.073	0.2	30
300–1500	f/1500	30
1500–100,000	1.0	30

f = frequency in MHz

* = Plane-wave equivalent power density

NOTE 1 TO TABLE 1: Occupational/controlled limits apply in situations in which persons are exposed as a consequence of their employment provided those persons are fully aware of the potential for exposure and can exercise control over their exposure. Limits for occupational/controlled exposure also apply in situations when an individual is transient through a location where occupational/controlled limits apply provided he or she is made aware of the potential for exposure.

NOTE 2 TO TABLE 1: General population/uncontrolled exposures apply in situations in which the general public may be exposed, or in which persons that are exposed as a consequence of their employment may not be fully aware of the potential for exposure or can not exercise control over their exposure.

CALCULATIONS

Given

$$E = \sqrt{(30 * P * G) / d}$$

and

$$S = E^2 / 3770$$

where

E = Field Strength in Volts/meter

P = Power in Watts

G = Numeric antenna gain

d = Distance in meters

S = Power Density in milliwatts/square centimeter

Combining equations and rearranging the terms to express the distance as a function of the remaining variables yields:

$$d = \sqrt{((30 * P * G) / (3770 * S))}$$

Changing to units of Power to mW and Distance to cm, using:

$$P \text{ (mW)} = P \text{ (W)} / 1000 \text{ and}$$

$$d \text{ (cm)} = 100 * d \text{ (m)}$$

yields

$$d = 100 * \sqrt{((30 * (P / 1000) * G) / (3770 * S))}$$

$$d = 0.282 * \sqrt{(P * G / S)}$$

where

d = distance in cm

P = Power in mW

G = Numeric antenna gain

S = Power Density in mW/cm²

Substituting the logarithmic form of power and gain using:

$$P \text{ (mW)} = 10^{(P \text{ (dBm)} / 10)} \text{ and}$$

$$G \text{ (numeric)} = 10^{(G \text{ (dBi)} / 10)}$$

yields

$$d = 0.282 * 10^{((P + G) / 20)} / \sqrt{S} \quad \text{Equation (1)}$$

where

d = MPE distance in cm

P = Power in dBm

G = Antenna Gain in dBi

S = Power Density Limit in mW/cm²

Equation (1) and the measured peak power is used to calculate the MPE distance.

LIMITS

From §1.1310 Table 1 (B), $S = 1.0 \text{ mW/cm}^2$

RESULTS

No non-compliance noted:

Mode	Power Density Limit (mW/cm²)	Output Power (dBm)	Antenna Gain (dBi)	MPE Distance (cm)
802.11b	1.0	17.77	2.20	2.81
802.11g	1.0	16.84	2.20	2.52

NOTE: For mobile or fixed location transmitters, the minimum separation distance is 20 cm, even if calculations indicate that the MPE distance would be less.

7.5. AVERAGE POWER

AVERAGE POWER LIMIT

None; for reporting purposes only.

TEST PROCEDURE

The transmitter output is connected to a power meter.

RESULTS

No non-compliance noted:

The cable assembly insertion loss of 11.02 dB (including 10 dB pad and 1.02 dB cable) was entered as an offset in the power meter to allow for direct reading of power.

802.11b Mode

Channel	Frequency (MHz)	Average Power (dBm)
Low	2412	14.68
Middle	2437	14.75
High	2462	14.76

802.11g Mode

Channel	Frequency (MHz)	Average Power (dBm)
Low	2412	5.90
Middle	2437	5.90
High	2462	5.70

7.6. PEAK POWER SPECTRAL DENSITY

LIMIT

§15.247 (d) For direct sequence systems, the peak power spectral density conducted from the intentional radiator to the antenna shall not be greater than 8 dBm in any 3 kHz band during any time interval of continuous transmission.

TEST PROCEDURE

The transmitter output is connected to a spectrum analyzer, the maximum level in a 3 kHz bandwidth is measured with the spectrum analyzer using RBW = 3 kHz and VBW > 3 kHz, sweep time = span / 3 kHz, and video averaging is turned off. The PPSD is the highest level found across the emission in any 3 kHz band.

RESULTS

No non-compliance noted:

802.11b Mode

Channel	Frequency (MHz)	PPSD (dBm)	Limit (dBm)	Margin (dB)
Low	2412	-7.58	8	-15.58
Middle	2437	-7.79	8	-15.79
High	2462	-7.09	8	-15.09

802.11g Mode

Channel	Frequency (MHz)	PPSD (dBm)	Limit (dBm)	Margin (dB)
Low	2412	-15.95	8	-23.95
Middle	2437	-15.45	8	-23.45
High	2462	-15.16	8	-23.16

PEAK POWER SPECTRAL DENSITY (802.11b MODE)

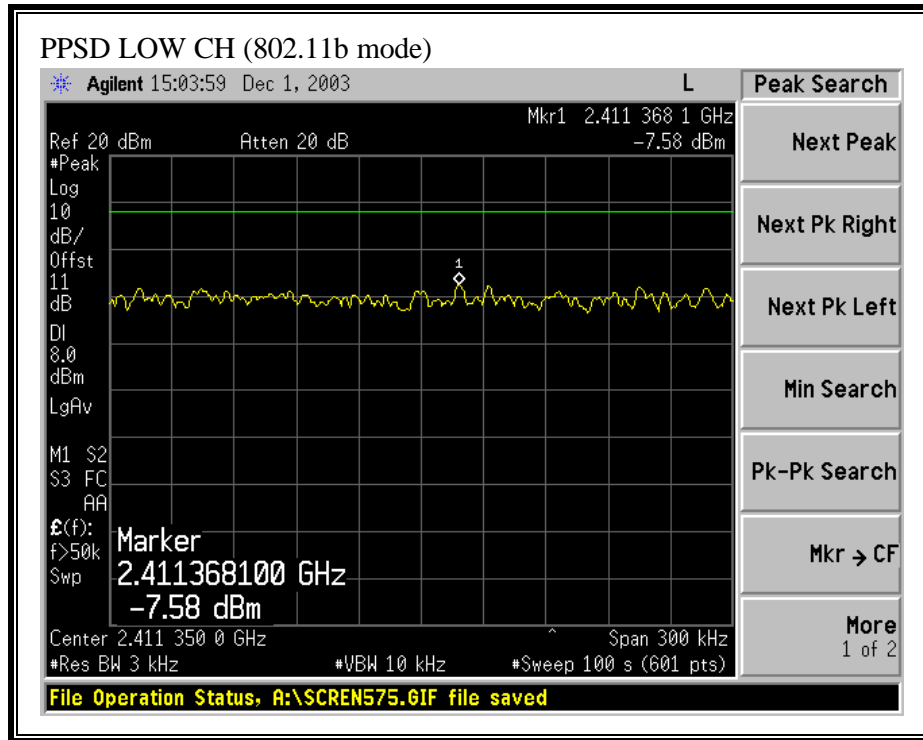

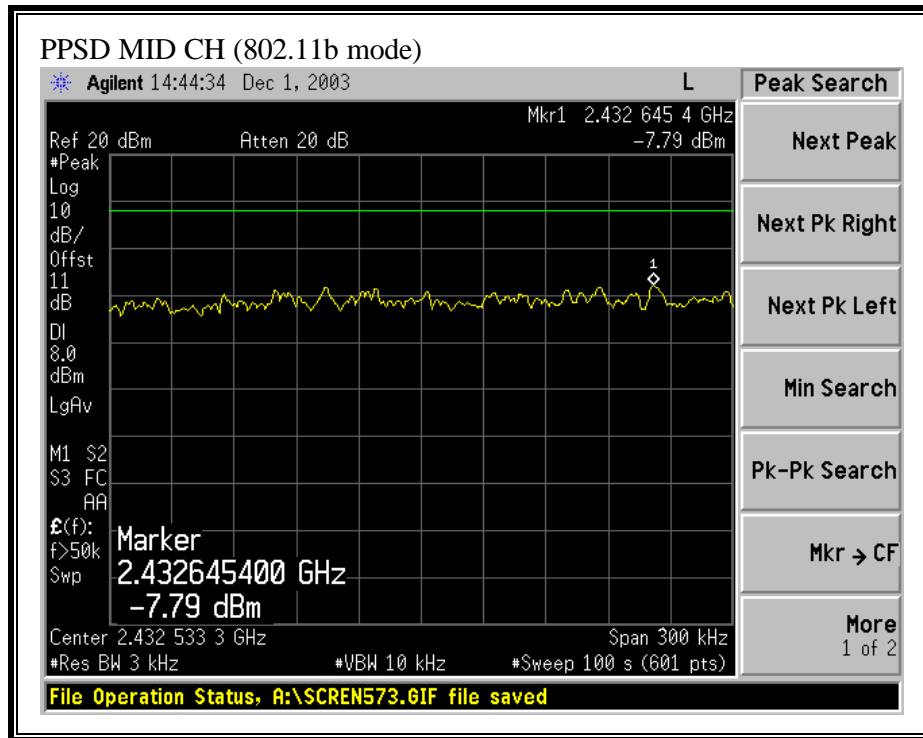

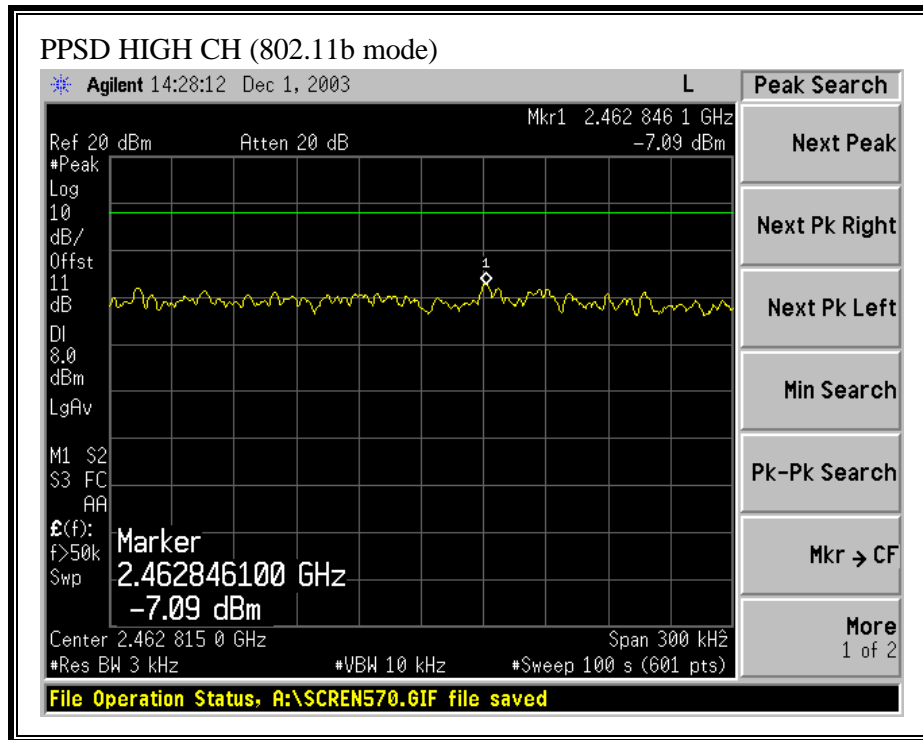

PEAK POWER SPECTRAL DENSITY (802.11g MODE)

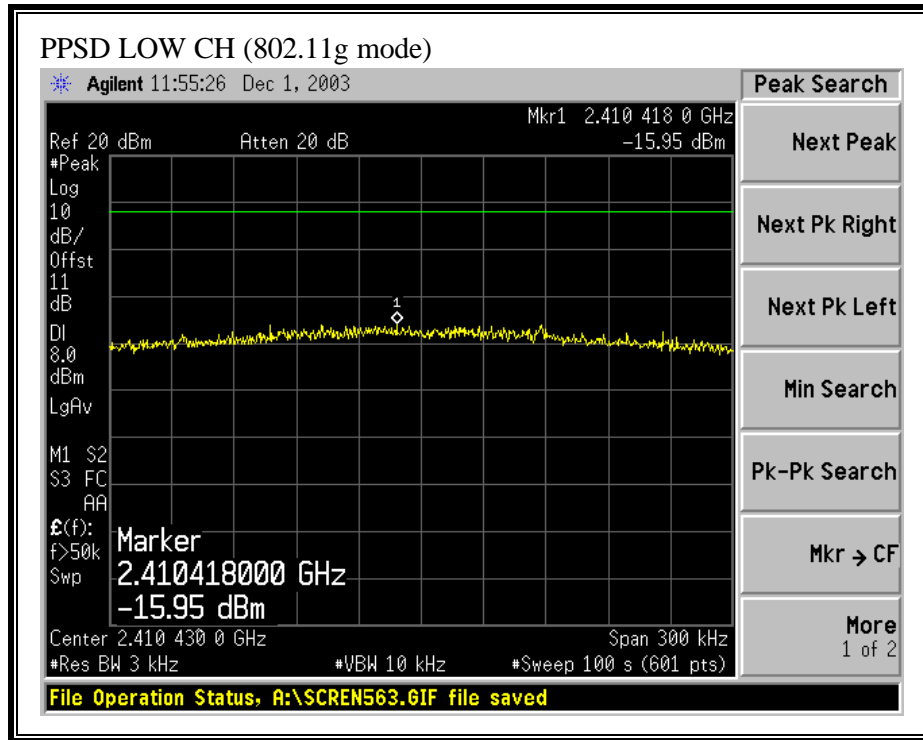

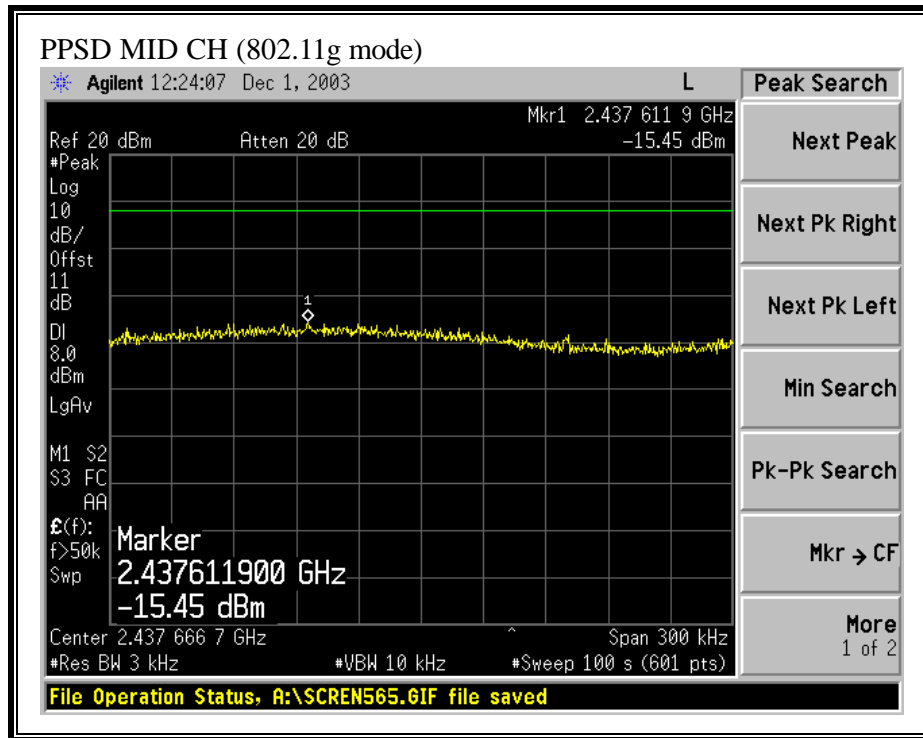

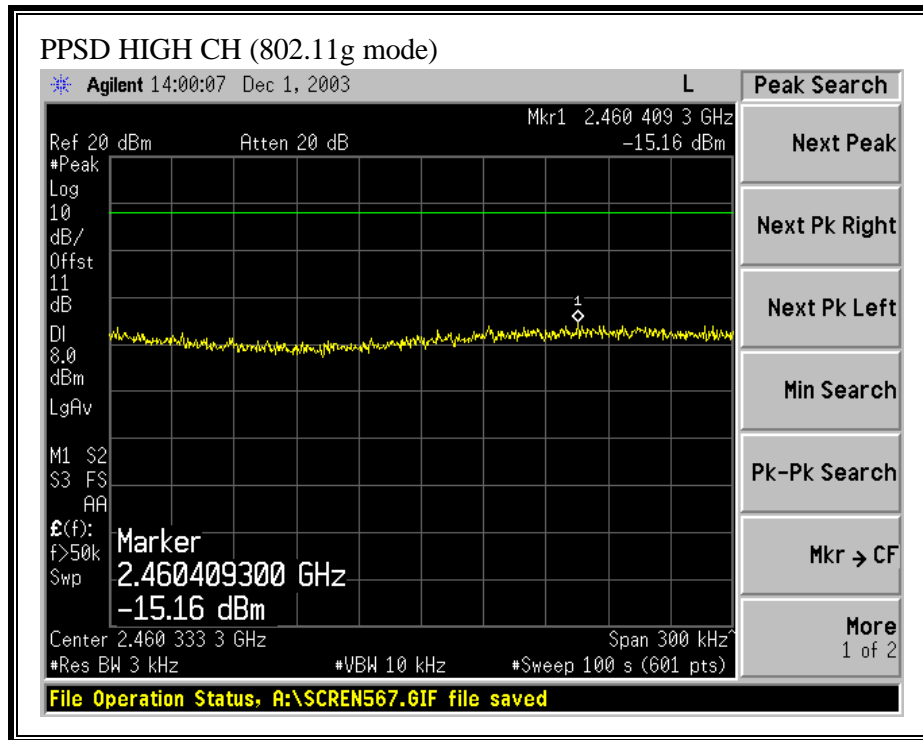

7.7. CONDUCTED SPURIOUS EMISSIONS

LIMITS

§15.247 (c) In any 100 kHz bandwidth outside the frequency band in which the spread spectrum intentional radiator is operating, the radio frequency power that is produced by the intentional radiator shall be at least 20 dB below that in the 100 kHz bandwidth within the band that contains the highest level of the desired power, based on either an RF conducted or a radiated measurement. Attenuation below the general limits specified in §15.209(a) is not required. In addition, radiated emissions which fall in the restricted bands, as defined in §15.205(a), must also comply with the radiated emission limits specified in §15.209(a) (see §15.205(c)).

TEST PROCEDURE

The transmitter output is connected to a spectrum analyzer. The resolution bandwidth is set to 100 kHz. The video bandwidth is set to 100 kHz.

The spectrum from 30 MHz to 26 GHz is investigated with the transmitter set to the lowest, middle, and highest channels.

RESULTS

No non-compliance noted:

SPURIOUS EMISSIONS, LOW CHANNEL (802.11b MODE)

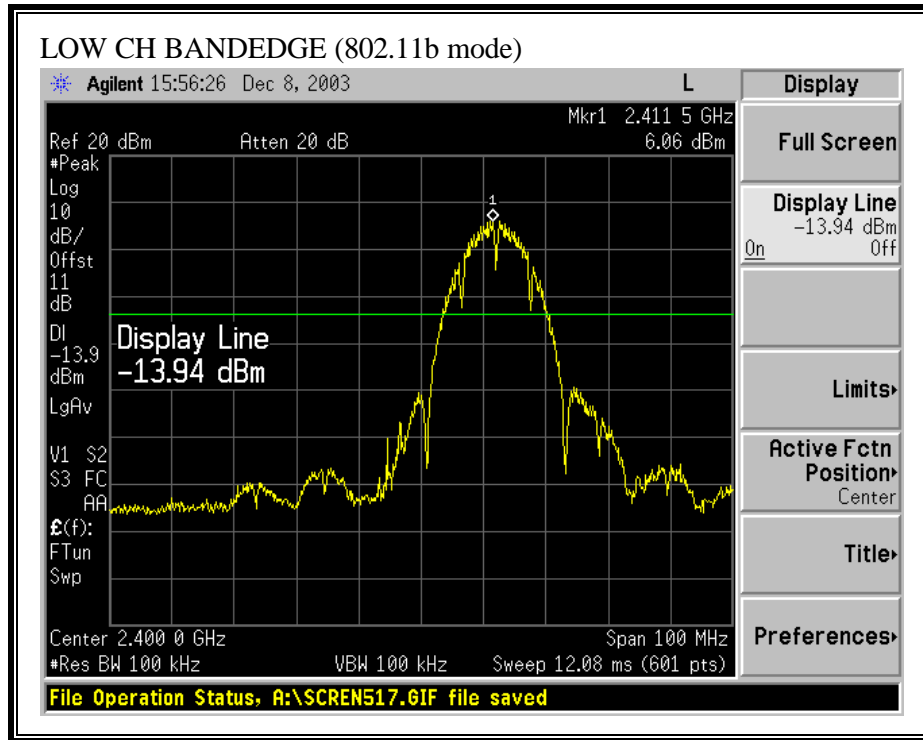

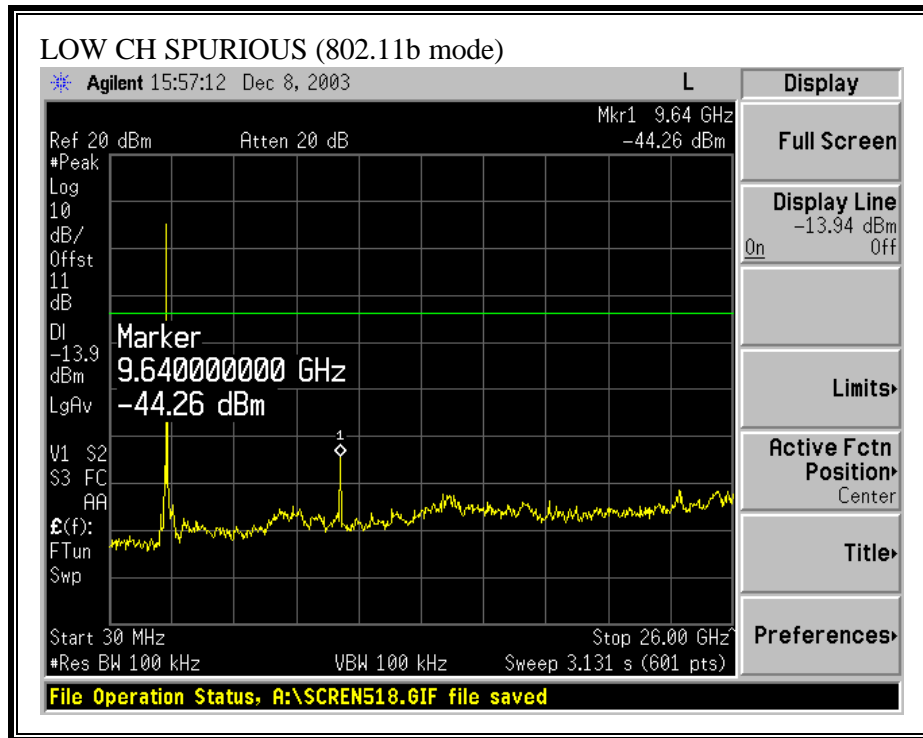

SPURIOUS EMISSIONS, MID CHANNEL (802.11b MODE)

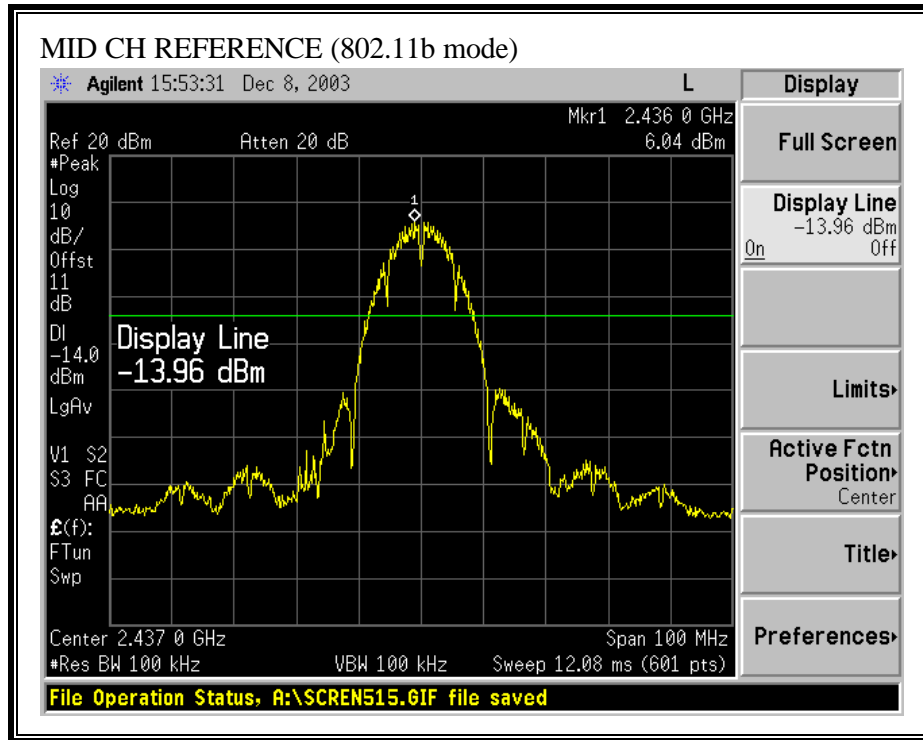

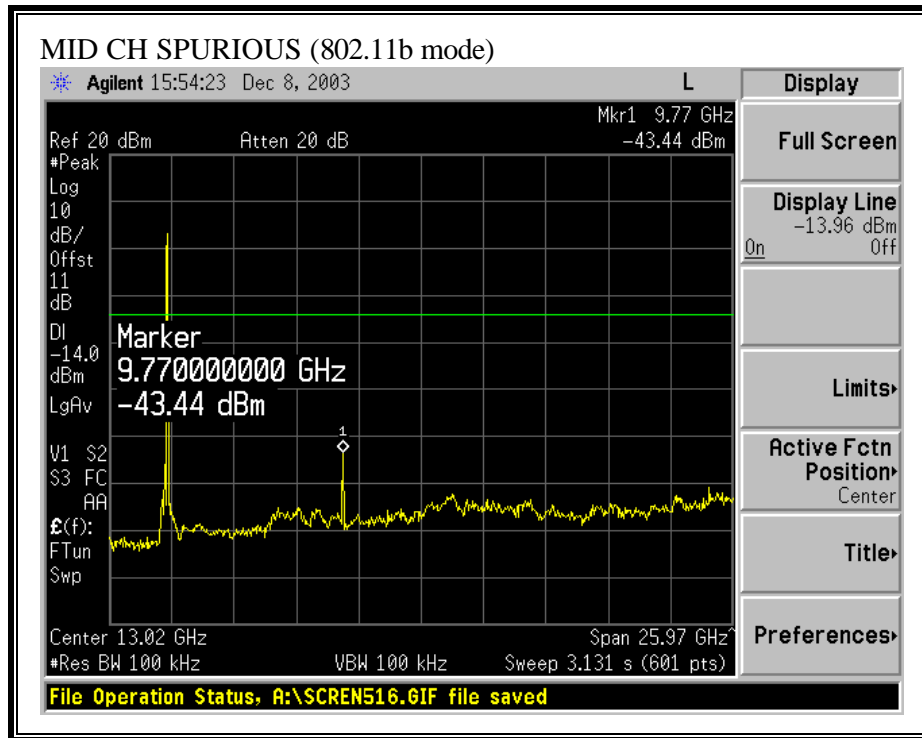

SPURIOUS EMISSIONS, HIGH CHANNEL (802.11b MODE)

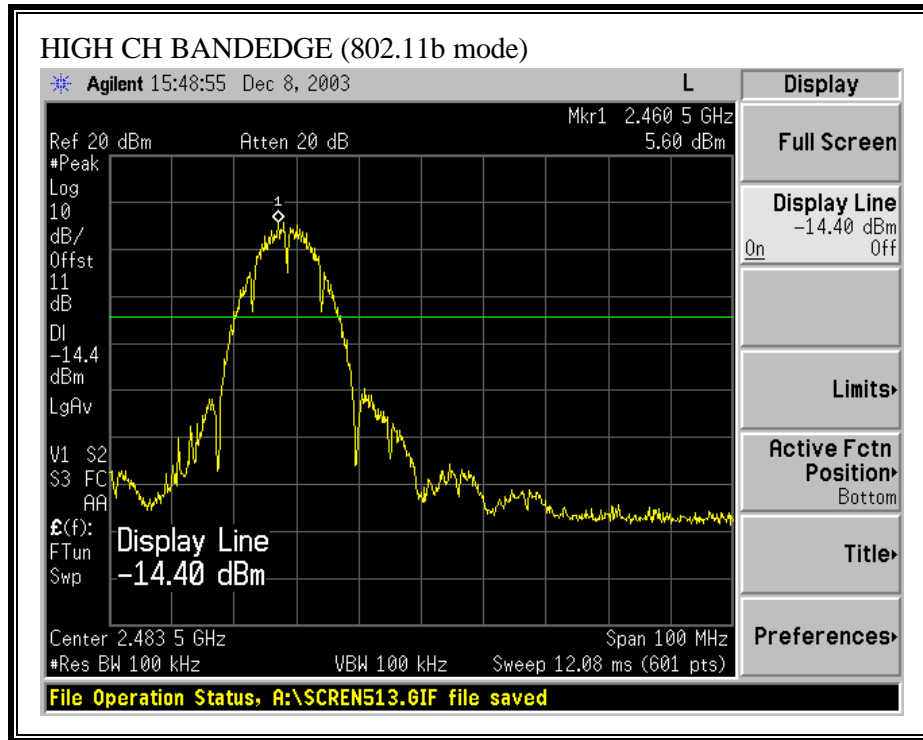

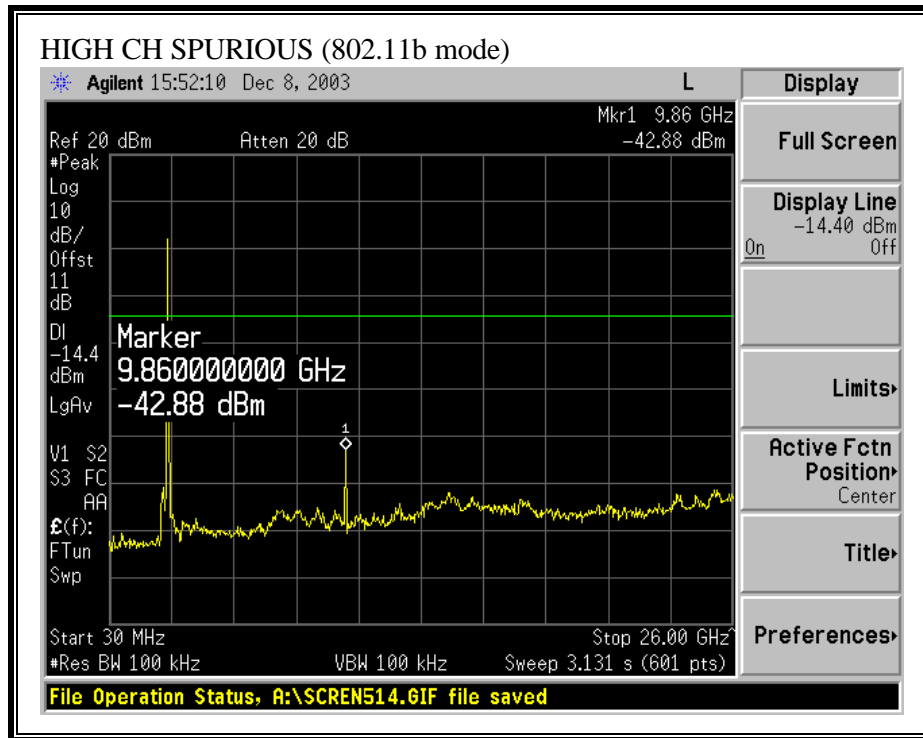

SPURIOUS EMISSIONS, LOW CHANNEL (802.11g MODE)

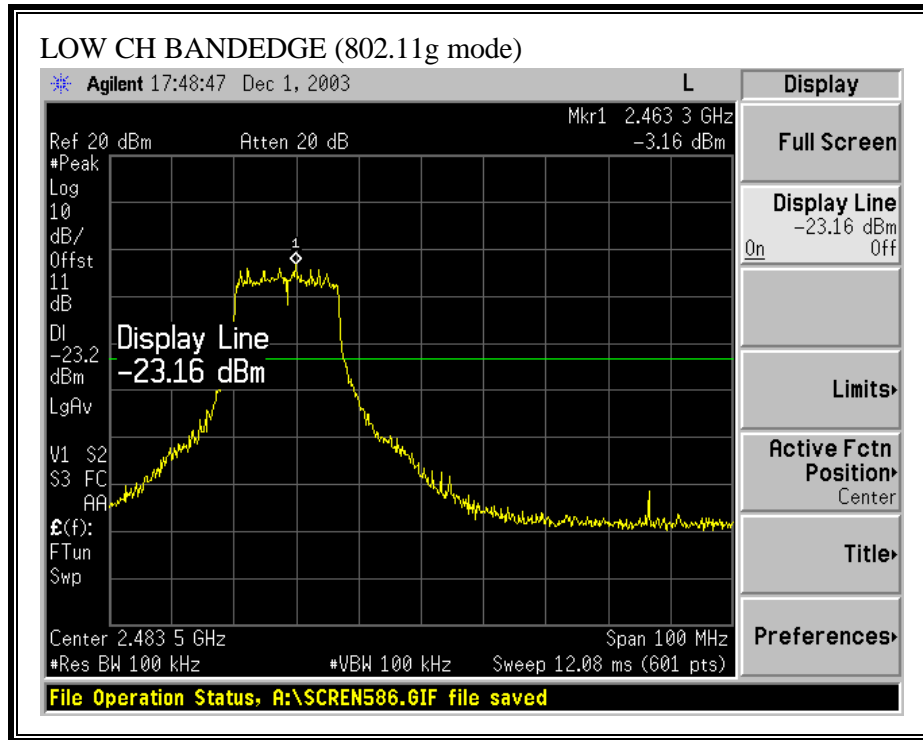

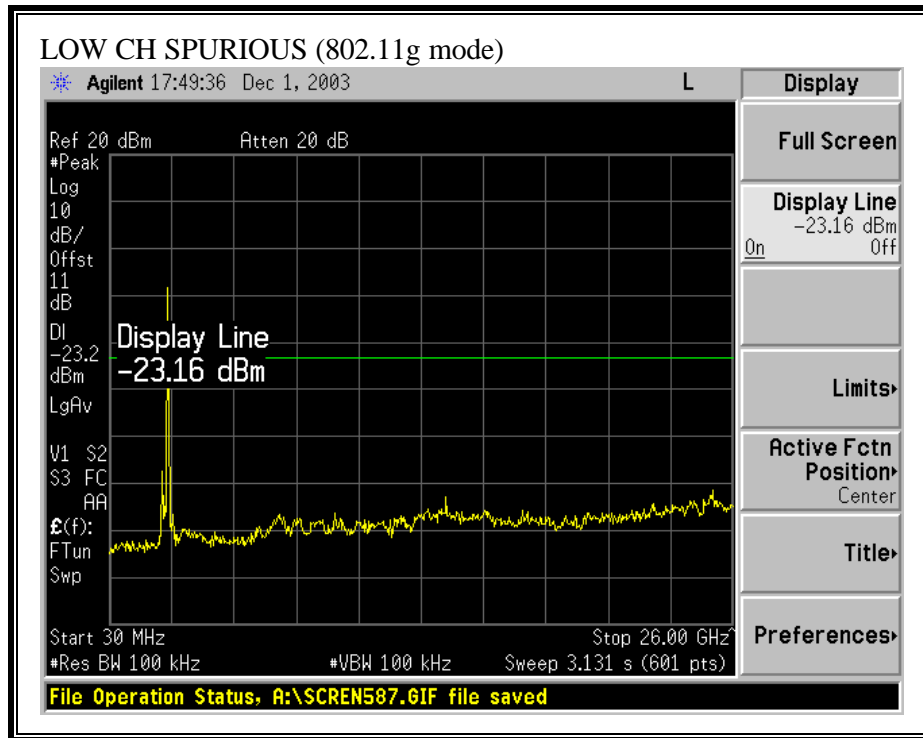

SPURIOUS EMISSIONS, MID CHANNEL (802.11g MODE)

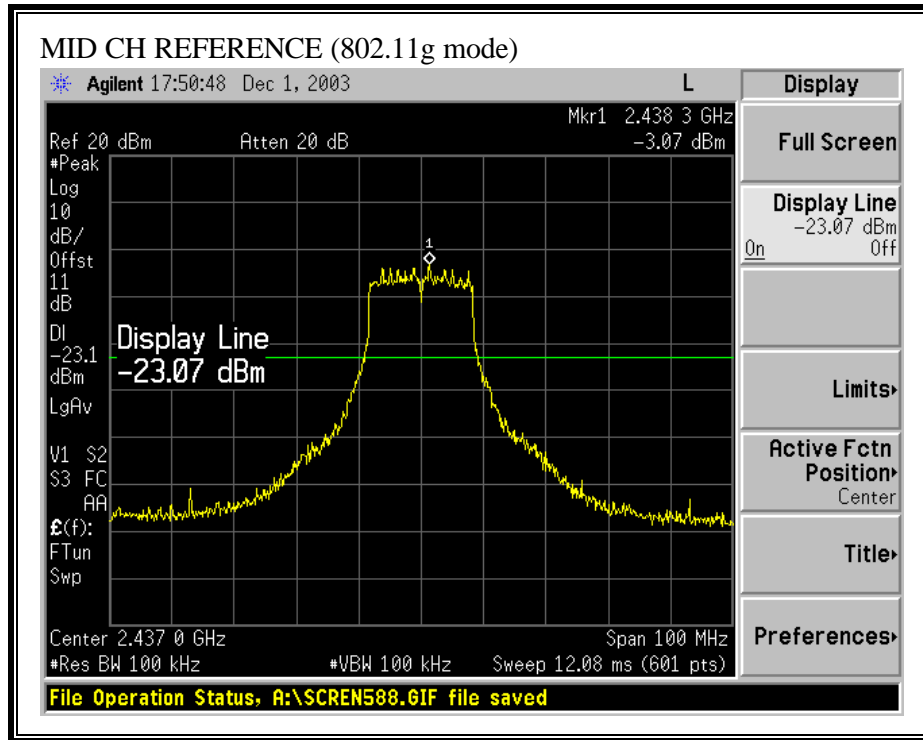

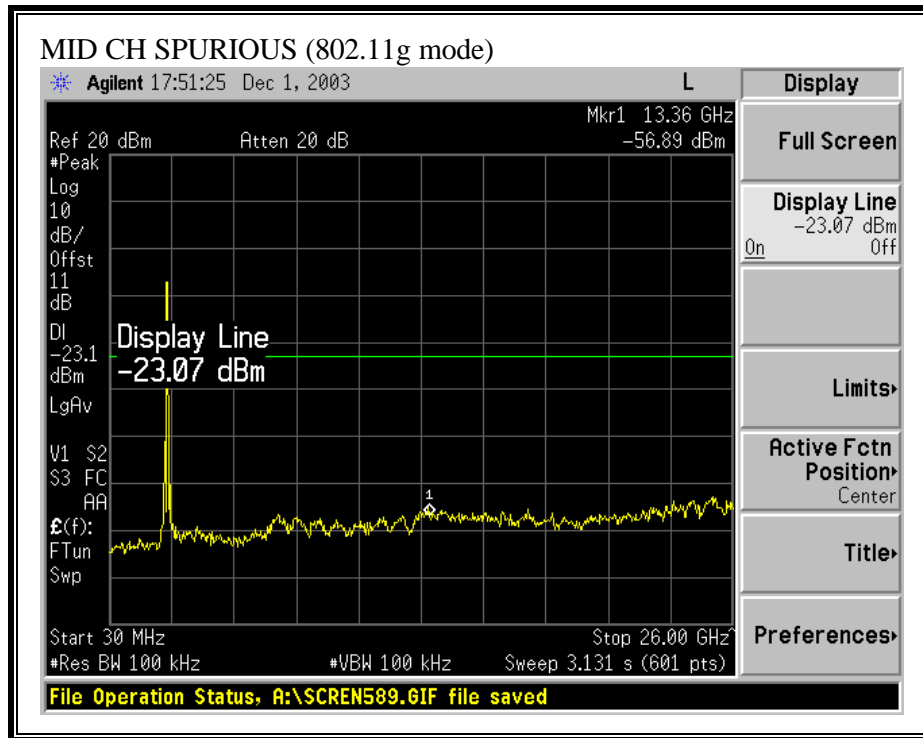

SPURIOUS EMISSIONS, HIGH CHANNEL (802.11g MODE)

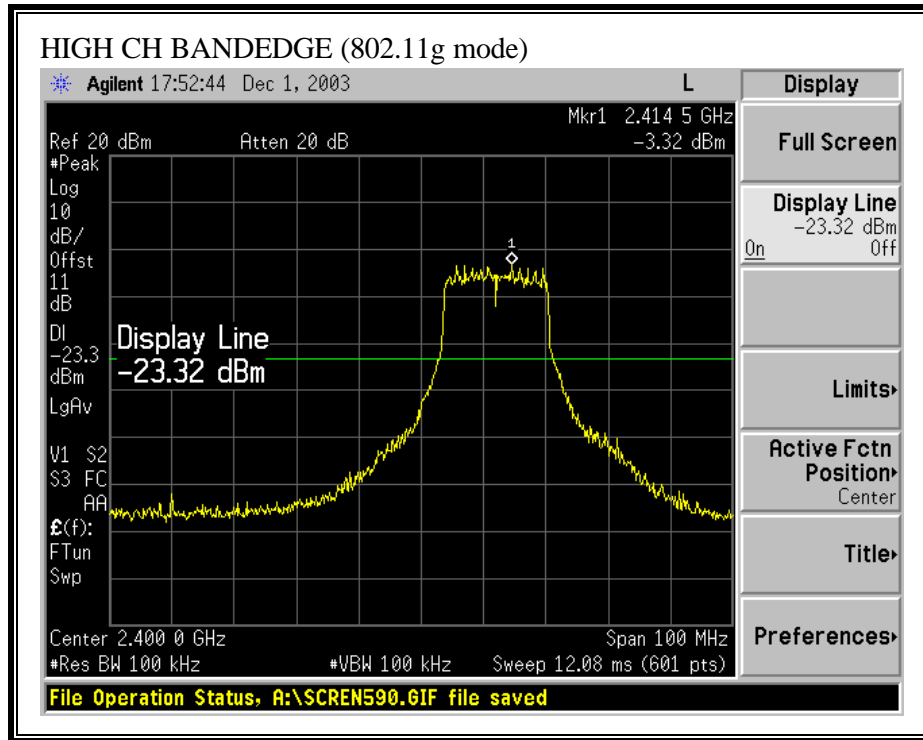

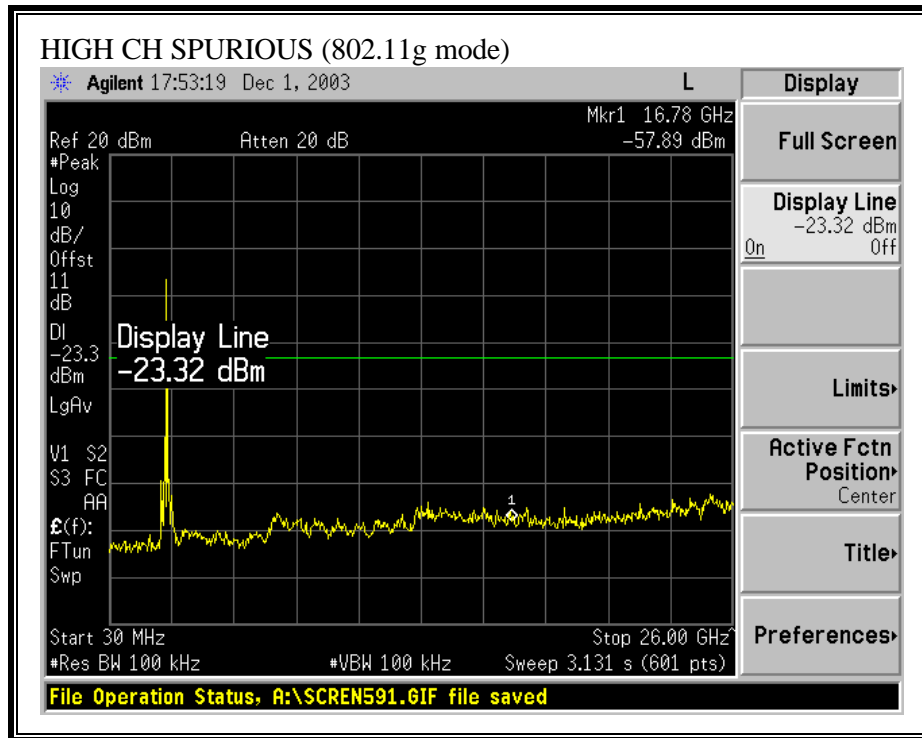

7.8. RADIATED EMISSIONS LIMITS AND PROCEDURES

7.8.1. TRANSMITTER RADIATED SPURIOUS EMISSIONS

LIMITS

§15.205 (a) Except as shown in paragraph (d) of this section, only spurious emissions are permitted in any of the frequency bands listed below:

MHz	MHz	MHz	GHz
0.090 - 0.110	16.42 - 16.423	399.9 - 410	4.5 - 5.15
¹ 0.495 - 0.505	16.69475 - 16.69525	608 - 614	5.35 - 5.46
2.1735 - 2.1905	16.80425 - 16.80475	960 - 1240	7.25 - 7.75
4.125 - 4.128	25.5 - 25.67	1300 - 1427	8.025 - 8.5
4.17725 - 4.17775	37.5 - 38.25	1435 - 1626.5	9.0 - 9.2
4.20725 - 4.20775	73 - 74.6	1645.5 - 1646.5	9.3 - 9.5
6.215 - 6.218	74.8 - 75.2	1660 - 1710	10.6 - 12.7
6.26775 - 6.26825	108 - 121.94	1718.8 - 1722.2	13.25 - 13.4
6.31175 - 6.31225	123 - 138	2200 - 2300	14.47 - 14.5
8.291 - 8.294	149.9 - 150.05	2310 - 2390	15.35 - 16.2
8.362 - 8.366	156.52475 - 156.52525	2483.5 - 2500	17.7 - 21.4
8.37625 - 8.38675	156.7 - 156.9	2655 - 2900	22.01 - 23.12
8.41425 - 8.41475	162.0125 - 167.17	3260 - 3267	23.6 - 24.0
12.29 - 12.293	167.72 - 173.2	3332 - 3339	31.2 - 31.8
12.51975 - 12.52025	240 - 285	3345.8 - 3358	36.43 - 36.5
12.57675 - 12.57725	322 - 335.4	3600 - 4400	(²)
13.36 - 13.41			

¹ Until February 1, 1999, this restricted band shall be 0.490-0.510 MHz.

² Above 38.6

§15.205 (b) Except as provided in paragraphs (d) and (e), the field strength of emissions appearing within these frequency bands shall not exceed the limits shown in Section 15.209. At frequencies equal to or less than 1000 MHz, compliance with the limits in Section 15.209 shall be demonstrated using measurement instrumentation employing a CISPR quasi-peak detector. Above 1000 MHz, compliance with the emission limits in Section 15.209 shall be demonstrated based on the average value of the measured emissions. The provisions in Section 15.35 apply to these measurements.

§15.209 (a) Except as provided elsewhere in this Subpart, the emissions from an intentional radiator shall not exceed the field strength levels specified in the following table:

Frequency (MHz)	Field Strength (microvolts/meter)	Measurement Distance (meters)
30 - 88	100 **	3
88 - 216	150 **	3
216 - 960	200 **	3
Above 960	500	3

** Except as provided in paragraph (g), fundamental emissions from intentional radiators operating under this Section shall not be located in the frequency bands 54-72 MHz, 76-88 MHz, 174-216 MHz or 470-806 MHz. However, operation within these frequency bands is permitted under other sections of this Part, e.g., Sections 15.231 and 15.241.

§15.209 (b) In the emission table above, the tighter limit applies at the band edges.

TEST PROCEDURE

The EUT is placed on a non-conducting table 80 cm above the ground plane. The antenna to EUT distance is 3 meters. The EUT is configured in accordance with ANSI C63.4. The EUT is set to transmit in a continuous mode.

For measurements below 1 GHz the resolution bandwidth is set to 100 kHz for peak detection measurements or 120 kHz for quasi-peak detection measurements. Peak detection is used unless otherwise noted as quasi-peak.

For measurements above 1 GHz the resolution bandwidth is set to 1 MHz, then the video bandwidth is set to 1 MHz for peak measurements and 10 Hz for average measurements.

The spectrum from 30 MHz to 26 GHz is investigated with the transmitter set to the lowest, middle, and highest channels.

The frequency range of interest is monitored at a fixed antenna height and EUT azimuth. The EUT is rotated through 360 degrees to maximize emissions received. The antenna is scanned from 1 to 4 meters above the ground plane to further maximize the emission. Measurements are made with the antenna polarized in both the vertical and the horizontal positions.

The configuration and orientation of the EUT was varied to determine the worst-case. The EUT was first configured as a typical laptop notebook PC resting on the turntable in a normal operating condition. It was then configured as a tablet PC and evaluated in X, Y and Z orientations. Worst-case results are reported.

7.8.2. CO-LOCATED TRANSMITTER RADIATED EMISSIONS

SUPPLEMENTAL TEST PROCEDURE

The EUT is placed on a non-conducting table 80 cm above the ground plane. The antenna The dominant transmitter is set to the worst case channel. The spurious emissions performance of the dominant transmitter is investigated as the settings of the non-dominant transmitter are varied. Worst case results are reported.

7.9. RADIATED EMISSIONS RESULTS WITH HTL017 ANTENNA

7.9.1. TRANSMITTER RADIATED EMISSIONS ABOVE 1 GHZ

RESULTS

The worst-case condition was observed with the EUT in the laptop configuration. No non-compliance noted:

RESTRICTED BANDEDGE (b MODE, LOW CHANNEL, HORIZONTAL)

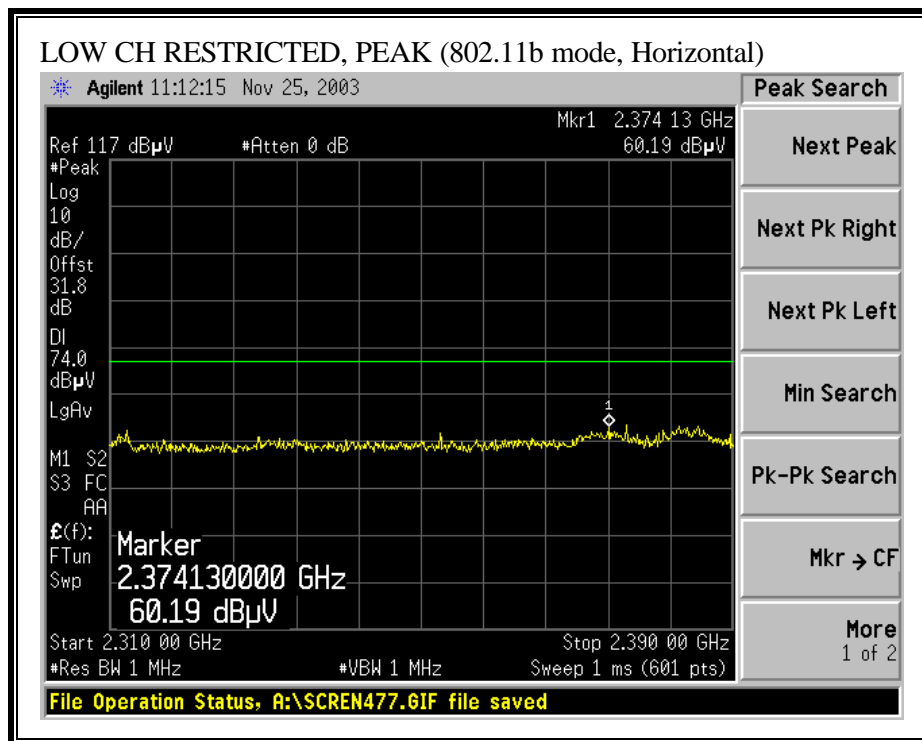

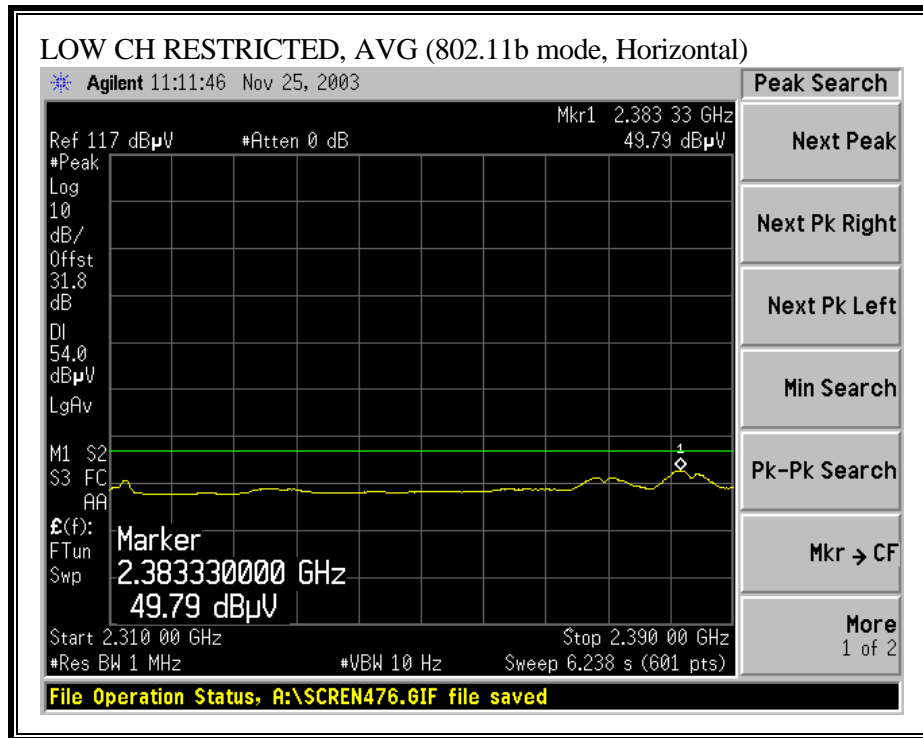

RESTRICTED BANDEDGE (b MODE, LOW CHANNEL, VERTICAL)

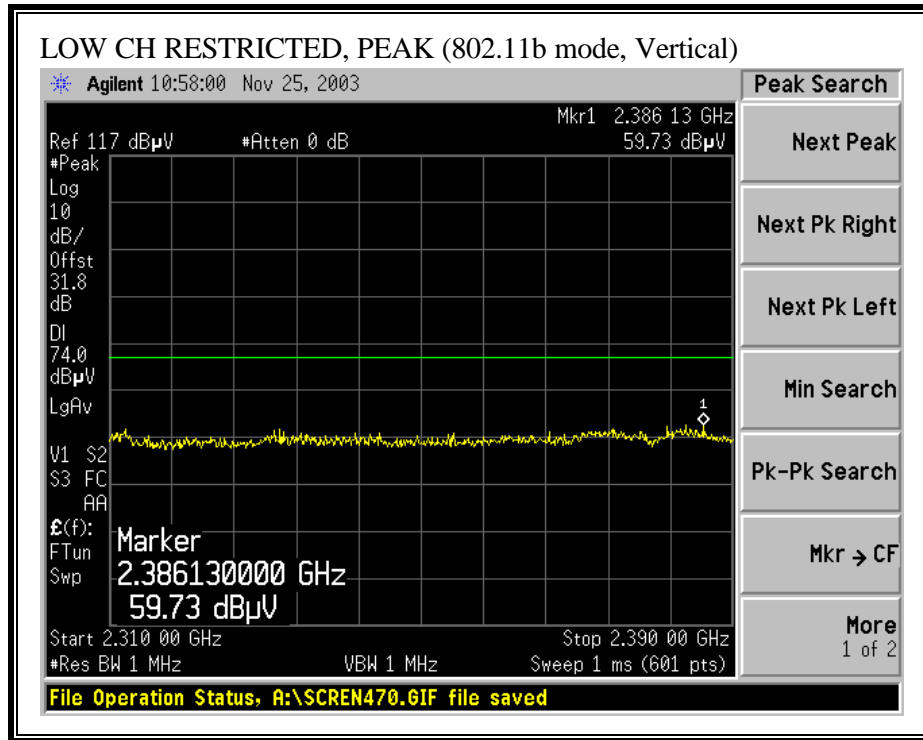

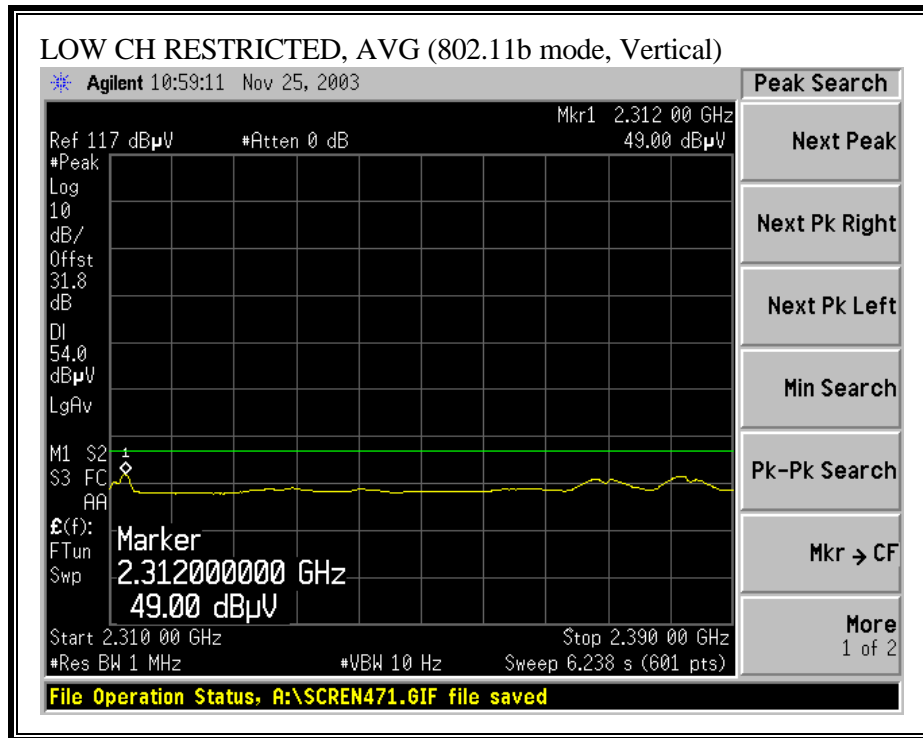

RESTRICTED BANDEDGE (b MODE, HIGH CHANNEL, HORIZONTAL)

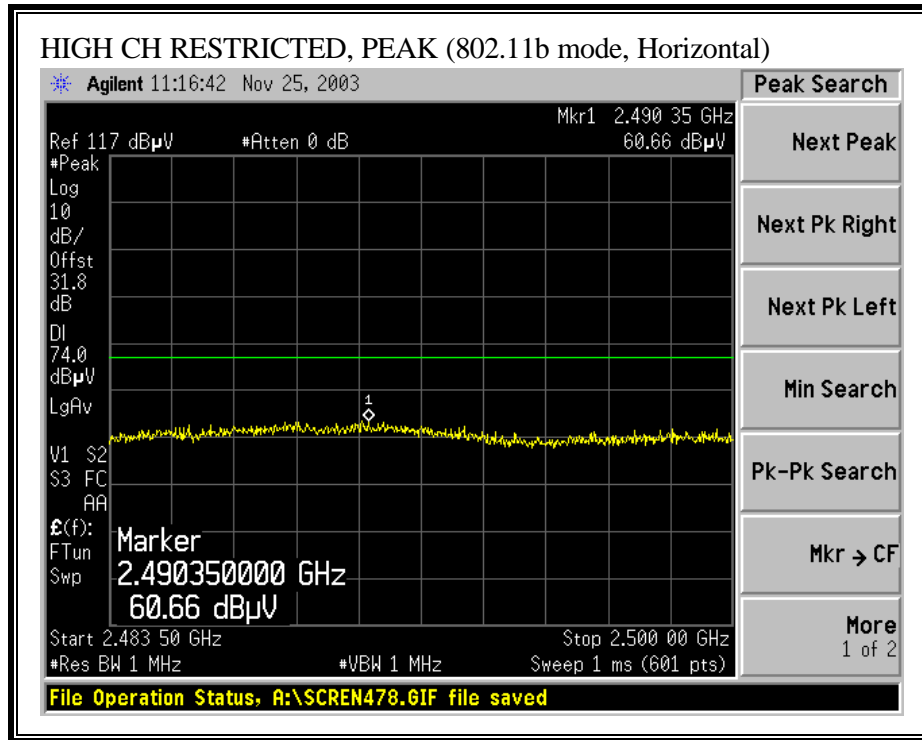

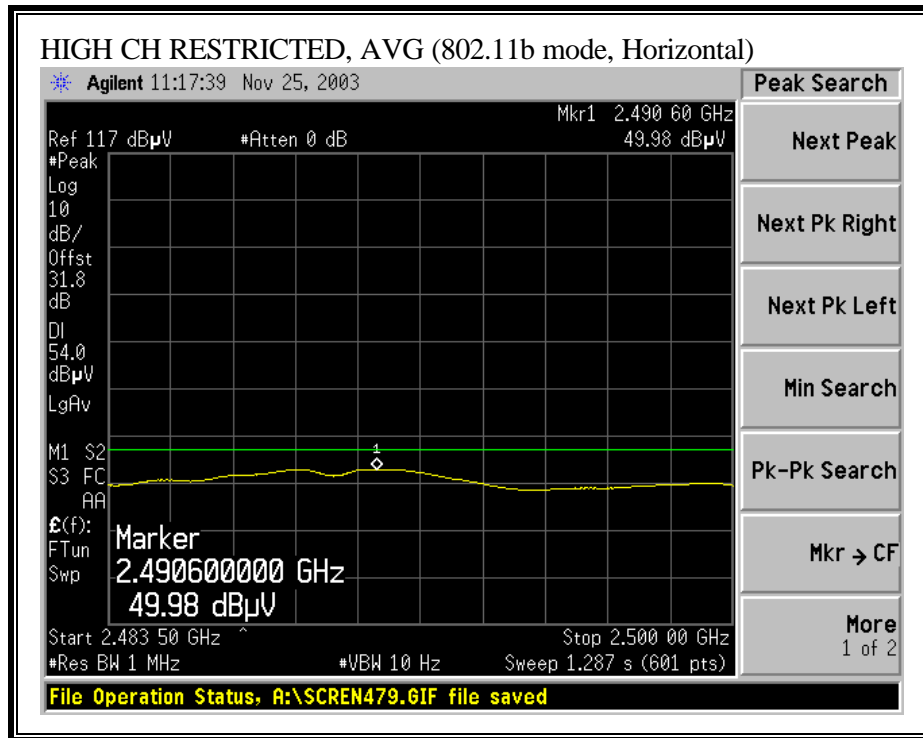

RESTRICTED BANDEDGE (b MODE, HIGH CHANNEL, VERTICAL)

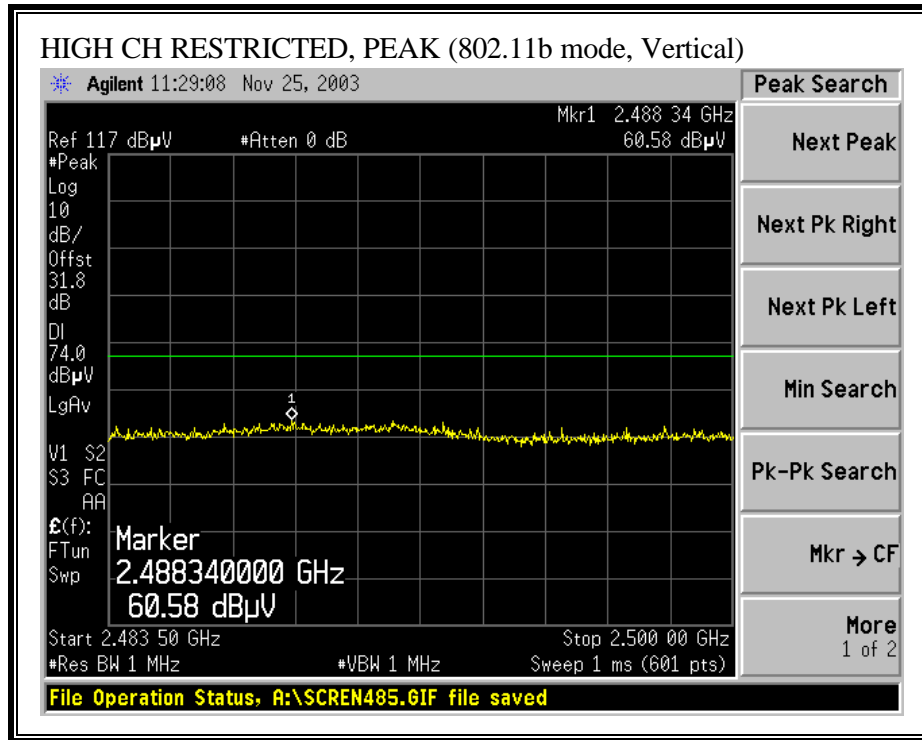

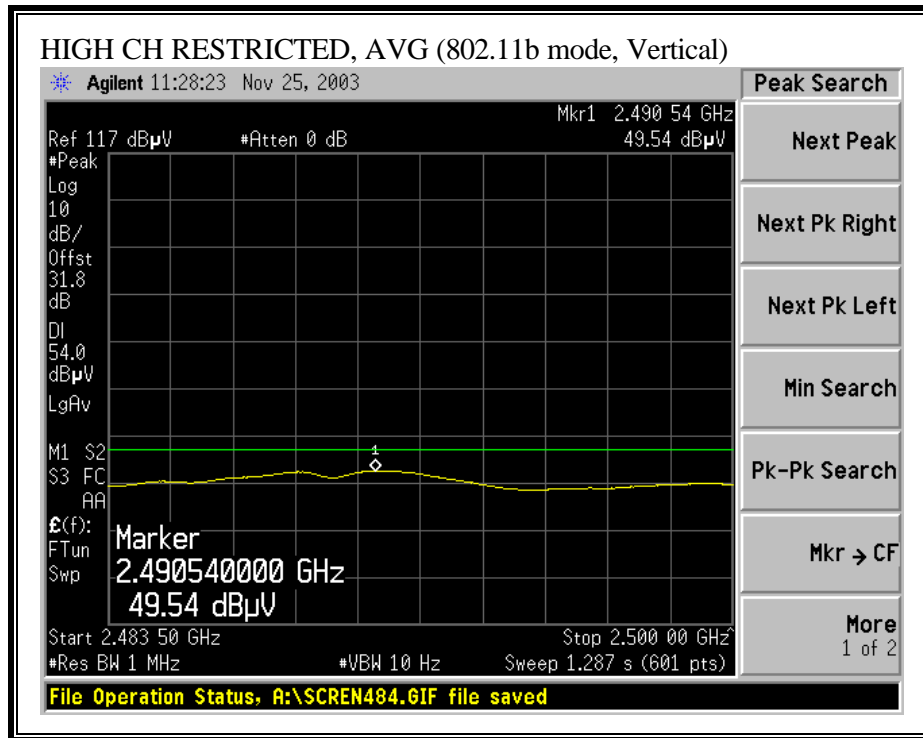

HARMONICS AND SPURIOUS EMISSIONS (b MODE)

11/25/03 High Frequency Measurement																
Compliance Certification Services, Morgan Hill Open Field Site																
Test Engr:		Yan Zheng														
Project #:		03U2392														
Company:		Intel														
EUT Descrip.:		802.11b/g card with Toshiba notebook, with antenna HTL017														
EUT M/N:		M200														
Test Target:		FCC Class B														
Mode Oper:		Transmitt, b mode														
Test Equipment:																
EMCO Hm 1-18GHz				Pre-amplifier 1-26GHz				Spectrum Analyzer				Horn > 18GHz				
T60; S/N: 2238 @ 3m				T63 Mitco 646456				Agilent E4446A Analyzer				T117; ARA 18-26GHz; S/N:1013				
Hi Frequency Cables:																
<input type="checkbox"/> (2 ft) <input checked="" type="checkbox"/> (2 ~ 3 ft) <input type="checkbox"/> (4 ~ 6 ft) <input checked="" type="checkbox"/> (12 ft)																
Peak Measurements:																
1 MHz Resolution Bandwidth																
1 MHz Video Bandwidth																
Average Measurements:																
1 MHz Resolution Bandwidth																
10 Hz Video Bandwidth																
f	Dist	Read Pk	Read Avg.	AF	CL	Amp	D Corr	HPF	Peak	Avg	Pk Lim	Avg Lim	Pk Mar	Avg Mar	Notes	
GHz	feet	dBuV	dBuV	dB/m	dB	dB	dB		dBuV/m	dBuV/m	dBuV/m	dBuV/m	dB	dB		
Channe 1 (2412MHz)																
4824	98	46.1	37.2	33.1	44	-35.3	0.0	1.0	49.3	40.4	74.0	54.0	-24.7	-13.6	V	
4824	98	46.0	35.5	33.1	44	-35.3	0.0	1.0	49.2	38.7	74.0	54.0	-24.8	-15.3	H	
Channe 6 (2437MHz)																
4874	98	44.5	32.6	33.1	44	-35.3	0.0	1.0	47.7	35.8	74.0	54.0	-26.3	-18.2	V	
7311	98	43.4	31.3	36.2	57	-34.6	0.0	1.0	51.7	39.6	74.0	54.0	-22.3	-14.4	V	
4874	98	44.4	32.9	33.1	44	-35.3	0.0	1.0	47.6	36.1	74.0	54.0	-26.4	-17.9	H	
7311	98	43.2	31.4	36.2	57	-34.6	0.0	1.0	51.5	39.7	74.0	54.0	-22.5	-14.3	H	
Channe 11 (2462MHz)																
4924	98	46.7	34.1	33.2	45	-35.3	0.0	1.0	50.0	37.4	74.0	54.0	-24.0	-16.6	V	
7386	98	44.8	31.1	36.3	57	-34.5	0.0	1.0	53.3	39.6	74.0	54.0	-20.7	-14.4	V	
4924	98	45.8	33.3	33.2	45	-35.3	0.0	1.0	49.1	36.6	74.0	54.0	-24.9	-17.4	H	
7386	98	44.5	31.0	36.3	57	-34.5	0.0	1.0	53.0	39.5	74.0	54.0	-21.0	-14.5	H	
NO RADIATION EMISSION FOUND ABOVE 75GHz																
f Measurement Frequency Amp Preamp Gain Avg Lim Average Field Strength Limit Dist Distance to Antenna D Corr Distance Correct to 3 meters Pk Lim Peak Field Strength Limit Read Analyzer Reading Avg Average Field Strength @ 3 m Avg Mar Margin vs. Average Limit AF Antenna Factor Peak Calculated Peak Field Strength Pk Mar Margin vs. Peak Limit CL Cable Loss HPF High Pass Filter																

RESTRICTED BANDEDGE (g MODE, LOW CHANNEL, HORIZONTAL)

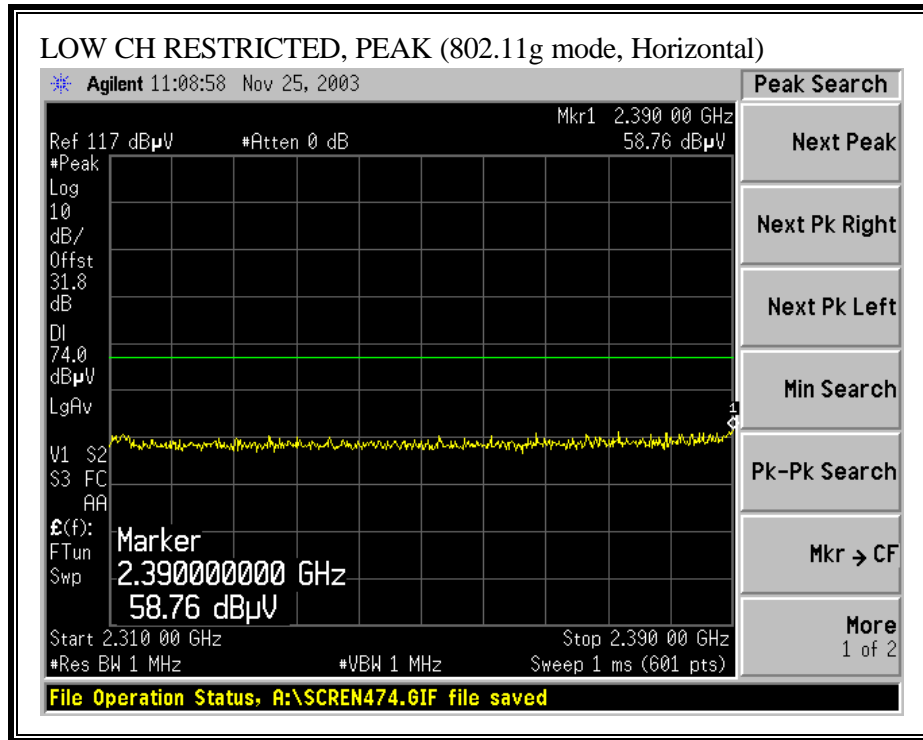

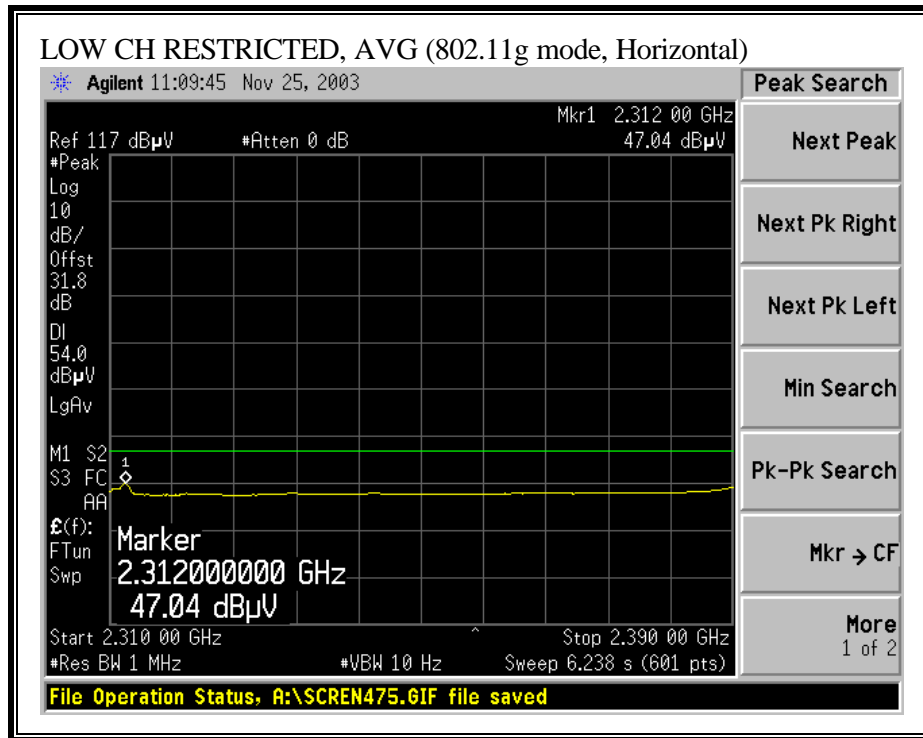

RESTRICTED BANDEDGE (g MODE, LOW CHANNEL, VERTICAL)

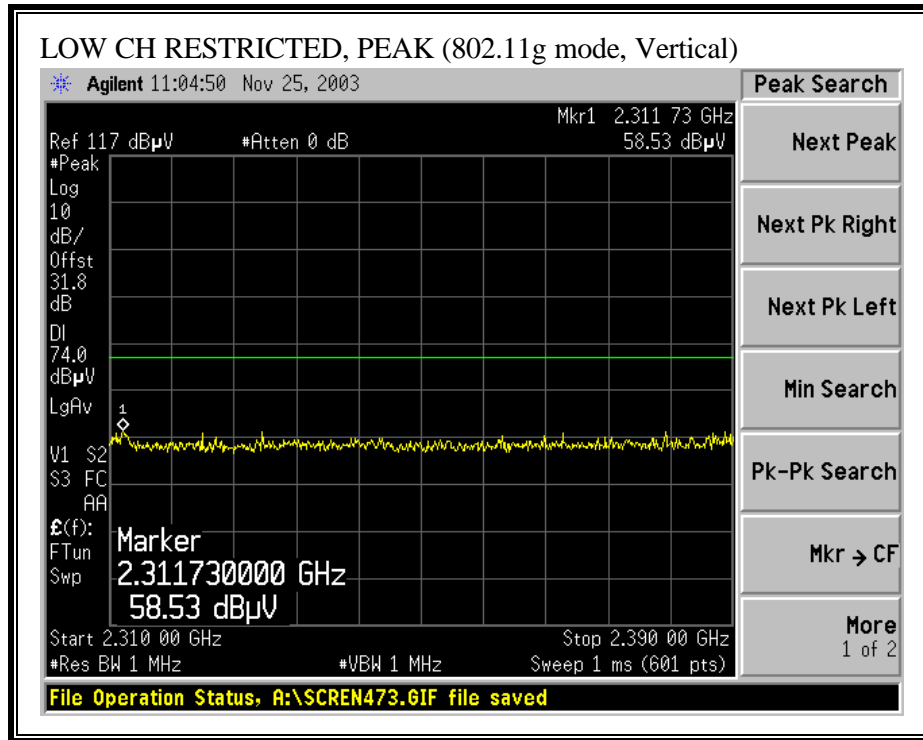

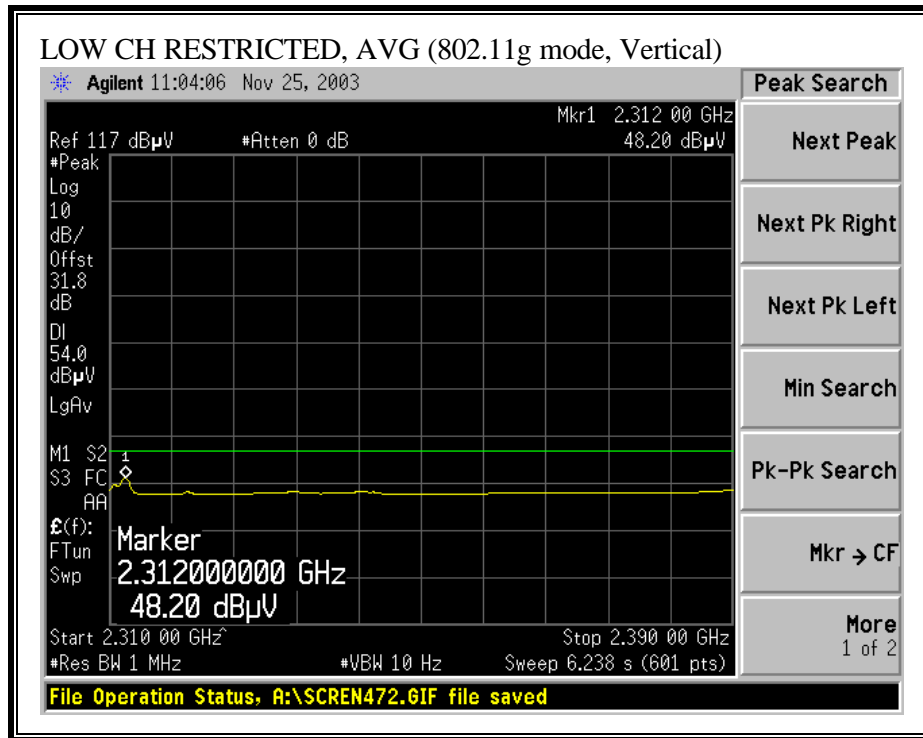

RESTRICTED BANDEDGE (g MODE, HIGH CHANNEL, HORIZONTAL)

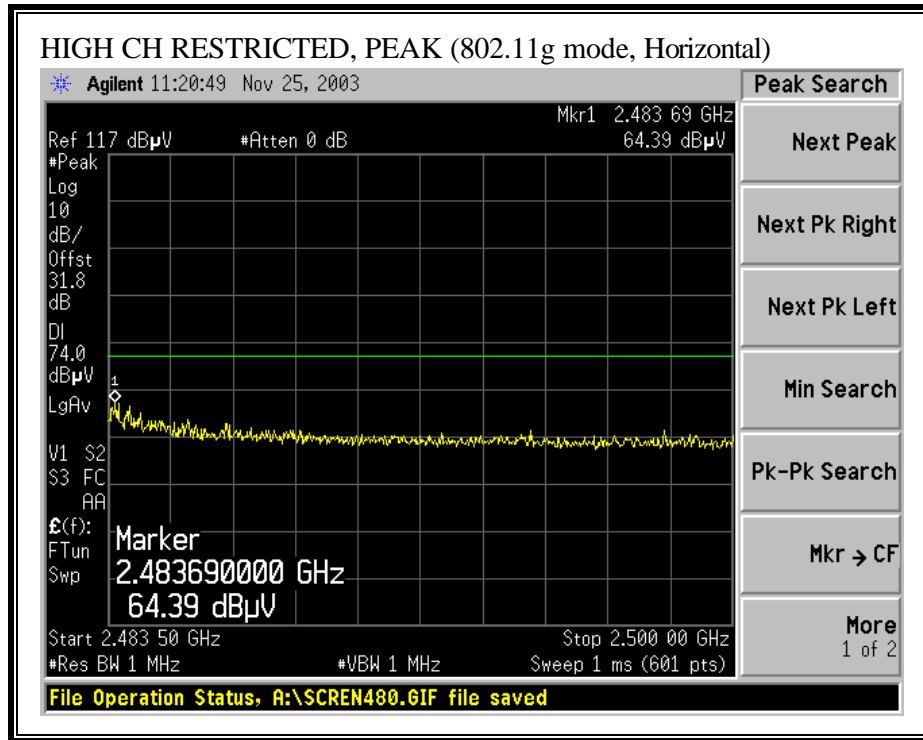

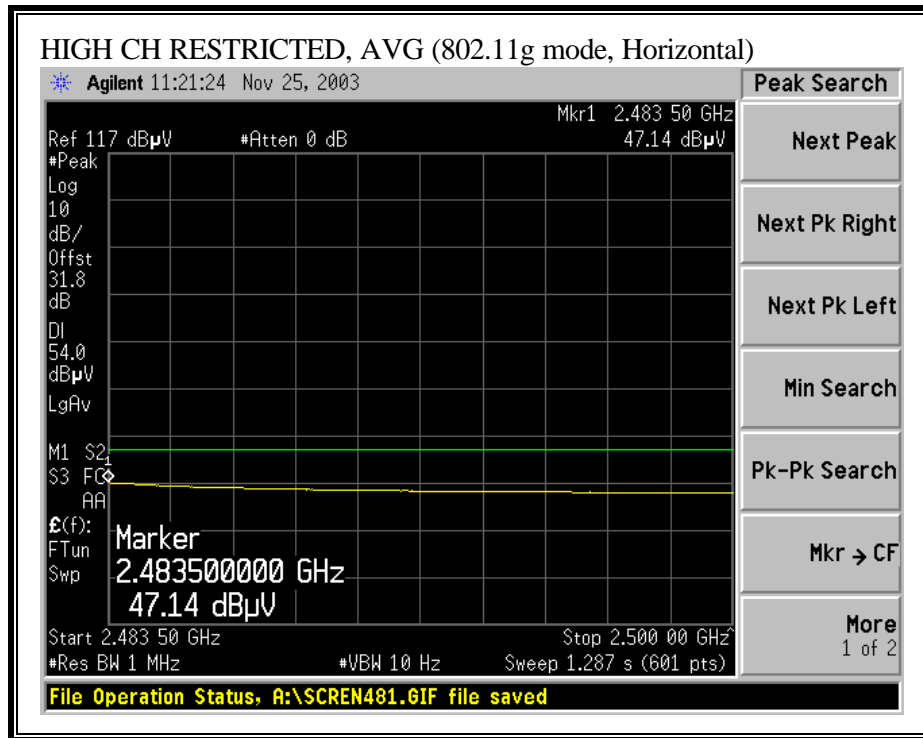

RESTRICTED BANDEDGE (g MODE, HIGH CHANNEL, VERTICAL)

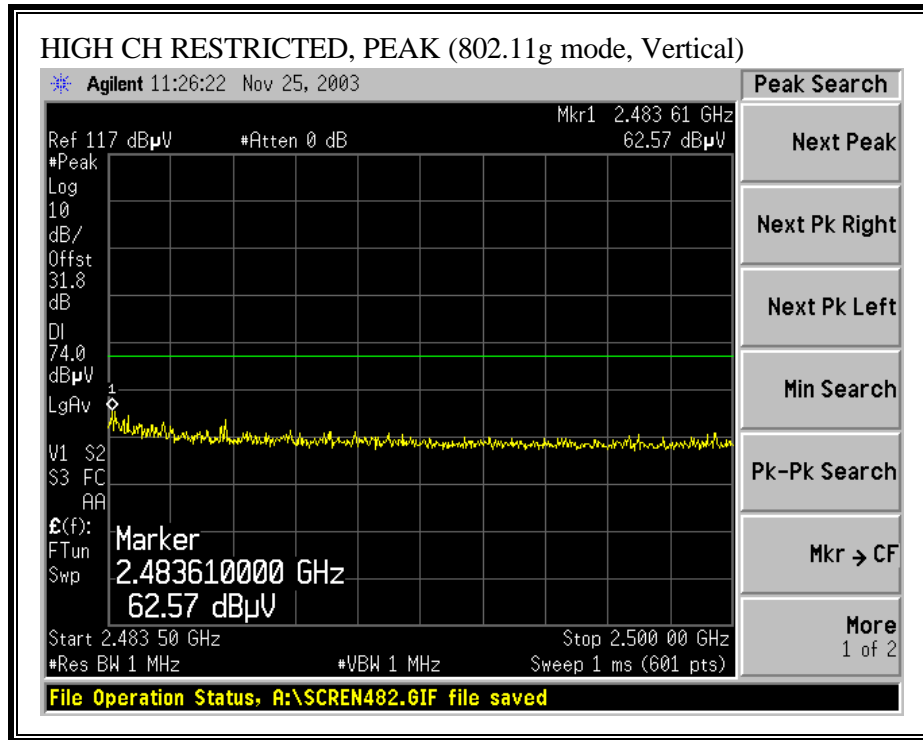

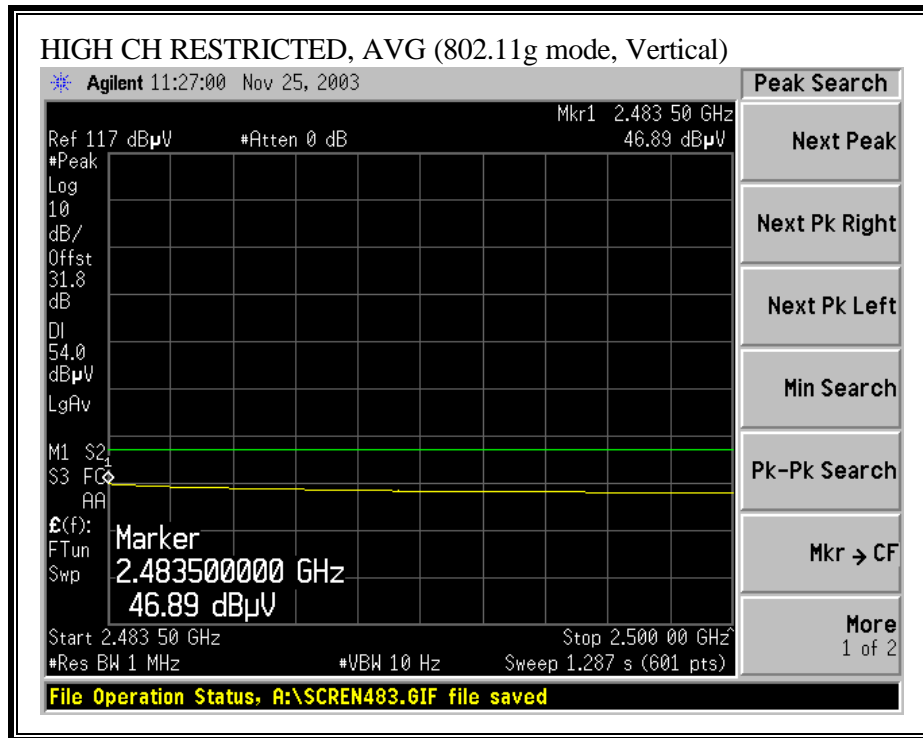

HARMONICS AND SPURIOUS EMISSIONS (g MODE)

11/25/03 **High Frequency Measurement**
 Compliance Certification Services, Morgan Hill Open Field Site

Test Engr: Yan Zheng
 Project #: 03U2392
 Company: Intel
 EUT Descrip.: 802.11b/g card with Toshiba notebook, with antenna HTL017
 EUT M/N: M200
 Test Target: FCC Class B
 Mode Oper: Transmitt, g mode

Test Equipment:

EMCO Hm 1-18GHz T60; S/N: 2238 @ 3m	Pre-amplifier 1-26GHz T63 Mitec 646456	Spectrum Analyzer Agilent E4446A Analyzer	Horn > 18GHz T117; ARA 18-26GHz; S/N:1013
-----------------------------------------------	--------------------------------------------------	-----------------------------------------------------	--------------------------------------------------------

Hi Frequency Cables:
 (2 ft) (2 ~ 3 ft) (4 ~ 6 ft) (12 ft)

Peak Measurements: 1MHz Resolution Bandwidth
 1MHz Video Bandwidth
Average Measurements: 1MHz Resolution Bandwidth
 10Hz Video Bandwidth

f GHz	Dist feet	Read Pk dBuV	Read Avg. dBuV	AF dB/m	CL dB	Amp dB	D Corr dB	HPF	Peak dBuV/m	Avg dBuV/m	Pk Lim dBuV/m	Avg Lim dBuV/m	Pk Mar dB	Avg Mar dB	Notes
Channel 1 (2412MHz)															
4824	98	45.9	32.1	33.1	4.4	-35.3	0.0	1.0	49.1	35.3	74.0	54.0	-24.9	-18.7	V
4824	98	46.1	32.2	33.1	4.4	-35.3	0.0	1.0	49.3	35.4	74.0	54.0	-24.7	-18.6	H
Channel 6 (2437MHz)															
4874	98	44.4	32.1	33.1	4.4	-35.3	0.0	1.0	47.6	35.3	74.0	54.0	-26.4	-18.7	V
7311	98	44.6	31.9	36.2	5.7	-34.6	0.0	1.0	52.9	40.2	74.0	54.0	-21.1	-13.8	V
4874	98	44.5	32.4	33.1	4.4	-35.3	0.0	1.0	47.7	35.6	74.0	54.0	-26.3	-18.4	H
7311	98	43.5	31.9	36.2	5.7	-34.6	0.0	1.0	51.8	40.2	74.0	54.0	-22.2	-13.8	H
Channel 11 (2462MHz)															
4924	98	44.4	32.0	33.2	4.5	-35.3	0.0	1.0	47.7	35.3	74.0	54.0	-26.3	-18.7	V
7386	98	43.6	31.6	36.3	5.7	-34.5	0.0	1.0	52.1	40.1	74.0	54.0	-21.9	-13.9	V
4924	98	45.2	31.8	33.2	4.5	-35.3	0.0	1.0	48.5	35.1	74.0	54.0	-25.5	-18.9	H
7386	98	43.8	31.6	36.3	5.7	-34.5	0.0	1.0	52.3	40.1	74.0	54.0	-21.7	-13.9	H
NO RADIATION EMISSION FOUND ABOVE 7.5GHz															

f	Measurement Frequency	Amp	Preamp Gain	Avg Lim	Average Field Strength Limit
Dist	Distance to Antenna	D Corr	Distance Correct to 3 meters	Pk Lim	Peak Field Strength Limit
Read	Analyzer Reading	Avg	Average Field Strength @ 3 m	Avg Mar	Margin vs. Average Limit
AF	Antenna Factor	Peak	Calculated Peak Field Strength	Pk Mar	Margin vs. Peak Limit
CL	Cable Loss	HPF	High Pass Filter		

7.9.2. CO-LOCATED TRANSMITTER EMISSIONS ABOVE 1 GHz

RESULTS

No non-compliance noted:

WORST-CASE RESTRICTED BANDEDGE (LOW CHANNEL, HORIZONTAL)

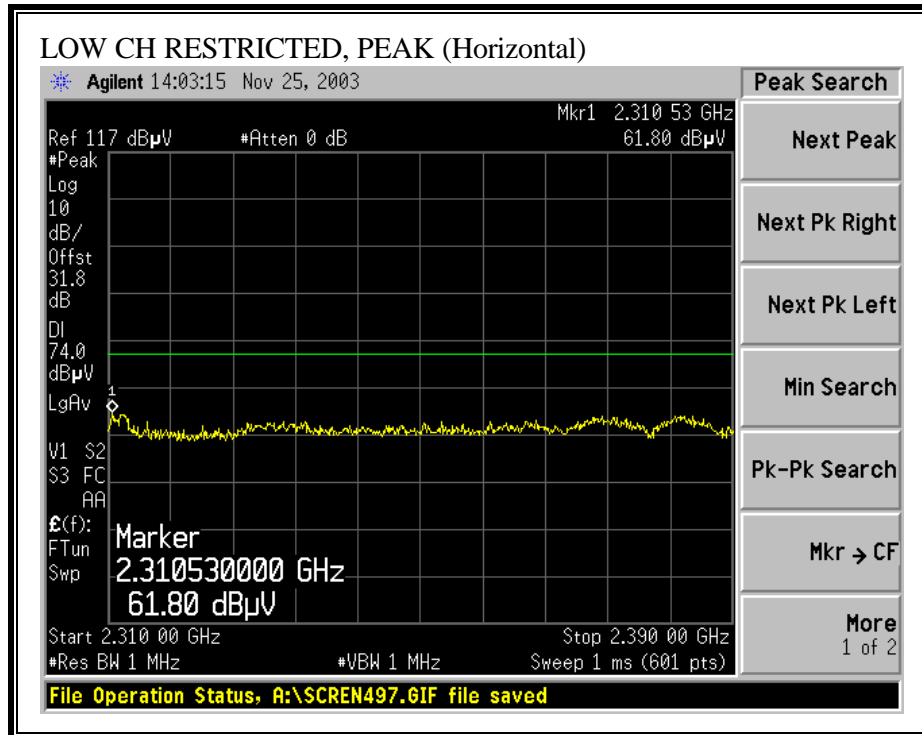

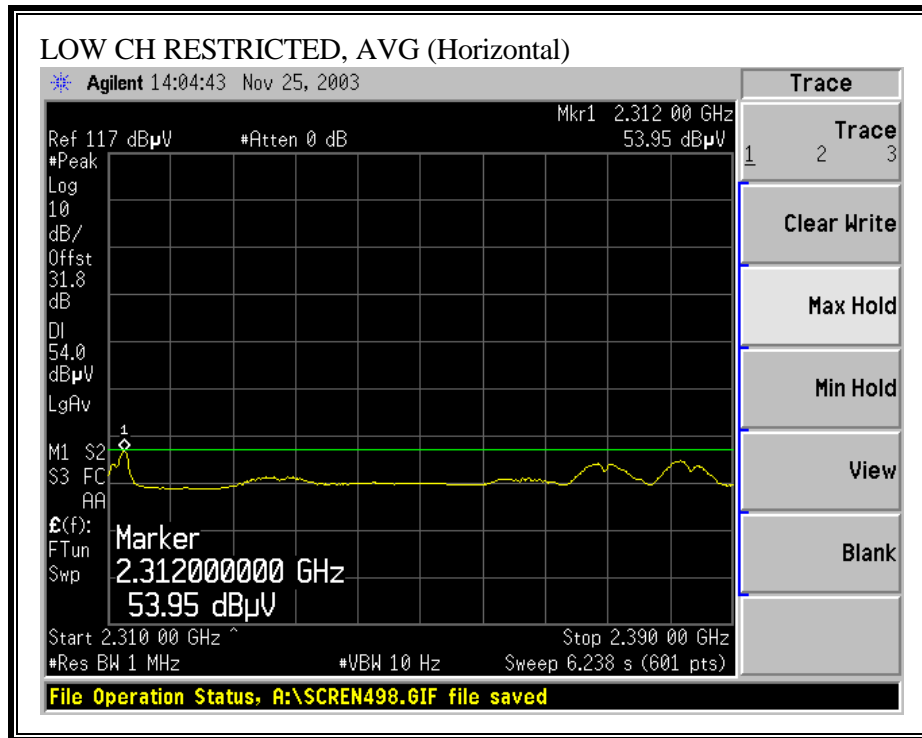

WORST-CASE RESTRICTED BANDEDGE (LOW CHANNEL, VERTICAL)

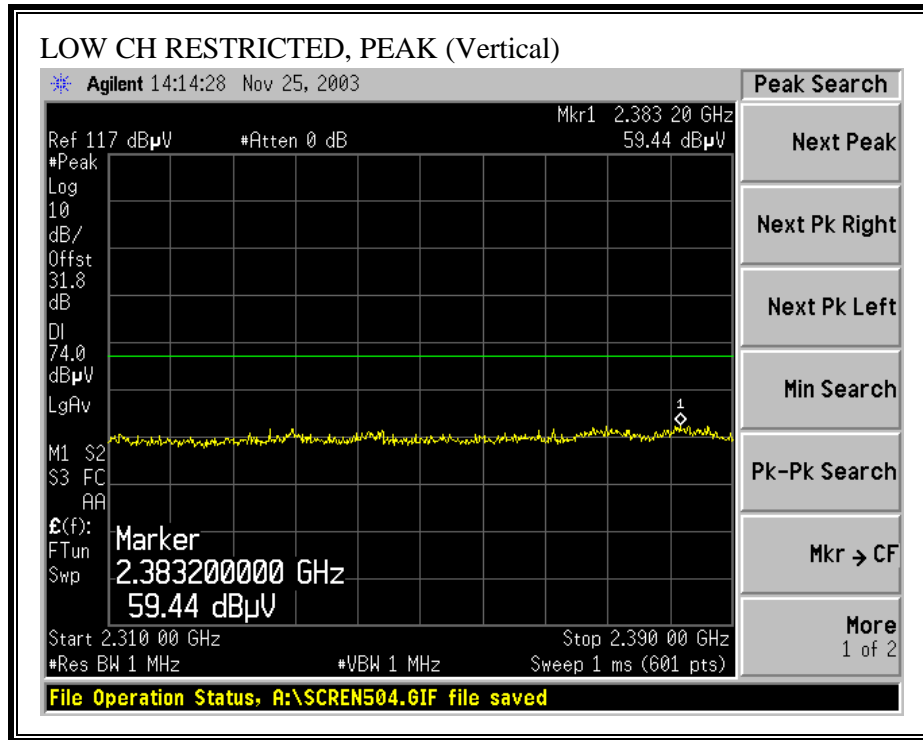

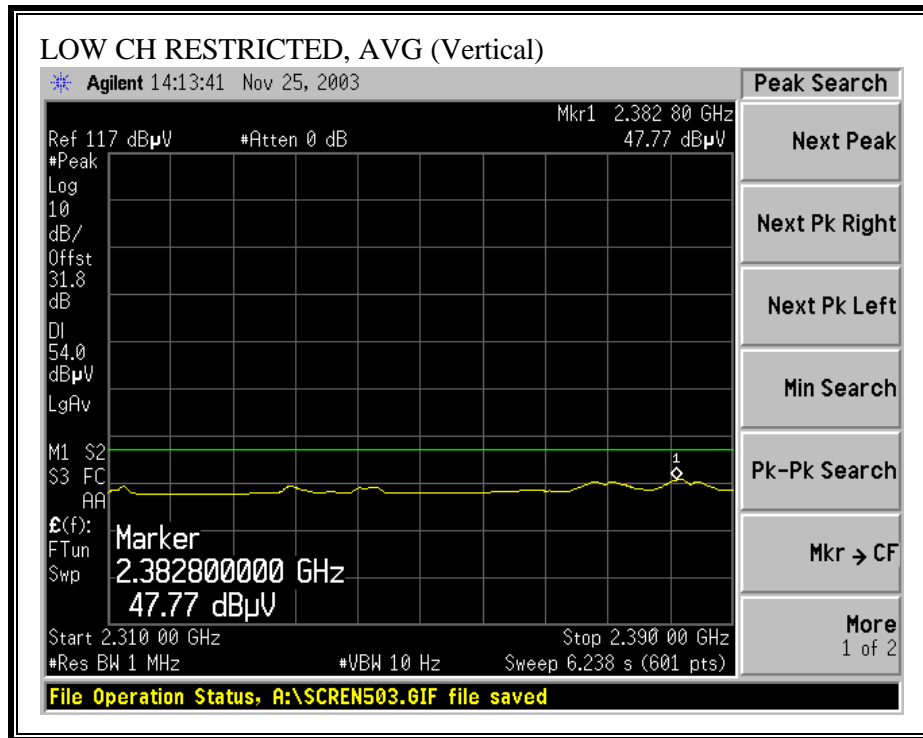

WORST-CASE RESTRICTED BANDEDGE (HIGH CHANNEL, HORIZONTAL)

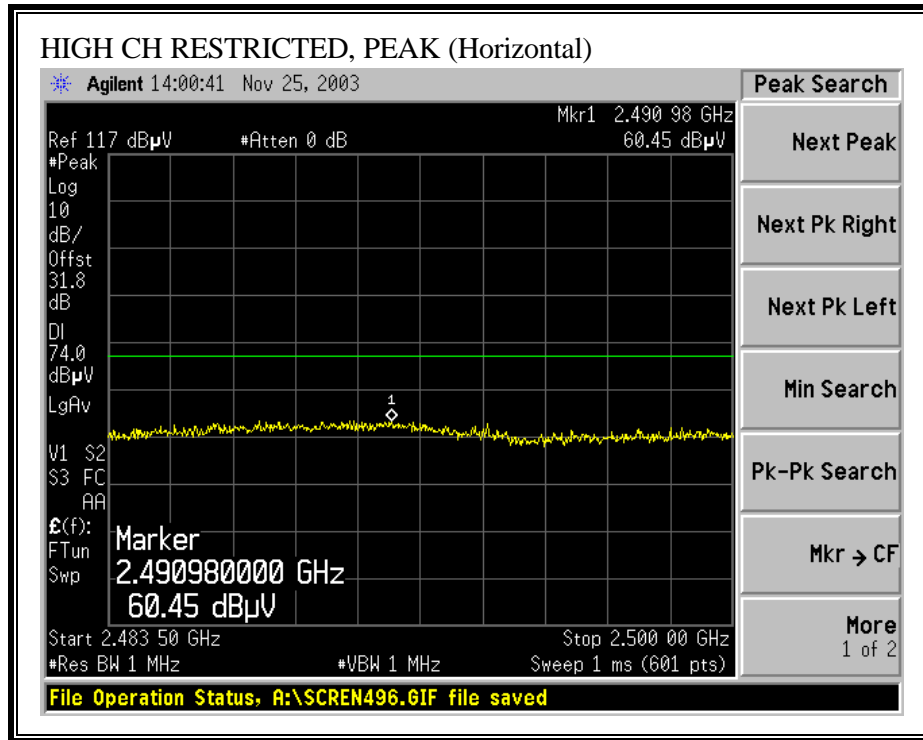

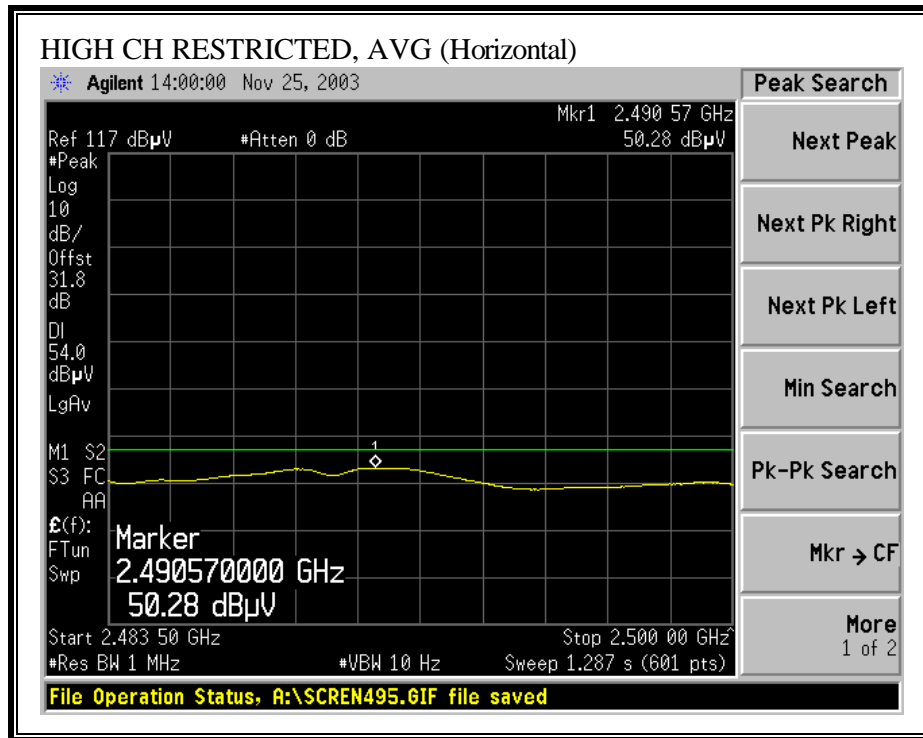

WORST-CASE RESTRICTED BANDEDGE (HIGH CHANNEL, VERTICAL)

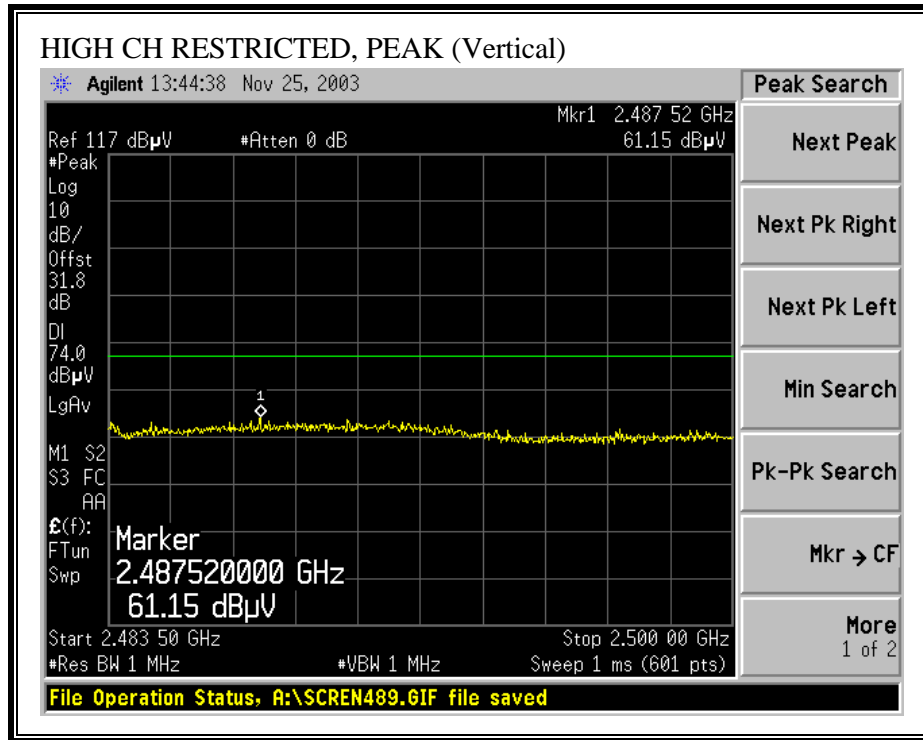

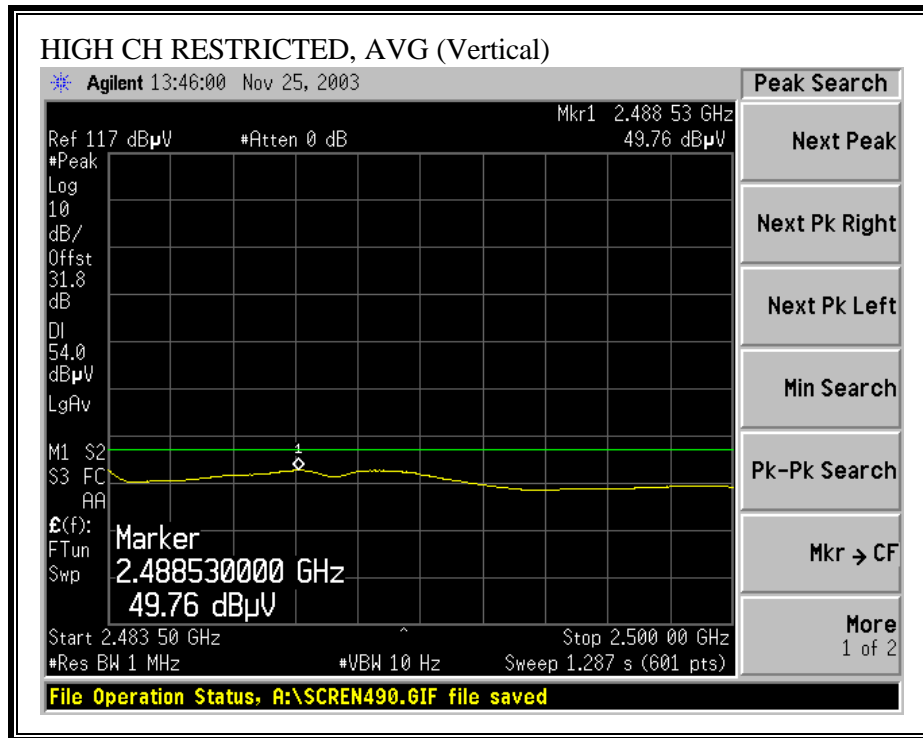

WORST-CASE HARMONICS AND SPURIOUS EMISSIONS

11/25/03 **High Frequency Measurement**
 Compliance Certification Services, Morgan Hill Open Field Site

Test Engr: Yan Zheng
Project #: 03U2392
Company: Intel
EUT Descrip.: 802.11b/g card with Toshiba notebook, with antenna HTL017
EUT M/N: M200
Test Target: FCC Class B
Mode Oper: Transmit, Co-Location with worst position, worst-case configuration & worst channel

Test Equipment:

EMCO Horn 1-18GHz T60; S/N: 2238 @ 3m	Pre-amplifier 1-26GHz T63 Mitec 646456	Spectrum Analyzer Agilent E4446A Analyzer	Horn > 18GHz T117; ARA 18-26GHz; S/N:1013
-------------------------------------------------	--------------------------------------------------	-----------------------------------------------------	--------------------------------------------------------

Hi Frequency Cables:
 (2 ft) (2 ~ 3 ft) (4 ~ 6 ft) (12 ft)

Peak Measurements: 1MHz Resolution Bandwidth
 1MHz Video Bandwidth
Average Measurements: 1MHz Resolution Bandwidth
 10Hz Video Bandwidth

f GHz	Dist feet	Read Pk dBuV	Read Avg. dBuV	AF dB/m	CL dB	Amp dB	D Corr dB	HPF	Peak dBuV/m	Avg dBuV/m	Pk Lim dBuV/m	Avg Lim dBuV/m	Pk Mar dB	Avg Mar dB	Notes
Channel 11 (2462MHz)															
4924	98	45.9	34.0	33.2	4.5	-35.3	0.0	1.0	49.2	37.3	74.0	54.0	-24.8	-16.7	V
7386	98	45.0	31.1	36.3	5.7	-34.5	0.0	1.0	53.5	39.6	74.0	54.0	-20.5	-14.4	V
4924	98	45.3	33.6	33.2	4.5	-35.3	0.0	1.0	48.6	36.9	74.0	54.0	-25.4	-17.1	H
7386	98	43.8	31.0	36.3	5.7	-34.5	0.0	1.0	52.3	39.5	74.0	54.0	-21.7	-14.5	H
NO RADIATION EMISSION FOUND ABOVE 7.5GHz															

f Measurement Frequency Amp Preamp Gain Avg Lim Average Field Strength Limit
 Dist Distance to Antenna D Corr Distance Correct to 3 meters Pk Lim Peak Field Strength Limit
 Read Analyzer Reading Avg Average Field Strength @ 3 m Avg Mar Margin vs. Average Limit
 AF Antenna Factor Peak Calculated Peak Field Strength Pk Mar Margin vs. Peak Limit
 CL Cable Loss HPF High Pass Filter

7.9.3. WORST-CASE RADIATED EMISSIONS BELOW 1 GHz

SPURIOUS EMISSIONS 30 TO 1000 MHz (WORST-CASE CONFIGURATION, HORIZONTAL)

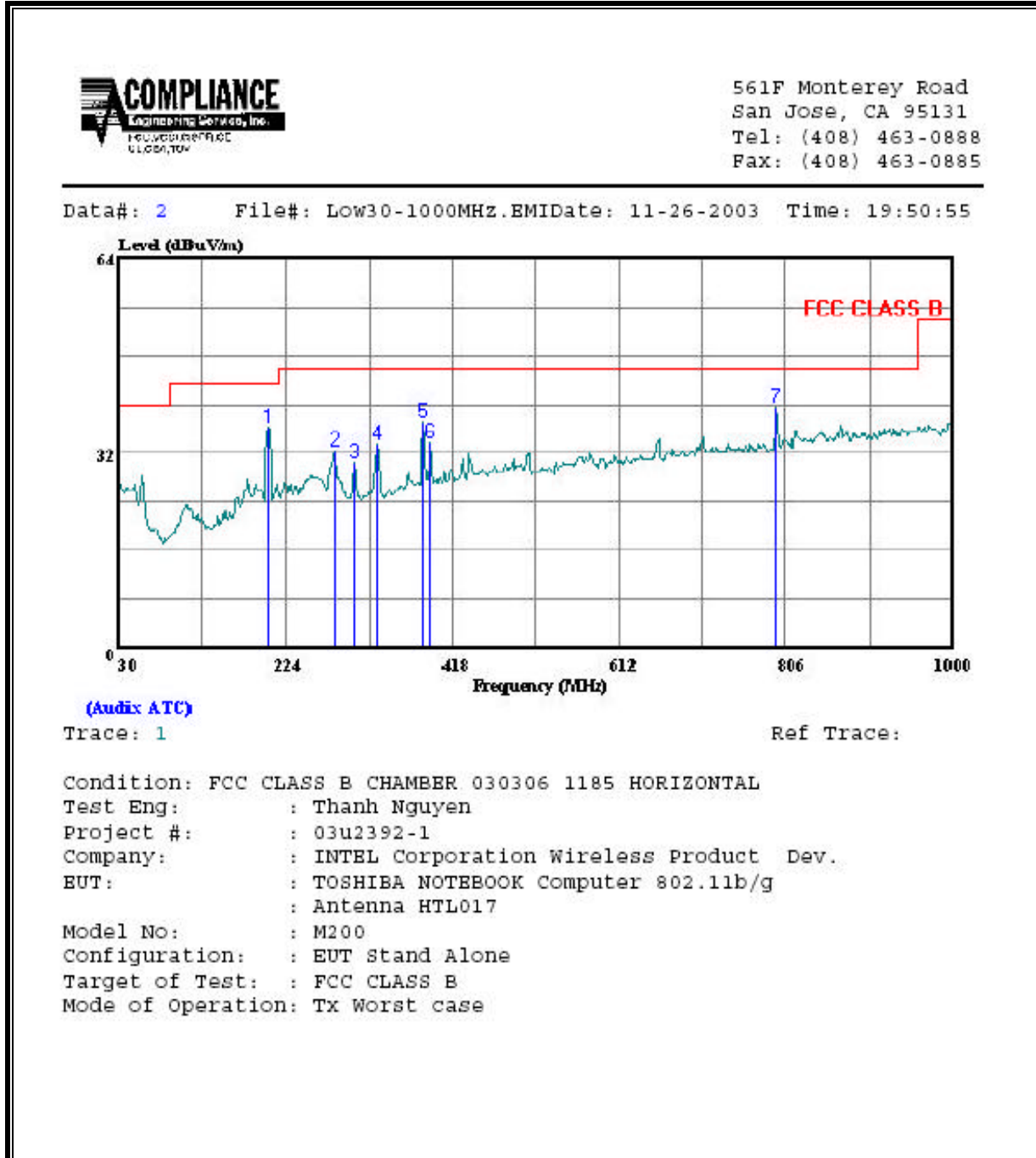

	Freq	Remark	Read Level	Factor	Level	Limit Line	Over Limit
	MHz		dBuV	dB	dBuV/m	dBuV/m	dB
1	203.630	Peak	25.61	10.59	36.20	43.50	-7.30
2	281.230	Peak	18.77	13.59	32.36	46.00	-13.64
3	305.480	Peak	16.60	13.96	30.56	46.00	-15.44
4	329.730	Peak	18.81	14.68	33.49	46.00	-12.51
5	383.080	Peak	21.09	16.06	37.15	46.00	-8.85
6	392.780	Peak	17.40	16.28	33.68	46.00	-12.32
7	795.330	Peak	16.90	22.76	39.66	46.00	-6.34

SPURIOUS EMISSIONS 30 TO 1000 MHz (WORST-CASE CONFIGURATION, VERTICAL)

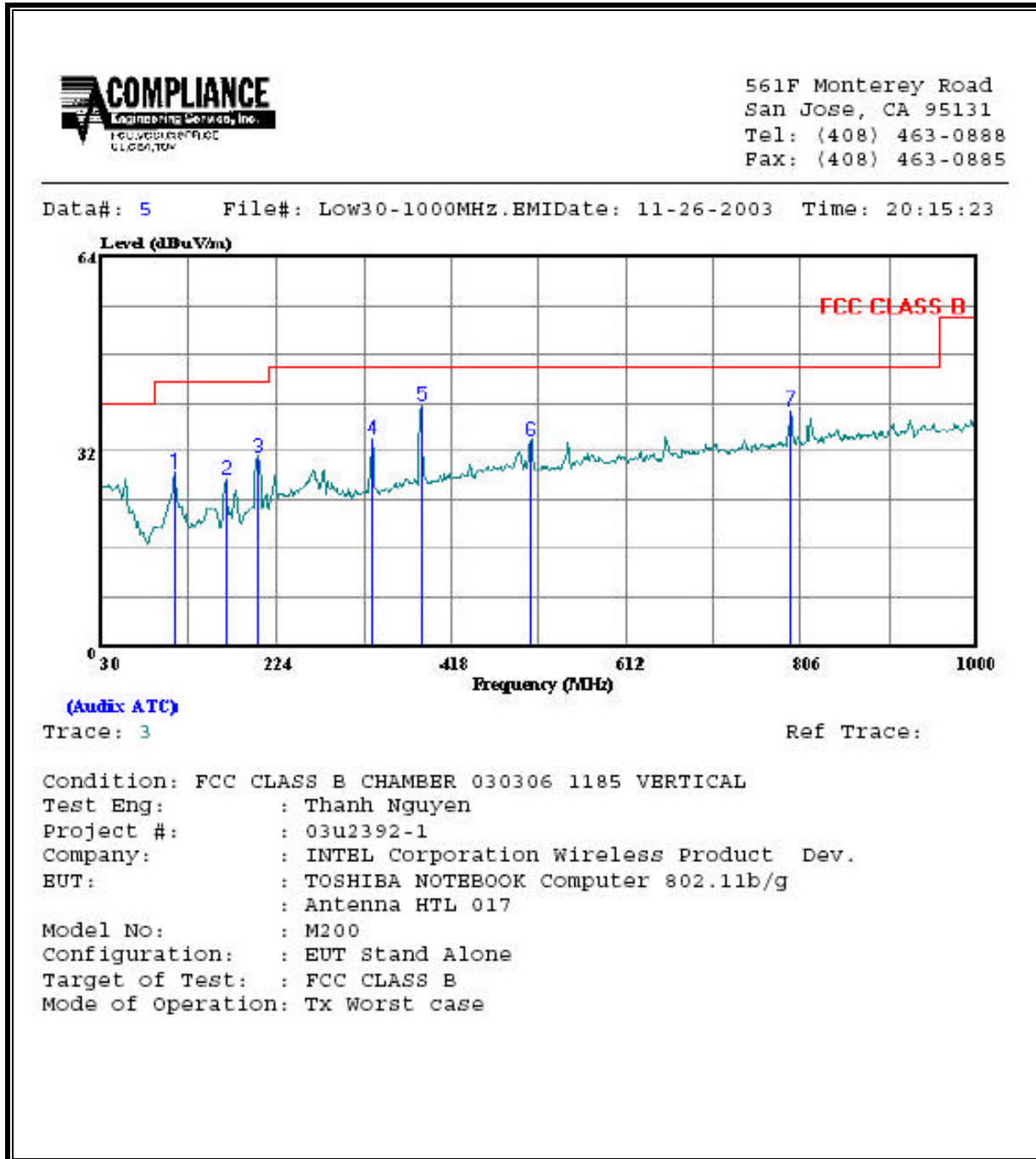

	Freq	Remark	Read Level	Factor	Level	Limit Line	Over Limit
	MHz		dBuV	dB	dBuV/m	dBuV/m	dB
1	111.480	Peak	17.72	10.88	28.60	43.50	-14.90
2	167.740	Peak	17.38	10.08	27.46	43.50	-16.04
3	204.600	Peak	20.28	10.68	30.97	43.50	-12.53
4	329.730	Peak	19.41	14.68	34.09	46.00	-11.91
5	385.990	Peak	23.60	16.15	39.75	46.00	-6.25
6	506.270	Peak	14.91	18.93	33.84	46.00	-12.16
7	795.330	Peak	16.00	22.76	38.76	46.00	-7.24

7.10. RADIATED EMISSIONS RESULTS WITH TIAN01 ANTENNA

7.10.1. TRANSMITTER RADIATED EMISSIONS ABOVE 1 GHz

RESULTS

The worst-case condition was observed with the EUT in the laptop configuration. No non-compliance noted:

RESTRICTED BANDEDGE (b MODE, LOW CHANNEL, HORIZONTAL)

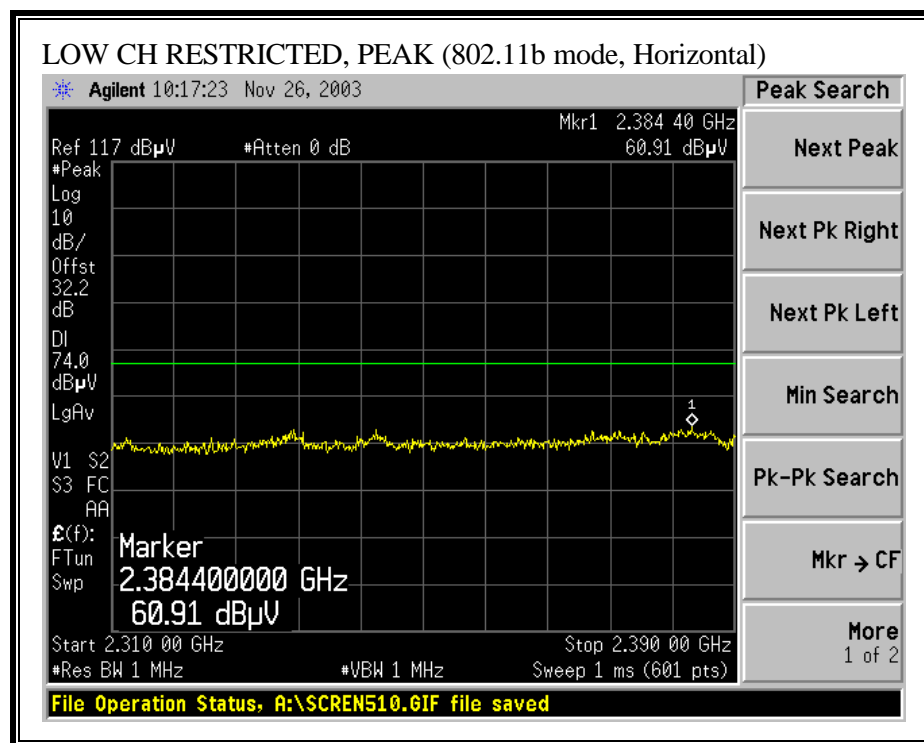

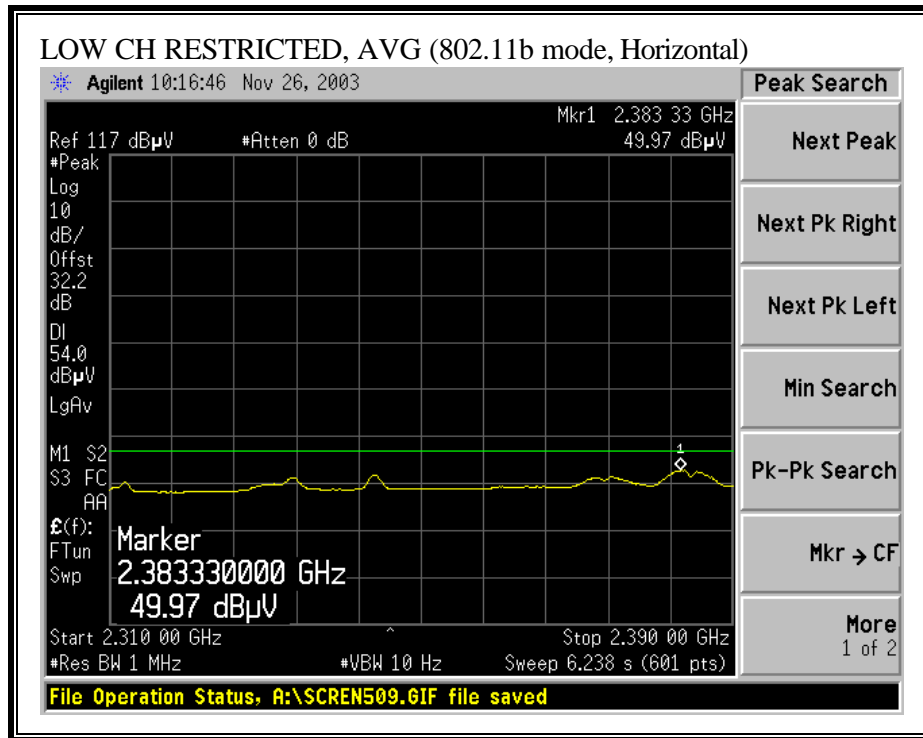

RESTRICTED BANDEDGE (b MODE, LOW CHANNEL, VERTICAL)

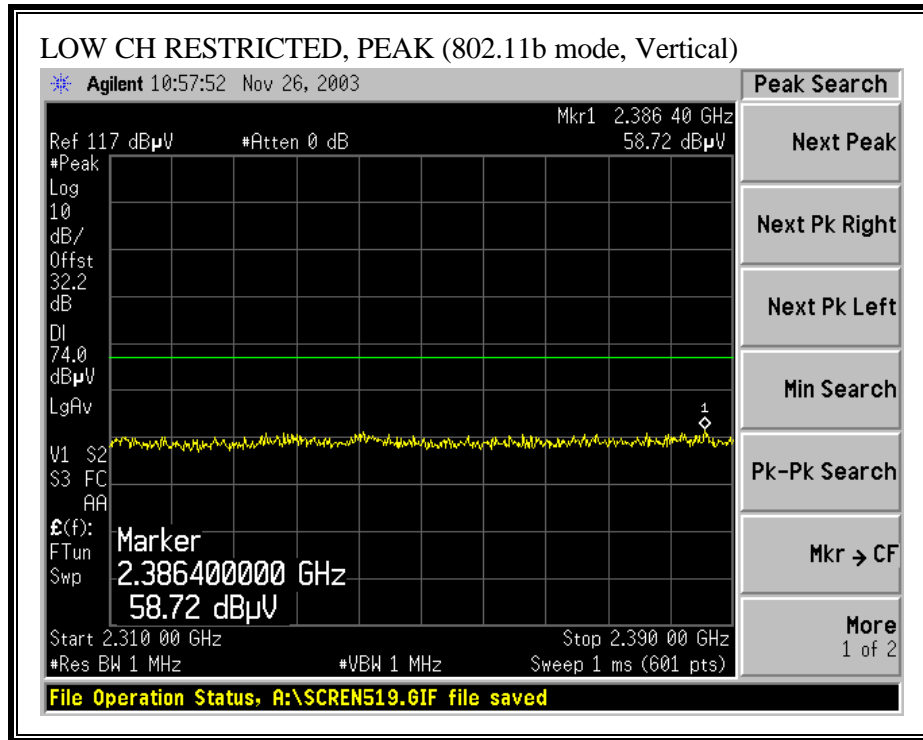

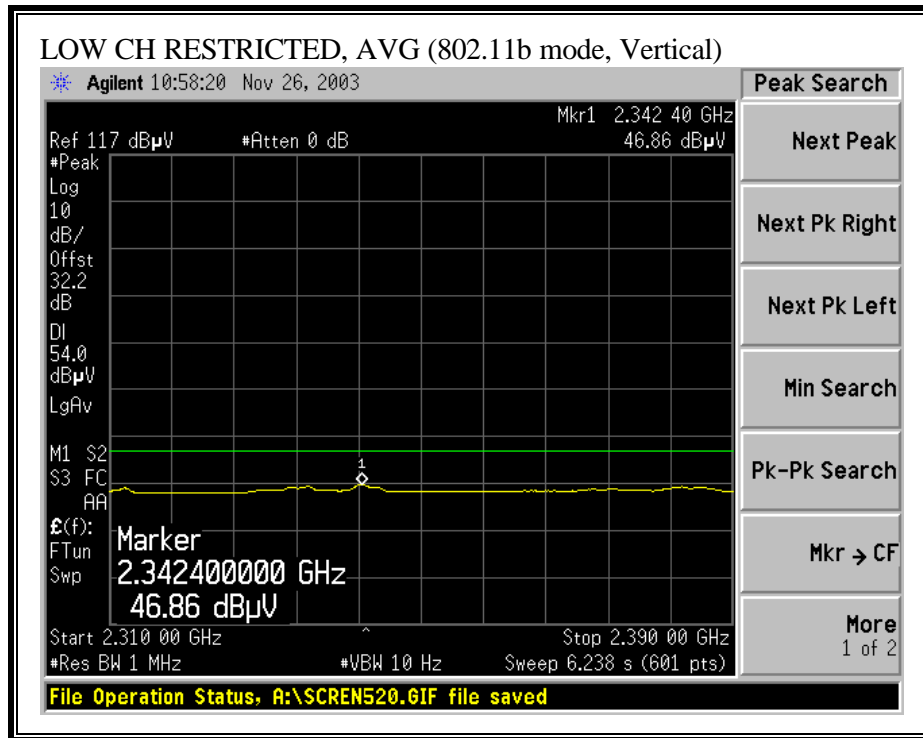

RESTRICTED BANDEDGE (b MODE, HIGH CHANNEL, HORIZONTAL)

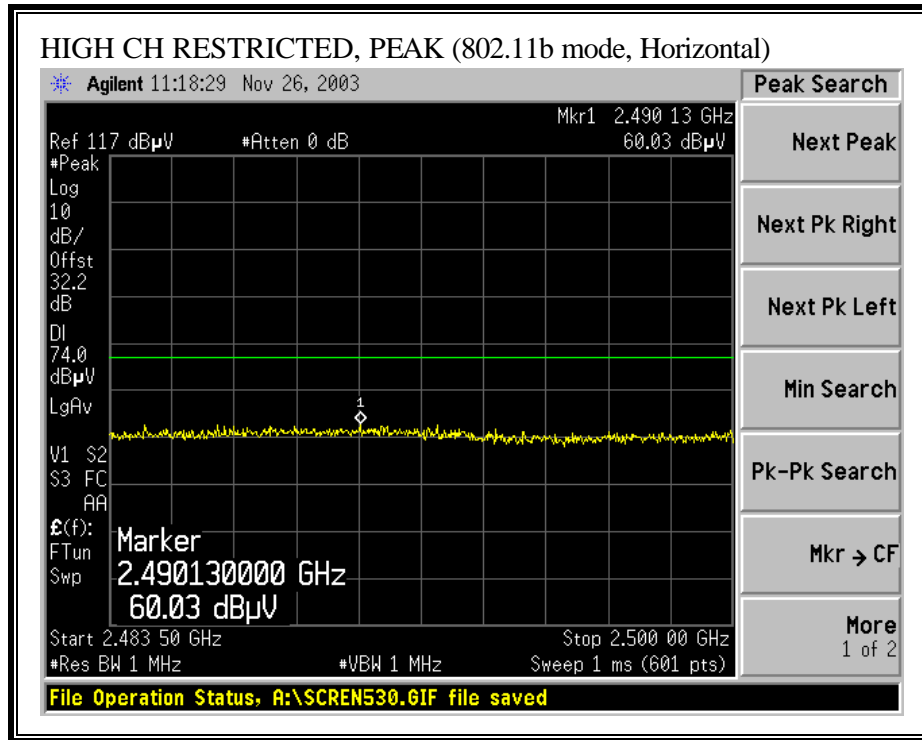

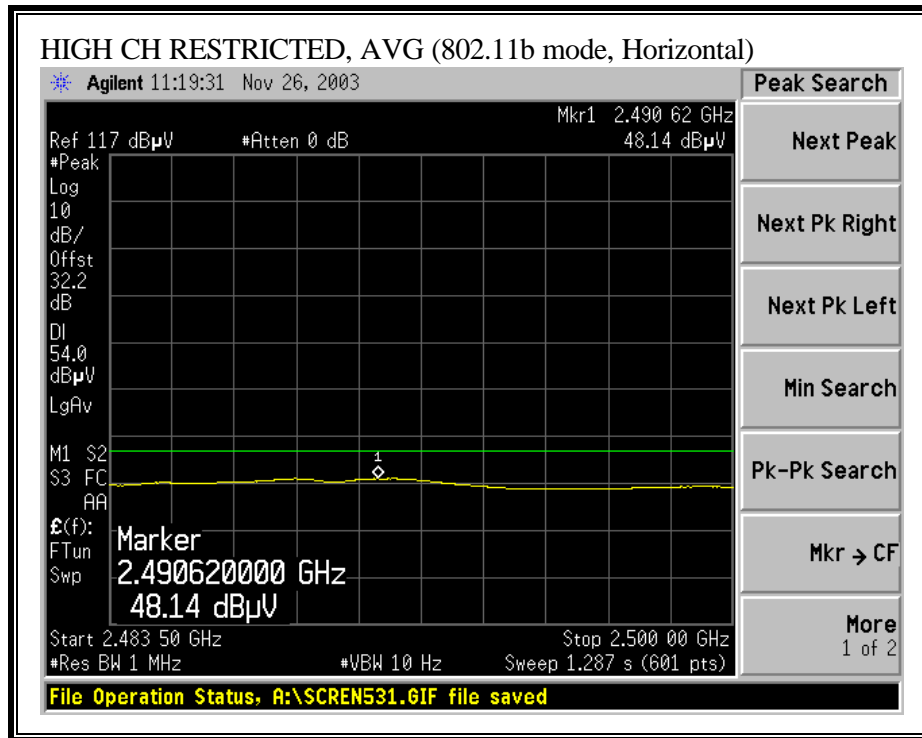

RESTRICTED BANDEDGE (b MODE, HIGH CHANNEL, VERTICAL)

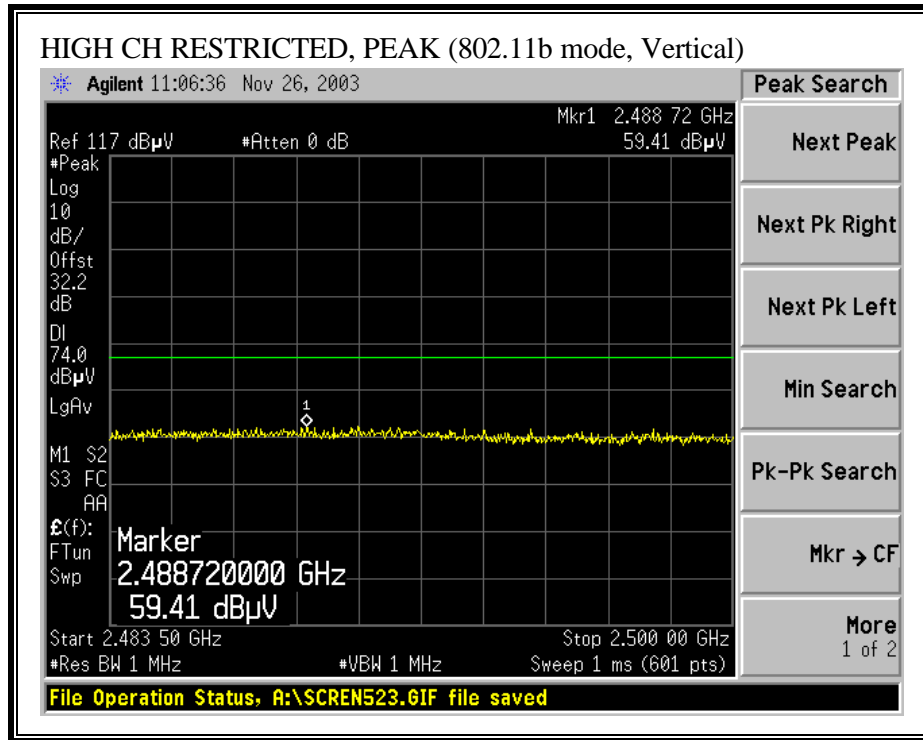

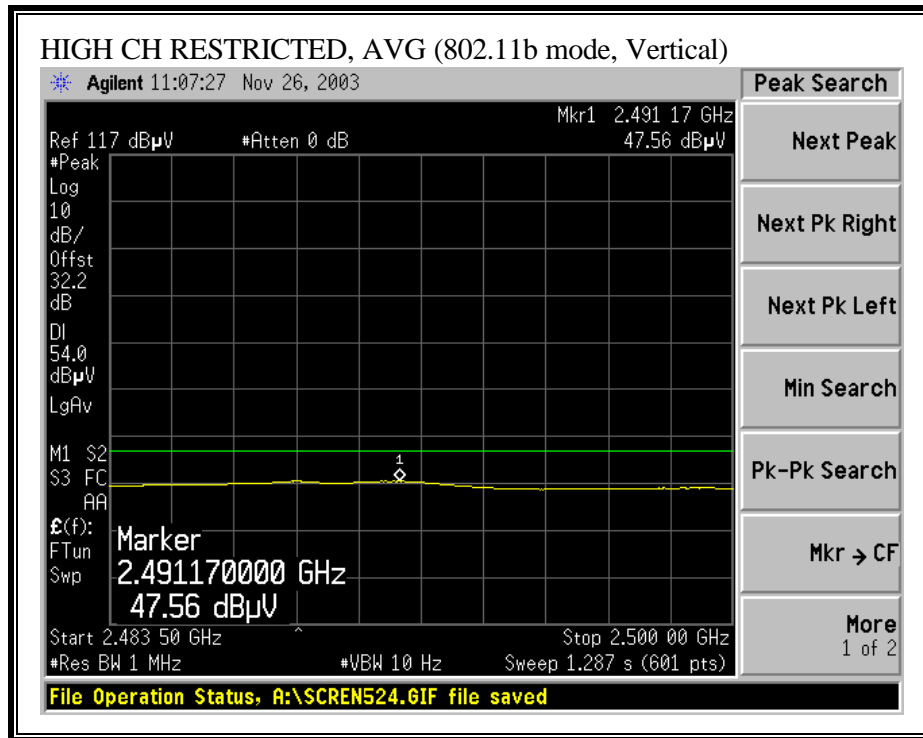

HARMONICS AND SPURIOUS EMISSIONS (b MODE)

11/26/03 **High Frequency Measurement**
 Compliance Certification Services, Morgan Hill Open Field Site

Test Engr: Yan Zheng
Project #: 03U2392
Company: Intel
EUT Descrip.: 802.11b/g card with Toshiba notebook, with antenna TIAN01
EUT M/N: M200
Test Target: FCC Class B
Mode Oper: Transmitt, b mode

Test Equipment:

EMCO Horn 1-18GHz T60; S/N: 2238 @ 3m	Pre-amplifier 1-26GHz T63 Miteq 646456	Spectrum Analyzer Agilent E4446A Analyzer	Horn > 18GHz T117; ARA 18-26GHz; S/N:1013
------------------------------------------	-------------------------------------------	----------------------------------------------	----------------------------------------------

Hi Frequency Cables:
 (2 ft) (2 ~ 3 ft) (4 ~ 6 ft) (12 ft)

Peak Measurements:
 1 MHz Resolution Bandwidth
 1 MHz Video Bandwidth

Average Measurements:
 1 MHz Resolution Bandwidth
 10 Hz Video Bandwidth

f GHz	Dist feet	Read Pk dBuV	Read Avg. dBuV	AF dB/m	CL dB	Amp dB	D Corr dB	HPF	Peak dBuV/m	Avg dBuV/m	Pk Lim dBuV/m	Avg Lim dBuV/m	Pk Mar dB	Avg Mar dB	Notes
Channe 1 (2412MHz)															
4.824	9.8	43.9	33.4	33.1	4.4	-35.3	0.0	1.0	47.1	36.6	74.0	54.0	-26.9	-17.4	V
4.824	9.8	43.0	30.4	33.1	4.4	-35.3	0.0	1.0	46.2	33.6	74.0	54.0	-27.8	-20.4	H
Channe 6 (2437MHz)															
4.874	9.8	43.6	31.5	33.1	4.4	-35.3	0.0	1.0	46.8	34.7	74.0	54.0	-27.2	-19.3	V
7.311	9.8	43.2	31.0	36.2	5.7	-34.6	0.0	1.0	51.5	39.3	74.0	54.0	-22.5	-14.7	V
4.874	9.8	43.0	30.3	33.1	4.4	-35.3	0.0	1.0	46.2	33.5	74.0	54.0	-27.8	-20.5	H
7.311	9.8	42.0	30.1	36.2	5.7	-34.6	0.0	1.0	50.3	38.4	74.0	54.0	-23.7	-15.6	H
Channe 11 (2462MHz)															
4.924	9.8	42.9	32.0	33.2	4.5	-35.3	0.0	1.0	46.2	35.3	74.0	54.0	-27.8	-18.7	V
7.386	9.8	43.6	31.2	36.3	5.7	-34.5	0.0	1.0	52.1	39.7	74.0	54.0	-21.9	-14.3	V
4.924	9.8	43.3	30.3	33.2	4.5	-35.3	0.0	1.0	46.6	33.6	74.0	54.0	-27.4	-20.4	H
7.386	9.8	42.5	30.1	36.3	5.7	-34.5	0.0	1.0	51.0	38.6	74.0	54.0	-23.0	-15.4	H
NO RADIATION EMISSION FOUND ABOVE 7.5GHz															

f	Measurement Frequency	Amp	Preamp Gain	Avg Lim	Average Field Strength Limit
Dist	Distance to Antenna	D Corr	Distance Correct to 3 meters	Pk Lim	Peak Field Strength Limit
Read	Analyzer Reading	Avg	Average Field Strength @ 3 m	Avg Mar	Margin vs. Average Limit
AF	Antenna Factor	Peak	Calculated Peak Field Strength	Pk Mar	Margin vs. Peak Limit
CL	Cable Loss	HPF	High Pass Filter		

RESTRICTED BANDEDGE (g MODE, LOW CHANNEL, HORIZONTAL)

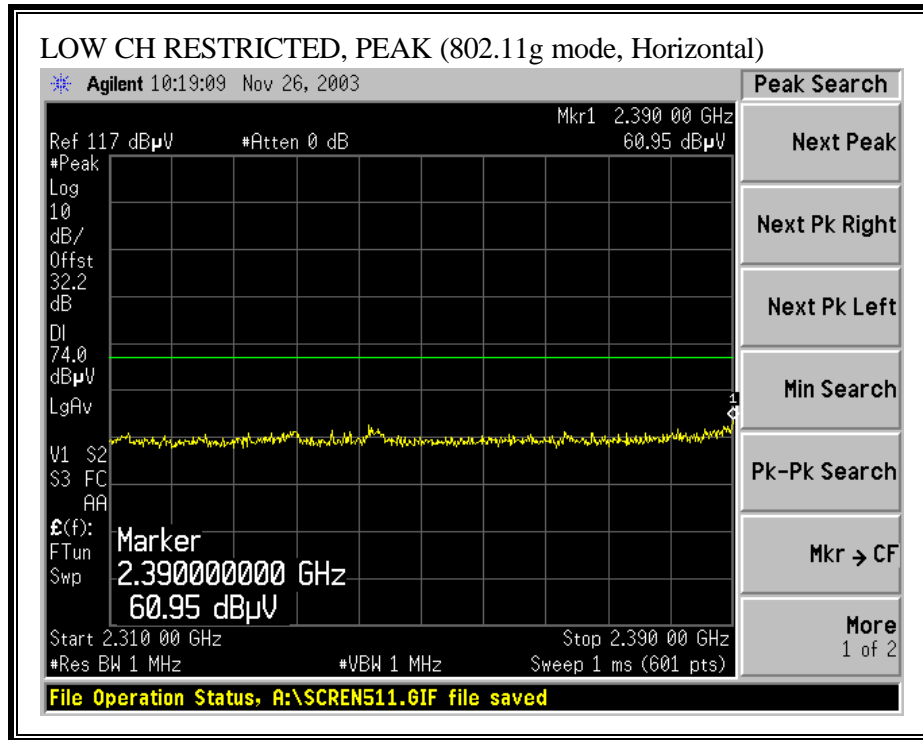

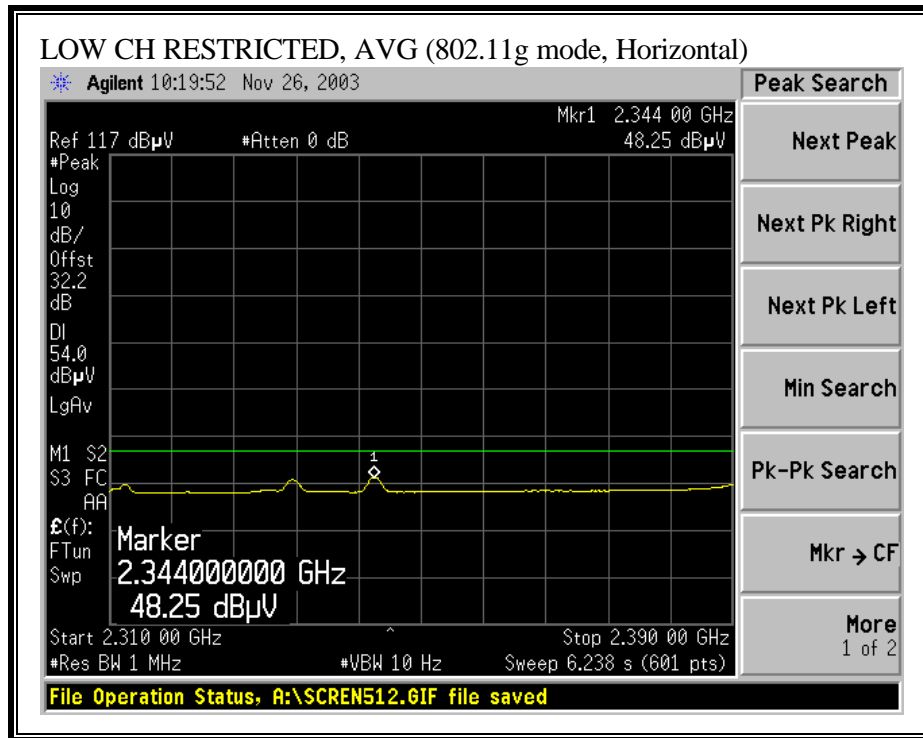

RESTRICTED BANDEDGE (g MODE, LOW CHANNEL, VERTICAL)

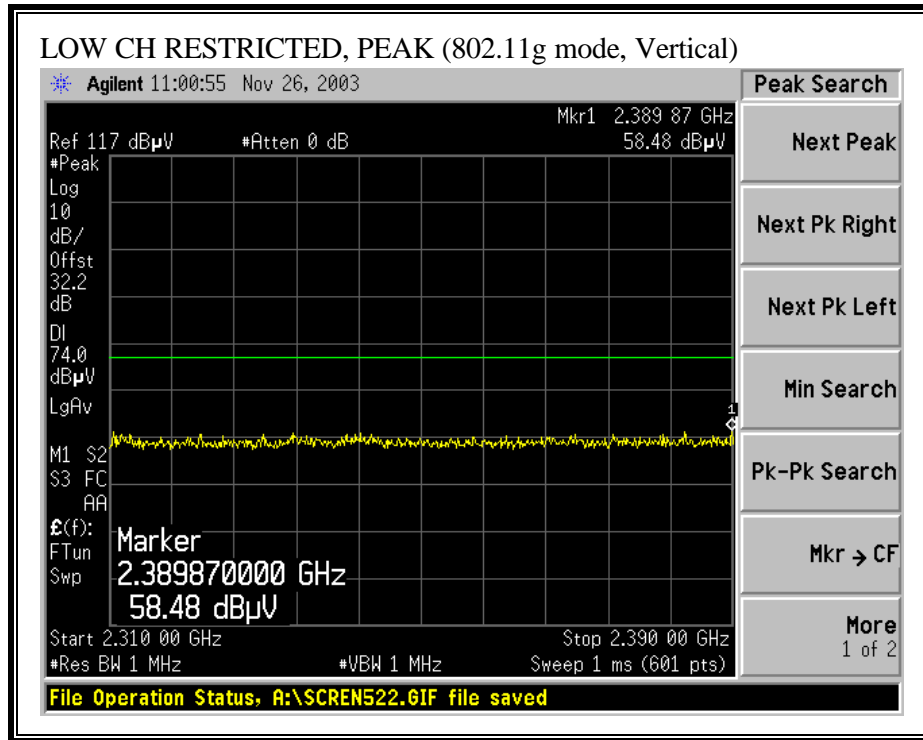

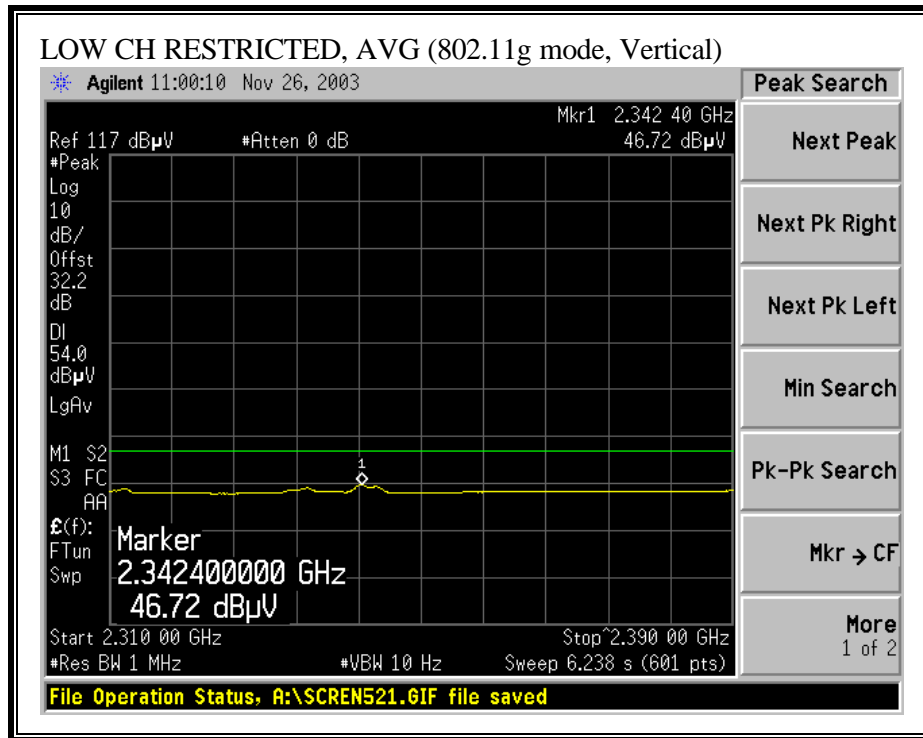

RESTRICTED BANDEDGE (g MODE, HIGH CHANNEL, HORIZONTAL)

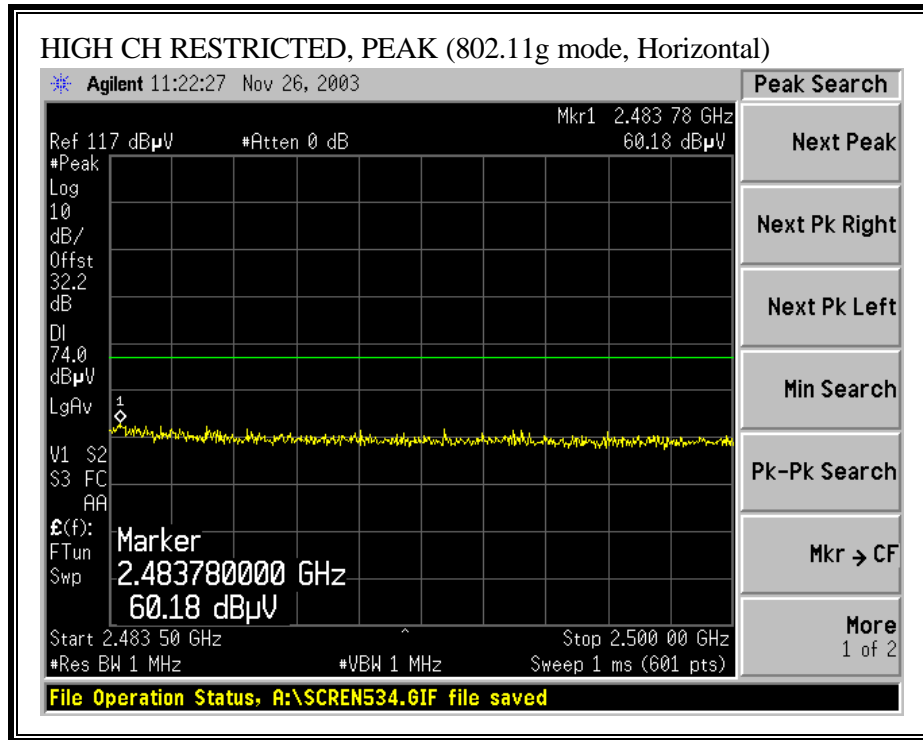

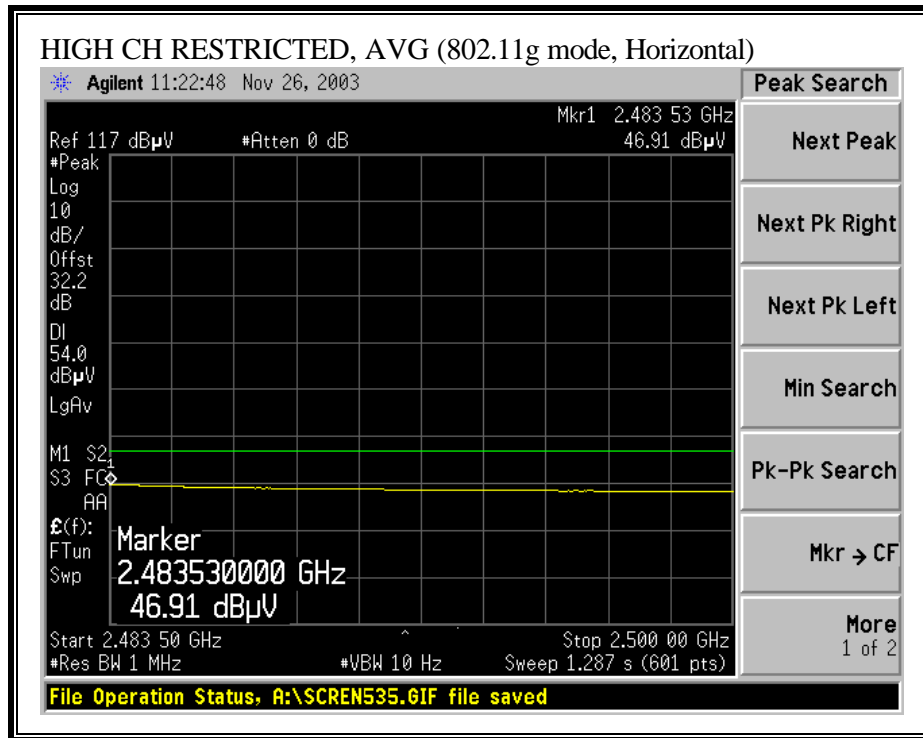

RESTRICTED BANDEDGE (g MODE, HIGH CHANNEL, VERTICAL)

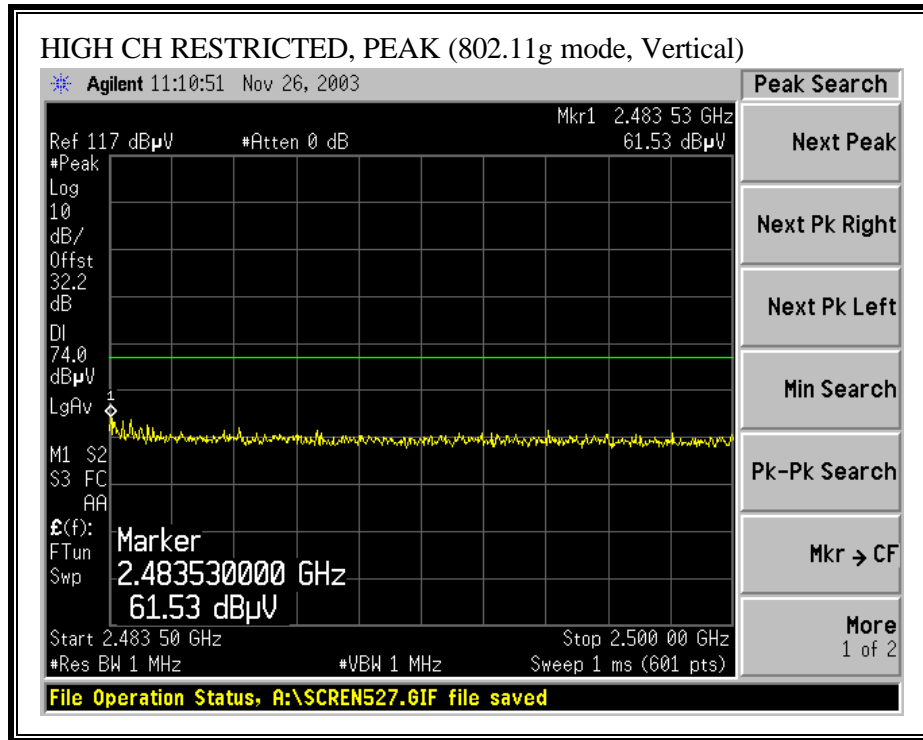

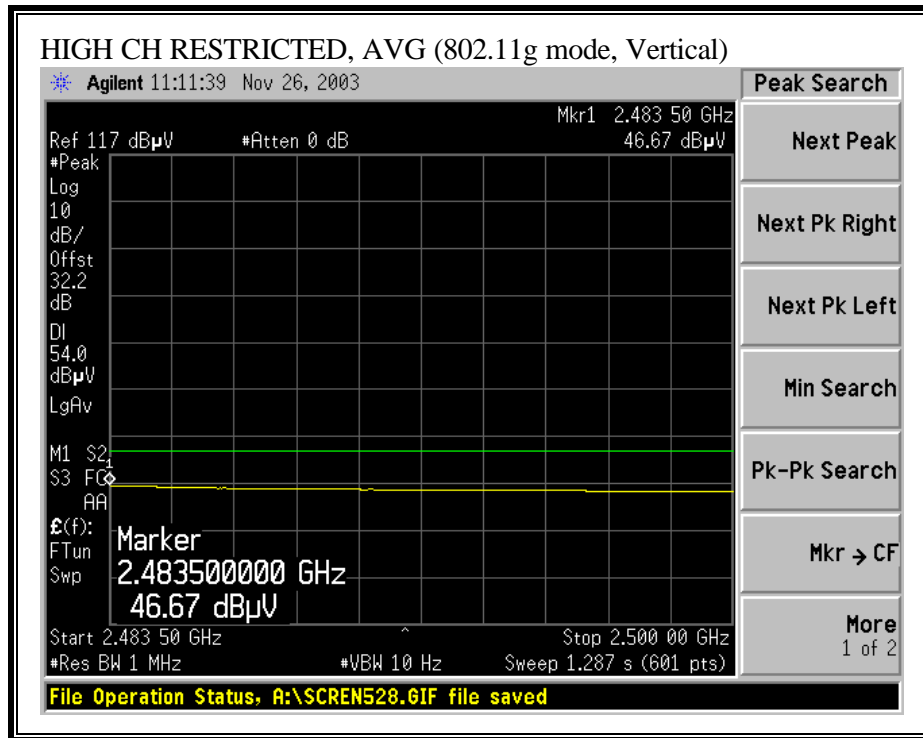

HARMONICS AND SPURIOUS EMISSIONS (g MODE)

11/26/03 **High Frequency Measurement**
 Compliance Certification Services, Morgan Hill Open Field Site

Test Engr: Yan Zheng
 Project #: 03U2392
 Company: Intel
 EUT Descrip.: 802.11b/g card with Toshiba notebook, with antenna TIAN01
 EUT M/N: M200
 Test Target: FCC Class B
 Mode Oper: Transmitt, g mode

Test Equipment:

EMCO Horn 1-18GHz T60; S/N: 2238 @ 3m	Pre-amplifier 1-26GHz T63 Mitec 646456	Spectrum Analyzer Agilent E4446A Analyzer	Horn > 18GHz T117; ARA 18-26GHz; S/N:1013
-------------------------------------------------	--------------------------------------------------	-----------------------------------------------------	--------------------------------------------------------

Hi Frequency Cables:
 (2 ft) (2 ~ 3 ft) (4 ~ 6 ft) (12 ft)

Peak Measurements: 1MHz Resolution Bandwidth
 1MHz Video Bandwidth
Average Measurements: 1MHz Resolution Bandwidth
 10Hz Video Bandwidth

f GHz	Dist feet	Read Pk dBuV	Read Avg. dBuV	AF dB/m	CL dB	Amp dB	D Corr dB	HPF	Peak dBuV/m	Avg dBuV/m	Pk Lim dBuV/m	Avg Lim dBuV/m	Pk Mar dB	Avg Mar dB	Notes
Channel 1 (2412MHz)															
4824	98	43.5	31.3	33.1	4.4	-35.3	0.0	1.0	46.7	34.5	74.0	54.0	-27.3	-19.5	V
4824	98	43.3	31.1	33.1	4.4	-35.3	0.0	1.0	46.5	34.3	74.0	54.0	-27.5	-19.7	H
Channel 6 (2437MHz)															
4874	98	44.7	31.6	33.1	4.4	-35.3	0.0	1.0	47.9	34.8	74.0	54.0	-26.1	-19.2	V
7311	98	43.1	31.3	36.2	5.7	-34.6	0.0	1.0	51.4	39.6	74.0	54.0	-22.6	-14.4	V
4874	98	42.7	30.2	33.1	4.4	-35.3	0.0	1.0	45.9	33.4	74.0	54.0	-28.1	-20.6	H
7311	98	43.2	29.6	36.2	5.7	-34.6	0.0	1.0	51.5	37.9	74.0	54.0	-22.5	-16.1	H
Channel 11 (2462MHz)															
4924	98	44.9	32.0	33.2	4.5	-35.3	0.0	1.0	48.2	35.3	74.0	54.0	-25.8	-18.7	V
7386	98	45.6	31.9	36.3	5.7	-34.5	0.0	1.0	54.1	40.4	74.0	54.0	-19.9	-13.6	V
4924	98	45.7	31.7	33.2	4.5	-35.3	0.0	1.0	49.0	35.0	74.0	54.0	-25.0	-19.0	H
7386	98	44.6	30.8	36.3	5.7	-34.5	0.0	1.0	53.1	39.3	74.0	54.0	-20.9	-14.7	H
NO RADIATION EMISSION FOUND ABOVE 7.5GHz															

f	Measurement Frequency	Amp	Preamp Gain	Avg Lim	Average Field Strength Limit
Dist	Distance to Antenna	D Corr	Distance Correct to 3 meters	Pk Lim	Peak Field Strength Limit
Read	Analyzer Reading	Avg	Average Field Strength @ 3 m	Avg Mar	Margin vs. Average Limit
AF	Antenna Factor	Peak	Calculated Peak Field Strength	Pk Mar	Margin vs. Peak Limit
CL	Cable Loss	HPF	High Pass Filter		

7.10.2. CO-LOCATED TRANSMITTER EMISSIONS ABOVE 1 GHz

RESULTS

No non-compliance noted:

WORST-CASE RESTRICTED BANDEDGE (LOW CHANNEL, HORIZONTAL)

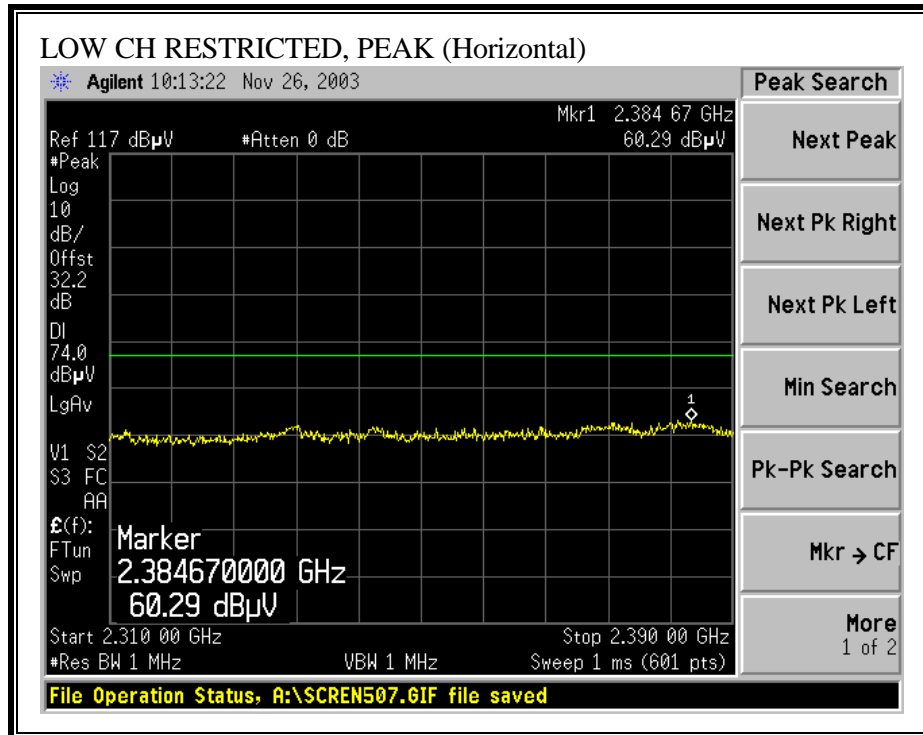

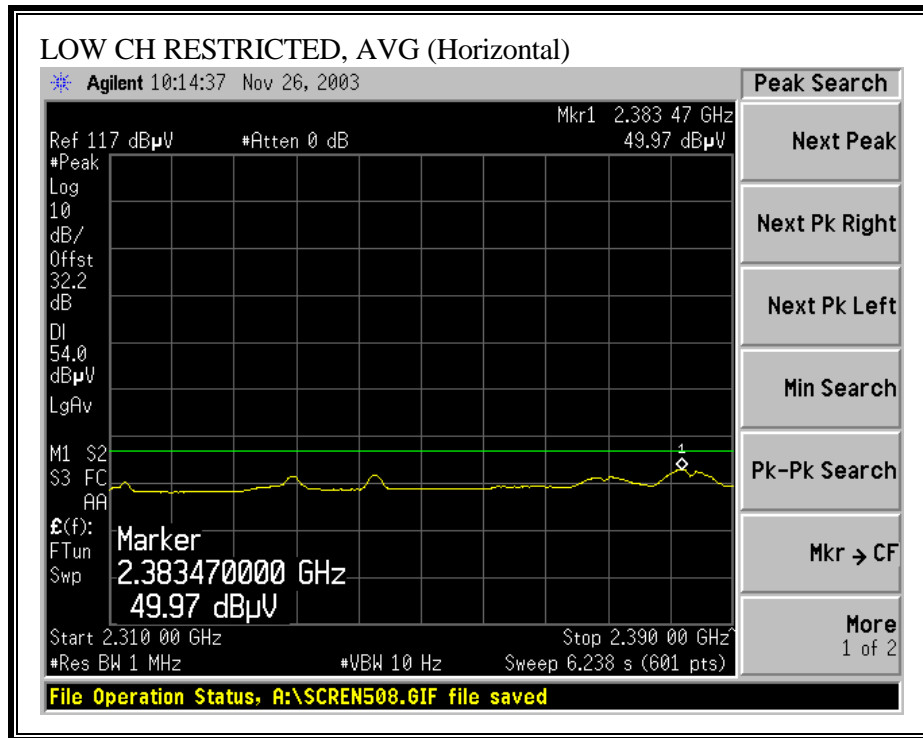

WORST-CASE RESTRICTED BANDEDGE (LOW CHANNEL, VERTICAL)

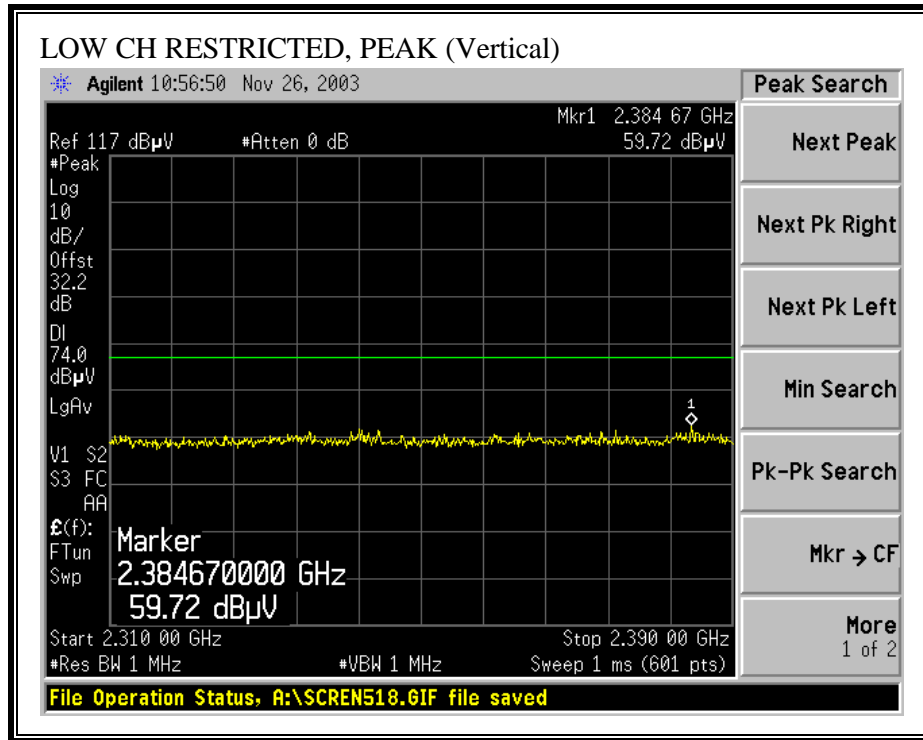

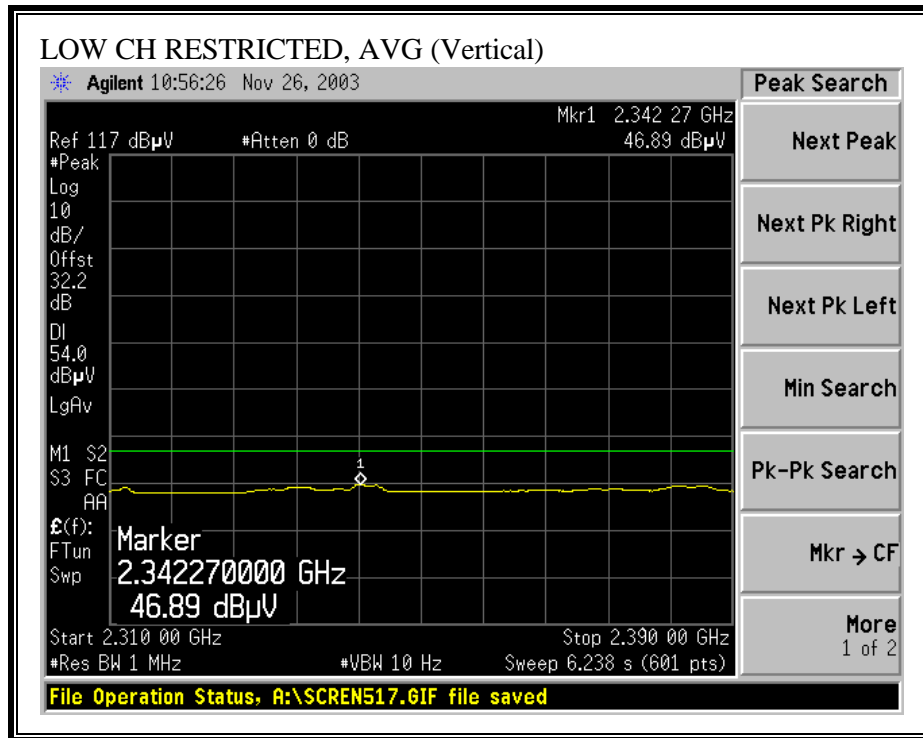

WORST-CASE RESTRICTED BANDEDGE (HIGH CHANNEL, HORIZONTAL)

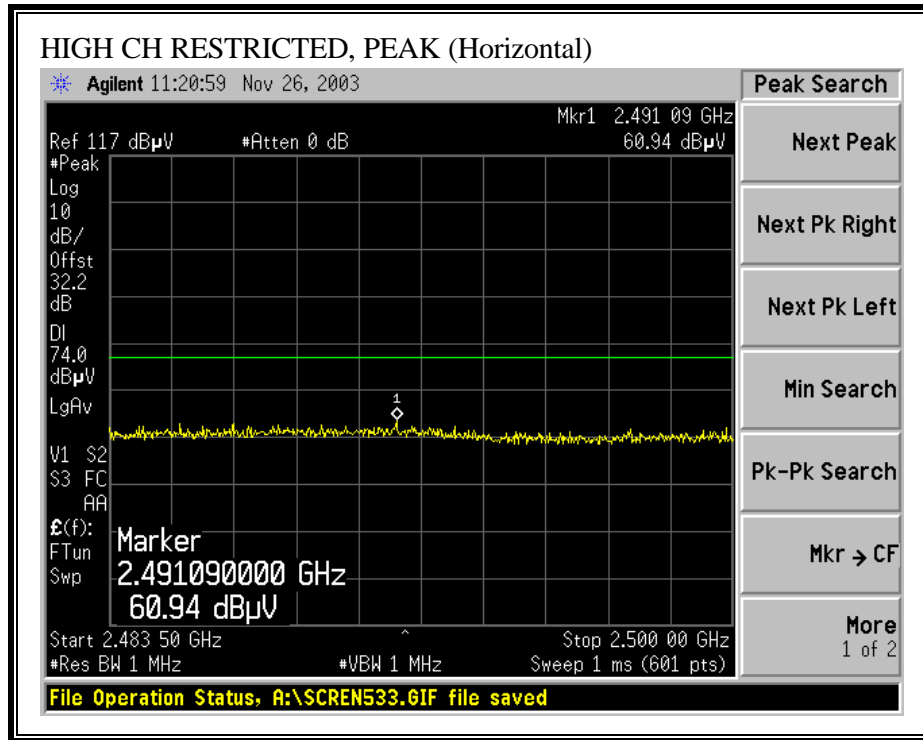

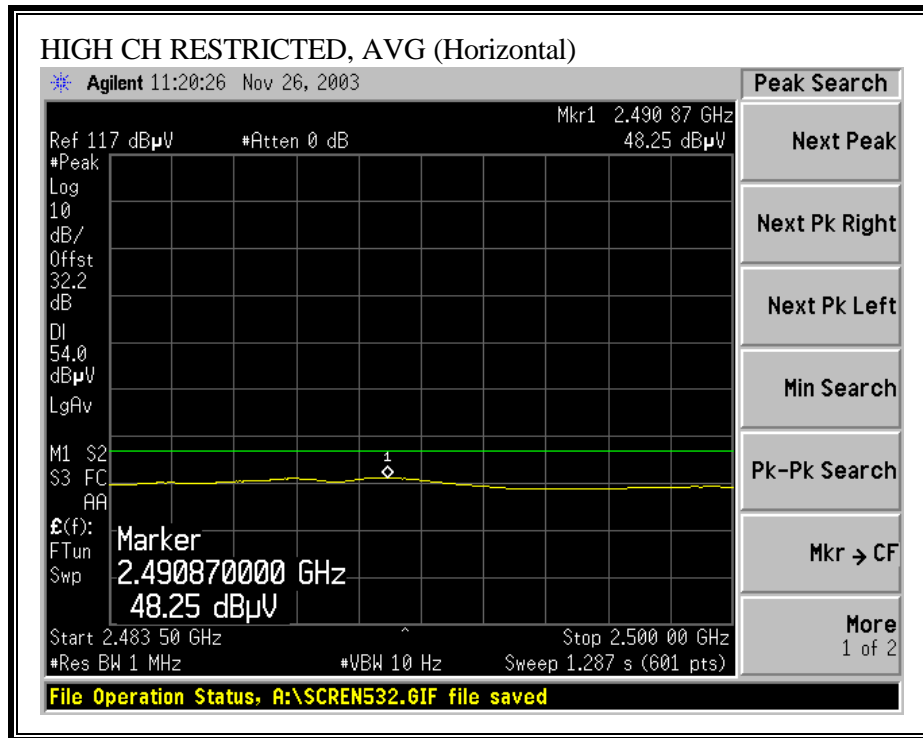

WORST-CASE RESTRICTED BANDEDGE (HIGH CHANNEL, VERTICAL)

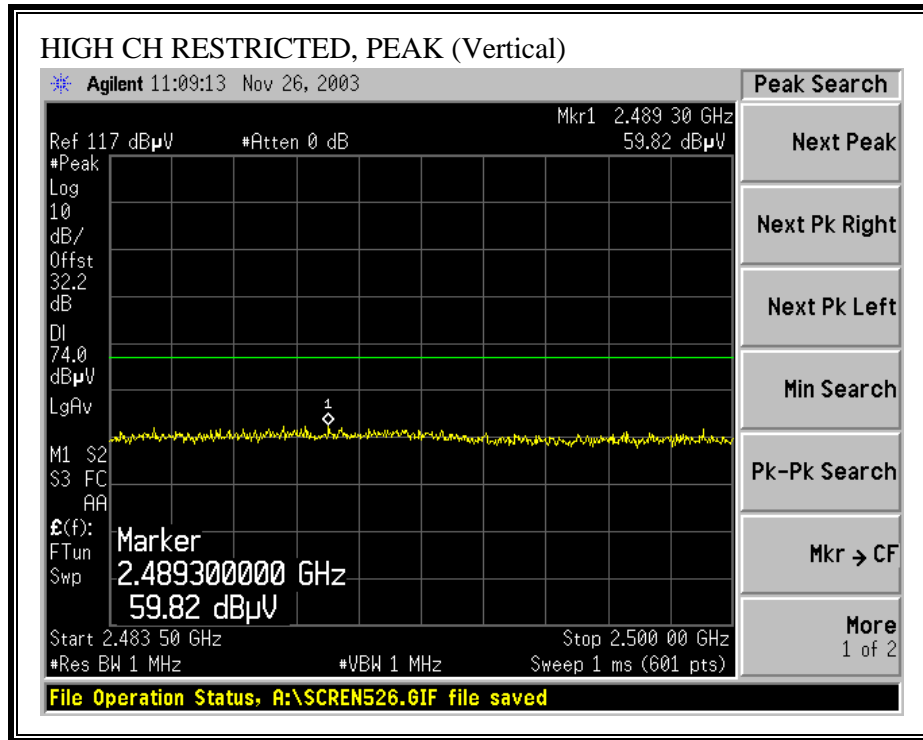

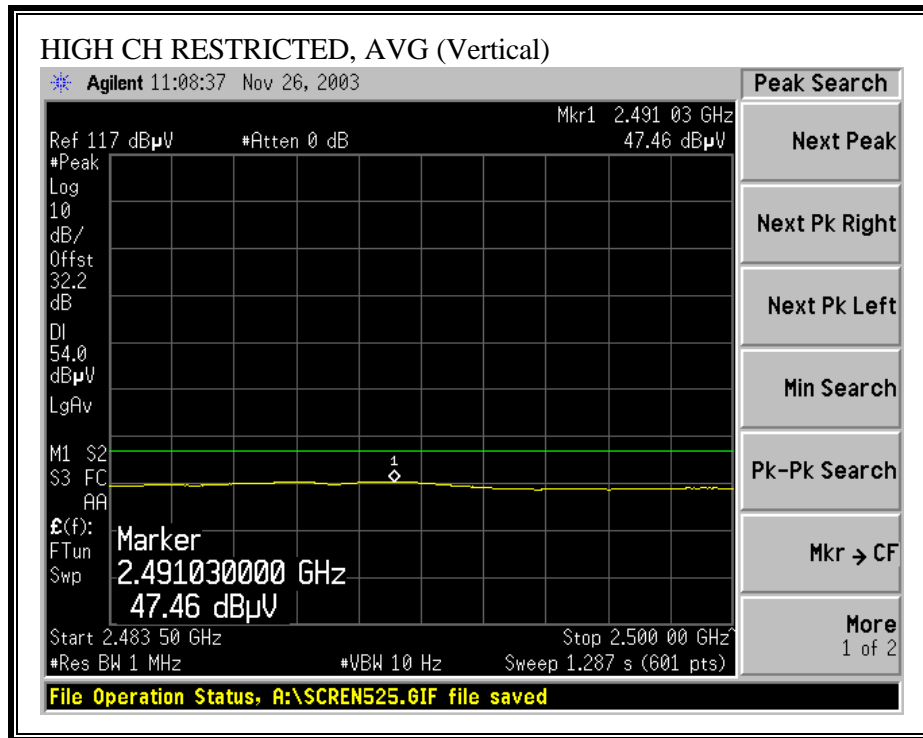

WORST-CASE HARMONICS AND SPURIOUS EMISSIONS

11/26/03 **High Frequency Measurement**
 Compliance Certification Services, Morgan Hill Open Field Site

Test Engr: Yan Zheng
Project #: 03U2392
Company: Intel
EUT Descrip.: 802.11b /g card with Toshiba notebook, with antenna TIAN01
EUT M/N: M200
Test Target: FCC Class B
Mode Oper: Transmitt, Co-Location with worst position, worst configuration & worst channel

Test Equipment:

EMCO Horn 1-18GHz T60; S/N: 2238 @ 3m	Pre-amplifier 1-26GHz T63 Miteq 646456	Spectrum Analyzer Agilent E4446A Analyzer	Horn > 18GHz T117; ARA 18-26GHz; S/N:1013
------------------------------------------	-------------------------------------------	----------------------------------------------	----------------------------------------------

Hi Frequency Cables:
 (2 ft) (2 ~ 3 ft) (4 ~ 6 ft) (12 ft)

Peak Measurements:
 1 MHz Resolution Bandwidth
 1 MHz Video Bandwidth

Average Measurements:
 1 MHz Resolution Bandwidth
 10 Hz Video Bandwidth

f GHz	Dist feet	Read Pk dBuV	Read Avg. dBuV	AF dB/m	CL dB	Amp dB	D Corr dB	HPF	Peak dBuV/m	Avg dBuV/m	Pk Lim dBuV/m	Avg Lim dBuV/m	Pk Mar dB	Avg Mar dB	Notes
Channe 11 (2462MHz)															
4.924	9.8	43.5	32.0	33.2	4.5	-35.3	0.0	1.0	46.8	35.3	74.0	54.0	-27.2	-18.7	V
7.386	9.8	43.8	31.1	36.3	5.7	-34.5	0.0	1.0	52.3	39.6	74.0	54.0	-21.7	-14.4	V
4.924	9.8	43.0	30.3	33.2	4.5	-35.3	0.0	1.0	46.3	33.6	74.0	54.0	-27.7	-20.4	H
7.386	9.8	42.9	30.1	36.3	5.7	-34.5	0.0	1.0	51.4	38.6	74.0	54.0	-22.6	-15.4	H
NO RADIATION EMISSION FOUND ABOVE 7.5GHz															

f	Measurement Frequency	Amp	Preamp Gain	Avg Lim	Average Field Strength Limit
Dist	Distance to Antenna	D Corr	Distance Correct to 3 meters	Pk Lim	Peak Field Strength Limit
Read	Analyzer Reading	Avg	Average Field Strength @ 3 m	Avg Mar	Margin vs. Average Limit
AF	Antenna Factor	Peak	Calculated Peak Field Strength	Pk Mar	Margin vs. Peak Limit
CL	Cable Loss	HPF	High Pass Filter		

7.10.3. WORST-CASE RADIATED EMISSIONS BELOW 1 GHz

SPURIOUS EMISSIONS 30 TO 1000 MHz (WORST-CASE CONFIGURATION, HORIZONTAL)

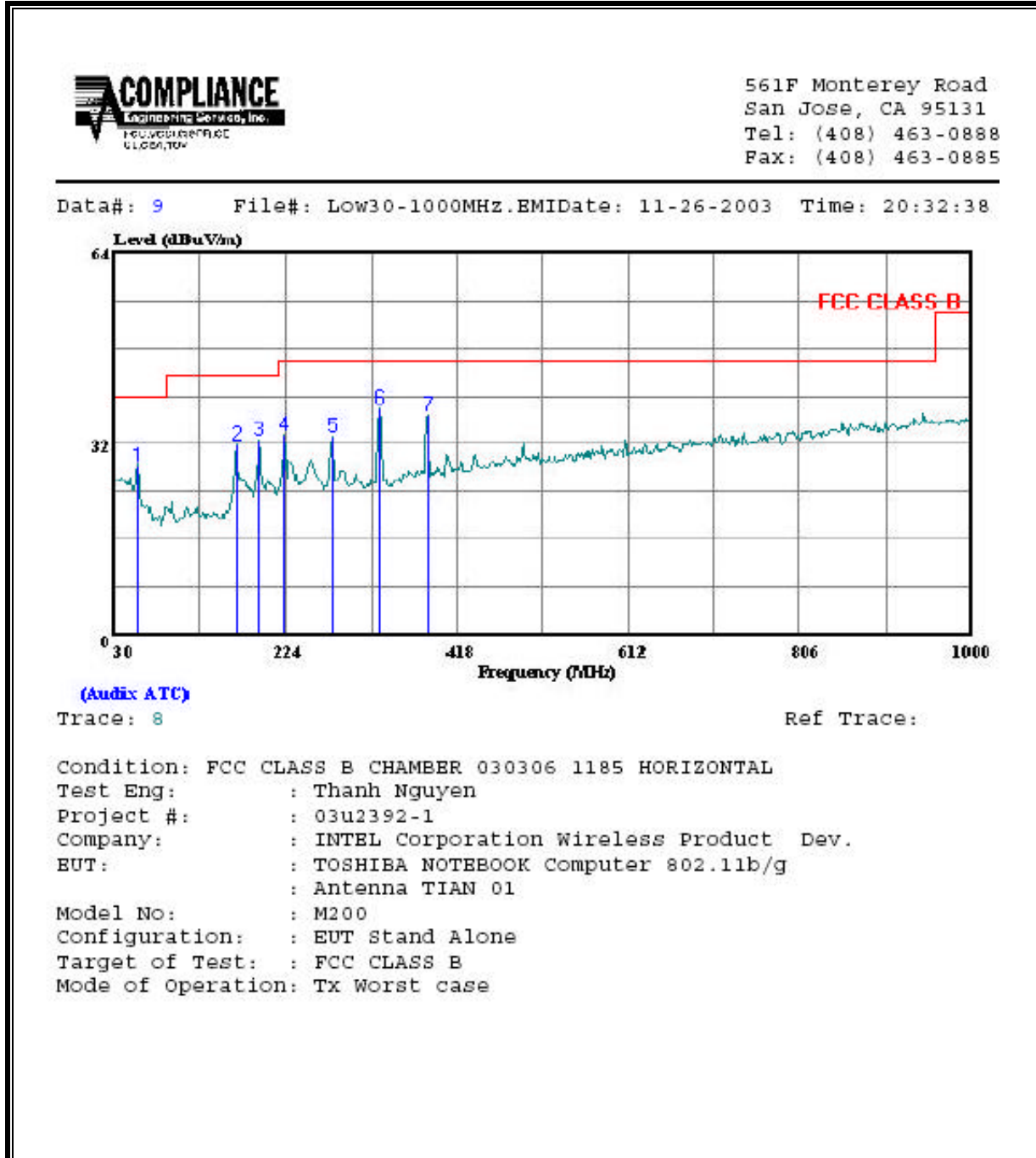

	Freq	Remark	Read Level	Factor	Level	Limit Line	Over Limit
	MHz		dBuV	dB	dBuV/m	dBuV/m	dB
1	57.160	Peak	14.83	13.46	28.29	40.00	-11.71
2	167.740	Peak	21.83	10.08	31.91	43.50	-11.59
3	193.930	Peak	22.08	10.56	32.64	43.50	-10.86
4	223.030	Peak	21.85	11.78	33.63	46.00	-12.37
5	276.380	Peak	19.60	13.56	33.16	46.00	-12.84
6	329.730	Peak	23.29	14.68	37.97	46.00	-8.03
7	385.990	Peak	20.68	16.15	36.83	46.00	-9.17

SPURIOUS EMISSIONS 30 TO 1000 MHz (WORST-CASE CONFIGURATION, VERTICAL)

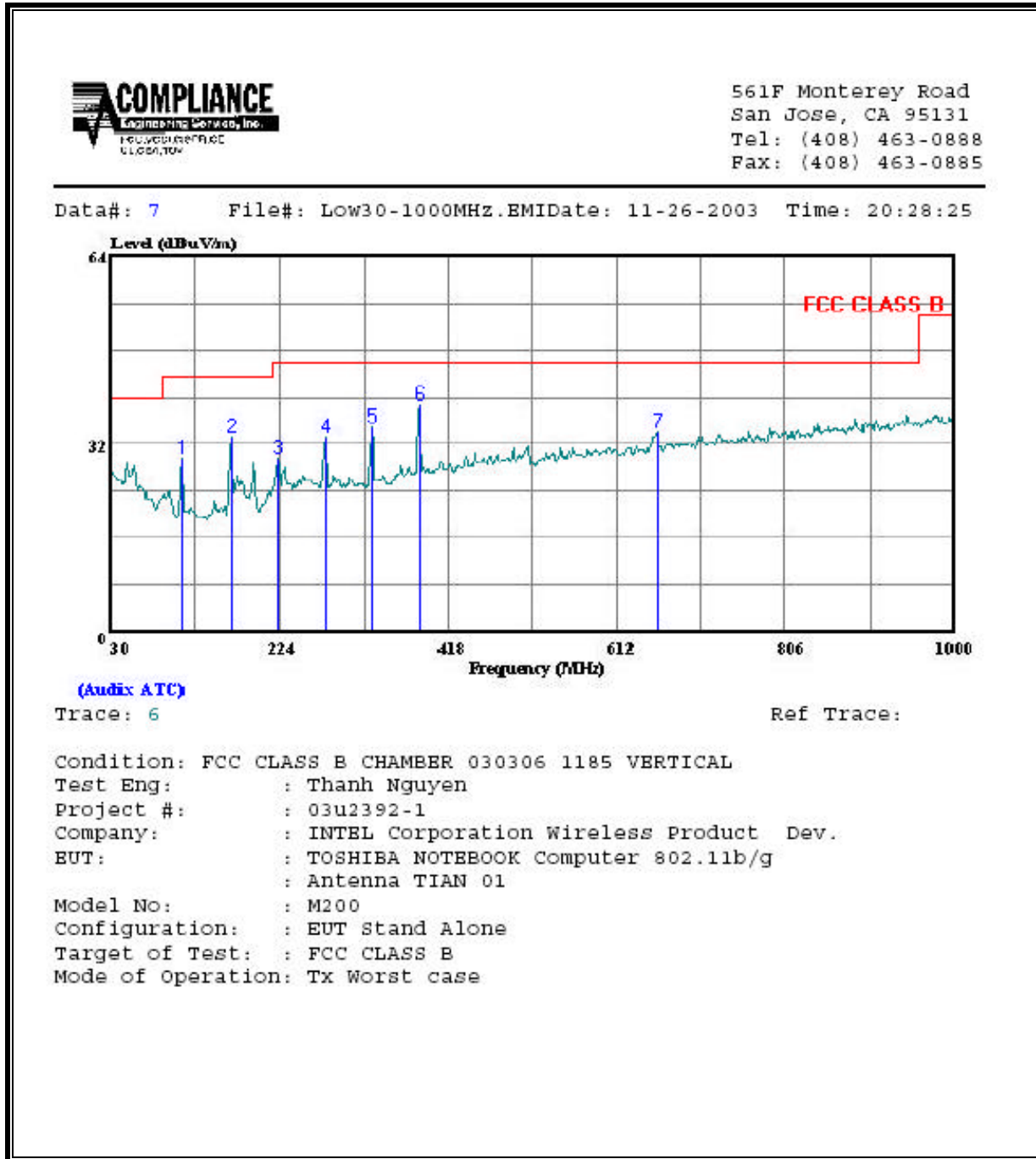

	Freq	Remark	Read Level	Factor	Level	Limit Line	Over Limit
	MHz		dBuV	dB	dBuV/m	dBuV/m	dB
1	111.480	Peak	18.75	10.88	29.63	43.50	-13.87
2	167.740	Peak	23.26	10.08	33.34	43.50	-10.16
3	223.030	Peak	17.93	11.78	29.71	46.00	-16.29
4	276.380	Peak	19.55	13.56	33.11	46.00	-12.89
5	329.730	Peak	20.32	14.68	35.00	46.00	-11.00
6	385.990	Peak	22.71	16.15	38.86	46.00	-7.14
7	657.590	Peak	13.24	20.85	34.09	46.00	-11.91

7.11. POWERLINE CONDUCTED EMISSIONS

LIMIT

§15.207 (a) Except as shown in paragraphs (b) and (c) of this section, for an intentional radiator that is designed to be connected to the public utility (AC) power line, the radio frequency voltage that is conducted back onto the AC power line on any frequency or frequencies within the band 150 kHz to 30 MHz shall not exceed the limits in the following table, as measured using a 50 μ H/50 ohms line impedance stabilization network (LISN). Compliance with the provisions of this paragraph shall be based on the measurement of the radio frequency voltage between each power line and ground at the power terminal.

The lower limit applies at the boundary between the frequency ranges.

Frequency of Emission (MHz)	Conducted Limit (dBuV)	
	Quasi-peak	Average
0.15-0.5	66 to 56*	56 to 46*
0.5-5	56	46
5-30	60	50

*Decreases with the logarithm of the frequency.

TEST PROCEDURE

The EUT is placed on a non-conducting table 40 cm from the vertical ground plane and 80 cm above the horizontal ground plane. The EUT is configured in accordance with ANSI C63.4.

The resolution bandwidth is set to 9 kHz for both peak detection and quasi-peak detection measurements. Peak detection is used unless otherwise noted as quasi-peak.

Line conducted data is recorded for both NEUTRAL and HOT lines.

RESULTS

No non-compliance noted:

6 WORST EMISSIONS

CONDUCTED EMISSIONS DATA (115VAC 60Hz)									
Freq.	Reading			Closs	Limit	EN B	Margin		Remark
(MHz)	PK (dBuV)	QP (dBuV)	AV (dBuV)	(dB)	QP	AV	QP (dB)	AV (dB)	L1 / L2
0.40	42.70	--	--	0.00	58.74	48.74	-16.04	-6.04	L1
0.20	47.08	--	--	0.00	64.51	54.51	-17.43	-7.43	L1
8.46	38.24	--	--	0.00	60.00	50.00	-21.76	-11.76	L1
0.41	44.86	--	--	0.00	58.69	48.69	-13.83	-3.83	L2
0.20	47.18	--	--	0.00	64.51	54.51	-17.33	-7.33	L2
3.60	38.02	--	--	0.00	56.00	46.00	-17.98	-7.98	L2
6 Worst Data									

8. SETUP PHOTOS

ANTENNA PORT CONDUCTED RF MEASUREMENT SETUP

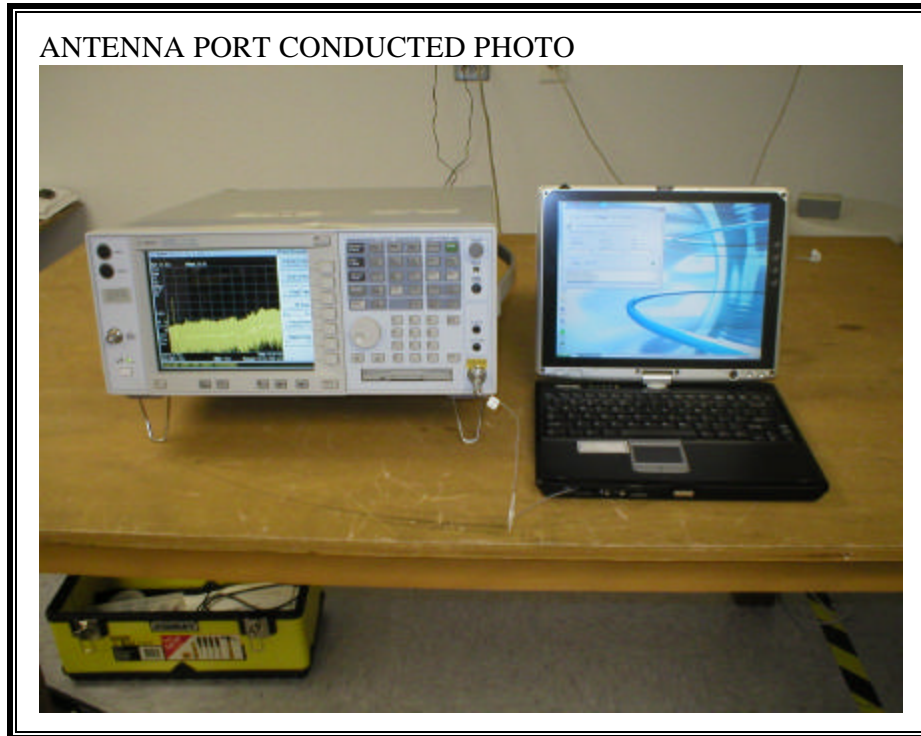

RADIATED RF MEASUREMENT SETUP

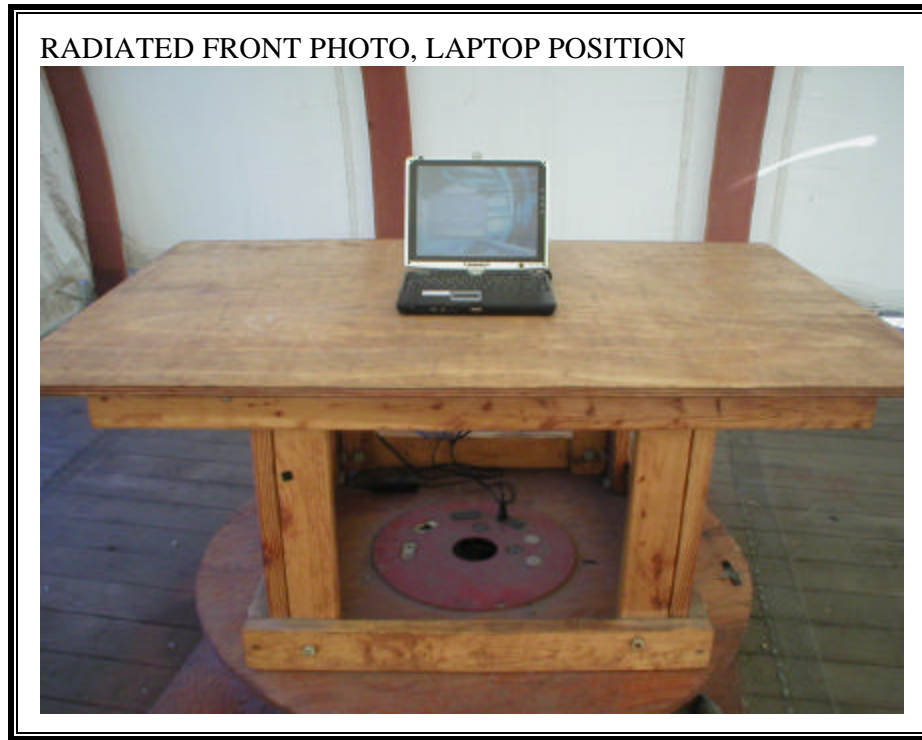

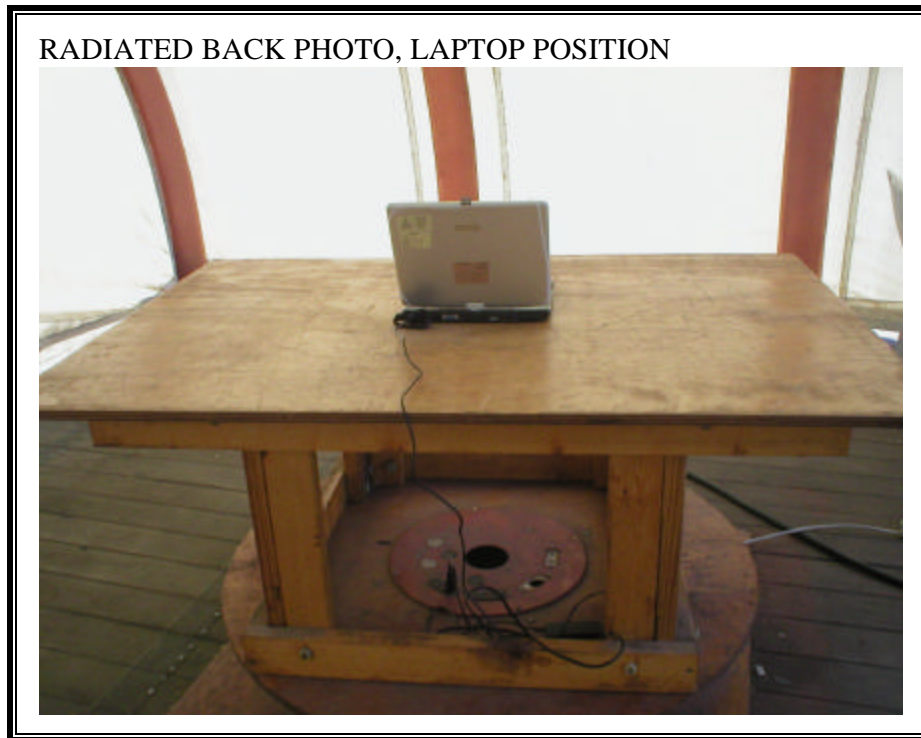

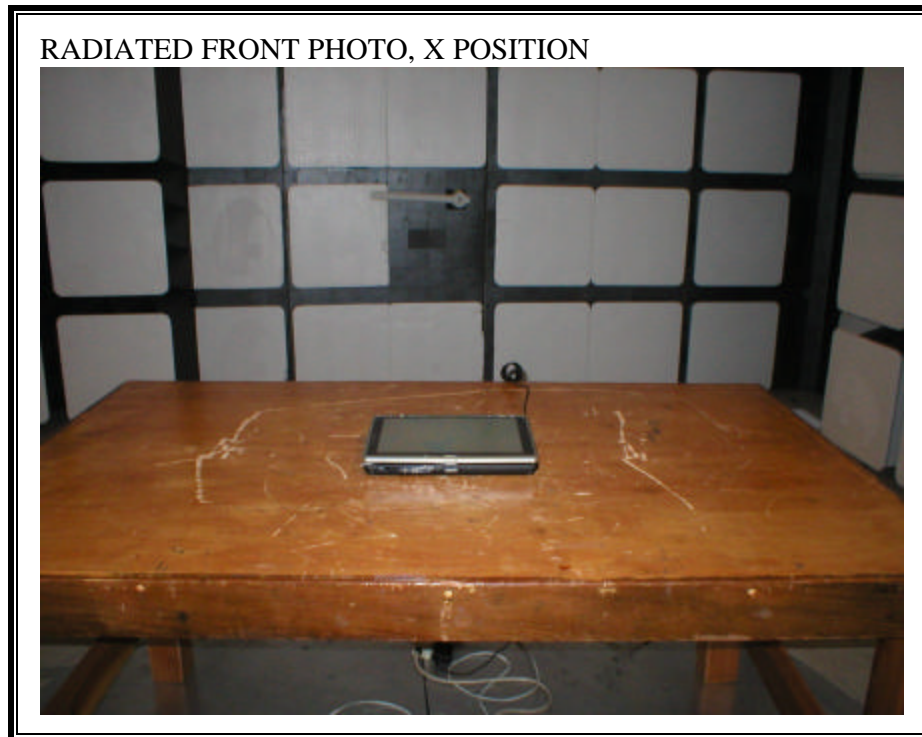



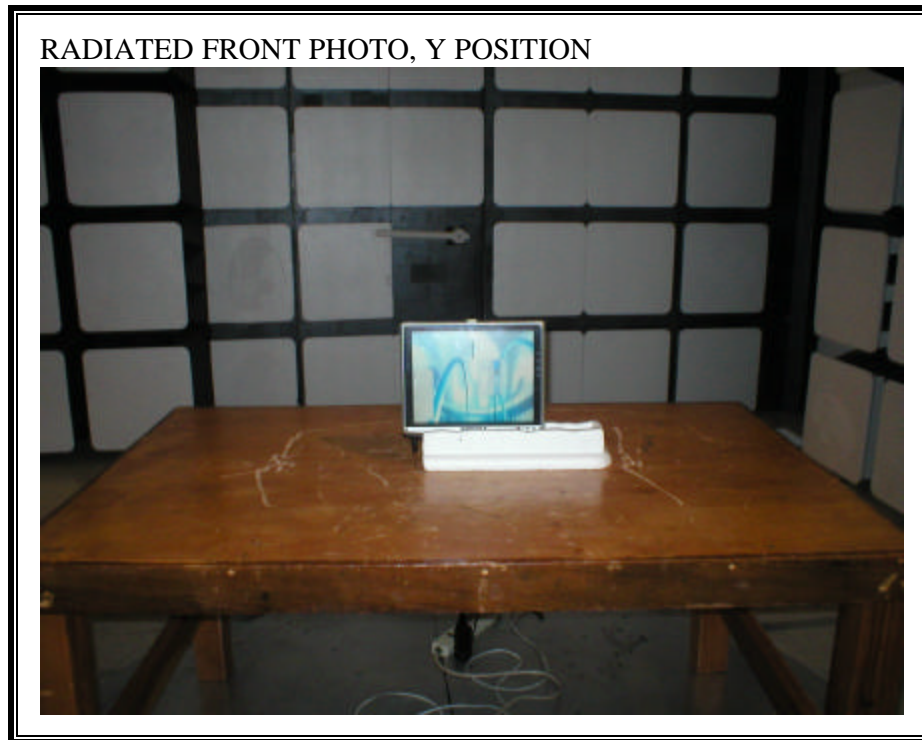

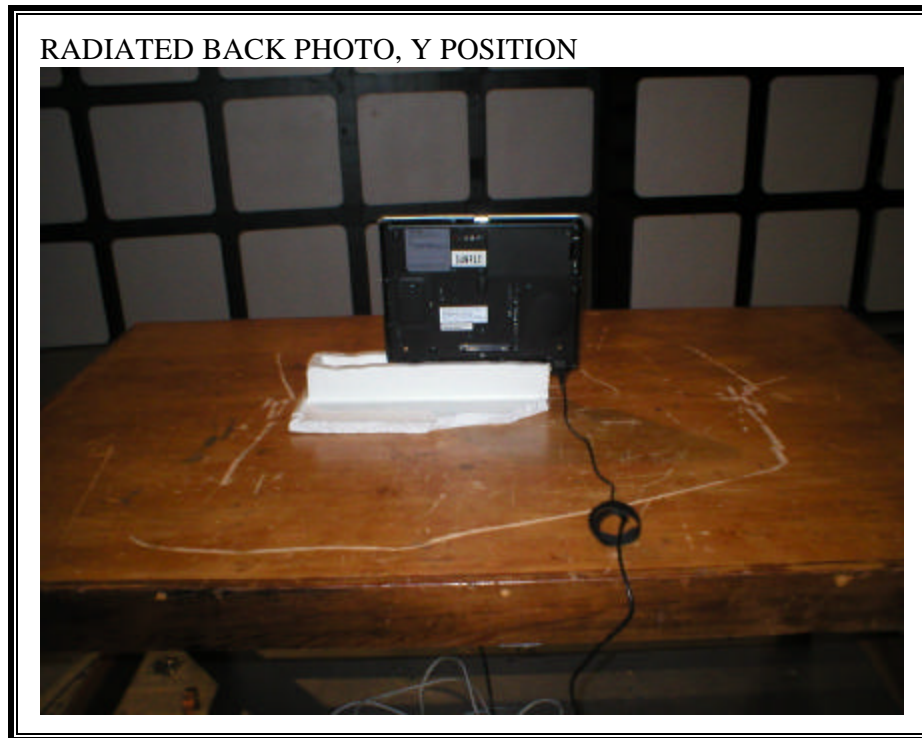

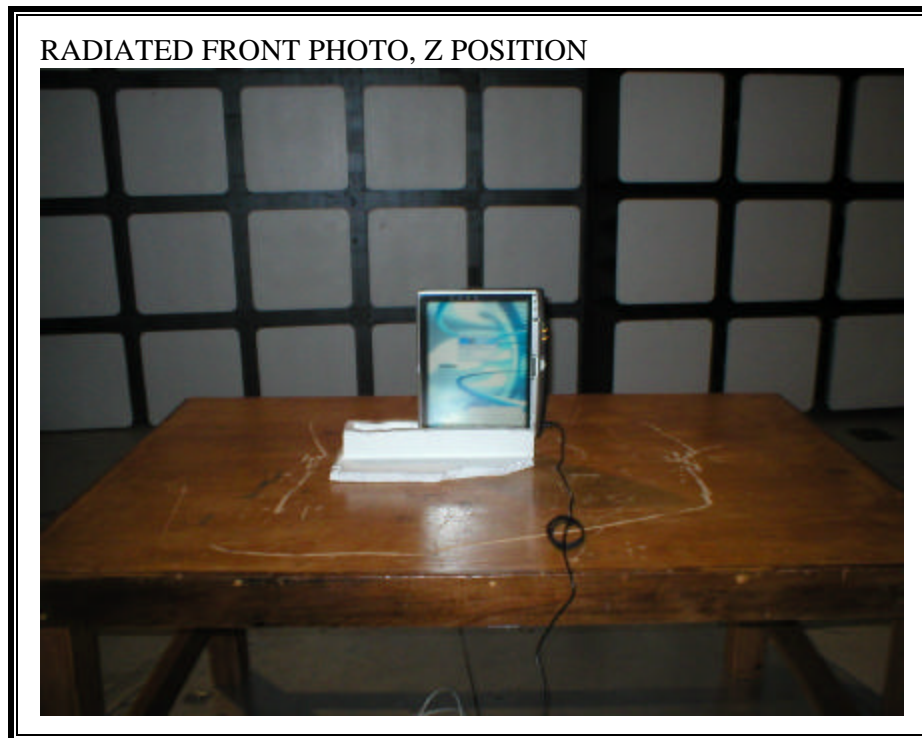

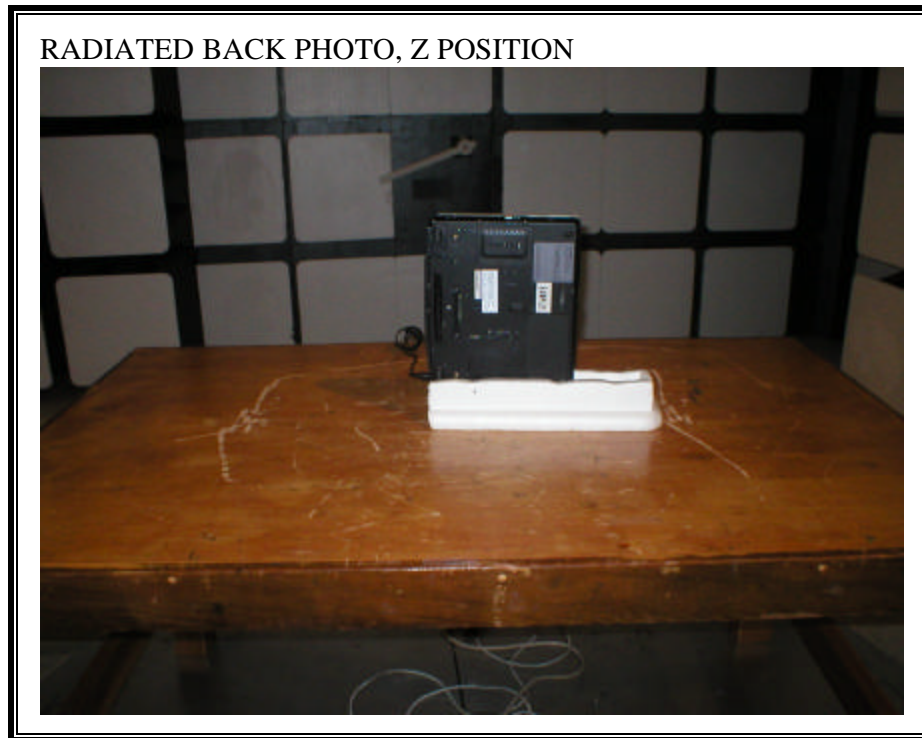

POWERLINE CONDUCTED EMISSIONS MEASUREMENT SETUP



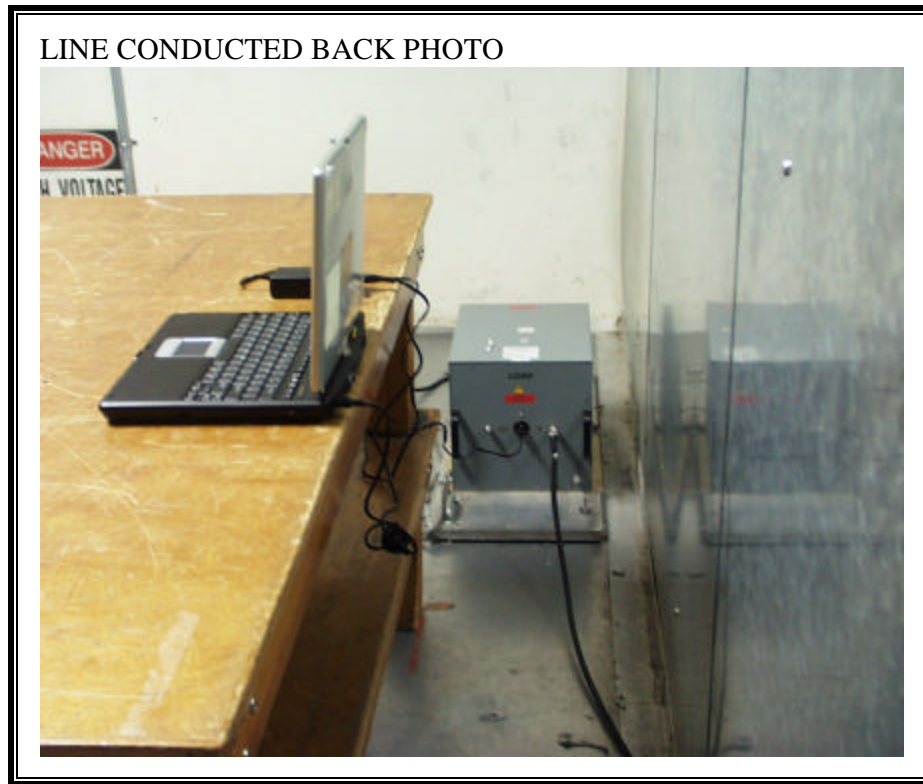

END OF REPORT