



849 NW STATE ROAD 45
NEWBERRY, FL 32669 USA
PH: 888.472.2424 OR 352.472.5500
FAX: 352.472.2030
EMAIL: INFO@TIMCOENGR.COM
[HTTP://WWW.TIMCOENGR.COM](http://WWW.TIMCOENGR.COM)

FCC PART 80, 90, AND ISED RSS-238

TEST REPORT

APPLICANT	KELVIN HUGHES LIMITED
	VOLTAGE, MOLLISON AVENUE
	ENFIELD EN3 7XQ UNITED KINGDOM
FCC ID	CICSCV-A1
IC	1493A-SCVA1
MODEL NUMBER	SCV-A1-10-ADBD
PRODUCT DESCRIPTION	X BAND RADAR
DATE SAMPLE RECEIVED	05/22/2017
DATE TESTED	06/07/2017
TESTED BY	Tim Royer
APPROVED BY	Sid Sanders
TEST RESULTS	<input checked="" type="checkbox"/> PASS <input type="checkbox"/> FAIL

Report Number	Version Number	Description	Issue Date
1062AUT17TestReport	Rev1	Initial Issue	6/15/17
	Rev2	Revised Report	12/1/2017

THE ATTACHED REPORT SHALL NOT BE REPRODUCED EXCEPT IN FULL WITHOUT THE WRITTEN APPROVAL OF TIMCO ENGINEERING, INC.

TABLE OF CONTENTS

GENERAL REMARKS	3
EUT SPECIFICATION.....	4
TEST SETUP INFORMATION.....	4
TEST RESULTS SUMMARY	5
ANTENNA INFORMATION	6
RF POWER OUTPUT	7
MODULATION CHARACTERISTICS	8
MODULATION CHARACTERISTICS PLOTS	9
MODULATION CHARACTERISTICS – PULSE PROFILE – Short Pulse.....	9
MODULATION CHARACTERISTICS – PULSE PROFILE - Medium Pulse.....	10
MODULATION CHARACTERISTICS – PULSE PROFILE – Long Pulse	11
MODULATION CHARACTERISTICS – PULSE PROFILE – Long Pulse	12
MODULATION CHARACTERISTICS – PULSE INTERVAL	13
OCCUPIED BANDWIDTH.....	14
OCCUPIED BANDWIDTH PLOT(S)	15
OCCUPIED BANDWIDTH - 99 PERCENT	15
OCCUPIED BANDWIDTH PLOT(S)	16
OCCUPIED BANDWIDTH – 40dB	16
SPURIOUS EMISSIONS AT ANTENNA TERMINALS (CONDUCTED)	17
FIELD STRENGTH OF SPURIOUS EMISSIONS	18
FIELD STRENGTH OF SPURIOUS EMISSIONS	19
FREQUENCY STABILITY.....	20
STATE OF THE MEASUREMENT UC.....	21
EQUIPMENT LIST	22

GENERAL REMARKS

The attached report shall not be reproduced except in full without the written permission of Timco Engineering Inc.

Summary

The device under test does:

- Fulfill the general approval requirements as identified in this test report and was selected by the customer.
- Not fulfill the general approval requirements as identified in this test report.

Attestations

This equipment has been tested in accordance with the standards identified in this test report. To the best of my knowledge and belief, these tests were performed using the measurement procedures described in this report.

All instrumentation and accessories used to test products for compliance to the indicated standards are calibrated regularly in accordance with ISO 17025 requirements.

I attest that the necessary measurements were made at:

Timco Engineering Inc.
849 NW State Road 45
Newberry, FL 32669



Tested by:

Name and Title: Tim Royer, Project Manager/Testing Engineer

Date: 6/12/2017

Reviewed and approved by: _____

Name and Title: Sid Sanders, Engineer



Date: 6/15/17

Applicant: KELVIN HUGHES LIMITED
FCC ID: CICSCV-A1
IC: 1493A-SCVA1
Report: 1062AUT17TestReport_Rev2

[Table of Contents](#)

EUT SPECIFICATION

EUT Description	X BAND RADAR
FCC ID	CICSCV-A1
IC	1493A-SCVA1
Model Number	SCV-A1-10-ADBD
Operating Frequency	9.5 – 9.4GHz
Type of Emission	PON
EUT Power Source	<input type="checkbox"/> 110–120Vac/50– 60Hz – Shipboard only
	<input checked="" type="checkbox"/> DC Power (24V)
	<input type="checkbox"/> Battery Operated Exclusively
Test Item	<input type="checkbox"/> Prototype
	<input checked="" type="checkbox"/> Pre-Production
	<input type="checkbox"/> Production
Type of Equipment	<input type="checkbox"/> Fixed
	<input checked="" type="checkbox"/> Mobile
	<input type="checkbox"/> Portable
Antenna Gain	20-22 dBi

TEST SETUP INFORMATION

Test facility	Timco Engineering, Inc. 849 NW State Road 45 Newberry, FL 32669
Test Condition	Temperature: 26°C Relative humidity: 50%. Barometer: 1012.5mb
Modifications	None
Test Exercise	The EUT was placed in continuous transmit mode of operation
Applicable Standards	ANSI/TIA 603-D: 2010, FCC CFR 47, Part 80, Part 90, ISED RSS-238, ISED RSS-GEN

TEST RESULTS SUMMARY

Test	Regulatory Body	Rule	Result
RF Power Output	FCC	Part 80.215(a)(3)	Pass
		Part 90.205(r)	Pass
	ISED	RSS-238 Section 4.2	Pass
Modulation Characteristics	FCC	Part 90.207	Pass
	ISED	RSS 238 3.2(a)	Pass
Occupied Bandwidth	FCC	Part 80.205(a)	Pass
		Part 90.209, Part 90.210(b)	Pass
	ISED	RSS 238 3.2(c)	Pass
Spurious Emissions at Antenna Terminals	FCC	Part 80.211(f)	Pass
		Part 90.210, Part 90.215	Pass
	ISED	RSS 238 4.3	Pass
Field Strength of Spurious Emissions	FCC	Part 80.211(f)	Pass
		Part 90.210, Part 90.215	Pass
	ISED	RSS 238 4.3	Pass
Frequency Stability	FCC	Part 80.209(b)	Pass
		Part 90.213	Pass
	ISED	RSS-238 4.1	Pass

ANTENNA INFORMATION

Rule Part No.: RSS-238 Section 2

TYPE:	
Antenna length Size	530mm
Antenna Gain	20-22 dBi
Beamwidth_horizontal	4°
Beamwidth_vertical	20°-22° (Typical)
Side-lobe suppression	0
Back-lobe suppression	0
Polarization	Horizontally polarized linear array

RF POWER OUTPUT

Rule Part No.: Part 2.1046(a), Part 80.215(a) (3), Part 90.205(r), RSS-238 Section 4.2

Requirements:

Part 90.205(r) – Power will be authorized on a case-by-case basis.

RSS-238 Section 4.2 – The output power shall not exceed 60 kW and the antenna gain shall not exceed 35 dBi.

Method of Measurement: RF power is measured by connecting a 50-ohm, Peak Power meter to the RF output connector.

Test Setup Diagram:

b) Method of Measurement

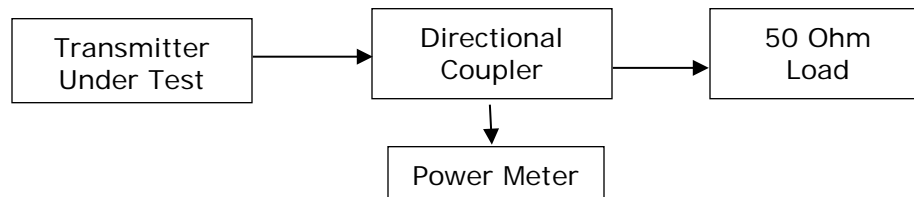

Test Data:

OUTPUT POWER:

Pulse Type	Peak Power (dBm)	Peak Power (Watts)	Duty Cycle (%)	Average Power (Watts)
Short	50.065	101.51	6.942%	7.05
Medium	50.044	101.02	6.942%	7.01
Long	50.165	103.87	6.942%	7.21

Results Meet Requirements

MODULATION CHARACTERISTICS

Rule Part No.: Part 90.207, RSS-238 Section 3.2(a)

Requirements: None

Method of Measurement: Modulation Characteristics are reported using a 50-ohm peak power sensor or spectrum analyzer in zero span mode. A directional coupler is used to sample output power.

Test Setup Diagram:

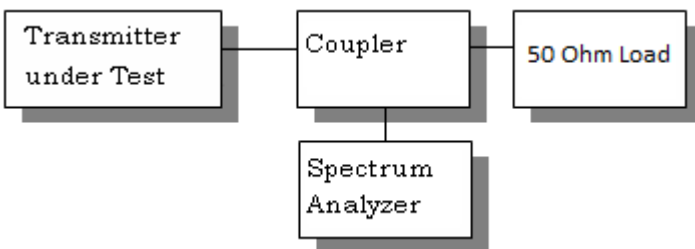

The device under test is capable of multiple pulse styles and durations.

Detailed specifications are contained in “product specifications” manual.

Plots of these pulse groups are shown below.

Sub Pulse Type	Pulse Width (us)	Rise Time (ns)
Short	0.103	51.600
Medium	5.000	52.100
Long	24.930	43.100

Ontime Per Period (us)	Period (us)	Duty Cycle (%)
30.033	433	6.942%

Results Meet Requirements

Applicant: KELVIN HUGHES LIMITED
 FCC ID: CICSCV-A1
 IC: 1493A-SCVA1
 Report: 1062AUT17TestReport_Rev2

[Table of Contents](#)

MODULATION CHARACTERISTICS PLOTS

MODULATION CHARACTERISTICS – PULSE PROFILE – Short Pulse

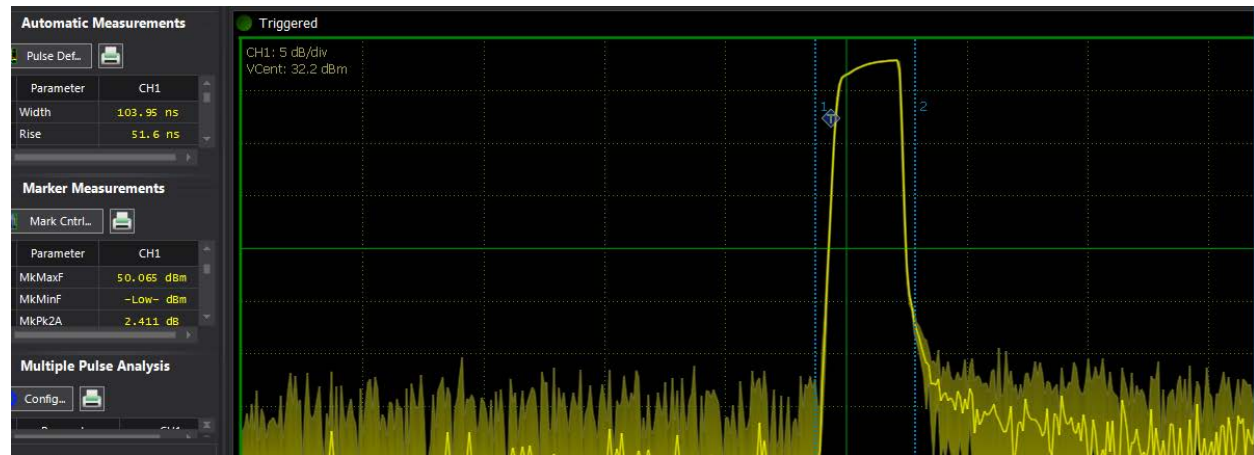

Results Meet Requirements

MODULATION CHARACTERISTICS PLOTS

MODULATION CHARACTERISTICS – PULSE PROFILE - Medium Pulse

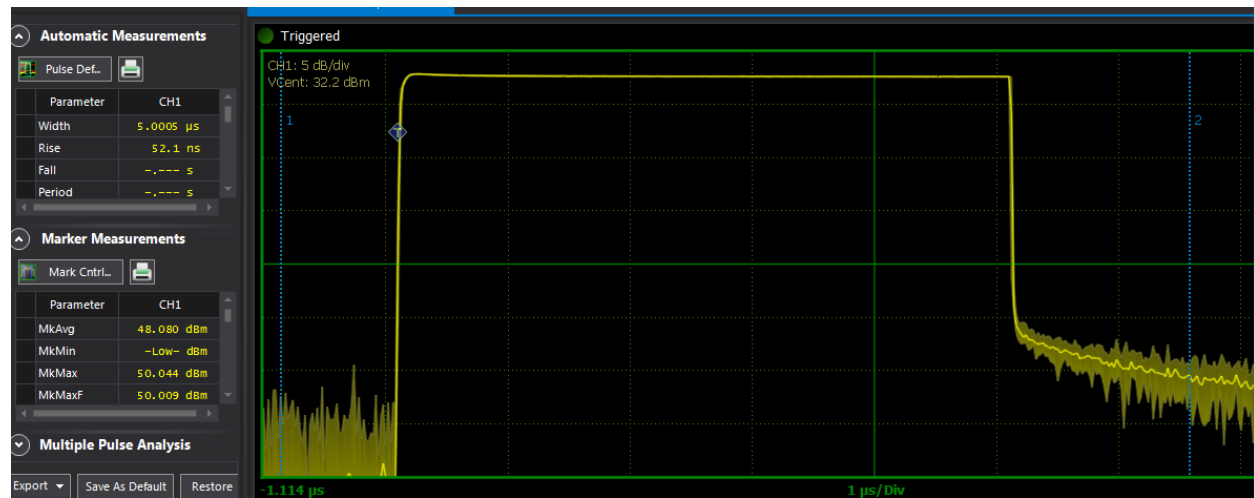

Results Meet Requirements

MODULATION CHARACTERISTICS PLOTS

MODULATION CHARACTERISTICS – PULSE PROFILE – Long Pulse

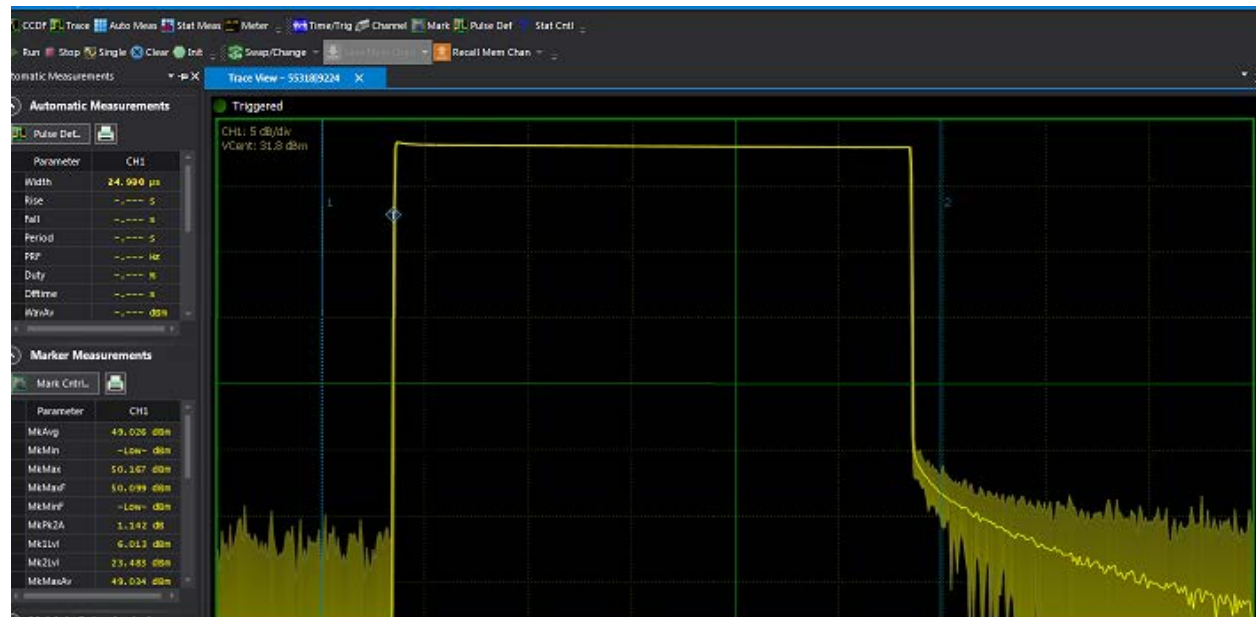

Results Meet Requirements

MODULATION CHARACTERISTICS PLOTS

MODULATION CHARACTERISTICS – PULSE PROFILE – Long Pulse

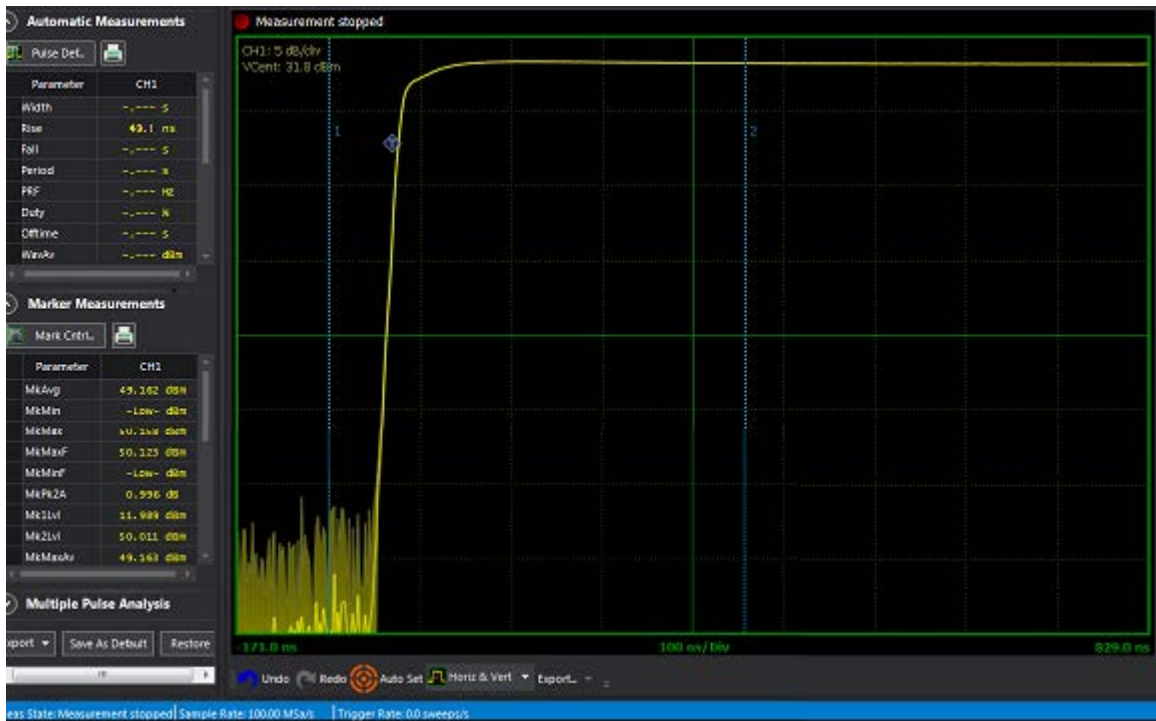

Results Meet Requirements

MODULATION CHARACTERISTICS PLOTS

MODULATION CHARACTERISTICS – PULSE INTERVAL

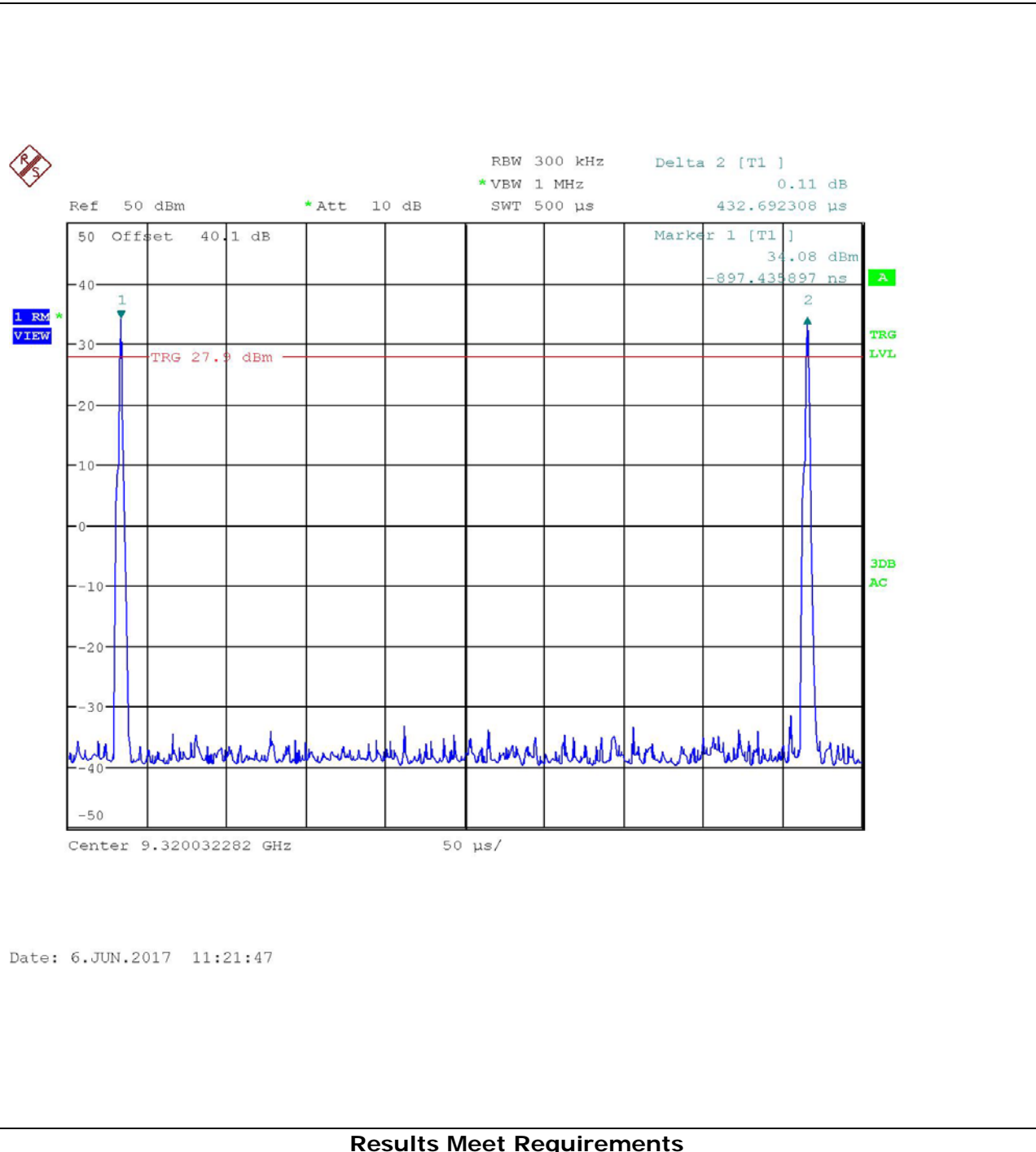

OCCUPIED BANDWIDTH

Rule Part No.: Part 90.209, Part 90.210(b), Part 80.205(a), RSS 238 3.2(c)

Requirements:

Part 80.205(a): Emissions must remain within the band

Part 90.209: Subject to case-by-case review

RSS 238 3.2(c): 40dB bandwidth measurements must be reported

Method of Measurement: Measurements were made in accordance with standard listed above.

Block Diagram:

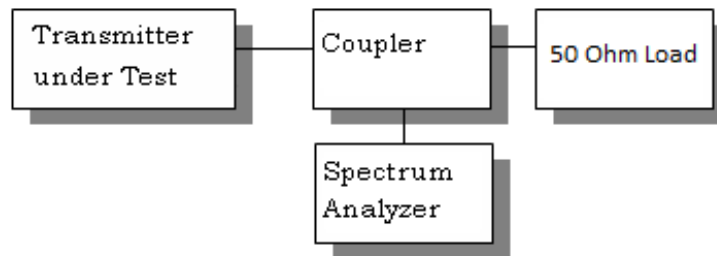

Test Data:

Measurement Type	Occupied Bandwidth (MHz)
99%	13.815
40dB	31.63

Results Meet Requirements

OCCUPIED BANDWIDTH PLOT(S)

OCCUPIED BANDWIDTH - 99 PERCENT

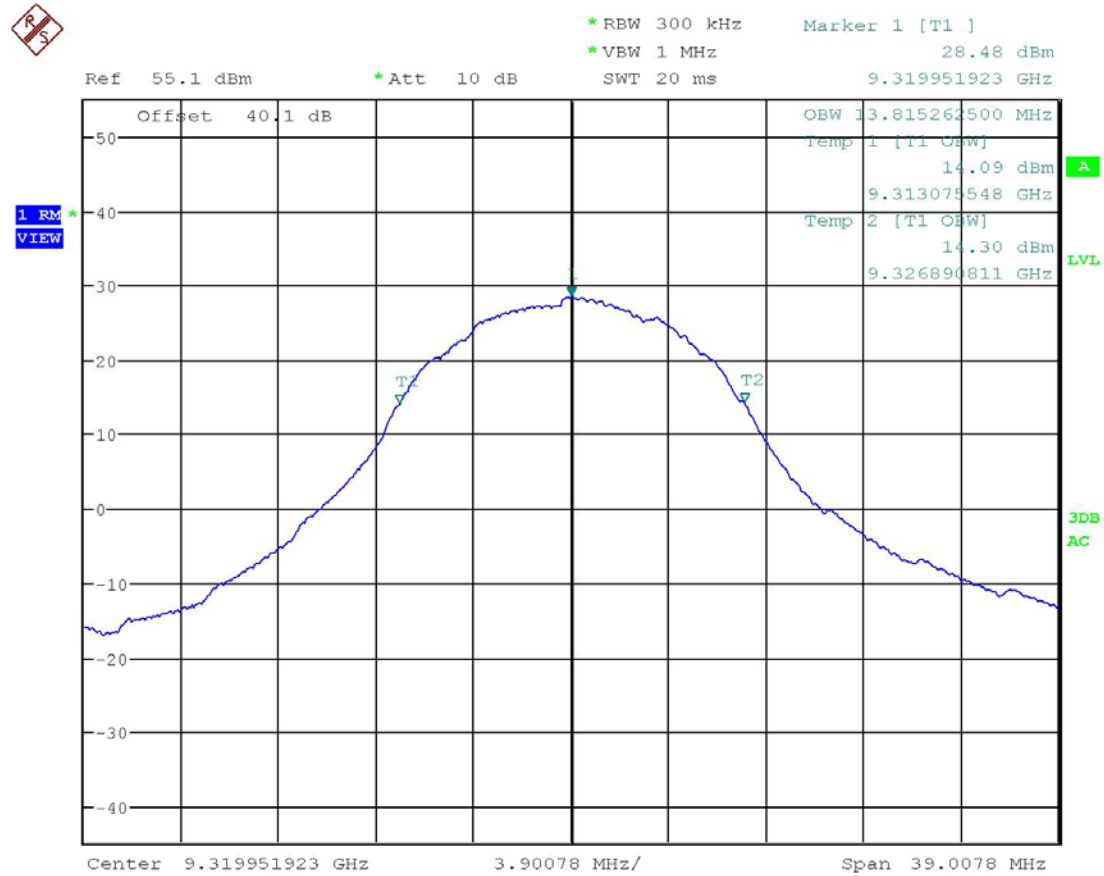

Date: 6.JUN.2017 14:15:24

Results Meet Requirements

OCCUPIED BANDWIDTH PLOT(S)

OCCUPIED BANDWIDTH – 40dB

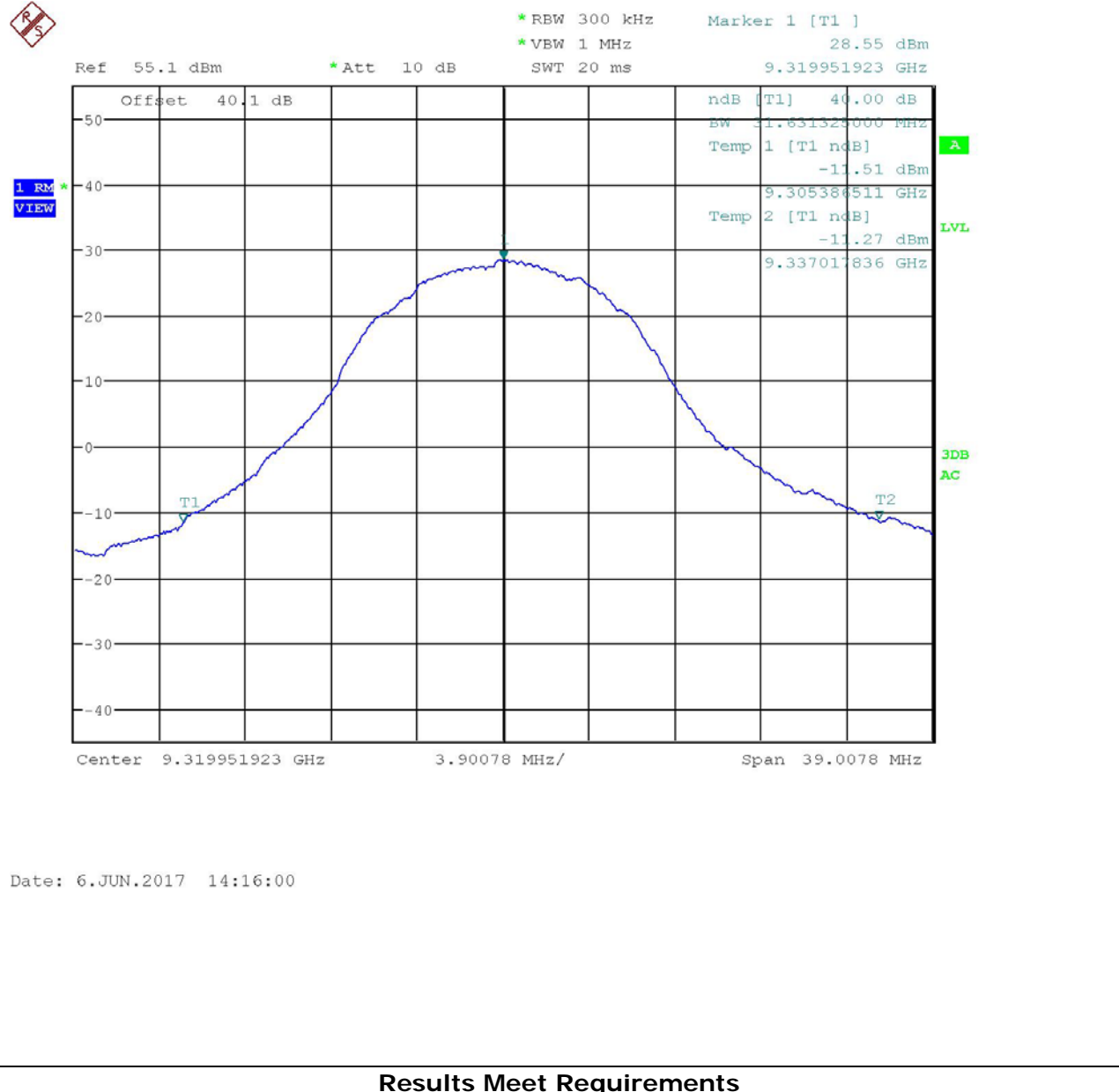

SPURIOUS EMISSIONS AT ANTENNA TERMINALS (CONDUCTED)

Rule Part No.: Part 2.1051(a), Part 90.210, Part 90.215, Part 80.211(f), RSS 238 4.3

Requirements:

Part 80.211(f): $43 + 10\log(\text{mean power in watts})$

Part 90.210(c): $43 + 10\log(\text{mean power in watts})$

RSS 238 4.3: 20dB per decade from 40 dB bandwidth, not more than 60 dB

Method of Measurement: Measurements were made in accordance with standards listed.

The mean power was calculated based on the standard formula for radar systems:
 $P_a = P_m \cdot T_d \cdot f_r$. Where T_d is pulse duration, P_m is peak power, and f_r is pulse rep rate.

Block Diagram:

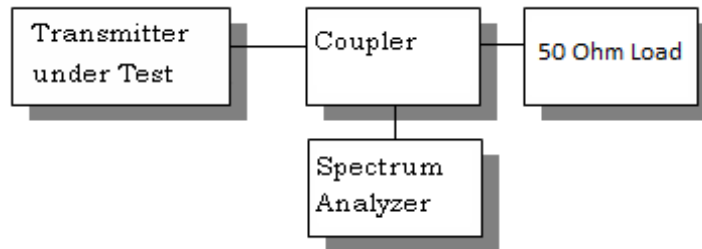

Test Data:

Mean Power (Watts)	Emission Frequency (MHz)	Emission Level (dBc)	FCC Limit (dBc)	FCC Margin (dB)	IC Limit (dBc)	IC Margin (dB)
7.21	454.37	-53.09	-51.58	40.09	-66.21	36.88
7.21	628.47	-52.59	-51.58	39.59	-63.39	39.20
7.21	713.97	-52.17	-51.58	39.17	-62.28	39.89
7.21	1709.60	-52.19	-51.58	39.19	-54.70	47.49
7.21	3258.65	-50.64	-51.58	37.64	-49.10	51.54
7.21	5551.90	-53.28	-51.58	40.28	-44.47	58.81

Results Meet Requirements

FIELD STRENGTH OF SPURIOUS EMISSIONS

Rule Parts. No.: FCC Part 2.1053, Part 90.210, Part 90.215, Part 80.211(f), RSS-238 4.3

Requirements:

Part 80.211(f): $43 + 10 \log$ (mean power in watts)

Part 90.210(c): $43 + 10 \log$ (mean power in watts)

RSS 238 4.3: 20dB per decade from 40 dB bandwidth, not more than 60 dB

METHOD OF MEASUREMENT: The tabulated data shows the results of the radiated field strength emissions test. The spectrum was scanned from 30 MHz to at least the tenth harmonic of the fundamental or 40 GHz. This test was conducted per the standard listed above using the substitution method.

Test Setup Diagram:

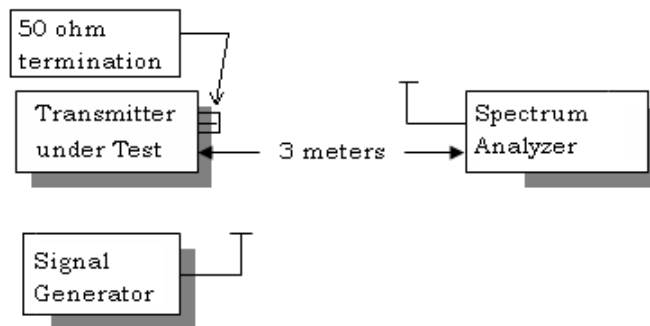

FIELD STRENGTH OF SPURIOUS EMISSIONS

Test Data:

Emission Frequency MHz	Antenna Polarity	ERP (dBmW)	Margin dB
3.55	V	-55.02	65.35
16.22	V	-67.74	78.07
42.53	V	-48.93	59.26
53.43	H	-52.86	63.19
53.43	V	-52.74	63.07
61.33	H	-50.21	60.54
61.33	V	-48.29	58.62
65.42	H	-53.13	63.46
71.95	V	-55.59	65.92
166.49	V	-49.45	59.78
232.05	V	-53.91	64.24
265.38	V	-49.60	59.93
266.66	H	-54.43	64.76
560.25	H	-46.81	57.14
2280.40	H	-34.70	45.03
7974.00	V	-31.75	42.08
11951.90	H	-24.73	35.06
13695.00	V	-26.75	37.08
14512.60	H	-23.95	34.28
19974.35	V	-18.13	28.46

FREQUENCY STABILITY

Rule Parts. No.: FCC Part 2.1055, Part 90.213, Part 80.209(b), RSS-238 4.1

Requirements

Part 80.209(b): Emissions must not be closer than $1.5/T$ MHz from the band edges, where T is the pulse duration in microseconds

Duration of shortest pulse is 103.95 ns

Emissions must not be closer than $1.5 / 103.95 = 14.4$ MHz from the band edge

Part 90.213(a) Specified in station authorization

RSS 238 4.1: The carrier frequency shall not depart from the reference frequency in excess of 800 ppm for equipment which operates in the band 2900-3100 MHz nor in excess of 1250 ppm for equipment which operates in the band 9225-9500 MHz.

Method of Measurements: The test procedure was modified to measure spurious emissions radiated from a terminating load.

Test Data:

Temperature (°C)	Frequency (MHz)	Error (ppm)	Margin (ppm)
25 (ref)	9288.3		
-30	9292.9	492	758
-20	9292.8	484	766
-10	9291.0	285	965
0	9290.7	256	994
10	9290.4	228	1022
20	9289.7	142	1108
30	9289.1	85	1165
40	9288.3	0	1250

Results Meet Requirements

Applicant: KELVIN HUGHES LIMITED
 FCC ID: CICSCV-A1
 IC: 1493A-SCVA1
 Report: 1062AUT17TestReport_Rev2

[Table of Contents](#)

STATE OF THE MEASUREMENT UC

The data and results referenced in this document are true and accurate. The measurement uncertainty was calculated for all measurements listed in this test report according To CISPR 16-4 or ENTR 100-028 Specification for radio disturbance and immunity measuring apparatus and methods – Part 4: “Uncertainty in EMC Measurements” and is documented in the Timco Engineering, Inc. quality system according to DIN EN ISO/IEC 17025. Furthermore, component and process variability of devices similar to that tested may result in additional deviation. The manufacturer has the sole responsibility of continued compliance of the device. Hereafter the best measurement capability for Timco Engineering, Inc. is reported:

Test Items	Measurement Uncertainty	Notes
RF Frequency Accuracy	± 49.5 Hz	(1)
RF Conducted Power	±0.93dB	(1)
Conducted spurious emission of transmitter valid up to 40GHz	±1.86dB	
Occupied Bandwidth	±2.65%	
Audio Frequency Response	±1.86dB	
Modulation limiting	±1.88%	
Radiated RF Power	±1.4dB	
Maximum frequency deviation: Within 300 Hz and 6kHz of audio freq.	±1.88%	
Within 6kHz and 25kHz of audio Freq.	±2.04%	
Rad Emissions Sub Meth up to 26.5GHz	±2.14dB	
Rad Emissions Sub Meth up to 18-40 GHz	±2.04%	
Adjacent channel power	±1.47dB	(1)
Transient Frequency Response	±1.88%	
Temperature	±1.0°C	(1)
Humidity	±5.0%	

This uncertainty represents an expanded uncertainty expressed at approximately the 95% confidence level using a coverage factor of k=1.96.

EQUIPMENT LIST

Device	Manufacturer	Model	Serial Number	Cal/Char Date	Due Date
Temperature Chamber LARGE	Tenney Engineering	TTRC	11717-7	09/01/16	09/01/18
Sweep/Signal Generator	Anritsu	68369B	985112	10/28/15	10/28/17
USB Peak Power Sensor 50 MHz to 18 GHz	Boonton	55318	9224	09/13/16	09/13/18
EMI Test Receiver R & S ESU 40 Chamber	Rohde & Schwarz	ESU 40	100320	04/01/16	04/01/18
Antenna: Biconical 1096 Chamber	Eaton	94455-1	1096	07/14/15	07/14/17
Antenna: Log-Periodic 1122 CHAMBER	Electro-Metrics	LPA-25	1122	07/14/15	07/14/17
Antenna: Double-Ridged Horn/ETS Horn 2	Panashield	3M	N/A	04/25/16	12/31/17
Software: Field Strength Program	ETS-Lindgren	3117	00041534	03/01/17	03/01/19
EMI Test Receiver R & S ESU 40 Chamber	Timco	N/A	Version 4.10.7.0	N/A	N/A
EMI Test Receiver R & S ESU 40 Chamber	Rohde & Schwarz	ESU 40	100320	04/01/16	04/01/18
Coaxial Cable - Chamber 3 cable set (Primary)	Micro-Coax	Chamber 3 cable set (Primary)	KMKM-0244-01; KMKM-0670-00; KFKF-0198-01	08/09/16	08/09/18
Bore-sight Antenna Positioning Tower	Sunol Sciences	TLT2	N/A	N/A	N/A
Coaxial Cable #101 - NMNM-0180-01 Aqua DC-40G	Micro-Coax	UFB311A-0-0720-50U50U	225362-002 (#101)	07/18/16	07/18/18
Attenuator SMA 6dB 10W DC-18G	Pasternack	PE7016-6	22	06/22/2015	06/22/2017
Attenuator SMA 30dB 5W DC-18G	Pasternack	PE7013-30	23	06/22/2015	06/22/2017

END OF REPORT