



**RF EXPOSURE PART 2 TEST REPORT**

**Applicant Name:**  
 Microsoft Corporation  
 Microsoft Corporation Way  
 Redmond, WA 98052 USA

**Date of Testing:**  
 02/14/2025 – 02/28/2025  
**Test Site/Location:**  
 Element, Columbia, MD, USA  
**Document Serial No.:**  
 1M2503050023-03.C3K (Rev3)

**FCC ID:** C3K00002101

**APPLICANT:** MICROSOFT CORPORATION

**DUT Type:** Wireless Module  
**Application Type:** Class II Permissive Change  
**FCC Rule Part(s):** CFR §2.1093  
**Model:** HWB-Q93  
**Host Device Model Name:** 2109  
**Host Device FCC ID:** C3K2109  
**Permissive Change(s):** FCC C2PC Cover Letter for 2109 and 2110  
**Device Serial Numbers:** Pre-Production Samples [WH624, 4CQ24]

Note: This revised test report supersedes and replaces the previously issued test report on the same subject device for the same type of testing as indicated. Please discard or destroy the previously issued test report(s) and dispose of it accordingly.

Only operations relevant to this permissive change were evaluated for compliance. The FCC C2PC Cover Letter for 2109 and 2110 includes a description of all changed items.

I attest to the accuracy of data. All measurements reported herein were performed by me or were made under my supervision and are correct to the best of my knowledge and belief. I assume full responsibility for the completeness of these measurements and vouch for the qualifications of all persons taking them. Test results reported herein relate only to the item(s) tested.



RJ Ortanez  
 Executive Vice President



<b>FCC ID:</b> C3K00002101	<b>RF EXPOSURE PART 2 TEST REPORT</b>	<b>Approved by:</b> Technical Manager
<b>Document S/N:</b> 1M2503050023-03.C3K (Rev3)	<b>DUT Type:</b> Wireless Module	Page 1 of 39

**T A B L E O F C O N T E N T S**

1 DEVICE UNDER TEST .....3

2 RF EXPOSURE LIMITS .....5

3 TIME VARYING TRANSMISSION TEST CASES .....7

4 FCC MEASUREMENT PROCEDURES..... 10

5 MEASUREMENT TEST SETUP (FREQ < 6 GHZ) ..... 18

6 TEST CONFIGURATIONS (FREQ < 6 GHZ)..... 21

7 CONDUCTED TX CASES (FREQ < 6 GHZ)..... 24

8 SYSTEM VERIFICATION (FREQ < 6 GHZ) ..... 30

9 SAR TEST RESULTS (FREQ < 6 GHZ) ..... 32

10 EQUIPMENT LIST..... 35

11 MEASUREMENT UNCERTAINTIES..... 36

12 CONCLUSION..... 37

13 REFERENCES ..... 38

- APPENDIX A: VERIFICATION PLOTS
- APPENDIX B: SAR TISSUE SPECIFICATIONS
- APPENDIX C: SAR SYSTEM VALIDATION
- APPENDIX D: TEST SETUP PHOTOGRAPHS
- APPENDIX E: TEST SEQUENCES
- APPENDIX F: CALIBRATION CERTIFICATES

<b>FCC ID:</b> C3K00002101	<b>RF EXPOSURE PART 2 TEST REPORT</b>	<b>Approved by:</b> Technical Manager
<b>Document S/N:</b> 1M2503050023-03.C3K (Rev3)	<b>DUT Type:</b> Wireless Module	Page 2 of 39

# 1 DEVICE UNDER TEST

## 1.1 Device Overview

Band & Mode	Operating Modes	Tx Frequency
2.4 GHz WIFI	Data	2412 - 2472 MHz
5 GHz WIFI	Data	U-NII-1: 5180 - 5240 MHz U-NII-2A: 5260 - 5320 MHz U-NII-2C: 5500 - 5720 MHz U-NII-3: 5745 - 5825 MHz U-NII-4: 5845 - 5885 MHz
6 GHz WIFI	Data	U-NII-5: 5935 - 6415 MHz U-NII-6: 6435 - 6515 MHz U-NII-7: 6535 - 6875 MHz U-NII-8: 6895 - 7115 MHz
2.4 GHz Bluetooth	Data	2402 - 2480 MHz

## 1.2 Time-Averaging Algorithm for RF Exposure Compliance

This device is enabled with Qualcomm® FastConnect features. These features perform their proprietary time averaging algorithms in real time to control and manage transmitting power and ensure the time-averaged RF exposure is in compliance with FCC requirements at all times. Section 2.1 and 2.2 has additional details regarding the implementation of these TAS algorithms.

Regulatory RF exposure limits are defined with respect to time-averaged RF exposure. Qualcomm FastConnect TAS algorithm performs transmit power control to ensures at all times the wireless device is in compliance with the configured limit of RF exposure averaged over a defined time window denoted as  $T_{SAR}$  for SAR.

- For FCC, a 30 second time-averaging window is used by FastConnect TAS for WLAN operation in 2.4GHz, 5GHz, and 6GHz WLAN bands.
- For ICNIRP 1998, the time-averaging window for radios operating <10GHz is 360 seconds. FastConnect TAS uses a 360s window for regions outside the U.S (e.g., ISED Canada).

The purpose of this report is to demonstrate the Qualcomm® FastConnect™ time averaged SAR (TAS) feature RF exposure compliance under dynamic transmission scenarios. This test report provides reference to test results and plots using parameters is determined from for static SAR test and configure in FastConnect TAS BDF for validating the FastConnect TAS feature.

## 1.3 Bibliography

Report Type		Report Serial Number
FCC ID: C3K00002101	RF EXPOSURE PART 2 TEST REPORT	
Document S/N: 1M2503050023-03.C3K (Rev3)	DUT Type: Wireless Module	Approved by: Technical Manager  Page 3 of 39

RF Exposure Part 0 Test Report	1M2503050023-02.C3K
RF Exposure Part 1 Test Report	1M2503050023-01.C3K
RF Exposure Compliance Summary Report	1M2503050023-04.C3K

<b>FCC ID:</b> C3K00002101	<b>RF EXPOSURE PART 2 TEST REPORT</b>	<b>Approved by:</b> Technical Manager
<b>Document S/N:</b> 1M2503050023-03.C3K (Rev3)	<b>DUT Type:</b> Wireless Module	Page 4 of 39

## 2 RF EXPOSURE LIMITS

### 2.1 Uncontrolled Environment

UNCONTROLLED ENVIRONMENTS are defined as locations where there is the exposure of individuals who have no knowledge or control of their exposure. The general population/uncontrolled exposure limits are applicable to situations in which the general public may be exposed or in which persons who are exposed as a consequence of their employment may not be made fully aware of the potential for exposure or cannot exercise control over their exposure. Members of the general public would come under this category when exposure is not employment-related; for example, in the case of a wireless transmitter that exposes persons in its vicinity.

### 2.2 Controlled Environment

CONTROLLED ENVIRONMENTS are defined as locations where there is exposure that may be incurred by persons who are aware of the potential for exposure, (i.e. as a result of employment or occupation). In general, occupational/controlled exposure limits are applicable to situations in which persons are exposed as a consequence of their employment, who have been made fully aware of the potential for exposure and can exercise control over their exposure. This exposure category is also applicable when the exposure is of a transient nature due to incidental passage through a location where the exposure levels may be higher than the general population/uncontrolled limits, but the exposed person is fully aware of the potential for exposure and can exercise control over his or her exposure by leaving the area or by some other appropriate means.

### 2.3 RF Exposure Limits for Frequencies Below 6 GHz

**Table 2-1**  
**SAR Human Exposure Specified in ANSI/IEEE C95.1-1992 and Health Canada Safety Code 6**

HUMAN EXPOSURE LIMITS		
	UNCONTROLLED ENVIRONMENT <i>General Population</i> (W/kg) or (mW/g)	CONTROLLED ENVIRONMENT <i>Occupational</i> (W/kg) or (mW/g)
<b>Peak Spatial Average SAR</b> Head	1.6	8.0
<b>Whole Body SAR</b>	0.08	0.4
<b>Peak Spatial Average SAR</b> Hands, Feet, Ankle, Wrists, etc.	4.0	20

1. The Spatial Peak value of the SAR averaged over any 1 gram of tissue (defined as a tissue volume in the shape of a cube) and over the appropriate averaging time.
2. The Spatial Average value of the SAR averaged over the whole body.
3. The Spatial Peak value of the SAR averaged over any 10 grams of tissue (defined as a tissue volume in the shape of a cube) and over the appropriate averaging time.

<b>FCC ID:</b> C3K00002101	<b>RF EXPOSURE PART 2 TEST REPORT</b>	<b>Approved by:</b> Technical Manager
<b>Document S/N:</b> 1M2503050023-03.C3K (Rev3)	<b>DUT Type:</b> Wireless Module	Page 5 of 39

## 2.4 RF Exposure Limits for Frequencies Above 6 GHz

Per §1.1310 (d)(3), the MPE limits are applied for frequencies above 6 GHz. Power Density is expressed in units of W/m<sup>2</sup> or mW/cm<sup>2</sup>.

Peak Spatially Averaged Power Density was evaluated over a circular area of 4 cm<sup>2</sup> per interim FCC Guidance for near-field power density evaluations per October 2018 TCB Workshop notes.

**Table 2-2  
Human Exposure Limits Specified in FCC 47 CFR §1.1310**

Human Exposure to Radiofrequency (RF) Radiation Limits		
Frequency Range [MHz]	Power Density [mW/cm <sup>2</sup> ]	Averaging Time [Minutes]
(A) Limits for Occupational / Controlled Environments		
1,500 – 100,000	5.0	6
(B) Limits for General Population / Uncontrolled Environments		
1,500 – 100,000	1.0	30

Note: 1.0 mW/cm<sup>2</sup> is 10 W/m<sup>2</sup>

## 2.5 Time Averaging Windows for FCC Compliance

Per October 2018 TCB Workshop Notes, the below time-averaging windows can be used for assessing time-averaged exposures for devices that are capable of actively monitoring and adjusting power output over time to comply with exposure limits.

Interim Guidance	Frequency (GHz)	Maximum Averaging Time (sec)
SAR	< 3	100
	3 – 6	60
MPE	6 - 10	30
	10 - 16	14
	16 – 24	8
	24 – 42	4
	42 – 95	2

FCC ID: C3K00002101	RF EXPOSURE PART 2 TEST REPORT	Approved by: Technical Manager
Document S/N: 1M2503050023-03.C3K (Rev3)	DUT Type: Wireless Module	Page 6 of 39

### 3 TIME VARYING TRANSMISSION TEST CASES

The following scenarios cover validation tests to prove FastConnect TAS accounts for the history of transmission power accuracy at all times including before, during, and after transition in each scenario.

Since RF exposure is proportional to the Tx power for a SAR wireless device, time-averaging algorithm validation can be effectively performed through conducted power measurements outlined below. In addition, since FastConnect TAS feature operates at the same averaged algorithm to all WLAN bands (2.4GHz, 5GHz, and 6GHz), test selection criteria described in Section 5.2 was used for time varying validation.

1. Time-Varying Test Sequence: This test proves the FastConnect TAS accounts for Tx power variations in time accurately. In addition, this test is performed to capture the maximum time-averaged results in at least two time-averaging windows duration.
2. Change in antenna (applicable when the software supports SISO diversity operation): This test is to prove that FastConnect functions correctly during transitions in Plim (at different antennas) within the same WLAN band and same Antenna Group. If device supports SISO and transmission diversity between an Antenna to another antenna, then this test is applicable. If WLAN MIMO CDD is implemented, then device is always under MIMO transmission, in this case, this test is NOT applicable.
3. Change in device state (DSI) (applicable when the device supports multiple DSI): This is to prove that FastConnect TAS performs power enforcements to maintain compliance during transitions in the device state.
4. Change in WLAN band: This is to prove that the FastConnect TAS functions correctly during transitions in radios and bands.
5. Simultaneous Transmission: This is to prove that the FastConnect TAS functions in transition from 1st standalone WLAN radio to simultaneous WLAN radios and back to 2nd standalone WLAN radio.

To add confidence in the feature validation, the time-averaged SAR measurements are also performed but only performed for transmission scenario 1 to avoid the complexity in SAR (such as, for scenario 3 requiring change in SAR probe calibration file to accommodate different bands and/or tissue simulating liquid).

The strategy for testing in Tx varying transmission condition is outlined as follows:

- Demonstrate the total RF exposure averaged over FCC defined time windows does not exceed FCC’s SAR limits, through time-averaged power measurements:
  - Measure conducted power.
  - Convert it into RF exposure and divide by respective limits to get normalized exposure use equation as described in this section.
  - Perform time-averaging over predefined time windows.
  - Demonstrate that the total normalized time-averaged RF exposure is <1 for all transmission scenarios.
  - For frequency below 6GHz or if regulator requires SAR for WLAN 6GHz band.

FCC ID: C3K00002101	<b>RF EXPOSURE PART 2 TEST REPORT</b>	Approved by: Technical Manager
Document S/N: 1M2503050023-03.C3K (Rev3)	DUT Type: Wireless Module	Page 7 of 39

$$1g\_or\_10gSAR(t) = \frac{\text{Conducted\_Tx\_power}(t)}{\text{Conducted\_Tx\_power\_Plim}} * 1g\_or\_10gSAR\_Plim \quad (1a)$$

$$\frac{\int_{t_1}^{t_2} TSAR^{1E\_or\_10gSAR}(t) dt}{FCC\ or\ ICNIRP\ SAR\ limit} \leq 1 \quad (1b)$$

- For frequency greater than 6GHz if regulator requires APD. (Applicable for ISED)

$$4cm^2\ PD(t) = \frac{\text{Conducted\_Tx\_power}(t)}{\text{Conducted\_Tx\_power\_Plim}} * 4cm^2\ PD\_Plim \quad (1c)$$

$$\frac{\int_{t_1}^{t_2} TSAR^{4cm^2\ PD}(t) dt}{APD\ 4cm^2\ PD\ limit} \leq 1 \quad (1d)$$

where, *conducted\_Tx\_power(t)*, *conducted\_Tx\_power\_Plim* and *1g\_or\_10gSAR\_Plim* correspond to the measured instantaneous conducted Tx power and conducted Tx power at *Plim* of DUT, and *1g\_or\_10gSAR* values at *Plim* for the worst-case radio configuration within the tested band/Antenna/DSI. Similarly, *4cm2 PD\_Plim* correspond to the APD values at *Plim* for the worst-case radio configuration within the tested band (greater than 6GHz)/Antenna/DSI.

The equations (1a) & (1b) are applicable if SAR is required by regulator to address RF exposure for the band greater than 6GHz.

**NOTE:** The ratio circled in red square is obtained from the measurement on the radio configuration is selected for validation test while the *1g\_or\_10gSAR\_Plim* and *4cm2 PD\_Plim* must be from the SAR value in the worst-case radio configuration within the tested band/Antenna/DSI in static SAR report and scale to the *conducted\_Tx\_power\_Plim* level is measured from DUT used in validation test.

- Demonstrate the total RF exposure averaged over FCC defined time windows does not exceed FCC's SAR limits, through time-averaged SAR measurements. Note as mentioned earlier, this measurement is performed for transmission scenario 1 only.
  - Choose worst case EUT orientation of SAR measurement per according to Static SAR test report and perform pointSAR measurement use cDASY6
  - Measure instantaneous SAR versus time and demonstrate total normalized time-averaged RF exposure is <1.0 at all times.
  - For frequency below 6GHz or if regulator requires SAR for WLAN 6GHz band.

$$1g\_or\_10gSAR(t) = \frac{\text{pointSAR}(t)}{\text{pointSAR\_Plim}} * 1g\_or\_10gSAR\_Plim \quad (2a)$$

$$\frac{\int_{t_1}^{t_2} TSAR^{1E\_or\_10gSAR}(t) dt}{FCC\ or\ ICNIRP\ SAR\ limit} \leq 1 \quad (2b)$$

- For frequency greater than 6GHz if regulator requires APD. (Applicable for ISED)

FCC ID: C3K00002101	RF EXPOSURE PART 2 TEST REPORT	Approved by: Technical Manager
Document S/N: 1M2503050023-03.C3K (Rev3)	DUT Type: Wireless Module	Page 8 of 39



$$4cm^2 PD(t) = \frac{pointSAR(t)}{pointSAR_{Plim}} * 4cm^2 PD_{Plim} \quad (2c)$$

$$\frac{\int_{t_1}^{t_2} TSAR_{4cm^2 PD} dt}{APD_{4cm^2 PD} limit} \leq 1 \quad (2d)$$

where,  $pointSAR(t)$ ,  $pointSAR_{Plim}$ , and  $1g\_or\_10gSAR_{Plim}$  correspond to the measured instantaneous point SAR and point SAR at  $P_{lim}$  of DUT, and  $1g\_or\_10gSAR$  values at  $P_{lim}$  for the worst-case radio configuration within the tested band/Antenna/DSI. Similarly,  $4cm^2 PD_{Plim}$  is the APD values at  $P_{lim}$  for the worst-case radio configuration within the tested band (greater than 6GHz)/Antenna/DSI.

The equations (2a) & (2b) are applicable if SAR is required by regulator to address RF exposure for the band greater than 6GHz.

**NOTE:** The ratio circled in red square is obtained from the measurement on the radio configuration is selected for validation test while the  $1g\_or\_10gSAR_{Plim}$  and  $4cm^2 PD_{Plim}$  must be from the SAR value in the worst-case radio configuration within the tested band/Antenna/DSI in static SAR report and scale to the  $conducted\_Tx\_power_{Plim}$  level is measured from DUT used in validation test.

FCC ID: C3K00002101	RF EXPOSURE PART 2 TEST REPORT	Approved by: Technical Manager
Document S/N: 1M2503050023-03.C3K (Rev3)	DUT Type: Wireless Module	Page 9 of 39

## 4 FCC MEASUREMENT PROCEDURES

This chapter provides the test plan and test procedure for validating WLAN FastConnect.

### 4.1 Test Sequence Determination for Validation

Following the FCC recommendation, one test sequences having time-variation in Tx power are predefined for validation:

- Test sequence 1: request DUT's Tx power to be at maximum power, measured  $P_{max}^\dagger$ , for 30s, then requesting for half of the maximum power, i.e., measured  $P_{max}/2$ , for the rest of the time.

The details for generating these two test sequences is described and listed in Appendix E.

**NOTE:** For test sequence generation, “measured  $P_{limit}$ ” and “measured  $P_{max}$ ” are used instead of the “ $P_{limit}$ ” specified in BDF entry and “ $P_{max}$ ” specified for the device, because the Smart Transmit feature operates against the actual power level of the “ $P_{limit}$ ” that was calibrated for the DUT. The “measured  $P_{limit}$ ” accurately reflects what the feature is referencing to, therefore, it should be used during feature validation testing. The RF tune up and device-to-device variation are already considered in Part 0 report prior to determining  $P_{limit}$ .

### 4.2 Test Configuration Selection Criteria for Validating Feature

The conducted power measurement method is used for all validation test scenarios. These tests demonstrate the power enforcement by FastConnect TAS where  $P_{lim}$  could vary before and after transition.

#### 4.2.1 Time-Varying Test Sequence

Select one representative test channel from all the available radio configurations (band/ant(s)/DSI) that has  $P_{max} > P_{lim} + \text{device uncertainty}$ .

- If  $P_{max} < P_{lim} + \text{device uncertainty}$  for all radio configurations, then select radio configuration with largest ( $P_{max} \text{ dBm} - P_{lim} \text{ dBm}$ ) value.
- If  $P_{max} > P_{lim} + \text{device uncertainty}$  for more than one radio configuration. Then, order of preference is given by:
  - If multiple radio configurations (band/ant(s)/DSI) meet this criteria, then SISO is preferred over MIMO due to simplified test setup.
  - After determining SISO vs. MIMO configuration, then select the configuration that has largest ( $P_{max} \text{ dBm} - P_{lim} \text{ dBm}$ ) dB delta.
- Test to be performed at two bands for Time-Varying Test sequence test. If only one band within a configuration has  $P_{max} > P_{lim}$  and  $P_{lim} > P_{max}$  in all other configurations, then only one band needs to be tested.
- Test is not required if  $P_{lim} > P_{max}$  for all radio configurations.

**NOTE:** The same selection criteria are applicable for both conducted & radiated tests.

FCC ID: C3K00002101	RF EXPOSURE PART 2 TEST REPORT	Approved by: Technical Manager
Document S/N: 1M2503050023-03.C3K (Rev3)	DUT Type: Wireless Module	Page 10 of 39

## 4.2.2 Change in Antenna

This test scenario does not apply if SISO mode diversity is not supported. (e.g., CDD is enabled and always use MIMO). The criteria to select test configuration for Change in Antenna measurement is:

- The antennas selected for this test should be in the same antenna group.
- Whenever possible and supported by the EUT, first select antenna switch configuration within the same band/DSI (i.e., same band and DSI combination), and having different Plim, and having both  $P_{max} > P_{lim} + \text{device uncertainty}$  where possible. Otherwise, select at least one antenna having  $P_{max} > P_{lim} + \text{device uncertainty}$ .
  - If multiple radio configurations (band/DSI) meet  $P_{max} > P_{lim} + \text{device uncertainty}$ , then select the configuration that has largest  $(P_{max} \text{ dBm} - P_{lim} \text{ dBm})$  dB delta.
  - If  $P_{max} < P_{lim} + \text{device uncertainty}$  for all radio configurations, then select radio configuration with largest  $(P_{max} \text{ dBm} - P_{lim} \text{ dBm})$  value.
- If the EUT does not support antenna switch within the same band but has multiple transmitting antennas to support different frequency bands, then antenna switch test should be performed in combination with Change in WLAN band test scenario.
- Test for Change in Antenna is not required if all  $P_{lim} > P_{max}$  for all radio configurations.

## 4.2.3 Change in Device State Index (DSI)

This test scenario does not apply if multiple DSIs is not supported in the device. The criteria to select test configuration for Change in DSI measurement is:

- Select a band/antenna having the  $P_{max} > P_{lim} + \text{device uncertainty}$  within any DSI, and for the same band/antenna(s) having a different Plim in any other DSI. Both the selected DSIs should have  $P_{max} > P_{lim} + \text{device uncertainty}$  where possible. Otherwise, select at least one DSI having  $P_{max} > P_{lim} + \text{device uncertainty}$ .
- If  $P_{max} < P_{lim} + \text{device uncertainty}$  for all band/antenna(s), then select radio configuration with largest  $(P_{max} \text{ dBm} - P_{lim} \text{ dBm})$  value.
- If  $P_{max} > P_{lim} + \text{device uncertainty}$  for more than one radio configuration, then order of preference is given by:
  - If multiple radio configurations (band/ant(s)/DSI) meet this criteria and if device support SISO. Then SISO is preferred over MIMO due to simplified test setup.
  - After determining SISO vs. MIMO configuration, then select the configuration that has largest  $(P_{max} \text{ dBm} - P_{lim} \text{ dBm})$  dB delta.

Test for Change in DSI is not required if all  $P_{lim} > P_{max}$  for all radio configurations.

## 4.2.4 Change in WLAN Band

The criteria to select test configuration for Change in WLAN band measurement is:

FCC ID: C3K00002101	<b>RF EXPOSURE PART 2 TEST REPORT</b>	<b>Approved by:</b> Technical Manager
<b>Document S/N:</b> 1M2503050023-03.C3K (Rev3)	<b>DUT Type:</b> Wireless Module	Page 11 of 39

- First select both bands in a DSI having  $P_{max} > P_{lim} + \text{device uncertainty}$  where possible. Otherwise, select at least one band having  $P_{max} > P_{lim} + \text{device uncertainty}$ .
- If  $P_{max} < P_{lim} + \text{device uncertainty}$  for all radio configurations, then select radio configuration with largest  $(P_{max} \text{ dBm} - P_{lim} \text{ dBm})$  value.
- If  $P_{max} > P_{lim} + \text{device uncertainty}$  for more than one radio configuration. Then, order of preference is given by:
  - If multiple radio configurations (band/ant(s)/DSI) meet this criteria and if device support SISO. Then SISO is preferred over MIMO due to simplified test setup.
  - After determining SISO vs. MIMO configuration, then select the configuration that has largest  $(P_{max} \text{ dBm} - P_{lim} \text{ dBm})$  dB delta.
- The antennas corresponding to the selected bands should be in the same antenna group.
- Test for Change in WLAN band is not required if all  $P_{lim} > P_{max}$  for all radio configurations.

### 4.2.5 Simultaneous Transmission

This test scenario does not apply if simultaneous transmission within WLAN bands is not supported in the device. The criteria to select test configuration for Simultaneous Transmission measurement is:

- The bands must be selected from supported Simultaneous Transmission configuration. (e.g., WLAN DBS and/or HBS)
- First select both bands in a DSI having  $P_{max} > P_{lim} + \text{device uncertainty}$  where possible. Otherwise, select at least one band having  $P_{max} > P_{lim} + \text{device uncertainty}$ .
- If  $P_{max} < P_{lim} + \text{device uncertainty}$  for all radio configurations, then select radio configuration with largest  $(P_{max} \text{ dBm} - P_{lim} \text{ dBm})$  value.
- If  $P_{max} > P_{lim} + \text{device uncertainty}$  for more than one radio configuration. Then, order of preference is given by:
  - If multiple radio configurations (band/ant(s)/DSI) meet this criteria and if device support SISO. Then SISO is preferred over MIMO due to simplified test setup.
  - After determining SISO vs. MIMO configuration, then select the configuration that has largest  $(P_{max} \text{ dBm} - P_{lim} \text{ dBm})$  dB delta.
- The antennas corresponding to the selected bands should be in the same antenna group.
- Even if a device has  $P_{lim} > P_{max}$  for all radio configurations, then “Simultaneous Transmission” test scenario should still be performed for validation of FastConnect TAS device.

### 4.3 Test Procedures for Conducted Power Measurement

1. Measure  $P_{lim}$  for modes at validation antenna ports, bands and/or DSIs with FastConnect TAS Peak Exposure Mode enabled with callbox to establish the chosen mode for test. Denote this measured power value as `Conducted_Tx_power_Plim`.

FCC ID: C3K00002101	RF EXPOSURE PART 2 TEST REPORT	Approved by: Technical Manager
Document S/N: 1M2503050023-03.C3K (Rev3)	DUT Type: Wireless Module	Page 12 of 39

**NOTE:** The measurement of Peak Exposure Mode should be performed with 70% or higher WLAN duty cycle (for example, using iPerf to generate UL traffic).

2. Set EUT to the intended FastConnect TAS mode.
3. Establish radio link with the callbox in the selected band.

**NOTE:** For the purpose of collecting repeatable time averaged power data, it is recommended to include a section of 30s at the beginning of every test with the device WLAN connection disconnected or turned off or transmitting at a very low duty cycle.

4. Request EUT to transmit in following Transition sequence:
  - a. Time-Varying Test Sequence – Request EUT to transmit maximum power for at least 30s with 100% duty cycle and 50% duty cycle for 30s to determine time-averaged 1gSAR versus time.

Time duration (seconds)	Duty Cycle (%)
30	100%
60	50%

- b. Change in antenna – EUT operates at Antenna 1 (e.g., Main antenna port) and requests to transmit at maximum power for at least 30s. Then switch to operation on Antenna 2 (e.g., Aux antenna port), followed by at least 120s of observation.
- c. Change in device state (DSI) – EUT operates at DSI 1 and requests to transmit at maximum power for at least 30s. Then switch to operation on DSI 2, followed by at least 120s of observation (observation period includes transition time).
- d. Change in WLAN band – EUT operates at Band 1 and requests to transmit at maximum power for at least 30s. Then it switches to Band 2 using the same antenna port and observes another 120s (observation period includes transition time).
- e. Simultaneous Transmissions: First establish WLAN connection with the callbox in radio2 configuration and request radio2 configuration to transmit at maximum duty cycle for at least 120s to test predominantly radio2 SAR exposure scenario. Then add radio1 configuration to the existing radio2 configuration call, and request both radio1 and radio2 to transmit at maximum duty cycle to test radio1 and radio2 SAR exposure scenario for at least 120s. Then drop (or request low duty cycle) for radio2 configuration to test predominantly radio1 SAR exposure scenario for another at least 120s. Record the conducted Tx powers for both radio1 and radio2 configurations for the entire duration of this test.

Note: radio1 and radio2 should operate at different band.

5. Measure and record Tx power versus time.

FCC ID: C3K00002101	<b>RF EXPOSURE PART 2 TEST REPORT</b>	Approved by: Technical Manager
Document S/N: 1M2503050023-03.C3K (Rev3)	DUT Type: Wireless Module	Page 13 of 39

- a. Once the measurement is done, extract instantaneous Tx power versus time, and convert the conducted Tx power into 1g\_or\_10g SAR value, see Eq. (1a), using Step 1 result.
- b. Then perform 30s moving average to determine time-averaged 1g\_or\_10gSAR versus time as illustrated in Figure 6-2.

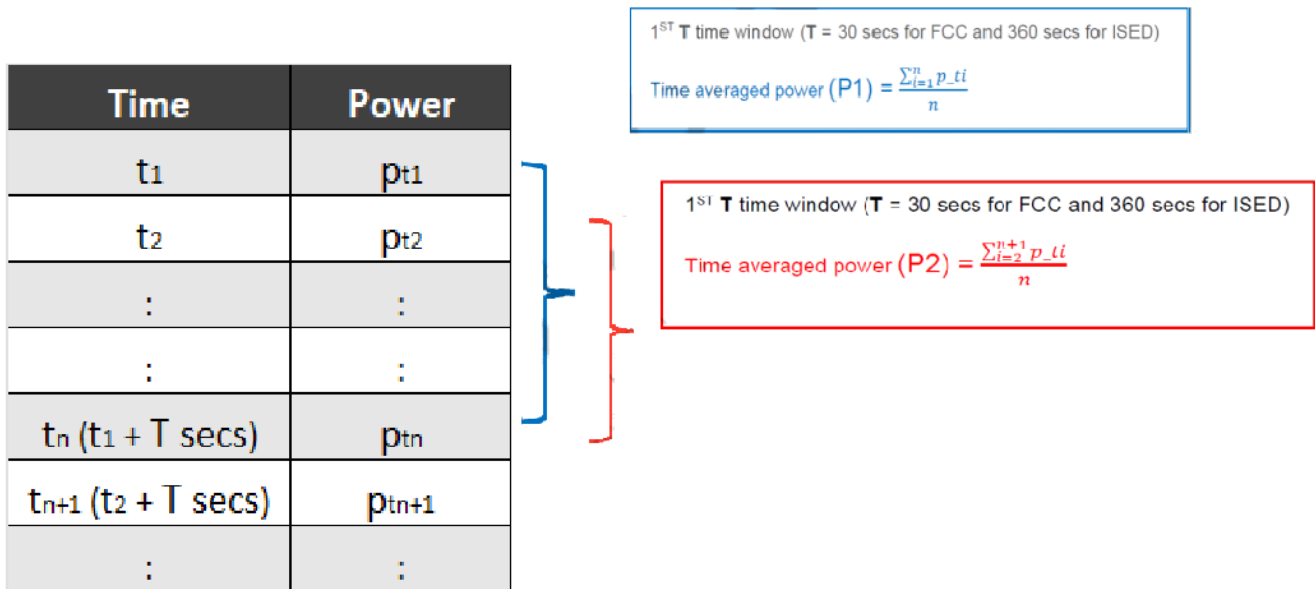

**Figure 6-2 Time running/moving average illustration**

The following normalization is used to convert 1g\_or\_10gSAR exposure using Equation (1a) and (1c) in section 5.1 to validate the continuity of RF exposure limits during the transition. The procedures from step1 and step 2 in this section should be completed for each configuration under test and use below equations to validate the RF exposure during the transition.

- o if tested with both radio configurations below 6GHz:

$$1g\_or\_10gSAR_1(t) = \frac{Conducted\_Tx\_power\_1(t)}{Conducted\_Tx\_power\_Plim\_1} * 1g\_or\_10gSAR\_Plim\_1 \quad (4a)$$

$$1g\_or\_10gSAR_2(t) = \frac{Conducted\_Tx\_power\_2(t)}{Conducted\_Tx\_power\_Plim\_2} * 1g\_or\_10gSAR\_Plim\_2 \quad (4b)$$

$$\frac{\frac{1}{TSAR} \left[ \int_{t-TSAR}^{t+1} 1g\_or\_10gSAR_1(t) dt + \int_{t-TSAR}^t 1g\_or\_10gSAR_2(t) dt \right]}{FCC\ or\ ICNIRP\ SAR\ limit} \leq 1 \quad (4c)$$

FCC ID: C3K00002101	<b>RF EXPOSURE PART 2 TEST REPORT</b>	Approved by: Technical Manager
Document S/N: 1M2503050023-03.C3K (Rev3)	DUT Type: Wireless Module	Page 14 of 39

where,  $conducted\_Tx\_power\_1(t)$ ,  $conducted\_Tx\_power\_Plim\_1$ , and  $1g\_or\_10gSAR\_Plim\_1$  correspond to the instantaneous Tx power, conducted Tx power at  $P_{lim\_1}$  of DUT, and compliance  $1g\_or\_10gSAR$  values of Antenna 1 (or Band 1 or DSI1) at  $P_{lim\_1}$ ;  $conducted\_Tx\_power\_2(t)$ ,  $conducted\_Tx\_power\_Plim\_2$ , and  $1g\_or\_10gSAR\_Plim\_2$  correspond to the instantaneous Tx power, conducted Tx power at  $P_{lim\_2}$  of DUT, and compliance  $1g\_or\_10gSAR$  values of Antenna 2 (or Band 2 or DSI2) at  $P_{lim\_2}$ .

Transition from the Antenna 1 (or Band 1 or DSI1) to the Antenna 2 (or Band 2 or DSI2) happens at time-instant ' $t'$ '.

- if tested with radio configuration: 2.4/5GHz WLAN assessed using SAR + 6GHz WLAN band assessed using APD (e.g., applicable for ISED):

$$1g\_or\_10gSAR_1(t) = \frac{Conducted\_Tx\_power\_1(t)}{Conducted\_Tx\_power\_Plim\_1} * 1g\_or\_10gSAR\_Plim\_1 \quad (5a)$$

$$4cm^2 PD_2(t) = \frac{Conducted\_Tx\_power\_2(t)}{Conducted\_Tx\_power\_Plim\_2} * 4cm^2 PD\_Plim\_2 \quad (5b)$$

$$\frac{\frac{1}{TSAR} \int_{t-TSAR}^{t1} 1g\_or\_10gSAR(t) dt}{ICNIRP SAR limit} + \frac{\frac{1}{TSAR} \int_{t-TSAR}^t 4cm^2 PD(t) dt}{APD 4cm^2 PD limit} \leq 1 \quad (5c)$$

where,  $conducted\_Tx\_power\_1(t)$ ,  $conducted\_Tx\_power\_Plim\_1$  and  $1g\_or\_10gSAR\_Plim\_1$  correspond to the measured instantaneous conducted Tx power and conducted Tx power at  $P_{lim\_1}$  of DUT, and  $1g\_or\_10gSAR$  values at  $P_{lim\_1}$  for the worst-case radio configuration within the tested 2.4/5GHz WLAN band;  $conducted\_Tx\_power\_2(t)$ ,  $conducted\_Tx\_power\_Plim\_2$ , and  $4cm^2 PD\_Plim\_2$  correspond to the instantaneous Tx power, conducted Tx power at  $P_{lim\_2}$  of DUT, and  $4cm^2 PD$  values (APD) of at  $P_{lim\_2}$  for the worst-case radio configuration within the tested 6GHz WLAN band.

Transition from the Band1 to the Band2 happens at time-instant ' $t'$ '.

- if tested with both radio configurations greater than 6GHz bands that are assessed using APD (e.g., applicable for ISED):

$$4cm^2 PD_1(t) = \frac{Conducted\_Tx\_power\_1(t)}{Conducted\_Tx\_power\_Plim\_1} * 4cm^2 PD\_Plim\_1 \quad (6a)$$

$$4cm^2 PD_2(t) = \frac{Conducted\_Tx\_power\_2(t)}{Conducted\_Tx\_power\_Plim\_2} * 4cm^2 PD\_Plim\_2 \quad (6b)$$

$$\frac{\frac{1}{TSAR} \left[ \int_{t-TSAR}^{t1} 4cm^2 PD_1(t) dt + \int_{t-TSAR}^t 4cm^2 PD_2(t) dt \right]}{APD 4cm^2 PD limit} \leq 1 \quad (6c)$$

FCC ID: C3K00002101	RF EXPOSURE PART 2 TEST REPORT	Approved by: Technical Manager
Document S/N: 1M2503050023-03.C3K (Rev3)	DUT Type: Wireless Module	Page 15 of 39

where,  $conducted\_Tx\_power\_1(t)$ ,  $conducted\_Tx\_power\_Plim\_1$ , and  $4cm_2 PD\_Plim\_1$  correspond to the instantaneous Tx power, conducted Tx power at  $P_{lim\_1}$  of DUT, and compliance  $4cm_2$  PD values (APD) of Band 1 (or Antenna 1) at  $P_{lim\_1}$ ;

$conducted\_Tx\_power\_2(t)$ ,  $conducted\_Tx\_power\_Plim\_2$ , and  $4cm_2 PD\_Plim\_2$  correspond to the instantaneous Tx power, conducted Tx power at  $P_{lim\_2}$  of DUT, and compliance  $4cm_2$  PD values (APD) of Antenna Band 2 (or Antenna 2) at  $P_{lim\_2}$ .

Transition from the Band 1 (or Antenna 1) to the Band 2 (or Antenna 2) happens at time-instant ' $t_r$ '.

6. Make one plot containing:
  - a. Computed time-averaged  $1g\_or\_10gSAR$  (and/or  $4cm_2$  PD) versus time from above procedure.
  - b. Corresponding regulatory  $1g\_or\_10gSAR$  (and/or  $4cm_2$  PD) limit.

The validation criteria is, at all times, the combined time-averaged  $1g\_or\_10gSAR$  (and/or  $4cm_2$  PD) versus time shall not exceed the regulatory  $1g\_or\_10gSAR$  limit.

#### 4.4 Test Procedures for Time-Varying SAR Measurement

The pointSAR test is performed only with Time-Varying Test Sequence to provide high confidence in the algorithm validation. The radio configuration for this test is selected by following the selection criteria described in Section 5.2.1.

1. For a given radio configuration:
  - a. Enable WLAN connection with callbox in **FastConnect TAS Peak Exposure Mode** and enable high duty cycle Tx while performing the following steps.
  - b. Perform the area scan.
  - c. Conduct pointSAR measurement at peak location of the area scan for 120s.

This pointSAR value,  $pointSAR\_Plim$  corresponds to pointSAR at the measured  $P_{lim}$ .

**NOTE:** The measurement of Peak Exposure Mode should be performed with 70% or higher WLAN duty cycle (for example, using iPerf to generate UL traffic).

2. Set EUT to intended FastConnect Time-Averaged Exposure Mode with callbox to establish the same chosen radio configuration (mode/channel) for test.
  - a. Request EUT to transmit in Time-Varying Test sequence and perform Time-averaged point SAR measurements at the same peak location.
  - b. Perform Time-averaged point SAR measurements at the same peak location as Peak Exposure Point SAR measurement for 120s. Note this includes initial 30s with WLAN with very low duty cycle (or WLAN is disconnected) and 90s of high duty cycle (WLAN has to be connected with high uplink traffic).
  - c. Once the measurement is done, extract instantaneous pointSAR versus time data,  $pointSAR(t)$
  - d. Convert it into instantaneous  $1gSAR$  versus time by using Equation (2a) and (2c) in Section 5.2.4:

FCC ID: C3K00002101	<b>RF EXPOSURE PART 2 TEST REPORT</b>	Approved by: Technical Manager
Document S/N: 1M2503050023-03.C3K (Rev3)	DUT Type: Wireless Module	Page 16 of 39



$$1g\_or\_10gSAR(t) = \frac{pointSAR(t)}{pointSAR\_Plim} * 1g\_or\_10gSAR\_Plim \quad (2a)$$

where, *pointSAR\_Plim* corresponds to the value determined in Step 1, and *pointSAR(t)* corresponds to instantaneous *pointSAR* determined in Step 2 in this section.

- e. Then perform 30s moving average to determine time-averaged 1gSAR versus time.
3. Make one plot containing:
- a. Computed time-averaged 1g\_or\_10gSAR versus time determined from Step 2.
  - b. Regulatory 1g\_or\_10gSAR limit.

The validation criteria for *pointSAR* measurement is, at all times, the time averaged 1g\_or\_10gSAR (or 4cm2 PD) versus time shall not exceed the regulatory 1g\_or\_10gSAR (or 4cm2 PD) limit.

FCC ID: C3K00002101	<b>RF EXPOSURE PART 2 TEST REPORT</b>	<b>Approved by:</b> Technical Manager
Document S/N: 1M2503050023-03.C3K (Rev3)	DUT Type: Wireless Module	Page 17 of 39

## 5 MEASUREMENT TEST SETUP (FREQ < 6 GHZ)

### 5.1 Conducted Measurement Test Setup

#### Conducted Test Setup

The Rohde & Schwarz CMW500 callbox was used in this test. The test setup schematic is shown in Figure 6-1a (Appendix D – Test Setup Photo 1 and 2) for measurements with a single antenna port of DUT, and in Figure 6-1b (Appendix D – Test Setup Photo 3) for simultaneous transmission (DBS) measurements.

For single antenna measurement, one port (RF1 COM) of the callbox is connected to the RF port of the DUT using a directional coupler. For simultaneous transmission (DBS) measurement, two ports (RF 3 COM and RF 4 COM) of the callboxes used for signaling two different bands are connected to a combiner, which is in turn connected to a directional coupler. The coupled port of the directional coupler is connected to a splitter to connect to two RF filters corresponding to the two frequencies of interest. In the setups, the power meter is used to tap the directional coupler for measuring the conducted output power of the DUT.

All the path losses from RF port of DUT to the callbox RF COM port and to the power meter are calibrated and automatically entered as offsets in the callbox and the power meter via test scripts on the PC used to control callbox and power meter.

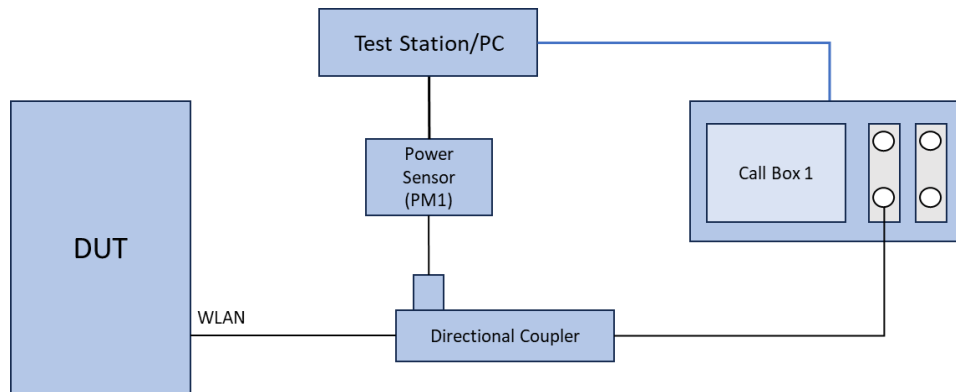

(a) Appendix D – Test Setup Photo 1, 2

FCC ID: C3K00002101	<b>RF EXPOSURE PART 2 TEST REPORT</b>	Approved by: Technical Manager
Document S/N: 1M2503050023-03.C3K (Rev3)	DUT Type: Wireless Module	Page 18 of 39

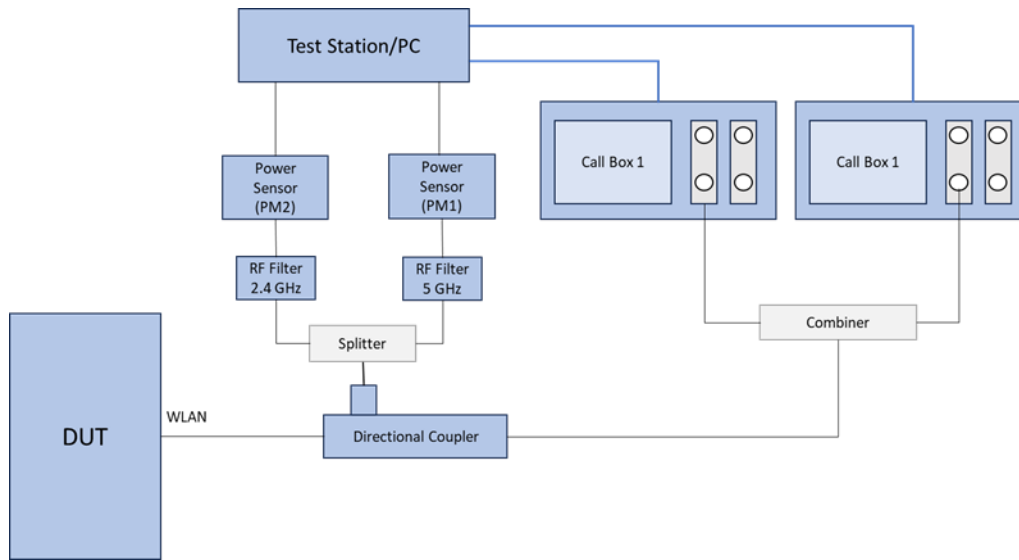

(b) Appendix D – Test Setup Photo 3

**Figure 5-1  
Conducted power measurement setup**

Both the callbox and power meter are connected to the PC using GPIB cables. Two test scripts are custom made for automation, and the test duration set in the test scripts is 500 seconds.

For time-varying Tx power measurement, the PC runs the 1<sup>st</sup> test script to send GPIB commands to control the callbox's requested power versus time, while at the same time to record the conducted power measured at DUT RF port using the power meter. The commands sent to the DUT to request power are:

- 0dBm for 30 seconds
- test sequence 1 (defined in Section 4.1 and generated in Section 4.2.1), for 90 seconds.
- stay at the last power level of test sequence 1 for the remaining time.

Power meter readings are periodically recorded every 100ms. A running average of this measured Tx power over 30 seconds is performed in the post-data processing to determine the 30s-time averaged power.

For call drop, band/antenna switch, and DSI switch tests, after the call is established, the DUT' Tx power is requested to 0dBm for 30 seconds while simultaneously starting the 2<sup>nd</sup> test script runs at the same time to start recording the Tx power measured at DUT RF port using the power meter. After the initial 30 seconds since starting the Tx power recording, the DUT' Tx power is requested to maximum power from the DUT for the rest of the test. Note that the call drop/re-establish, or band/antenna switch or DSI switch is manually performed when the Tx power of DUT is at  $P_{reserve}$  level. See Section 4.3 for detailed test procedure of call drop test, band/antenna switch test and DSI switch test.

FCC ID: C3K00002101	RF EXPOSURE PART 2 TEST REPORT	Approved by: Technical Manager
Document S/N: 1M2503050023-03.C3K (Rev3)	DUT Type: Wireless Module	Page 19 of 39

## 5.2 SAR Measurement Setup

The measurement setup is similar to normal SAR measurements as described in the Part 1 Test Report. The difference in SAR measurement setup for time averaging feature validation is that the callbox is signaling in close loop power control mode (instead of requesting maximum power in open loop control mode) and callbox is connected to the PC using GPIB so that the test script executed on PC can send GPIB commands to control the callbox’s requested power over time (test sequence). The same test script used in conducted setup for time-varying Tx power measurements is also used in this section for running the test sequences during SAR measurements, and the recorded values from the disconnected power meter by the test script were discarded.

As mentioned in Section 4.4, for DUT to follow TPC command sent from the callbox wirelessly, the “path loss” between callbox antenna and the DUT needs to be very well calibrated. Since the SAR chamber is in uncontrolled environment, precautions must be taken to minimize the environmental influences on “path loss”.

The DUT is placed in worst-case position according to Table 6-2.

FCC ID: C3K00002101	<b>RF EXPOSURE PART 2 TEST REPORT</b>	<b>Approved by:</b> Technical Manager
Document S/N: 1M2503050023-03.C3K (Rev3)	DUT Type: Wireless Module	Page 20 of 39

## 6 TEST CONFIGURATIONS (FREQ < 6 GHZ)

### 6.1 WLAN transmission

The  $P_{limit}$  values, corresponding to 1.0 W/kg (1gSAR) of  $SAR_{design\_target}$ , for technologies and bands supported by DUT are derived in Part 0 report and summarized in Table 7-1.

**Table 6-1**  
 **$P_{limit}$  for supported bands ( $P_{limit}$  in BDF file)**

Exposure Scenario			Maximum Tune-Up Output Power*	Power Mode 1	Power Mode 2
Averaging Volume				1g	1g
Spacing				25mm, 0mm	0mm
DSI				0	1
Technology/Band	Antenna	Antenna Group	$P_{max}$	$P_{limit}$	$P_{limit}$
2.4 GHz WIFI	R	AG0	22.0	34.3	16.25
2.4 GHz WIFI	L	AG1	22.0	33.7	16.25
5 GHz WIFI	R	AG0	20.5	29.8	16.0
5 GHz WIFI	L	AG1	20.5	27.4	16.0
6 GHz WIFI	R	AG0	18.0	30.3	14.0
6 GHz WIFI	L	AG1	18.0	29.3	14.0

\* Maximum tune up target power,  $P_{max}$ , is configured in NV settings in DUT to limit maximum transmitting. The DUT maximum allowed output power is equal to  $P_{max} + 1$  dB device uncertainty.

Based on selection criteria described in Section 5.2, the selected bands for testing time-varying test sequences are highlighted in yellow in Table 7-1. Per the manufacturer, the *Reserve margin* (dB) is set to 1dB and is used in Part 2 test.

The radio configurations used in Part 2 test for selected bands, DSIs and antennas are listed in Table 6-2. The corresponding worst-case radio configuration 1gSAR values for selected technology/band/DSI are extracted from Part 1 report and are listed in Table 6-2.

Based on equations (1a), (2a), (3a) and (4a), it is clear that Part 2 testing outcome is normalized quantity, which implies that it can be applied to any radio configuration within a selected technology/band/DSI. Thus, as long as applying the worst-case SAR obtained from the worst radio configuration in Part 1 testing to calculate time-varying SAR exposure in equations (1a), (2a), (3a) and (4a), the accuracy in compliance demonstration remains the same. Therefore, there may be some differences between the radio configuration selected for Part 2 testing and the radio configuration associated with worst-case SAR obtained in the Part 1 evaluation.

FCC ID: C3K00002101	RF EXPOSURE PART 2 TEST REPORT	Approved by: Technical Manager
Document S/N: 1M2503050023-03.C3K (Rev3)	DUT Type: Wireless Module	Page 21 of 39

The measured  $P_{limit}$  for all the selected radio configurations are listed in below Table 6-2.  $P_{max}$  was also measured for radio configurations selected for testing time-varying Tx power transmission scenarios in order to generate test sequences following the test procedures in Section 5.1.

**Table 6-2  
Radio Configurations Selected for Part 2 Test**

Test Case #	Test Scenario	Tech	Band	Antenna	DSI	Channel	Frequency [MHz]	Test Configurations	SAR Exposure Scenario	Part 1 Worst Case Measured SAR at Plimit (W/kg)	EFS Plimit [dBm]	Tune-up Pmax [dBm]	Measured Plimit [dBm]	Measured Pmax [dBm]
1	Time Varying Test Sequence	WLAN	2.4	R	1	11	2462	802.11b 20 MHz BW DSSS	Top, 0mm	0.673	16.25	22.00	16.12	21.94
2			5	L	1	165	5825	802.11ac 20 MHz BW DSSS	Top, 0mm	0.890	16.00	20.50	16.04	20.98
3	Change in Device State (DSI)		2.4	R	0	11	2462	802.11b 20 MHz BW DSSS	Top, 25mm	0.068	34.30	22.00	21.94	21.94
			2.4	R	1	11	2462	802.11b 20 MHz BW DSSS	Top, 0mm	0.673	16.25	22.00	16.12	21.94
4	Change in WLAN Band		2.4	L	1	1	2412	802.11b 20 MHz BW DSSS	Top, 0mm	0.638	16.25	22.00	16.15	22.02
			5	L	1	165	5825	802.11ac 20 MHz BW DSSS	Top, 0mm	0.890	16.00	20.50	16.04	20.98
5	Simultaneous Transmission		5	L	1	165	5825	802.11ac 20 MHz BW DSSS	Top, 0mm	0.890	16.00	20.50	16.04	20.98
			2.4	L	1	11	2412	802.11n 20 MHz BW DSSS	Top, 0mm	0.638	16.25	13.50	13.59	13.59

Note: The device uncertainty of  $P_{max}$  is +/- 1 dB as provided by manufacturer.

**Table 6-3  
DSI and Corresponding Exposure Scenarios**

Scenario	Description	SAR Test Cases
Device Mode (DSI=0)	<ul style="list-style-type: none"> <li>Device transmits at an angle <math>\leq 210^\circ</math> or no motion is detected</li> </ul>	<p><i>SAR Testing per KDB Publication 616217 D04v01r02</i></p>
Device Mode (DSI=1)	<ul style="list-style-type: none"> <li>Device transmits when no accessory is attached, motion is detected, or accessory is attached at <math>&gt;210^\circ</math> angle</li> </ul>	<p><i>SAR per KDB Publication 648474 D04v01r03</i></p>

Based on the selection criteria described in Section 4.2, the radio configurations for the Tx varying transmission test cases listed in Section 3 are:

- 1. Technologies and bands for time-varying Tx power transmission:** The test case 1~2 listed in Table 6-2 are selected to test with the test sequences defined in Section 4.1 in both time-varying conducted power measurement and time-varying SAR measurement.
- 2. Technologies and bands for change in DSI:** Based on selection criteria in Section 4.2.3 for a given technology and band, test case 3 in Table 6-2 is selected for change in antenna test by establishing a call in WLAN 2.4 GHz, antenna R in DSI = 0, and then handing over to DSI = 1 exposure scenario in conducted power setup.
- 3. Technologies and bands for change in Band test:** Following the guidelines in Section 4.2.4, test case 4 in Table 6-2 is selected for handover test from a band (WLAN 2.4 GHz, DSI = 1, antenna L), to a band in the same DSI within one antenna group (WLAN 5 GHz, DSI = 1, antenna L) in conducted power setup.

FCC ID: C3K00002101	RF EXPOSURE PART 2 TEST REPORT	Approved by: Technical Manager
Document S/N: 1M2503050023-03.C3K (Rev3)	DUT Type: Wireless Module	Page 22 of 39

4. Technologies and bands for simultaneous transmission (DBS): Based on selection criteria in Section 4.2.5, test case 5 in Table 6-2 is selected for simultaneous transmission test in one of the supported simultaneous WLAN transmission scenario, i.e., WLAN 5 GHz (Station mode) + WLAN 2.4 GHz (Hotspot mode) active in the same 30s time window, in conducted power setup.

**NOTE:** This device supports different antenna groups for each antenna. Therefore, change in antennas test was excluded.

**NOTE:** All switching and simultaneous test cases (#3 - #5) were done with modes/bands within the same antenna group.

FCC ID: C3K00002101	<b>RF EXPOSURE PART 2 TEST REPORT</b>	<b>Approved by:</b> Technical Manager
Document S/N: 1M2503050023-03.C3K (Rev3)	DUT Type: Wireless Module	Page 23 of 39

## 7 CONDUCTED TX CASES (FREQ < 6 GHZ)

### 7.1 Time-varying Tx Power Case

The measurement setup is shown in Figure 6-1. The purpose of the time-varying Tx power measurement is to demonstrate the effectiveness of power limiting enforcement and that the time-averaged Tx power when represented in time-averaged 1gSAR or 10gSAR values does not exceed FCC limit as shown in Eq. (1a) and (1b), rewritten below:

$$1g\_or\_10gSAR(t) = \frac{conducted\_Tx\_power(t)}{conducted\_Tx\_power\_P_{limit}} * 1g\_or\_10gSAR\_P_{limit} \quad (1a)$$

$$\frac{\frac{1}{T_{SAR}} \int_{t-T_{SAR}}^t 1g\_or\_10gSAR(t) dt}{FCC\ SAR\ limit} \leq 1 \quad (1b)$$

where,  $conducted\_Tx\_power(t)$ ,  $conducted\_Tx\_power\_P_{limit}$ , and  $1g\_or\_10gSAR\_P_{limit}$  correspond to the measured instantaneous conducted Tx power, measured conducted Tx power at  $P_{limit}$ , and measured 1gSAR and 10gSAR values at  $P_{limit}$  reported in Part 1 test (listed in Table 6-2 of this report as well).

Following the test procedure in Section 4.3, the conducted Tx power measurement for all selected configurations are reported in this section. In all the conducted Tx power plots, the green curve represents time-averaged power and red line represents the conducted power limit that corresponds to FCC limit of 1.6 W/kg for 1gSAR or 4.0 W/kg for 10gSAR.

Similarly, in all the 1g or 10gSAR plots (when converted using Eq. (1a)), the green curve represents the 30s/30s-time averaged 1gSAR or 10gSAR value calculated based on instantaneous 1gSAR or 10gSAR; and the red line limit represents the FCC limit of 1.6 W/kg for 1gSAR or 4.0 W/kg for 10gSAR.

Time-varying Tx power measurements were conducted on test cases #1 ~ #2 in Table 6-2, by generating test sequence 1 given in APPENDIX E: using measured  $P_{limit}$  and measured  $P_{max}$  (last two columns of Table 6-2) for each of these test cases. Measurement results for test cases #1 ~ #2 are given in Sections 8.1.1-8.1.2.

FCC ID: C3K00002101	RF EXPOSURE PART 2 TEST REPORT	Approved by: Technical Manager
Document S/N: 1M2503050023-03.C3K (Rev3)	DUT Type: Wireless Module	Page 24 of 39



### 7.1.1 WLAN Band 2.4 GHz, Antenna R

#### Test result for test sequence 1:

Time-averaged conducted Tx power is converted/calculated into time-averaged 1gSAR using Equation (1a) and plotted below to demonstrate that the time-averaged 1gSAR versus time does not exceed the FCC limit of 1.6 W/kg for 1gSAR:

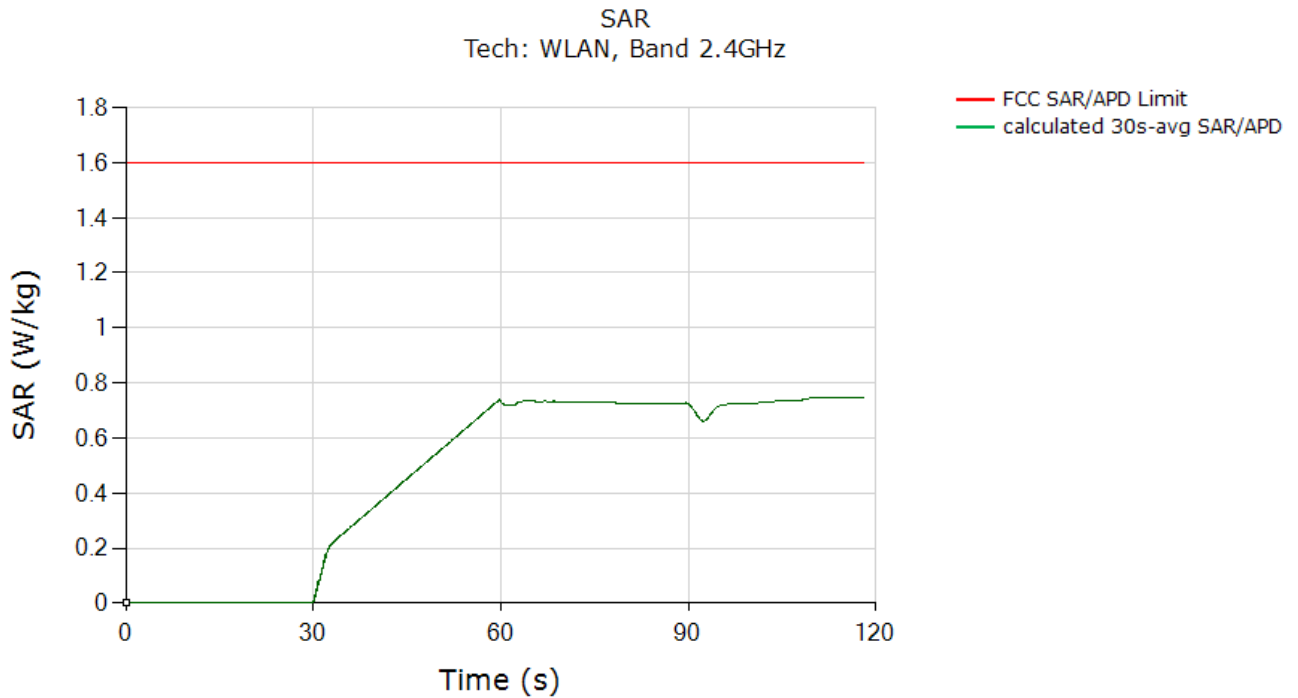

	(W/kg)
FCC 1gSAR limit	1.6
Max 30s-time averaged 1gSAR (green curve)	0.748
<b>Validated:</b> Max time averaged SAR (green curve) is within 1 dB device uncertainty of measured SAR at $P_{limit}$ (worst case SAR at Plim column in Table 6-2).	

<b>FCC ID:</b> C3K00002101	<b>RF EXPOSURE PART 2 TEST REPORT</b>	<b>Approved by:</b> Technical Manager
<b>Document S/N:</b> 1M2503050023-03.C3K (Rev3)	<b>DUT Type:</b> Wireless Module	Page 25 of 39

## 7.1.2 WLAN Band 5 GHz, Antenna L

### Test result for test sequence 1:

Time-averaged conducted Tx power is converted/calculated into time-averaged 1gSAR using Equation (1a) and plotted below to demonstrate that the time-averaged 1gSAR versus time does not exceed the FCC limit of 1.6 W/kg for 1gSAR:

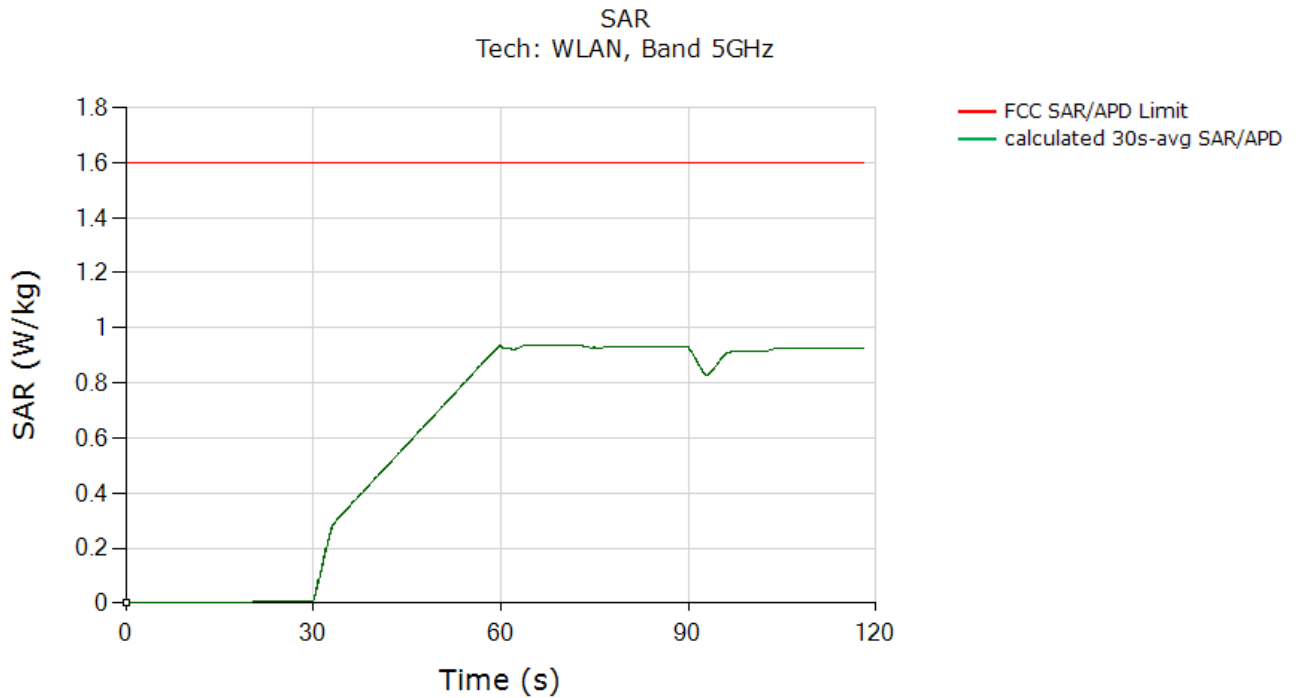

	(W/kg)
FCC 1gSAR limit	1.6
Max 30s-time averaged 1gSAR (green curve)	0.937
<b>Validated:</b> Max time averaged SAR (green curve) is within 1 dB device uncertainty of measured SAR at $P_{limit}$ (worst case SAR at Plim column in Table 6-2).	

FCC ID: C3K00002101	RF EXPOSURE PART 2 TEST REPORT	Approved by: Technical Manager
Document S/N: 1M2503050023-03.C3K (Rev3)	DUT Type: Wireless Module	Page 26 of 39

## 7.2 Change in Device State Index (DSI)

This test was conducted with callbox requesting maximum power, and with DSI switch from WLAN Band 2.4 GHz, antenna R, DSI = 0 to DSI = 1. Following procedure detailed in Section 4.3 using the measurement setup shown in Figure 6 -1, the DSI switch was performed when the DUT is transmitting at  $P_{reserve}$  level as shown in the plot below.

### Test result for change in DSI:

All the time-averaged conducted Tx power measurement results were converted into time-averaged normalized SAR values using Equation (4a), (4b) and (4c), and plotted below to demonstrate that the time-averaged normalized SAR versus time does not exceed the FCC limit of 1 unit.

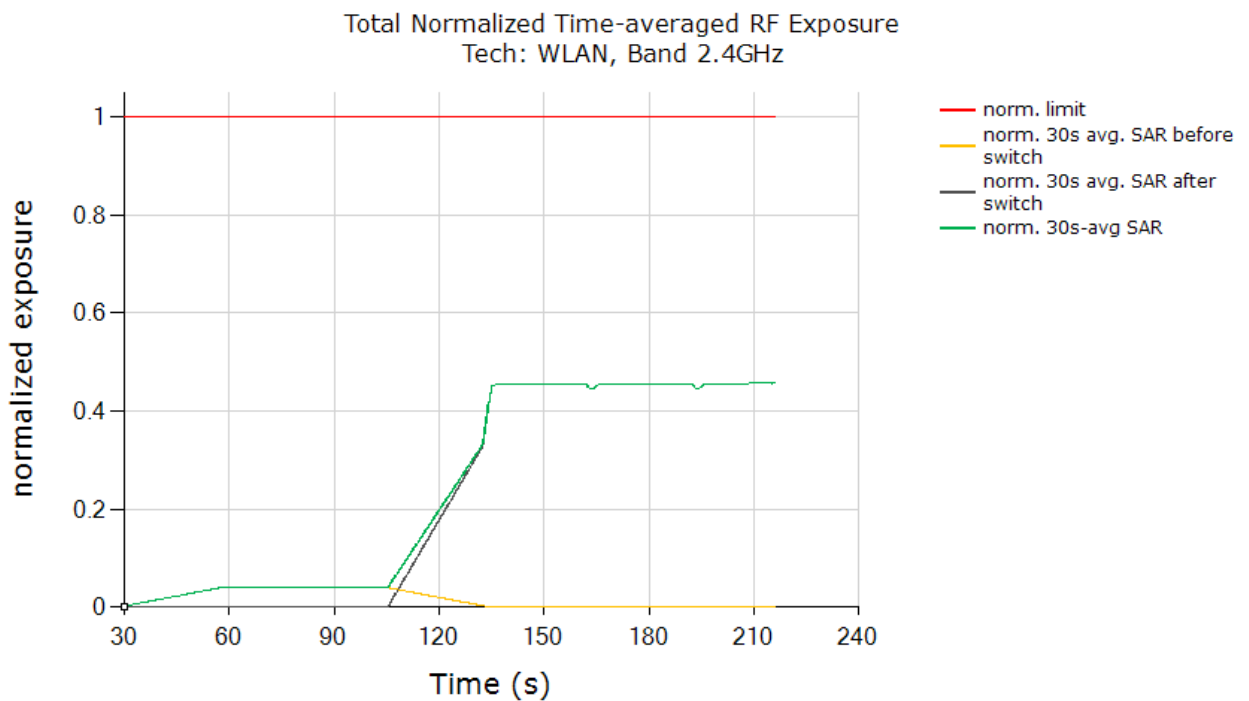

FCC normalized total exposure limit	1.0
Max 30s-time averaged normalized SAR (green curve)	0.457
Validated	

The test result validated the continuity of power limiting in change in DSI scenario.

<b>FCC ID:</b> C3K00002101	<b>RF EXPOSURE PART 2 TEST REPORT</b>	<b>Approved by:</b> Technical Manager
<b>Document S/N:</b> 1M2503050023-03.C3K (Rev3)	<b>DUT Type:</b> Wireless Module	Page 27 of 39

### 7.3 Change in WLAN Band

This test was conducted with a callbox requesting maximum power, and with a band switch WLAN Band 2.4 GHz, DSI = 1, antenna L to WLAN Band 5 GHz, DSI = 1, antenna L. Following procedure detailed in Section 4.3 and using the measurement setup shown in Figure 6-1, the band switch was performed when the DUT is transmitting at  $P_{reserve}$  level as shown in the plot below.

Test result for change in band:

Time-averaged conducted Tx power measurement results were converted into time-averaged normalized SAR values using Equation (4a), (4b) and (4c), and plotted below to demonstrate that the time-averaged normalized SAR versus time does not exceed the normalized FCC limit of 1.0:

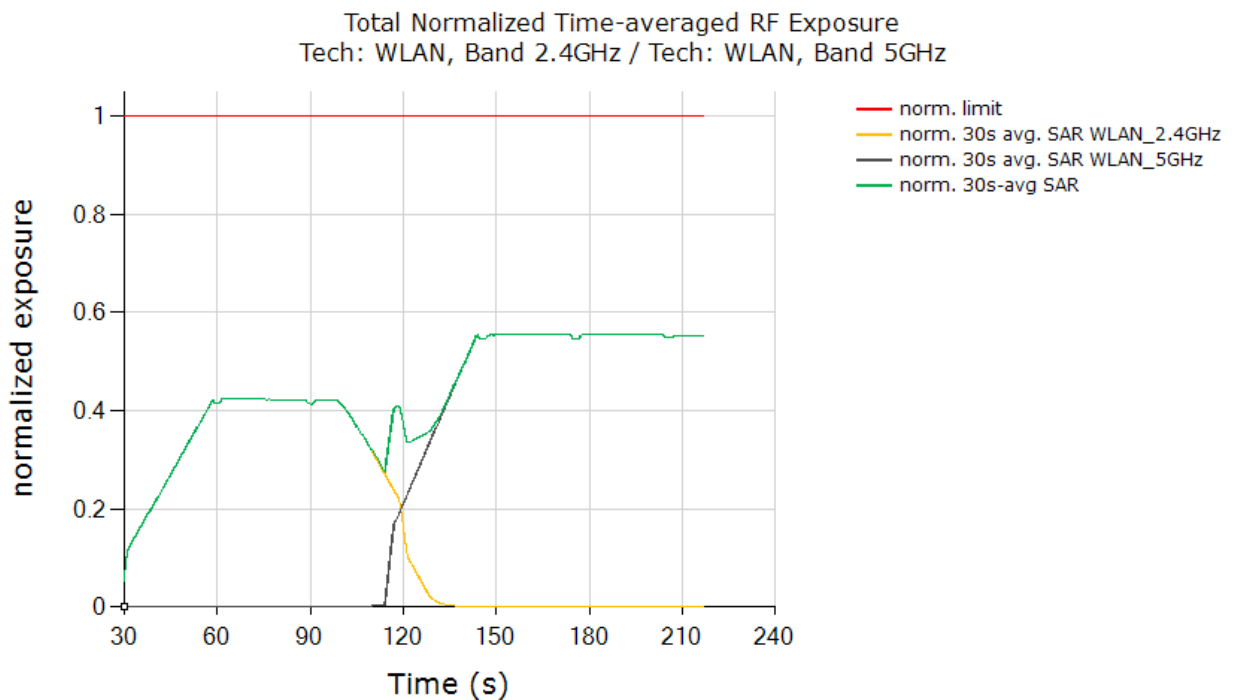

FCC normalized SAR limit	1.0
Max 30s-time averaged normalized SAR (green curve)	0.556
Validated	

The test result validated the continuity of power limiting in band switch scenario.

FCC ID: C3K00002101	<b>RF EXPOSURE PART 2 TEST REPORT</b>	Approved by: Technical Manager
Document S/N: 1M2503050023-03.C3K (Rev3)	DUT Type: Wireless Module	Page 28 of 39

## 7.4 Simultaneous Transmission (DBS)

This test was conducted with a callbox requesting maximum power, and with the EUT in WLAN 2.4GHz + WLAN 5GHz call. Following procedure detailed in Section 4.3, and using the measurement setup shown in Figure 6-1, since WLAN channels are sharing the same antenna port, the SAR exposure switch measurement is performed with the EUT in various SAR exposure scenarios, i.e., in SAR<sub>WLAN 2.4GHz</sub> only scenario (t = 0s ~ 120s), SAR<sub>WLAN 2.4GHz</sub> + SAR<sub>WLAN 5GHz</sub> scenario (t = 120s ~ 240s) and SAR<sub>WLAN 5GHz</sub> only scenario (t > 240s).

All the conducted Tx power measurement results were converted into time-averaged normalized SAR values using Equation (4a), (4b) and (4c), and plotted below to demonstrate that the time-averaged normalized SAR versus time does not exceed the FCC limit of 1 unit. Equation (7a) is used to convert the WLAN Tx power of device to obtain 30s-averaged normalized SAR in WLAN 5GHz as shown in black curve. Similarly, equation (4b) is used to obtain 30s-averaged normalized SAR in WLAN 2.4GHz as shown in orange curve. Equation (c) is used to obtain total time-averaged normalized SAR as shown in green curve (i.e., sum of black and orange curves).

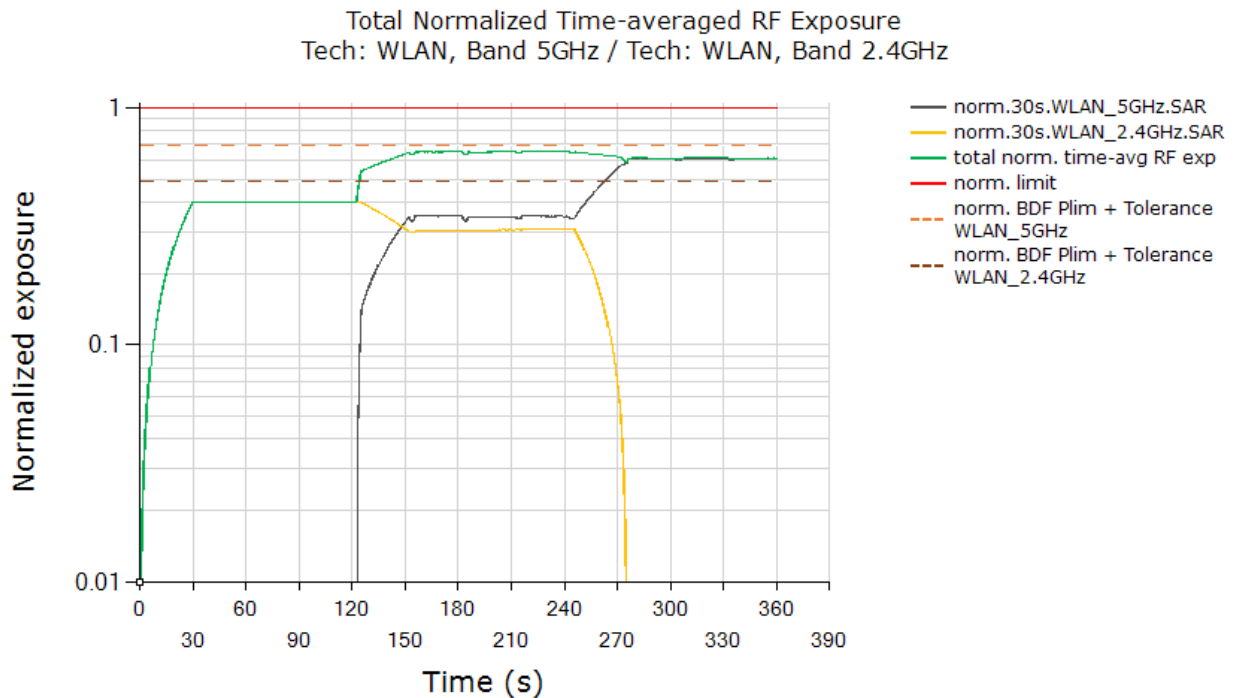

FCC normalized total exposure limit	1.0
Max time averaged normalized SAR (green curve)	0.658
Validated	

**Plot Notes:** The test result validated the continuity of power limiting in simultaneous transmission scenario.

<b>FCC ID:</b> C3K00002101	<b>RF EXPOSURE PART 2 TEST REPORT</b>	<b>Approved by:</b> Technical Manager
<b>Document S/N:</b> 1M2503050023-03.C3K (Rev3)	<b>DUT Type:</b> Wireless Module	Page 29 of 39

## 8 SYSTEM VERIFICATION (FREQ < 6 GHZ)

### 8.1 Tissue Verification

**Table 8-1  
Measured Tissue Properties**

Calibrated for Tests Performed on:	Tissue Type	Tissue Temp During Calibration (°C)	Measured Frequency (MHz)	Measured Conductivity, $\sigma$ (S/m)	Measured Dielectric Constant, $\epsilon$	TARGET Conductivity, $\sigma$ (S/m)	TARGET Dielectric Constant, $\epsilon$	% dev $\sigma$	% dev $\epsilon$
2/26/2025	2450 Head	20.2	2320	1.65	41.03	1.69	39.46	-2.43%	3.98%
			2400	1.70	40.94	1.76	39.29	-2.96%	4.20%
			2450	1.74	40.88	1.80	39.20	-3.33%	4.29%
			2480	1.76	40.84	1.83	39.16	-3.87%	4.27%
			2500	1.78	40.80	1.86	39.14	-4.15%	4.25%
2/28/2025	5200-5800 Head	23.2	5700	5.04	36.56	5.17	35.41	-2.52%	3.23%
			5710	5.05	36.56	5.18	35.40	-2.55%	3.26%
			5720	5.06	36.53	5.19	35.39	-2.54%	3.22%
			5745	5.09	36.48	5.21	35.36	-2.42%	3.15%
			5750	5.10	36.46	5.22	35.36	-2.36%	3.13%
			5755	5.10	36.46	5.22	35.35	-2.34%	3.13%
			5765	5.11	36.44	5.23	35.34	-2.33%	3.12%
			5775	5.12	36.42	5.25	35.33	-2.31%	3.09%
			5785	5.14	36.41	5.26	35.32	-2.28%	3.10%
			5795	5.15	36.40	5.27	35.31	-2.26%	3.09%
			5805	5.16	36.39	5.28	35.29	-2.24%	3.10%
			5825	5.18	36.34	5.30	35.27	-2.21%	3.03%
			5835	5.19	36.32	5.31	35.23	-2.13%	3.10%
			5845	5.21	36.32	5.32	35.21	-2.05%	3.15%
			5850	5.21	36.31	5.32	35.20	-2.01%	3.16%
			5855	5.22	36.30	5.33	35.20	-1.97%	3.15%
			5875	5.24	36.27	5.35	35.18	-1.95%	3.09%
5885	5.25	36.26	5.36	35.18	-1.94%	3.08%			
			5905	5.27	36.23	5.38	35.16	-2.04%	3.05%

The above measured tissue parameters were used in the DASY software. The DASY software was used to perform interpolation to determine the dielectric parameters at the SAR test device frequencies (per KDB Publication 865664 D01v01r04 and IEEE 1528-2013 6.6.1.2). The tissue parameters listed in the SAR test plots may slightly differ from the table above due to significant digit rounding in the software.

FCC ID: C3K00002101	RF EXPOSURE PART 2 TEST REPORT	Approved by: Technical Manager
Document S/N: 1M2503050023-03.C3K (Rev3)	DUT Type: Wireless Module	Page 30 of 39

## 8.2 Test System Verification

Prior to SAR assessment, the system is verified to  $\pm 10\%$  of the SAR measurement on the reference dipole at the time of calibration by the calibration facility. Full system validation status and result summary can be found in Appendix C.

**Table 8-2  
System Verification Results**

System Verification TARGET & MEASURED													
SAR System #	Tissue Frequency (MHz)	Tissue Type	Date	Amb. Temp (°C)	Liquid Temp (°C)	Input Power (W)	Source SN	Probe SN	DAE	Measured SAR <sub>1g</sub> (W/kg)	1 W Target SAR <sub>1g</sub> (W/kg)	1 W Normalized SAR <sub>1g</sub> (W/kg)	Deviation n <sub>1g</sub> (%)
S	2450	HEAD	2/26/2025	21.1	20.2	0.100	797	7803	1583	5.360	52.000	53.600	3.08%
S	5850	HEAD	2/28/2025	23.3	22.0	0.050	1057	7803	1583	4.130	81.500	82.600	1.35%

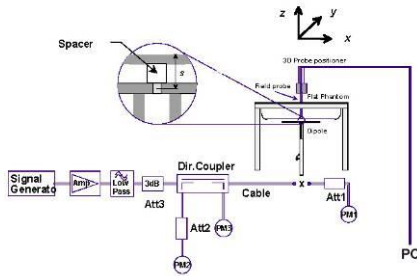

**Figure 8-1  
System Verification Setup Diagram**



**Figure 8-2  
System Verification Setup Photo**

FCC ID: C3K00002101	RF EXPOSURE PART 2 TEST REPORT	Approved by: Technical Manager
Document S/N: 1M2503050023-03.C3K (Rev3)	DUT Type: Wireless Module	Page 31 of 39

## 9 SAR TEST RESULTS (FREQ < 6 GHZ)

### 9.1 Time-varying Tx Power Case

Following Section 4.4 procedure, time-averaged SAR measurements are conducted using a SAR probe at peak location of area scan over 120 seconds. cDASY6 system verification for SAR measurement is provided in Section 10, and the associated SPEAG certificates are attached in Appendix F.

SAR probe integration times depend on the communication signal being tested as defined in the probe calibration parameters.

Since the sampling rate used by cDASY6 for pointSAR measurements is not in user control, the number of points in 30s interval is determined from the scan duration setting in cDASY6 time-average pointSAR measurement by (30s cDASY6\_scan\_duration \* total number of pointSAR values recorded). Running average is performed over these number of points in excel spreadsheet to obtain 30s averaged point SAR.

Following Section 4.4, for each of selected technology/band (listed in Table 6-2):

1. With *Reserve\_margin* set to 0 dB, area scan is performed at  $P_{limit}$ , and time-averaged pointSAR measurements are conducted to determine the pointSAR at  $P_{limit}$  at peak location, denoted as  $pointSAR_{P_{limit}}$ .
2. With *Reserve\_margin* set to actual (intended) value, two more time-averaged pointSAR measurements are performed at the same peak location for test sequences 1 and 2.

To demonstrate compliance, all the pointSAR measurement results were converted into 1gSAR or 10gSAR values by using Equation (3a), rewritten below:

$$1g\_or\_10gSAR(t) = \frac{pointSAR(t)}{pointSAR_{P_{limit}}} * 1g\_or\_10gSAR_{P_{limit}} \quad (3a)$$

where,  $pointSAR(t)$ ,  $pointSAR_{P_{limit}}$ , and  $1g\_or\_10gSAR_{P_{limit}}$  correspond to the measured instantaneous point SAR, measured point SAR at  $P_{limit}$  from above step 1 and 2, and measured 1gSAR or 10gSAR values at  $P_{limit}$  obtained from Part 1 report and listed in Table 6-2 of this report.

FCC ID: C3K00002101	<b>RF EXPOSURE PART 2 TEST REPORT</b>	<b>Approved by:</b> Technical Manager
<b>Document S/N:</b> 1M2503050023-03.C3K (Rev3)	<b>DUT Type:</b> Wireless Module	Page 32 of 39



### 9.1.1 WLAN Band 2.4 GHz, Antenna R

SAR test results for test sequence 1:

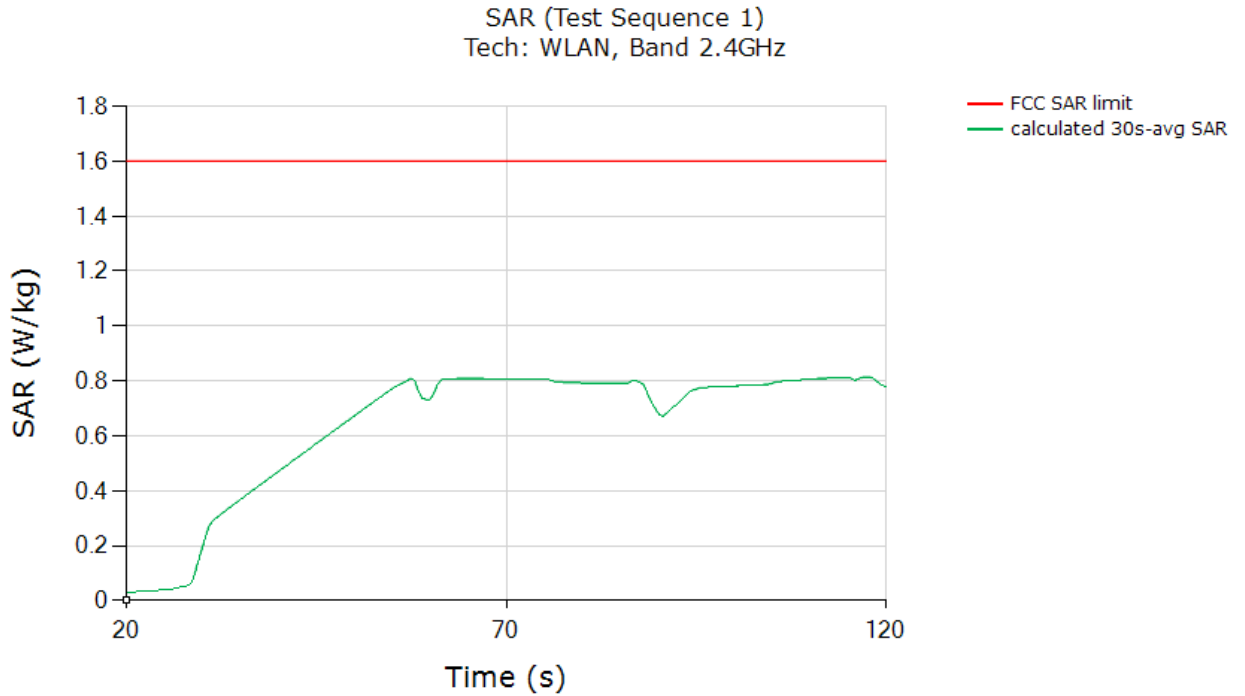

	(W/kg)
FCC 1gSAR limit	1.6
Max 30s-time averaged point 1gSAR (green curve)	0.814
Validated: Max time averaged SAR (green curve) is within 1 dB device uncertainty of measured SAR at $P_{limit}$ (worst case SAR at $P_{lim}$ column in Table 6-2).	

FCC ID: C3K00002101	<b>RF EXPOSURE PART 2 TEST REPORT</b>	Approved by: Technical Manager
Document S/N: 1M2503050023-03.C3K (Rev3)	DUT Type: Wireless Module	Page 33 of 39

### 9.1.2 WLAN Band 5 GHz, Antenna R

SAR test results for test sequence 1:

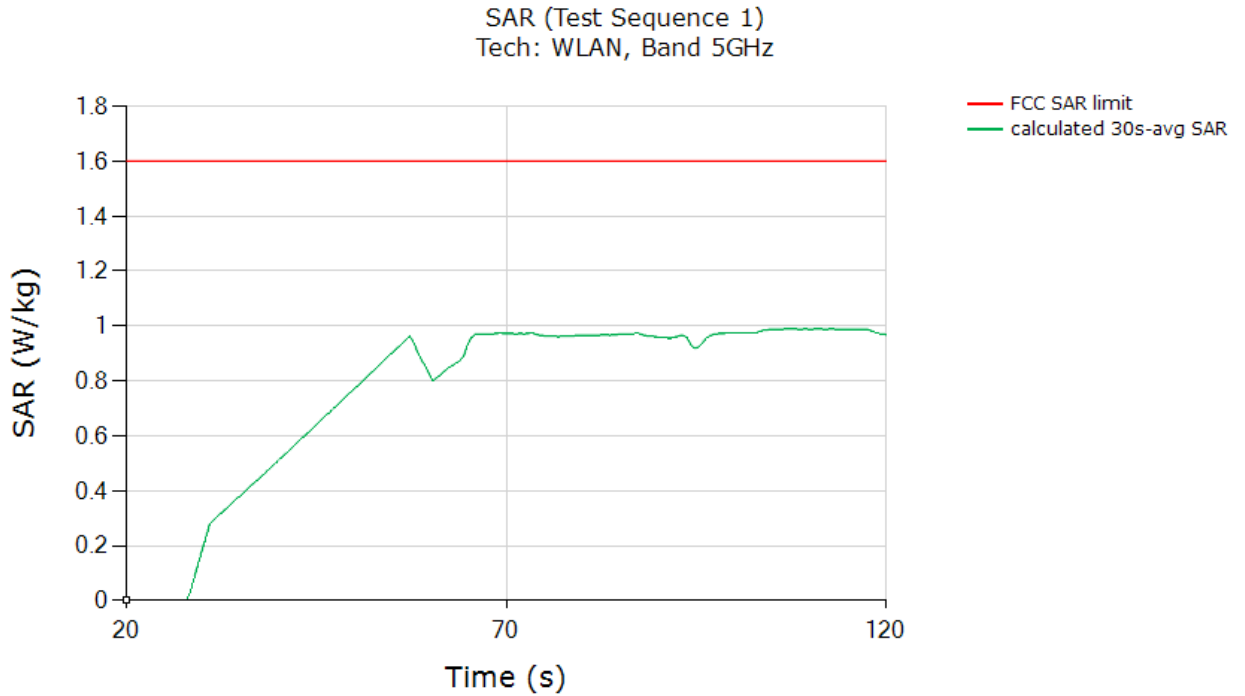

	(W/kg)
FCC 1gSAR limit	1.6
Max 30s-time averaged point 1gSAR (green curve)	0.997
<b>Validated:</b> Max time averaged SAR (green curve) is within 1 dB device uncertainty of measured SAR at $P_{limit}$ (worst case SAR at Plim column in Table 6-2).	

<b>FCC ID:</b> C3K00002101	<b>RF EXPOSURE PART 2 TEST REPORT</b>	<b>Approved by:</b> Technical Manager
<b>Document S/N:</b> 1M2503050023-03.C3K (Rev3)	<b>DUT Type:</b> Wireless Module	Page 34 of 39

## 10 EQUIPMENT LIST

Manufacturer	Model	Description	Cal Date	Cal Interval	Cal Due	Serial Number
Agilent	E4404B	Spectrum Analyzer	N/A	N/A	N/A	MY45113242
Agilent	E4438C	ESG Vector Signal Generator	10/23/2024	Annual	10/23/2025	MY45093852
Agilent	E4438C	ESG Vector Signal Generator	3/25/2024	Annual	3/25/2025	MY47270002
Agilent	N5182A	MXG Vector Signal Generator	7/9/2024	Annual	7/9/2025	MY48180366
Agilent	8753ES	S-Parameter Vector Network Analyzer	9/25/2024	Annual	9/25/2025	MY40003841
Amplifier Research	1551G6	Amplifier	CBT	N/A	CBT	433972
Anritsu	MA24106A	USB Power Sensor	4/15/2024	Annual	4/15/2025	1827528
Anritsu	MA2411B	Pulse Power Sensor	7/10/2024	Annual	7/10/2025	1126066
COMTech	AR85729-5	Solid State Amplifier	CBT	N/A	CBT	M155A00-009
Control Company	4052	Long Stem Thermometer	2/27/2024	Biennial	2/27/2026	240174346
Control Company	4040	Therm./ Clock/ Humidity Monitor	4/15/2024	Biennial	4/15/2026	240310280
K & L	11SH10-1300/U4000	High Pass Filter	CBT	N/A	CBT	11SH10-1300/U4000 - 2
MCL	BW-N6W5+	6dB Attenuator	CBT	N/A	CBT	1139
Mini Circuits	ZA2PD2-63-S+	Power Splitter	CBT	N/A	CBT	SUU64901930
Mini Circuits	ZAPD-2-272-S+	Power Splitter	CBT	N/A	CBT	SF702001405
Mini Circuits	NLP-1200+	Low Pass Filter	CBT	N/A	CBT	VUU78201318
Mini Circuits	VHF-3800	High Pass Filter	CBT	N/A	CBT	N/A
Mini-Circuits	BW-N20W5+	DC to 18 GHz Precision Fixed 20 dB Attenuator	CBT	N/A	CBT	N/A
Mini-Circuits	NLP-2950+	Low Pass Filter DC to 2700 MHz	CBT	N/A	CBT	N/A
Mini-Circuits	NLP-1200+	Low Pass Filter DC to 1000 MHz	CBT	N/A	CBT	N/A
Mini-Circuits	BW-N20W5	Power Attenuator	CBT	N/A	CBT	1226
Narda	4216-10	Directional Coupler, 0.5 to 8.0 GHz, 10 dB	CBT	N/A	CBT	1492
Narda	4216-10	Directional Coupler, 0.5 to 8.0 GHz, 10 dB	CBT	N/A	CBT	1493
Narda	BW-S3W2	Attenuator	CBT	N/A	CBT	120
Narda	BW-S10W2+	Attenuator	CBT	N/A	CBT	831
Narda	4014C-6	4 - 8 GHz SMA 6 dB Directional Coupler	CBT	N/A	CBT	N/A
Newmark System	NSC-G2	Motion Controller	CBT	N/A	CBT	1007-D
Pasternack	PE2208-6	Bidirectional Coupler	CBT	N/A	CBT	N/A
Pasternack	PE2209-10	Bidirectional Coupler	CBT	N/A	CBT	N/A
Rohde & Schwarz	CMW500	Wideband Radio Communication Tester	1/6/2025	Annual	1/6/2026	150117
Rohde & Schwarz	CMW500	Wideband Radio Communication Tester	1/6/2025	Annual	1/6/2026	131454
Rohde & Schwarz	NRP8S	3 Path Dipole Power Sensor	10/28/2024	Annual	10/28/2025	109956
Rohde & Schwarz	NRP8S	3 Path Dipole Power Sensor	9/24/2024	Annual	9/24/2025	109958
SPEAG	DAK-3.5	Dielectric Assessment Kit	11/5/2024	Annual	11/5/2025	1277
SPEAG	D2450V2	2450 MHz Sar Dipole	11/15/2022	Triennial	11/15/2025	797
SPEAG	D5GHzV2	5 GHz SAR Dipole	2/21/2025	Biennial	2/21/2026	1057
SPEAG	DAE4	Dasy Data Acquisition Electronics	7/8/2024	Annual	7/8/2025	1583
SPEAG	EX3DV4	SAR Probe	6/28/2024	Annual	6/28/2025	7803

**Notes:**

1. CBT (Calibrated Before Testing). Prior to testing, the measurement paths containing a cable, amplifier, attenuator, coupler, or filter were connected to a calibrated source (i.e. a signal generator) to determine the losses of the measurement path. The power meter offset was then adjusted to compensate for the measurement system losses. This level offset is stored within the power meter before measurements are made. This calibration verification procedure applies to the system verification and output power measurements. The calibrated reading is then taken directly from the power meter after compensation of the losses for all final power measurements.
2. Each equipment item is used solely within its respective calibration period.

FCC ID: C3K00002101	<b>RF EXPOSURE PART 2 TEST REPORT</b>	<b>Approved by:</b> Technical Manager
Document S/N: 1M2503050023-03.C3K (Rev3)	DUT Type: Wireless Module	Page 35 of 39

# 11 MEASUREMENT UNCERTAINTIES

## For SAR Measurements

a	c	d	e= f(d,k)	f	g	h = c x f/e	i = c x g/e	k
Uncertainty Component	Tol. (± %)	Prob. Dist.	Div. Div.	c <sub>1</sub> 1gm	c <sub>1</sub> 10 gms	1gm u <sub>1</sub> (± %)	10gms u <sub>1</sub> (± %)	v <sub>1</sub>
<b>Measurement System</b>								
Probe Calibration	6.55	N	1	1.0	1.0	6.6	6.6	∞
Axial Isotropy	0.25	N	1	0.7	0.7	0.2	0.2	∞
Hemishperical Isotropy	1.3	N	1	0.7	0.7	0.9	0.9	∞
Boundary Effect	2.0	R	1.73	1.0	1.0	1.2	1.2	∞
Linearity	0.3	N	1	1.0	1.0	0.3	0.3	∞
System Detection Limits	0.25	R	1.73	1.0	1.0	0.1	0.1	∞
Readout Electronics	0.3	N	1	1.0	1.0	0.3	0.3	∞
Response Time	0.8	R	1.73	1.0	1.0	0.5	0.5	∞
Integration Time	2.6	R	1.73	1.0	1.0	1.5	1.5	∞
RF Ambient Conditions - Noise	3.0	R	1.73	1.0	1.0	1.7	1.7	∞
RF Ambient Conditions - Reflections	3.0	R	1.73	1.0	1.0	1.7	1.7	∞
Probe Positioner Mechanical Tolerance	0.4	R	1.73	1.0	1.0	0.2	0.2	∞
Probe Positioning w/ respect to Phantom	6.7	R	1.73	1.0	1.0	3.9	3.9	∞
Extrapolation, Interpolation & Integration algorithms for Max. SAR Evaluation	4.0	R	1.73	1.0	1.0	2.3	2.3	∞
<b>Test Sample Related</b>								
Test Sample Positioning	2.7	N	1	1.0	1.0	2.7	2.7	35
Device Holder Uncertainty	1.67	N	1	1.0	1.0	1.7	1.7	5
Output Power Variation - SAR drift measurement	5.0	R	1.73	1.0	1.0	2.9	2.9	∞
SAR Scaling	0.0	R	1.73	1.0	1.0	0.0	0.0	∞
<b>Phantom &amp; Tissue Parameters</b>								
Phantom Uncertainty (Shape & Thickness tolerances)	7.6	R	1.73	1.0	1.0	4.4	4.4	∞
Liquid Conductivity - measurement uncertainty	4.2	N	1	0.78	0.71	3.3	3.0	10
Liquid Permittivity - measurement uncertainty	4.1	N	1	0.23	0.26	1.0	1.1	10
Liquid Conductivity - Temperature Uncertainty	3.4	R	1.73	0.78	0.71	1.5	1.4	∞
Liquid Permittivity - Temperature Uncertainty	0.6	R	1.73	0.23	0.26	0.1	0.1	∞
Liquid Conductivity - deviation from target values	5.0	R	1.73	0.64	0.43	1.8	1.2	∞
Liquid Permittivity - deviation from target values	5.0	R	1.73	0.60	0.49	1.7	1.4	∞
<b>Combined Standard Uncertainty (k=1)</b>	RSS					11.5	11.3	60
<b>Expanded Uncertainty</b> (95% CONFIDENCE LEVEL)	k=2					23.0	22.6	

<b>FCC ID:</b> C3K00002101	<b>RF EXPOSURE PART 2 TEST REPORT</b>	<b>Approved by:</b> Technical Manager
<b>Document S/N:</b> 1M2503050023-03.C3K (Rev3)	<b>DUT Type:</b> Wireless Module	Page 36 of 39

## 12 CONCLUSION

### 12.1 Measurement Conclusion

The SAR evaluation indicates that the DUT complies with the RF radiation exposure limits of the FCC and Innovation, Science, and Economic Development Canada, with respect to all parameters subject to this test. These measurements were taken to simulate the RF effects of RF exposure under worst-case conditions. Precise laboratory measures were taken to assure repeatability of the tests. The results and statements relate only to the item(s) tested.

Please note that the absorption and distribution of electromagnetic energy in the body are very complex phenomena that depend on the mass, shape, and size of the body, the orientation of the body with respect to the field vectors, and the electrical properties of both the body and the environment. Other variables that may play a substantial role in possible biological effects are those that characterize the environment (e.g. ambient temperature, air velocity, relative humidity, and body insulation) and those that characterize the individual (e.g. age, gender, activity level, debilitation, or disease). Because various factors may interact with one another to vary the specific biological outcome of an exposure to electromagnetic fields, any protection guide should consider maximal amplification of biological effects as a result of field-body interactions, environmental conditions, and physiological variables. [3]

<b>FCC ID:</b> C3K00002101	<b>RF EXPOSURE PART 2 TEST REPORT</b>	<b>Approved by:</b> Technical Manager
<b>Document S/N:</b> 1M2503050023-03.C3K (Rev3)	<b>DUT Type:</b> Wireless Module	Page 37 of 39

## 13 REFERENCES

- [1] Federal Communications Commission, ET Docket 93-62, Guidelines for Evaluating the Environmental Effects of Radiofrequency Radiation, Aug. 1996.
- [2] ANSI/IEEE C95.1-2005, American National Standard safety levels with respect to human exposure to radio frequency electromagnetic fields, 3kHz to 300GHz, New York: IEEE, 2006.
- [3] ANSI/IEEE C95.1-1992, American National Standard safety levels with respect to human exposure to radio frequency electromagnetic fields, 3kHz to 300GHz, New York: IEEE, Sept. 1992.
- [4] ANSI/IEEE C95.3-2002, IEEE Recommended Practice for the Measurement of Potentially Hazardous Electromagnetic Fields - RF and Microwave, New York: IEEE, December 2002.
- [5] IEEE Standards Coordinating Committee 39 –Standards Coordinating Committee 34 – IEEE Std. 1528-2013, IEEE Recommended Practice for Determining the Peak Spatial-Average Specific Absorption Rate (SAR) in the Human Head from Wireless Communications Devices: Measurement Techniques.
- [6] NCRP, National Council on Radiation Protection and Measurements, Biological Effects and Exposure Criteria for RadioFrequency Electromagnetic Fields, NCRP Report No. 86, 1986. Reprinted Feb. 1995.
- [7] T. Schmid, O. Egger, N. Kuster, Automated E-field scanning system for dosimetric assessments, IEEE Transaction on Microwave Theory and Techniques, vol. 44, Jan. 1996, pp. 105-113.
- [8] K. Pokovic, T. Schmid, N. Kuster, Robust setup for precise calibration of E-field probes in tissue simulating liquids at mobile communications frequencies, ICECOM97, Oct. 1997, pp. 1 -124.
- [9] K. Pokovic, T. Schmid, and N. Kuster, E-field Probe with improved isotropy in brain simulating liquids, Proceedings of the ELMAR, Zadar, Croatia, June 23-25, 1996, pp. 172-175.
- [10] Schmid & Partner Engineering AG, Application Note: Data Storage and Evaluation, June 1998, p2.
- [11] V. Hombach, K. Meier, M. Burkhardt, E. Kuhn, N. Kuster, The Dependence of EM Energy Absorption upon Human Modeling at 900 MHz, IEEE Transaction on Microwave Theory and Techniques, vol. 44 no. 10, Oct. 1996, pp. 1865-1873.
- [12] N. Kuster and Q. Balzano, Energy absorption mechanism by biological bodies in the near field of dipole antennas above 300MHz, IEEE Transaction on Vehicular Technology, vol. 41, no. 1, Feb. 1992, pp. 17-23.
- [13] G. Hartsgrove, A. Kraszewski, A. Surowiec, Simulated Biological Materials for Electromagnetic Radiation Absorption Studies, University of Ottawa, Bioelectromagnetics, Canada: 1987, pp. 29-36.
- [14] Q. Balzano, O. Garay, T. Manning Jr., Electromagnetic Energy Exposure of Simulated Users of Portable Cellular Telephones, IEEE Transactions on Vehicular Technology, vol. 44, no.3, Aug. 1995.
- [15] W. Gander, Computermathematick, Birkhaeuser, Basel, 1992.
- [16] W.H. Press, S.A. Teukolsky, W.T. Vetterling, and B.P. Flannery, Numerical Recipes in C, The Art of Scientific Computing, Second edition, Cambridge University Press, 1992.

<b>FCC ID:</b> C3K00002101	<b>RF EXPOSURE PART 2 TEST REPORT</b>	<b>Approved by:</b> Technical Manager
<b>Document S/N:</b> 1M2503050023-03.C3K (Rev3)	<b>DUT Type:</b> Wireless Module	Page 38 of 39

- [17] N. Kuster, R. Kastle, T. Schmid, Dosimetric evaluation of mobile communications equipment with known precision, IEEE Transaction on Communications, vol. E80-B, no. 5, May 1997, pp. 645-652.
- [18] CENELEC CLC/SC111B, European Prestandard (prENV 50166-2), Human Exposure to Electromagnetic Fields High-frequency: 10kHz-300GHz, Jan. 1995.
- [19] Prof. Dr. Niels Kuster, ETH, Eidgenössische Technische Hochschule Zürich, Dosimetric Evaluation of the Cellular Phone.
- [20] IEC 62209-1, Measurement procedure for the assessment of specific absorption rate of human exposure to radio frequency fields from hand-held and body-mounted wireless communication devices - Part 1: Devices used next to the ear (Frequency range of 300 MHz to 6 GHz), July 2016.
- [21] Innovation, Science, Economic Development Canada RSS-102 Radio Frequency Exposure Compliance of Radiocommunication Apparatus (All Frequency Bands) Issue 5, March 2015.
- [22] Health Canada Safety Code 6 Limits of Human Exposure to Radio Frequency Electromagnetic Fields in the Frequency Range from 3 kHz – 300 GHz, 2015
- [23] FCC SAR Test Procedures for 2G-3G Devices, Mobile Hotspot and UMPC Devices KDB Publications 941225, D01-D07
- [24] SAR Measurement Guidance for IEEE 802.11 Transmitters, KDB Publication 248227 D01
- [25] FCC SAR Considerations for Handsets with Multiple Transmitters and Antennas, KDB Publications 648474 D03-D04
- [26] FCC SAR Evaluation Considerations for Laptop, Notebook, Netbook and Tablet Computers, FCC KDB Publication 616217 D04
- [27] FCC SAR Measurement and Reporting Requirements for 100MHz – 6 GHz, KDB Publications 865664 D01-D02
- [28] FCC General RF Exposure Guidance and SAR Procedures for Dongles, KDB Publication 447498, D01-D02
- [29] Anexo à Resolução No. 533, de 10 de Setembro de 2009.
- [30] IEC 62209-2, Human exposure to radio frequency fields from hand-held and body-mounted wireless communication devices - Human models, instrumentation, and procedures - Part 2: Procedure to determine the specific absorption rate (SAR) for wireless communication devices used in close proximity to the human body (frequency range of 30 MHz to 6 GHz), Mar. 2010.

<b>FCC ID:</b> C3K00002101	<b>RF EXPOSURE PART 2 TEST REPORT</b>	<b>Approved by:</b> Technical Manager
<b>Document S/N:</b> 1M2503050023-03.C3K (Rev3)	<b>DUT Type:</b> Wireless Module	Page 39 of 39

# APPENDIX A: VERIFICATION PLOTS

<b>FCC ID:</b> C3K-00002101	<b>RF EXPOSURE PART 2 TEST REPORT</b>	<b>Approved by:</b> Technical Manager
<b>DUT Type:</b> Wireless Module		Appendix B Page 1 of 1



# APPENDIX B: SAR TISSUE SPECIFICATIONS

## Measurement Procedure for Tissue verification:

- 1) The network analyzer and probe system was configured and calibrated.
- 2) The probe was immersed in the tissue. The tissue was placed in a nonmetallic container. Trapped air bubbles beneath the flange were minimized by placing the probe at a slight angle.
- 3) The complex admittance with respect to the probe aperture was measured
- 4) The complex relative permittivity  $\epsilon'$  can be calculated from the below equation (Pournaropoulos and Misra):

$$Y = \frac{j2\omega\epsilon_r\epsilon_0}{[\ln(b/a)]^2} \int_a^b \int_a^b \int_0^\pi \cos\phi' \frac{\exp[-j\omega r(\mu_0\epsilon_r'\epsilon_0)^{1/2}]}{r} d\phi' d\rho' d\rho$$

where  $Y$  is the admittance of the probe in contact with the sample, the primed and unprimed coordinates refer to source and observation points, respectively,  $r^2 = \rho^2 + \rho'^2 - 2\rho\rho' \cos\phi'$ ,  $\omega$  is the angular frequency, and  $j = \sqrt{-1}$ .

### 3 Composition / Information on ingredients

#### 3.2 Mixtures

**Description:** Aqueous solution with surfactants and inhibitors

**Declarable, or hazardous components:**

CAS: 107-21-1 EINECS: 203-473-3 Reg.nr.: 01-2119456816-28-0000	<b>Ethanediol</b> STOT RE 2, H373; Acute Tox. 4, H302	>1.0-4.9%
CAS: 68608-26-4 EINECS: 271-781-5 Reg.nr.: 01-2119527859-22-0000	<b>Sodium petroleum sulfonate</b> Eye Irrit. 2, H319	< 2.9%
CAS: 107-41-5 EINECS: 203-489-0 Reg.nr.: 01-2119539582-35-0000	<b>Hexylene Glycol / 2-Methyl-pentane-2,4-diol</b> Skin Irrit. 2, H315; Eye Irrit. 2, H319	< 2.9%
CAS: 68920-66-1 NLP: 500-236-9 Reg.nr.: 01-2119489407-26-0000	<b>Alkoxyated alcohol, &gt; C<sub>16</sub></b> Aquatic Chronic 2, H411; Skin Irrit. 2, H315; Eye Irrit. 2, H319	< 2.0%

**Additional information:**

For the wording of the listed risk phrases refer to section 16.

Not mentioned CAS-, EINECS- or registration numbers are to be regarded as Proprietary/Confidential.

The specific chemical identity and/or exact percentage concentration of proprietary components is withheld as a trade secret.

**Figure B-1**

Note: Liquid recipes are proprietary SPEAG. Since the composition is approximate to the actual liquids utilized, the manufacturer tissue-equivalent liquid data sheets are provided below.

FCC ID: C3K-00002101	RF EXPOSURE PART 2 TEST REPORT	Approved by: Technical Manager
DUT Type: Wireless Module		Appendix B Page 1 of 2

**Measurement Certificate / Material Test**

Item Name	Head Tissue Simulating Liquid (HBBL600-10000V6)
Product No.	SL AAH U16 BC (Batch: 230313-2)
Manufacturer	SPEAG

**Measurement Method**

TSL dielectric parameters measured using calibrated DAK probe.

**Target Parameters**

Target parameters as defined in the IEEE 1528 and IEC 62209 compliance standards.

**Test Condition**

Ambient Condition 22°C ; 30% humidity  
 TSL Temperature 22°C  
 Test Date 17-Mar-23  
 Operator WM

**Additional Information**

TSL Density  
 TSL Heat-capacity

**Results**

f [MHz]	Measured			Target		Diff.to Target [%]	
	e'	e''	sigma	eps	sigma	Δ-eps	Δ-sigma
600	44.9	24.8	0.83	42.7	0.88	5.1	-5.9
750	44.2	21.0	0.88	41.9	0.89	5.4	-1.5
800	44.0	20.1	0.90	41.7	0.90	5.6	0.3
825	44.0	19.8	0.91	41.6	0.91	5.8	0.4
835	44.0	19.6	0.92	41.5	0.91	5.9	0.9
850	43.9	19.4	0.92	41.5	0.92	5.8	0.4
900	43.7	18.7	0.94	41.5	0.97	5.3	-3.1
1400	42.6	14.7	1.15	40.6	1.18	4.9	-2.5
1450	42.5	14.5	1.17	40.5	1.20	4.9	-2.5
1600	42.3	14.0	1.25	40.3	1.28	4.9	-2.7
1625	42.3	13.9	1.26	40.3	1.30	5.0	-3.0
1640	42.3	13.9	1.27	40.3	1.31	5.1	-2.8
1650	42.2	13.9	1.27	40.2	1.31	4.9	-3.3
1700	42.1	13.8	1.30	40.2	1.34	4.8	-3.1
1750	42.1	13.7	1.33	40.1	1.37	5.0	-3.0
1800	42.0	13.6	1.36	40.0	1.40	5.0	-2.9
1810	42.0	13.6	1.37	40.0	1.40	5.0	-2.1
1825	42.0	13.5	1.38	40.0	1.40	5.0	-1.4
1850	42.0	13.5	1.39	40.0	1.40	5.0	-0.7
1900	41.9	13.4	1.42	40.0	1.40	4.7	1.4
1950	41.8	13.4	1.45	40.0	1.40	4.5	3.6
2000	41.8	13.3	1.48	40.0	1.40	4.5	5.7
2050	41.7	13.3	1.51	39.9	1.44	4.5	4.5
2100	41.7	13.2	1.55	39.8	1.49	4.7	4.1
2150	41.6	13.2	1.58	39.7	1.53	4.7	3.0
2200	41.5	13.2	1.62	39.6	1.58	4.7	2.7
2250	41.4	13.2	1.65	39.6	1.62	4.7	1.7
2300	41.3	13.2	1.69	39.5	1.67	4.6	1.4
2350	41.3	13.3	1.73	39.4	1.71	4.9	1.1
2400	41.2	13.3	1.77	39.3	1.76	4.9	0.8
2450	41.1	13.3	1.81	39.2	1.80	4.8	0.6
2500	41.1	13.3	1.85	39.1	1.85	5.0	-0.2
2550	41.0	13.3	1.89	39.1	1.91	4.9	-1.0
2600	40.9	13.4	1.93	39.0	1.96	4.8	-1.7

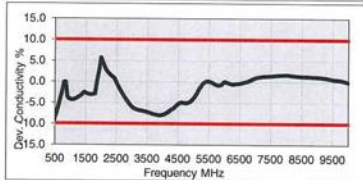
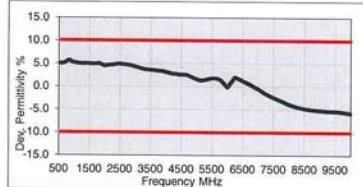

3500	39.3	13.9	2.70	37.9	2.91	3.6	-7.2
3700	39.0	14.0	2.88	37.7	3.12	3.4	-7.7
5200	36.5	15.8	4.58	36.0	4.66	1.3	-1.5
5250	36.4	16.0	4.66	35.9	4.71	1.4	-1.0
5300	36.4	16.1	4.73	35.9	4.76	1.5	-0.5
5500	36.3	16.2	4.97	35.6	4.96	1.8	0.1
5600	36.2	16.2	5.06	35.5	5.07	1.8	-0.2
5700	36.0	16.2	5.14	35.4	5.17	1.6	-0.6
5800	35.7	16.2	5.22	35.3	5.27	1.2	-0.9
6000	35.0	16.4	5.48	35.1	5.48	-0.2	0.1
6500	34.9	16.7	6.05	34.5	6.07	1.2	-0.4
7000	33.7	17.2	6.72	33.9	6.65	-0.6	1.0
7500	32.5	17.6	7.34	33.3	7.24	-2.5	1.4
8000	31.4	17.9	7.97	32.7	7.84	-3.9	1.7
8500	30.6	18.1	8.57	32.1	8.45	-4.8	1.3
9000	29.9	18.3	9.18	31.5	9.08	-5.2	1.2
9500	29.3	18.5	9.77	31.0	9.71	-5.4	0.6
10000	28.6	18.6	10.35	30.4	10.36	-5.9	-0.1

**Figure B-2**  
**600 – 5800 MHz Head Tissue Equivalent Matter**

FCC ID: C3K-00002101	RF EXPOSURE PART 2 TEST REPORT	Approved by: Technical Manager
DUT Type: Wireless Module		Appendix B Page 2 of 2

# APPENDIX C: SAR SYSTEM VALIDATION

Per FCC KDB Publication 865664 D02v01r02, SAR system validation status should be documented to confirm measurement accuracy. The SAR systems (including SAR probes, system components and software versions) used for this device were validated against its performance specifications prior to the SAR measurements. Reference dipoles were used with the required tissue- equivalent media for system validation, according to the procedures outlined in FCC KDB Publication 865664 D01v01r04 and IEEE 1528-2013. Since SAR probe calibrations are frequency dependent, each probe calibration point was validated at a frequency within the valid frequency range of the probe calibration point, using the system that normally operates with the probe for routine SAR measurements and according to the required tissue-equivalent media.

A tabulated summary of the system validation status including the validation date(s), measurement frequencies, SAR probes and tissue dielectric parameters has been included.

**Table C-1  
SAR System Validation Summary – 1g**

SAR System	Freq. (MHz)	Date	Probe SN	DAE	Probe Cal Point		Cond. (σ)	Perm. (εr)	CW VALIDATION			MOD. VALIDATION		
									SENSITIVITY	PROBE LINEARITY	PROBE ISOTROPY	MOD. TYPE	DUTY FACTOR	PAR
S	2450	7/29/2024	7803	1583	2450	Head	1.836	39.924	PASS	PASS	PASS	OFDM/TDD	PASS	PASS
S	5750	7/19/2024	7803	1583	5750	Head	5.262	34.250	PASS	PASS	PASS	OFDM	N/A	PASS

NOTE: Modulations in the table above represent test configurations for which the measurement system has been validated per FCC KDB Publication 865664 D01v01r04 for scenarios when CW probe calibrations are used with other signal types. SAR systems were validated for modulated signals with a periodic duty cycle, such as GMSK, or with a high peak to average ratio (>5 dB), such as OFDM according to FCC KDB Publication 865664 D01v01r04.

FCC ID: C3K-00002101	<b>RF EXPOSURE PART 2 TEST REPORT</b>	Approved by: Technical Manager
DUT Type: Wireless Module		APPENDIX C: Page 1 of 1

# APPENDIX D: TEST SETUP PHOTOGRAPHS

<b>FCC ID:</b> C3K-00002101	<b>RF EXPOSURE PART 2 TEST REPORT</b>	<b>Approved by:</b> Technical Manager
<b>DUT Type:</b> Wireless Module		APPENDIX B: Page 1 of 1

## APPENDIX E: TEST SEQUENCES

1. Test sequence is generated based on below parameters of the DUT:
  - a. Measured maximum power ( $P_{max}$ )
  - b. Measured Tx\_power\_at\_SAR\_design\_target ( $P_{limit}$ )
  - c. SAR\_time\_window (30s for FCC)

2. Test Sequence 1 Waveform:

Since WLAN radios do not have closed loop power control, average Tx power level of WLAN radios is indirectly varied by transmitting at varying duty cycles (i.e., varying UL data rates). Test sequence #1 described previously can be converted into duty cycle at  $P_{max}$ , i.e., duty cycle for an arbitrary Tx power level = (Tx power level /  $P_{max}$ ).

**Table E-1 Test Sequence 1 for WLAN radio**

Time duration (seconds)	Duty Cycle (%)
30	100%
60	50%

NOTE: Test sequence #2 is not achievable due to current test capability. Therefore, in the interim, it is exempt.

FCC ID: C3K-00002101	RF EXPOSURE PART 2 TEST REPORT	Approved by: Technical Manager
DUT Type: Wireless Module		APPENDIX B: Page 1 of 1

# APPENDIX F: CALIBRATION CERTIFICATES

<b>FCC ID:</b> A3LSMS911U	<b>PART 2 RF EXPOSURE EVALUATION REPORT</b>	<b>Approved by:</b> Technical Manager
<b>DUT Type:</b> Portable Handset		APPENDIX B: Page 1 of 1