



THIS PRODUCT HAS BEEN DESIGNED, MANUFACTURED AND  
INSPECTED IN COMPLIANCE WITH THE  
ISO9001 QUALITY ASSURANCE SYSTEM.

Part No. 11906759

# **KEC** MOBILE APPLICATIONS

**MODEL: LSMD-104**

**10.4" LCD INTEGRATED DVD MONITOR RECEIVER SYSTEM**

## **INSTALLATION INFORMATION & OPERATING INSTRUCTIONS**



**THIS PRODUCT IS INTENDED FOR PROFESSIONAL INSTALLATION ONLY**

**FOR MOBILE-SPECIFIC 12 VOLT DC-ONLY OPERATION  
PLEASE READ ALL INSTRUCTIONS BEFORE USING THIS PRODUCT**

**IMPORTANT NOTE :**

WHEN USED IN A VEHICLE, THIS SYSTEM IS INTENDED PRIMARILY AS A MONITOR FOR THE BUILT-IN DVD PLAYER OR FOR AN EXTERNAL DVD PLAYER, VIDEOCASSETTE PLAYER, VIDEO GAME, OR CAMERA. TELEVISION BROADCAST RECEPTION WILL BE ADVERSELY AFFECTED BY CONDITIONS SUCH AS MOTION, CHANGE OF DIRECTION, ATMOSPHERIC ACTIVITY, AND LOCAL SURROUNDINGS. IT IS THEREFORE LIKELY THAT BROADCAST PICTURE QUALITY WILL BE MARGINAL WHEN THIS SYSTEM IS USED IN A MOBILE ENVIRONMENT.

# CAUTIONS

## **CAUTION :**

- ANY CHANGES OR MODIFICATIONS IN THE CONSTRUCTION OF THIS DEVICE WHICH ARE NOT EXPRESSLY APPROVED BY THE PARTY RESPONSIBLE FOR COMPLIANCE COULD VOID THE USER'S AUTHORITY TO OPERATE THE EQUIPMENT.

## **WARNINGS :**

- TO PREVENT FIRE OR SHOCK HAZARD, DO NOT EXPOSE THIS UNIT TO RAIN OR MOISTURE.
- DO NOT OPEN THE CABINET. DANGEROUS HIGH VOLTAGE IS PRESENT. SERVICING SHOULD ONLY BE PERFORMED BY QUALIFIED PERSONNEL.
- THIS LCD VIDEO SYSTEM SHOULD ONLY BE OPERATED WITH 12V DC.

## **GRAPHICAL SYMBOLS EXPLANATION**



This lightning flash with arrowhead symbol, within an equilateral triangle is intended to alert the user to the presence of uninsulated "dangerous voltage" within the product's enclosure that may be of sufficient magnitude to constitute a risk of electric shock to persons.



The exclamation point within an equilateral triangle is intended to alert the user to the presence of important operating and maintenance (Servicing) instructions in the literature accompanying the appliance.

## **FCC WARNINGS :**

This equipment may generate or use radio frequency energy. Change or modifications to this equipment may cause harmful interference unless the modifications are expressly approved in the instruction manual.

The user could lose the authorization to operate this equipment if an unauthorized change or modification is made.

## IMPORTANT SAFEGUARDS

1. **Read Instructions** All safety & operating instructions should be read before operating the appliance.
2. **Retain Instructions** The safety and operating instructions should be retained for future reference.
3. **Heed Warnings** Adhere to ALL warnings on the product and in the operating instructions.
4. **Follow Instructions** All operating and use instructions should be followed.
5. **Cleaning** Unplug this product from power cable connector before cleaning. Do not use liquid cleaners or aerosol cleaners. Use a damp cloth for cleaning.
6. **Attachments** Do not use attachments not recommended by the product manufacturer as they may cause hazards.
7. **Water and Moisture** Do not install this product near water - for example, near a bath tub, washbowl, kitchen sink or laundry tub; in a wet basement; or near a swimming pool and the like.
8. **Accessories** Do not place this product on an unstable cart, stand, tripod, bracket, or table. The product may fall, causing serious injury to a child or adult, and serious damage to the equipment.  
Use only with a cart, stand, tripod, bracket, or table recommended by the manufacturer, or sold with the product. Any mounting of the product should follow the manufacturer's instructions, and should use a mounting approved by the manufacturer.
9. A product and cart combination should be moved with care. Quick stops, excessive force, and uneven surfaces may cause the product and cart combination to overturn.
10. **Ventilation** Slots and opening in the cabinet are provided for ventilation and to ensure reliable operation of the product and to protect it from overheating and these should never be blocked by placing the product on a bed, sofa, rug, or other similar surface. This product should not be placed in a built-in installation such as a bookcase or rack unless proper ventilation is provided or the manufacturer's instructions have been adhered to. 
11. **Power Sources** This product should be operated only from the type of power source indicated on the marking label. If you are not sure of the type of power supply to your car, consult your product dealer. For products intended to operate from battery power, or other source, refer to the operating instructions.
12. **Servicing** Do not attempt to service this product yourself as opening or removing covers may expose you to dangerous voltage or other hazards. Refer all servicing to qualified service personnel.
13. **Damage requiring Service** Unplug this product the wall outlet and refer servicing to qualified service personnel under the following conditions:
  - a. When the power-supply cord or plug is damaged.
  - b. If liquid has been spilled, or objects have fallen into the product.
  - c. If the product has been exposed to rain or water.
  - d. If the product does not operate normally by following the operating instructions. Adjust only those controls that are covered by the operating instructions as an improper adjustment of other controls may result in damage and will often require extensive work by a qualified technician to restore the product to its normal operation.
  - e. If the product has been dropped, or the cabinet has been damaged.
  - f. When the product exhibits a distinct change in performance-this indicates a need for service.
14. **Replacement Parts** When replacement parts are required, be sure the service technician has used replacement parts specified by the manufacturer or that have the same characteristics as the original part. Unauthorized substitutions may result in fire, electric shock or other hazards.
15. **Safety Check** Upon completion of any service or repairs to this video product, ask the service technician to perform safety checks to determine that the video product is in proper operating condition.
16. **Wall or Ceiling Mounting** The product should be mounted to a wall or ceiling only safety recommended by the manufacturer.
17. **Heat** The product should be situated away from heat sources such as radiators, heat registers, stoves, or other products (including amplifiers) that produce heat.

# TABLE OF CONTENTS

We urge you to carefully read all of the descriptions and operating procedures contained in this Owner's Manual before operating your new LSMD-104.

▶ CAUTIONS	2
▶ IMPORTANT SAFEGUARDS	3
▶ TABLE OF CONTENTS (THIS PAGE)	4
▶ FEATURES	5
▶ ACCESSORIES	6
▶ IDENTIFICATION OF LSMD-104 CONTROLS & CONNECTORS	7
▶ REMOTE CONTROL USE	9
▶ SIGNAL CONNECTION	12
▶ POWER CONNECTION	14
▶ DOME LIGHT CONNECTION	15
▶ INSTALLATION FOR VEHICLE USE	16
▶ LSMD-104 OPERATION	17
▶ TV MENU BUTTON - GENERAL INFORMATION	18
▶ TV MENU BUTTON - OPERATIONS	19
▶ PICTURE BUTTON	23
▶ STATUS BUTTON	24
▶ OTHER USEFUL FUNCTIONS	25
▶ DVD FUNCTION OPERATION	26
▶ INTRODUCTION	27
▶ DISC REQUIREMENTS/COPYRIGHT INFORMATION	29
▶ BASIC PLAYBACK	30
▶ SEARCHING FOR A SPECIFIC SCREEN OR SONG DURING PLAYBACK	31
▶ SETTING A CUSTOM VIEW	32
▶ CHANGING THE SIZE AND ANGLE OF THE SCREEN	33
▶ USING THE MENU, TITLE & SUBTITLE BUTTONS	34
▶ USING THE SETUP MENU	35
▶ SETTING A MENU	36
▶ USING THE LANGUAGE	37
▶ SETTING THE DISPLAY OPTIONS	38
▶ PARENTAL LOCK SETTINGS	39
▶ SETTING RATING LEVEL AND PASSWORD	40
▶ RECEPTION DISTURBANCE	41
▶ SPECIFICATIONS	42

# FEATURES

- 10.4 INCH TFT LCD Panel
- Built-In DVD Player
- 12 Volt DC Operation
- Wireless Remote Control
- MTS Stereo Frequency Synthesizer Tuning System
- Full On-Screen Display of all Switching Functions
- Full On-Screen Display of all Picture Functions
- Automatic Power On, Automatic Power Off & Memory Power On Functions
- High Voltage Protection (Over 18 Volts DC)
- Polarity Reversal Protection
- Four Input Selections (Built-in MTS Stereo TV Tuner, DVD, Stereo Audio/Video Inputs 1, 2)
- Low Level Stereo Audio/Video Output
- Powered Stereo External Speakers Output
- Built-In Stereo FM Transmitter with On-Screen Frequency Selection & Control
- Built-In Stereo IR Transmitter
- External Antenna Input
- 10-Year Memory Back Up
- 15' Extension Cable Supplies Power To & Receives Signal From KEC Mobile Applications VCP's

The Remote Controller that is packaged with this unit will also control any KEC Mobile Applications Videocassette or DVD Player.

## NOTES:

### **Automatic Power On Function:**

This system will automatically power on whenever the LCD screen is lowered to its viewing position.

### **Automatic Power Off Function:**

This system will automatically turn off approximately 15 minutes after it last receives a video signal.

### **Memory Power On Function:**

If this system was in power on mode when power was last removed (unplugged or ignition off), it will automatically turn on when power is reapplied.

# ACCESSORIES

Please check to make sure that all of these items have been included:

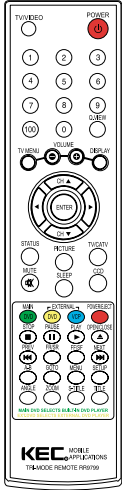

**Remote Control**



**12V DC Power Extension cable**



**A/V 1 Extension Cable**



**Owner's Manual**

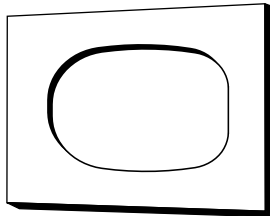

**Cutout Template**

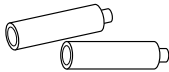

**Batteries (AAA x 2)**

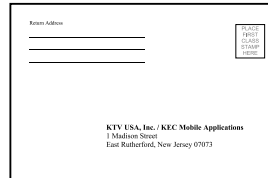

**Warranty Card**

Other general and vehicle- specific mounting and installation accessories are also available.

# IDENTIFICATION OF LSMD-104 CONTROLS & CONNECTORS

## ◆ FRONT VIEW

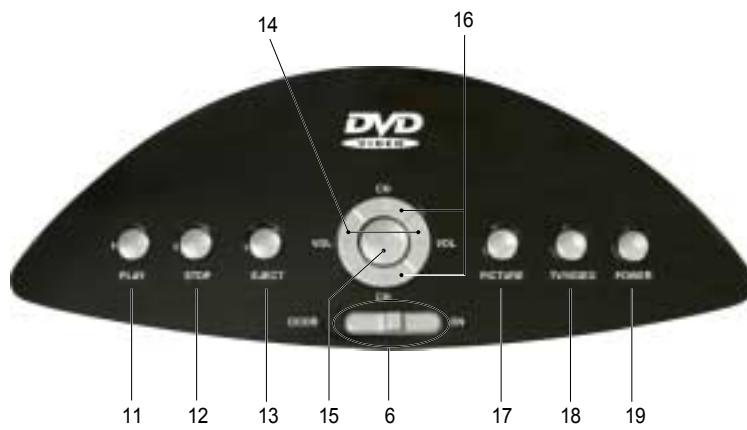
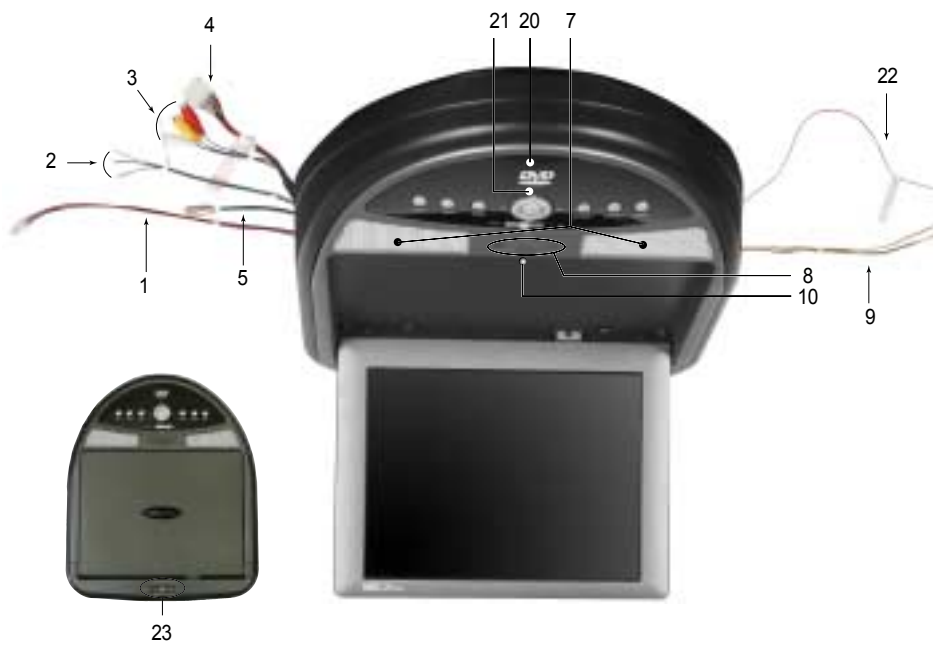



## IDENTIFICATION OF LSMD-104 CONTROLS & CONNECTORS

- 1. DC INPUT JACK**  
For connection to a source of 12 Volt DC power.
- 2. EXTERNAL SPEAKERS OUTPUT CONNECTOR**  
Supplies 2.0 W/Channel @ 4Ω (variable) for connection of optional external speakers. (L+, R+, Common Ground).
- 3. L&R AUDIO/VIDEO (THROUGH) OUTPUT JACKS**  
Supplies L&R Audio and Video signal for connection to additional monitors, external amplifiers, etc.  
When the LSMD-104 is powered on, these outputs always feed the signal from the selected input source.  
When the LSM-104 is powered off, these outputs always feed the signal from the program source connected to A/V1.
- 4. AUDIO/VIDEO 1 EXTENSION CABLE CONNECTOR**  
For connection of supplied 15 foot L&R Audio/Video 1 Extension Cable. The Extension Cable receives A/V signals from and supplies 12 Volt DC Power & R-Link Connection to an external KEC Mobile Applications VCP or DVD Player.
- 5. ANTENNA INPUT JACK**  
For connection of an external television broadcast antenna.
- 6. DOME LIGHTS SWITCH**  
Selects lighting mode.
- 7. DOME LIGHTS**  
Provides additional vehicle lighting.
- 8. LCD PANEL DROP-DOWN BUTTON**  
Side to release LCD Panel from stored position.
- 9. DOME LIGHTS POWER CONNECTION WIRES**  
Provides power to lamps (Refer to page 15 for instructions on proper connection of this 4-wire system).
- 10. AUTO POWER SWITCH**  
Lowering LCD Panel automatically turns power on.
- 11. DVD PLAY BUTTON**  
Use this button to play a disc.
- 12. DVD STOP BUTTON**  
Use this button to stop playing a disc.
- 13. DVD EJECT BUTTON**  
Use this button to eject or load a disc.
- 14. VOLUME DOWN & UP BUTTONS**  
Adjusts volume of (*optional*) speakers wired to the External Speakers Output Connector (#2). Also used in conjunction with the on-screen menus.
- 15. MENU BUTTON**  
Displays on-screen Main menu.
- 16. CHANNEL DOWN & UP BUTTONS**  
Selects the next lower or higher channel stored in memory. Also used to select menu items with some on-screen menus.
- 17. PICTURE BUTTON**  
Displays the on-screen Picture menu
- 18. TV/VIDEO BUTTON**  
Press repeatedly to select the desired program source: Broadcast TV, DVD, Video 1, Video 2.
- 19. POWER BUTTON**  
Press to power the system ON/OFF.
- 20. STAND-BY INDICATOR**  
Illuminates to indicate that 12 Volt DC Power is available, but that LCD screen is not currently powered on.
- 21. REMOTE CONTROL SENSOR**  
Receives control signals from the remote control hand unit. Also passes controls signals to an external KEC Mobile Applications Videocassette Player or DVD Player that is connected via an R-Link cable.
- 22. FM TRANSMITTER ANTENNA**  
Transmits low-power stereo audio signal for reception on the vehicle's FM Radio.
- 23. L&R AUDIO/VIDEO 2 INPUT JACKS**  
For connection of a 2nd external program source.

# REMOTE CONTROL USE

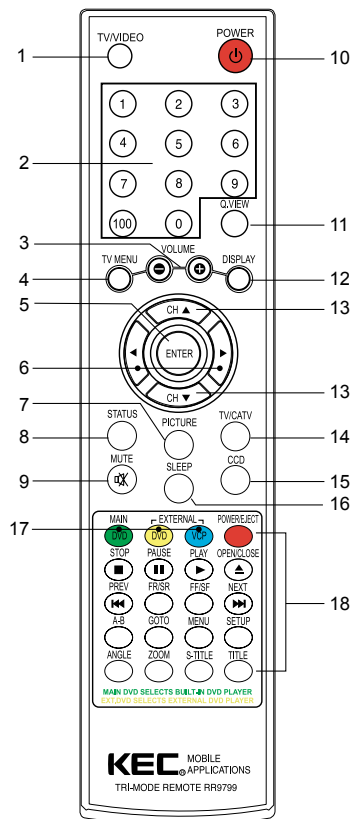

- 1. TV/VIDEO BUTTON**  
Press repeatedly to cycle program source selection between TV, DVD, VIDEO1 & VIDEO2. This button is duplicated on the LSMD-104's Control Panel.
- 2. DIRECT CHANNEL SELECTION (0 ~ 9 & 100) BUTTONS**  
Used for the direct selection of broadcast channels.
- 3. VOLUME +/- BUTTONS**  
These 2 buttons are primarily used in conjunction with the TV MENU & PICTURE buttons. However, if speakers are connected to the EXTERNAL SPEAKERS OUTPUT, they also work to adjust volume. These buttons are duplicated on the LSMD-104's Control Panel.
- 4. TV MENU BUTTON**  
Press to call up an on-screen menu. Press repeatedly to cycle through the available menu items and clear the menu from the screen. This button is duplicated on the LSMD-104's Control Panel.
- 5. ENTER BUTTON**  
Used in conjunction with Disc and Setup Menus.
- 6. LEFT ◀ / RIGHT ▶ BUTTONS**  
Used to select menu items with some on-screen menus.
- 7. PICTURE BUTTON**  
Press to call up the on-screen Picture Menu. Press repeatedly to cycle through Contrast, Brightness, Sharpness, Color, Tint or Display Off. The selected item will be displayed in MAGENTA. Adjust the desired item with the VOLUME buttons. This button is duplicated on the LSMD-104's Control Panel.
- 8. STATUS BUTTON**  
Press repeatedly to cycle between a user-adjustable picture and 3 different preset picture balances.
- 9. MUTE BUTTON**  
Press to reduce sound to minimum level. Press again to restore.
- 10. POWER BUTTON**  
Press to turn the LCD Panel ON/OFF. This button is duplicated on the LSMD-104's Control Panel.
- 11. QUICK VIEW BUTTON**  
Press to cycle between the current and the previously viewed channel. The system must be in TV mode for this button to function.
- 12. DISPLAY BUTTON**  
Press to display the Program Source (TV/CH#, DVD, VID 1, VID 2) being viewed and the SLEEP TIMER setting.
- 13. CHANNEL DOWN ▼ / UP ▲ BUTTONS**  
Press to view the next higher or lower channel stored in memory. Also used to select menu items with some on-screen menus. These buttons are duplicated on the LSMD104's Control Panel.
- 14. TV/CATV BUTTON**  
Select regular broadcast television reception or cable broadcast reception. Press repeatedly to cycle between TV and CATV modes. The system must be in TV mode for this to function.
- 15. CCD BUTTON**  
Press repeated to cycle between Closed Captions 1, Closed Captions 2, Text 1, Text 2 and Off.
- 16. SLEEP BUTTON**  
Sets the TV to automatically power off in 15-120 minutes.

# REMOTE CONTROL USE

## 17. MODE TV/DVD/VCP BUTTONS

- Press the TV MODE button to control the TV & built-in DVD Player.
- Press the DVD MODE button to control an EXTERNAL KEC DVD Player.
- Press the VCP MODE button to control an EXTERNAL KEC Videocassette Player.

### Important Notes:

- Press the GREEN DVD MODE button is used to control the built-in DVD Player.
- Press the YELLOW DVD button to control an EXTERNAL KEC DVD Player.
- Press the BLUE VCP button to control an EXTERNAL KEC VCP.

## 18. DVD & VCP CONTROLS

These controls are designed to operate KEC Mobile Applications DVD Players and Videocassette Players ONLY. Some controls may operate Products from another manufacturer, but operation will be erratic.

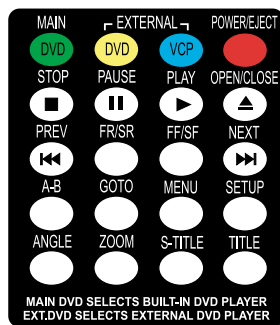

- STOP:** Used to stop the DVD or videotape.
- PAUSE:** Used to "freeze" the picture on the DVD or videotape.
- PLAY:** Used to play a recorded videotape or DVD.
- OPEN/CLOSE:** Used to eject the videocassette or disc.
- PREVIOUS:** Use this button to move to the DVD's previous chapter.
- FR/SR:** Used to Fast or Slow Reverse the DVD or videotape.
- FF/SF:** Used to Fast or Slow Forward the DVD or videotape.
- NEXT:** Use this button to move to the DVD's next chapter.
- A-B:** Use this button to repeat the selected segment, or for specifying and repeating playback of a segment.
- GOTO:** Use this button for jumping to a specified location.

**MENU:** Use this button to display the contents menu of the DVD. This function is disc dependent. A disc may not contain a contents menu and different discs may have widely differing menus.

**STEUP:** Use this button to display the LSMD-104's built-in setup menus for Language, Video, Audio and Parental Control.

**ANGLE:** If a disc includes multi angle information, the user can view screens in multiple angles. This function is limited to discs which support multi angle information.

**ZOOM:** Use this button to enlarge the screen image up to 4 times. You may also move around the image using the ARROW buttons (#6, #13).

**S-TITLE:** Use this button to change the subtitle language to a different language or from the one selected at the initial settings. This function is disc dependent. A disc may not contain no subtitles and different discs will contain differing subtitles.

**TITLE :** Use this button to display the title menu of the DVD.

## REMOTE CONTROL USE



### NOTES :

- The Remote control should be directed at the Remote Control sensor just below the LCD Screen as shown above.
- The maximum operating distance of the Remote Control is about 10 feet.
- The Remote Control should be kept away from UV exposure which may disrupt its operation. It may be difficult to receive Remote Control signals when UV is present. If this occurs, it will be necessary to operate it closer to the Remote Control Sensor.

### REMOTE CONTROL BATTERY INSTALLATION

It is time to replace the batteries when the remote control is not working properly.  
( Alkaline batteries usually last for 6 months to 1 year. )

- Press battery compartment tab in the direction of the arrow and lift off cover.
- Install new batteries in the compartment. Be sure to observe the correct polarity (+/-) as indicated in the compartment.
- Use only new AAA batteries of the same type.
- If batteries become exhausted, remove them immediately to avoid leakage.
- Should battery leakage occur, clean the battery compartment with a soft cloth and replace with new batteries.

CAUTION : Avoid dropping the remote control.

# SIGNAL CONNECTION

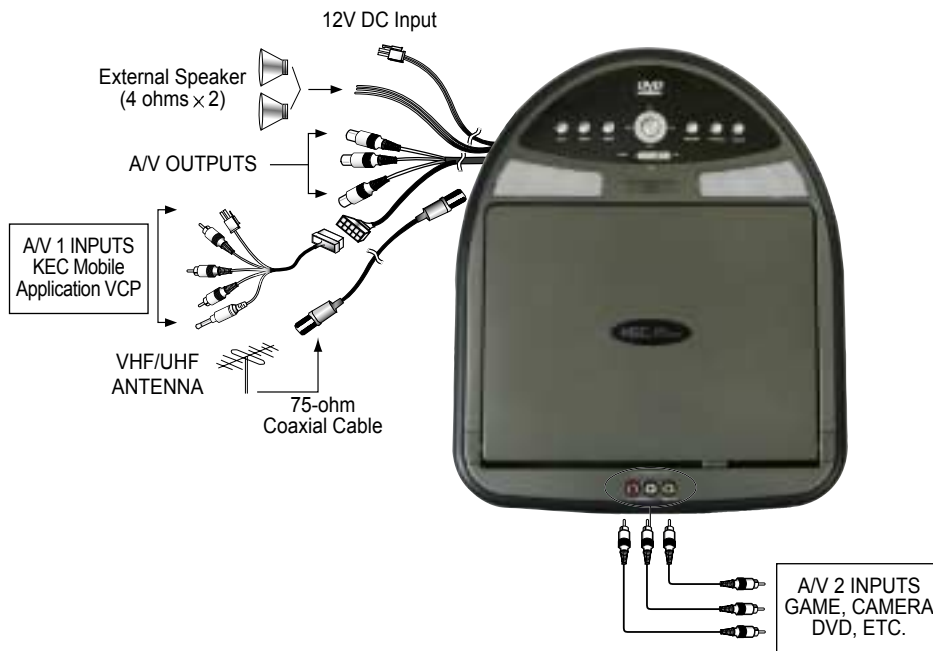

Be sure to disconnect POWER before making any connections.

This illustration shows only one possible example of external equipment connection. For a more detailed understanding of each connection, please refer to the instruction manuals supplied with each component you plan to connect.

This 15 foot cable simplifies connection and installation of an external program source. If a KEC Mobile Applications Videocassette Player or additional DVD Player is used as the A/V1 program source, only this single cable is needed as it supplies 12V power to and receives signal from the VCP.

<b>Connector</b>	<b>Connect To</b>
10-Pin Mate & Lock	LSMD-104 10-Pin Mate & Lock Connector
2-Pin Mate & Lock	KEC VCP or DVD 12V Power Input <i>(Designed to provide power to KEC products ONLY)</i>
RCA Plug Yellow (Male)	A/V1 Video Output
RCA Plug Red (Male)	A/V1 Right Audio Output
RCA Plug White (Male)	A/V1 Left Audio Output
Mini Phone Plug (Male)	KEC VCP R-Link Input/Output

## SIGNAL CONNECTION (continued)

### SELECTING THE PROGRAM SOURCE

Press the TV/VIDEO button on the Remote Control or LSMD-104 Control Panel to select the desired program source. Repeatedly pressing the button will switch between inputs as follows:

Broadcast TV (built-in) DVD VIDEO 1 VIDEO 2 Broadcast TV .....

### AUDIO SYSTEM

- The Audio Outputs always feed a low-level audio signal from the selected input.
- The Audio Outputs feed a Monophonic signal whenever the selected input source has a Monophonic audio signal (e.g. a monophonic broadcast from the built-in TV Tuner, or the signal from a Monophonic VCP connected to the VIDEO 1, 2 input terminals).
- The Audio Outputs feed a Stereo signal whenever the selected input source has a Stereo audio signal (e.g. a stereo broadcast received by the built-in TV Tuner, or the signal from the built-in DVD player).
- The EXTERNAL SPEAKERS OUTPUT CONECTOR feeds a high level mono or stereo signal whose level is Variable up to 2.0W maximum when connected to 4-ohm speakers.
- **IR (Infrared Rays) Transmitter**  
The built-in IR Transmitter allows you to listen to the Stereo or Monophonic audio signal from the selected program source (TV, DVD, VIDEO1, VIDEO2) on IR Wireless Headphones compatible with those that are manufactured by Unwired Technology LLC. They are widely available under the Unwired brand name. Headphones sold under other brand names that are compatible with Unwired may also be used. The IR signal is always live.

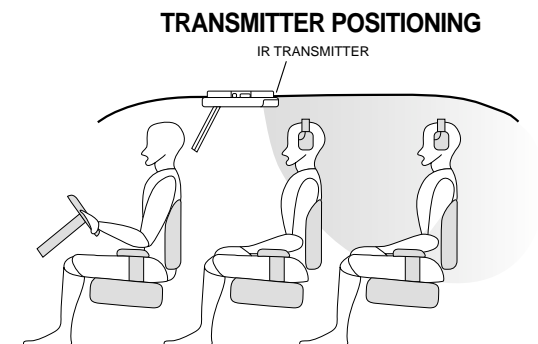

- **Wireless FM Transmitter**  
The built-in FM Broadcast Transmitter allows you to listen to the Stereo or Monophonic audio signal from the selected program source (TV, DVD, VIDEO1, VIDEO2) on the FM Band of the vehicle's radio or on headphones equipped with an FM tuner. See page 21 of this manual for a full description and details of operation.

### VIDEO SYSTEM

This model incorporates 2 sets of External STEREO AUDIO/VIDEO INPUTS (VIDEO1, VIDEO2) for direct connection of up to 2 external program sources (Videocassette Player, Video Game, Camcorder, etc.). Direct connection results in superior video quality and should be used whenever the external program source provides direct outputs. Refer to the instruction manual supplied with each external instrument for details.

## POWER CONNECTION

### CONNECTING TO VEHICLE POWER

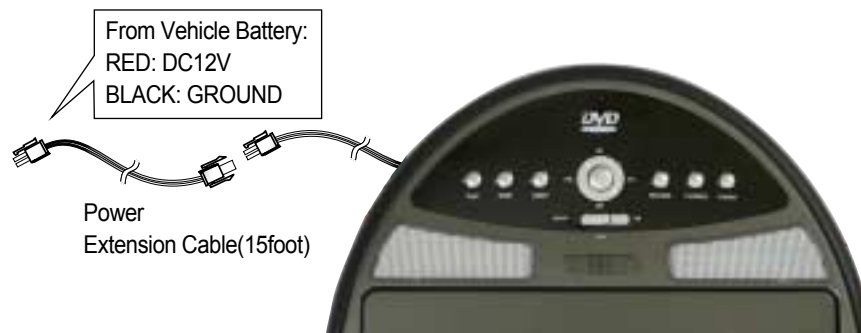

#### NOTE

The cable assembly used to connect the LSMD-104 to the 12Volt power supply may vary depending on product packaging.  
MANUFACTURER : TEASUNG ELECTRIC CO.,LTD. TYPE# : AWM STYLE 1015

#### WARNING

The DC Battery Cord is ONLY for use with this model. Do not use it to power any other product.

# DOME LIGHT CONNECTION

## IMPORTANT NOTE - NEGATIVE & POSITIVE DOOR CIRCUITS:

The 4-wire harness for the LSMD104's built-in dome lights is color-coded for use in vehicles that employ a **negative** door circuit. This includes GM (excepting 2003 and later full-sized SUV's), Chrysler and most imported vehicles.

Most Ford Motor Company vehicles and 2003 and later GM full-sized SUV's employ a **positive** door circuit.

First verify which type of circuit is used in the installation vehicle and then follow the instructions in the appropriate section below.

### (1) NEGATIVE Door Circuit

**Red wire** - Connect to 12V constant (*unswitched*) power.

**Yellow wire** - Connect to 12V constant (*unswitched*) power.

**Black wire** - Connect to chassis ground.

**White wire** - Connect to negative door switch.

### (2) POSITIVE Door Circuit

**Red wire** - Connect to 12V constant (*unswitched*) power.

If there is no constant power wire under the factory dome light, a constant power lead will have to be run to a source of unswitched 12V power.

**Yellow wire** - Connect to positive door switch.

**Black wire** - Connect to chassis ground.

**White wire** - Connect to chassis ground.

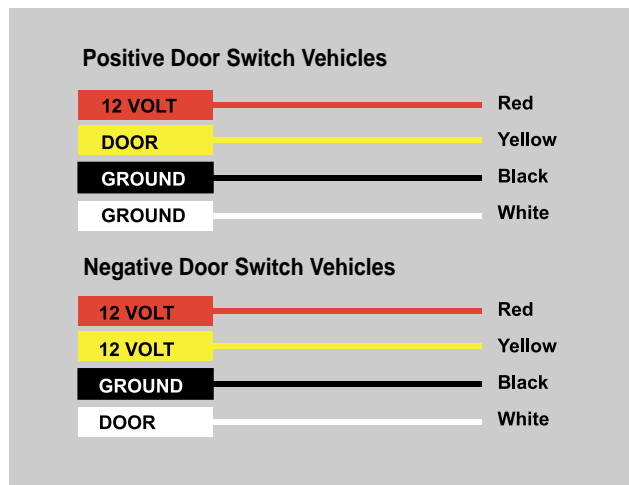



# INSTALLATION FOR VEHICLE USE

## 1. LSMD-104 INSTALLATION

### WARNING:

UNDER NO CONDITION SHOULD THE LCD DISPLAY BE MOUNTED IN ANY POSITION WHERE A PICTURE MIGHT BE VISIBLE TO THE DRIVER. EVEN IN THOSE CASES WHERE SUCH AN INSTALLATION IS NOT PROHIBITED BY LAW, DOING SO MIGHT INCREASE THE LIKELIHOOD OF A SERIOUS ACCIDENT

### EXAMPLE

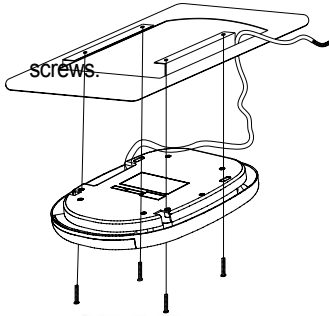

Install the unit to metal pillars in the vehicle's roof with 4 screws. If the pillars are not conveniently located, secure a 3/8" plywood board to the pillars and mount the LSMD-104 to the plywood board.

- Use extreme care to insure that tools do not damage the unit.
- Use extreme care to insure that cutting tools and/or mounting screws do not contact, cut or drill through exterior body panels.

### NOTES:

**DO NOT SECURE THE LSMD-104 DIRECTLY TO THE ROOF HEADLINER MATERIAL. THE HEADLINER MATERIAL AND BACKING WILL NOT BE STRONG ENOUGH TO SAFELY SUPPORT THE UNIT'S WEIGHT.**

The DC Power plug should not be accessible to the consumer.

When mounting the LSMD-104 with screws, be certain that the minimum thickness of the mounting material is as follows:

- Wood : 3/8" or more
- Metal : 1/8" or more
- Plastic : 3/16" or more

## 2. LSMD-104 CUTOUT DIMENSIONS

Please use the cutout template that is packaged with this unit.

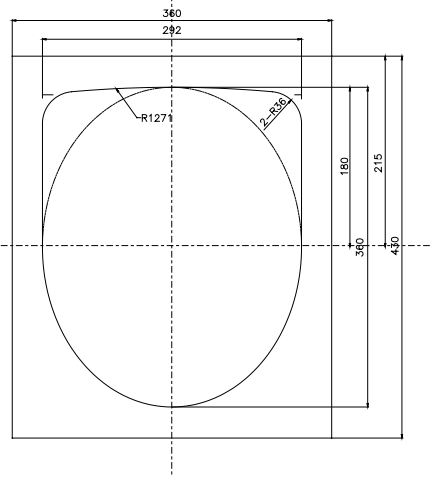

# LSMD-104 OPERATION

## 1. INITIAL PREPARATION

- Insert batteries into the Remote Control unit by following the procedure described in the "REMOTE CONTROL BATTERY INSTALLATION" section in this manual.
- Follow the procedure described in the "MENU OPERATION" and "AUTO PROGRAM" sections that follow to automatically scan and store active television channels into memory.

## 2. BASIC OPERATION PROCEDURE

1. Lowering the LCD Screen releases the AUTO POWER SWITCH (see item #10 on page 9) and turns power on. The input source last viewed will be automatically selected.  
If the screen is already lowered but power has been turned off manually (or by the AUTO POWER OFF function), press the POWER button on the LSMD-104 Control Panel or remote control to turn power back on.
2. Press the TV/VIDEO button on the LSMD-104 Control Panel or Remote Control to select the desired mode.(TV, DVD, VIDEO 1, VIDEO 2)

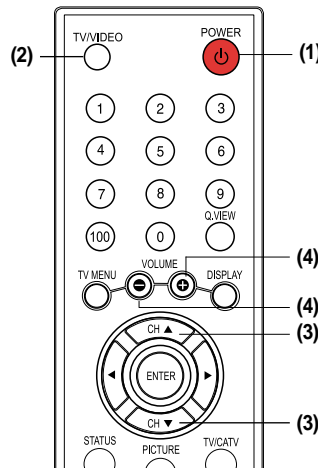

3. If TV mode has been selected, select the desired channel using the CHANNEL ▼/▲ buttons on the LSMD-104 Control Panel or Remote Control. Pressing the ▼/▲ buttons advances to the next lower or higher channel stored in memory.

Channels can be selected directly by using the 10-digit Keypad on the Remote Control. Example: To select Channel 5, press "0" first, than press "5". (If "0" is not pressed first, there will be a delay of about 5 seconds before the channel changes.)

4. If external speakers are connected to the EXTERNAL SPEAKERS OUTPUT CONNECTOR, the VOLUME +/- buttons on the Remote Control may be used to adjust the speaker's volume.

The volume level will be shown on the screen with a bar scale and a reference number (0-100) as shown.

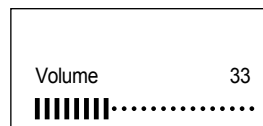

**NOTE :** The volume level can be muted instantly by pressing the MUTE button on the Remote Control. See "MUTE Button" on page 25.

# TV MENU BUTTON - GENERAL INFORMATION

## On-Screen Display

- On-screen displays automatically disappear after about 5 seconds if no selection is made.

The TV MENU button gives you access to a variety of TV and Monitor functions.

1. Press the TV MENU button on the Remote Control.

The first time it is pressed, the following display appears on the screen.

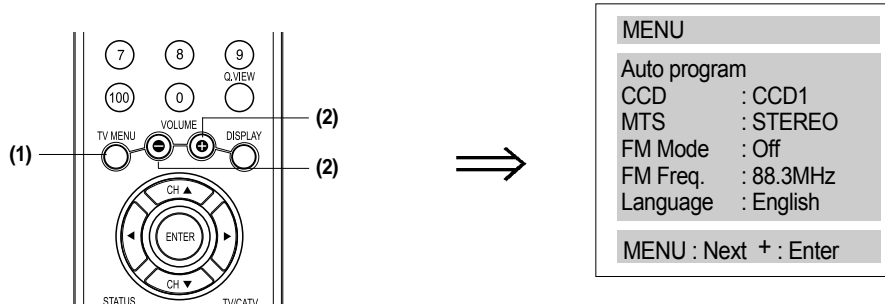

Press the TV MENU button repeatedly to select the desired item for adjustment. Each time the button is pressed, the selected item will change from WHITE to MAGENTA, indicating that it may be adjusted.

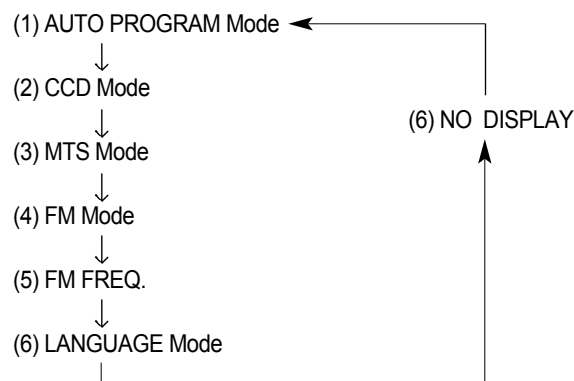

2. After selecting the desired mode, press the VOLUME + button on the Remote control.

**NOTE:** TV Broadcast related items - AUTO PROGRAM, CCD & SAP -- are only shown in the TV MENU display if the LSMD-104 is set to TV Mode.

# TV MENU BUTTON - OPERATIONS

## (1) AUTO PROGRAM

This function allows automatic memorization of all active TV channels in your viewing area. Once memorized, channels can be selected with the CHANNEL ▼/▲ buttons on the Remote Control or on the LSMD-104's Control Panel.

To activate AUTO PROGRAMMING.

- Press the TV/Video button as necessary to switch to TV Mode.
- Press the MENU Button until "AUTO PROGRAM" is selected.
- Press the VOLUME button.

The following display will appear and the channel programming set-up procedure will begin automatically.

**Auto Programming**  
**CATV : 5**  
**+Exit**

All possible channels will be rapidly scanned and all active channels will be memorized.

- Note that very weak broadcast signals will not be memorized.
- If you wish to stop the Auto Programming procedure before it is finished, press the VOLUME + button.

## (2) CCD

The LSMD-104 incorporates a Closed Caption Decoder (CCD) to enable viewing of CCD and TEXT broadcasts.

CCD and TEXT information can only be viewed if they are being broadcast by a television station, or recorded on a videotape or videodisc.

- Press the MENU Button until "CCD" is selected.
- Then press the VOLUME + button.
- A display of CCD & TEXT channels will appear:

**CCD : Off**  
**CCD 1**  
**CCD 2**  
**Text 1**  
**Text 2**

Press the VOLUME+ button repeatedly to select the desired CCD or TEXT mode.

You may also use the CCD button on the remote control to cycle through available modes:

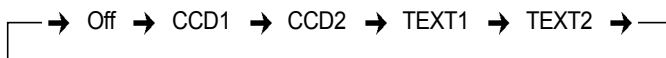

# TV MENU BUTTON - OPERATIONS

## (3) MTS / STEREO

The LSMD-104 incorporates a **MTS/STEREO** (Multichannel Television Sound) decoder to receive:

- **MONOPHONIC** broadcasts
- **STEREO** broadcasts (if the station is broadcasting in Stereo)
- **SAP** (Secondary Audio Program) broadcasts. SAP material might be an audio track in an additional language, or it might be DVS information (Descriptive Video Service ) for the visually impaired.

To select the MTS mode:

- Press the TV/Video button as necessary to switch to TV Mode.
- Press the MENU Button until "MTS" is selected.
- A sub-menu will be displayed as shown below:

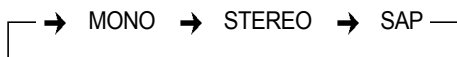
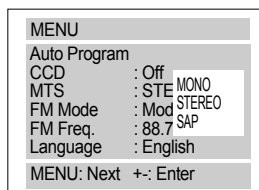

- Each time you press the VOLUME + button, the selection will change in the order MONO - STEREO - SAP. The chosen mode will change from WHITE to MAGENTA.
- Press the MENU button repeatedly until the menu disappears from the screen.

Whenever you change channels or switch the LSMD-104 to TV mode, the MTS mode will be displayed on screen after a brief delay as shown below.



In this example, the station is broadcasting both STEREO and SAP signals. You may also call up this display at any time by pressing the DISPLAY button on the remote control.

If MONO mode has been selected, the on-screen display will not indicate a STEREO broadcast even if it is available.

### NOTES:

- Reception of Stereo or SAP broadcast information is of course dependent on a television station actually broadcasting such material. Not all stations do, and some stations only broadcast Stereo/SAP material during part of the day.
- If the LSMD-104 is set to STEREO and no stereo signal is being broadcast, a MONO signal will automatically be received.
- A stronger signal is required to receive Stereo or SAP broadcasts. If noise is heard, you can improve the clarity of the audio signal by switching to MONO reception.
- If a received SAP signal is weak, SAP will not be heard.
- Some stations broadcast the same audio signal on the SAP band to insure that the viewer will still hear audio if the television is accidentally set to SAP reception.
- Even if both STEREO and SAP are broadcast, only one can be heard at a time.
- Transmission of CABLE TV signals differ from off-air TV broadcasts. It is possible that MTS sound may not be received satisfactorily.

# TV MENU BUTTON - OPERATIONS

## (4) FM BROADCAST MODE & FM FREQUENCY

The LSMD-104 has a built-in FM Stereo Broadcast Transmitter to allow you to listen to the audio signal from the selected program source (TV, DVD, VIDEO1, VIDEO2) through the vehicle's FM radio.

### Procedure

1. Press the TV MENU button as many times as necessary to select "FM MODE".
2. Press the VOLUME+ button as many times as necessary to set FM MODE as desired to "MODE1", "MODE2" or "OFF".

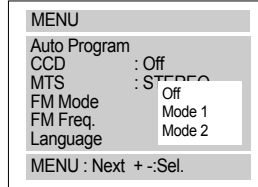

- 3A. If "MODE1" was selected in Step 2 above, press the TV MENU button again to select "FM FREQ.", then press the VOLUME + button repeatedly to choose one of the 4 preset FM Frequencies: 88.3MHz, 88.7MHz, 89.1MHz or 90.3MHz.

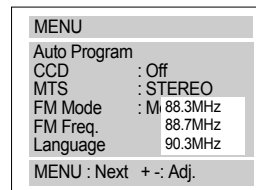

-OR-

- 3B. If "MODE2" was set in Step 2 above, press the TV MENU button again to select "FM FREQ.", then press the VOLUME + button to choose any FM Frequency from 88.3MHz to 90.3MHz in 0.1MHz (100KHz) increments.

4. Tune the vehicle's radio to the frequency chosen in Step 3 above.

It may be necessary to repeat Step 3, choosing a different frequency each time, before you are able to receive a satisfactory signal. The best signal is usually obtained by choosing a frequency that is not actively broadcasting in your area. Also note that better results may be obtained if the vehicle's antenna can be lowered independently.

Example - Receiving Audio through the FM Radio at 88.7MHz.

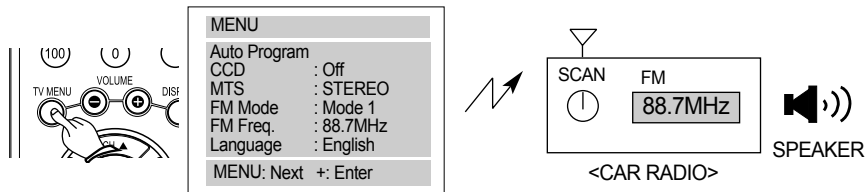

### NOTES TO INSTALLER

- The FM Transmitter Antenna (Page 8 # 22) should be installed in the direction of the vehicle's main FM Antenna.
- Never adjust the LA01 coil on the FM Transmitter board. It was optimally adjusted at the factory.

# TV MENU BUTTON - OPERATIONS

## (5) LANGUAGE

The on-screen displays may be set to appear in your choice of 4 languages - English, Spanish, Portuguese or French.

1. Press the TV MENU button repeatedly until "LANGUAGE" is selected.
2. Press the VOLUME + button as many times as necessary to select between "ENGLISH", "ESPAÑOL", "PORTUGUÊS" and "FRANÇAIS".
3. Press the TV MENU button again to exit.

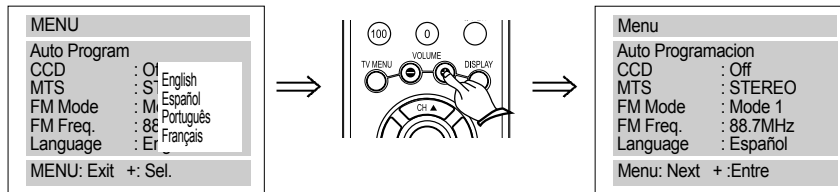

# PICTURE BUTTON

The PICTURE button allows you to select each picture adjustment element.

- Press the PICTURE button on the Remote Control or on the LSMD-104 Control Panel to bring up the PICTURE Menu.
- Press the PICTURE button repeatedly to select the item you wish to adjust.
- The selected item will change from WHITE to MAGENTA, indicating that it may be adjusted.

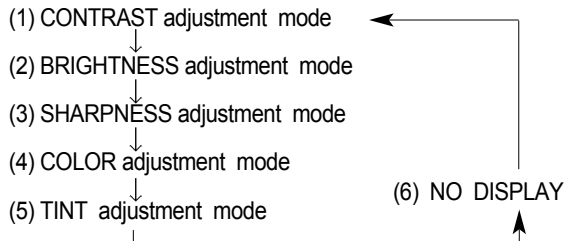

- After selecting the desired mode, press the VOLUME - / + buttons to adjust the picture as you prefer according to the chart below.

VOLUME -	ITEM	VOLUME+
LIGHT	CONTRAST	STRONG
DARK	BRIGHTNESS	BRIGHT
SOFT	SHARPNESS	SHARP
SUBDUED	COLOR	VIVID
REDDISH	TINT	GREENISH

- When you are finished making adjustments, press the PICTURE button as many times as necessary to remove the Picture Menu from the screen.

## Example - Adjusting CONTRAST

- Press the PICTURE button to display the PICTURE menu and select CONTRAST.
- Press the VOLUME - / + buttons to call up and adjust the CONTRAST bar display.

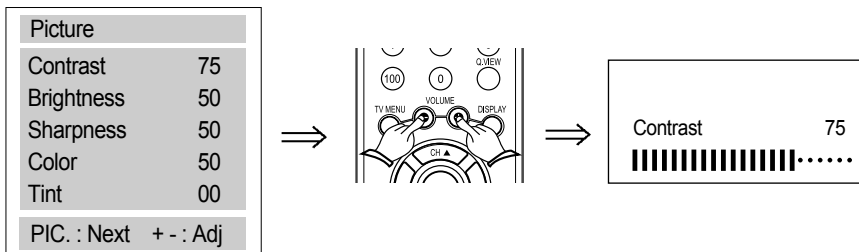

## NOTES ON THE PICTURE FUNCTIONS:

Picture adjustments are only memorized if the STATUS Mode (see next section) is set to "CUSTOM". Color LCD screens operate differently than conventional color picture tubes. As you operate the picture controls, you will notice that the range of adjustment is somewhat less dramatic than would occur with a conventional picture tube.



# STATUS BUTTON

The STATUS button on the Remote Control lets you select between a CUSTOM adjustable picture setting mode or any one of 3 factory preset picture modes.

Pressing the STATUS button repeatedly changes the mode as follows:

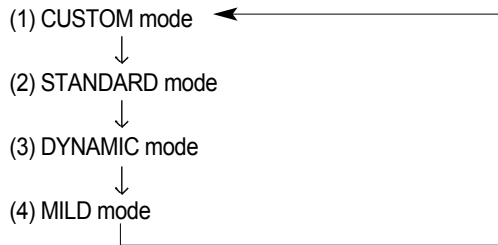

MODE	PICTURE
CUSTOM	Select this mode to view a picture that may be adjusted to your own personal taste. <b>Note:</b> While picture adjustments may also be made in the other 3 modes, adjustments will only be stored in memory in CUSTOM mode.
STANDARD	Select this mode to restore picture adjustments to the normal factory-preset mode.
DYNAMIC	Select this mode to view a strong and bright picture. This mode is intended especially for viewing in brighter (daylight) environments.
MILD	Select this mode to view a milder picture. This mode is intended especially for viewing in darker (nighttime) environments or to lessen eye fatigue.

## OTHER USEFUL FUNCTIONS

### (1) QUICK VIEW Button

Press the Q. VIEW button on the Remote Control.  
The previously viewed channel will appear on the screen.  
Press Q.VIEW again to switch back to the original channel.

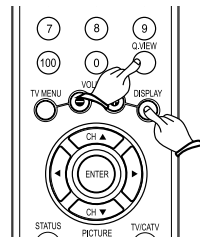

### (2) DISPLAY Button

Press the DISPLAY button on the Remote Control.  
The Program Source (Channel # & MTS mode, DVD, VIDEO1, VIDEO2) you are viewing and the setting of the SLEEP TIMER will be displayed as shown.

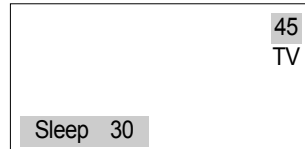

### (3) SLEEP Button

Press the SLEEP button to select a time period between 15 and 180 minutes after which the LSMD-104 will automatically switch to power-off mode.  
Repeatedly pressing the SLEEP button on the Remote Control cycles the SLEEP timer as shown below.

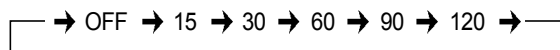

**NOTE :** To cancel the sleep timer function, press the SLEEP button repeatedly until the words "SLEEP OFF" are displayed.

### (4) MUTE Button

Press the MUTE button on the Remote Control.  
Audio from any speaker(s) attached to the EXTERNAL SPEAKERS OUTPUT CONNECTOR will be reduced to zero and "MUTE" will appear on the screen.  
Pressing the MUTE button again will restore the audio to its original level.

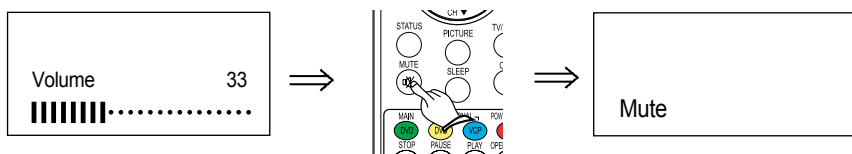

### (5) AUTOMATIC POWER SHUT-OFF

If the system is not switched off when a TV Station stops broadcasting, (or any other program source ends) the system will automatically go to power off mode after approximately 15 minutes have passed.

## DVD FUNCTION & OPERATION

**CAUTION** | This Digital Video Disc Player employs a Laser System.  
To ensure proper use of this product, please read this owner's manual carefully and retain for future reference, should the unit require maintenance, contact an authorized service location-see service procedure.  
Use of controls, adjustments or the performance of procedures other than those specified may result herein hazardous radiation exposure.  
To prevent direct exposure to laser beam, do not try to open the enclosure.  
Visible laser radiation when open the enclosure. **DO NOT STARE INTO BEAM.**

**FCC NOTICE** | This equipment has been tested and found to comply with the limits for a Class B digital device, pursuant to part 15 of the FCC Rules. These limits are designed to provide reasonable protection against harmful interference in a residential installation.  
This equipment generates, uses, and can radiate radio frequency energy and, if not installed and used in accordance with the instructions, may cause harmful interference to radio communications.  
However, there is no guarantee that interference will not occur in a particular installation.  
If this equipment does cause harmful interference to radio or television reception, which can be determined by turning the equipment off and on, the user is encouraged to try to correct the interference by one or more of the following measures:

- Reorient or relocate the receiving antenna.
- Increase the separation between the equipment and receiver.
- Connect the equipment into an outlet on a circuit different from that to which the receiver is connected.
- Consult the dealer or an experienced radio/TV technician for help.

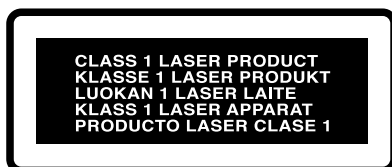

**FCC WARNING** | Changes or modifications not expressly approved by the party responsible for compliance could void the user's authority to operate the equipment.

### **INDUSTRY CANADA REQUIREMENT**

This class B digital apparatus meets all requirements of the Canadian Interference-Causing Equipment Regulations.  
Cet appareil numérique de la classe B respecte toutes les exigences du Règlement sur le matériel brouilleur du Canada.

**DTS** | "DTS" and "DTS Digital Out" are trademarks of Digital Theater Systems, Inc.

# INTRODUCTION

## Precautions

### Disc Slot

Keep your fingers well clear of the disc slot. It may cause serious personal injury.

### Laser Beam

Do not look into the opening of the disc slot or ventilation opening of the product to see to source of the laser beam. It may cause sight damage.

### Disc

Do not use a cracked, deformed, or repaired disc. These discs are easily broken and may cause serious personal injury and product malfunction.

## To Obtain a Clear Picture

The DVD player is a high technology, precision device. If the optical pick-up lens and disc drive parts are dirty or worn down, the picture quality becomes poor. To obtain a clear picture, we recommend regular inspection and maintenance (cleaning or parts replacement) every 1,000 hours of use depending on the operating environment. For details, contact your nearest dealer.

## Notes on Moisture Condensation

**Moisture condensation damages the DVD player. Please read the following carefully.**

Moisture condensation occurs, for example, when you pour a cold drink into a glass on a warm day. Drops of water form on the outside of the glass. In the same way, moisture may condense on the optical pick-up lens inside this unit, one of the most crucial internal parts of the DVD player.

**Moisture condensation occurs during the following cases.**

- When you bring the DVD player directly from a cold place to a warm place.
- When you use the DVD player in a room where you just turned on the heater, or a place where the cold wind from the air conditioner directly hits the unit.
- In summer, when you use the DVD player in a hot and humid place just after you move the unit from an air conditioned room.
- When you use the DVD player in a humid place.

**Do not use the DVD player when moisture condensation may occur.**

If you use the DVD player in such a situation, it may damage discs and internal parts. Remove the disc, turn power "ON" and leave it "ON" for two or three hours. After two or three hours, the DVD player will have warmed up and evaporated any moisture. Keep the DVD player connected outlet and moisture condensation will seldom occur.

# INTRODUCTION

## Notes on Discs

This section shows you how to handle, clean, and store discs.

### On Handling Discs

- Do not touch the playback side of the disc.

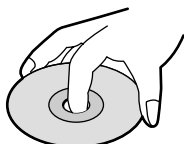

- Do not attach paper or tape to discs.

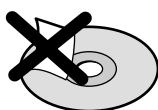

### On Storing Discs

- Do not store discs in a place subject to direct sunlight or near heat sources.
- Do not store discs in places subject to moisture and dust such as a bathroom or near a humidifier.
- Store discs vertically in a case. Stacking or placing objects on discs outside of their case may cause warping.

### On Cleaning discs

- Fingerprints and dust on the disc cause picture and sound deterioration. Wipe the disc from the center outward with a soft cloth. Always keep the disc clean.
- If you cannot wipe off the dust with a soft cloth, wipe the disc lightly with a slightly moistened soft cloth and finish with a dry cloth.
- Do not use any type of solvents such as thinner, benzene, commercially available cleaners or anti-static spray for vinyl LPs. They may damage the disc.

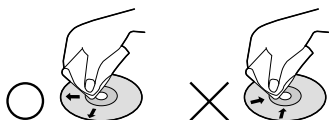



### About This Owner's Manual

- This owner's manual explains the basic instructions of this DVD player.
- Some DVD video discs have functions that may not be explained in this owners manual. Therefore, some instructions may differ from this owner's manual, and there may be extra instructions. In this case, follow the instructions displayed on the TV screen or package.
- "⊗" may appear on the TV screen during operation. This icon means the function explained in this owner's manual is not available on that specific DVD video disc.

# DISC REQUIREMENTS/COPYRIGHT INFORMATION

## Playable Discs

This DVD player can play back the following discs.

	Disc mark	Contents	Disc size	Maximum playback time
DVD video discs		Audio+Video (moving pictures)	12 cm	Approx. 4 hours (single sided disc)
				Approx. 8 hours (double sided disc)
Audio CDs		Audio	12 cm	74 minutes
Video CDs		Audio+Video (moving pictures)	12 cm	74 minutes

This unit can also play discs containing MP3, WMA or JPG files.

You cannot playback discs other than those listed above. (CD-ROM, CD-G, photo CD, and CD-i discs can not be played on this DVD player.)

## Region Management Information

Region Management Information: This DVD Player is designed and manufactured to respond to the Region Management Information that is recorded on a DVD disc. If the Region number described on the DVD disc does not correspond to the Region number of this DVD player, this DVD player cannot play that disc.

The Region number of this DVD player is.



## Notes on Unauthorized Discs

You may not be able to play back some DVD video discs on this player if they were purchased from outside your geographic area or made for business purposes.

When you try to play back an unauthorized disc, "**Check Regional Code**" appears on the TV screen.

## Notes on Copyright

It is forbidden by law to copy, broadcast, show, broadcast on cable, play in public, and rent copyrighted material without permission.

DVD video discs are copy protected, and any recordings made from these discs will be distorted.

This product incorporates copyright protection technology that is protected by method claims of certain U.S. patents and other intellectual property rights owned by Macrovision Corporation and other rights owners. Use of this copyright protection technology must be authorized by Macrovision Corporation, and is intended for home and other limited viewing uses only, unless otherwise authorized by Macrovision Corporation. Reverse engineering or disassembly is prohibited.

## BASIC DISC PLAYBACK

### Before operating

- Set the initial settings as desired. Turn to instructions on initial settings beginning on page 35 more details.



### Playback

- Turn Power On.
- Insert a disc WITH THE LABEL FACING UP. Do not use force. The LSMD-104 will automatically switch to DVD mode and begin to read the disc. After a short period of time (depending on the complexity of the disc), playback will begin.
- To stop playback, press the STOP button.
- To temporarily stop playback press the PAUSE button.
- To resume PLAYBACK, press the PLAY button once again.

### **NOTE**

- The DVD player automatically memorizes the location where the stop button was pressed during playback and resumes from that point when the playback button is pressed again.
- If the unit is in PAUSE mode for more than about 5 minutes, a screensaver will appear to protect the TV hardware. Press any key to clear the screensaver. After about 10 minutes in PAUSE mode, the power is automatically turned off.

## SEARCHING FOR A SPECIFIC SCREEN OR SONG DURING PLAYBACK

You can use one of the function listed below in order to jump to a specific chapter or track during playback

### Scan at fast forward or fast reverse

- Press the FR/SR or FF/SB buttons on the remote controller.
- For DVD playback, pressing the button successively executes the function in the following order;  
2X → 4X → 8X → 32X → 64X  
(For CD playback, the choices are FAST or NORMAL.)
- To return to normal playback speed, press the PLAY button.

### To skip a chapter or a track

- Press the PREV ◀◀ or NEXT ▶▶ button on the remote controller.  
When the NEXT ▶▶| button is pressed, playback skips to the next chapter or track during DVD or CD playback.
- When the PREV |◀◀ button pressed, playback skips to the beginning of the current chapter for DVD playback and the previous chapter when it is pressed again.

### **NOTE**

- What is a chapter?  
A chapter is one of the several sections to which a movie is divided into.
- What is a title?  
A title refers to a single whole movie.



## SETTING A CUSTOM VIEW

### Setting a specific frame within a chapter of a DVD

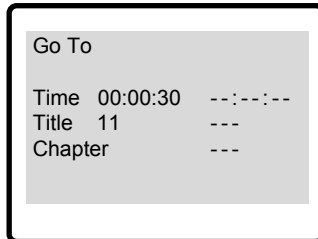

- Press GOTO button on the remote controller.
- Enter the time location of the frame using the number buttons and then press ENTER.

### Setting a specific DVD title or chapter

- Press GOTO button on the remote controller.
- Use the UP & DOWN buttons to select Chapter or Track.
- Use the numeric keypad to enter the appropriate Chapter or Track # an then press ENTER.

# CHANGING THE SIZE AND ANGLE OF THE SCREEN

## Changing the size of the screen

- Press the ZOOM button.
- Pressing the button successively executes the function in the following order:

→ ZOOM X1 → X2 → X3 → OFF →

This function is only available during DVD/VCD playback.

- While in ZOOM mode, you may move to different portions of the enlarged screen by pressing the ARROW buttons.

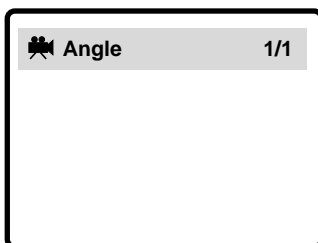

## Viewing from another angle

- Press ANGLE button.
- Pressing the button successively changes the viewing angle which is displayed on the screen.
- This function is available only for discs that have scenes recorded at different angles.

## USING THE MENU, TITLE & SUBTITLE BUTTONS

### Selecting a menu listed on the disc

- Press MENU button.
- The menu contained on the disc will appear on the screen. The menu appears differently with different discs.
- This function does not work for a CD.

### To view the title menu

- Press the TITLE button.
- The title menu contained in the disc will appear.
- The title menu appears differently with different discs.
- This function will not work with a CDs.

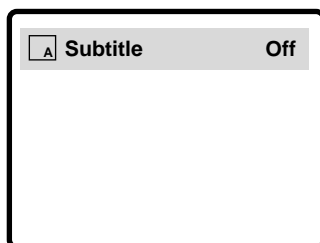

### To view the subtitle

- Press the S-TITLE button.
- The menu contained on the disc will appear.
- The subtitle menu appears differently with different discs.
- This function will not work with a CDs.

## USING THE SETUP MENU

Pressing SETUP button will show a screen with which various menus can be set. The unit must be in STOP mode in order to display the SETUP Menu.

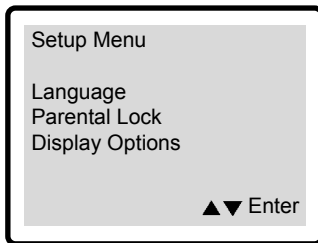

Press the SETUP button, then press ENTER to select the LANGUAGE submenu.

- DISC MENU : For selecting a language listed in a disc.
- AUDIO : For selecting audio speaker language.
- SUBTITLE : For selecting subtitle language.

## SETTING A MENU

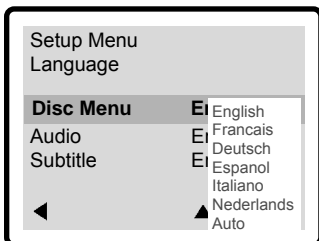

### Selecting a menu language contained in the disc

- 1 Press SETUP button on the remote controller.
- 2 Go to "LANGUAGE" using the CH▲/▼, Enter buttons.
- 3 Go to "DISC MENU" using the CH▲/▼, Enter buttons.
- 4 Choose the desired language using the CH▲/▼ buttons and select it by pressing ENT.

#### **NOTE**

- This function only work for DISC STOP mode.

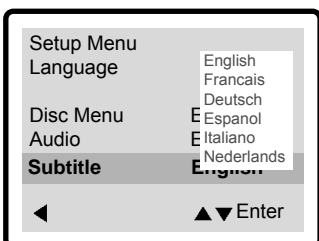

### Selecting subtitle language

- 1 Press SETUP button on the remote controller.
- 2 Go to "LANGUAGE" using the CH▲/▼, Enter buttons.
- 3 Go to "SUBTITLE" using the CH▲/▼, Enter buttons.
- 4 Choose the desired language using the CH▲/▼ buttons and select it by pressing ENT button.

#### **NOTE**

- This function only works if there is no Disc inside.

# SETTING THE LANGUAGE

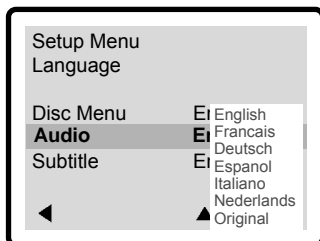

## Selecting audio language

- 1** Press SETUP button on the remote controller.
- 2** Go to "LANGUAGE" using the CH ▲/▼, Enter buttons.
- 3** Go to "AUDIO" using the CH ▲/▼, Enter buttons.
- 4** Choose the desired language using the CH ▲/▼ buttons and select it by pressing ENT button.

### **NOTE**

- If the selected language is not listed in the disc the language will not appear on the menu.
- This function only works if there is no Disc inside.

## SETTING THE DISPLAY OPTIONS

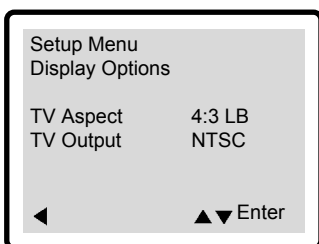

- 1** Press SETUP button on the remote controller.
- 2** Go to VIDEO using the CH ▲/▼, Enter buttons.
- 3** Go to the item using the CH ▲/▼, Enter buttons.
- 4** Choose the desired setting using the CH ▲/▼ buttons and select it by pressing ENT button.

### TV Aspect

- 4:3 PS : Only the center portion of 16:9 ratio screen is visible.
- 4:3 LB : The complete 16:9 ratio screen is visible MTS black strips on the top and bottom.
- 16:9 WIDE : For selecting the wide screen TV viewing format.

### TV Output

- NTSC : For areas where the color system is NTSC.
- PAL : For areas where the color system is PAL
- AUTO : For areas that support Auto.

## PARENTAL LOCK SETTINGS

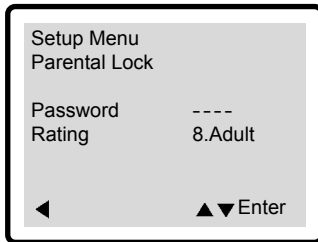

- 1** Press SETUP button on the remote controller.
- 2** Go to "Parental Lock" using the CH▲/▼, Enter buttons.
- 3** Go to a desired item using the CH▲/▼ buttons.

### Password

- Turn to setting rating level and password.

### Rating

- Set a password and select rating level for DVDs unsuitable for children. For more details, turn to setting rating level and password.



## SETTING RATING LEVEL AND PASSWORD

This is to prohibit the playing of specified DVDs which are unsuitable for children.

Some DVD discs contain a restriction level which enables parents to remove scenes or prevent playback of discs by children. DVD players are equipped with a password designed to prevent children changing the level.

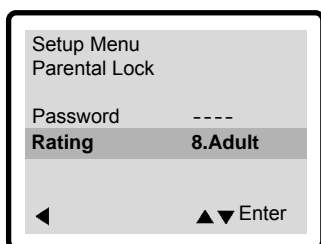

### Setting Rating

- 1** Press SETUP button on the remote controller.
- 2** Go to "Parental Lock" using the CH▲/▼, Enter buttons.
- 3** Go to "Parental" using the CH▲/▼, Enter buttons.
- 4** Choose the desired setting using the CH▲/▼, Enter buttons and select it by pressing ENT button.
- 5** Please enter your password
  - A message appears when the password is incorrect "The password is incorrect".
  - A high level number means that the movie is more oriented to the adult audience.

### Setting your password

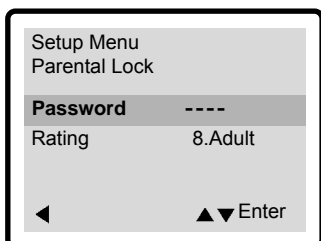

- 1** Press SETUP button on the remote controller.
- 2** Go to "Parental Lock" using the CH▲/▼, Enter buttons.
- 3** Go to "Password" using the CH▲/▼, Enter buttons.
- 4** Input your old password using the number buttons. The password is initially set to 0000.
- 5** Input a new password twice using the number buttons.
- 6** Press ENT button.

# RECEPTION DISTURBANCE

The most common types of television interference are as follows :



## **IGNITION NOISE:**

Black spots or horizontal lines may appear, picture may flutter or drift. Usually caused by interference from automobile ignition systems, neon lamps, electric drills and other electric appliances.



## **GHOSTS :**

Ghosts are caused by the television signals following two paths. One is a direct path and the other is reflected from tall buildings, hills or other objects.

Changing the direction or position of the antenna may improve the reception.



## **SNOW :**

If you are located on the fringes of a television reception area, the signal will be weak, and your picture may contain many small dots.

When the signal is extremely weak, it may be necessary to install an external sensitive antenna to improve the picture.



## **RADIO FREQUENCY INTERFERENCE :**

This interference produces moving ripples or diagonal streaks, and in some cases causes loss of contrast in the picture.

## SPECIFICATIONS

ITEM	SPECIFICATION	
<b>GENERAL</b>	Display Panel	10.4 Inch TFT LCD
	Television System	NTSC-M
	Tuning System	Frequency Synthesizer
	Receiving Channels	VHF 2~13/UHF 14~69/+113 CATV
	Antenna Impedance	UHF/VHF 75 Ohm
	Power Source	DC 12Volt(Car Battery)
	Power Consumption	33W (DC 12V)
<b>DISPLAY SCREEN</b>	High Resolution Picture	800H × 600V=480,000Pixels
	Contrast Ratio	350:1 Typical
	Pixel Pitch	0.264 × 0.264(mm)
	Pixel Configuration	RGB Stripe Arrangement
	LCD Panel Dimension	(WHD) 9.6" × 7.2" × 0.43" (243.0mm × 184.0mm × 11.0mm)
	Active Screen Area	8.3" × 6.2"(211.2mm × 158.4mm)
	Off Axis Viewing Range	Horizontal: ±60° / Vertical:40° Up, 60° Down
	Operating Temperature	0°C~50°C / 32°F~122°F
	Operating Humidity	35% ~ 85%
<b>VIDEO</b>	Input Level	1.0 ± 0.1 Vp-p(75 Ω Load)
	Output Level	1.0 ± 0.1 Vp-p(75 Ω Load)
<b>AUDIO (ALL STEREO)</b>	Input Level	400 ± 50mVrms(RCA Jacks)
	Output Level	400 ± 50mVrms(RCA Jacks)
	External Speakers Outputs	2.0W × 2@4 Ω , <10% THD(Variable) Hum < 3mVrms / Buzz < 200mVp-p
	Wireless IR Transmitter	Compatible with Unwired® brand IR Headphones (Unwired® Technology LLC) and other brands compatible with Unwired®.
	Wireless FM Broadcast Modulator	Off + 4 Preset Frequencies + Any Frequency Between 88.3 MHz~90.3 MHz In 100 kHz Steps

### ACCESSORIES

Supplied	Unified Remote Controller (LSMD-104 + KEC Mobile Applications VCP's) AAA Cells X 2 A/V 1 Extension Cable 12V DC Input Power Extension Cable External Speakers Extension Cable Installation & Operating Manual Installation Cutout Template Warranty Card
Optional	Universal Trim Ring Molded Consoles for a variety of specific vehicles