



Accredited by the Swiss Accreditation Service (SAS)  
The Swiss Accreditation Service is one of the signatories to the EA  
Multilateral Agreement for the recognition of calibration certificates

Client **UL**  
**Fremont, USA**

Certificate No. **D750V3-1019\_Apr23**

## CALIBRATION CERTIFICATE

Object **D750V3 - SN:1019**

Calibration procedure(s) **QA CAL-05.v12  
Calibration Procedure for SAR Validation Sources between 0.7-3 GHz**

Calibration date: **April 13, 2023**

This calibration certificate documents the traceability to national standards, which realize the physical units of measurements (SI).  
The measurements and the uncertainties with confidence probability are given on the following pages and are part of the certificate.

All calibrations have been conducted in the closed laboratory facility: environment temperature ( $22 \pm 3$ )°C and humidity < 70%.

Calibration Equipment used (M&TE critical for calibration)

Primary Standards	ID #	Cal Date (Certificate No.)	Scheduled Calibration
Power meter NRP2	SN: 104778	30-Mar-23 (No. 217-03804/03805)	Mar-24
Power sensor NRP-Z91	SN: 103244	30-Mar-23 (No. 217-03804)	Mar-24
Power sensor NRP-Z91	SN: 103245	30-Mar-23 (No. 217-03805)	Mar-24
Reference 20 dB Attenuator	SN: BH9394 (20k)	30-Mar-23 (No. 217-03809)	Mar-24
Type-N mismatch combination	SN: 310982 / 06327	30-Mar-23 (No. 217-03810)	Mar-24
Reference Probe EX3DV4	SN: 7349	10-Jan-23 (No. EX3-7349_Jan23)	Jan-24
DAE4	SN: 601	19-Dec-22 (No. DAE4-601_Dec22)	Dec-23
Secondary Standards	ID #	Check Date (in house)	Scheduled Check
Power meter E4419B	SN: GB39512475	30-Oct-14 (in house check Oct-22)	In house check: Oct-24
Power sensor HP 8481A	SN: US37292783	07-Oct-15 (in house check Oct-22)	In house check: Oct-24
Power sensor HP 8481A	SN: MY41093315	07-Oct-15 (in house check Oct-22)	In house check: Oct-24
RF generator R&S SMT-06	SN: 100972	15-Jun-15 (in house check Oct-22)	In house check: Oct-24
Network Analyzer Agilent E8358A	SN: US41080477	31-Mar-14 (in house check Oct-22)	In house check: Oct-24

Calibrated by: **Paulo Pina**      **Paulo Pina**      **Laboratory Technician**

Signature

Approved by: **Sven Kühn**      **Sven Kühn**      **Technical Manager**

Signature

Issued: April 14, 2023

This calibration certificate shall not be reproduced except in full without written approval of the laboratory.



Accredited by the Swiss Accreditation Service (SAS)  
The Swiss Accreditation Service is one of the signatories to the EA  
Multilateral Agreement for the recognition of calibration certificates

### Glossary:

TSL	tissue simulating liquid
ConvF	sensitivity in TSL / NORM x,y,z
N/A	not applicable or not measured

### Calibration is Performed According to the Following Standards:

- IEC/IEEE 62209-1528, "Measurement Procedure For The Assessment Of Specific Absorption Rate Of Human Exposure To Radio Frequency Fields From Hand-Held And Body-Worn Wireless Communication Devices - Part 1528: Human Models, Instrumentation And Procedures (Frequency Range of 4 MHz to 10 GHz)", October 2020.
- KDB 865664, "SAR Measurement Requirements for 100 MHz to 6 GHz"

### Additional Documentation:

- DASY System Handbook

### Methods Applied and Interpretation of Parameters:

- Measurement Conditions:* Further details are available from the Validation Report at the end of the certificate. All figures stated in the certificate are valid at the frequency indicated.
- Antenna Parameters with TSL:* The source is mounted in a touch configuration below the center marking of the flat phantom.
- Return Loss:* This parameter is measured with the source positioned under the liquid filled phantom (as described in the measurement condition clause). The Return Loss ensures low reflected power. No uncertainty required.
- SAR measured:* SAR measured at the stated antenna input power.
- SAR normalized:* SAR as measured, normalized to an input power of 1 W at the antenna connector.
- SAR for nominal TSL parameters:* The measured TSL parameters are used to calculate the nominal SAR result.

The reported uncertainty of measurement is stated as the standard uncertainty of measurement multiplied by the coverage factor  $k=2$ , which for a normal distribution corresponds to a coverage probability of approximately 95%.

## Measurement Conditions

DASY system configuration, as far as not given on page 1.

<b>DASY Version</b>	DASY52	V52.10.4
<b>Extrapolation</b>	Advanced Extrapolation	
<b>Phantom</b>	Modular Flat Phantom	
<b>Distance Dipole Center - TSL</b>	15 mm	with Spacer
<b>Zoom Scan Resolution</b>	dx, dy, dz = 5 mm	
<b>Frequency</b>	750 MHz $\pm$ 1 MHz	

## Head TSL parameters

The following parameters and calculations were applied.

	<b>Temperature</b>	<b>Permittivity</b>	<b>Conductivity</b>
<b>Nominal Head TSL parameters</b>	22.0 °C	41.9	0.89 mho/m
<b>Measured Head TSL parameters</b>	(22.0 $\pm$ 0.2) °C	41.1 $\pm$ 6 %	0.92 mho/m $\pm$ 6 %
<b>Head TSL temperature change during test</b>	< 0.5 °C	----	----

## SAR result with Head TSL

<b>SAR averaged over 1 cm<sup>3</sup> (1 g) of Head TSL</b>	Condition	
SAR measured	250 mW input power	2.19 W/kg
SAR for nominal Head TSL parameters	normalized to 1W	<b>8.51 W/kg <math>\pm</math> 17.0 % (k=2)</b>

<b>SAR averaged over 10 cm<sup>3</sup> (10 g) of Head TSL</b>	condition	
SAR measured	250 mW input power	1.43 W/kg
SAR for nominal Head TSL parameters	normalized to 1W	<b>5.59 W/kg <math>\pm</math> 16.5 % (k=2)</b>

## Appendix (Additional assessments outside the scope of SCS 0108)

### Antenna Parameters with Head TSL

Impedance, transformed to feed point	$55.7 \Omega + 3.9 j\Omega$
Return Loss	- 23.7 dB

### General Antenna Parameters and Design

Electrical Delay (one direction)	1.041 ns
----------------------------------	----------

After long term use with 100W radiated power, only a slight warming of the dipole near the feedpoint can be measured.

The dipole is made of standard semirigid coaxial cable. The center conductor of the feeding line is directly connected to the second arm of the dipole. The antenna is therefore short-circuited for DC-signals. On some of the dipoles, small end caps are added to the dipole arms in order to improve matching when loaded according to the position as explained in the "Measurement Conditions" paragraph. The SAR data are not affected by this change. The overall dipole length is still according to the Standard.

No excessive force must be applied to the dipole arms, because they might bend or the soldered connections near the feedpoint may be damaged.

### Additional EUT Data

Manufactured by	SPEAG
-----------------	-------

# DASY5 Validation Report for Head TSL

Date: 13.04.2023

Test Laboratory: SPEAG, Zurich, Switzerland

**DUT: Dipole 750 MHz; Type: D750V3; Serial: D750V3 - SN:1019**

Communication System: UID 0 - CW; Frequency: 750 MHz

Medium parameters used:  $f = 750$  MHz;  $\sigma = 0.92$  S/m;  $\epsilon_r = 41.1$ ;  $\rho = 1000$  kg/m<sup>3</sup>

Phantom section: Flat Section

Measurement Standard: DASY5 (IEEE/IEC/ANSI C63.19-2011)

DASY52 Configuration:

- Probe: EX3DV4 - SN7349; ConvF(10.11, 10.11, 10.11) @ 750 MHz; Calibrated: 10.01.2023
- Sensor-Surface: 1.4mm (Mechanical Surface Detection)
- Electronics: DAE4 Sn601; Calibrated: 19.12.2022
- Phantom: Flat Phantom 4.9 (front); Type: QD 00L P49 AA; Serial: 1001
- DASY52 52.10.4(1535); SEMCAD X 14.6.14(7501)

## Dipole Calibration for Head Tissue/Pin=250 mW, d=15mm/Zoom Scan (7x7x7)/Cube 0:

Measurement grid: dx=5mm, dy=5mm, dz=5mm

Reference Value = 59.38 V/m; Power Drift = -0.02 dB

Peak SAR (extrapolated) = 3.35 W/kg

**SAR(1 g) = 2.19 W/kg; SAR(10 g) = 1.43 W/kg**

Smallest distance from peaks to all points 3 dB below = 17 mm

Ratio of SAR at M2 to SAR at M1 = 65.4%

Maximum value of SAR (measured) = 2.91 W/kg

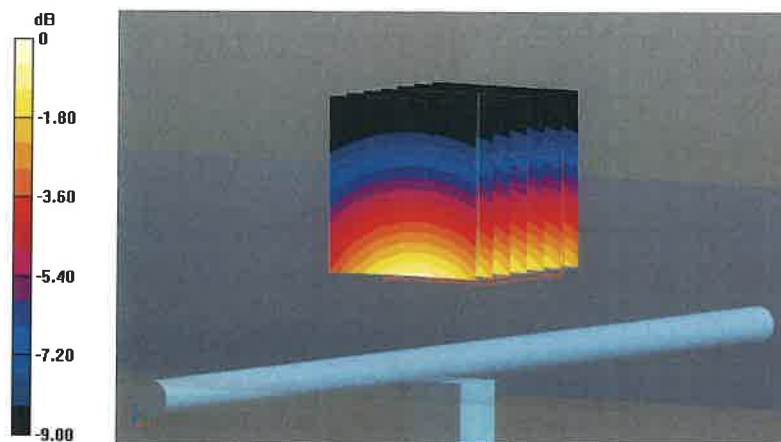

0 dB = 2.91 W/kg = 4.64 dBW/kg

# Impedance Measurement Plot for Head TSL

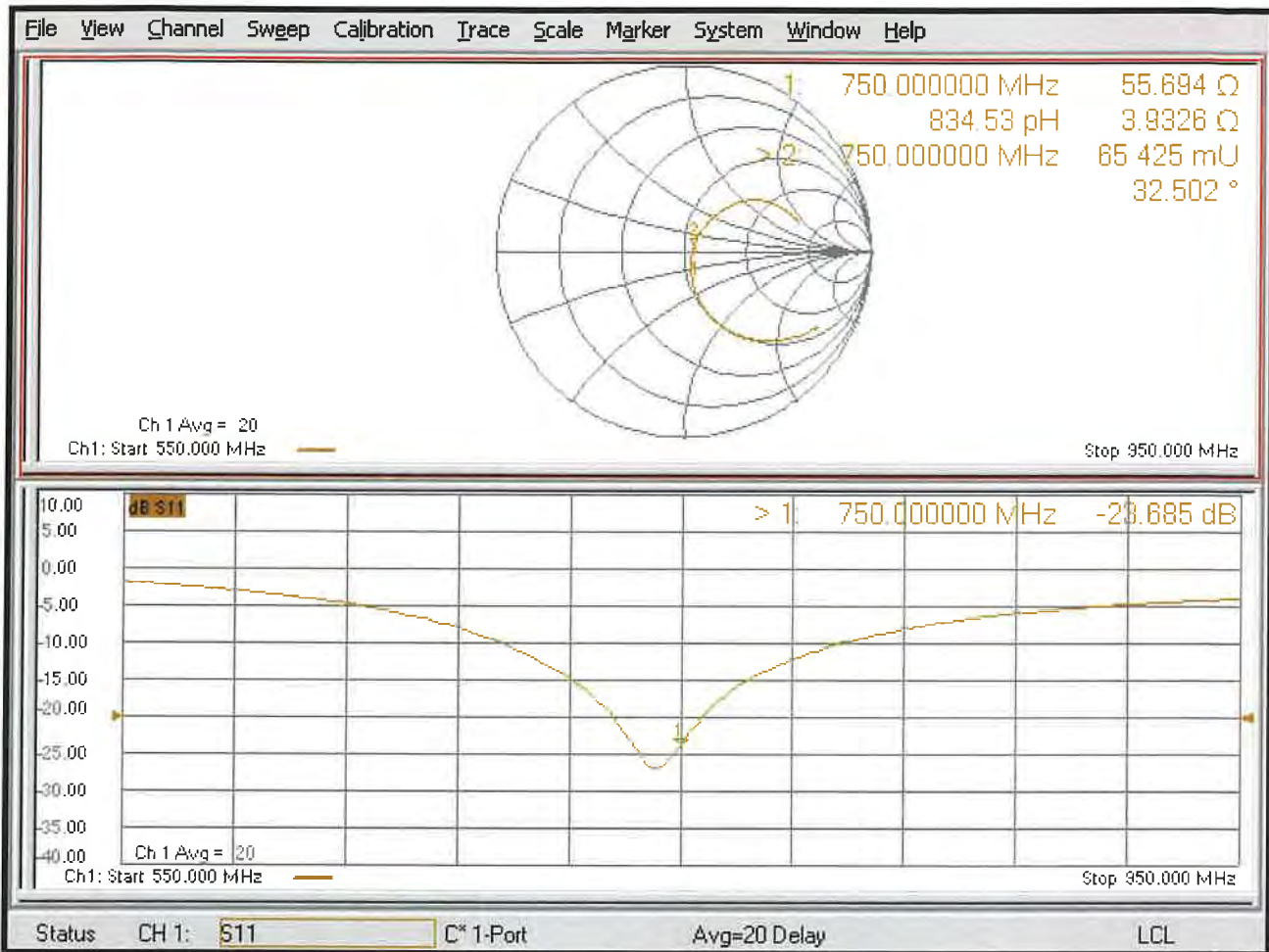



## Dipole Impedance Measurement

Equipment Location	Equipment Name	Model Name	Date of Verification
UL Verification Services Inc. 47173 Benicia Street Fremont, CA 94538, U.S.A.	Dipole Antenna	D750V3-1019	April 13, 2024

Number:	Check List:	Result:
1	Visual Inspection	Pass
2	Return/Loss and Impedance	Pass
3	Dipole Arms	Pass

Equipment List:	
Equipment Name:	Calibration Date:
R&S ZNLE6 Vector Network Analyzer	03/05/2024
ZV-Z135 Calibration Kit	03/27/2024

## Dipole Impedance Measurement

### 1) Photo of Dipole

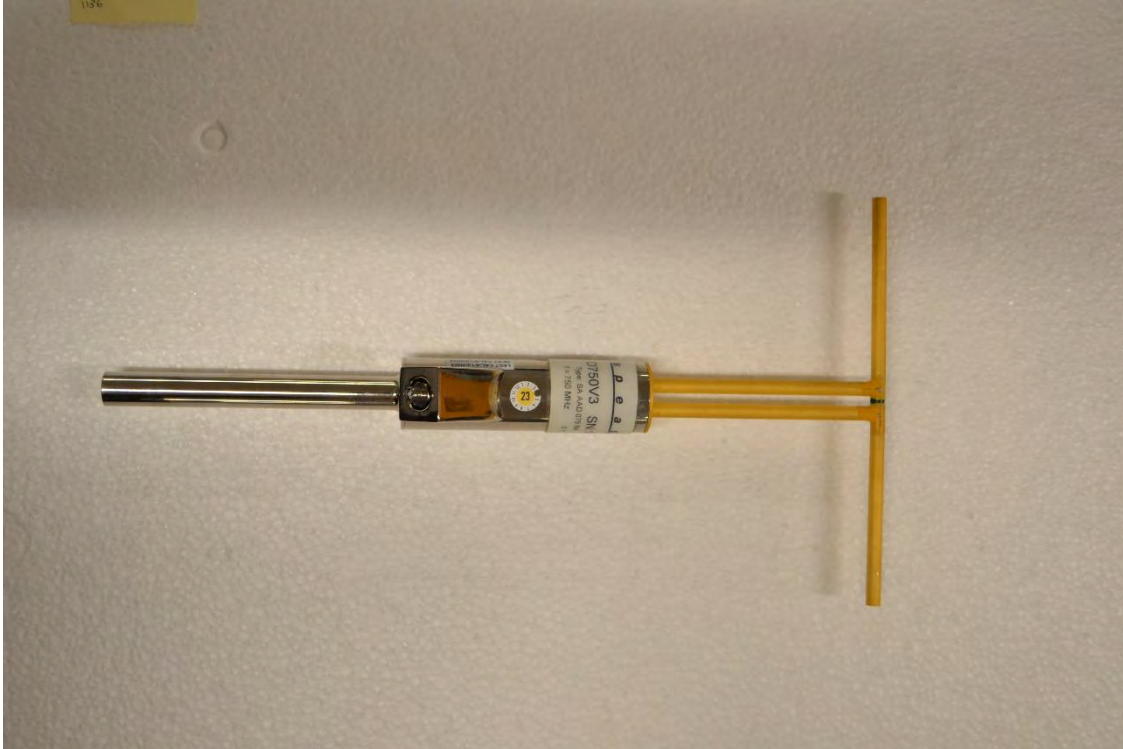

- The connector of dipole contains no abnormalities.



## Dipole Impedance Measurement

### 2) Impedance and Return/Loss

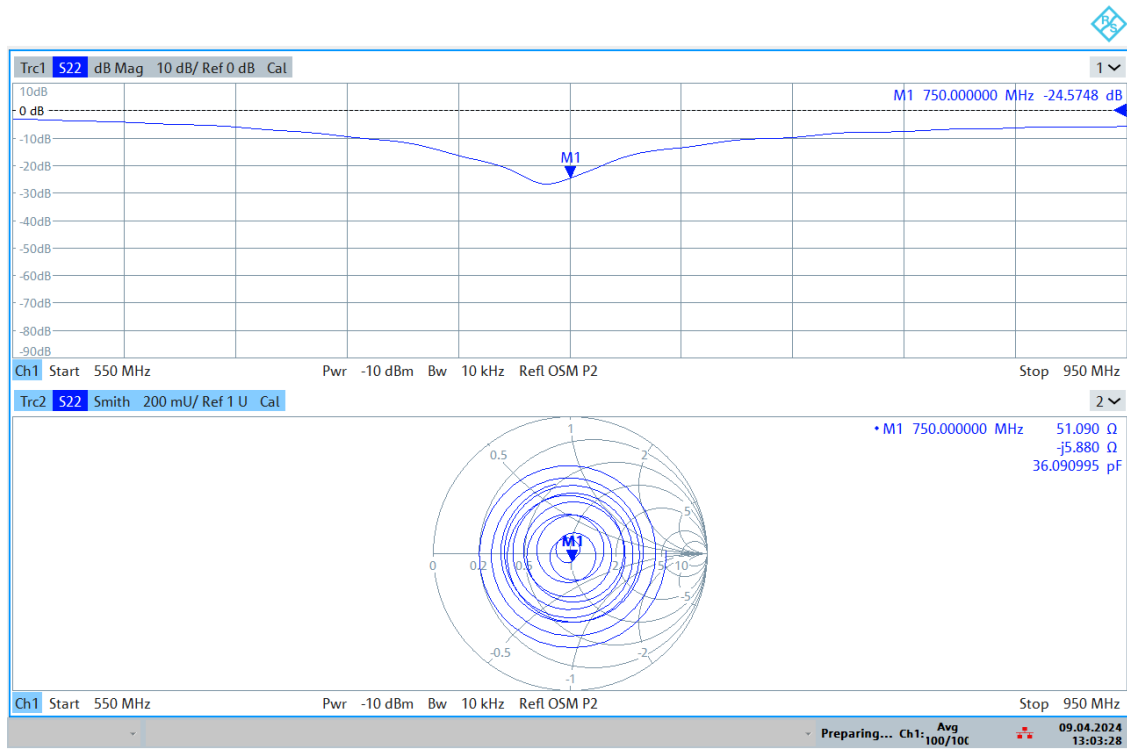

13:03:29 09.04.2024

- Return/Loss is greater than the -20 dB cutoff and Impedance is within 5 Ω of previous value.

## Dipole Impedance Measurement

### 3) Dipole Arms

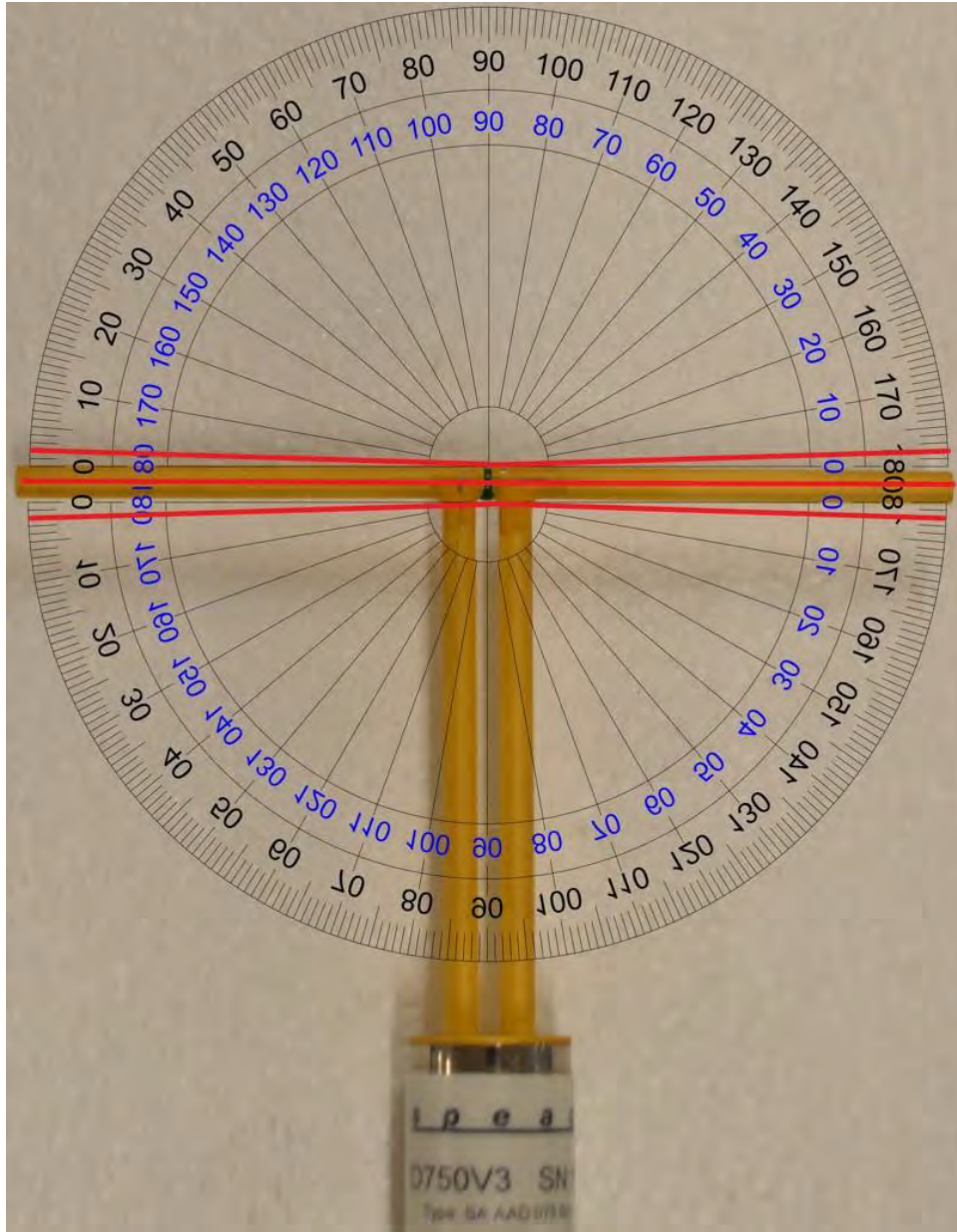

- The center red line indicates that the arms of the dipole fall within  $\pm 2^\circ$



## Dipole Impedance Measurement

Equipment Location	Equipment Name	Model Name	Date of Verification
UL Verification Services Inc. 47173 Benicia Street Fremont, CA 94538, U.S.A.	Dipole Antenna	D750V3-1019	April 2, 2025

Number:	Check List:	Result:
1	Visual Inspection	Pass
2	Return/Loss and Impedance	Pass
3	Dipole Arms	Pass

Equipment List:	
Equipment Name:	Calibration Date:
R&S Vector Network Analyzer	2/20/2025
ZV-Z135 Calibration Kit	2/19/2025

## Dipole Impedance Measurement

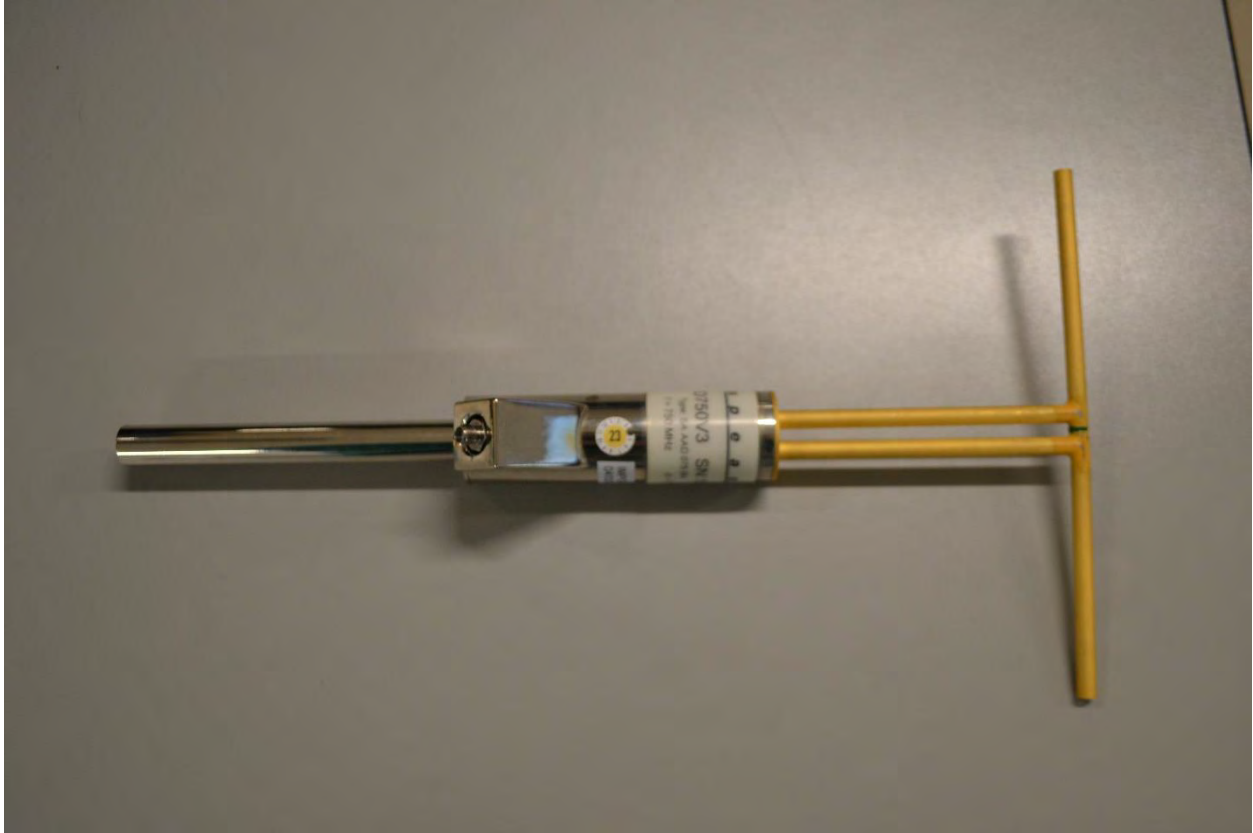

- The connector of dipole contains no abnormalities.

# Dipole Impedance Measurement

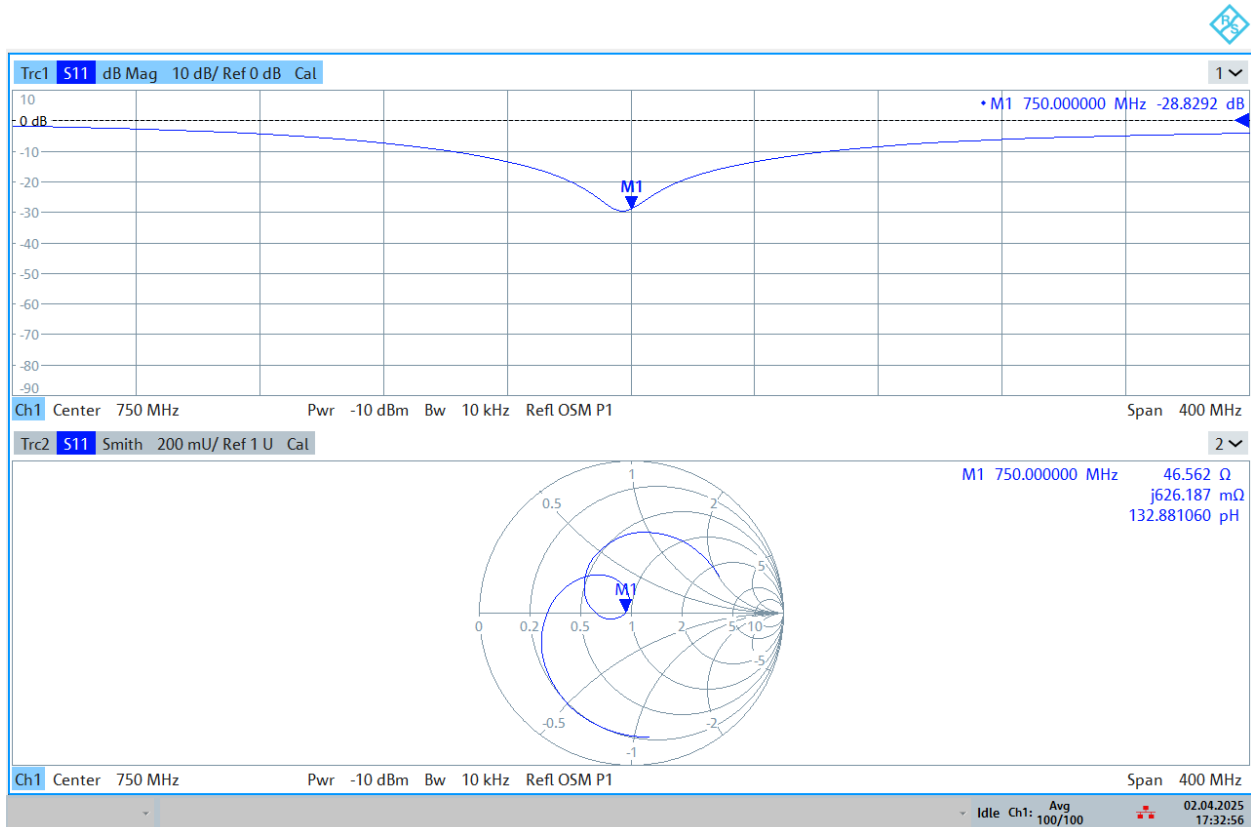

17:32:57 02.04.2025

- Return/Loss is greater than the -20 dB cutoff and Impedance is within 5 Ω of previous value.

## Dipole Impedance Measurement



- The center red line indicates that the arms of the dipole fall within  $\pm 2^\circ$



Accredited by the Swiss Accreditation Service (SAS)  
The Swiss Accreditation Service is one of the signatories to the EA  
Multilateral Agreement for the recognition of calibration certificates

Client **UL**  
Fremont, USA

Certificate No. **D750V3-1024\_May23**

## CALIBRATION CERTIFICATE

Object **D750V3 - SN:1024**

Calibration procedure(s) **QA CAL-05.v12  
Calibration Procedure for SAR Validation Sources between 0.7-3 GHz**

Calibration date: **May 11, 2023**

This calibration certificate documents the traceability to national standards, which realize the physical units of measurements (SI).  
The measurements and the uncertainties with confidence probability are given on the following pages and are part of the certificate.

All calibrations have been conducted in the closed laboratory facility: environment temperature ( $22 \pm 3$ )°C and humidity < 70%.

Calibration Equipment used (M&TE critical for calibration)

Primary Standards	ID #	Cal Date (Certificate No.)	Scheduled Calibration
Power meter NRP2	SN: 104778	30-Mar-23 (No. 217-03804/03805)	Mar-24
Power sensor NRP-Z91	SN: 103244	30-Mar-23 (No. 217-03804)	Mar-24
Power sensor NRP-Z91	SN: 103245	30-Mar-23 (No. 217-03805)	Mar-24
Reference 20 dB Attenuator	SN: BH9394 (20k)	30-Mar-23 (No. 217-03809)	Mar-24
Type-N mismatch combination	SN: 310982 / 06327	30-Mar-23 (No. 217-03810)	Mar-24
Reference Probe EX3DV4	SN: 7349	10-Jan-23 (No. EX3-7349_Jan23)	Jan-24
DAE4	SN: 601	19-Dec-22 (No. DAE4-601_Dec22)	Dec-23
Secondary Standards	ID #	Check Date (in house)	Scheduled Check
Power meter E4419B	SN: GB39512475	30-Oct-14 (in house check Oct-22)	In house check: Oct-24
Power sensor HP 8481A	SN: US37292783	07-Oct-15 (in house check Oct-22)	In house check: Oct-24
Power sensor HP 8481A	SN: MY41093315	07-Oct-15 (in house check Oct-22)	In house check: Oct-24
RF generator R&S SMT-06	SN: 100972	15-Jun-15 (in house check Oct-22)	In house check: Oct-24
Network Analyzer Agilent E8358A	SN: US41080477	31-Mar-14 (in house check Oct-22)	In house check: Oct-24

Calibrated by: **Paulo Pina** Laboratory Technician

Signature

Approved by: **Sven Kühn** Technical Manager

Issued: May 12, 2023

This calibration certificate shall not be reproduced except in full without written approval of the laboratory.



Accredited by the Swiss Accreditation Service (SAS)  
The Swiss Accreditation Service is one of the signatories to the EA  
Multilateral Agreement for the recognition of calibration certificates

### Glossary:

TSL	tissue simulating liquid
ConvF	sensitivity in TSL / NORM x,y,z
N/A	not applicable or not measured

### Calibration is Performed According to the Following Standards:

- IEC/IEEE 62209-1528, "Measurement Procedure For The Assessment Of Specific Absorption Rate Of Human Exposure To Radio Frequency Fields From Hand-Held And Body-Worn Wireless Communication Devices - Part 1528: Human Models, Instrumentation And Procedures (Frequency Range of 4 MHz to 10 GHz)", October 2020.
- KDB 865664, "SAR Measurement Requirements for 100 MHz to 6 GHz"

### Additional Documentation:

- DASY System Handbook

### Methods Applied and Interpretation of Parameters:

- Measurement Conditions:* Further details are available from the Validation Report at the end of the certificate. All figures stated in the certificate are valid at the frequency indicated.
- Antenna Parameters with TSL:* The source is mounted in a touch configuration below the center marking of the flat phantom.
- Return Loss:* This parameter is measured with the source positioned under the liquid filled phantom (as described in the measurement condition clause). The Return Loss ensures low reflected power. No uncertainty required.
- SAR measured:* SAR measured at the stated antenna input power.
- SAR normalized:* SAR as measured, normalized to an input power of 1 W at the antenna connector.
- SAR for nominal TSL parameters:* The measured TSL parameters are used to calculate the nominal SAR result.

The reported uncertainty of measurement is stated as the standard uncertainty of measurement multiplied by the coverage factor  $k=2$ , which for a normal distribution corresponds to a coverage probability of approximately 95%.



## Measurement Conditions

DASY system configuration, as far as not given on page 1.

<b>DASY Version</b>	DASY52	V52.10.4
<b>Extrapolation</b>	Advanced Extrapolation	
<b>Phantom</b>	Modular Flat Phantom	
<b>Distance Dipole Center - TSL</b>	15 mm	with Spacer
<b>Zoom Scan Resolution</b>	dx, dy, dz = 5 mm	
<b>Frequency</b>	750 MHz ± 1 MHz	

## Head TSL parameters

The following parameters and calculations were applied.

	<b>Temperature</b>	<b>Permittivity</b>	<b>Conductivity</b>
<b>Nominal Head TSL parameters</b>	22.0 °C	41.9	0.89 mho/m
<b>Measured Head TSL parameters</b>	(22.0 ± 0.2) °C	41.5 ± 6 %	0.91 mho/m ± 6 %
<b>Head TSL temperature change during test</b>	< 0.5 °C	---	---

## SAR result with Head TSL

<b>SAR averaged over 1 cm<sup>3</sup> (1 g) of Head TSL</b>	Condition	
SAR measured	250 mW input power	2.17 W/kg
SAR for nominal Head TSL parameters	normalized to 1W	<b>8.52 W/kg ± 17.0 % (k=2)</b>

<b>SAR averaged over 10 cm<sup>3</sup> (10 g) of Head TSL</b>	condition	
SAR measured	250 mW input power	1.42 W/kg
SAR for nominal Head TSL parameters	normalized to 1W	<b>5.60 W/kg ± 16.5 % (k=2)</b>

## Appendix (Additional assessments outside the scope of SCS 0108)

### Antenna Parameters with Head TSL

Impedance, transformed to feed point	$56.1 \Omega + 3.3 j\Omega$
Return Loss	- 23.7 dB

### General Antenna Parameters and Design

Electrical Delay (one direction)	1.020 ns
----------------------------------	----------

After long term use with 100W radiated power, only a slight warming of the dipole near the feedpoint can be measured.

The dipole is made of standard semirigid coaxial cable. The center conductor of the feeding line is directly connected to the second arm of the dipole. The antenna is therefore short-circuited for DC-signals. On some of the dipoles, small end caps are added to the dipole arms in order to improve matching when loaded according to the position as explained in the "Measurement Conditions" paragraph. The SAR data are not affected by this change. The overall dipole length is still according to the Standard.

No excessive force must be applied to the dipole arms, because they might bend or the soldered connections near the feedpoint may be damaged.

### Additional EUT Data

Manufactured by	SPEAG
-----------------	-------

# DASY5 Validation Report for Head TSL

Date: 11.05.2023

Test Laboratory: SPEAG, Zurich, Switzerland

**DUT: Dipole 750 MHz; Type: D750V3; Serial: D750V3 - SN:1024**

Communication System: UID 0 - CW; Frequency: 750 MHz

Medium parameters used:  $f = 750$  MHz;  $\sigma = 0.91$  S/m;  $\epsilon_r = 41.5$ ;  $\rho = 1000$  kg/m<sup>3</sup>

Phantom section: Flat Section

Measurement Standard: DASY5 (IEEE/IEC/ANSI C63.19-2011)

DASY52 Configuration:

- Probe: EX3DV4 - SN7349; ConvF(10.11, 10.11, 10.11) @ 750 MHz; Calibrated: 10.01.2023
- Sensor-Surface: 1.4mm (Mechanical Surface Detection)
- Electronics: DAE4 Sn601; Calibrated: 19.12.2022
- Phantom: Flat Phantom 4.9 (front); Type: QD 00L P49 AA; Serial: 1001
- DASY52 52.10.4(1535); SEMCAD X 14.6.14(7501)

## Dipole Calibration for Head Tissue/Pin=250 mW, d=15mm/Zoom Scan (7x7x7)/Cube 0:

Measurement grid: dx=5mm, dy=5mm, dz=5mm

Reference Value = 59.63 V/m; Power Drift = -0.02 dB

Peak SAR (extrapolated) = 3.29 W/kg

**SAR(1 g) = 2.17 W/kg; SAR(10 g) = 1.42 W/kg**

Smallest distance from peaks to all points 3 dB below = 17 mm

Ratio of SAR at M2 to SAR at M1 = 65.8%

Maximum value of SAR (measured) = 2.88 W/kg

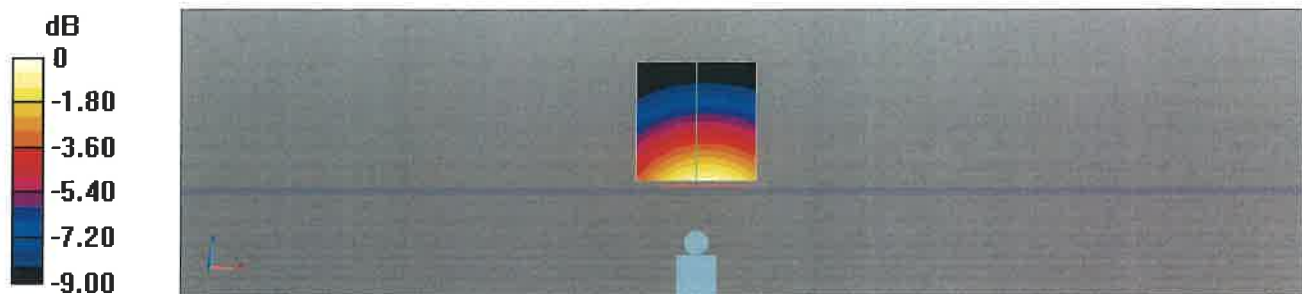

0 dB = 2.88 W/kg = 4.59 dBW/kg

# Impedance Measurement Plot for Head TSL

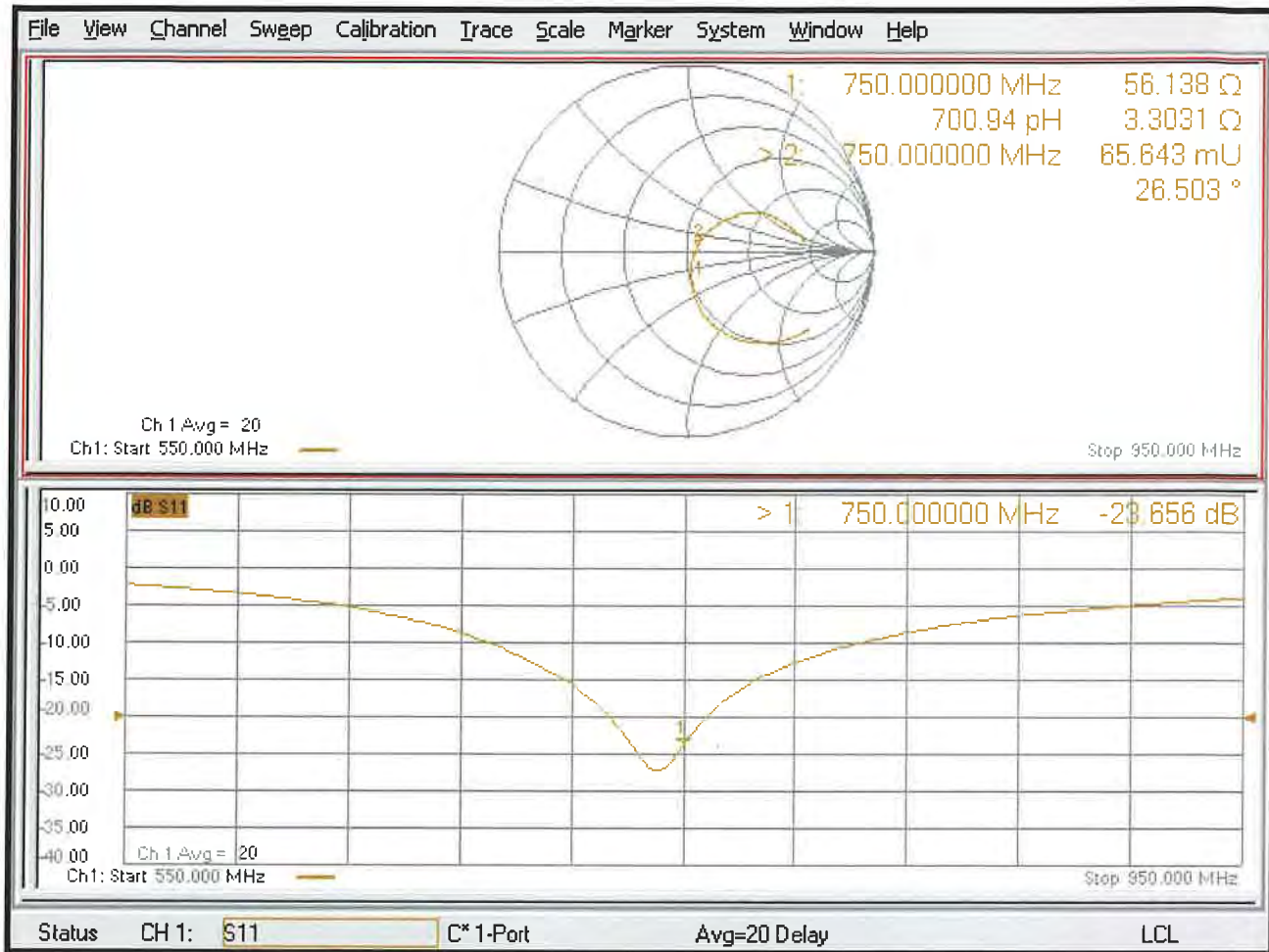



## Dipole Impedance Measurement

Equipment Location	Equipment Name	Model Name	Date of Verification
UL Verification Services Inc. 47173 Benicia Street Fremont, CA 94538, U.S.A.	Dipole Antenna	D750V3-1024	May 7th, 2025

Number:	Check List:	Result:
1	Visual Inspection	Pass
2	Return/Loss and Impedance	Pass
3	Dipole Arms	Pass

Equipment List:	
Equipment Name:	Calibration Date:
R&S Vector Network Analyzer	2/19/2025
ZV-Z135 Calibration Kit	5/13/2024

## Dipole Impedance Measurement

### 1) Photo of Dipole



- The connector of dipole contains no abnormalities.

## 2) Impedance and Return/Loss

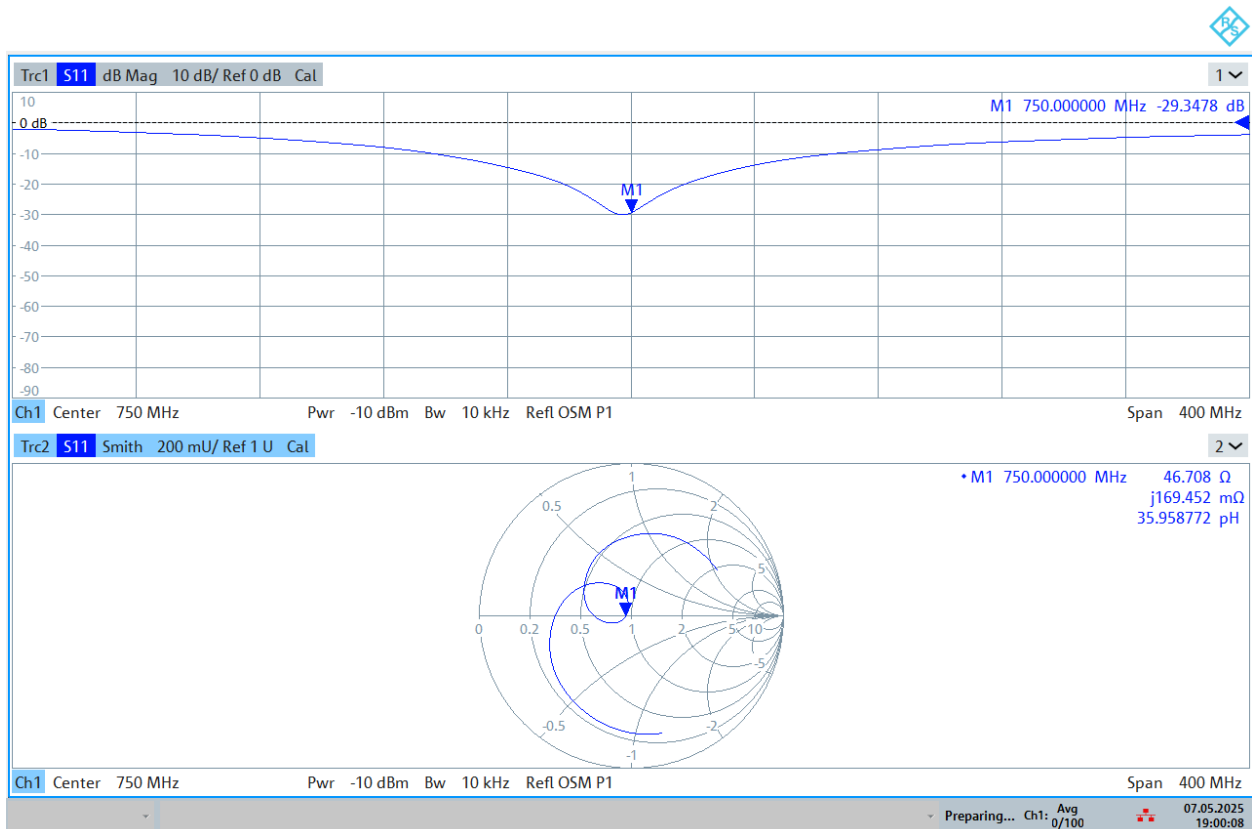

19:00:09 07.05.2025

- Return/Loss is greater than the -20 dB cutoff and Impedance is within 5 Ω of previous value.

### 3) Dipole Arms

- The center red line indicates that the arms of the dipole fall within  $\pm 2^\circ$





Accredited by the Swiss Accreditation Service (SAS)  
The Swiss Accreditation Service is one of the signatories to the EA  
Multilateral Agreement for the recognition of calibration certificates

Accreditation No.: **SCS 0108**

Client **UL**  
Fremont, USA

Certificate No. **D750V3-1071\_Nov23**

**CALIBRATION CERTIFICATE**

Object **D750V3 - SN:1071**

Calibration procedure(s) **QA CAL-05.v12  
Calibration Procedure for SAR Validation Sources between 0.7-3 GHz**

Calibration date: **November 07, 2023**

This calibration certificate documents the traceability to national standards, which realize the physical units of measurements (SI).  
The measurements and the uncertainties with confidence probability are given on the following pages and are part of the certificate.

All calibrations have been conducted in the closed laboratory facility: environment temperature (22 ± 3)°C and humidity < 70%.

Calibration Equipment used (M&TE critical for calibration)

Primary Standards	ID #	Cal Date (Certificate No.)	Scheduled Calibration
Power meter NRP2	SN: 104778	30-Mar-23 (No. 217-03804/03805)	Mar-24
Power sensor NRP-Z91	SN: 103244	30-Mar-23 (No. 217-03804)	Mar-24
Power sensor NRP-Z91	SN: 103245	30-Mar-23 (No. 217-03805)	Mar-24
Reference 20 dB Attenuator	SN: BH9394 (20k)	30-Mar-23 (No. 217-03809)	Mar-24
Type-N mismatch combination	SN: 310982 / 06327	30-Mar-23 (No. 217-03810)	Mar-24
Reference Probe EX3DV4	SN: 7349	03-Nov-23 (No. EX3-7349_Nov23)	Nov-24
DAE4	SN: 601	03-Oct-23 (No. DAE4-601_Oct23)	Oct-24
Secondary Standards	ID #	Check Date (in house)	Scheduled Check
Power meter E4419B	SN: GB39512475	30-Oct-14 (in house check Oct-22)	In house check: Oct-24
Power sensor HP 8481A	SN: US37292783	07-Oct-15 (in house check Oct-22)	In house check: Oct-24
Power sensor HP 8481A	SN: MY41093315	07-Oct-15 (in house check Oct-22)	In house check: Oct-24
RF generator R&S SMT-06	SN: 100972	15-Jun-15 (in house check Oct-22)	In house check: Oct-24
Network Analyzer Agilent E8358A	SN: US41080477	31-Mar-14 (in house check Oct-22)	In house check: Oct-24

Calibrated by: **Paulo Pina** Laboratory Technician *[Signature]*

Approved by: **Sven Kühn** Technical Manager *[Signature]*

Issued: November 8, 2023

This calibration certificate shall not be reproduced except in full without written approval of the laboratory.



Accredited by the Swiss Accreditation Service (SAS)

The Swiss Accreditation Service is one of the signatories to the EA  
Multilateral Agreement for the recognition of calibration certificates

### Glossary:

TSL	tissue simulating liquid
ConvF	sensitivity in TSL / NORM x,y,z
N/A	not applicable or not measured

### Calibration is Performed According to the Following Standards:

- a) IEC/IEEE 62209-1528, "Measurement Procedure For The Assessment Of Specific Absorption Rate Of Human Exposure To Radio Frequency Fields From Hand-Held And Body-Worn Wireless Communication Devices - Part 1528: Human Models, Instrumentation And Procedures (Frequency Range of 4 MHz to 10 GHz)", October 2020.
- b) KDB 865664, "SAR Measurement Requirements for 100 MHz to 6 GHz"

### Additional Documentation:

- c) DASY System Handbook

### Methods Applied and Interpretation of Parameters:

- *Measurement Conditions:* Further details are available from the Validation Report at the end of the certificate. All figures stated in the certificate are valid at the frequency indicated.
- *Antenna Parameters with TSL:* The source is mounted in a touch configuration below the center marking of the flat phantom.
- *Return Loss:* This parameter is measured with the source positioned under the liquid filled phantom (as described in the measurement condition clause). The Return Loss ensures low reflected power. No uncertainty required.
- *SAR measured:* SAR measured at the stated antenna input power.
- *SAR normalized:* SAR as measured, normalized to an input power of 1 W at the antenna connector.
- *SAR for nominal TSL parameters:* The measured TSL parameters are used to calculate the nominal SAR result.

The reported uncertainty of measurement is stated as the standard uncertainty of measurement multiplied by the coverage factor  $k=2$ , which for a normal distribution corresponds to a coverage probability of approximately 95%.

## Measurement Conditions

DASY system configuration, as far as not given on page 1.

<b>DASY Version</b>	DASY52	V52.10.4
<b>Extrapolation</b>	Advanced Extrapolation	
<b>Phantom</b>	Modular Flat Phantom	
<b>Distance Dipole Center - TSL</b>	15 mm	with Spacer
<b>Zoom Scan Resolution</b>	dx, dy, dz = 5 mm	
<b>Frequency</b>	750 MHz $\pm$ 1 MHz	

## Head TSL parameters

The following parameters and calculations were applied.

	Temperature	Permittivity	Conductivity
<b>Nominal Head TSL parameters</b>	22.0 °C	41.9	0.89 mho/m
<b>Measured Head TSL parameters</b>	(22.0 $\pm$ 0.2) °C	42.7 $\pm$ 6 %	0.89 mho/m $\pm$ 6 %
<b>Head TSL temperature change during test</b>	< 0.5 °C	---	---

## SAR result with Head TSL

<b>SAR averaged over 1 cm<sup>3</sup> (1 g) of Head TSL</b>	Condition	
SAR measured	250 mW input power	2.11 W/kg
SAR for nominal Head TSL parameters	normalized to 1W	<b>8.49 W/kg <math>\pm</math> 17.0 % (k=2)</b>

<b>SAR averaged over 10 cm<sup>3</sup> (10 g) of Head TSL</b>	condition	
SAR measured	250 mW input power	1.39 W/kg
SAR for nominal Head TSL parameters	normalized to 1W	<b>5.57 W/kg <math>\pm</math> 16.5 % (k=2)</b>

## Appendix (Additional assessments outside the scope of SCS 0108)

### Antenna Parameters with Head TSL

Impedance, transformed to feed point	54.1 $\Omega$ - 0.8 j $\Omega$
Return Loss	- 27.9 dB

### General Antenna Parameters and Design

Electrical Delay (one direction)	1.038 ns
----------------------------------	----------

After long term use with 100W radiated power, only a slight warming of the dipole near the feedpoint can be measured.

The dipole is made of standard semirigid coaxial cable. The center conductor of the feeding line is directly connected to the second arm of the dipole. The antenna is therefore short-circuited for DC-signals. On some of the dipoles, small end caps are added to the dipole arms in order to improve matching when loaded according to the position as explained in the "Measurement Conditions" paragraph. The SAR data are not affected by this change. The overall dipole length is still according to the Standard.

No excessive force must be applied to the dipole arms, because they might bend or the soldered connections near the feedpoint may be damaged.

### Additional EUT Data

Manufactured by	SPEAG
-----------------	-------

# DASY5 Validation Report for Head TSL

Date: 07.11.2023

Test Laboratory: SPEAG, Zurich, Switzerland

**DUT: Dipole 750 MHz; Type: D750V3; Serial: D750V3 - SN:1071**

Communication System: UID 0 - CW; Frequency: 750 MHz

Medium parameters used:  $f = 750$  MHz;  $\sigma = 0.89$  S/m;  $\epsilon_r = 42.7$ ;  $\rho = 1000$  kg/m<sup>3</sup>

Phantom section: Flat Section

Measurement Standard: DASY5 (IEEE/IEC/ANSI C63.19-2011)

DASY52 Configuration:

- Probe: EX3DV4 - SN7349; ConvF(10.11, 10.11, 10.11) @ 750 MHz; Calibrated: 03.11.2023
- Sensor-Surface: 1.4mm (Mechanical Surface Detection)
- Electronics: DAE4 Sn601; Calibrated: 03.10.2023
- Phantom: Flat Phantom 4.9 (front); Type: QD 00L P49 AA; Serial: 1001
- DASY52 52.10.4(1535); SEMCAD X 14.6.14(7501)

## Dipole Calibration for Head Tissue/Pin=250 mW, d=15mm/Zoom Scan (7x7x7)/Cube 0:

Measurement grid: dx=5mm, dy=5mm, dz=5mm

Reference Value = 60.01 V/m; Power Drift = -0.02 dB

Peak SAR (extrapolated) = 3.17 W/kg

**SAR(1 g) = 2.11 W/kg; SAR(10 g) = 1.39 W/kg**

Smallest distance from peaks to all points 3 dB below = 18.4 mm

Ratio of SAR at M2 to SAR at M1 = 66.6%

Maximum value of SAR (measured) = 2.81 W/kg

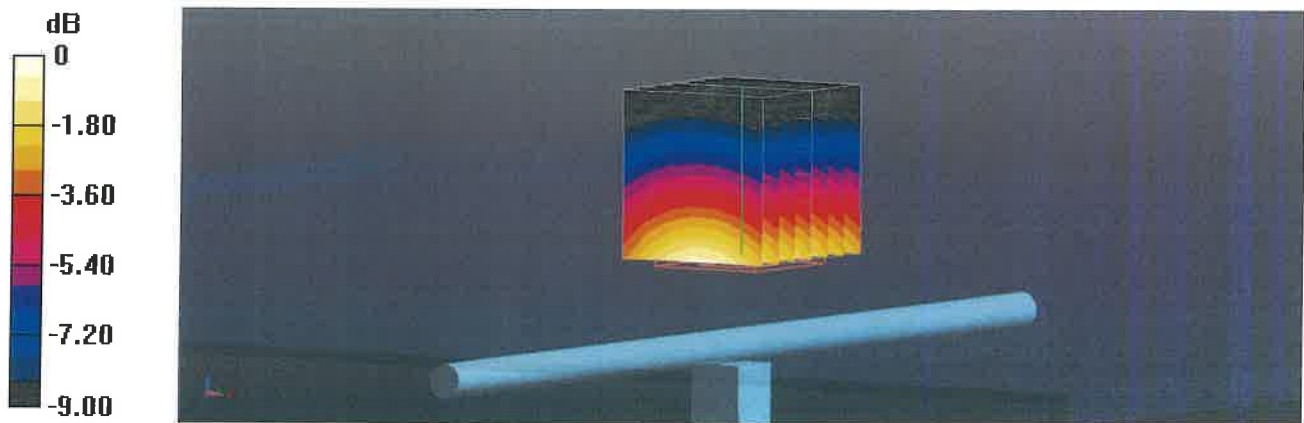

0 dB = 2.81 W/kg = 4.48 dBW/kg

# Impedance Measurement Plot for Head TSL

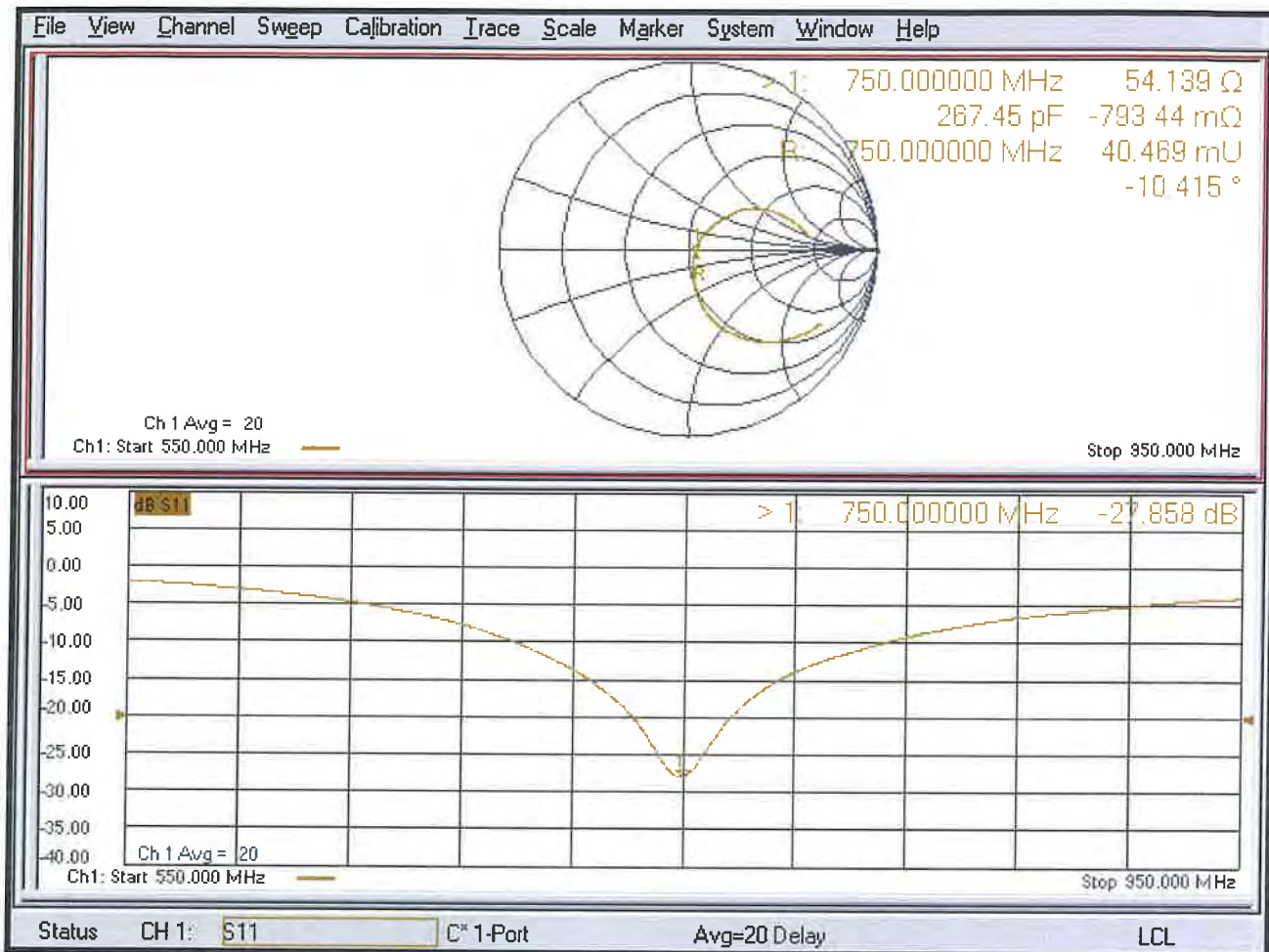



## Dipole Impedance Measurement

Equipment Location	Equipment Name	Model Name	Date of Verification
UL Verification Services Inc. 47173 Benicia Street Fremont, CA 94538, U.S.A.	Dipole Antenna	D750V2-1071	October 18, 2024

Number:	Check List:	Result:
1	Visual Inspection	Pass
2	Return/Loss and Impedance	Pass
3	Dipole Arms	Pass

Equipment List:	
Equipment Name:	Calibration Date:
R&S Vector Network Analyzer	2/13/2024
ZV-Z135 Calibration Kit	5/17/2024

## Dipole Impedance Measurement

### 1) Photo of Dipole



- The connector of dipole contains no abnormalities.



## Dipole Impedance Measurement

### 2) Impedance and Return/Loss

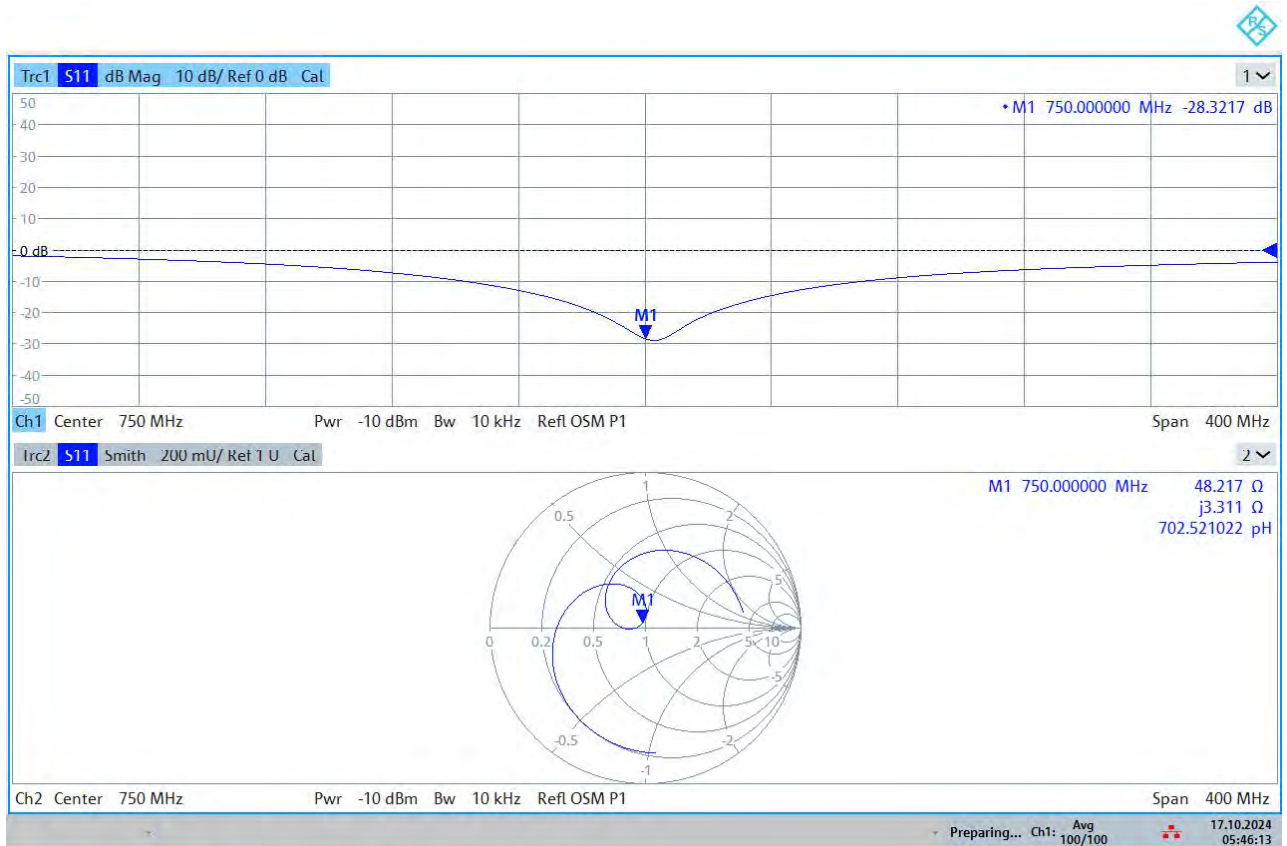

05:46:15 17.10.2024

- Return/Loss is greater than the -20 dB cutoff and Impedance is within 5 Ω of previous value.

## Dipole Impedance Measurement

### 3) Dipole Arms

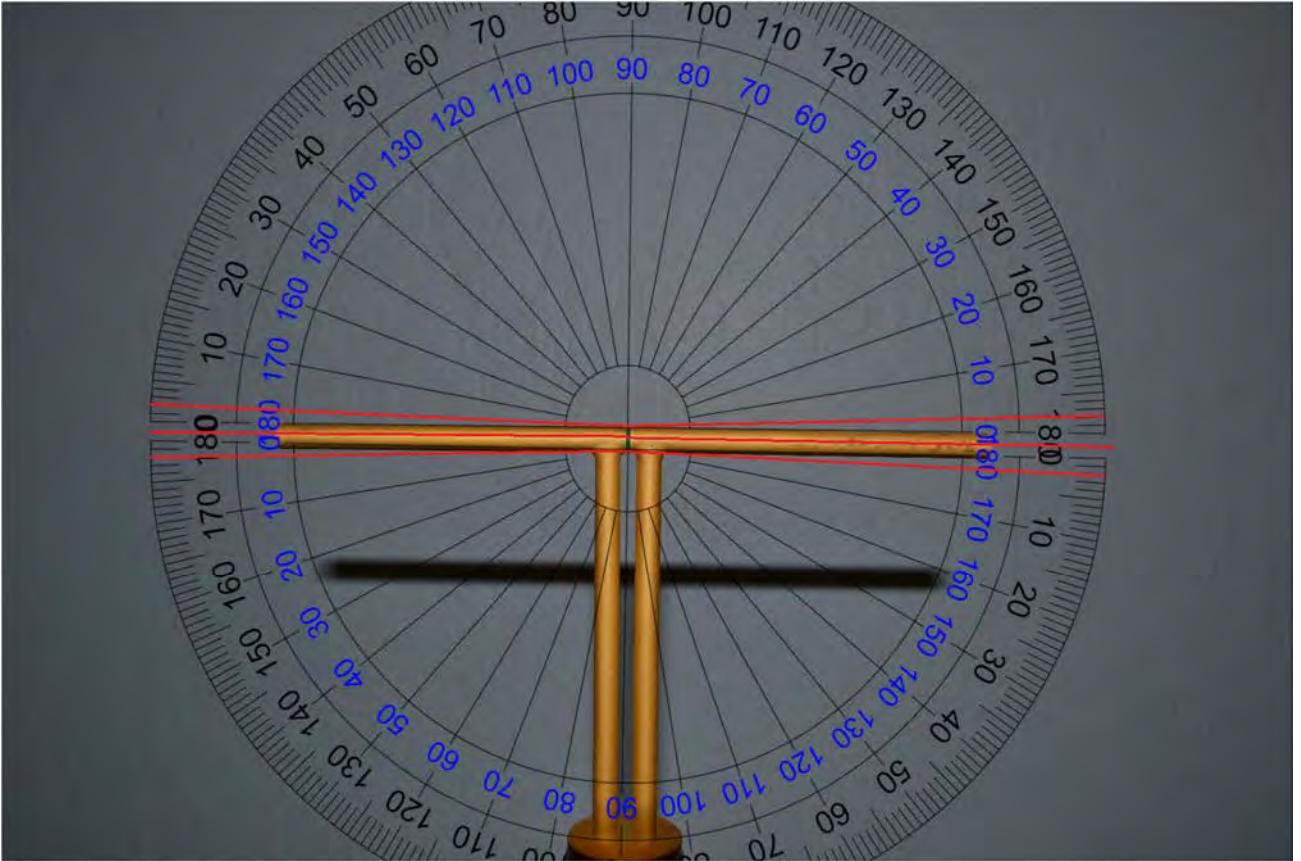

- The center red line indicates that the arms of the dipole fall within  $\pm 2^\circ$



Accredited by the Swiss Accreditation Service (SAS)  
The Swiss Accreditation Service is one of the signatories to the EA  
Multilateral Agreement for the recognition of calibration certificates

Accreditation No.: **SCS 0108**

Client **UL**  
**Fremont, USA**

Certificate No. **D835V2-4d002\_Nov23**

## CALIBRATION CERTIFICATE

Object **D835V2 - SN:4d002**

Calibration procedure(s) **QA CAL-05.v12  
Calibration Procedure for SAR Validation Sources between 0.7-3 GHz**

Calibration date: **November 07, 2023**

This calibration certificate documents the traceability to national standards, which realize the physical units of measurements (SI).  
The measurements and the uncertainties with confidence probability are given on the following pages and are part of the certificate.

All calibrations have been conducted in the closed laboratory facility: environment temperature (22 ± 3)°C and humidity < 70%.

Calibration Equipment used (M&TE critical for calibration)

Primary Standards	ID #	Cal Date (Certificate No.)	Scheduled Calibration
Power meter NRP2	SN: 104778	30-Mar-23 (No. 217-03804/03805)	Mar-24
Power sensor NRP-Z91	SN: 103244	30-Mar-23 (No. 217-03804)	Mar-24
Power sensor NRP-Z91	SN: 103245	30-Mar-23 (No. 217-03805)	Mar-24
Reference 20 dB Attenuator	SN: BH9394 (20k)	30-Mar-23 (No. 217-03809)	Mar-24
Type-N mismatch combination	SN: 310982 / 06327	30-Mar-23 (No. 217-03810)	Mar-24
Reference Probe EX3DV4	SN: 7349	03-Nov-23 (No. EX3-7349_Nov23)	Nov-24
DAE4	SN: 601	03-Oct-23 (No. DAE4-601_Oct23)	Oct-24
Secondary Standards	ID #	Check Date (in house)	Scheduled Check
Power meter E4419B	SN: GB39512475	30-Oct-14 (in house check Oct-22)	In house check: Oct-24
Power sensor HP 8481A	SN: US37292783	07-Oct-15 (in house check Oct-22)	In house check: Oct-24
Power sensor HP 8481A	SN: MY41093315	07-Oct-15 (in house check Oct-22)	In house check: Oct-24
RF generator R&S SMT-06	SN: 100972	15-Jun-15 (in house check Oct-22)	In house check: Oct-24
Network Analyzer Agilent E8358A	SN: US41080477	31-Mar-14 (in house check Oct-22)	In house check: Oct-24

Calibrated by: **Paulo Pina** (Name) / **Laboratory Technician** (Function) / *[Signature]* (Signature)

Approved by: **Sven Kühn** (Name) / **Technical Manager** (Function) / *[Signature]* (Signature)

Issued: November 8, 2023

This calibration certificate shall not be reproduced except in full without written approval of the laboratory.



Accredited by the Swiss Accreditation Service (SAS)

The Swiss Accreditation Service is one of the signatories to the EA  
Multilateral Agreement for the recognition of calibration certificates

### Glossary:

TSL	tissue simulating liquid
ConvF	sensitivity in TSL / NORM x,y,z
N/A	not applicable or not measured

### Calibration is Performed According to the Following Standards:

- a) IEC/IEEE 62209-1528, "Measurement Procedure For The Assessment Of Specific Absorption Rate Of Human Exposure To Radio Frequency Fields From Hand-Held And Body-Worn Wireless Communication Devices - Part 1528: Human Models, Instrumentation And Procedures (Frequency Range of 4 MHz to 10 GHz)", October 2020.
- b) KDB 865664, "SAR Measurement Requirements for 100 MHz to 6 GHz"

### Additional Documentation:

- c) DASY System Handbook

### Methods Applied and Interpretation of Parameters:

- *Measurement Conditions:* Further details are available from the Validation Report at the end of the certificate. All figures stated in the certificate are valid at the frequency indicated.
- *Antenna Parameters with TSL:* The source is mounted in a touch configuration below the center marking of the flat phantom.
- *Return Loss:* This parameter is measured with the source positioned under the liquid filled phantom (as described in the measurement condition clause). The Return Loss ensures low reflected power. No uncertainty required.
- *SAR measured:* SAR measured at the stated antenna input power.
- *SAR normalized:* SAR as measured, normalized to an input power of 1 W at the antenna connector.
- *SAR for nominal TSL parameters:* The measured TSL parameters are used to calculate the nominal SAR result.

The reported uncertainty of measurement is stated as the standard uncertainty of measurement multiplied by the coverage factor  $k=2$ , which for a normal distribution corresponds to a coverage probability of approximately 95%.

## Measurement Conditions

DASY system configuration, as far as not given on page 1.

<b>DASY Version</b>	DASY52	V52.10.4
<b>Extrapolation</b>	Advanced Extrapolation	
<b>Phantom</b>	Modular Flat Phantom	
<b>Distance Dipole Center - TSL</b>	15 mm	with Spacer
<b>Zoom Scan Resolution</b>	dx, dy, dz = 5 mm	
<b>Frequency</b>	835 MHz ± 1 MHz	

## Head TSL parameters

The following parameters and calculations were applied.

	Temperature	Permittivity	Conductivity
<b>Nominal Head TSL parameters</b>	22.0 °C	41.5	0.90 mho/m
<b>Measured Head TSL parameters</b>	(22.0 ± 0.2) °C	42.5 ± 6 %	0.92 mho/m ± 6 %
<b>Head TSL temperature change during test</b>	< 0.5 °C	---	---

## SAR result with Head TSL

<b>SAR averaged over 1 cm<sup>3</sup> (1 g) of Head TSL</b>	Condition	
SAR measured	250 mW input power	2.45 W/kg
SAR for nominal Head TSL parameters	normalized to 1W	<b>9.69 W/kg ± 17.0 % (k=2)</b>

<b>SAR averaged over 10 cm<sup>3</sup> (10 g) of Head TSL</b>	condition	
SAR measured	250 mW input power	1.60 W/kg
SAR for nominal Head TSL parameters	normalized to 1W	<b>6.33 W/kg ± 16.5 % (k=2)</b>

## Appendix (Additional assessments outside the scope of SCS 0108)

### Antenna Parameters with Head TSL

Impedance, transformed to feed point	51.3 $\Omega$ - 1.9 j $\Omega$
Return Loss	- 32.9 dB

### General Antenna Parameters and Design

Electrical Delay (one direction)	1.392 ns
----------------------------------	----------

After long term use with 100W radiated power, only a slight warming of the dipole near the feedpoint can be measured.

The dipole is made of standard semirigid coaxial cable. The center conductor of the feeding line is directly connected to the second arm of the dipole. The antenna is therefore short-circuited for DC-signals. On some of the dipoles, small end caps are added to the dipole arms in order to improve matching when loaded according to the position as explained in the "Measurement Conditions" paragraph. The SAR data are not affected by this change. The overall dipole length is still according to the Standard.

No excessive force must be applied to the dipole arms, because they might bend or the soldered connections near the feedpoint may be damaged.

### Additional EUT Data

Manufactured by	SPEAG
-----------------	-------

# DASY5 Validation Report for Head TSL

Date: 07.11.2023

Test Laboratory: SPEAG, Zurich, Switzerland

**DUT: Dipole 835 MHz; Type: D835V2; Serial: D835V2 - SN:4d002**

Communication System: UID 0 - CW; Frequency: 835 MHz

Medium parameters used:  $f = 835 \text{ MHz}$ ;  $\sigma = 0.92 \text{ S/m}$ ;  $\epsilon_r = 42.5$ ;  $\rho = 1000 \text{ kg/m}^3$

Phantom section: Flat Section

Measurement Standard: DASY5 (IEEE/IEC/ANSI C63.19-2011)

DASY52 Configuration:

- Probe: EX3DV4 - SN7349; ConvF(9.69, 9.69, 9.69) @ 835 MHz; Calibrated: 03.11.2023
- Sensor-Surface: 1.4mm (Mechanical Surface Detection)
- Electronics: DAE4 Sn601; Calibrated: 03.10.2023
- Phantom: Flat Phantom 4.9 (front); Type: QD 00L P49 AA; Serial: 1001
- DASY52 52.10.4(1535); SEMCAD X 14.6.14(7501)

## Dipole Calibration for Head Tissue/Pin=250 mW, d=15mm/Zoom Scan (7x7x7)/Cube 0:

Measurement grid:  $dx=5\text{mm}$ ,  $dy=5\text{mm}$ ,  $dz=5\text{mm}$

Reference Value = 64.11 V/m; Power Drift = -0.02 dB

Peak SAR (extrapolated) = 3.67 W/kg

**SAR(1 g) = 2.45 W/kg; SAR(10 g) = 1.60 W/kg**

Smallest distance from peaks to all points 3 dB below = 17 mm

Ratio of SAR at M2 to SAR at M1 = 66.6%

Maximum value of SAR (measured) = 3.25 W/kg

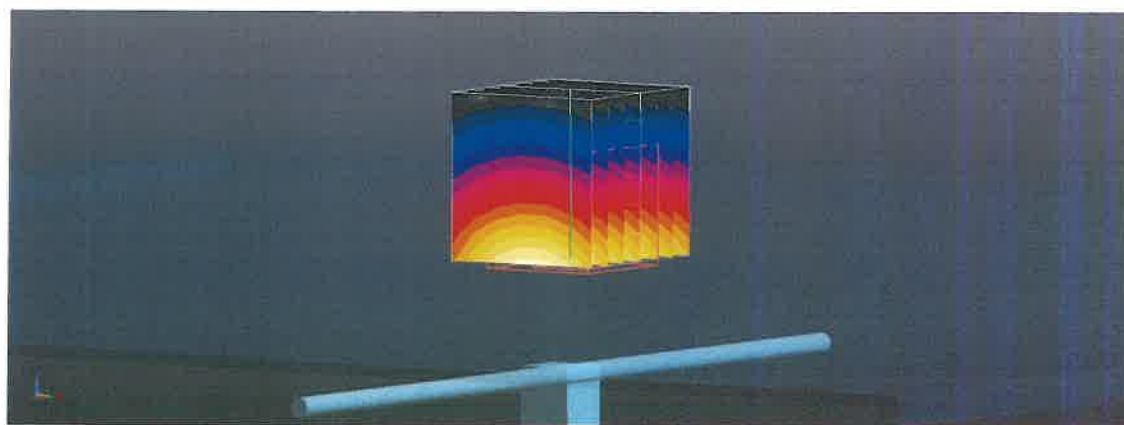
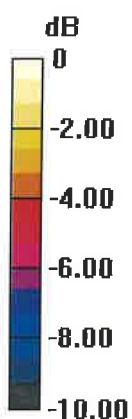

0 dB = 3.25 W/kg = 5.12 dBW/kg

# Impedance Measurement Plot for Head TSL

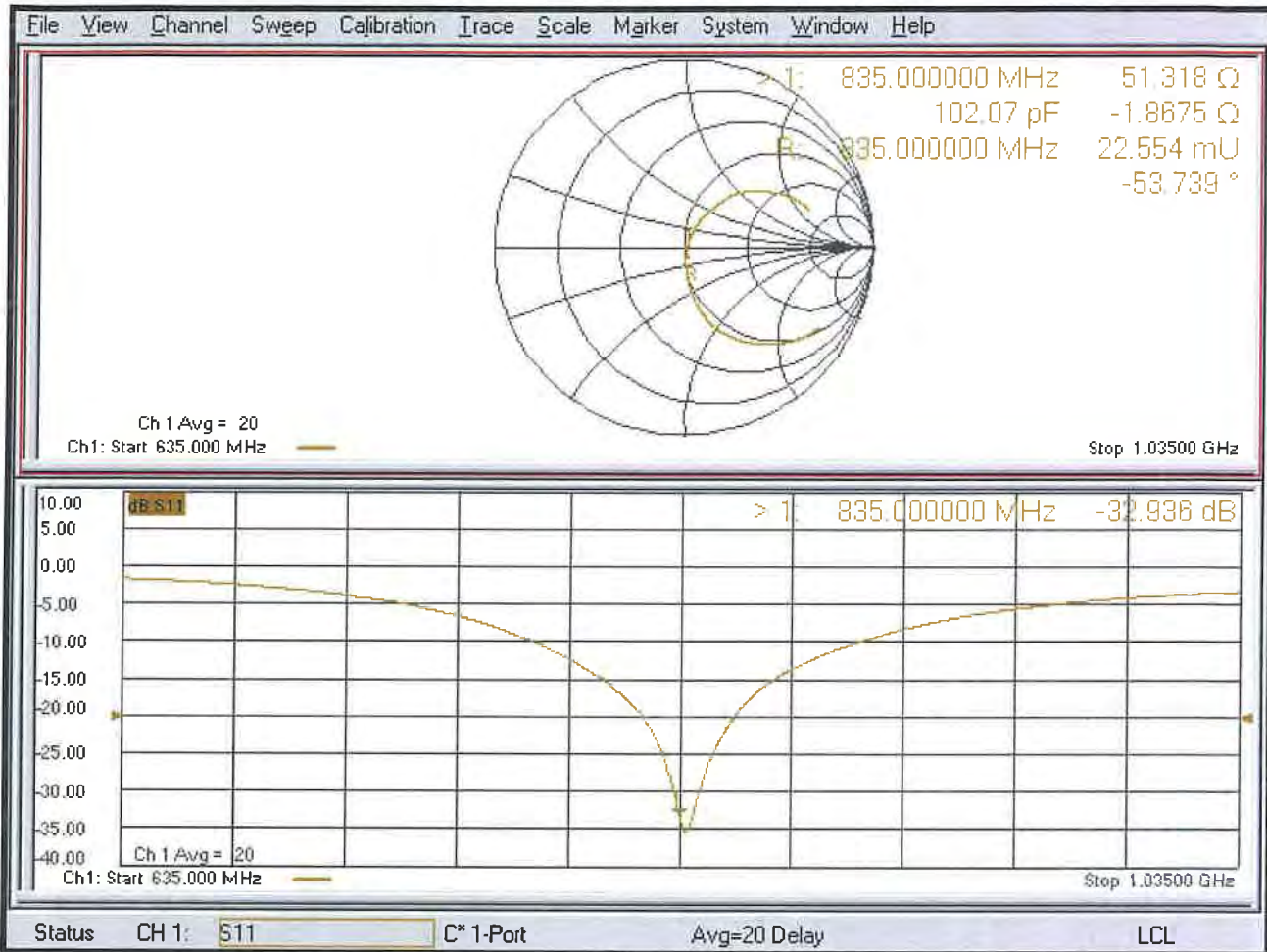





## Dipole Impedance Measurement

Equipment Location	Equipment Name	Model Name	Date of Verification
UL Verification Services Inc. 47173 Benicia Street Fremont, CA 94538, U.S.A.	Dipole Antenna	D835V2-4d002	October 16, 2024

Number:	Check List:	Result:
1	Visual Inspection	Pass
2	Return/Loss and Impedance	Pass
3	Dipole Arms	Pass

Equipment List:	
Equipment Name:	Calibration Date:
R&S Vector Network Analyzer	2/13/2024
ZV-Z135 Calibration Kit	5/17/2024

## Dipole Impedance Measurement

### 1) Photo of Dipole



- The connector of dipole contains no abnormalities.

## Dipole Impedance Measurement

### 2) Impedance and Return/Loss

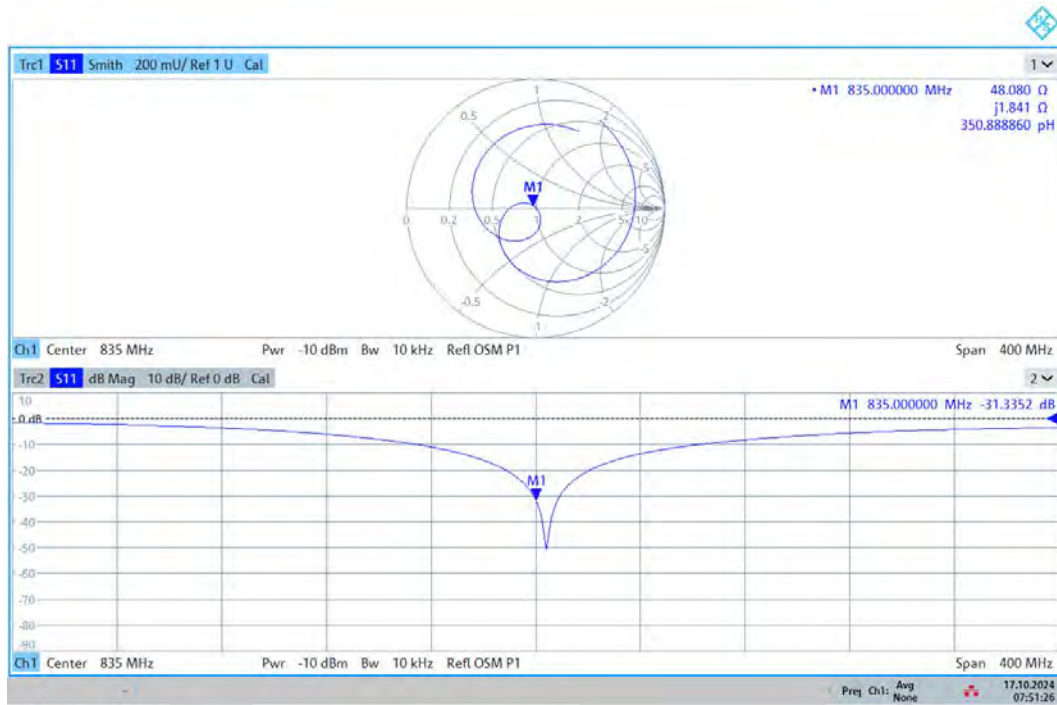

3) 07:51:28 17.10.2024

- Return/Loss is greater than the -20 dB cutoff and Impedance is within 5 Ω of previous value.

## Dipole Impedance Measurement

### 4) Dipole Arms

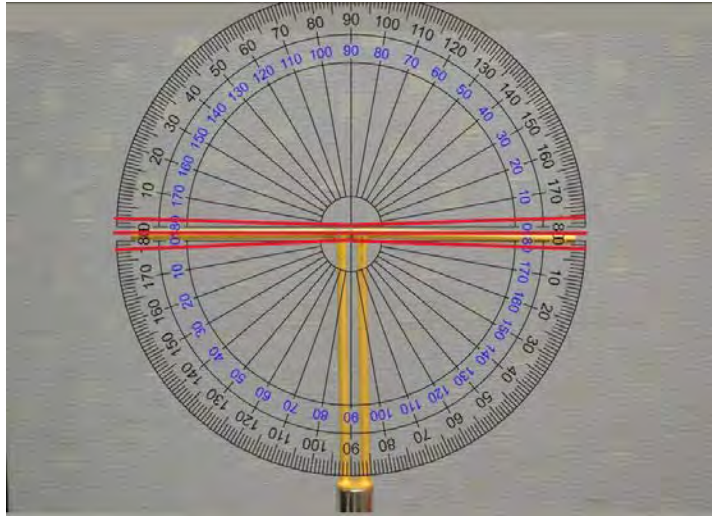

- The center red line indicates that the arms of the dipole fall within  $\pm 2^\circ$



Accredited by the Swiss Accreditation Service (SAS)  
The Swiss Accreditation Service is one of the signatories to the EA  
Multilateral Agreement for the recognition of calibration certificates

Accreditation No.: **SCS 0108**

Client **UL**  
**Fremont, USA**

Certificate No. **D835V2-4d117\_May23**

## CALIBRATION CERTIFICATE

Object **D835V2 - SN:4d117**

Calibration procedure(s) **QA CAL-05.v12  
Calibration Procedure for SAR Validation Sources between 0.7-3 GHz**

Calibration date: **May 11, 2023**

This calibration certificate documents the traceability to national standards, which realize the physical units of measurements (SI).  
The measurements and the uncertainties with confidence probability are given on the following pages and are part of the certificate.

All calibrations have been conducted in the closed laboratory facility: environment temperature (22 ± 3)°C and humidity < 70%.

Calibration Equipment used (M&TE critical for calibration)

Primary Standards	ID #	Cal Date (Certificate No.)	Scheduled Calibration
Power meter NRP2	SN: 104778	30-Mar-23 (No. 217-03804/03805)	Mar-24
Power sensor NRP-Z91	SN: 103244	30-Mar-23 (No. 217-03804)	Mar-24
Power sensor NRP-Z91	SN: 103245	30-Mar-23 (No. 217-03805)	Mar-24
Reference 20 dB Attenuator	SN: BH9394 (20k)	30-Mar-23 (No. 217-03809)	Mar-24
Type-N mismatch combination	SN: 310982 / 06327	30-Mar-23 (No. 217-03810)	Mar-24
Reference Probe EX3DV4	SN: 7349	10-Jan-23 (No. EX3-7349_Jan23)	Jan-24
DAE4	SN: 601	19-Dec-22 (No. DAE4-601_Dec22)	Dec-23

Secondary Standards	ID #	Check Date (in house)	Scheduled Check
Power meter E4419B	SN: GB39512475	30-Oct-14 (in house check Oct-22)	In house check: Oct-24
Power sensor HP 8481A	SN: US37292783	07-Oct-15 (in house check Oct-22)	In house check: Oct-24
Power sensor HP 8481A	SN: MY41093315	07-Oct-15 (in house check Oct-22)	In house check: Oct-24
RF generator R&S SMT-06	SN: 100972	15-Jun-15 (in house check Oct-22)	In house check: Oct-24
Network Analyzer Agilent E8358A	SN: US41080477	31-Mar-14 (in house check Oct-22)	In house check: Oct-24

	<b>Name</b>	<b>Function</b>	<b>Signature</b>
Calibrated by:	<b>Paulo Pina</b>	<b>Laboratory Technician</b>	

	<b>Name</b>	<b>Function</b>	
Approved by:	<b>Sven Kühn</b>	<b>Technical Manager</b>	

Issued: May 15, 2023

This calibration certificate shall not be reproduced except in full without written approval of the laboratory.



Accredited by the Swiss Accreditation Service (SAS)

The Swiss Accreditation Service is one of the signatories to the EA  
Multilateral Agreement for the recognition of calibration certificates

### Glossary:

TSL	tissue simulating liquid
ConvF	sensitivity in TSL / NORM x,y,z
N/A	not applicable or not measured

### Calibration is Performed According to the Following Standards:

- IEC/IEEE 62209-1528, "Measurement Procedure For The Assessment Of Specific Absorption Rate Of Human Exposure To Radio Frequency Fields From Hand-Held And Body-Worn Wireless Communication Devices - Part 1528: Human Models, Instrumentation And Procedures (Frequency Range of 4 MHz to 10 GHz)", October 2020.
- KDB 865664, "SAR Measurement Requirements for 100 MHz to 6 GHz"

### Additional Documentation:

- DASY System Handbook

### Methods Applied and Interpretation of Parameters:

- Measurement Conditions:* Further details are available from the Validation Report at the end of the certificate. All figures stated in the certificate are valid at the frequency indicated.
- Antenna Parameters with TSL:* The source is mounted in a touch configuration below the center marking of the flat phantom.
- Return Loss:* This parameter is measured with the source positioned under the liquid filled phantom (as described in the measurement condition clause). The Return Loss ensures low reflected power. No uncertainty required.
- SAR measured:* SAR measured at the stated antenna input power.
- SAR normalized:* SAR as measured, normalized to an input power of 1 W at the antenna connector.
- SAR for nominal TSL parameters:* The measured TSL parameters are used to calculate the nominal SAR result.

The reported uncertainty of measurement is stated as the standard uncertainty of measurement multiplied by the coverage factor  $k=2$ , which for a normal distribution corresponds to a coverage probability of approximately 95%.

## Measurement Conditions

DASY system configuration, as far as not given on page 1.

<b>DASY Version</b>	DASY52	V52.10.4
<b>Extrapolation</b>	Advanced Extrapolation	
<b>Phantom</b>	Modular Flat Phantom	
<b>Distance Dipole Center - TSL</b>	15 mm	with Spacer
<b>Zoom Scan Resolution</b>	dx, dy, dz = 5 mm	
<b>Frequency</b>	835 MHz $\pm$ 1 MHz	

## Head TSL parameters

The following parameters and calculations were applied.

	Temperature	Permittivity	Conductivity
<b>Nominal Head TSL parameters</b>	22.0 °C	41.5	0.90 mho/m
<b>Measured Head TSL parameters</b>	(22.0 $\pm$ 0.2) °C	41.2 $\pm$ 6 %	0.94 mho/m $\pm$ 6 %
<b>Head TSL temperature change during test</b>	< 0.5 °C	---	---

## SAR result with Head TSL

<b>SAR averaged over 1 cm<sup>3</sup> (1 g) of Head TSL</b>	Condition	
SAR measured	250 mW input power	2.50 W/kg
SAR for nominal Head TSL parameters	normalized to 1W	<b>9.66 W/kg <math>\pm</math> 17.0 % (k=2)</b>

<b>SAR averaged over 10 cm<sup>3</sup> (10 g) of Head TSL</b>	condition	
SAR measured	250 mW input power	1.61 W/kg
SAR for nominal Head TSL parameters	normalized to 1W	<b>6.27 W/kg <math>\pm</math> 16.5 % (k=2)</b>

## Appendix (Additional assessments outside the scope of SCS 0108)

### Antenna Parameters with Head TSL

Impedance, transformed to feed point	50.1 $\Omega$ - 5.3 j $\Omega$
Return Loss	- 25.6 dB

### General Antenna Parameters and Design

Electrical Delay (one direction)	1.394 ns
----------------------------------	----------

After long term use with 100W radiated power, only a slight warming of the dipole near the feedpoint can be measured.

The dipole is made of standard semirigid coaxial cable. The center conductor of the feeding line is directly connected to the second arm of the dipole. The antenna is therefore short-circuited for DC-signals. On some of the dipoles, small end caps are added to the dipole arms in order to improve matching when loaded according to the position as explained in the "Measurement Conditions" paragraph. The SAR data are not affected by this change. The overall dipole length is still according to the Standard.

No excessive force must be applied to the dipole arms, because they might bend or the soldered connections near the feedpoint may be damaged.

### Additional EUT Data

Manufactured by	SPEAG
-----------------	-------



# DASY5 Validation Report for Head TSL

Date: 11.05.2023

Test Laboratory: SPEAG, Zurich, Switzerland

**DUT: Dipole 835 MHz; Type: D835V2; Serial: D835V2 - SN:4d117**

Communication System: UID 0 - CW; Frequency: 835 MHz

Medium parameters used:  $f = 835 \text{ MHz}$ ;  $\sigma = 0.94 \text{ S/m}$ ;  $\epsilon_r = 41.2$ ;  $\rho = 1000 \text{ kg/m}^3$

Phantom section: Flat Section

Measurement Standard: DASY5 (IEEE/IEC/ANSI C63.19-2011)

DASY52 Configuration:

- Probe: EX3DV4 - SN7349; ConvF(9.69, 9.69, 9.69) @ 835 MHz; Calibrated: 10.01.2023
- Sensor-Surface: 1.4mm (Mechanical Surface Detection)
- Electronics: DAE4 Sn601; Calibrated: 19.12.2022
- Phantom: Flat Phantom 4.9 (front); Type: QD 00L P49 AA; Serial: 1001
- DASY52 52.10.4(1535); SEMCAD X 14.6.14(7501)

## Dipole Calibration for Head Tissue/Pin=250 mW, d=15mm/Zoom Scan (7x7x7)/Cube 0:

Measurement grid:  $dx=5\text{mm}$ ,  $dy=5\text{mm}$ ,  $dz=5\text{mm}$

Reference Value = 63.32 V/m; Power Drift = -0.01 dB

Peak SAR (extrapolated) = 3.79 W/kg

**SAR(1 g) = 2.5 W/kg; SAR(10 g) = 1.61 W/kg**

Smallest distance from peaks to all points 3 dB below = 16 mm

Ratio of SAR at M2 to SAR at M1 = 65.8%

Maximum value of SAR (measured) = 3.32 W/kg



0 dB = 3.32 W/kg = 5.21 dBW/kg

# Impedance Measurement Plot for Head TSL

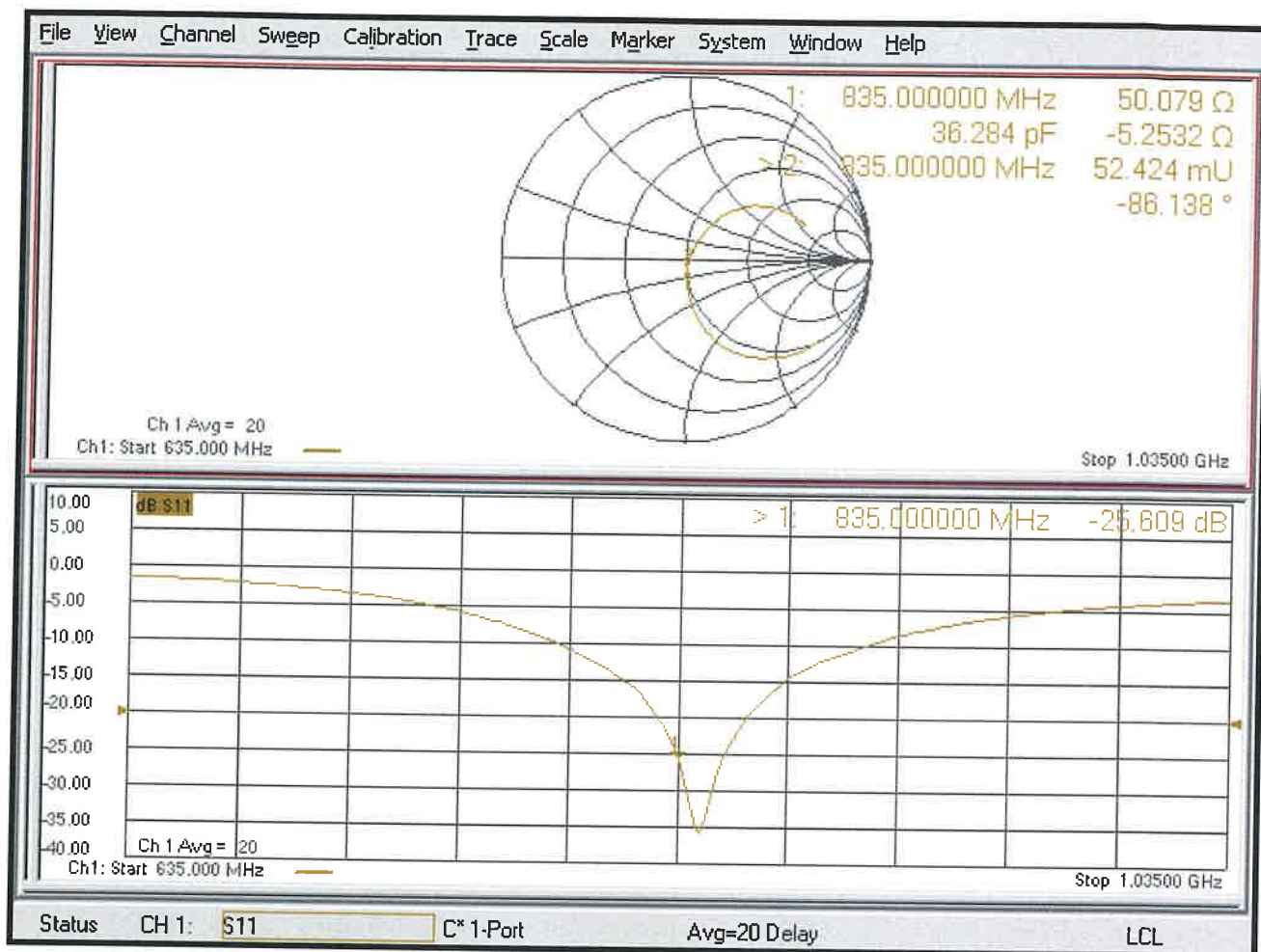



## Dipole Impedance Measurement

Equipment Location	Equipment Name	Model Name	Date of Verification
UL Verification Services Inc. 47173 Benicia Street Fremont, CA 94538, U.S.A.	Dipole Antenna	D835V2-4d117	April 10, 2024

Number:	Check List:	Result:
1	Return/Loss and Impedance	Pass
2	Dipole Arms	Pass

Equipment List:	
Equipment Name:	Calibration Date:
R&S ZNLE6 Vector Network Analyzer	02/28/2025
ZV-Z135 Calibration Kit	03/31/2024

## Dipole Impedance Measurement

### 1) Impedance and Return/Loss

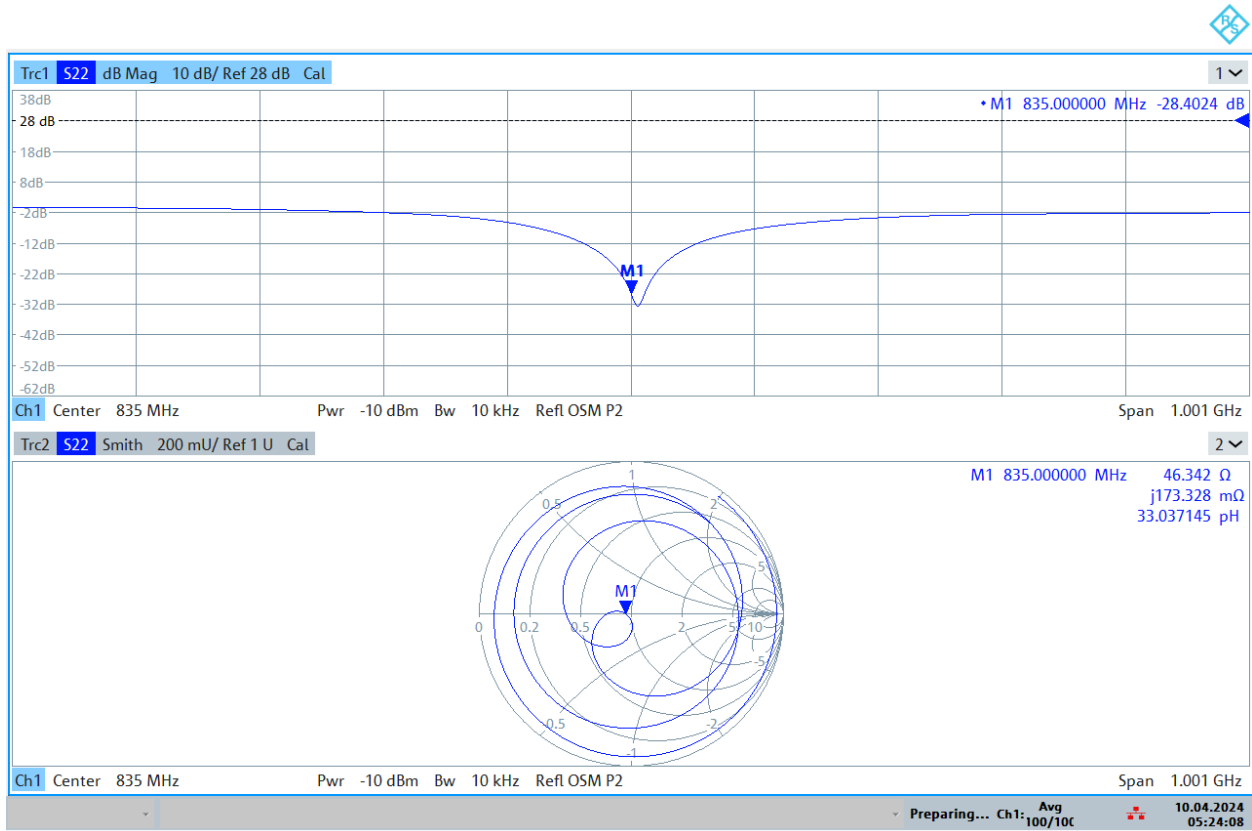

05:24:09 10.04.2024

- Return/Loss is greater than the -20 dB cutoff and Impedance is within 5  $\Omega$  of previous value.

## Dipole Impedance Measurement

### 2) Dipole Arms

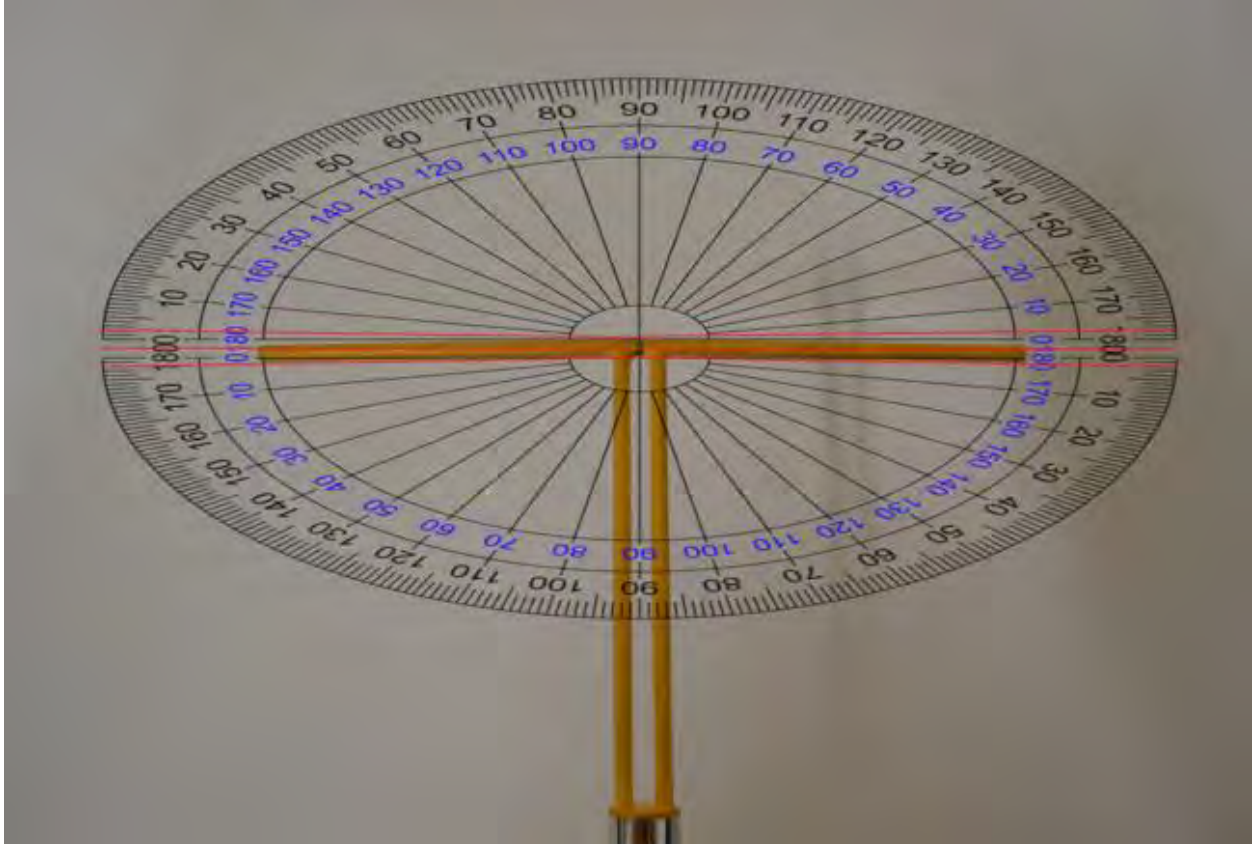

- The center red line indicates that the arms of the dipole fall within  $\pm 2^\circ$



## Dipole Impedance Measurement

Equipment Location	Equipment Name	Model Name	Date of Verification
UL Verification Services Inc. 47173 Benicia Street Fremont, CA 94538, U.S.A.	Dipole Antenna	D835V2-4d117	May 7th, 2025

Number:	Check List:	Result:
1	Visual Inspection	Pass
2	Return/Loss and Impedance	Pass
3	Dipole Arms	Pass

Equipment List:	
Equipment Name:	Calibration Date:
R&S Vector Network Analyzer	2/1/20259
ZV-Z135 Calibration Kit	5/13/2024

## Dipole Impedance Measurement

### 1) Photo of Dipole



- The connector of dipole contains no abnormalities.

## 2) Impedance and Return/Loss

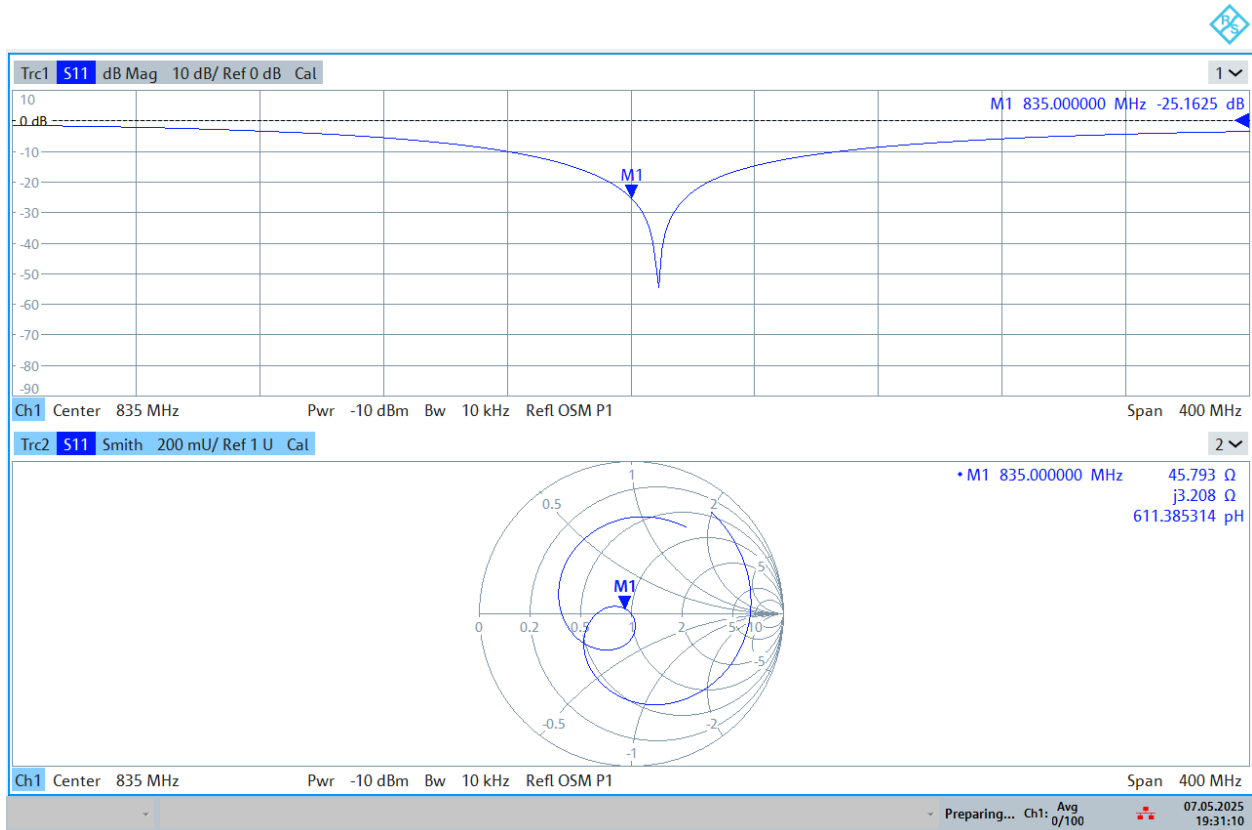

19:31:11 07.05.2025

- Return/Loss is greater than the -20 dB cutoff and Impedance is within 5 Ω of previous value.



## Dipole Impedance Measurement

### 3) Dipole Arms

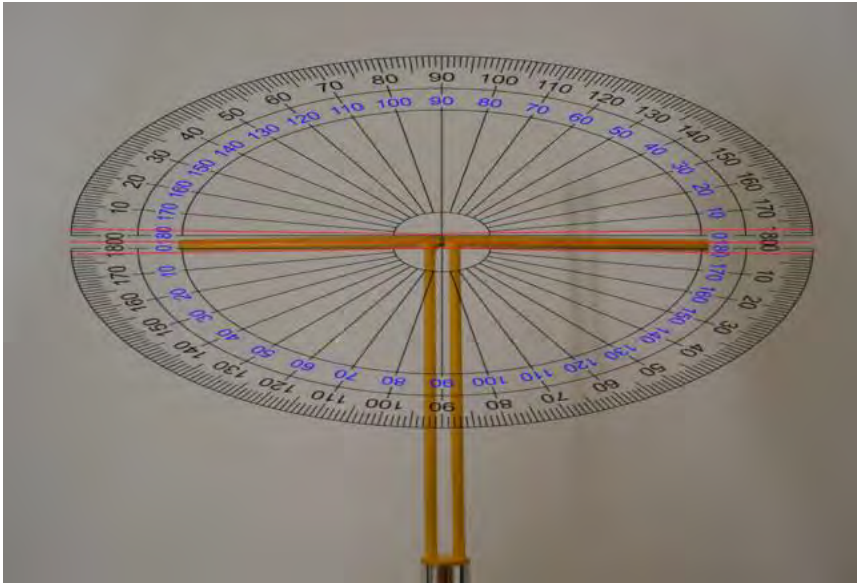

- The center red line indicates that the arms of the dipole fall within  $\pm 2^\circ$



Accredited by the Swiss Accreditation Service (SAS)  
The Swiss Accreditation Service is one of the signatories to the EA  
Multilateral Agreement for the recognition of calibration certificates

Client **UL**  
**Fremont, USA**

Certificate No. **D1640V2-324\_Jun23**

## CALIBRATION CERTIFICATE

Object **D1640V2 - SN:324**

Calibration procedure(s) **QA CAL-05.v12  
Calibration Procedure for SAR Validation Sources between 0.7-3 GHz**

Calibration date: **June 13, 2023**

This calibration certificate documents the traceability to national standards, which realize the physical units of measurements (SI).  
The measurements and the uncertainties with confidence probability are given on the following pages and are part of the certificate.

All calibrations have been conducted in the closed laboratory facility: environment temperature (22 ± 3)°C and humidity < 70%.

Calibration Equipment used (M&TE critical for calibration)

Primary Standards	ID #	Cal Date (Certificate No.)	Scheduled Calibration
Power meter NRP2	SN: 104778	30-Mar-23 (No. 217-03804/03805)	Mar-24
Power sensor NRP-Z91	SN: 103244	30-Mar-23 (No. 217-03804)	Mar-24
Power sensor NRP-Z91	SN: 103245	30-Mar-23 (No. 217-03805)	Mar-24
Reference 20 dB Attenuator	SN: BH9394 (20k)	30-Mar-23 (No. 217-03809)	Mar-24
Type-N mismatch combination	SN: 310982 / 06327	30-Mar-23 (No. 217-03810)	Mar-24
Reference Probe EX3DV4	SN: 7349	10-Jan-23 (No. EX3-7349_Jan23)	Jan-24
DAE4	SN: 601	19-Dec-22 (No. DAE4-601_Dec22)	Dec-23

Secondary Standards	ID #	Check Date (in house)	Scheduled Check
Power meter E4419B	SN: GB39512475	30-Oct-14 (in house check Oct-22)	In house check: Oct-24
Power sensor HP 8481A	SN: US37292783	07-Oct-15 (in house check Oct-22)	In house check: Oct-24
Power sensor HP 8481A	SN: MY41093315	07-Oct-15 (in house check Oct-22)	In house check: Oct-24
RF generator R&S SMT-06	SN: 100972	15-Jun-15 (in house check Oct-22)	In house check: Oct-24
Network Analyzer Agilent E8358A	SN: US41080477	31-Mar-14 (in house check Oct-22)	In house check: Oct-24

Calibrated by: **Paulo Pina**      **Laboratory Technician**

Signature

Approved by: **Sven Kühn**      **Technical Manager**

Issued: June 22, 2023

This calibration certificate shall not be reproduced except in full without written approval of the laboratory.



Accredited by the Swiss Accreditation Service (SAS)  
The Swiss Accreditation Service is one of the signatories to the EA  
Multilateral Agreement for the recognition of calibration certificates

### Glossary:

TSL	tissue simulating liquid
ConvF	sensitivity in TSL / NORM x,y,z
N/A	not applicable or not measured

### Calibration is Performed According to the Following Standards:

- IEC/IEEE 62209-1528, "Measurement Procedure For The Assessment Of Specific Absorption Rate Of Human Exposure To Radio Frequency Fields From Hand-Held And Body-Worn Wireless Communication Devices - Part 1528: Human Models, Instrumentation And Procedures (Frequency Range of 4 MHz to 10 GHz)", October 2020.
- KDB 865664, "SAR Measurement Requirements for 100 MHz to 6 GHz"

### Additional Documentation:

- DASY System Handbook

### Methods Applied and Interpretation of Parameters:

- Measurement Conditions:* Further details are available from the Validation Report at the end of the certificate. All figures stated in the certificate are valid at the frequency indicated.
- Antenna Parameters with TSL:* The source is mounted in a touch configuration below the center marking of the flat phantom.
- Return Loss:* This parameter is measured with the source positioned under the liquid filled phantom (as described in the measurement condition clause). The Return Loss ensures low reflected power. No uncertainty required.
- SAR measured:* SAR measured at the stated antenna input power.
- SAR normalized:* SAR as measured, normalized to an input power of 1 W at the antenna connector.
- SAR for nominal TSL parameters:* The measured TSL parameters are used to calculate the nominal SAR result.

The reported uncertainty of measurement is stated as the standard uncertainty of measurement multiplied by the coverage factor  $k=2$ , which for a normal distribution corresponds to a coverage probability of approximately 95%.

## Measurement Conditions

DASY system configuration, as far as not given on page 1.

DASY Version	DASY52	V52.10.4
Extrapolation	Advanced Extrapolation	
Phantom	Modular Flat Phantom	
Distance Dipole Center - TSL	10 mm	with Spacer
Zoom Scan Resolution	dx, dy, dz = 5 mm	
Frequency	1640 MHz ± 1 MHz	

## Head TSL parameters

The following parameters and calculations were applied.

	Temperature	Permittivity	Conductivity
Nominal Head TSL parameters	22.0 °C	40.2	1.31 mho/m
Measured Head TSL parameters	(22.0 ± 0.2) °C	40.5 ± 6 %	1.27 mho/m ± 6 %
Head TSL temperature change during test	< 0.5 °C	----	----

## SAR result with Head TSL

SAR averaged over 1 cm <sup>3</sup> (1 g) of Head TSL	Condition	
SAR measured	250 mW input power	8.29 W/kg
SAR for nominal Head TSL parameters	normalized to 1W	<b>33.9 W/kg ± 17.0 % (k=2)</b>

SAR averaged over 10 cm <sup>3</sup> (10 g) of Head TSL	condition	
SAR measured	250 mW input power	4.50 W/kg
SAR for nominal Head TSL parameters	normalized to 1W	<b>18.3 W/kg ± 16.5 % (k=2)</b>

## Appendix (Additional assessments outside the scope of SCS 0108)

### Antenna Parameters with Head TSL

Impedance, transformed to feed point	52.4 $\Omega$ + 3.9 j $\Omega$
Return Loss	- 27.0 dB

### General Antenna Parameters and Design

Electrical Delay (one direction)	1.234 ns
----------------------------------	----------

After long term use with 100W radiated power, only a slight warming of the dipole near the feedpoint can be measured.

The dipole is made of standard semirigid coaxial cable. The center conductor of the feeding line is directly connected to the second arm of the dipole. The antenna is therefore short-circuited for DC-signals. On some of the dipoles, small end caps are added to the dipole arms in order to improve matching when loaded according to the position as explained in the "Measurement Conditions" paragraph. The SAR data are not affected by this change. The overall dipole length is still according to the Standard.

No excessive force must be applied to the dipole arms, because they might bend or the soldered connections near the feedpoint may be damaged.

### Additional EUT Data

Manufactured by	SPEAG
-----------------	-------

# DASY5 Validation Report for Head TSL

Date: 13.06.2023

Test Laboratory: SPEAG, Zurich, Switzerland

**DUT: Dipole 1640 MHz; Type: D1640V2; Serial: D1640V2 - SN:324**

Communication System: UID 0 - CW; Frequency: 1640 MHz

Medium parameters used:  $f = 1640 \text{ MHz}$ ;  $\sigma = 1.27 \text{ S/m}$ ;  $\epsilon_r = 40.5$ ;  $\rho = 1000 \text{ kg/m}^3$

Phantom section: Flat Section

Measurement Standard: DASY5 (IEEE/IEC/ANSI C63.19-2011)

DASY52 Configuration:

- Probe: EX3DV4 - SN7349; ConvF(8.68, 8.68, 8.68) @ 1640 MHz; Calibrated: 10.01.2023
- Sensor-Surface: 1.4mm (Mechanical Surface Detection)
- Electronics: DAE4 Sn601; Calibrated: 19.12.2022
- Phantom: Flat Phantom 5.0 (front); Type: QD 000 P50 AA; Serial: 1001
- DASY52 52.10.4(1535); SEMCAD X 14.6.14(7501)

## Dipole Calibration for Head Tissue/Pin=250 mW, d=10mm/Zoom Scan (7x7x7)/Cube 0:

Measurement grid:  $dx=5\text{mm}$ ,  $dy=5\text{mm}$ ,  $dz=5\text{mm}$

Reference Value = 105.8 V/m; Power Drift = -0.05 dB

Peak SAR (extrapolated) = 14.9 W/kg

**SAR(1 g) = 8.29 W/kg; SAR(10 g) = 4.5 W/kg**

Smallest distance from peaks to all points 3 dB below = 10.2 mm

Ratio of SAR at M2 to SAR at M1 = 56.1%

Maximum value of SAR (measured) = 12.6 W/kg

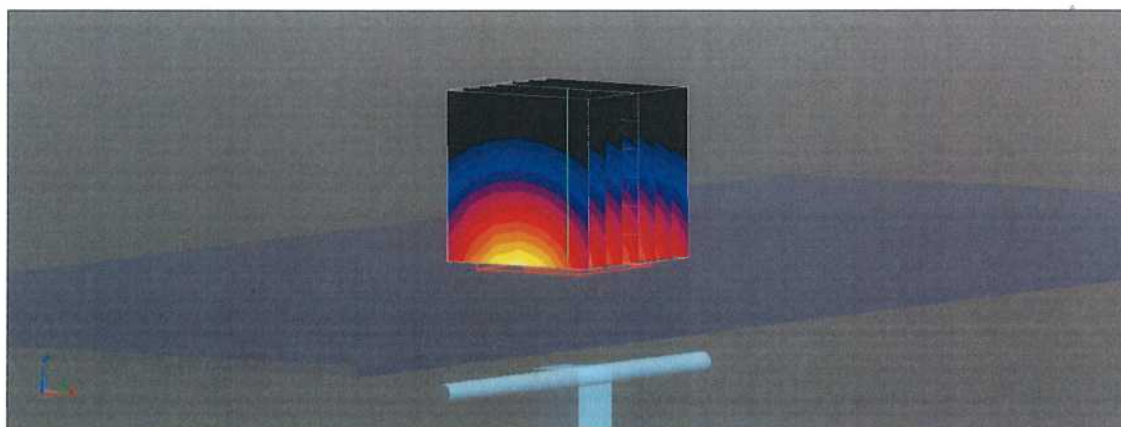
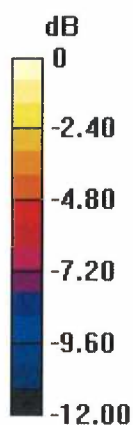

0 dB = 12.6 W/kg = 11.00 dBW/kg

# Impedance Measurement Plot for Head TSL

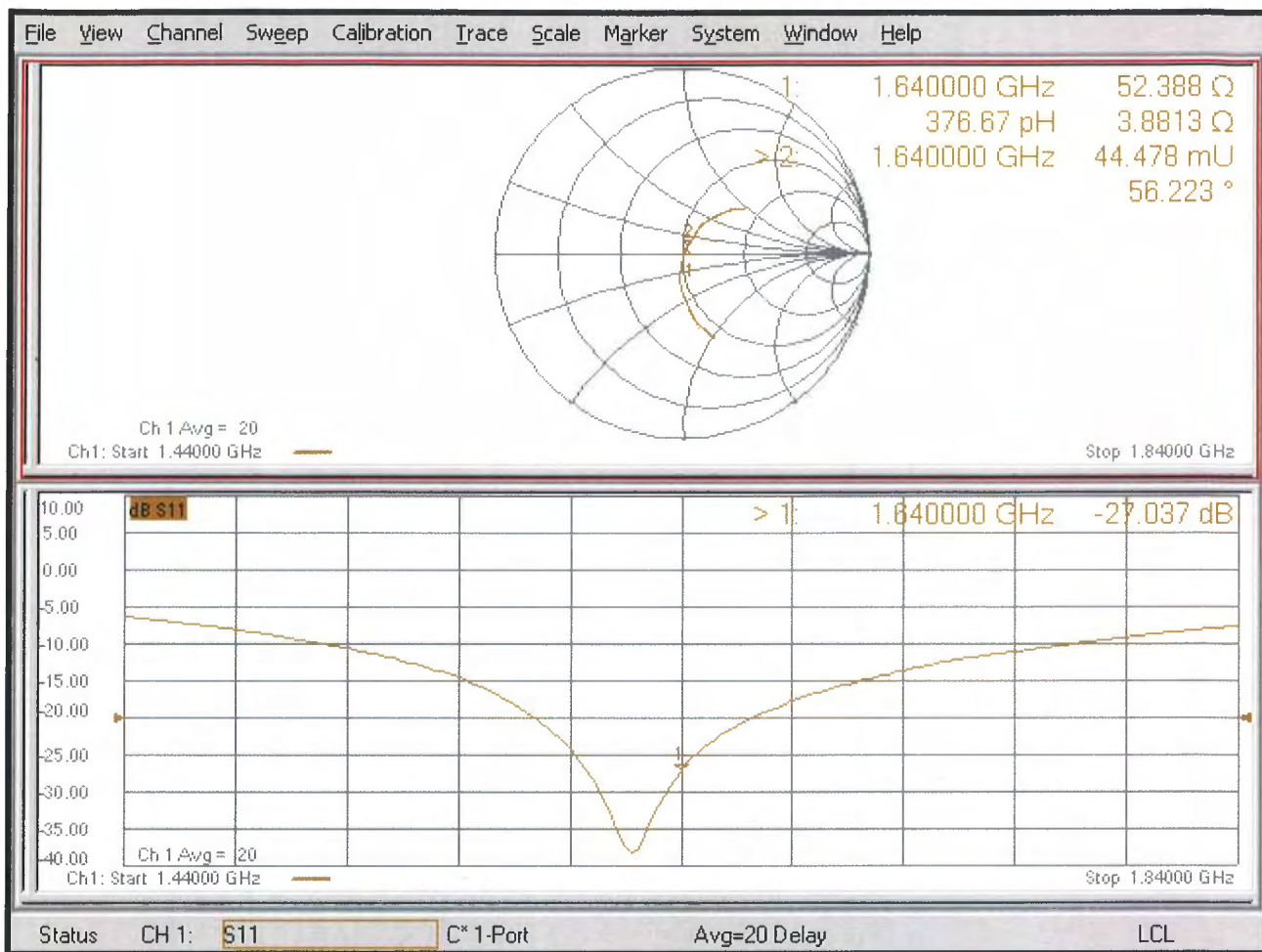



## Dipole Impedance Measurement

Equipment Location	Equipment Name	Model Name	Date of Verification
UL Verification Services Inc. 47173 Benicia Street Fremont, CA 94538, U.S.A.	Dipole Antenna	D1640V2-324	April 10, 2024

Number:	Check List:	Result:
1	Return/Loss and Impedance	Pass
2	Dipole Arms	Pass

Equipment List:	
Equipment Name:	Calibration Date:
R&S ZNLE6 Vector Network Analyzer	02/28/2025
ZV-Z135 Calibration Kit	03/31/2024



# Dipole Impedance Measurement

## 1) Impedance and Return/Loss

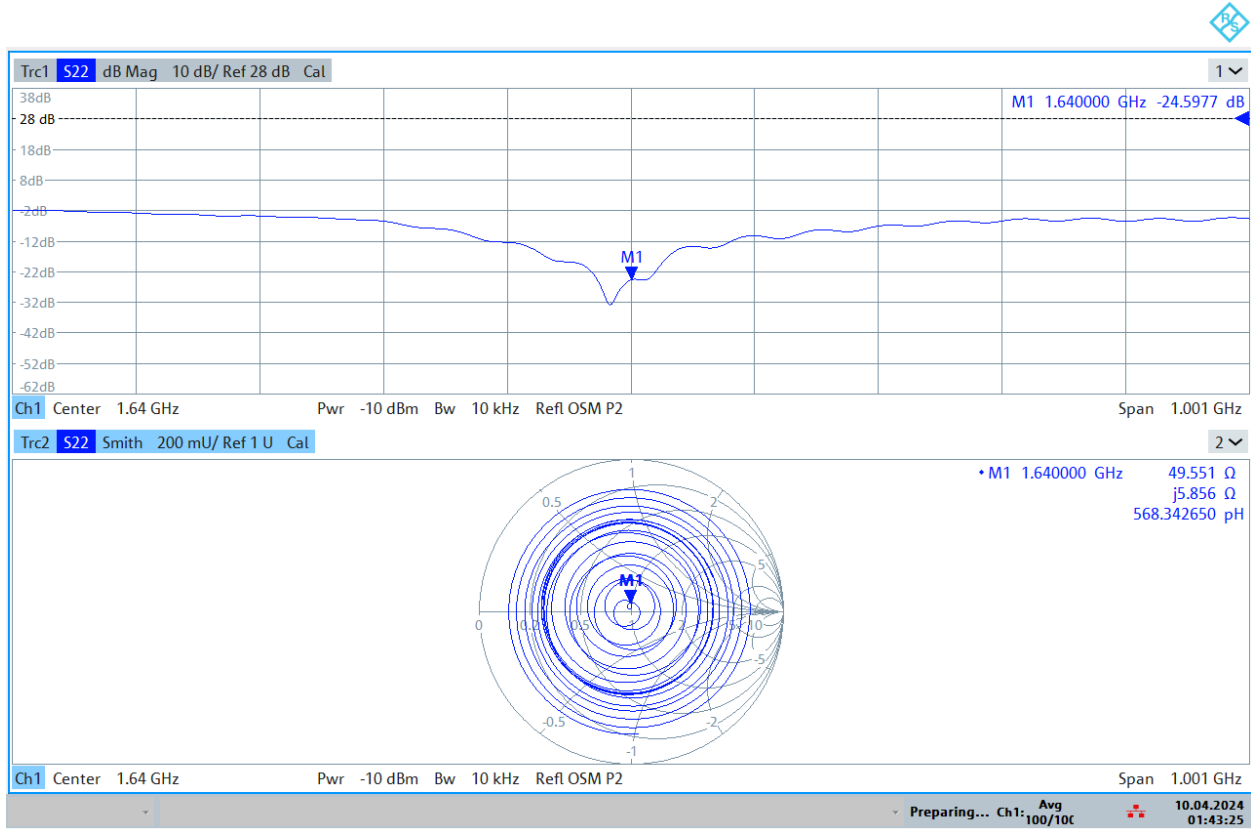

01:43:26 10.04.2024

- Return/Loss is greater than the -20 dB cutoff and Impedance is within 5 Ω of previous value.

## Dipole Impedance Measurement

### 2) Dipole Arms

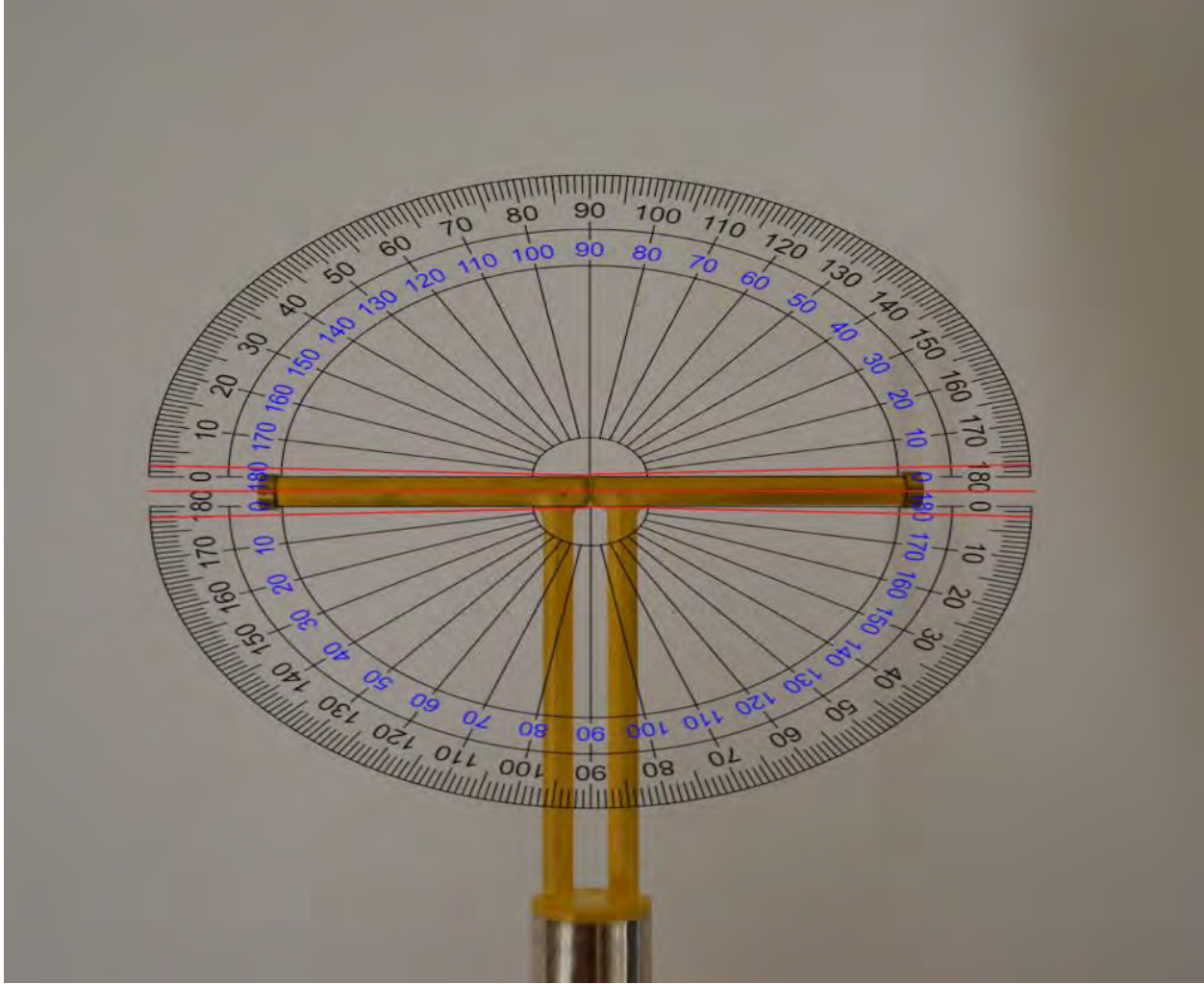

- The center red line indicates that the arms of the dipole fall within  $\pm 2^\circ$



## Dipole Impedance Measurement

Equipment Location	Equipment Name	Model Name	Date of Verification
UL Verification Services Inc. 47173 Benicia Street Fremont, CA 94538, U.S.A.	Dipole Antenna	D1640V2-324	May 13, 2025

Number:	Check List:	Result:
1	Visual Inspection	Pass
2	Return/Loss and Impedance	Pass
3	Dipole Arms	Pass

Equipment List:	
Equipment Name:	Calibration Date:
R&S Vector Network Analyzer	2/12/2025
ZV-Z135 Calibration Kit	5/17/2024

## Dipole Impedance Measurement

### 1) Photo of Dipole



- The connector of dipole contains no abnormalities.

## Dipole Impedance Measurement

### 2) Impedance and Return/Loss

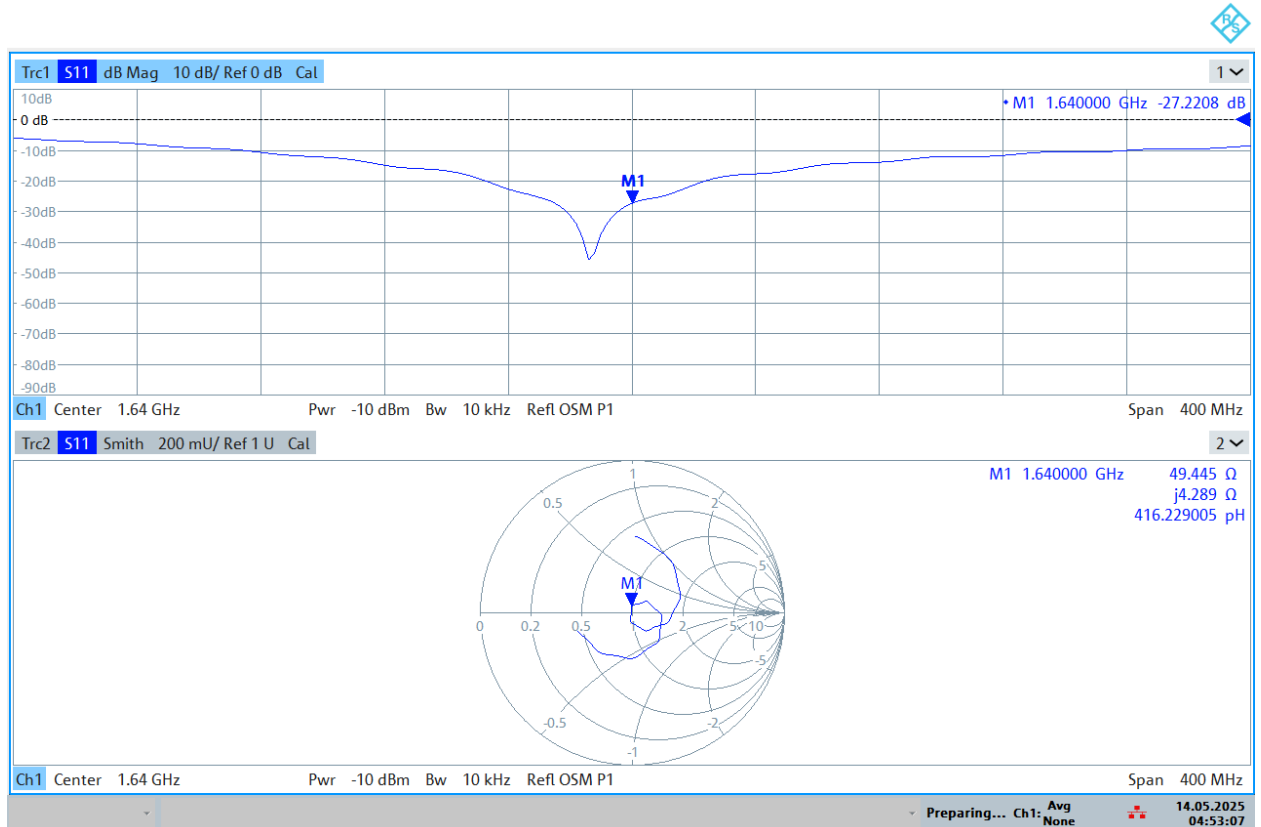

04:53:07 14.05.2025

- Return/Loss is greater than the -20 dB cutoff and Impedance is within 5 Ω of previous value.

## Dipole Impedance Measurement

### 3) Dipole Arms

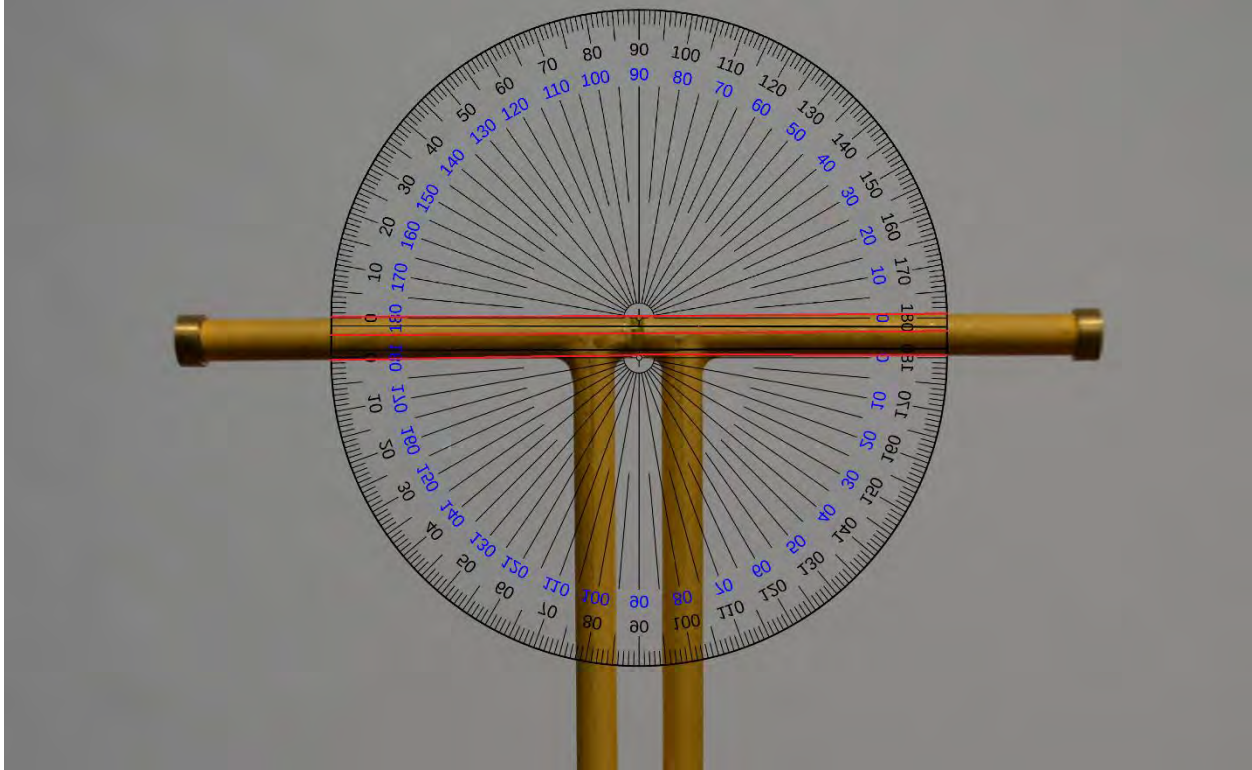

- The center red line indicates that the arms of the dipole fall within  $\pm 2^\circ$



Accredited by the Swiss Accreditation Service (SAS)  
The Swiss Accreditation Service is one of the signatories to the EA  
Multilateral Agreement for the recognition of calibration certificates

Client **UL**  
**Fremont, USA**

Certificate No. **D1750V2-1050\_Apr23**

## CALIBRATION CERTIFICATE

Object **D1750V2 - SN:1050**

Calibration procedure(s) **QA CAL-05.v12  
Calibration Procedure for SAR Validation Sources between 0.7-3 GHz**

Calibration date: **April 19, 2023**

This calibration certificate documents the traceability to national standards, which realize the physical units of measurements (SI).  
The measurements and the uncertainties with confidence probability are given on the following pages and are part of the certificate.

All calibrations have been conducted in the closed laboratory facility: environment temperature ( $22 \pm 3$ )°C and humidity < 70%.

Calibration Equipment used (M&TE critical for calibration)

Primary Standards	ID #	Cal Date (Certificate No.)	Scheduled Calibration
Power meter NRP2	SN: 104778	30-Mar-23 (No. 217-03804/03805)	Mar-24
Power sensor NRP-Z91	SN: 103244	30-Mar-23 (No. 217-03804)	Mar-24
Power sensor NRP-Z91	SN: 103245	30-Mar-23 (No. 217-03805)	Mar-24
Reference 20 dB Attenuator	SN: BH9394 (20k)	30-Mar-23 (No. 217-03809)	Mar-24
Type-N mismatch combination	SN: 310982 / 06327	30-Mar-23 (No. 217-03810)	Mar-24
Reference Probe EX3DV4	SN: 7349	10-Jan-23 (No. EX3-7349_Jan23)	Jan-24
DAE4	SN: 601	19-Dec-22 (No. DAE4-601_Dec22)	Dec-23

Secondary Standards	ID #	Check Date (in house)	Scheduled Check
Power meter E4419B	SN: GB39512475	30-Oct-14 (in house check Oct-22)	In house check: Oct-24
Power sensor HP 8481A	SN: US37292783	07-Oct-15 (in house check Oct-22)	In house check: Oct-24
Power sensor HP 8481A	SN: MY41093315	07-Oct-15 (in house check Oct-22)	In house check: Oct-24
RF generator R&S SMT-06	SN: 100972	15-Jun-15 (in house check Oct-22)	In house check: Oct-24
Network Analyzer Agilent E8358A	SN: US41080477	31-Mar-14 (in house check Oct-22)	In house check: Oct-24

	Name	Function	Signature
Calibrated by:	<b>Michael Weber</b>	<b>Laboratory Technician</b>	
Approved by:	<b>Sven Kühn</b>	<b>Technical Manager</b>	

Issued: April 20, 2023

This calibration certificate shall not be reproduced except in full without written approval of the laboratory.



Accredited by the Swiss Accreditation Service (SAS)  
The Swiss Accreditation Service is one of the signatories to the EA  
Multilateral Agreement for the recognition of calibration certificates

### Glossary:

TSL	tissue simulating liquid
ConvF	sensitivity in TSL / NORM x,y,z
N/A	not applicable or not measured

### Calibration is Performed According to the Following Standards:

- a) IEC/IEEE 62209-1528, "Measurement Procedure For The Assessment Of Specific Absorption Rate Of Human Exposure To Radio Frequency Fields From Hand-Held And Body-Worn Wireless Communication Devices - Part 1528: Human Models, Instrumentation And Procedures (Frequency Range of 4 MHz to 10 GHz)", October 2020.
- b) KDB 865664, "SAR Measurement Requirements for 100 MHz to 6 GHz"

### Additional Documentation:

- c) DASY System Handbook

### Methods Applied and Interpretation of Parameters:

- *Measurement Conditions:* Further details are available from the Validation Report at the end of the certificate. All figures stated in the certificate are valid at the frequency indicated.
- *Antenna Parameters with TSL:* The source is mounted in a touch configuration below the center marking of the flat phantom.
- *Return Loss:* This parameter is measured with the source positioned under the liquid filled phantom (as described in the measurement condition clause). The Return Loss ensures low reflected power. No uncertainty required.
- *SAR measured:* SAR measured at the stated antenna input power.
- *SAR normalized:* SAR as measured, normalized to an input power of 1 W at the antenna connector.
- *SAR for nominal TSL parameters:* The measured TSL parameters are used to calculate the nominal SAR result.

The reported uncertainty of measurement is stated as the standard uncertainty of measurement multiplied by the coverage factor  $k=2$ , which for a normal distribution corresponds to a coverage probability of approximately 95%.



## Measurement Conditions

DASY system configuration, as far as not given on page 1.

<b>DASY Version</b>	DASY52	V52.10.4
<b>Extrapolation</b>	Advanced Extrapolation	
<b>Phantom</b>	Modular Flat Phantom	
<b>Distance Dipole Center - TSL</b>	10 mm	with Spacer
<b>Zoom Scan Resolution</b>	dx, dy, dz = 5 mm	
<b>Frequency</b>	1750 MHz $\pm$ 1 MHz	

## Head TSL parameters

The following parameters and calculations were applied.

	Temperature	Permittivity	Conductivity
<b>Nominal Head TSL parameters</b>	22.0 °C	40.1	1.37 mho/m
<b>Measured Head TSL parameters</b>	(22.0 $\pm$ 0.2) °C	38.9 $\pm$ 6 %	1.35 mho/m $\pm$ 6 %
<b>Head TSL temperature change during test</b>	< 0.5 °C	----	----

## SAR result with Head TSL

<b>SAR averaged over 1 cm<sup>3</sup> (1 g) of Head TSL</b>	Condition	
SAR measured	250 mW input power	9.00 W/kg
SAR for nominal Head TSL parameters	normalized to 1W	<b>36.1 W/kg <math>\pm</math> 17.0 % (k=2)</b>

<b>SAR averaged over 10 cm<sup>3</sup> (10 g) of Head TSL</b>	condition	
SAR measured	250 mW input power	4.72 W/kg
SAR for nominal Head TSL parameters	normalized to 1W	<b>18.9 W/kg <math>\pm</math> 16.5 % (k=2)</b>

## Appendix (Additional assessments outside the scope of SCS 0108)

### Antenna Parameters with Head TSL

Impedance, transformed to feed point	51.8 $\Omega$ - 0.7 j $\Omega$
Return Loss	- 34.4 dB

### General Antenna Parameters and Design

Electrical Delay (one direction)	1.221 ns
----------------------------------	----------

After long term use with 100W radiated power, only a slight warming of the dipole near the feedpoint can be measured.

The dipole is made of standard semirigid coaxial cable. The center conductor of the feeding line is directly connected to the second arm of the dipole. The antenna is therefore short-circuited for DC-signals. On some of the dipoles, small end caps are added to the dipole arms in order to improve matching when loaded according to the position as explained in the "Measurement Conditions" paragraph. The SAR data are not affected by this change. The overall dipole length is still according to the Standard.

No excessive force must be applied to the dipole arms, because they might bend or the soldered connections near the feedpoint may be damaged.

### Additional EUT Data

Manufactured by	SPEAG
-----------------	-------

# DASY5 Validation Report for Head TSL

Date: 19.04.2023

Test Laboratory: SPEAG, Zurich, Switzerland

**DUT: Dipole 1750 MHz; Type: D1750V2; Serial: D1750V2 - SN: 1050**

Communication System: UID 0 - CW; Frequency: 1750 MHz

Medium parameters used:  $f = 1750$  MHz;  $\sigma = 1.35$  S/m;  $\epsilon_r = 38.9$ ;  $\rho = 1000$  kg/m<sup>3</sup>

Phantom section: Flat Section

Measurement Standard: DASY5 (IEEE/IEC/ANSI C63.19-2011)

DASY52 Configuration:

- Probe: EX3DV4 - SN7349; ConvF(8.67, 8.67, 8.67) @ 1750 MHz; Calibrated: 10.01.2023
- Sensor-Surface: 1.4mm (Mechanical Surface Detection)
- Electronics: DAE4 Sn601; Calibrated: 19.12.2022
- Phantom: Flat Phantom 5.0 (front); Type: QD 000 P50 AA; Serial: 1001
- DASY52 52.10.4(1535); SEMCAD X 14.6.14(7501)

## Dipole Calibration for Head Tissue/Pin=250 mW, d=10mm/Zoom Scan (7x7x7)/Cube 0:

Measurement grid: dx=5mm, dy=5mm, dz=5mm

Reference Value = 106.2 V/m; Power Drift = -0.01 dB

Peak SAR (extrapolated) = 16.8 W/kg

**SAR(1 g) = 9 W/kg; SAR(10 g) = 4.72 W/kg**

Smallest distance from peaks to all points 3 dB below = 10 mm

Ratio of SAR at M2 to SAR at M1 = 53.8%

Maximum value of SAR (measured) = 14.0 W/kg

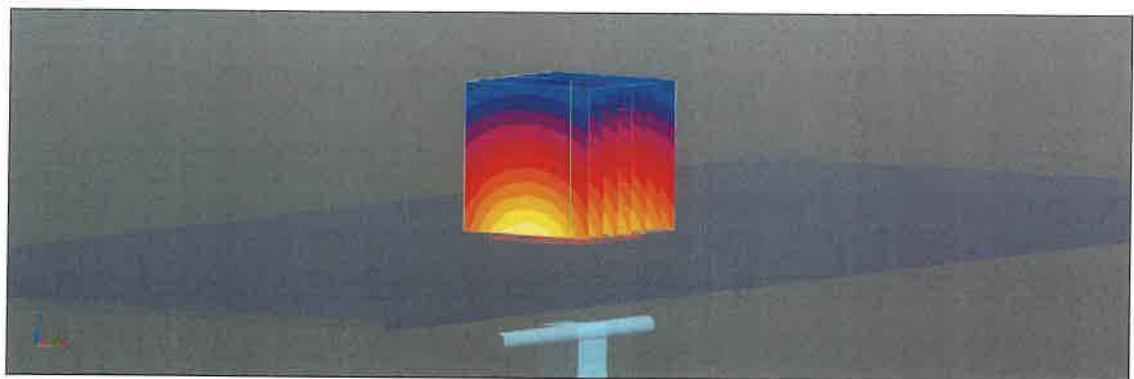
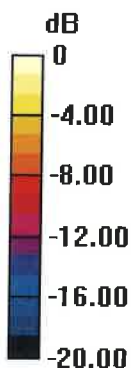

0 dB = 14.0 W/kg = 11.46 dBW/kg

# Impedance Measurement Plot for Head TSL

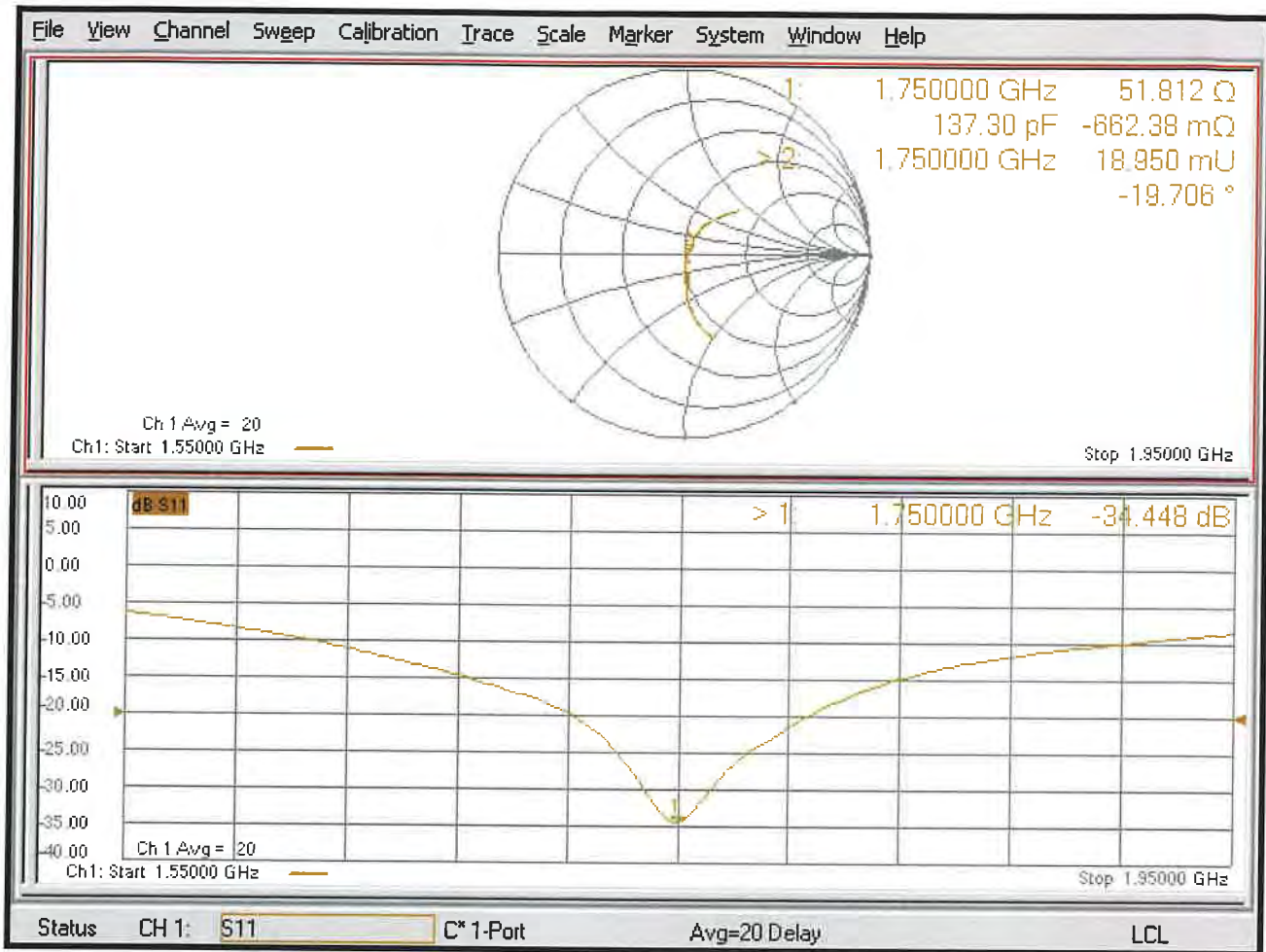



## Dipole Impedance Measurement

Equipment Location	Equipment Name	Model Name	Date of Verification
UL Verification Services Inc. 47173 Benicia Street Fremont, CA 94538, U.S.A.	Dipole Antenna	D1750V2-1050	April 9, 2024

Number:	Check List:	Result:
1	Return/Loss and Impedance	Pass
2	Dipole Arms	Pass

Equipment List:	
Equipment Name:	Calibration Date:
R&S ZNLE6 Vector Network Analyzer	02/28/2025
ZV-Z135 Calibration Kit	03/31/2024

## Dipole Impedance Measurement

### 1) Impedance and Return/Loss

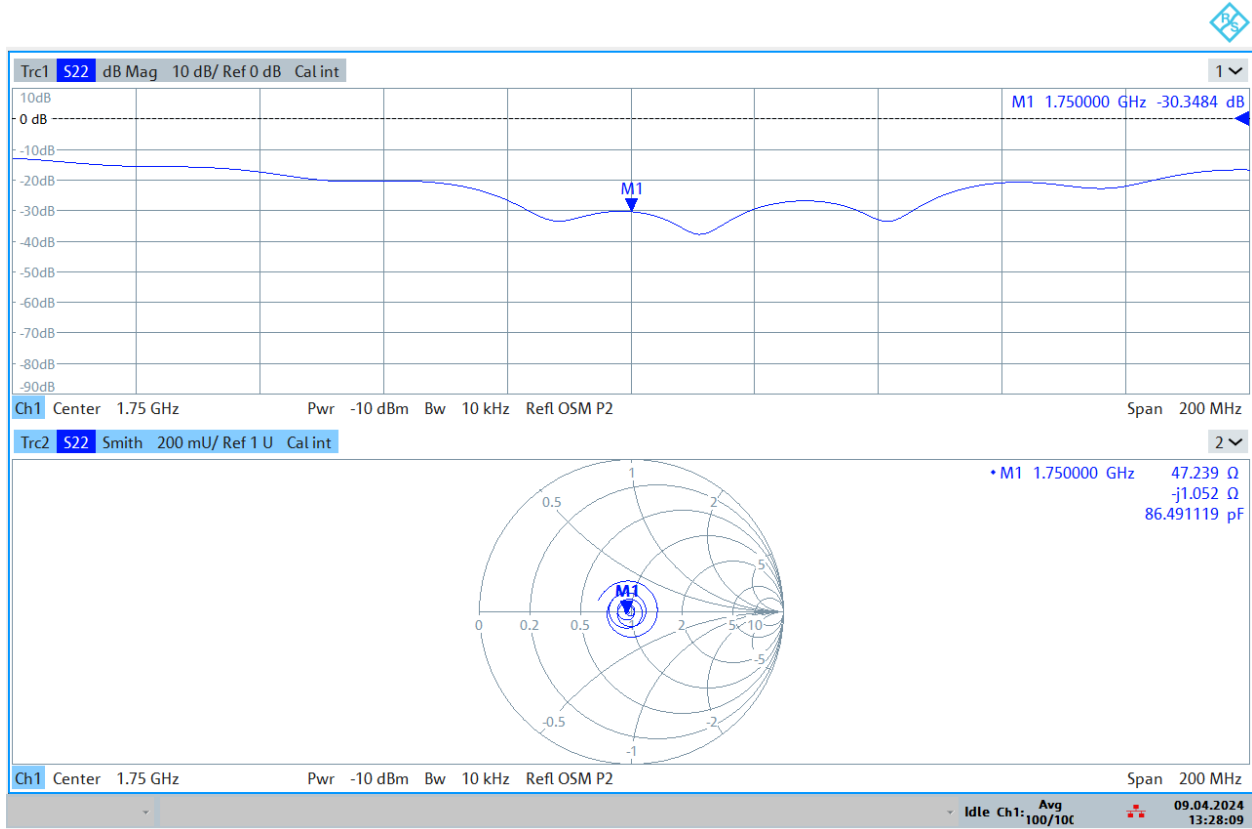

13:28:10 09.04.2024

- Return/Loss is greater than the -20 dB cutoff and Impedance is within 5 Ω of previous value.

## Dipole Impedance Measurement

### 2) Dipole Arms

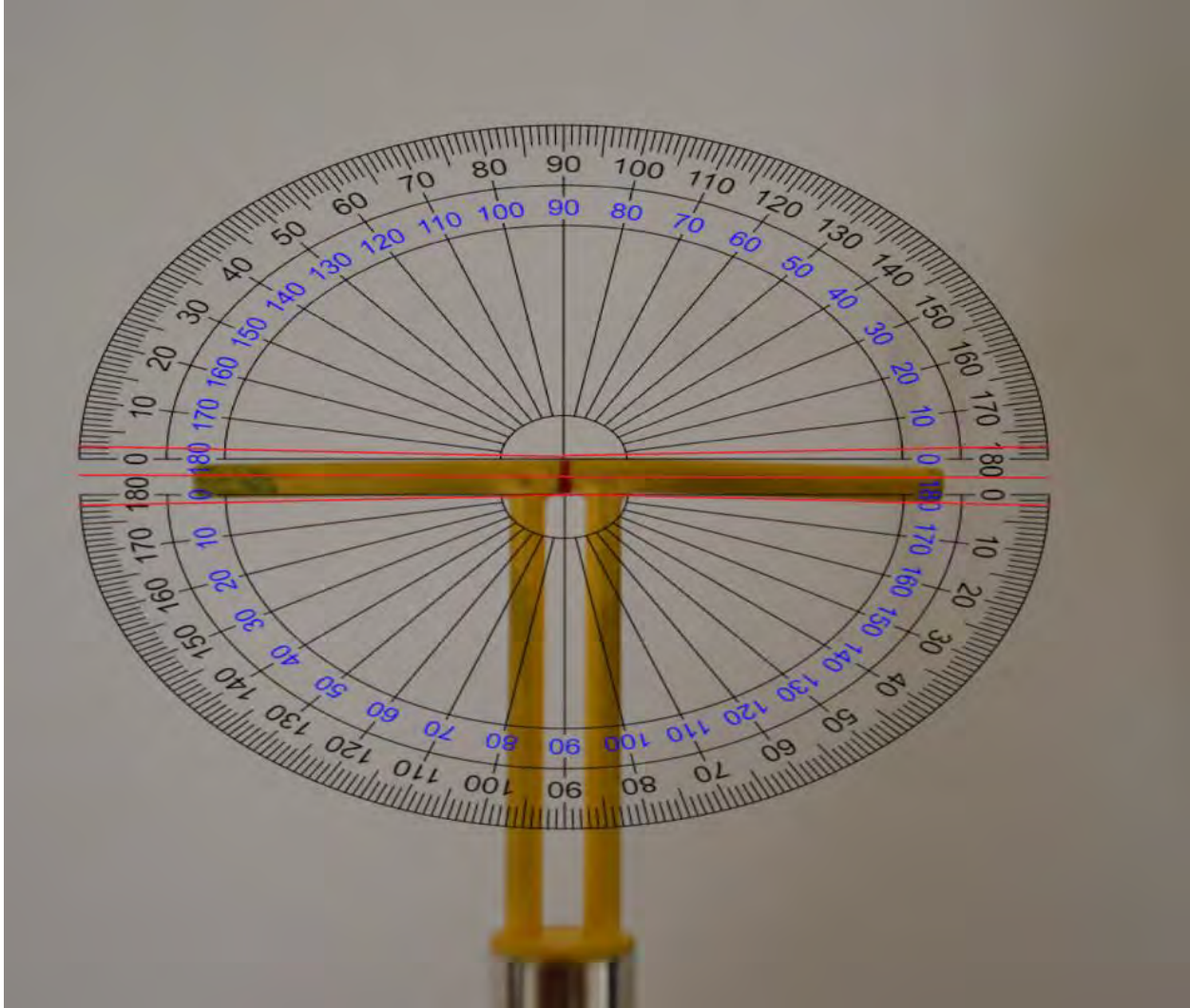

- The center red line indicates that the arms of the dipole fall within  $\pm 2^\circ$



## Dipole Impedance Measurement

Equipment Location	Equipment Name	Model Name	Date of Verification
UL Verification Services Inc. 47173 Benicia Street Fremont, CA 94538, U.S.A.	Dipole Antenna	D1750V2 - 1050	April 2, 2025

Number:	Check List:	Result:
1	Visual Inspection	Pass
2	Return/Loss and Impedance	Pass
3	Dipole Arms	Pass

Equipment List:	
Equipment Name:	Calibration Date:
R&S Vector Network Analyzer	2/20/2025
ZV-Z135 Calibration Kit	2/19/2025



## Dipole Impedance Measurement



- The connector of dipole contains no abnormalities.

# Dipole Impedance Measurement

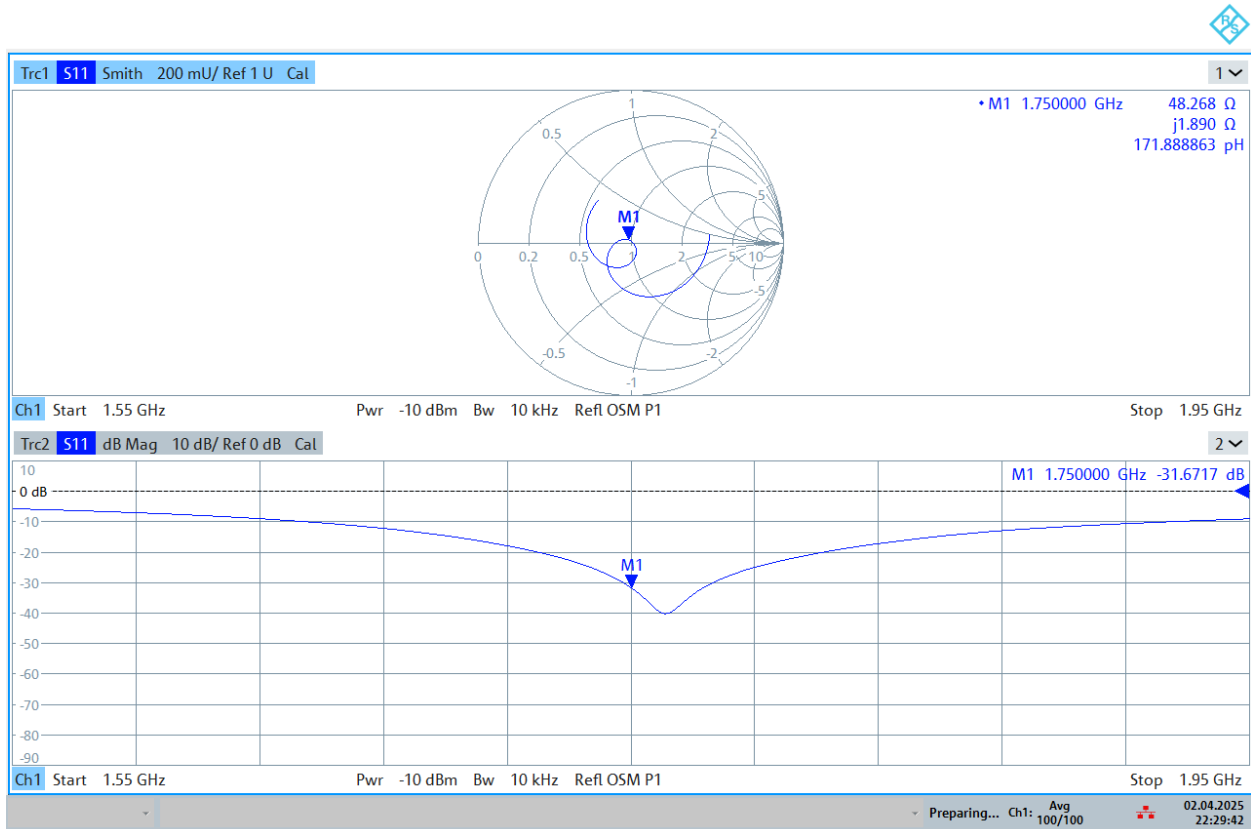

22:29:43 02.04.2025

- Return/Loss is greater than the -20 dB cutoff and Impedance is within 5 Ω of previous value.

## Dipole Impedance Measurement

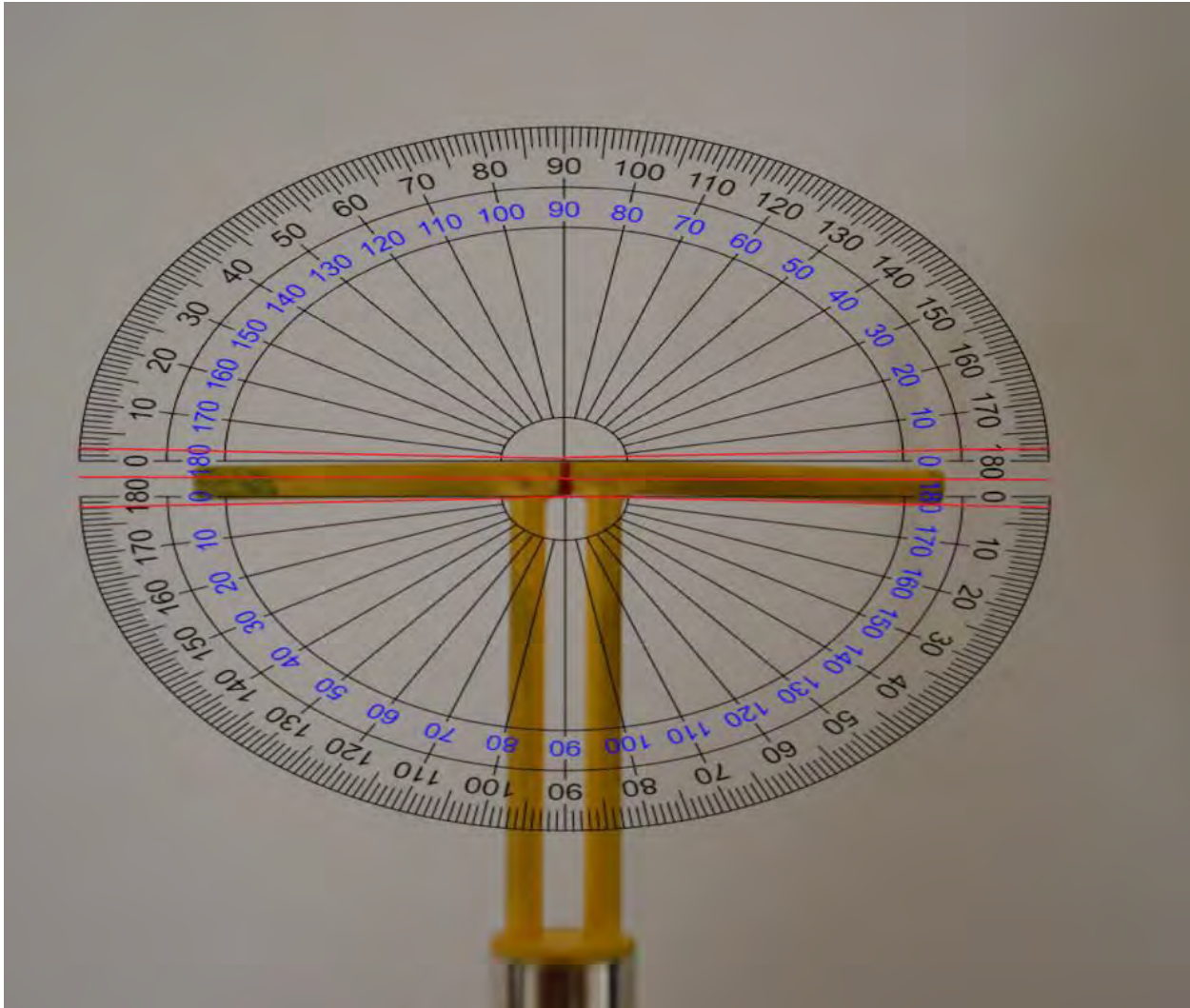

- The center red line indicates that the arms of the dipole fall within  $\pm 2^\circ$



Accredited by the Swiss Accreditation Service (SAS)  
The Swiss Accreditation Service is one of the signatories to the EA  
Multilateral Agreement for the recognition of calibration certificates

Client **UL**  
**Fremont, USA**

Certificate No. **D1750V2-1053\_Oct23**

**CALIBRATION CERTIFICATE**

Object **D1750V2 - SN:1053**

Calibration procedure(s) **QA CAL-05.v12  
Calibration Procedure for SAR Validation Sources between 0.7-3 GHz**

Calibration date: **October 13, 2023**

This calibration certificate documents the traceability to national standards, which realize the physical units of measurements (SI).  
The measurements and the uncertainties with confidence probability are given on the following pages and are part of the certificate.

All calibrations have been conducted in the closed laboratory facility: environment temperature (22 ± 3)°C and humidity < 70%.

Calibration Equipment used (M&TE critical for calibration)

Primary Standards	ID #	Cal Date (Certificate No.)	Scheduled Calibration
Power meter NRP2	SN: 104778	30-Mar-23 (No. 217-03804/03805)	Mar-24
Power sensor NRP-Z91	SN: 103244	30-Mar-23 (No. 217-03804)	Mar-24
Power sensor NRP-Z91	SN: 103245	30-Mar-23 (No. 217-03805)	Mar-24
Reference 20 dB Attenuator	SN: BH9394 (20k)	30-Mar-23 (No. 217-03809)	Mar-24
Type-N mismatch combination	SN: 310982 / 06327	30-Mar-23 (No. 217-03810)	Mar-24
Reference Probe EX3LV4	SN: 7349	10-Jan-23 (No. EX3-7349_Jan23)	Jan-24
DAE4	SN: 601	03-Oct-23 (No. DAE4-601_Oct23)	Oct-24
Secondary Standards	ID #	Check Date (in house)	Scheduled Check
Power meter E4419B	SN: GB39512475	30-Oct-14 (in house check Oct-22)	In house check: Oct-24
Power sensor HP 8481A	SN: US37292783	07-Oct-15 (in house check Oct-22)	In house check: Oct-24
Power sensor HP 8481A	SN: MY41093315	07-Oct-15 (in house check Oct-22)	In house check: Oct-24
RF generator R&S SMT-06	SN: 100972	15-Jun-15 (in house check Oct-22)	In house check: Oct-24
Network Analyzer Agilent E8358A	SN: US41080477	31-Mar-14 (in house check Oct-22)	In house check: Oct-24

Calibrated by: **Paulo Pina** (Name) / **Laboratory Technician** (Function) / *[Signature]* (Signature)

Approved by: **Sven Kühn** (Name) / **Technical Manager** (Function) / *[Signature]* (Signature)

Issued: October 17, 2023

This calibration certificate shall not be reproduced except in full without written approval of the laboratory.



Accredited by the Swiss Accreditation Service (SAS)  
The Swiss Accreditation Service is one of the signatories to the EA  
Multilateral Agreement for the recognition of calibration certificates

### Glossary:

TSL	tissue simulating liquid
ConvF	sensitivity in TSL / NORM x,y,z
N/A	not applicable or not measured

### Calibration is Performed According to the Following Standards:

- a) IEC/IEEE 62209-1528, "Measurement Procedure For The Assessment Of Specific Absorption Rate Of Human Exposure To Radio Frequency Fields From Hand-Held And Body-Worn Wireless Communication Devices - Part 1528: Human Models, Instrumentation And Procedures (Frequency Range of 4 MHz to 10 GHz)", October 2020.
- b) KDB 865664, "SAR Measurement Requirements for 100 MHz to 6 GHz"

### Additional Documentation:

- c) DASY System Handbook

### Methods Applied and Interpretation of Parameters:

- *Measurement Conditions:* Further details are available from the Validation Report at the end of the certificate. All figures stated in the certificate are valid at the frequency indicated.
- *Antenna Parameters with TSL:* The source is mounted in a touch configuration below the center marking of the flat phantom.
- *Return Loss:* This parameter is measured with the source positioned under the liquid filled phantom (as described in the measurement condition clause). The Return Loss ensures low reflected power. No uncertainty required.
- *SAR measured:* SAR measured at the stated antenna input power.
- *SAR normalized:* SAR as measured, normalized to an input power of 1 W at the antenna connector.
- *SAR for nominal TSL parameters:* The measured TSL parameters are used to calculate the nominal SAR result.

The reported uncertainty of measurement is stated as the standard uncertainty of measurement multiplied by the coverage factor  $k=2$ , which for a normal distribution corresponds to a coverage probability of approximately 95%.

## Measurement Conditions

DASY system configuration, as far as not given on page 1.

<b>DASY Version</b>	DASY52	V52.10.4
<b>Extrapolation</b>	Advanced Extrapolation	
<b>Phantom</b>	Modular Flat Phantom	
<b>Distance Dipole Center - TSL</b>	10 mm	with Spacer
<b>Zoom Scan Resolution</b>	dx, dy, dz = 5 mm	
<b>Frequency</b>	1750 MHz $\pm$ 1 MHz	

## Head TSL parameters

The following parameters and calculations were applied.

	Temperature	Permittivity	Conductivity
<b>Nominal Head TSL parameters</b>	22.0 °C	40.1	1.37 mho/m
<b>Measured Head TSL parameters</b>	(22.0 $\pm$ 0.2) °C	40.6 $\pm$ 6 %	1.35 mho/m $\pm$ 6 %
<b>Head TSL temperature change during test</b>	< 0.5 °C	---	---

## SAR result with Head TSL

<b>SAR averaged over 1 cm<sup>3</sup> (1 g) of Head TSL</b>	Condition	
SAR measured	250 mW input power	9.05 W/kg
SAR for nominal Head TSL parameters	normalized to 1W	<b>36.6 W/kg <math>\pm</math> 17.0 % (k=2)</b>

<b>SAR averaged over 10 cm<sup>3</sup> (10 g) of Head TSL</b>	condition	
SAR measured	250 mW input power	4.79 W/kg
SAR for nominal Head TSL parameters	normalized to 1W	<b>19.3 W/kg <math>\pm</math> 16.5 % (k=2)</b>

## Appendix (Additional assessments outside the scope of SCS 0108)

### Antenna Parameters with Head TSL

Impedance, transformed to feed point	49.6 $\Omega$ - 0.4 j $\Omega$
Return Loss	- 45.2 dB

### General Antenna Parameters and Design

Electrical Delay (one direction)	1.220 ns
----------------------------------	----------

After long term use with 100W radiated power, only a slight warming of the dipole near the feedpoint can be measured.

The dipole is made of standard semirigid coaxial cable. The center conductor of the feeding line is directly connected to the second arm of the dipole. The antenna is therefore short-circuited for DC-signals. On some of the dipoles, small end caps are added to the dipole arms in order to improve matching when loaded according to the position as explained in the "Measurement Conditions" paragraph. The SAR data are not affected by this change. The overall dipole length is still according to the Standard.

No excessive force must be applied to the dipole arms, because they might bend or the soldered connections near the feedpoint may be damaged.

### Additional EUT Data

Manufactured by	SPEAG
-----------------	-------

# DASY5 Validation Report for Head TSL

Date: 13.10.2023

Test Laboratory: SPEAG, Zurich, Switzerland

**DUT: Dipole 1750 MHz; Type: D1750V2; Serial: D1750V2 - SN:1053**

Communication System: UID 0 - CW; Frequency: 1750 MHz

Medium parameters used:  $f = 1750$  MHz;  $\sigma = 1.35$  S/m;  $\epsilon_r = 40.6$ ;  $\rho = 1000$  kg/m<sup>3</sup>

Phantom section: Flat Section

Measurement Standard: DASY5 (IEEE/IEC/ANSI C63.19-2011)

DASY52 Configuration:

- Probe: EX3DV4 - SN7349; ConvF(8.76, 8.76, 8.76) @ 1750 MHz; Calibrated: 10.01.2023
- Sensor-Surface: 1.4mm (Mechanical Surface Detection)
- Electronics: DAE4 Sn601; Calibrated: 03.10.2023
- Phantom: Flat Phantom 5.0 (front); Type: QD000P50AA; Serial: 1001
- DASY52 52.10.4(1535); SEMCAD X 14.6.14(7501)

## Dipole Calibration for Head Tissue/Pin=250 mW, d=10mm/Zoom Scan (7x7x7)/Cube 0:

Measurement grid: dx=5mm, dy=5mm, dz=5mm

Reference Value = 103.9 V/m; Power Drift = 0.07 dB

Peak SAR (extrapolated) = 16.6 W/kg

**SAR(1 g) = 9.05 W/kg; SAR(10 g) = 4.79 W/kg**

Smallest distance from peaks to all points 3 dB below = 10 mm

Ratio of SAR at M2 to SAR at M1 = 55.3%

Maximum value of SAR (measured) = 13.6 W/kg

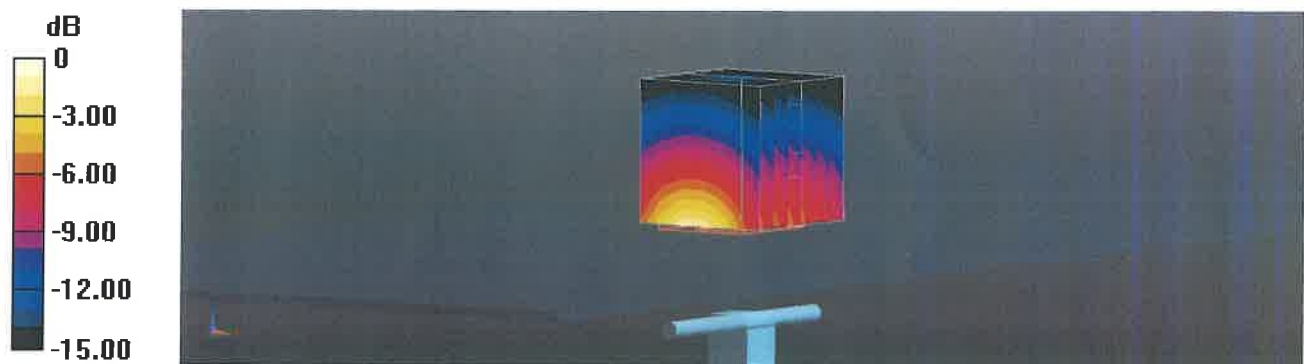

0 dB = 13.6 W/kg = 11.32 dBW/kg



# Impedance Measurement Plot for Head TSL

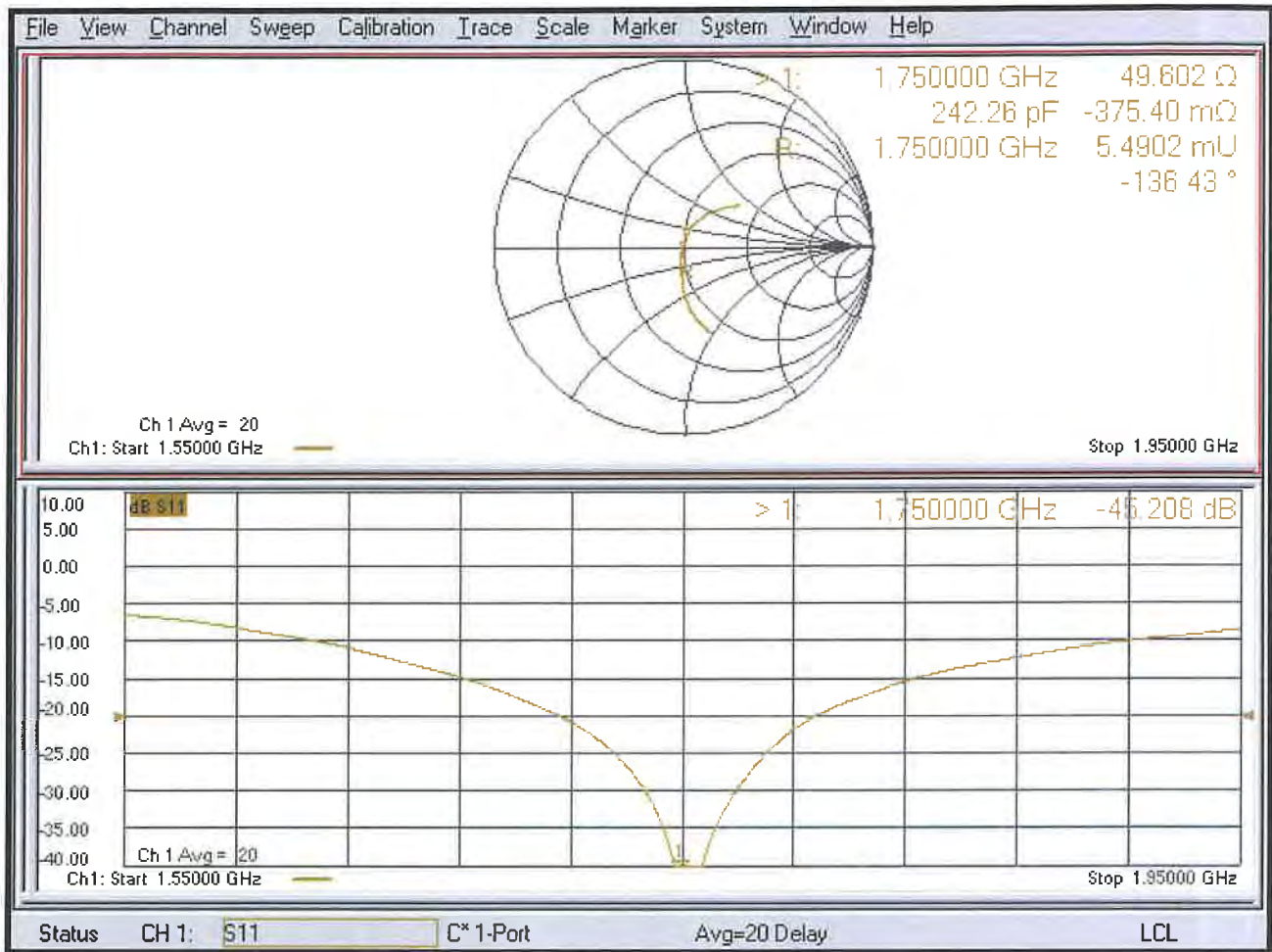



## Dipole Impedance Measurement

Equipment Location	Equipment Name	Model Name	Date of Verification
UL Verification Services Inc. 47173 Benicia Street Fremont, CA 94538, U.S.A.	Dipole Antenna	D1750V2-1053	April 9, 2024

Number:	Check List:	Result:
1	Visual Inspection	Pass
2	Return/Loss and Impedance	Pass
3	Dipole Arms	Pass

Equipment List:	
Equipment Name:	Calibration Date:
R&S Vector Network Analyzer	2/13/2024
ZV-Z135 Calibration Kit	5/17/2024

## Dipole Impedance Measurement

### 1) Photo of Dipole

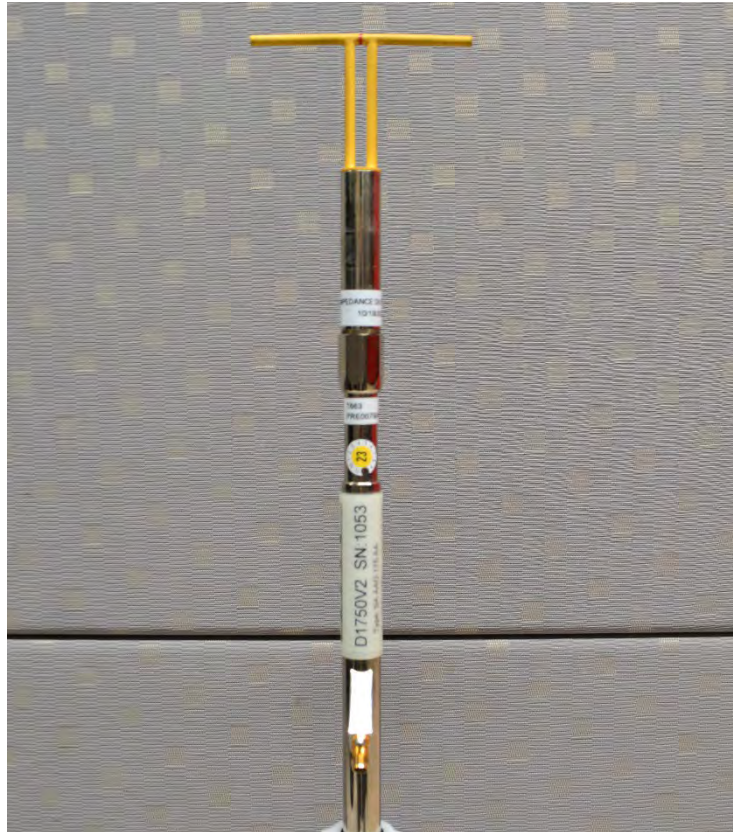

- The connector of dipole contains no abnormalities.

## Dipole Impedance Measurement

### 2) Impedance and Return/Loss

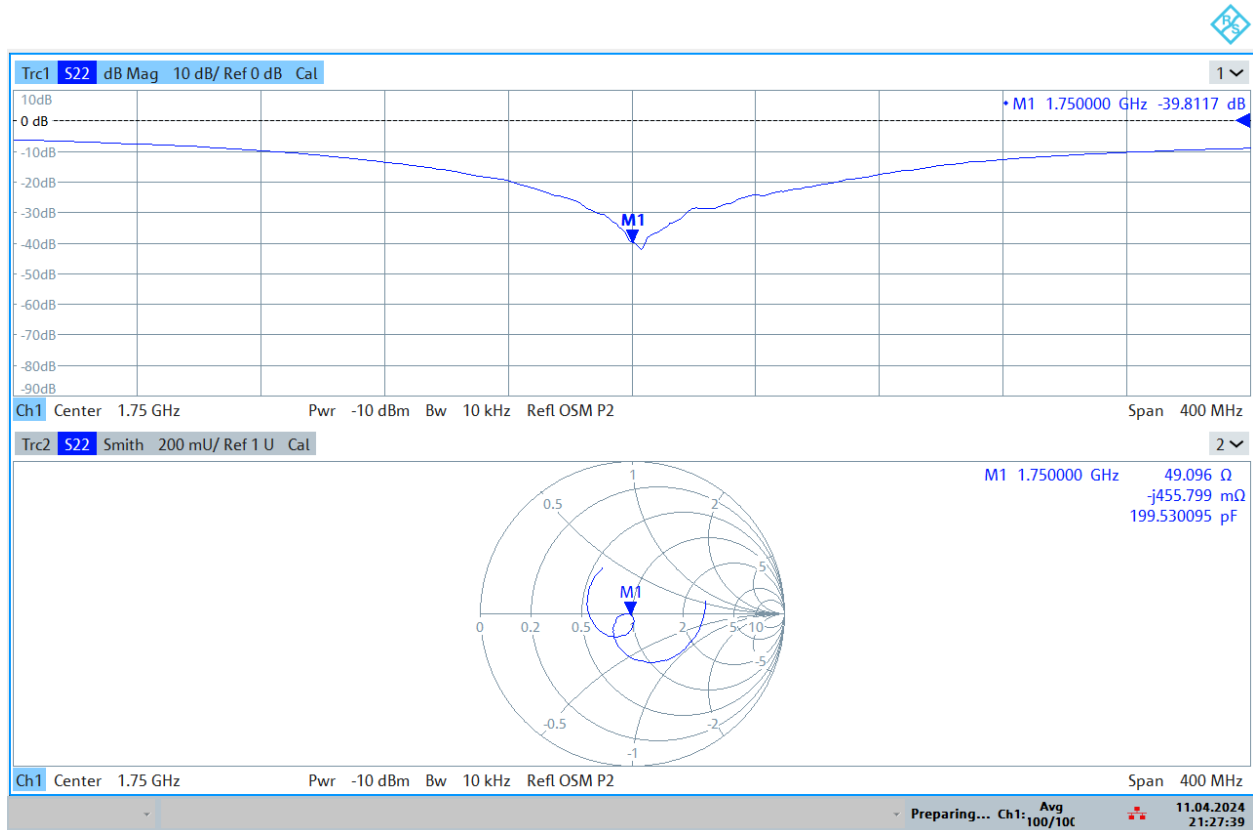

21:27:40 11.04.2024

- Return/Loss is greater than the -20 dB cutoff and Impedance is within 5 Ω of previous value.

## Dipole Impedance Measurement

### 3) Dipole Arms

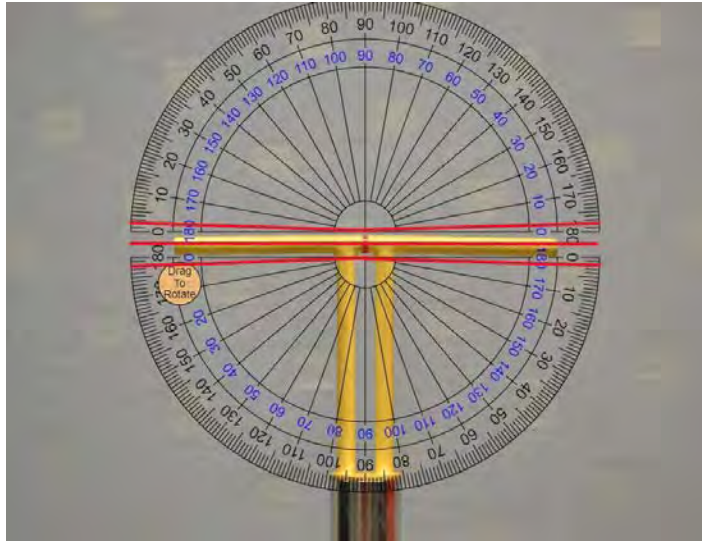

- The center red line indicates that the arms of the dipole fall within  $\pm 2^\circ$