



Accreditation No.: **SCS 0108**

Accredited by the Swiss Accreditation Service (SAS)  
The Swiss Accreditation Service is one of the signatories to the EA  
Multilateral Agreement for the recognition of calibration certificates

Client **UL USA**

Certificate No: **D3500V2-1060\_Feb23**

## CALIBRATION CERTIFICATE

Object **D3500V2 - SN:1060**

Calibration procedure(s) **QA CAL-22.v7  
Calibration Procedure for SAR Validation Sources between 3-10 GHz**

Calibration date: **February 07, 2023**

This calibration certificate documents the traceability to national standards, which realize the physical units of measurements (SI).  
The measurements and the uncertainties with confidence probability are given on the following pages and are part of the certificate.

All calibrations have been conducted in the closed laboratory facility: environment temperature ( $22 \pm 3$ )°C and humidity < 70%.

Calibration Equipment used (M&TE critical for calibration)

Primary Standards	ID #	Cal Date (Certificate No.)	Scheduled Calibration
Power meter NRP	SN: 104778	04-Apr-22 (No. 217-03525/03524)	Apr-23
Power sensor NRP-Z91	SN: 103244	04-Apr-22 (No. 217-03524)	Apr-23
Power sensor NRP-Z91	SN: 103245	04-Apr-22 (No. 217-03525)	Apr-23
Reference 20 dB Attenuator	SN: BH9394 (20k)	04-Apr-22 (No. 217-03527)	Apr-23
Type-N mismatch combination	SN: 310982 / 06327	04-Apr-22 (No. 217-03528)	Apr-23
Reference Probe EX3DV4	SN: 3503	08-Mar-22 (No. EX3-3503_Mar22)	Mar-23
DAE4	SN: 601	19-Dec-22 (No. DAE4-601_Dec22)	Dec-23

Secondary Standards	ID #	Check Date (in house)	Scheduled Check
Power meter E4419B	SN: GB39512475	30-Oct-14 (in house check Oct-22)	In house check: Oct-24
Power sensor HP 8481A	SN: US37292783	07-Oct-15 (in house check Oct-22)	In house check: Oct-24
Power sensor HP 8481A	SN: MY41093315	07-Oct-15 (in house check Oct-22)	In house check: Oct-24
RF generator R&S SMT-06	SN: 100972	15-Jun-15 (in house check Oct-22)	In house check: Oct-24
Network Analyzer Agilent E8358A	SN: US41080477	31-Mar-14 (in house check Oct-22)	In house check: Oct-24

	Name	Function	Signature
Calibrated by:	<b>Jeton Kastrati</b>	<b>Laboratory Technician</b>	
Approved by:	<b>Sven Kühn</b>	<b>Technical Manager</b>	

Issued: February 8, 2023

This calibration certificate shall not be reproduced except in full without written approval of the laboratory.



Accredited by the Swiss Accreditation Service (SAS)

The Swiss Accreditation Service is one of the signatories to the EA  
Multilateral Agreement for the recognition of calibration certificates

Accreditation No.: **SCS 0108**

### Glossary:

TSL	tissue simulating liquid
ConvF	sensitivity in TSL / NORM x,y,z
N/A	not applicable or not measured

### Calibration is Performed According to the Following Standards:

- IEC/IEEE 62209-1528, "Measurement Procedure For The Assessment Of Specific Absorption Rate Of Human Exposure To Radio Frequency Fields From Hand-Held And Body-Worn Wireless Communication Devices - Part 1528: Human Models, Instrumentation And Procedures (Frequency Range of 4 MHz to 10 GHz)", October 2020.
- KDB 865664, "SAR Measurement Requirements for 100 MHz to 6 GHz"

### Additional Documentation:

- DASY System Handbook

### Methods Applied and Interpretation of Parameters:

- Measurement Conditions:** Further details are available from the Validation Report at the end of the certificate. All figures stated in the certificate are valid at the frequency indicated.
- Antenna Parameters with TSL:** The source is mounted in a touch configuration below the center marking of the flat phantom.
- Return Loss:** This parameter is measured with the source positioned under the liquid filled phantom (as described in the measurement condition clause). The Return Loss ensures low reflected power. No uncertainty required.
- SAR measured:** SAR measured at the stated antenna input power.
- SAR normalized:** SAR as measured, normalized to an input power of 1 W at the antenna connector.
- SAR for nominal TSL parameters:** The measured TSL parameters are used to calculate the nominal SAR result.

The reported uncertainty of measurement is stated as the standard uncertainty of measurement multiplied by the coverage factor  $k=2$ , which for a normal distribution corresponds to a coverage probability of approximately 95%.

## Measurement Conditions

DASY system configuration, as far as not given on page 1.

<b>DASY Version</b>	DASY52	V52.10.4
<b>Extrapolation</b>	Advanced Extrapolation	
<b>Phantom</b>	Modular Flat Phantom	
<b>Distance Dipole Center - TSL</b>	10 mm	with Spacer
<b>Zoom Scan Resolution</b>	dx, dy = 4 mm, dz = 1.4 mm	Graded Ratio = 1.4 (Z direction)
<b>Frequency</b>	3500 MHz ± 1 MHz	

## Head TSL parameters

The following parameters and calculations were applied.

	Temperature	Permittivity	Conductivity
<b>Nominal Head TSL parameters</b>	22.0 °C	37.9	2.91 mho/m
<b>Measured Head TSL parameters</b>	(22.0 ± 0.2) °C	37.9 ± 6 %	2.96 mho/m ± 6 %
<b>Head TSL temperature change during test</b>	< 0.5 °C	---	---

## SAR result with Head TSL

<b>SAR averaged over 1 cm<sup>3</sup> (1 g) of Head TSL</b>	Condition	
SAR measured	100 mW input power	6.59 W/kg
SAR for nominal Head TSL parameters	normalized to 1W	<b>65.7 W/kg ± 19.9 % (k=2)</b>

<b>SAR averaged over 10 cm<sup>3</sup> (10 g) of Head TSL</b>	condition	
SAR measured	100 mW input power	2.49 W/kg
SAR for nominal Head TSL parameters	normalized to 1W	<b>24.9 W/kg ± 19.5 % (k=2)</b>

## Appendix (Additional assessments outside the scope of SCS 0108)

### Antenna Parameters with Head TSL

Impedance, transformed to feed point	52.4 $\Omega$ - 6.3 j $\Omega$
Return Loss	- 23.6 dB

### General Antenna Parameters and Design

Electrical Delay (one direction)	1.132 ns
----------------------------------	----------

After long term use with 100W radiated power, only a slight warming of the dipole near the feedpoint can be measured.

The dipole is made of standard semirigid coaxial cable. The center conductor of the feeding line is directly connected to the second arm of the dipole. The antenna is therefore short-circuited for DC-signals. On some of the dipoles, small end caps are added to the dipole arms in order to improve matching when loaded according to the position as explained in the "Measurement Conditions" paragraph. The SAR data are not affected by this change. The overall dipole length is still according to the Standard.

No excessive force must be applied to the dipole arms, because they might bend or the soldered connections near the feedpoint may be damaged.

### Additional EUT Data

Manufactured by	SPEAG
-----------------	-------

# DASY5 Validation Report for Head TSL

Date: 07.02.2023

Test Laboratory: SPEAG, Zurich, Switzerland

**DUT: Dipole 3500 MHz; Type: D3500V2; Serial: D3500V2 - SN:1060**

Communication System: UID 0 - CW; Frequency: 3500 MHz

Medium parameters used:  $f = 3500$  MHz;  $\sigma = 2.96$  S/m;  $\epsilon_r = 37.9$ ;  $\rho = 1000$  kg/m<sup>3</sup>

Phantom section: Flat Section

Measurement Standard: DASY5 (IEEE/IEC/ANSI C63.19-2011)

DASY52 Configuration:

- Probe: EX3DV4 - SN3503; ConvF(7.91, 7.91, 7.91) @ 3500 MHz; Calibrated: 08.03.2022
- Sensor-Surface: 1.4mm (Mechanical Surface Detection)
- Electronics: DAE4 Sn601; Calibrated: 19.12.2022
- Phantom: Flat Phantom 5.0 (front); Type: QD 000 P50 AA; Serial: 1001
- DASY52 52.10.4(1535); SEMCAD X 14.6.14(7501)

**Dipole Calibration for Head Tissue/Pin=100 mW, d=10mm, f=3500MHz/Zoom Scan,**

**dist=1.4mm (8x8x8)/Cube 0:** Measurement grid: dx=4mm, dy=4mm, dz=1.4mm

Reference Value = 69.44 V/m; Power Drift = -0.07 dB

Peak SAR (extrapolated) = 17.5 W/kg

**SAR(1 g) = 6.59 W/kg; SAR(10 g) = 2.49 W/kg**

Smallest distance from peaks to all points 3 dB below = 8.2 mm

Ratio of SAR at M2 to SAR at M1 = 75.9%

Maximum value of SAR (measured) = 12.6 W/kg

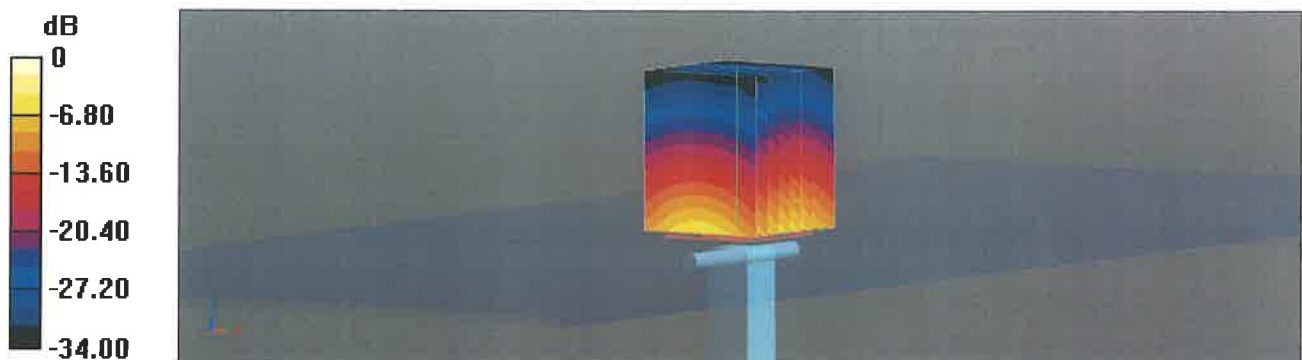

0 dB = 12.6 W/kg = 11.0 dBW/kg

# Impedance Measurement Plot for Head TSL

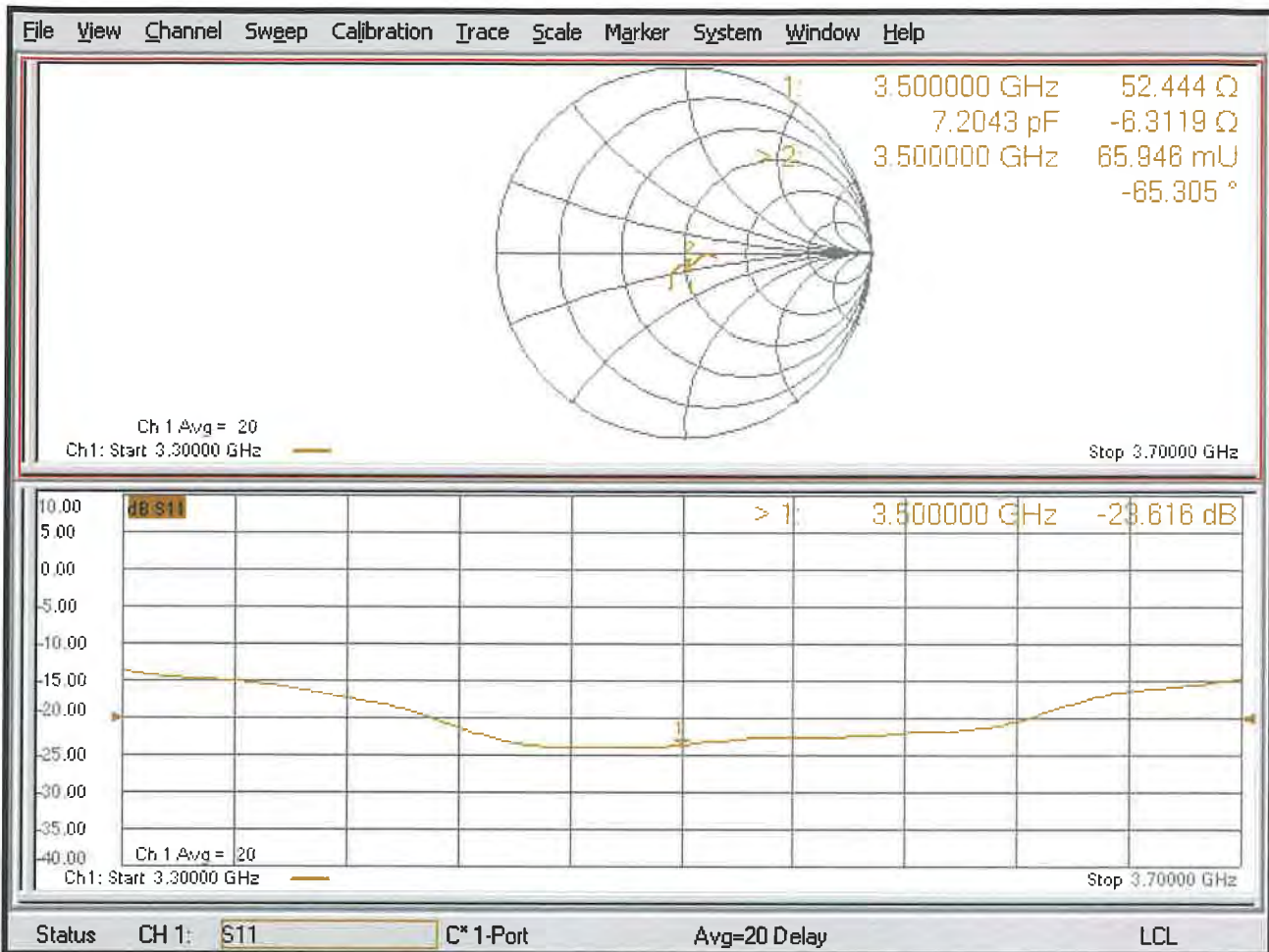



## Dipole Impedance Measurement

Equipment Location	Equipment Name	Model Name	Date of Verification
UL Verification Services Inc. 47173 Benicia Street Fremont, CA 94538, U.S.A.	Dipole Antenna	D3500V2-1060	January 01, 2024

Number:	Check List:	Result:
1	Visual Inspection	Pass
2	Return/Loss and Impedance	Pass
3	Dipole Arms	Pass

Equipment List:	
Equipment Name:	Calibration Date:
R&S ZNLE6 Vector Network Analyzer	03/05/2024
ZV-Z135 Calibration Kit	03/27/2024

## Dipole Impedance Measurement

### 1) Photo of Dipole



- The connector of dipole contains no abnormalities.



## Dipole Impedance Measurement

### 2) Impedance and Return/Loss

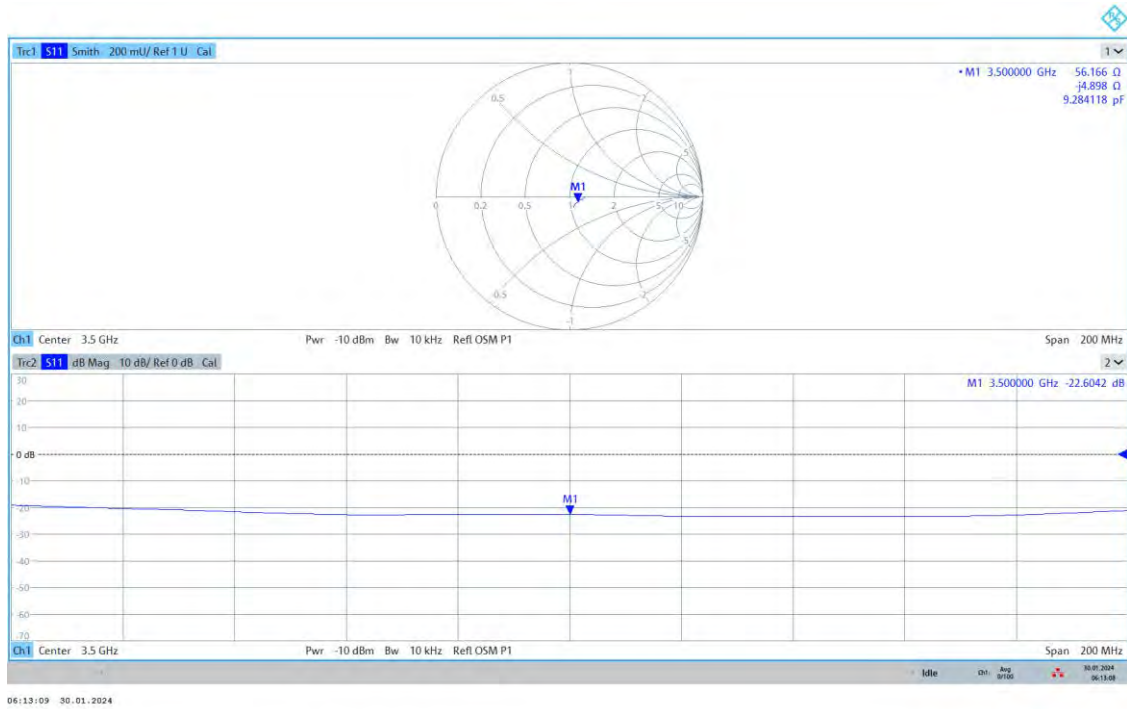

- Return/Loss is greater than the -20 dB cutoff and Impedance is within 5 Ω of previous value.

## Dipole Impedance Measurement

### 3) Dipole Arms

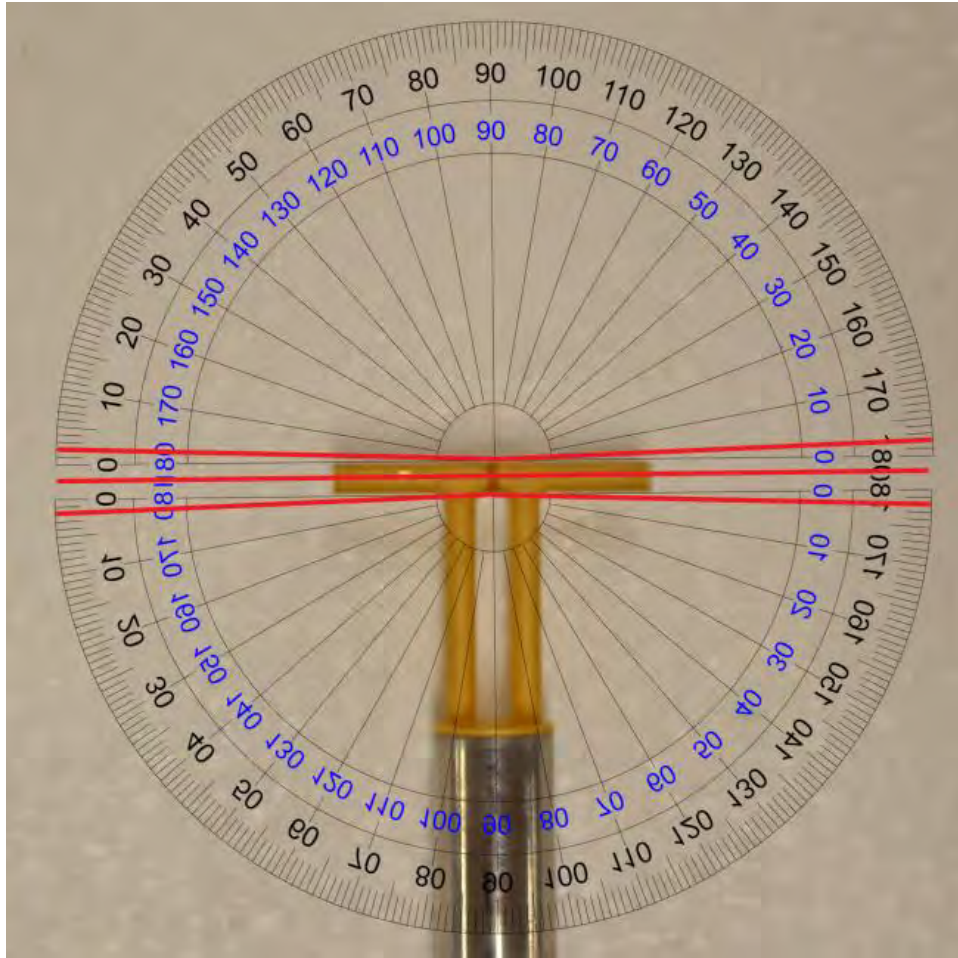

- The center red line indicates that the arms of the dipole fall within  $\pm 2^\circ$



## Dipole Impedance Measurement

Equipment Location	Equipment Name	Model Name	Date of Verification
UL Verification Services Inc. 47173 Benicia Street Fremont, CA 94538, U.S.A.	Dipole Antenna	D3500V2-1060	February 3, 2025

Number:	Check List:	Result:
1	Visual Inspection	Pass
2	Return/Loss and Impedance	Pass
3	Dipole Arms	Pass

Equipment List:	
Equipment Name:	Calibration Date:
R&S Vector Network Analyzer	2/13/2024
ZV-Z135 Calibration Kit	3/27/2024

## Dipole Impedance Measurement

### 1) Photo of Dipole



- The connector of dipole contains no abnormalities.

## Dipole Impedance Measurement

### 2) Impedance and Return/Loss

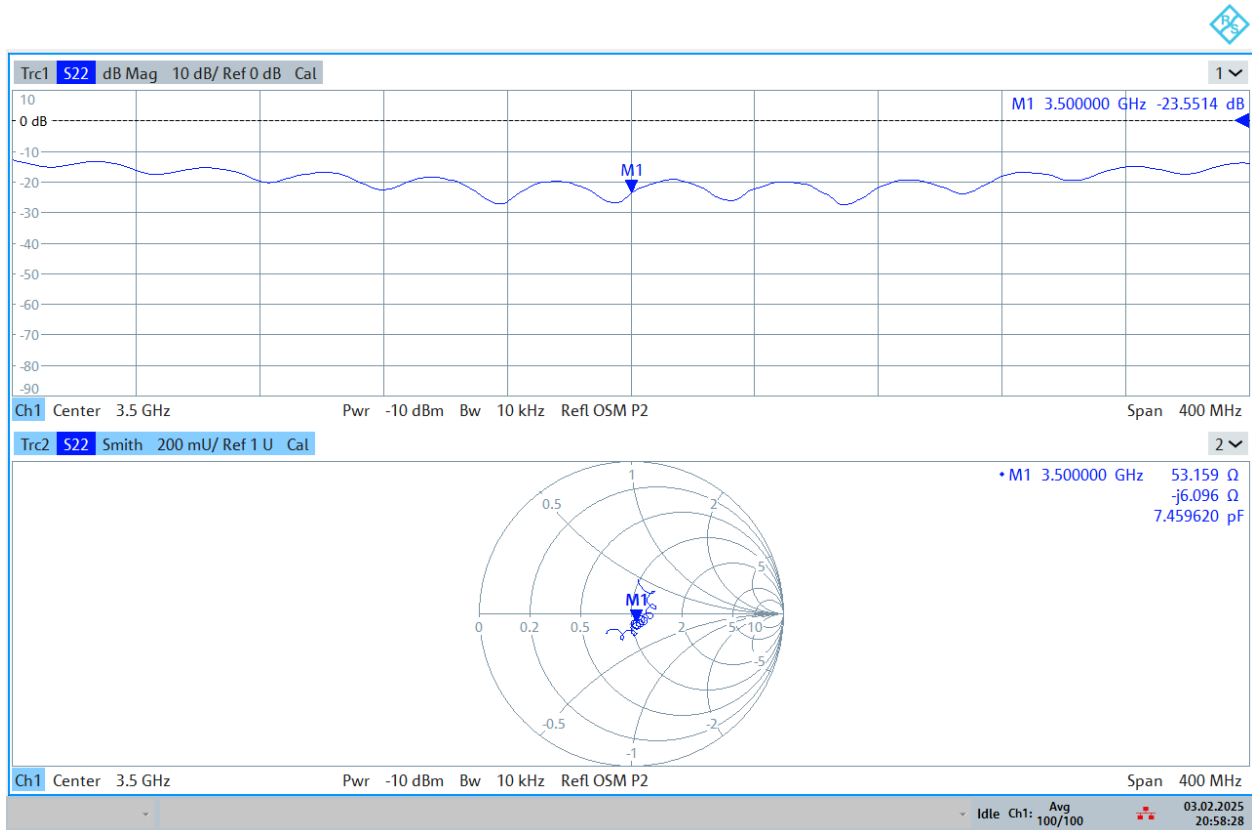

20:58:28 03.02.2025

- Return/Loss is greater than the -20 dB cutoff and Impedance is within 5 Ω of previous value.

## Dipole Impedance Measurement

### 3) Dipole Arms

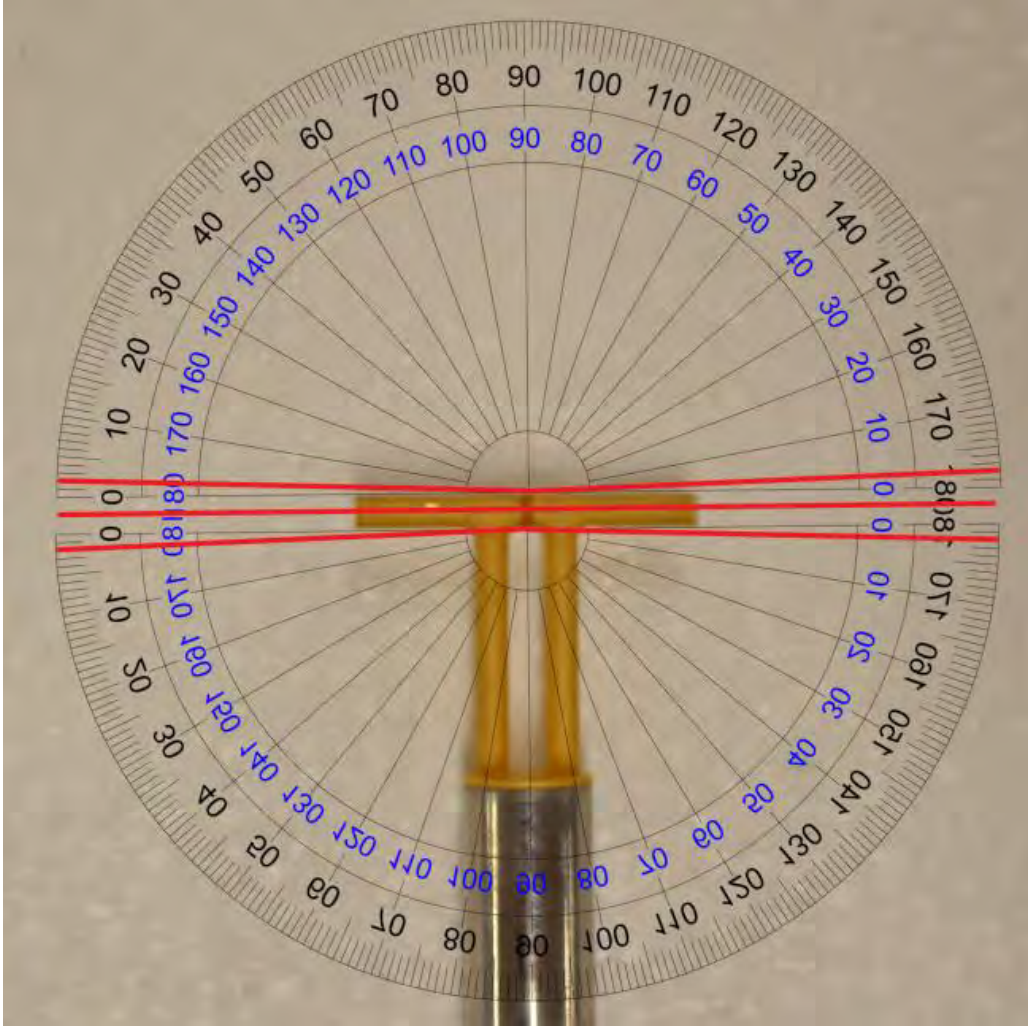

- The center red line indicates that the arms of the dipole fall within  $\pm 2^\circ$



Accredited by the Swiss Accreditation Service (SAS)  
**The Swiss Accreditation Service is one of the signatories to the EA Multilateral Agreement for the recognition of calibration certificates**

Accreditation No.: **SCS 0108**

Client **UL**  
**Fremont, USA**

Certificate No. **D3700V2-1039\_Apr25**

**CALIBRATION CERTIFICATE**

Object **D3700V2 - SN: 1039**

Calibration procedure(s) **QA CAL-22.v7**  
**Calibration Procedure for SAR Validation Sources between 3 - 10 GHz**

Calibration date **April 11, 2025**

This calibration certificate documents the traceability to national standards, which realize the physical units of measurements (SI). The measurements and the uncertainties with confidence probability are given on the following pages and are part of the certificate.

All calibrations have been conducted in the closed laboratory facility: environment temperature (22 ± 3)°C and humidity < 70%.

Calibration Equipment used (M&TE critical for calibration)

Primary Standards	ID	Cal Date (Certificate No.)	Scheduled Cal
Power Sensor R&S NRP-33T	SN: 100967	26-Mar-25 (No. 217-04290)	Mar-26
Power Sensor R&S NRP18A	SN: 101859	06-Feb-25 (No. 4030A315009541)	Feb-26
Spectrum Analyzer R&S FSV40	SN: 101832	29-Jan-25 (No. 4030A315009658)	Jan-26
3.5mm mismatch combination	SN: 1152	24-Mar-25 (No. 217-04293)	Mar-26
OCP DAK-12	SN: 1016	24-Sept-24 (No. OCP-DAK12-1016_Sep24)	Sep-25
OCP DAK-3.5	SN: 1249	23-Sept-24 (No. OCP-DAK3.5-1249_Sep24)	Sep-25
Reference Probe EX3DV4	SN: 7349	10-Jan-25 (No. EX3-7349_Jan25)	Jan-26
DAE4ip	SN: 1836	28-Oct-24 (No. DAE4ip-1836_Oct24)	Oct-25

Secondary Standards	ID	Check Date (in house)	Scheduled Check
ACAD Source Box	SN: 1000	28-May-24 (No. 675-ACAD_Source_Box-240528)	May-25
Signal Generator R&S SMB100A	SN: 182081	28-May-24 (No. 675-CAL16-S4588-240528)	May-25
Mismatch; SMA	SN: 1102	22-May-24 (No. 675-Mismatch_SMA-240522)	May-25

	Name	Function	Signature
Calibrated by	Paulo Pina	Laboratory Technician	
Approved by	Sven Kühn	Technical Manager	

Issued: April 15, 2025

This calibration certificate shall not be reproduced except in full without written approval of the laboratory.



Accredited by the Swiss Accreditation Service (SAS)  
**The Swiss Accreditation Service is one of the signatories to the EA  
Multilateral Agreement for the recognition of calibration certificates**

**Accreditation No.: SCS 0108**

## Glossary

TSL tissue simulating liquid  
ConvF sensitivity in TSL / NORM x,y,z  
N/A not applicable or not measured

## Calibration is Performed According to the Following Standards

- IEC/IEEE 62209-1528, "Measurement Procedure For The Assessment Of Specific Absorption Rate Of Human Exposure To Radio Frequency Fields From Hand-Held And Body-Worn Wireless Communication Devices - Part 1528: Human Models, Instrumentation And Procedures (Frequency Range of 4 MHz to 10 GHz)", October 2020.
- KDB 865664, "SAR Measurement Requirements for 100 MHz to 6 GHz"

## Additional Documentation

- DASY System Handbook

## Methods Applied and Interpretation of Parameters

- *Measurement Conditions*: Further details are available from the Validation Report at the end of the certificate. All figures stated in the certificate are valid at the frequency indicated.
- *Antenna Parameters with TSL*: The dipole is mounted with the spacer to position its feed point exactly below the center marking of the flat phantom section, with the arms oriented parallel to the body axis.
- *Feed Point Impedance and Return Loss*: These parameters are measured with the dipole positioned under the liquid filled phantom. The impedance stated is transformed from the measurement at the SMA connector to the feed point. The Return Loss ensures low reflected power. No uncertainty required.
- *Electrical Delay*: One-way delay between the SMA connector and the antenna feed point. No uncertainty required.
- *SAR measured*: SAR measured at the stated antenna input power.
- *SAR normalized*: SAR as measured, normalized to an input power of 1 W at the antenna connector.
- *SAR for nominal TSL parameters*: The measured TSL parameters are used to calculate the nominal SAR result.

The reported uncertainty of measurement is stated as the standard uncertainty of measurement multiplied by the coverage factor  $k=2$ , which for a normal distribution corresponds to a coverage probability of approximately 95%.



## Measurement Conditions

DASY system configuration, as far as not given on page 1.

<b>DASY Version</b>	DASY8 Module SAR	16.4.0
<b>Extrapolation</b>	Advanced Extrapolation	
<b>Phantom</b>	Modular Flat Phantom	
<b>Distance Dipole Center - TSL</b>	10 mm	with spacer
<b>Zoom Scan Resolution</b>	dx, dy = 5mm, dz = 1.4mm	Graded Ratio = 1.5 mm (Z direction)
<b>Frequency</b>	3700MHz ±1MHz	

## HSL parameters at 3700 MHz

The following parameters and calculations were applied.

	Temperature	Permittivity	Conductivity
<b>Nominal HSL parameters</b>	22.0 °C	37.7	3.12 mho/m
<b>Measured HSL parameters</b>	(22.0 ±0.2)°C	38.7 ±6%	3.10 mho/m ±6%
<b>HSL temperature change during test</b>	< 0.5 °C		

## SAR result with HSL at 3700 MHz

<b>SAR averaged over 1 cm<sup>3</sup> (1 g) of HSL</b>	Condition	
SAR for nominal HSL parameters	20 dBm input power	6.78 W/kg
SAR for nominal HSL parameters	normalized to 1W	67.8 W/kg ±19.9% (k = 2)

<b>SAR averaged over 10 cm<sup>3</sup> (10 g) of HSL</b>	Condition	
SAR for nominal HSL parameters	20 dBm input power	2.51 W/kg
SAR for nominal HSL parameters	normalized to 1W	25.1 W/kg ±19.5% (k = 2)

**Appendix (Additional assessments outside the scope of SCS 0108)****Antenna Parameters with HSL at 3700 MHz**

Impedance	46.2 $\Omega$ + 0.7 j $\Omega$
Return Loss	-28.0 dB

**General Antenna Parameters and Design**

Electrical Delay (one direction)	1.135 ns
----------------------------------	----------

After long term use with 100W radiated power, only a slight warming of the dipole near the feedpoint can be measured. The dipole is made of standard semirigid coaxial cable. The center conductor of the feeding line is directly connected to the second arm of the dipole. The antenna is therefore short-circuited for DC-signals. On some of the dipoles, small end caps are added to the dipole arms in order to improve matching when loaded according to the position as explained in the "Measurement Conditions" paragraph. The SAR data are not affected by this change. The overall dipole length is still according to the Standard. No excessive force must be applied to the dipole arms, because they might bend or the soldered connections near the feedpoint may be damaged.

**Additional EUT Data**

Manufactured by	SPEAG
-----------------	-------

**System Performance Check Report**

**Summary**

Dipole	Frequency [MHz]	TSL	Power [dBm]
D3700V2 - SN1039	3700	HSL	20

**Exposure Conditions**

Phantom Section, TSL	Test Distance [mm]	Band	Group, UID	Frequency [MHz], Channel Number	Conversion Factor	TSL Conductivity [S/m]	TSL Permittivity
Flat	10		CW, 0--	3700, 0	6.45	3.10	38.7

**Hardware Setup**

Phantom	TSL, Measured Date	Probe, Calibration Date	DAE, Calibration Date
MFP V8.0 Center	HSL, 2025-04-11	EX3DV4 - SN7349, 2025-01-10	DAE4ip Sn1836, 2024-10-28

**Scans Setup**

	Zoom Scan
Grid Extents [mm]	28 x 28 x 28
Grid Steps [mm]	5.0 x 5.0 x 1.4
Sensor Surface [mm]	1.4
Graded Grid	Yes
Grading Ratio	1.5
MAIA	N/A
Surface Detection	VMS + 6p
Scan Method	Measured

**Measurement Results**

	Zoom Scan
Date	2025-04-11
psSAR1g [W/Kg]	6.78
psSAR10g [W/Kg]	2.51
Power Drift [dB]	-0.09
Power Scaling	Disabled
Scaling Factor [dB]	
TSL Correction	Positive / Negative

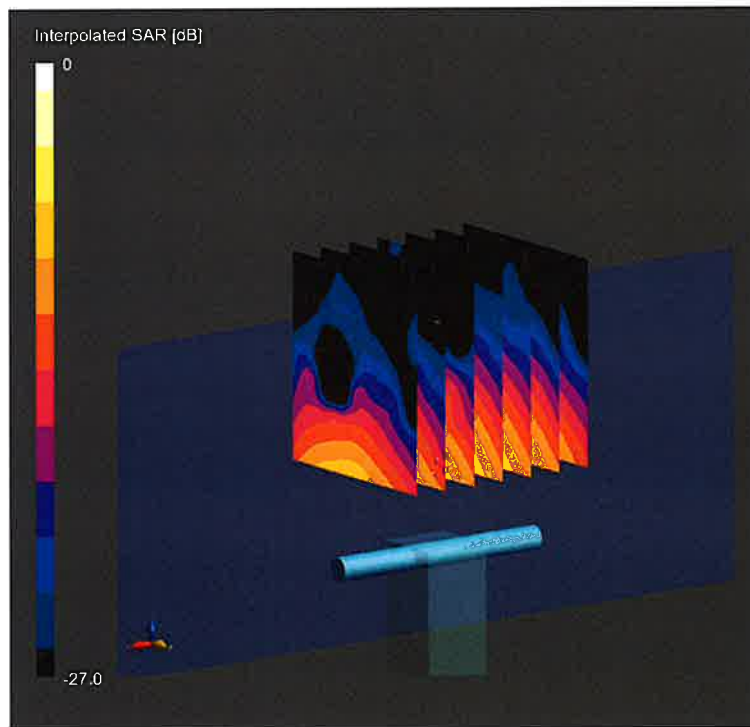

0 dB = 18.2 W/Kg

### Impedance Measurement Plot for HSL

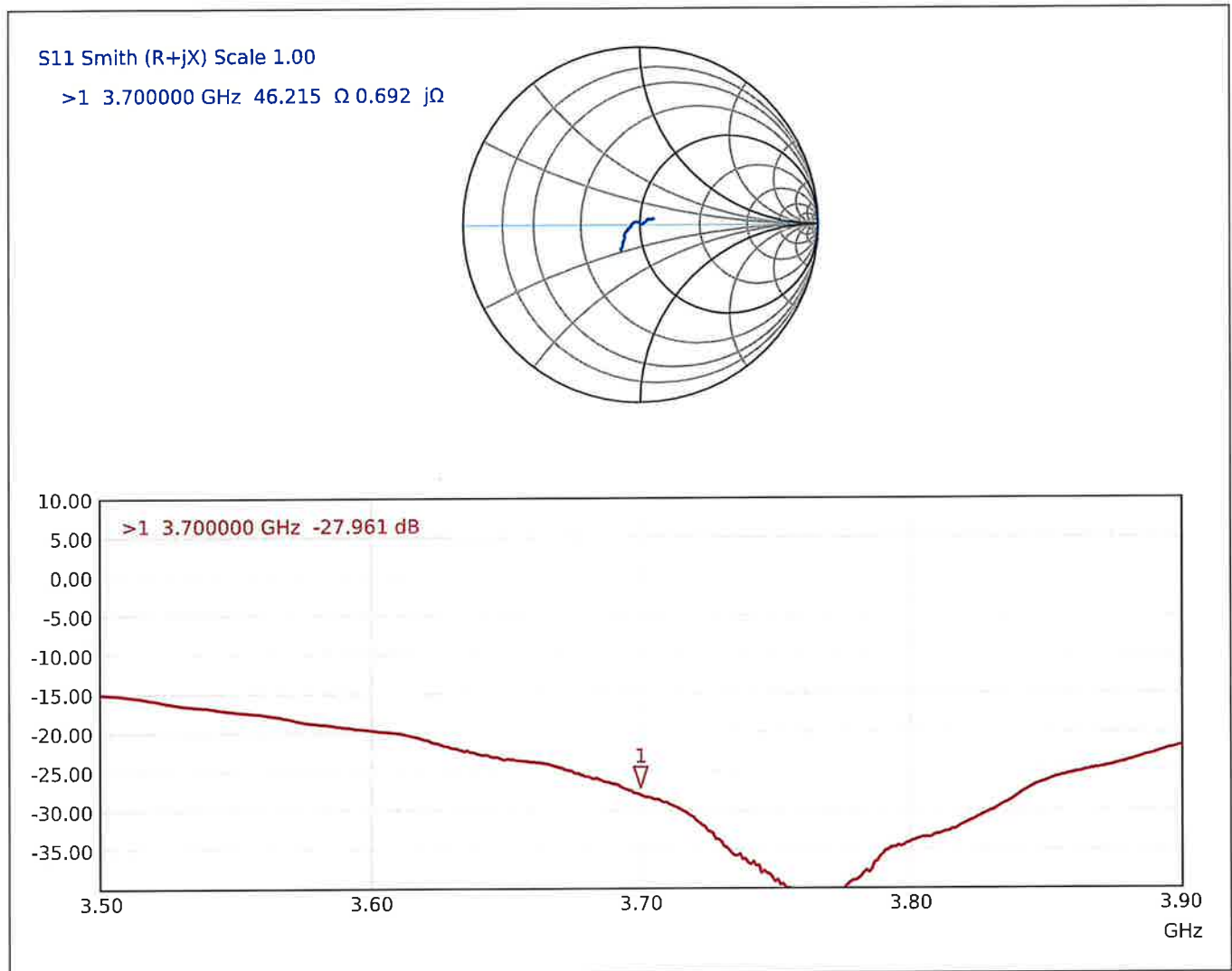



Accredited by the Swiss Accreditation Service (SAS)  
The Swiss Accreditation Service is one of the signatories to the EA  
Multilateral Agreement for the recognition of calibration certificates

Client **UL**  
Fremont, USA

Certificate No. **D3900V2-1102\_Oct23**

## CALIBRATION CERTIFICATE

Object **D3900V2 - SN:1102**

Calibration procedure(s) **QA CAL-22.v7  
Calibration Procedure for SAR Validation Sources between 3-10 GHz**

Calibration date: **October 24, 2023**

This calibration certificate documents the traceability to national standards, which realize the physical units of measurements (SI).  
The measurements and the uncertainties with confidence probability are given on the following pages and are part of the certificate.

All calibrations have been conducted in the closed laboratory facility: environment temperature ( $22 \pm 3$ )°C and humidity < 70%.

Calibration Equipment used (M&TE critical for calibration)

Primary Standards	ID #	Cal Date (Certificate No.)	Scheduled Calibration
Power meter NRP2	SN: 104778	30-Mar-23 (No. 217-03804/03805)	Mar-24
Power sensor NRP-Z91	SN: 103244	30-Mar-23 (No. 217-03804)	Mar-24
Power sensor NRP-Z91	SN: 103245	30-Mar-23 (No. 217-03805)	Mar-24
Reference 20 dB Attenuator	SN: BH9394 (20k)	30-Mar-23 (No. 217-03809)	Mar-24
Type-N mismatch combination	SN: 310982 / 06327	30-Mar-23 (No. 217-03810)	Mar-24
Reference Probe EX3DV4	SN: 3503	07-Mar-23 (No. EX3-3503_Mar23)	Mar-24
DAE4	SN: 601	03-Oct-23 (No. DAE4-601_Oct23)	Oct-24

Secondary Standards	ID #	Check Date (in house)	Scheduled Check
Power meter E4419B	SN: GB39512475	30-Oct-14 (in house check Oct-22)	In house check: Oct-24
Power sensor HP 8481A	SN: US37292783	07-Oct-15 (in house check Oct-22)	In house check: Oct-24
Power sensor HP 8481A	SN: MY41093315	07-Oct-15 (in house check Oct-22)	In house check: Oct-24
RF generator R&S SMT-06	SN: 100972	15-Jun-15 (in house check Oct-22)	In house check: Oct-24
Network Analyzer Agilent E8358A	SN: US41080477	31-Mar-14 (in house check Oct-22)	In house check: Oct-24

Calibrated by: **Claudio Leubler**      Name: Claudio Leubler      Function: Laboratory Technician

Approved by: **Sven Kühn**      Name: Sven Kühn      Function: Technical Manager

Signature

Issued: October 24, 2023

This calibration certificate shall not be reproduced except in full without written approval of the laboratory.



Accredited by the Swiss Accreditation Service (SAS)

The Swiss Accreditation Service is one of the signatories to the EA  
Multilateral Agreement for the recognition of calibration certificates

### Glossary:

TSL	tissue simulating liquid
ConvF	sensitivity in TSL / NORM x,y,z
N/A	not applicable or not measured

### Calibration is Performed According to the Following Standards:

- IEC/IEEE 62209-1528, "Measurement Procedure For The Assessment Of Specific Absorption Rate Of Human Exposure To Radio Frequency Fields From Hand-Held And Body-Worn Wireless Communication Devices - Part 1528: Human Models, Instrumentation And Procedures (Frequency Range of 4 MHz to 10 GHz)", October 2020.
- KDB 865664, "SAR Measurement Requirements for 100 MHz to 6 GHz"

### Additional Documentation:

- DASY System Handbook

### Methods Applied and Interpretation of Parameters:

- Measurement Conditions:** Further details are available from the Validation Report at the end of the certificate. All figures stated in the certificate are valid at the frequency indicated.
- Antenna Parameters with TSL:** The source is mounted in a touch configuration below the center marking of the flat phantom.
- Return Loss:** This parameter is measured with the source positioned under the liquid filled phantom (as described in the measurement condition clause). The Return Loss ensures low reflected power. No uncertainty required.
- SAR measured:** SAR measured at the stated antenna input power.
- SAR normalized:** SAR as measured, normalized to an input power of 1 W at the antenna connector.
- SAR for nominal TSL parameters:** The measured TSL parameters are used to calculate the nominal SAR result.

The reported uncertainty of measurement is stated as the standard uncertainty of measurement multiplied by the coverage factor  $k=2$ , which for a normal distribution corresponds to a coverage probability of approximately 95%.

## Measurement Conditions

DASY system configuration, as far as not given on page 1.

<b>DASY Version</b>	DASY52	V52.10.4
<b>Extrapolation</b>	Advanced Extrapolation	
<b>Phantom</b>	Modular Flat Phantom	
<b>Distance Dipole Center - TSL</b>	10 mm	with Spacer
<b>Zoom Scan Resolution</b>	dx, dy = 4 mm, dz = 1.4 mm	Graded Ratio = 1.4 (Z direction)
<b>Frequency</b>	3900 MHz ± 1 MHz	

## Head TSL parameters

The following parameters and calculations were applied.

	Temperature	Permittivity	Conductivity
<b>Nominal Head TSL parameters</b>	22.0 °C	37.5	3.32 mho/m
<b>Measured Head TSL parameters</b>	(22.0 ± 0.2) °C	37.9 ± 6 %	3.26 mho/m ± 6 %
<b>Head TSL temperature change during test</b>	< 0.5 °C	---	---

## SAR result with Head TSL

<b>SAR averaged over 1 cm<sup>3</sup> (1 g) of Head TSL</b>	Condition	
SAR measured	100 mW input power	6.89 W/kg
SAR for nominal Head TSL parameters	normalized to 1W	<b>69.3 W/kg ± 19.9 % (k=2)</b>

<b>SAR averaged over 10 cm<sup>3</sup> (10 g) of Head TSL</b>	condition	
SAR measured	100 mW input power	2.40 W/kg
SAR for nominal Head TSL parameters	normalized to 1W	<b>24.1 W/kg ± 19.5 % (k=2)</b>

## Appendix (Additional assessments outside the scope of SCS 0108)

### Antenna Parameters with Head TSL

Impedance, transformed to feed point	46.7 $\Omega$ - 2.4 j $\Omega$
Return Loss	- 27.5 dB

### General Antenna Parameters and Design

Electrical Delay (one direction)	1.103 ns
----------------------------------	----------

After long term use with 100W radiated power, only a slight warming of the dipole near the feedpoint can be measured.

The dipole is made of standard semirigid coaxial cable. The center conductor of the feeding line is directly connected to the second arm of the dipole. The antenna is therefore short-circuited for DC-signals. On some of the dipoles, small end caps are added to the dipole arms in order to improve matching when loaded according to the position as explained in the "Measurement Conditions" paragraph. The SAR data are not affected by this change. The overall dipole length is still according to the Standard.

No excessive force must be applied to the dipole arms, because they might bend or the soldered connections near the feedpoint may be damaged.

### Additional EUT Data

Manufactured by	SPEAG
-----------------	-------



# DASY5 Validation Report for Head TSL

Date: 24.10.2023

Test Laboratory: SPEAG, Zurich, Switzerland

**DUT: Dipole 3900 MHz; Type: D3900V2; Serial: D3900V2 - SN:1102**

Communication System: UID 0 - CW; Frequency: 3900 MHz

Medium parameters used:  $f = 3900$  MHz;  $\sigma = 3.26$  S/m;  $\epsilon_r = 37.9$ ;  $\rho = 1000$  kg/m<sup>3</sup>

Phantom section: Flat Section

Measurement Standard: DASY5 (IEEE/IEC/ANSI C63.19-2011)

DASY52 Configuration:

- Probe: EX3DV4 - SN3503; ConvF(7.39, 7.39, 7.39) @ 3900 MHz; Calibrated: 07.03.2023
- Sensor-Surface: 1.4mm (Mechanical Surface Detection)
- Electronics: DAE4 Sn601; Calibrated: 03.10.2023
- Phantom: Flat Phantom 5.0 (front); Type: QD 000 P50 AA; Serial: 1001
- DASY52 52.10.4(1535); SEMCAD X 14.6.14(7501)

**Dipole Calibration for Head Tissue/Pin=100 mW, d=10mm, f=3900MHz/Zoom Scan, dist=1.4mm (8x8x8)/Cube 0:** Measurement grid: dx=4mm, dy=4mm, dz=1.4mm

Reference Value = 70.09 V/m; Power Drift = 0.07 dB

Peak SAR (extrapolated) = 19.2 W/kg

**SAR(1 g) = 6.89 W/kg; SAR(10 g) = 2.4 W/kg**

Smallest distance from peaks to all points 3 dB below = 8 mm

Ratio of SAR at M2 to SAR at M1 = 74.4%

Maximum value of SAR (measured) = 13.4 W/kg

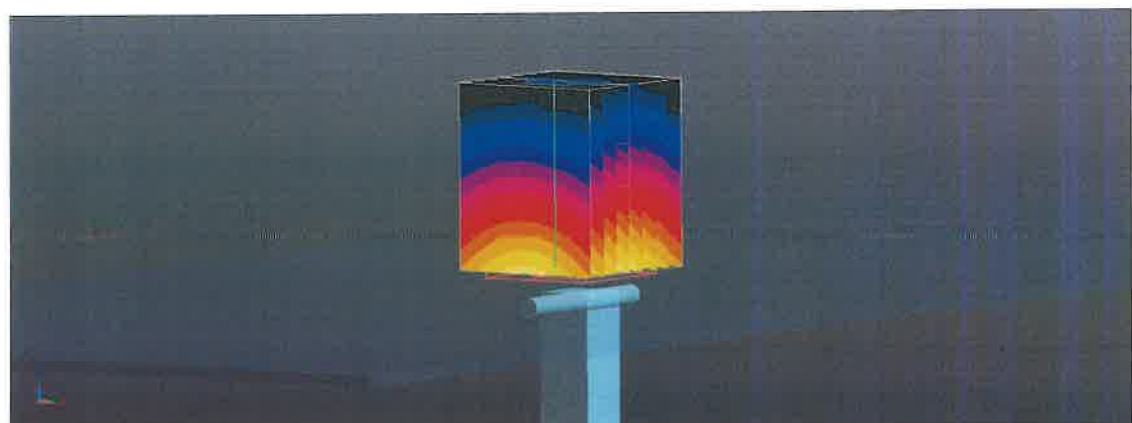
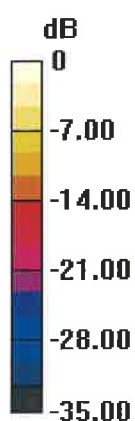

0 dB = 13.4 W/kg = 11.27 dBW/kg

# Impedance Measurement Plot for Head TSL

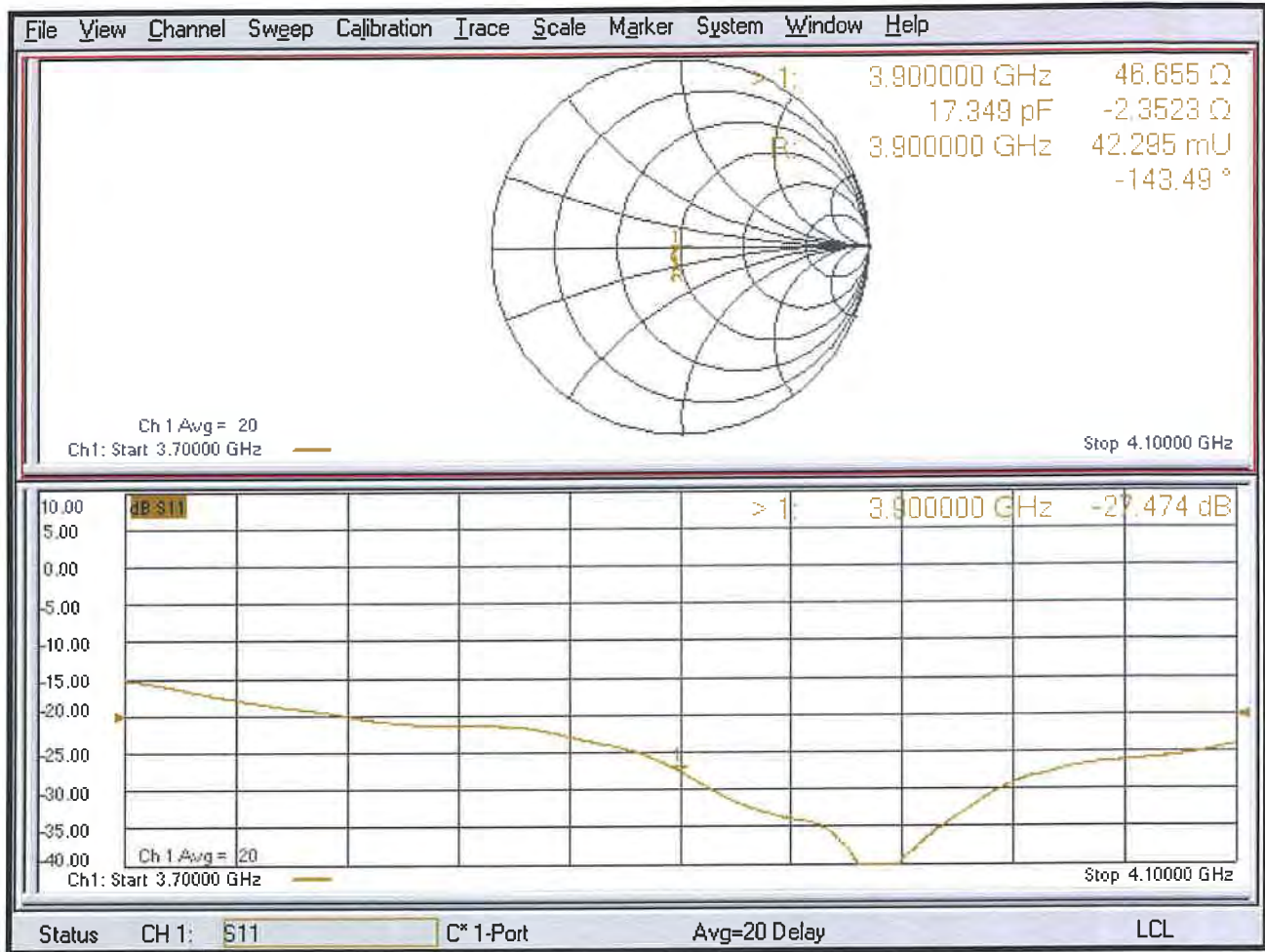



## Dipole Impedance Measurement

Equipment Location	Equipment Name	Model Name	Date of Verification
UL Verification Services Inc. 47173 Benicia Street Fremont, CA 94538, U.S.A.	Dipole Antenna	D3900V2-1102	October 18, 2024

Number:	Check List:	Result:
1	Visual Inspection	Pass
2	Return/Loss and Impedance	Pass
3	Dipole Arms	Pass

Equipment List:	
Equipment Name:	Calibration Date:
R&S Vector Network Analyzer	2/13/2024
ZN-Z135 Calibration Kit	5/17/2024

## Dipole Impedance Measurement

### 1) Photo of Dipole



- The connector of dipole contains no abnormalities.

## Dipole Impedance Measurement

### 2) Impedance and Return/Loss

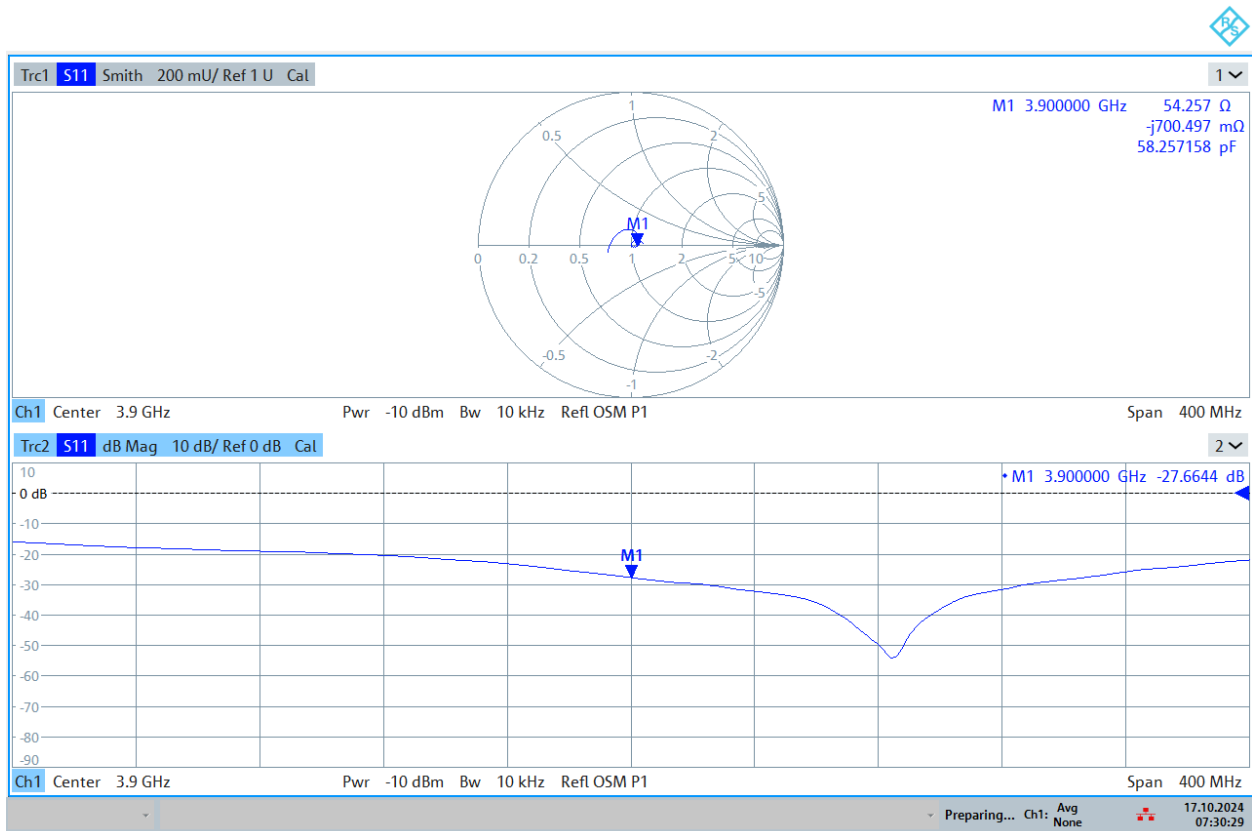

07:30:31 17.10.2024

- Return/Loss is greater than the -20 dB cutoff and Impedance is within 5  $\Omega$  of previous value.

## Dipole Impedance Measurement

### 3) Dipole Arms

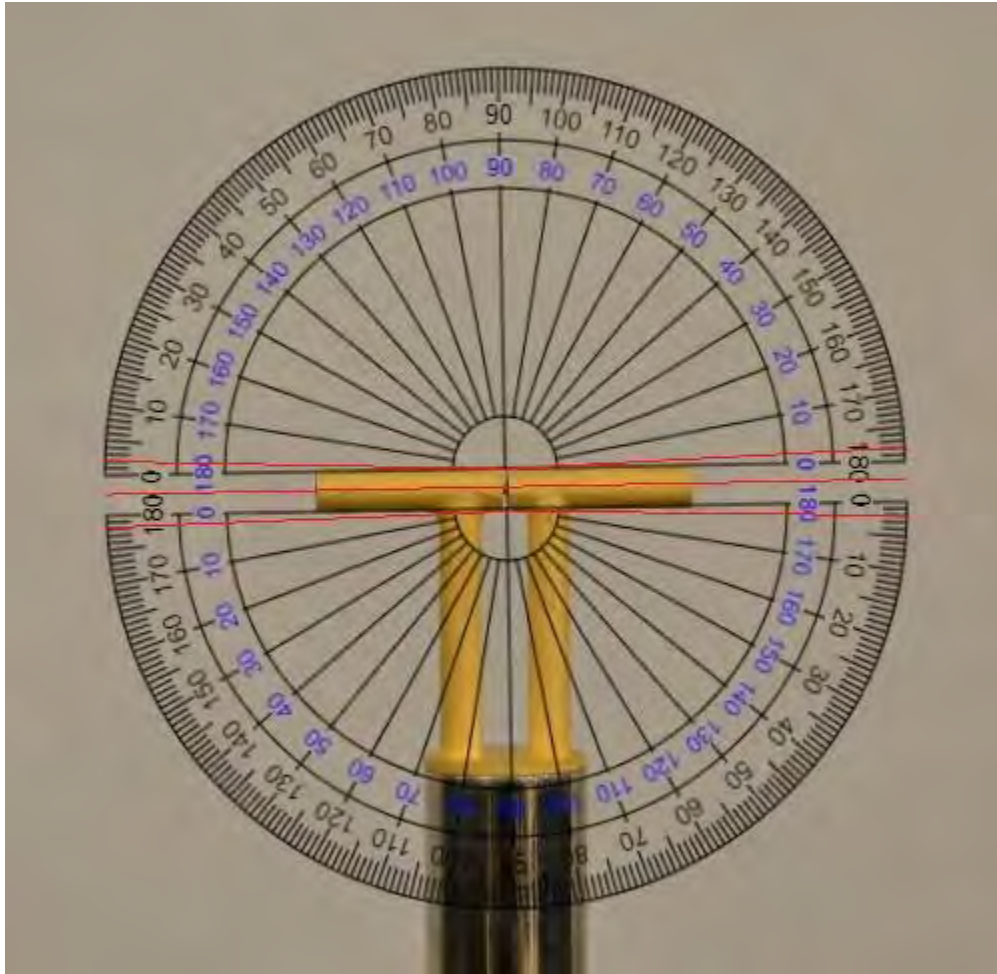

- The center red line indicates that the arms of the dipole fall within  $\pm 2^\circ$



Accredited by the Swiss Accreditation Service (SAS)  
The Swiss Accreditation Service is one of the signatories to the EA  
Multilateral Agreement for the recognition of calibration certificates

Accreditation No.: **SCS 0108**

Client **UL USA**

Certificate No: **D5GHzV2-1003\_Feb23**

## CALIBRATION CERTIFICATE

Object **D5GHzV2 - SN:1003**

Calibration procedure(s) **QA CAL-22.v7  
Calibration Procedure for SAR Validation Sources between 3-10 GHz**

Calibration date: **February 22, 2023**

This calibration certificate documents the traceability to national standards, which realize the physical units of measurements (SI).  
The measurements and the uncertainties with confidence probability are given on the following pages and are part of the certificate.

All calibrations have been conducted in the closed laboratory facility: environment temperature ( $22 \pm 3$ )°C and humidity < 70%.

Calibration Equipment used (M&TE critical for calibration)

Primary Standards	ID #	Cal Date (Certificate No.)	Scheduled Calibration
Power meter NRP	SN: 104778	04-Apr-22 (No. 217-03525/03524)	Apr-23
Power sensor NRP-Z91	SN: 103244	04-Apr-22 (No. 217-03524)	Apr-23
Power sensor NRP-Z91	SN: 103245	04-Apr-22 (No. 217-03525)	Apr-23
Reference 20 dB Attenuator	SN: BH9394 (20k)	04-Apr-22 (No. 217-03527)	Apr-23
Type-N mismatch combination	SN: 310982 / 06327	04-Apr-22 (No. 217-03528)	Apr-23
Reference Probe EX3DV4	SN: 3503	08-Mar-22 (No. EX3-3503_Mar22)	Mar-23
DAE4	SN: 601	19-Dec-22 (No. DAE4-601_Dec22)	Dec-23

Secondary Standards	ID #	Check Date (in house)	Scheduled Check
Power meter E4419B	SN: GB39512475	30-Oct-14 (in house check Oct-22)	In house check: Oct-24
Power sensor HP 8481A	SN: US37292783	07-Oct-15 (in house check Oct-22)	In house check: Oct-24
Power sensor HP 8481A	SN: MY41093315	07-Oct-15 (in house check Oct-22)	In house check: Oct-24
RF generator R&S SMT-06	SN: 100972	15-Jun-15 (in house check Oct-22)	In house check: Oct-24
Network Analyzer Agilent E8358A	SN: US41080477	31-Mar-14 (in house check Oct-22)	In house check: Oct-24

Calibrated by: **Paulo Pina**      Name: Paulo Pina      Function: Laboratory Technician

Approved by: **Niels Kuster**      Name: Niels Kuster      Function: Quality Manager

Signature

Issued: February 22, 2023

This calibration certificate shall not be reproduced except in full without written approval of the laboratory.



Accredited by the Swiss Accreditation Service (SAS)

The Swiss Accreditation Service is one of the signatories to the EA  
Multilateral Agreement for the recognition of calibration certificates

Accreditation No.: **SCS 0108**

### Glossary:

TSL	tissue simulating liquid
ConvF	sensitivity in TSL / NORM x,y,z
N/A	not applicable or not measured

### Calibration is Performed According to the Following Standards:

- IEC/IEEE 62209-1528, "Measurement Procedure For The Assessment Of Specific Absorption Rate Of Human Exposure To Radio Frequency Fields From Hand-Held And Body-Worn Wireless Communication Devices - Part 1528: Human Models, Instrumentation And Procedures (Frequency Range of 4 MHz to 10 GHz)", October 2020.
- KDB 865664, "SAR Measurement Requirements for 100 MHz to 6 GHz"

### Additional Documentation:

- DASY System Handbook

### Methods Applied and Interpretation of Parameters:

- Measurement Conditions:* Further details are available from the Validation Report at the end of the certificate. All figures stated in the certificate are valid at the frequency indicated.
- Antenna Parameters with TSL:* The source is mounted in a touch configuration below the center marking of the flat phantom.
- Return Loss:* This parameter is measured with the source positioned under the liquid filled phantom (as described in the measurement condition clause). The Return Loss ensures low reflected power. No uncertainty required.
- SAR measured:* SAR measured at the stated antenna input power.
- SAR normalized:* SAR as measured, normalized to an input power of 1 W at the antenna connector.
- SAR for nominal TSL parameters:* The measured TSL parameters are used to calculate the nominal SAR result.

The reported uncertainty of measurement is stated as the standard uncertainty of measurement multiplied by the coverage factor  $k=2$ , which for a normal distribution corresponds to a coverage probability of approximately 95%.



## Measurement Conditions

DASY system configuration, as far as not given on page 1.

<b>DASY Version</b>	DASY52	V52.10.4
<b>Extrapolation</b>	Advanced Extrapolation	
<b>Phantom</b>	Modular Flat Phantom V5.0	
<b>Distance Dipole Center - TSL</b>	10 mm	with Spacer
<b>Zoom Scan Resolution</b>	dx, dy = 4.0 mm, dz = 1.4 mm	Graded Ratio = 1.4 (Z direction)
<b>Frequency</b>	5250 MHz ± 1 MHz 5600 MHz ± 1 MHz 5750 MHz ± 1 MHz 5850 MHz ± 1 MHz	

## Head TSL parameters at 5250 MHz

The following parameters and calculations were applied.

	Temperature	Permittivity	Conductivity
<b>Nominal Head TSL parameters</b>	22.0 °C	35.9	4.71 mho/m
<b>Measured Head TSL parameters</b>	(22.0 ± 0.2) °C	36.0 ± 6 %	4.67 mho/m ± 6 %
<b>Head TSL temperature change during test</b>	< 0.5 °C	----	----

## SAR result with Head TSL at 5250 MHz

<b>SAR averaged over 1 cm<sup>3</sup> (1 g) of Head TSL</b>	Condition	
SAR measured	100 mW input power	8.03 W/kg
SAR for nominal Head TSL parameters	normalized to 1W	<b>80.3 W/kg ± 19.9 % (k=2)</b>

<b>SAR averaged over 10 cm<sup>3</sup> (10 g) of Head TSL</b>	condition	
SAR measured	100 mW input power	2.29 W/kg
SAR for nominal Head TSL parameters	normalized to 1W	<b>22.9 W/kg ± 19.5 % (k=2)</b>

### Head TSL parameters at 5600 MHz

The following parameters and calculations were applied.

	Temperature	Permittivity	Conductivity
Nominal Head TSL parameters	22.0 °C	35.5	5.07 mho/m
Measured Head TSL parameters	(22.0 ± 0.2) °C	35.9 ± 6 %	5.06 mho/m ± 6 %
Head TSL temperature change during test	< 0.5 °C	----	----

### SAR result with Head TSL at 5600 MHz

SAR averaged over 1 cm <sup>3</sup> (1 g) of Head TSL	Condition	
SAR measured	100 mW input power	8.28 W/kg
SAR for nominal Head TSL parameters	normalized to 1W	<b>83.0 W/kg ± 19.9 % (k=2)</b>

SAR averaged over 10 cm <sup>3</sup> (10 g) of Head TSL	condition	
SAR measured	100 mW input power	2.36 W/kg
SAR for nominal Head TSL parameters	normalized to 1W	<b>23.7 W/kg ± 19.5 % (k=2)</b>

### Head TSL parameters at 5750 MHz

The following parameters and calculations were applied.

	Temperature	Permittivity	Conductivity
Nominal Head TSL parameters	22.0 °C	35.4	5.22 mho/m
Measured Head TSL parameters	(22.0 ± 0.2) °C	35.7 ± 6 %	5.17 mho/m ± 6 %
Head TSL temperature change during test	< 0.5 °C	----	----

### SAR result with Head TSL at 5750 MHz

SAR averaged over 1 cm <sup>3</sup> (1 g) of Head TSL	Condition	
SAR measured	100 mW input power	7.92 W/kg
SAR for nominal Head TSL parameters	normalized to 1W	<b>79.3 W/kg ± 19.9 % (k=2)</b>

SAR averaged over 10 cm <sup>3</sup> (10 g) of Head TSL	condition	
SAR measured	100 mW input power	2.24 W/kg
SAR for nominal Head TSL parameters	normalized to 1W	<b>22.4 W/kg ± 19.5 % (k=2)</b>

## Head TSL parameters at 5850 MHz

The following parameters and calculations were applied.

	Temperature	Permittivity	Conductivity
Nominal Head TSL parameters	22.0 °C	35.2	5.32 mho/m
Measured Head TSL parameters	(22.0 ± 0.2) °C	35.4 ± 6 %	5.25 mho/m ± 6 %
Head TSL temperature change during test	< 0.5 °C	----	----

## SAR result with Head TSL at 5850 MHz

SAR averaged over 1 cm <sup>3</sup> (1 g) of Head TSL	Condition	
SAR measured	100 mW input power	8.13 W/kg
SAR for nominal Head TSL parameters	normalized to 1W	<b>81.3 W/kg ± 19.9 % (k=2)</b>

SAR averaged over 10 cm <sup>3</sup> (10 g) of Head TSL	condition	
SAR measured	100 mW input power	2.31 W/kg
SAR for nominal Head TSL parameters	normalized to 1W	<b>23.1 W/kg ± 19.5 % (k=2)</b>

## Appendix (Additional assessments outside the scope of SCS 0108)

### Antenna Parameters with Head TSL at 5250 MHz

Impedance, transformed to feed point	48.6 $\Omega$ - 5.6 j $\Omega$
Return Loss	- 24.7 dB

### Antenna Parameters with Head TSL at 5600 MHz

Impedance, transformed to feed point	55.3 $\Omega$ + 0.9 j $\Omega$
Return Loss	- 25.8 dB

### Antenna Parameters with Head TSL at 5750 MHz

Impedance, transformed to feed point	56.1 $\Omega$ - 2.9 j $\Omega$
Return Loss	- 24.0 dB

### Antenna Parameters with Head TSL at 5850 MHz

Impedance, transformed to feed point	60.4 $\Omega$ - 3.7 j $\Omega$
Return Loss	- 20.1 dB

### General Antenna Parameters and Design

Electrical Delay (one direction)	1.204 ns
----------------------------------	----------

After long term use with 100W radiated power, only a slight warming of the dipole near the feedpoint can be measured.

The dipole is made of standard semirigid coaxial cable. The center conductor of the feeding line is directly connected to the second arm of the dipole. The antenna is therefore short-circuited for DC-signals. On some of the dipoles, small end caps are added to the dipole arms in order to improve matching when loaded according to the position as explained in the "Measurement Conditions" paragraph. The SAR data are not affected by this change. The overall dipole length is still according to the Standard.

No excessive force must be applied to the dipole arms, because they might bend or the soldered connections near the feedpoint may be damaged.

### Additional EUT Data

Manufactured by	SPEAG
-----------------	-------

# DASY5 Validation Report for Head TSL

Date: 22.02.2023

Test Laboratory: SPEAG, Zurich, Switzerland

**DUT: Dipole D5GHzV2; Type: D5GHzV2; Serial: D5GHzV2 - SN:1003**

Communication System: UID 0 - CW; Frequency: 5250 MHz, Frequency: 5600 MHz, Frequency: 5750 MHz, Frequency: 5850 MHz

Medium parameters used:  $f = 5250$  MHz;  $\sigma = 4.67$  S/m;  $\epsilon_r = 36$ ;  $\rho = 1000$  kg/m<sup>3</sup>

Medium parameters used:  $f = 5600$  MHz;  $\sigma = 5.06$  S/m;  $\epsilon_r = 35.9$ ;  $\rho = 1000$  kg/m<sup>3</sup>

Medium parameters used:  $f = 5750$  MHz;  $\sigma = 5.17$  S/m;  $\epsilon_r = 35.7$ ;  $\rho = 1000$  kg/m<sup>3</sup>

Medium parameters used:  $f = 5850$  MHz;  $\sigma = 5.25$  S/m;  $\epsilon_r = 35.4$ ;  $\rho = 1000$  kg/m<sup>3</sup>

Phantom section: Flat Section

Measurement Standard: DASY5 (IEEE/IEC/ANSI C63.19-2011)

DASY52 Configuration:

- Probe: EX3DV4 - SN3503; ConvF(5.5, 5.5, 5.5) @ 5250 MHz, ConvF(5.1, 5.1, 5.1) @ 5600 MHz, ConvF(5.08, 5.08, 5.08) @ 5750 MHz, ConvF(4.99, 4.99, 4.99) @ 5850 MHz; Calibrated: 08.03.2022
- Sensor-Surface: 1.4mm (Mechanical Surface Detection)
- Electronics: DAE4 Sn601; Calibrated: 19.12.2022
- Phantom: Flat Phantom 5.0 (front); Type: QD 000 P50 AA; Serial: 1001
- DASY52 52.10.4(1535); SEMCAD X 14.6.14(7501)

**Dipole Calibration for Head Tissue/Pin=100mW, dist=10mm, f=5250 MHz/Zoom Scan, dist=1.4mm (8x8x7)/Cube 0:** Measurement grid: dx=4mm, dy=4mm, dz=1.4mm

Reference Value = 75.24 V/m; Power Drift = -0.02 dB

Peak SAR (extrapolated) = 27.1 W/kg

**SAR(1 g) = 8.03 W/kg; SAR(10 g) = 2.29 W/kg**

Smallest distance from peaks to all points 3 dB below = 6.8 mm

Ratio of SAR at M2 to SAR at M1 = 70.7%

Maximum value of SAR (measured) = 17.8 W/kg

**Dipole Calibration for Head Tissue/Pin=100mW, dist=10mm, f=5600 MHz/Zoom Scan, dist=1.4mm (8x8x7)/Cube 0:** Measurement grid: dx=4mm, dy=4mm, dz=1.4mm

Reference Value = 74.53 V/m; Power Drift = -0.03 dB

Peak SAR (extrapolated) = 30.4 W/kg

**SAR(1 g) = 8.28 W/kg; SAR(10 g) = 2.36 W/kg**

Smallest distance from peaks to all points 3 dB below = 7.2 mm

Ratio of SAR at M2 to SAR at M1 = 67.8%

Maximum value of SAR (measured) = 18.9 W/kg

**Dipole Calibration for Head Tissue/Pin=100mW, dist=10mm, f=5750 MHz/Zoom Scan,**

**dist=1.4mm (8x8x7)/Cube 0:** Measurement grid: dx=4mm, dy=4mm, dz=1.4mm

Reference Value = 72.42 V/m; Power Drift = -0.03 dB

Peak SAR (extrapolated) = 30.7 W/kg

**SAR(1 g) = 7.92 W/kg; SAR(10 g) = 2.24 W/kg**

Smallest distance from peaks to all points 3 dB below = 7.2 mm

Ratio of SAR at M2 to SAR at M1 = 66%

Maximum value of SAR (measured) = 18.5 W/kg

**Dipole Calibration for Head Tissue/Pin=100mW, dist=10mm, f=5850 MHz/Zoom Scan,**

**dist=1.4mm (8x8x7)/Cube 0:** Measurement grid: dx=4mm, dy=4mm, dz=1.4mm

Reference Value = 72.25 V/m; Power Drift = -0.01 dB

Peak SAR (extrapolated) = 32.4 W/kg

**SAR(1 g) = 8.13 W/kg; SAR(10 g) = 2.31 W/kg**

Smallest distance from peaks to all points 3 dB below = 7.2 mm

Ratio of SAR at M2 to SAR at M1 = 65.2%

Maximum value of SAR (measured) = 19.1 W/kg

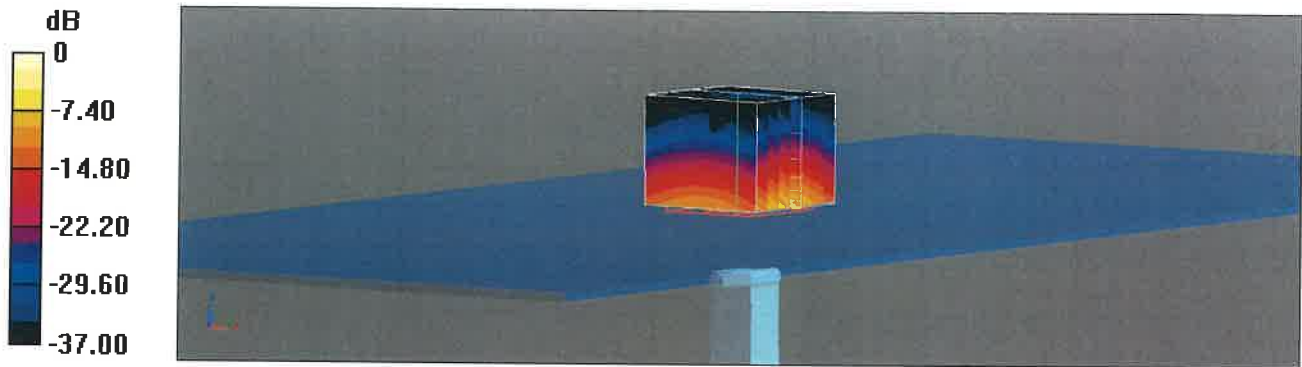

0 dB = 19.1 W/kg = 12.80 dBW/kg

# Impedance Measurement Plot for Head TSL

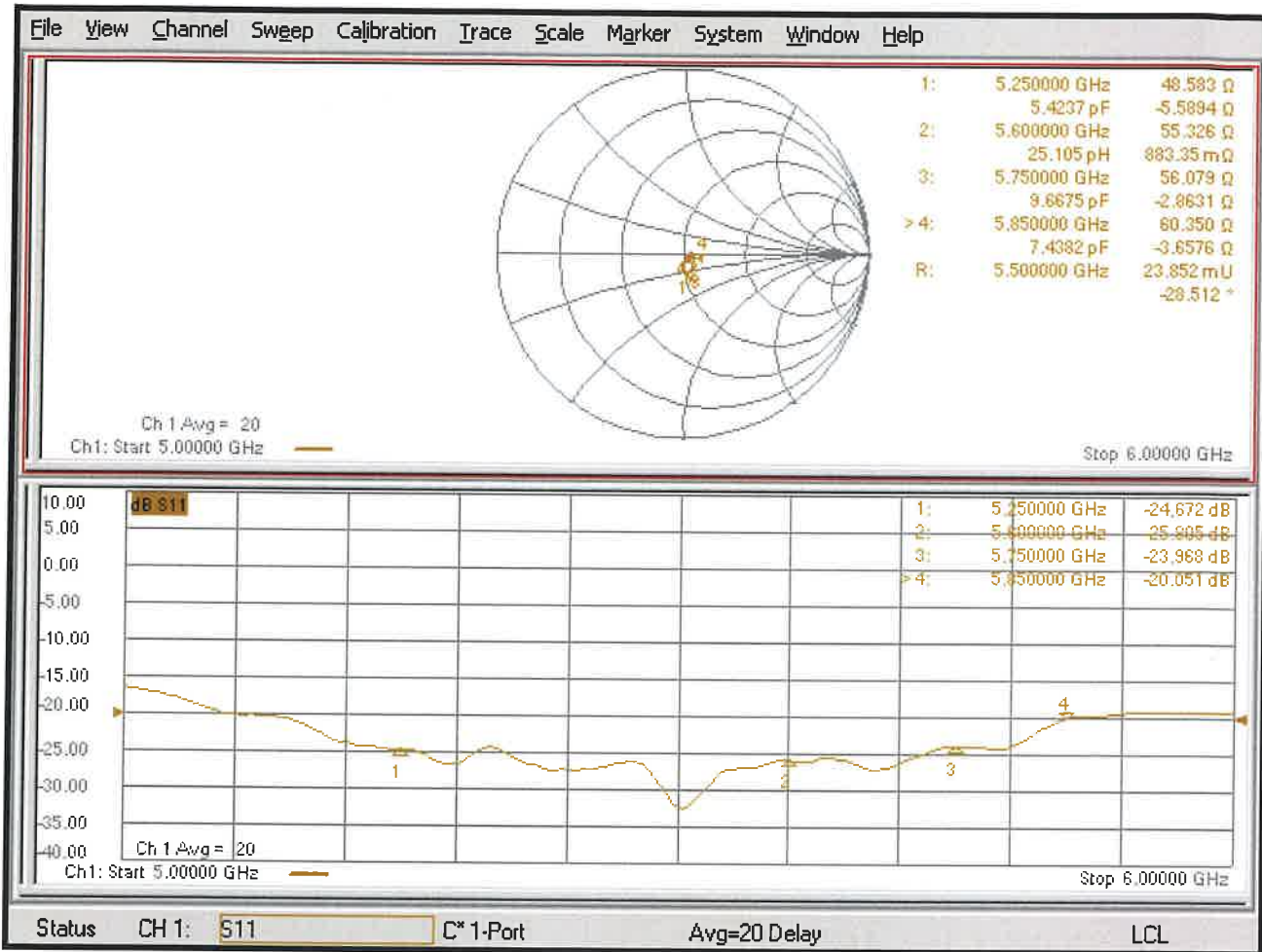



## Dipole Impedance Measurement

Equipment Location	Equipment Name	Model Name	Date of Verification
UL Verification Services Inc. 47173 Benicia Street Fremont, CA 94538, U.S.A.	Dipole Antenna	D5GHzV2-1003	January 01, 2024

Number:	Check List:	Result:
1	Visual Inspection	Pass
2	Return/Loss and Impedance	Pass
3	Dipole Arms	Pass

Equipment List:	
Equipment Name:	Calibration Date:
R&S ZNLE6 Vector Network Analyzer	03/05/2024
ZV-Z135 Calibration Kit	03/27/2024



## Dipole Impedance Measurement

### 1) Photo of Dipole



- The connector of dipole contains no abnormalities.

## Dipole Impedance Measurement

### 2) Impedance and Return/Loss

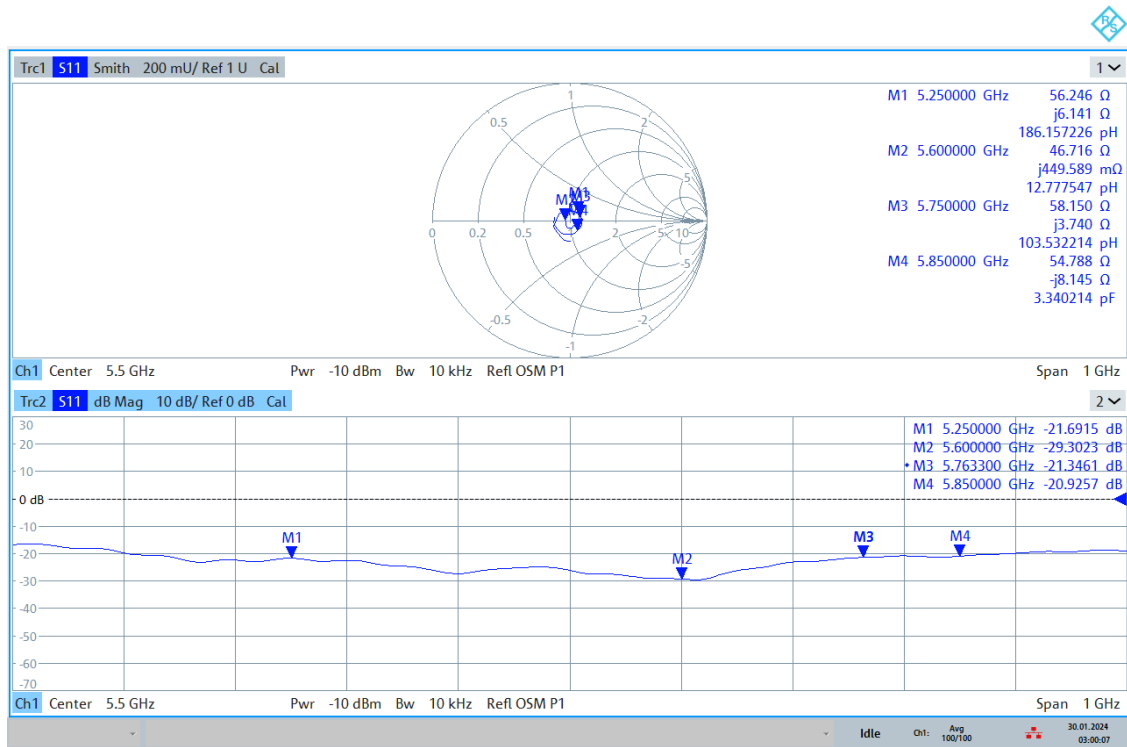

03:00:08 30.01.2024

- Return/Loss is greater than the -20 dB cutoff and Impedance is within 5 Ω of previous value.

## Dipole Impedance Measurement

### 3) Dipole Arms

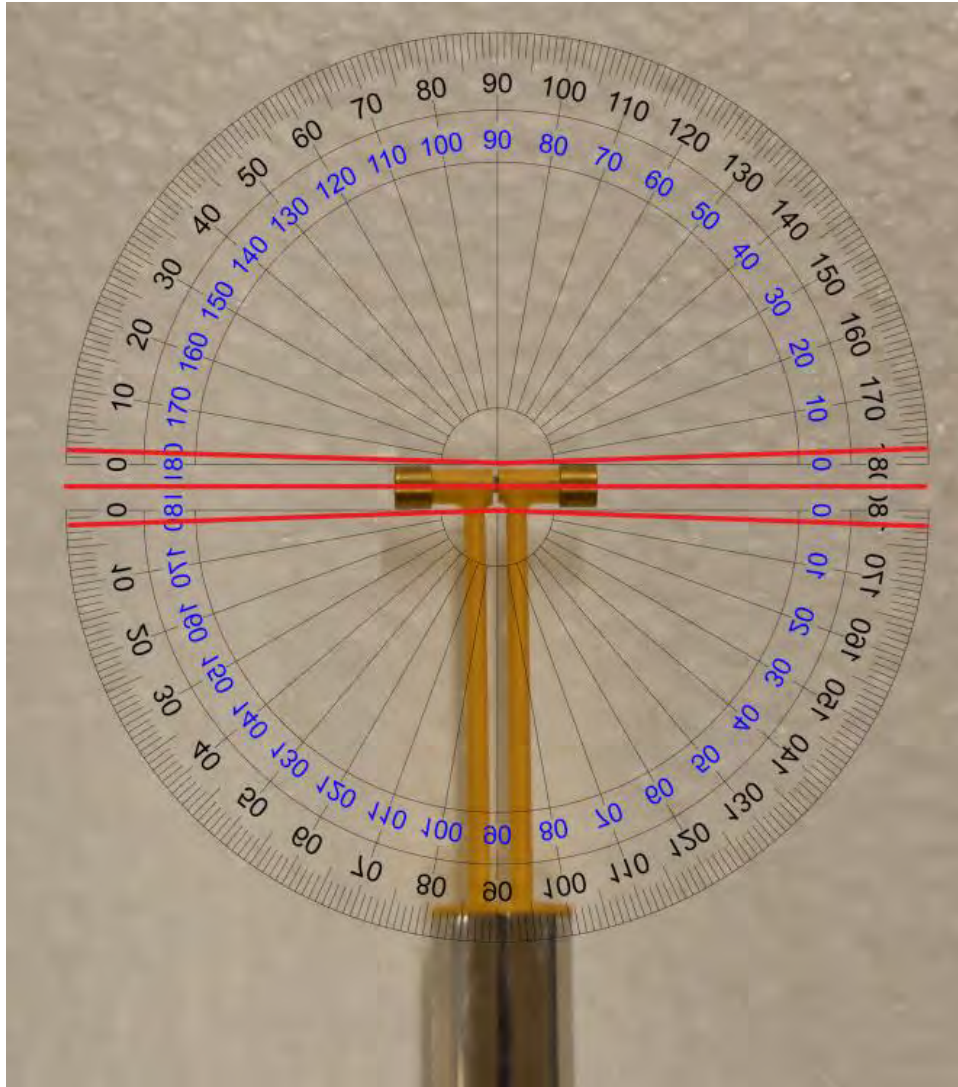

- The center red line indicates that the arms of the dipole fall within  $\pm 2^\circ$



## Dipole Impedance Measurement

Equipment Location	Equipment Name	Model Name	Date of Verification
UL Verification Services Inc. 47173 Benicia Street Fremont, CA 94538, U.S.A.	Dipole Antenna	D5GHzV2-1003	February 3, 2025

Number:	Check List:	Result:
1	Visual Inspection	Pass
2	Return/Loss and Impedance	Pass
3	Dipole Arms	Pass

Equipment List:	
Equipment Name:	Calibration Date:
R&S Vector Network Analyzer	2/13/2024
ZV-Z135 Calibration Kit	3/27/2024

## Dipole Impedance Measurement

### 1) Photo of Dipole



- The connector of dipole contains no abnormalities.

## 2) Impedance and Return/Loss

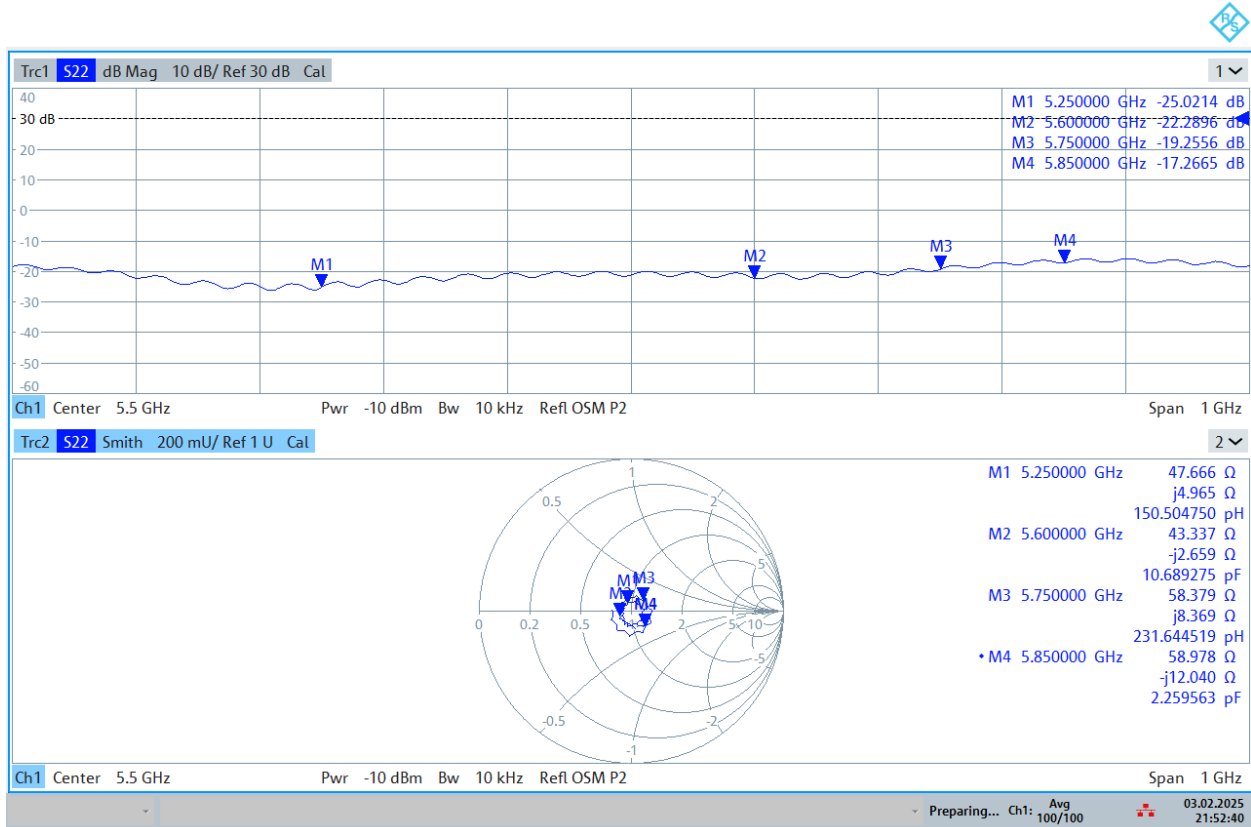

21:52:41 03.02.2025

- Return/Loss is greater than the -20 dB cutoff and Impedance is within 5 Ω of previous value.

## Dipole Impedance Measurement

### 3) Dipole Arms

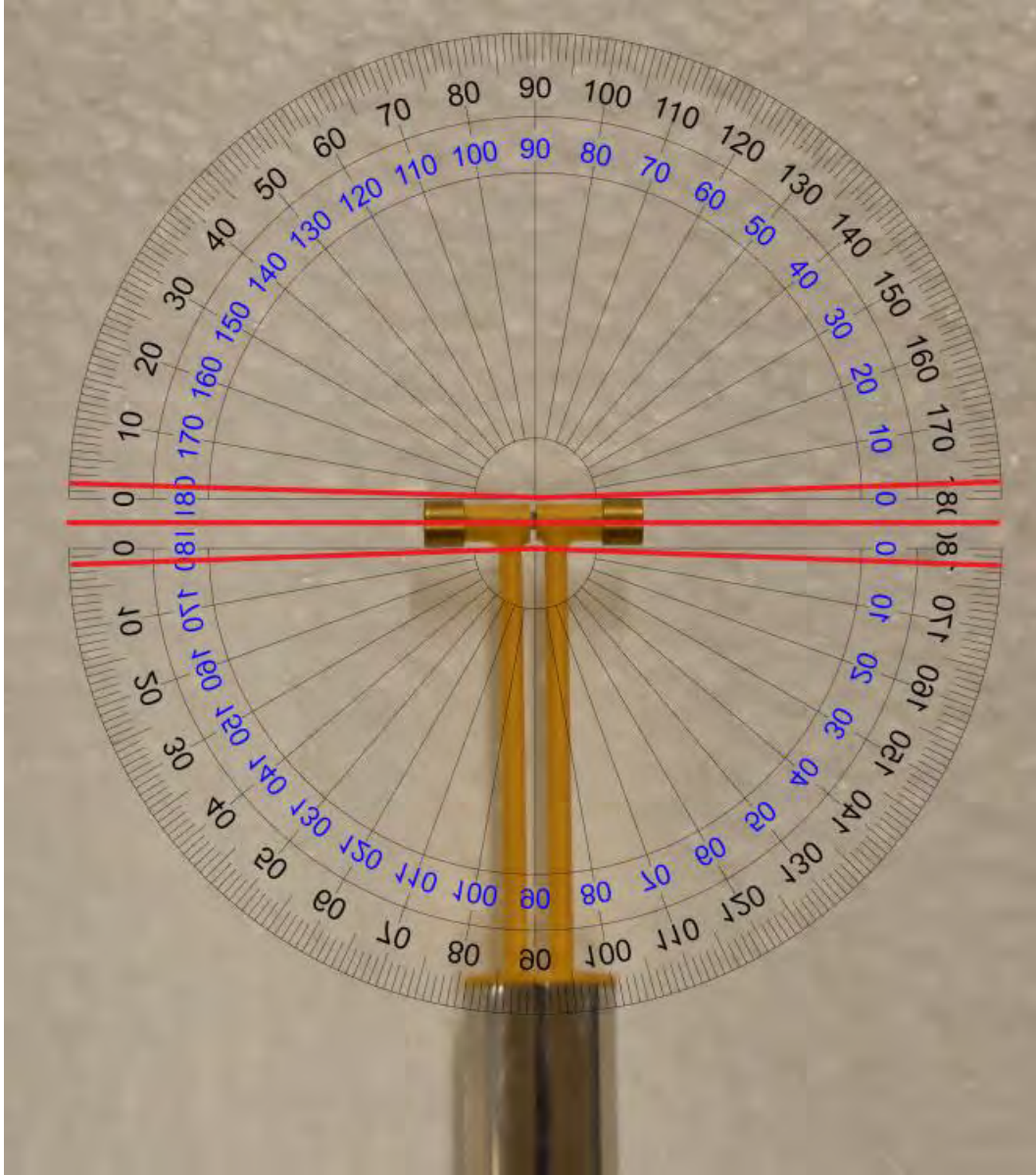

- The center red line indicates that the arms of the dipole fall within  $\pm 2^\circ$



Accredited by the Swiss Accreditation Service (SAS)  
The Swiss Accreditation Service is one of the signatories to the EA  
Multilateral Agreement for the recognition of calibration certificates

Accreditation No.: **SCS 0108**

Client **UL USA**

Certificate No: **D5GHzV2-1138\_Feb23**

**CALIBRATION CERTIFICATE**

Object **D5GHzV2 - SN:1138**

Calibration procedure(s) **QA CAL-22.v7  
Calibration Procedure for SAR Validation Sources between 3-10 GHz**

Calibration date: **February 03, 2023**

This calibration certificate documents the traceability to national standards, which realize the physical units of measurements (SI).  
The measurements and the uncertainties with confidence probability are given on the following pages and are part of the certificate.

All calibrations have been conducted in the closed laboratory facility: environment temperature (22 ± 3)°C and humidity < 70%.

Calibration Equipment used (M&TE critical for calibration)

Primary Standards	ID #	Cal Date (Certificate No.)	Scheduled Calibration
Power meter NRP	SN: 104778	04-Apr-22 (No. 217-03525/03524)	Apr-23
Power sensor NRP-Z91	SN: 103244	04-Apr-22 (No. 217-03524)	Apr-23
Power sensor NRP-Z91	SN: 103245	04-Apr-22 (No. 217-03525)	Apr-23
Reference 20 dB Attenuator	SN: BH9394 (20k)	04-Apr-22 (No. 217-03527)	Apr-23
Type-N mismatch combination	SN: 310982 / 06327	04-Apr-22 (No. 217-03528)	Apr-23
Reference Probe EX3DV4	SN: 3503	08-Mar-22 (No. EX3-3503_Mar22)	Mar-23
DAE4	SN: 601	19-Dec-22 (No. DAE4-601_Dec22)	Dec-23
Secondary Standards	ID #	Check Date (in house)	Scheduled Check
Power meter E4419B	SN: GB39512475	30-Oct-14 (in house check Oct-22)	In house check: Oct-24
Power sensor HP 8481A	SN: US37292783	07-Oct-15 (in house check Oct-22)	In house check: Oct-24
Power sensor HP 8481A	SN: MY41093315	07-Oct-15 (in house check Oct-22)	In house check: Oct-24
RF generator R&S SMT-06	SN: 100972	15-Jun-15 (in house check Oct-22)	In house check: Oct-24
Network Analyzer Agilent E8358A	SN: US41080477	31-Mar-14 (in house check Oct-22)	In house check: Oct-24

Calibrated by: **Paulo Pina** (Name), **Laboratory Technician** (Function), *[Signature]* (Signature)

Approved by: **Sven Kühn** (Name), **Technical Manager** (Function), *[Signature]* (Signature)

Issued: February 7, 2023

This calibration certificate shall not be reproduced except in full without written approval of the laboratory.





Accredited by the Swiss Accreditation Service (SAS)

The Swiss Accreditation Service is one of the signatories to the EA Multilateral Agreement for the recognition of calibration certificates

Accreditation No.: **SCS 0108**

**Glossary:**

TSL	tissue simulating liquid
ConvF	sensitivity in TSL / NORM x,y,z
N/A	not applicable or not measured

**Calibration is Performed According to the Following Standards:**

- a) IEC/IEEE 62209-1528, "Measurement Procedure For The Assessment Of Specific Absorption Rate Of Human Exposure To Radio Frequency Fields From Hand-Held And Body-Worn Wireless Communication Devices - Part 1528: Human Models, Instrumentation And Procedures (Frequency Range of 4 MHz to 10 GHz)", October 2020.
- b) KDB 865664, "SAR Measurement Requirements for 100 MHz to 6 GHz"

**Additional Documentation:**

- c) DASY System Handbook

**Methods Applied and Interpretation of Parameters:**

- *Measurement Conditions:* Further details are available from the Validation Report at the end of the certificate. All figures stated in the certificate are valid at the frequency indicated.
- *Antenna Parameters with TSL:* The source is mounted in a touch configuration below the center marking of the flat phantom.
- *Return Loss:* This parameter is measured with the source positioned under the liquid filled phantom (as described in the measurement condition clause). The Return Loss ensures low reflected power. No uncertainty required.
- *SAR measured:* SAR measured at the stated antenna input power.
- *SAR normalized:* SAR as measured, normalized to an input power of 1 W at the antenna connector.
- *SAR for nominal TSL parameters:* The measured TSL parameters are used to calculate the nominal SAR result.

The reported uncertainty of measurement is stated as the standard uncertainty of measurement multiplied by the coverage factor  $k=2$ , which for a normal distribution corresponds to a coverage probability of approximately 95%.

## Measurement Conditions

DASY system configuration, as far as not given on page 1.

<b>DASY Version</b>	DASY52	V52.10.4
<b>Extrapolation</b>	Advanced Extrapolation	
<b>Phantom</b>	Modular Flat Phantom V5.0	
<b>Distance Dipole Center - TSL</b>	10 mm	with Spacer
<b>Zoom Scan Resolution</b>	dx, dy = 4 mm, dz = 1.4 mm	Graded Ratio = 1.4 (Z direction)
<b>Frequency</b>	5250 MHz ± 1 MHz 5600 MHz ± 1 MHz 5750 MHz ± 1 MHz 5850 MHz ± 1 MHz	

## Head TSL parameters at 5250 MHz

The following parameters and calculations were applied.

	Temperature	Permittivity	Conductivity
<b>Nominal Head TSL parameters</b>	22.0 °C	35.9	4.71 mho/m
<b>Measured Head TSL parameters</b>	(22.0 ± 0.2) °C	35.5 ± 6 %	4.70 mho/m ± 6 %
<b>Head TSL temperature change during test</b>	< 0.5 °C	---	---

## SAR result with Head TSL at 5250 MHz

<b>SAR averaged over 1 cm<sup>3</sup> (1 g) of Head TSL</b>	Condition	
SAR measured	100 mW input power	7.97 W/kg
SAR for nominal Head TSL parameters	normalized to 1W	<b>79.5 W/kg ± 19.9 % (k=2)</b>

<b>SAR averaged over 10 cm<sup>3</sup> (10 g) of Head TSL</b>	condition	
SAR measured	100 mW input power	2.27 W/kg
SAR for nominal Head TSL parameters	normalized to 1W	<b>22.6 W/kg ± 19.5 % (k=2)</b>

### Head TSL parameters at 5600 MHz

The following parameters and calculations were applied.

	Temperature	Permittivity	Conductivity
Nominal Head TSL parameters	22.0 °C	35.5	5.07 mho/m
Measured Head TSL parameters	(22.0 ± 0.2) °C	35.4 ± 6 %	5.07 mho/m ± 6 %
Head TSL temperature change during test	< 0.5 °C	----	----

### SAR result with Head TSL at 5600 MHz

SAR averaged over 1 cm <sup>3</sup> (1 g) of Head TSL	Condition	
SAR measured	100 mW input power	8.25 W/kg
SAR for nominal Head TSL parameters	normalized to 1W	<b>82.5 W/kg ± 19.9 % (k=2)</b>

SAR averaged over 10 cm <sup>3</sup> (10 g) of Head TSL	condition	
SAR measured	100 mW input power	2.35 W/kg
SAR for nominal Head TSL parameters	normalized to 1W	<b>23.4 W/kg ± 19.5 % (k=2)</b>

### Head TSL parameters at 5750 MHz

The following parameters and calculations were applied.

	Temperature	Permittivity	Conductivity
Nominal Head TSL parameters	22.0 °C	35.4	5.22 mho/m
Measured Head TSL parameters	(22.0 ± 0.2) °C	35.2 ± 6 %	5.18 mho/m ± 6 %
Head TSL temperature change during test	< 0.5 °C	----	----

### SAR result with Head TSL at 5750 MHz

SAR averaged over 1 cm <sup>3</sup> (1 g) of Head TSL	Condition	
SAR measured	100 mW input power	7.84 W/kg
SAR for nominal Head TSL parameters	normalized to 1W	<b>78.3 W/kg ± 19.9 % (k=2)</b>

SAR averaged over 10 cm <sup>3</sup> (10 g) of Head TSL	condition	
SAR measured	100 mW input power	2.22 W/kg
SAR for nominal Head TSL parameters	normalized to 1W	<b>22.2 W/kg ± 19.5 % (k=2)</b>

### Head TSL parameters at 5850 MHz

The following parameters and calculations were applied.

	Temperature	Permittivity	Conductivity
Nominal Head TSL parameters	22.0 °C	35.2	5.32 mho/m
Measured Head TSL parameters	(22.0 ± 0.2) °C	34.9 ± 6 %	5.27 mho/m ± 6 %
Head TSL temperature change during test	< 0.5 °C	---	---

### SAR result with Head TSL at 5850 MHz

SAR averaged over 1 cm <sup>3</sup> (1 g) of Head TSL	Condition	
SAR measured	100 mW input power	8.02 W/kg
SAR for nominal Head TSL parameters	normalized to 1W	<b>80.1 W/kg ± 19.9 % (k=2)</b>

SAR averaged over 10 cm <sup>3</sup> (10 g) of Head TSL	condition	
SAR measured	100 mW input power	2.28 W/kg
SAR for nominal Head TSL parameters	normalized to 1W	<b>22.7 W/kg ± 19.5 % (k=2)</b>

## Appendix (Additional assessments outside the scope of SCS 0108)

### Antenna Parameters with Head TSL at 5250 MHz

Impedance, transformed to feed point	48.1 $\Omega$ - 4.5 j $\Omega$
Return Loss	- 26.0 dB

### Antenna Parameters with Head TSL at 5600 MHz

Impedance, transformed to feed point	53.7 $\Omega$ + 0.1 j $\Omega$
Return Loss	- 28.9 dB

### Antenna Parameters with Head TSL at 5750 MHz

Impedance, transformed to feed point	56.4 $\Omega$ + 0.3 j $\Omega$
Return Loss	- 24.4 dB

### Antenna Parameters with Head TSL at 5850 MHz

Impedance, transformed to feed point	57.1 $\Omega$ - 1.5 j $\Omega$
Return Loss	- 23.3 dB

### General Antenna Parameters and Design

Electrical Delay (one direction)	1.201 ns
----------------------------------	----------

After long term use with 100W radiated power, only a slight warming of the dipole near the feedpoint can be measured.

The dipole is made of standard semirigid coaxial cable. The center conductor of the feeding line is directly connected to the second arm of the dipole. The antenna is therefore short-circuited for DC-signals. On some of the dipoles, small end caps are added to the dipole arms in order to improve matching when loaded according to the position as explained in the "Measurement Conditions" paragraph. The SAR data are not affected by this change. The overall dipole length is still according to the Standard.

No excessive force must be applied to the dipole arms, because they might bend or the soldered connections near the feedpoint may be damaged.

### Additional EUT Data

Manufactured by	SPEAG
-----------------	-------

Test Laboratory: SPEAG, Zurich, Switzerland

**DUT: Dipole D5GHzV2; Type: D5GHzV2; Serial: D5GHzV2 - SN:1138**

Communication System: UID 0 - CW; Frequency: 5250 MHz, Frequency: 5600 MHz, Frequency: 5750 MHz, Frequency: 5850 MHz

Medium parameters used:  $f = 5250$  MHz;  $\sigma = 4.7$  S/m;  $\epsilon_r = 35.5$ ;  $\rho = 1000$  kg/m<sup>3</sup>

Medium parameters used:  $f = 5600$  MHz;  $\sigma = 5.07$  S/m;  $\epsilon_r = 35.4$ ;  $\rho = 1000$  kg/m<sup>3</sup>

Medium parameters used:  $f = 5750$  MHz;  $\sigma = 5.18$  S/m;  $\epsilon_r = 35.2$ ;  $\rho = 1000$  kg/m<sup>3</sup>

Medium parameters used:  $f = 5850$  MHz;  $\sigma = 5.27$  S/m;  $\epsilon_r = 34.9$ ;  $\rho = 1000$  kg/m<sup>3</sup>

Phantom section: Flat Section

Measurement Standard: DASY5 (IEEE/IEC/ANSI C63.19-2011)

DASY52 Configuration:

- Probe: EX3DV4 - SN3503; ConvF(5.5, 5.5, 5.5) @ 5250 MHz, ConvF(5.1, 5.1, 5.1) @ 5600 MHz, ConvF(5.08, 5.08, 5.08) @ 5750 MHz, ConvF(4.99, 4.99, 4.99) @ 5850 MHz; Calibrated: 08.03.2022
- Sensor-Surface: 1.4mm (Mechanical Surface Detection)
- Electronics: DAE4 Sn601; Calibrated: 19.12.2022
- Phantom: Flat Phantom 5.0 (front); Type: QD 000 P50 AA; Serial: 1001
- DASY52 52.10.4(1535); SEMCAD X 14.6.14(7501)

**Dipole Calibration for Head Tissue/Pin=100mW, dist=10mm, f=5250 MHz/Zoom Scan, dist=1.4mm (8x8x7)/Cube 0:** Measurement grid: dx=4mm, dy=4mm, dz=1.4mm

Reference Value = 75.08 V/m; Power Drift = -0.01 dB

Peak SAR (extrapolated) = 27.2 W/kg

**SAR(1 g) = 7.97 W/kg; SAR(10 g) = 2.27 W/kg**

Smallest distance from peaks to all points 3 dB below = 7.2 mm

Ratio of SAR at M2 to SAR at M1 = 71%

Maximum value of SAR (measured) = 18.3 W/kg

**Dipole Calibration for Head Tissue/Pin=100mW, dist=10mm, f=5600 MHz/Zoom Scan, dist=1.4mm (8x8x7)/Cube 0:** Measurement grid: dx=4mm, dy=4mm, dz=1.4mm

Reference Value = 73.91 V/m; Power Drift = -0.01 dB

Peak SAR (extrapolated) = 30.3 W/kg

**SAR(1 g) = 8.25 W/kg; SAR(10 g) = 2.35 W/kg**

Smallest distance from peaks to all points 3 dB below = 7.2 mm

Ratio of SAR at M2 to SAR at M1 = 68.4%

Maximum value of SAR (measured) = 19.3 W/kg

**Dipole Calibration for Head Tissue/Pin=100mW, dist=10mm, f=5750 MHz/Zoom Scan,**

**dist=1.4mm (8x8x7)/Cube 0:** Measurement grid: dx=4mm, dy=4mm, dz=1.4mm

Reference Value = 71.97 V/m; Power Drift = 0.00 dB

Peak SAR (extrapolated) = 30.4 W/kg

**SAR(1 g) = 7.84 W/kg; SAR(10 g) = 2.22 W/kg**

Smallest distance from peaks to all points 3 dB below = 7.2 mm

Ratio of SAR at M2 to SAR at M1 = 66.5%

Maximum value of SAR (measured) = 18.7 W/kg

**Dipole Calibration for Head Tissue/Pin=100mW, dist=10mm, f=5850 MHz/Zoom Scan,**

**dist=1.4mm (8x8x7)/Cube 0:** Measurement grid: dx=4mm, dy=4mm, dz=1.4mm

Reference Value = 71.46 V/m; Power Drift = -0.02 dB

Peak SAR (extrapolated) = 31.7 W/kg

**SAR(1 g) = 8.02 W/kg; SAR(10 g) = 2.28 W/kg**

Smallest distance from peaks to all points 3 dB below = 7.2 mm

Ratio of SAR at M2 to SAR at M1 = 65.6%

Maximum value of SAR (measured) = 19.5 W/kg

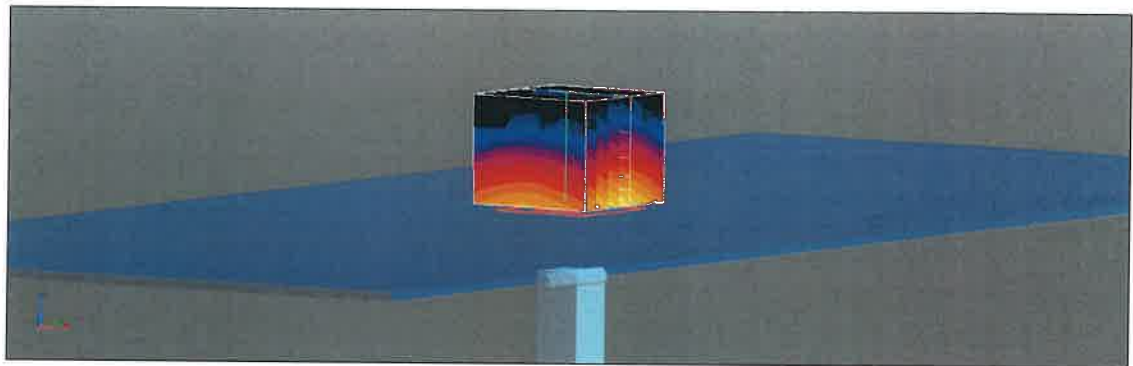
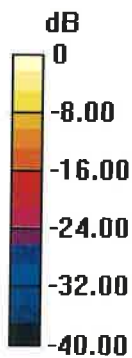

0 dB = 19.5 W/kg = 12.89 dBW/kg

# Impedance Measurement Plot for Head TSL

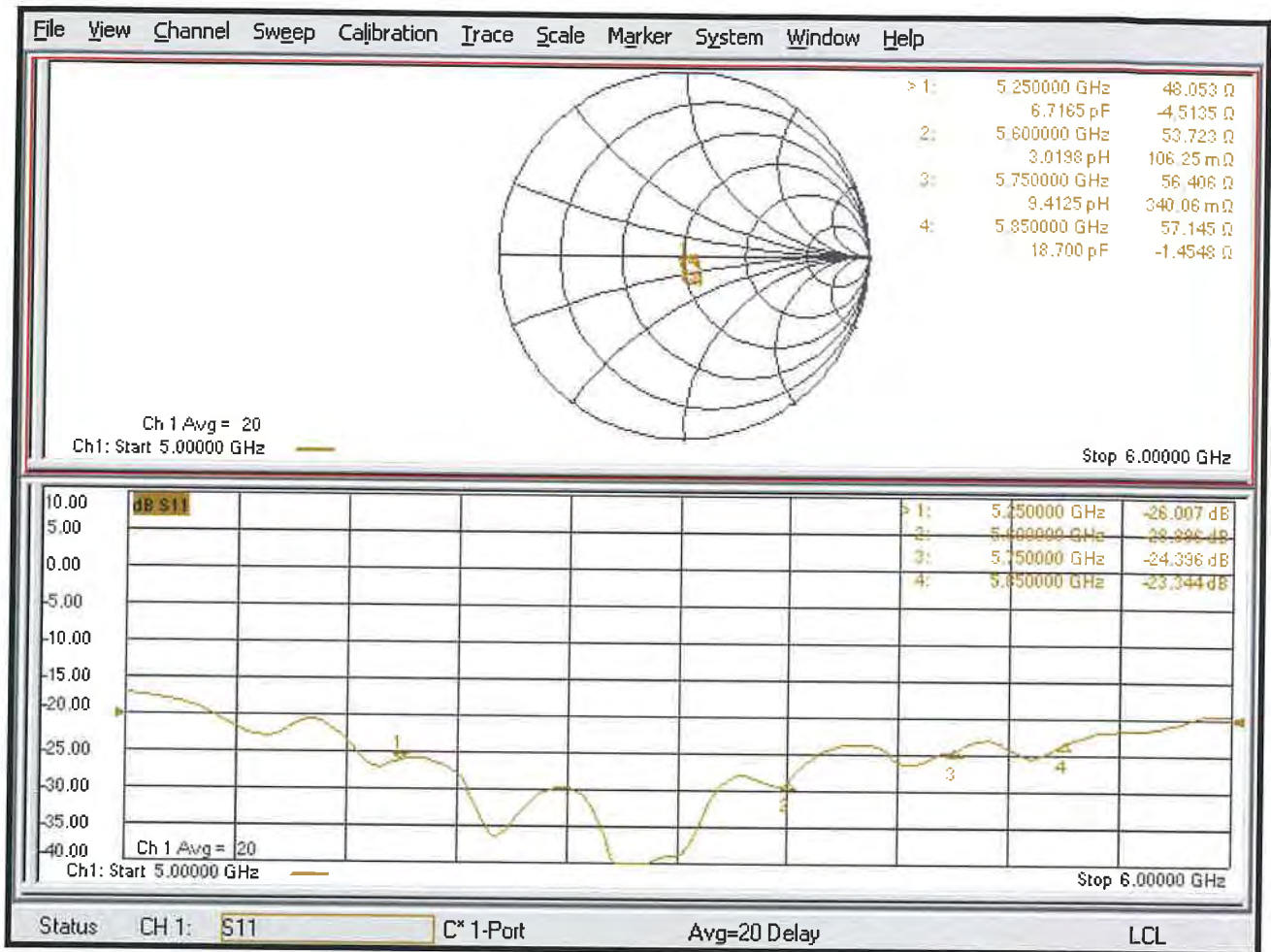





## Dipole Impedance Measurement

Equipment Location	Equipment Name	Model Name	Date of Verification
UL Verification Services Inc. 47173 Benicia Street Fremont, CA 94538, U.S.A.	Dipole Antenna	D5GHzV2-1138	February 6, 2025

Number:	Check List:	Result:
1	Visual Inspection	Pass
2	Return/Loss and Impedance	Pass
3	Dipole Arms	Pass

Equipment List:	
Equipment Name:	Calibration Date:
R&S Vector Network Analyzer	3/5/2024
ZN-Z135 Calibration Kit	5/17/2024

## Dipole Impedance Measurement

### 1) Photo of Dipole



- The connector of dipole contains no abnormalities.

## Dipole Impedance Measurement

### 2) Impedance and Return/Loss

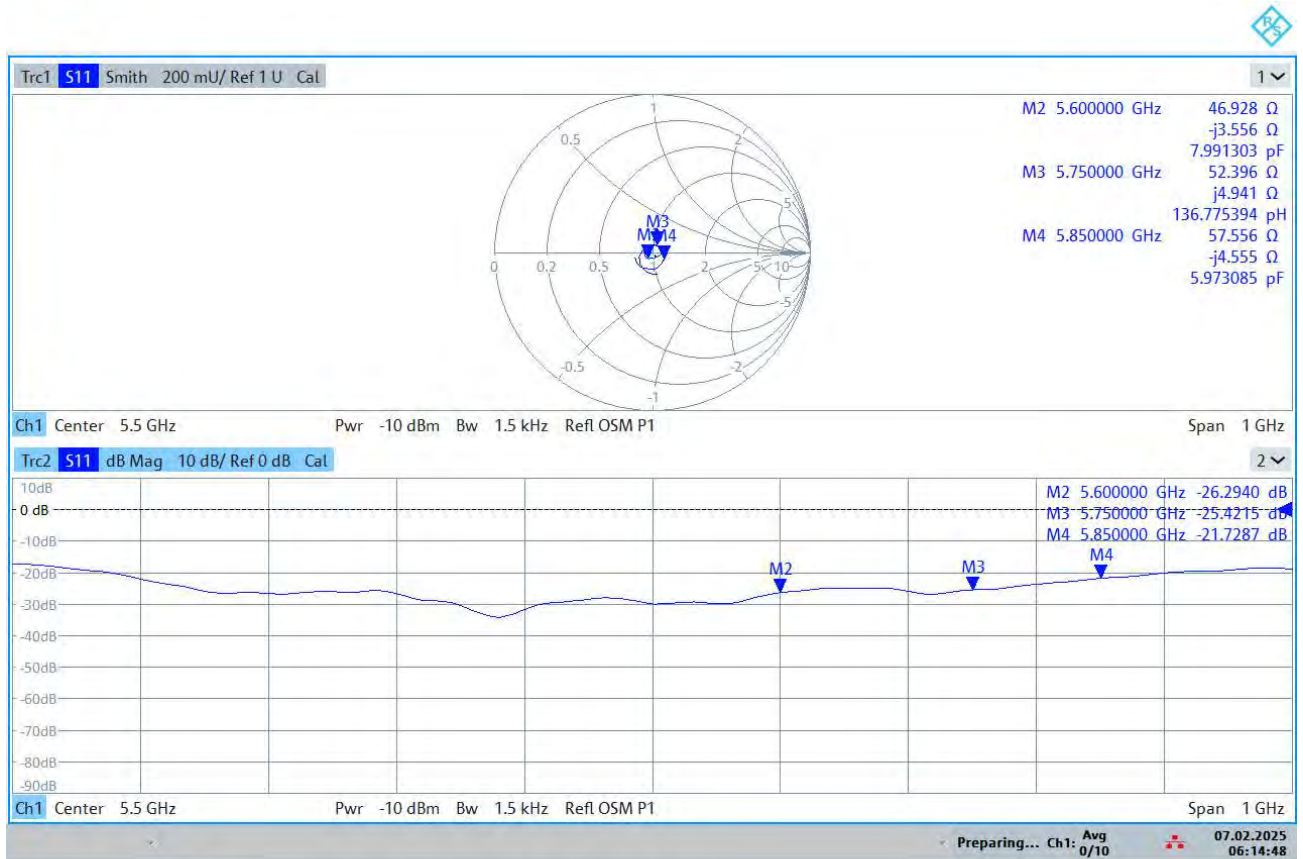

06:14:49 07.02.2025

- Return/Loss is greater than the -20 dB cutoff and Impedance is within 5 Ω of previous value.

## Dipole Impedance Measurement

### 3) Dipole Arms

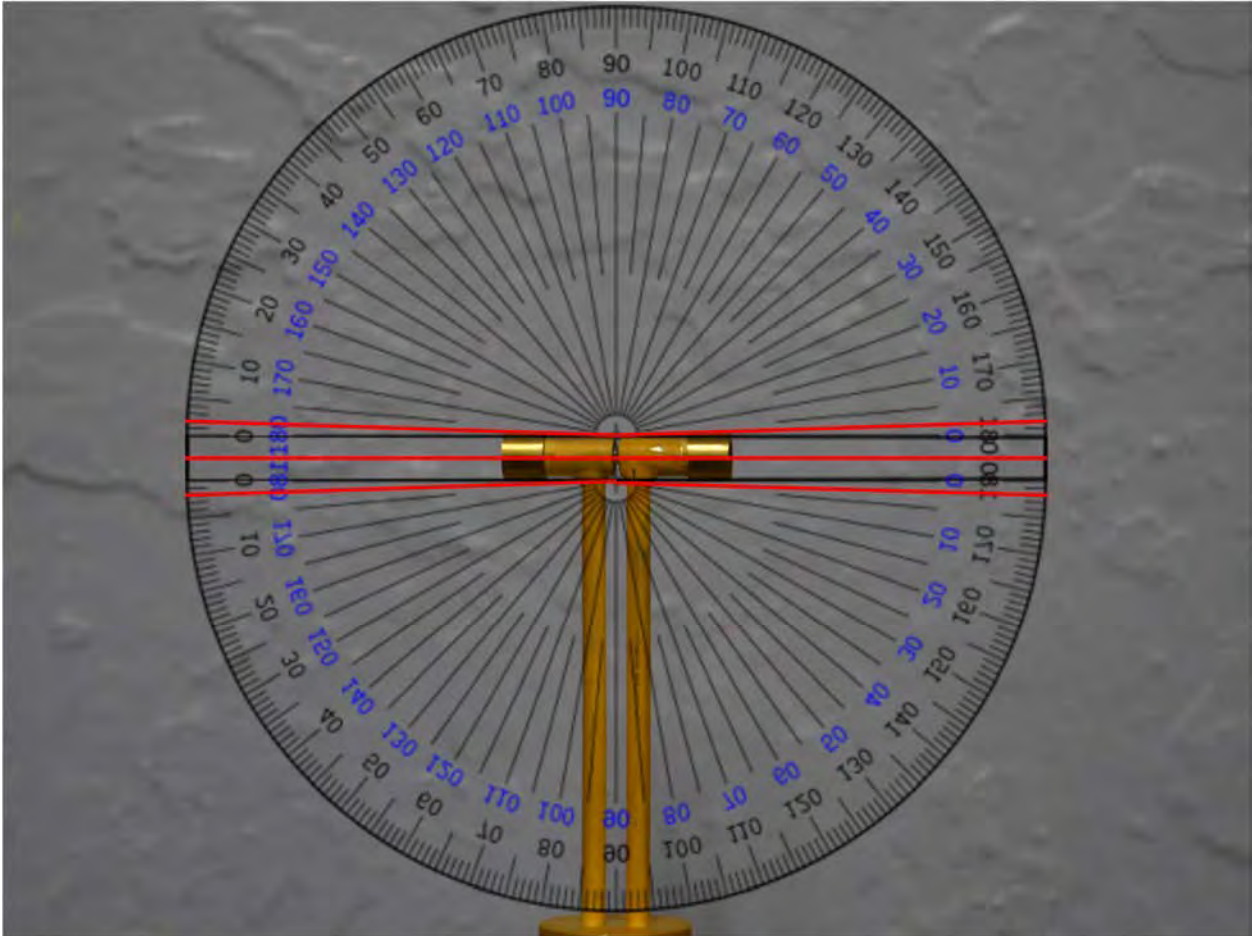

- The center red line indicates that the arms of the dipole fall within  $\pm 2^\circ$



Accredited by the Swiss Accreditation Service (SAS)  
 The Swiss Accreditation Service is one of the signatories to the EA  
 Multilateral Agreement for the recognition of calibration certificates

Accreditation No.: **SCS 0108**

Client **UL**  
**Fremont, USA**

Certificate No. **D5GHzV2-1168\_Feb25**

**CALIBRATION CERTIFICATE**

Object **D5GHzV2 - SN: 1168**

Calibration procedure(s) **QA CAL-22.v7**  
**Calibration Procedure for SAR Validation Sources between 3 - 10 GHz**

Calibration date **February 6, 2025**

This calibration certificate documents the traceability to national standards, which realize the physical units of measurements (SI).  
 The measurements and the uncertainties with confidence probability are given on the following pages and are part of the certificate.  
 All calibrations have been conducted in the closed laboratory facility: environment temperature (22 ± 3)°C and humidity < 70%.  
 Calibration Equipment used (M&TE critical for calibration)

Primary Standards	ID	Cal Date (Certificate No.)	Scheduled Cal
Power Sensor R&S NRP-33T	SN: 100967	28-Mar-24 (No. 217-04038)	Mar-25
Power Sensor R&S NRP18A	SN: 101859	22-Jul-24 (No. 4030A315008547)	Jul-25
Spectrum Analyzer R&S FSV40	SN: 101832	29-Jan-25 (No. 4030A315009658)	Jan-26
Mismatch; Short [S4188] Attenuator [S4423]	SN: 1152	28-Mar-24 (No. 217-04050)	Mar-25
OCP DAK-12	SN: 1016	24-Sept-24 (No. OCP-DAK12-1016_Sep24)	Sep-25
OCP DAK-3.5	SN: 1249	23-Sept-24 (No. OCP-DAK3.5-1249_Sep24)	Sep-25
Reference Probe EX3DV4	SN: 7349	10-Jan-25 (No. EX3-7349_Jan25)	Jan-26
DAE4ip	SN: 1836	28-Oct-24 (No. DAE4ip-1836_Oct24)	Oct-25

Secondary Standards	ID	Check Date (in house)	Scheduled Check
ACAD Source Box	SN: 1000	28-May-24 (No. 675-ACAD_Source_Box-240528)	May-25
Signal Generator R&S SMB100A	SN: 182081	28-May-24 (No. 675-CAL16-S4588-240528)	May-25
Mismatch; SMA	SN: 1102	22-May-24 (No. 675-Mismatch_SMA-240522)	May-25

	Name	Function	Signature
Calibrated by	Claudio Leubler	Laboratory Technician	
Approved by	Sven Kühn	Technical Manager	

Issued: February 6, 2025

This calibration certificate shall not be reproduced except in full without written approval of the laboratory.



Accredited by the Swiss Accreditation Service (SAS)  
**The Swiss Accreditation Service is one of the signatories to the EA  
Multilateral Agreement for the recognition of calibration certificates**

Accreditation No.: **SCS 0108**

## Glossary

TSL	tissue simulating liquid
ConvF	sensitivity in TSL / NORM x,y,z
N/A	not applicable or not measured

## Calibration is Performed According to the Following Standards

- IEC/IEEE 62209-1528, "Measurement Procedure For The Assessment Of Specific Absorption Rate Of Human Exposure To Radio Frequency Fields From Hand-Held And Body-Worn Wireless Communication Devices - Part 1528: Human Models, Instrumentation And Procedures (Frequency Range of 4 MHz to 10 GHz)", October 2020.
- KDB 865664, "SAR Measurement Requirements for 100 MHz to 6 GHz"

## Additional Documentation

- DASY System Handbook

## Methods Applied and Interpretation of Parameters

- *Measurement Conditions*: Further details are available from the Validation Report at the end of the certificate. All figures stated in the certificate are valid at the frequency indicated.
- *Antenna Parameters with TSL*: The dipole is mounted with the spacer to position its feed point exactly below the center marking of the flat phantom section, with the arms oriented parallel to the body axis.
- *Feed Point Impedance and Return Loss*: These parameters are measured with the dipole positioned under the liquid filled phantom. The impedance stated is transformed from the measurement at the SMA connector to the feed point. The Return Loss ensures low reflected power. No uncertainty required.
- *Electrical Delay*: One-way delay between the SMA connector and the antenna feed point. No uncertainty required.
- *SAR measured*: SAR measured at the stated antenna input power.
- *SAR normalized*: SAR as measured, normalized to an input power of 1 W at the antenna connector.
- *SAR for nominal TSL parameters*: The measured TSL parameters are used to calculate the nominal SAR result.

The reported uncertainty of measurement is stated as the standard uncertainty of measurement multiplied by the coverage factor  $k=2$ , which for a normal distribution corresponds to a coverage probability of approximately 95%.

## Measurement Conditions

DASY system configuration, as far as not given on page 1.

<b>DASY Version</b>	DASY8 Module SAR	16.4.0
<b>Extrapolation</b>	Advanced Extrapolation	
<b>Phantom</b>	Modular Flat Phantom	
<b>Distance Dipole Center - TSL</b>	10 mm	with spacer
<b>Zoom Scan Resolution</b>	dx, dy = 4mm, dz = 1.4mm	Graded Ratio = 1.4 mm (Z direction)
<b>Frequency</b>	5250MHz ±1MHz 5600MHz ±1MHz 5750MHz ±1MHz 5850MHz ±1MHz	

## Head TSL parameters at 5250 MHz

The following parameters and calculations were applied.

	Temperature	Permittivity	Conductivity
<b>Nominal Head TSL parameters</b>	22.0 °C	35.9	4.71 mho/m
<b>Measured Head TSL parameters</b>	(22.0 ±0.2)°C	35.1 ±6%	4.55 mho/m ±6%
<b>Head TSL temperature change during test</b>	< 0.5 °C		

## SAR result with Head TSL at 5250 MHz

<b>SAR averaged over 1 cm<sup>3</sup> (1 g) of Head TSL</b>	Condition	
SAR for nominal Head TSL parameters	20 dBm input power	8.11 W/kg
SAR for nominal Head TSL parameters	normalized to 1W	81.1 W/kg ±19.9% (k = 2)

<b>SAR averaged over 10 cm<sup>3</sup> (10 g) of Head TSL</b>	Condition	
SAR for nominal Head TSL parameters	20 dBm input power	2.31 W/kg
SAR for nominal Head TSL parameters	normalized to 1W	23.1 W/kg ±19.5% (k = 2)

**Head TSL parameters at 5600 MHz**

The following parameters and calculations were applied.

	Temperature	Permittivity	Conductivity
Nominal Head TSL parameters	22.0 °C	35.5	5.07 mho/m
Measured Head TSL parameters	(22.0 ±0.2)°C	34.4 ±6%	4.92 mho/m ±6%
Head TSL temperature change during test	< 0.5 °C		

**SAR result with Head TSL at 5600 MHz**

SAR averaged over 1 cm <sup>3</sup> (1 g) of Head TSL	Condition	
SAR for nominal Head TSL parameters	20 dBm input power	8.15 W/kg
SAR for nominal Head TSL parameters	normalized to 1W	81.5 W/kg ±19.9% (k = 2)

SAR averaged over 10 cm <sup>3</sup> (10 g) of Head TSL	Condition	
SAR for nominal Head TSL parameters	20 dBm input power	2.34 W/kg
SAR for nominal Head TSL parameters	normalized to 1W	23.4 W/kg ±19.5% (k = 2)

**Head TSL parameters at 5750 MHz**

The following parameters and calculations were applied.

	Temperature	Permittivity	Conductivity
Nominal Head TSL parameters	22.0 °C	35.4	5.22 mho/m
Measured Head TSL parameters	(22.0 ±0.2)°C	34.2 ±6%	5.08 mho/m ±6%
Head TSL temperature change during test	< 0.5 °C		

**SAR result with Head TSL at 5750 MHz**

SAR averaged over 1 cm <sup>3</sup> (1 g) of Head TSL	Condition	
SAR for nominal Head TSL parameters	20 dBm input power	7.94 W/kg
SAR for nominal Head TSL parameters	normalized to 1W	79.4 W/kg ±19.9% (k = 2)

SAR averaged over 10 cm <sup>3</sup> (10 g) of Head TSL	Condition	
SAR for nominal Head TSL parameters	20 dBm input power	2.25 W/kg
SAR for nominal Head TSL parameters	normalized to 1W	22.5 W/kg ±19.5% (k = 2)



### Head TSL parameters at 5850 MHz

The following parameters and calculations were applied.

	Temperature	Permittivity	Conductivity
<b>Nominal Head TSL parameters</b>	22.0 °C	35.2	5.32 mho/m
<b>Measured Head TSL parameters</b>	(22.0 ±0.2)°C	34.1 ±6%	5.18 mho/m ±6%
<b>Head TSL temperature change during test</b>	< 0.5 °C		

### SAR result with Head TSL at 5850 MHz

<b>SAR averaged over 1 cm<sup>3</sup> (1 g) of Head TSL</b>	Condition	
SAR for nominal Head TSL parameters	20 dBm input power	8.13 W/kg
SAR for nominal Head TSL parameters	normalized to 1W	81.3 W/kg ±19.9% (k = 2)

<b>SAR averaged over 10 cm<sup>3</sup> (10 g) of Head TSL</b>	Condition	
SAR for nominal Head TSL parameters	20 dBm input power	2.31 W/kg
SAR for nominal Head TSL parameters	normalized to 1W	23.1 W/kg ±19.5% (k = 2)

**Appendix (Additional assessments outside the scope of SCS 0108)**

**Antenna Parameters with Head TSL at 5250 MHz**

Impedance	48.8 $\Omega$ - 4.4 j $\Omega$
Return Loss	-26.8 dB

**Antenna Parameters with Head TSL at 5600 MHz**

Impedance	52.3 $\Omega$ - 1.7 j $\Omega$
Return Loss	-31.0 dB

**Antenna Parameters with Head TSL at 5750 MHz**

Impedance	58.0 $\Omega$ + 4.1 j $\Omega$
Return Loss	-21.6 dB

**Antenna Parameters with Head TSL at 5850 MHz**

Impedance	55.0 $\Omega$ + 4.2 j $\Omega$
Return Loss	-24.1 dB

**General Antenna Parameters and Design**

Electrical Delay (one direction)	1.189 ns
----------------------------------	----------

After long term use with 100W radiated power, only a slight warming of the dipole near the feedpoint can be measured. The dipole is made of standard semirigid coaxial cable. The center conductor of the feeding line is directly connected to the second arm of the dipole. The antenna is therefore short-circuited for DC-signals. On some of the dipoles, small end caps are added to the dipole arms in order to improve matching when loaded according to the position as explained in the "Measurement Conditions" paragraph. The SAR data are not affected by this change. The overall dipole length is still according to the Standard. No excessive force must be applied to the dipole arms, because they might bend or the soldered connections near the feedpoint may be damaged.

**Additional EUT Data**

Manufactured by	SPEAG
-----------------	-------

### System Performance Check Report

#### Summary

Dipole	Frequency [MHz]	TSL	Power [dBm]
D5GHzV2 - SN1168	5250	HSL	20

#### Exposure Conditions

Phantom Section, TSL	Test Distance [mm]	Band	Group, UID	Frequency [MHz], Channel Number	Conversion Factor	TSL Conductivity [S/m]	TSL Permittivity
Flat	10		CW, 0--	5250, 0	5.68	4.55	35.1

#### Hardware Setup

Phantom	TSL, Measured Date	Probe, Calibration Date	DAE, Calibration Date
MFP V8.0 Center	HSL, 2025-02-06	EX3DV4 - SN7349, 2025-01-10	DAE4ip Sn1 836, 2024-10-28

#### Scans Setup

	Zoom Scan
Grid Extents [mm]	22 x 22 x 22
Grid Steps [mm]	4.0 x 4.0 x 1.4
Sensor Surface [mm]	1.4
Graded Grid	Yes
Grading Ratio	1.4
MAIA	N/A
Surface Detection	VMS + 6p
Scan Method	Measured

#### Measurement Results

	Zoom Scan
Date	2025-02-06
psSAR1g [W/Kg]	8.11
psSAR10g [W/Kg]	2.31
Power Drift [dB]	-0.06
Power Scaling	Disabled
Scaling Factor [dB]	
TSL Correction	Positive / Negative

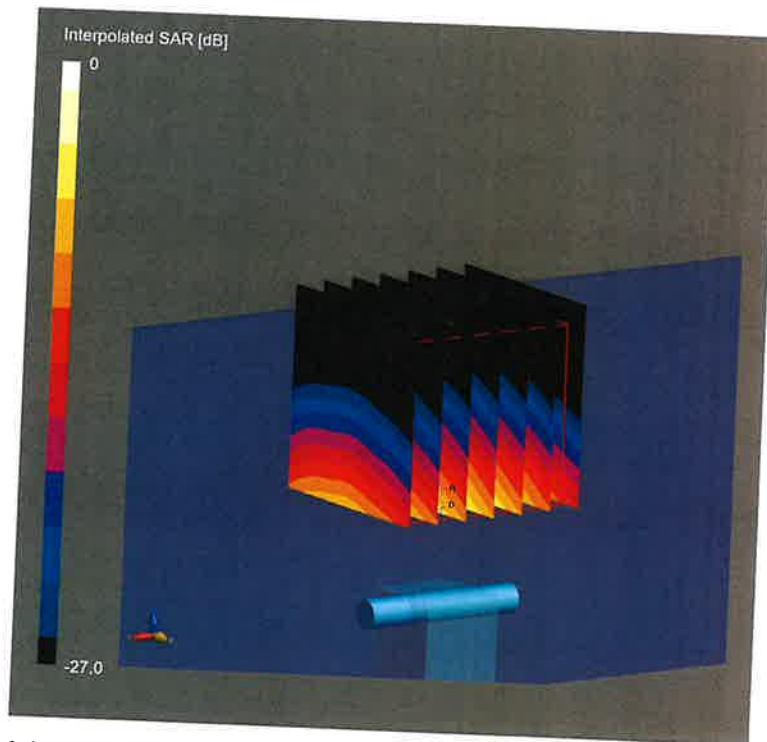

### System Performance Check Report

#### Summary

Dipole	Frequency [MHz]	TSL	Power [dBm]
D5GHzV2 - SN1168	5600	HSL	20

#### Exposure Conditions

Phantom Section, TSL	Test Distance [mm]	Band	Group, UID	Frequency [MHz], Channel Number	Conversion Factor	TSL Conductivity [S/m]	TSL Permittivity
Flat	10	CW, 0--	5600, 0		5.21	4.92	34.4

#### Hardware Setup

Phantom	TSL, Measured Date	Probe, Calibration Date	DAE, Calibration Date
MFP V8.0 Center	HSL, 2025-02-06	EX3DV4 - SN7349, 2025-01-10	DAE4ip Sn1836, 2024-10-28

#### Scans Setup

	Zoom Scan
Grid Extents [mm]	22 x 22 x 22
Grid Steps [mm]	4.0 x 4.0 x 1.4
Sensor Surface [mm]	1.4
Graded Grid	Yes
Grading Ratio	1.4
MAIA	N/A
Surface Detection	VMS + 6p
Scan Method	Measured

#### Measurement Results

Date	Zoom Scan
2025-02-06	
psSAR1g [W/Kg]	8.15
psSAR10g [W/Kg]	2.34
Power Drift [dB]	-0.02
Power Scaling	Disabled
Scaling Factor [dB]	
TSL Correction	Positive / Negative

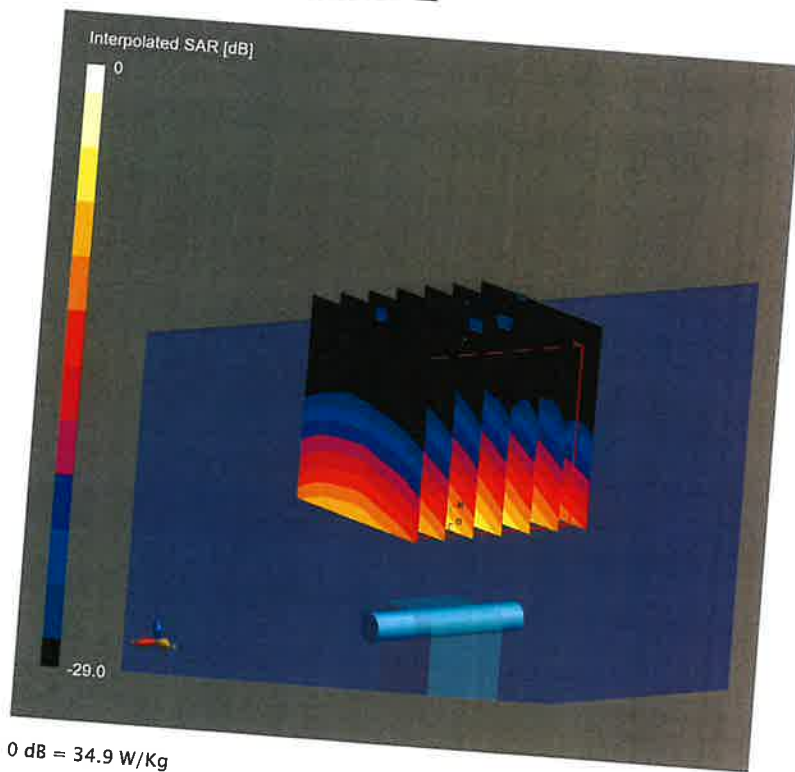

**System Performance Check Report**

**Summary**

Dipole	Frequency [MHz]	TSL	Power [dBm]
D5GHzV2 - SN1168	5750	HSL	20

**Exposure Conditions**

Phantom Section, TSL	Test Distance [mm]	Band	Group, UID	Frequency [MHz], Channel Number	Conversion Factor	TSL Conductivity [S/m]	TSL Permittivity
Flat	10	CW, 0--		5750, 0	5.38	5.08	34.2

**Hardware Setup**

Phantom	TSL, Measured Date	Probe, Calibration Date	DAE, Calibration Date
MFP V8.0 Center	HSL, 2025-02-06	EX3DV4 - SN7349, 2025-01-10	DAE4ip Sn1836, 2024-10-28

**Scans Setup**

	Zoom Scan
Grid Extents [mm]	22 x 22 x 22
Grid Steps [mm]	4.0 x 4.0 x 1.4
Sensor Surface [mm]	1.4
Graded Grid	Yes
Grading Ratio	1.4
MAIA	N/A
Surface Detection	VMS + 6p
Scan Method	Measured

**Measurement Results**

	Zoom Scan
Date	2025-02-06
psSAR1g [W/Kg]	7.94
psSAR10g [W/Kg]	2.25
Power Drift [dB]	0.00
Power Scaling	Disabled
Scaling Factor [dB]	
TSL Correction	Positive / Negative

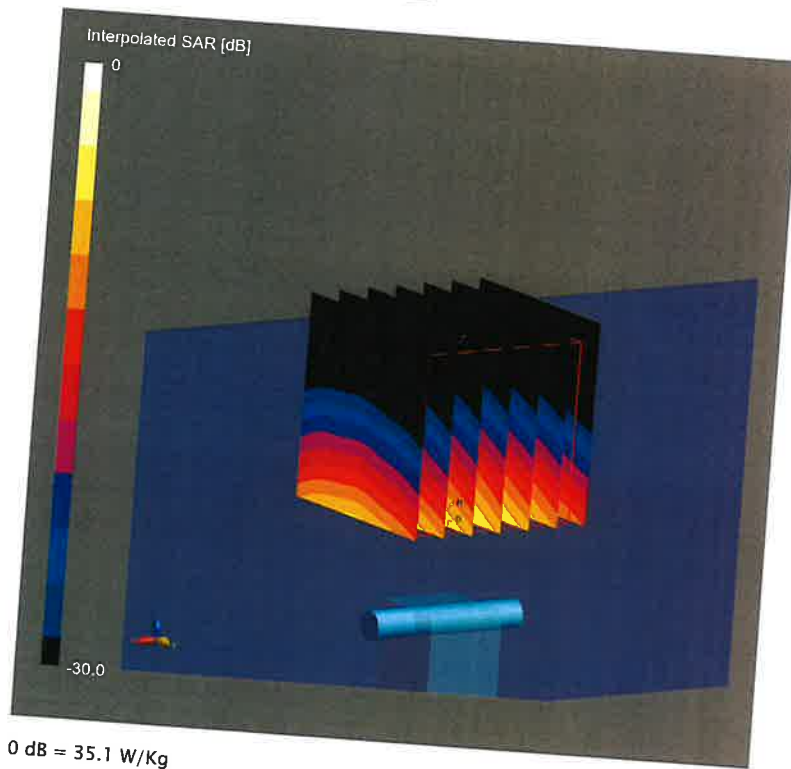

### System Performance Check Report

#### Summary

Dipole	Frequency [MHz]	TSL	Power [dBm]
D5GHzV2 - SN1168	5850	HSL	20

#### Exposure Conditions

Phantom Section, TSL	Test Distance [mm]	Band	Group, UID	Frequency [MHz], Channel Number	Conversion Factor	TSL Conductivity [S/m]	TSL Permittivity
Flat	10	CW, 0--	5850, 0		5.11	5.18	34.1

#### Hardware Setup

Phantom	TSL, Measured Date	Probe, Calibration Date	DAE, Calibration Date
MFP V8.0 Center	HSL, 2025-02-06	EX3DV4 - SN7349, 2025-01-10	DAE4ip Sn1836, 2024-10-28

#### Scans Setup

	Zoom Scan
Grid Extents [mm]	22 x 22 x 22
Grid Steps [mm]	4.0 x 4.0 x 1.4
Sensor Surface [mm]	1.4
Graded Grid	Yes
Grading Ratio	1.4
MAIA	N/A
Surface Detection	VMS + 6p
Scan Method	Measured

#### Measurement Results

	Zoom Scan
Date	2025-02-06
psSAR1g [W/Kg]	8.13
psSAR10g [W/Kg]	2.31
Power Drift [dB]	-0.06
Power Scaling	Disabled
Scaling Factor [dB]	
TSL Correction	Positive / Negative

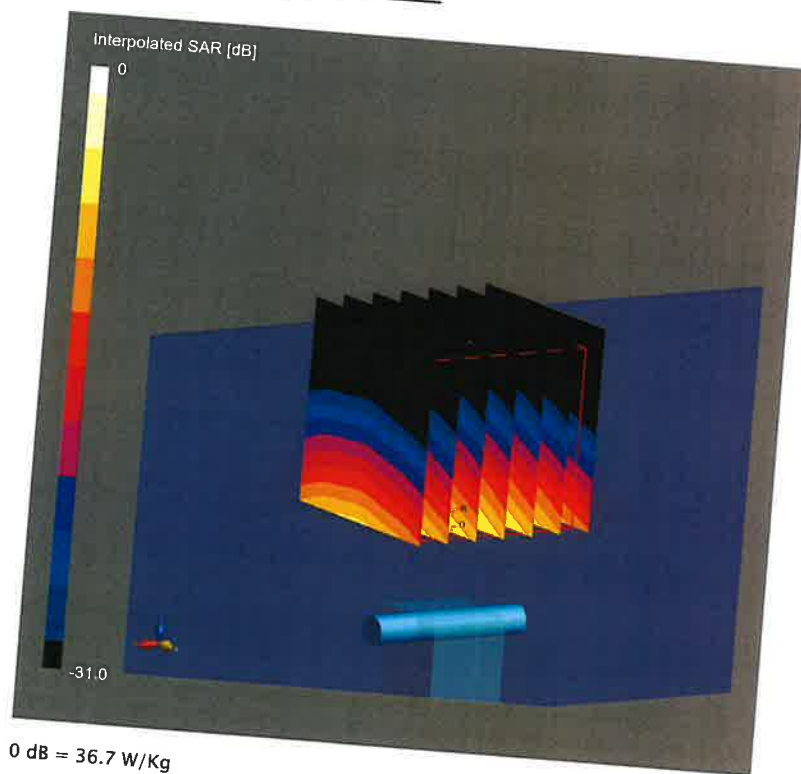

### Impedance Measurement Plot for Head TSL

S11 Smith (R+jX) Scale 1.00

>1	5.250000 GHz	48.798 $\Omega$	-4.369 $j\Omega$
>2	5.600000 GHz	52.336 $\Omega$	-1.699 $j\Omega$
>3	5.750000 GHz	58.000 $\Omega$	4.089 $j\Omega$
>4	5.850000 GHz	55.036 $\Omega$	4.238 $j\Omega$

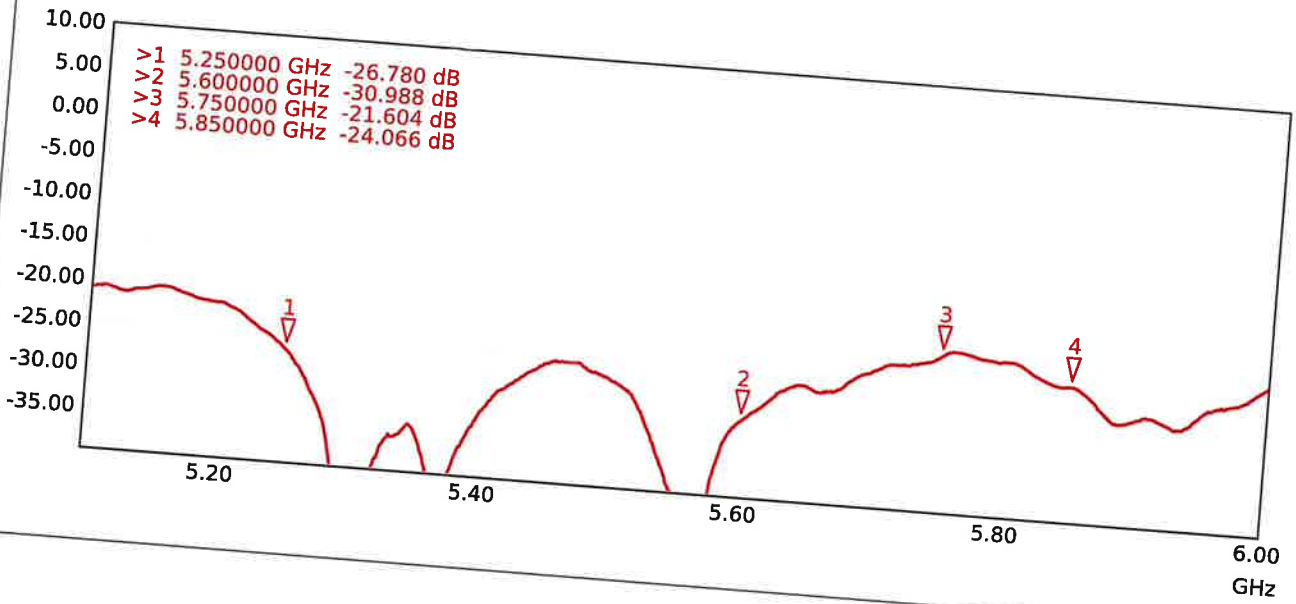
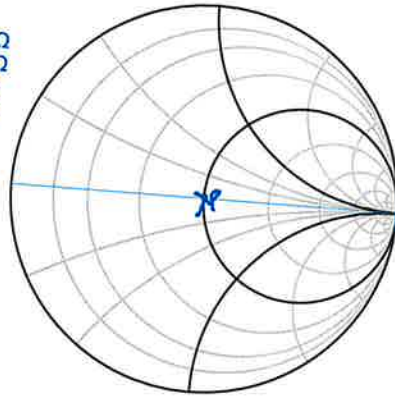



Accredited by the Swiss Accreditation Service (SAS)  
 The Swiss Accreditation Service is one of the signatories to the EA  
 Multilateral Agreement for the recognition of calibration certificates

Accreditation No.: **SCS 0108**

Client **UL**  
**Fremont, USA**

Certificate No. **D6.5GHzV2-1032\_Apr25**

**CALIBRATION CERTIFICATE**

Object **D6.5GHzV2 - SN: 1032**

Calibration procedure(s) **QA CAL-22.v7**  
**Calibration Procedure for SAR Validation Sources between 3 - 10 GHz**

Calibration date **April 14, 2025**

This calibration certificate documents the traceability to national standards, which realize the physical units of measurements (SI).  
 The measurements and the uncertainties with confidence probability are given on the following pages and are part of the certificate.  
 All calibrations have been conducted in the closed laboratory facility: environment temperature (22 ± 3)°C and humidity < 70%.  
 Calibration Equipment used (M&TE critical for calibration)

Primary Standards	ID	Cal Date (Certificate No.)	Scheduled Cal
Power Sensor R&S NRP-33T	SN: 100967	26-Mar-25 (No. 217-04290)	Mar-26
Power Sensor R&S NRP18A	SN: 101859	06-Feb-25 (No. 4030A315009541)	Feb-26
Spectrum Analyzer R&S FSV40	SN: 101832	29-Jan-25 (No. 4030A315009658)	Jan-26
3.5mm mismatch combination	SN: 1152	24-Mar-25 (No. 217-04293)	Mar-26
OCP DAK-12	SN: 1016	24-Sept-24 (No. OCP-DAK12-1016_Sep24)	Sep-25
OCP DAK-3.5	SN: 1249	23-Sept-24 (No. OCP-DAK3.5-1249_Sep24)	Sep-25
Reference Probe EX3DV4	SN: 7349	10-Jan-25 (No. EX3-7349_Jan25)	Jan-26
DAE4ip	SN: 1836	28-Oct-24 (No. DAE4ip-1836_Oct24)	Oct-25

Secondary Standards	ID	Check Date (in house)	Scheduled Check
ACAD Source Box	SN: 1000	28-May-24 (No. 675-ACAD_Source_Box-240528)	May-25
Signal Generator R&S SMB100A	SN: 182081	28-May-24 (No. 675-CAL16-S4588-240528)	May-25
Mismatch; SMA	SN: 1102	22-May-24 (No. 675-Mismatch_SMA-240522)	May-25

	Name	Function	Signature
Calibrated by	Leif Klysner	Laboratory Technician	
Approved by	Sven Kühn	Technical Manager	

Issued: April 15, 2025

This calibration certificate shall not be reproduced except in full without written approval of the laboratory.





Accredited by the Swiss Accreditation Service (SAS)  
**The Swiss Accreditation Service is one of the signatories to the EA  
Multilateral Agreement for the recognition of calibration certificates**

**Accreditation No.: SCS 0108**

## Glossary

TSL tissue simulating liquid  
ConvF sensitivity in TSL / NORM x,y,z  
N/A not applicable or not measured

## Calibration is Performed According to the Following Standards

- IEC/IEEE 62209-1528, "Measurement Procedure For The Assessment Of Specific Absorption Rate Of Human Exposure To Radio Frequency Fields From Hand-Held And Body-Worn Wireless Communication Devices - Part 1528: Human Models, Instrumentation And Procedures (Frequency Range of 4 MHz to 10 GHz)", October 2020.
- KDB 865664, "SAR Measurement Requirements for 100 MHz to 6 GHz"

## Additional Documentation

- DASY System Handbook

## Methods Applied and Interpretation of Parameters

- *Measurement Conditions*: Further details are available from the Validation Report at the end of the certificate. All figures stated in the certificate are valid at the frequency indicated.
- *Antenna Parameters with TSL*: The dipole is mounted with the spacer to position its feed point exactly below the center marking of the flat phantom section, with the arms oriented parallel to the body axis.
- *Feed Point Impedance and Return Loss*: These parameters are measured with the dipole positioned under the liquid filled phantom. The impedance stated is transformed from the measurement at the SMA connector to the feed point. The Return Loss ensures low reflected power. No uncertainty required.
- *Electrical Delay*: One-way delay between the SMA connector and the antenna feed point. No uncertainty required.
- *SAR measured*: SAR measured at the stated antenna input power.
- *SAR normalized*: SAR as measured, normalized to an input power of 1 W at the antenna connector.
- *SAR for nominal TSL parameters*: The measured TSL parameters are used to calculate the nominal SAR result.

The reported uncertainty of measurement is stated as the standard uncertainty of measurement multiplied by the coverage factor  $k=2$ , which for a normal distribution corresponds to a coverage probability of approximately 95%.

## Measurement Conditions

DASY system configuration, as far as not given on page 1.

<b>DASY Version</b>	DASY8 Module SAR	16.4.0
<b>Extrapolation</b>	Advanced Extrapolation	
<b>Phantom</b>	Modular Flat Phantom	
<b>Distance Dipole Center - TSL</b>	5 mm	with spacer
<b>Zoom Scan Resolution</b>	dx, dy = 3.4mm, dz = 1.4mm	Graded Ratio = 1.4 mm (Z direction)
<b>Frequency</b>	6500MHz $\pm$ 1MHz	

## HSL parameters at 6500 MHz

The following parameters and calculations were applied.

	Temperature	Permittivity	Conductivity
<b>Nominal HSL parameters</b>	22.0 °C	34.5	6.07 mho/m
<b>Measured HSL parameters</b>	(22.0 $\pm$ 0.2)°C	35.2 $\pm$ 6%	6.20 mho/m $\pm$ 6%
<b>HSL temperature change during test</b>	< 0.5 °C		

## SAR result with HSL at 6500 MHz

<b>SAR averaged over 1 cm<sup>3</sup> (1 g) of HSL</b>	Condition	
SAR for nominal HSL parameters	20 dBm input power	29.1 W/kg
SAR for nominal HSL parameters	normalized to 1W	291 W/kg $\pm$ 24.7% (k = 2)

<b>SAR averaged over 8 cm<sup>3</sup> (8 g) of HSL</b>	Condition	
SAR for nominal HSL parameters	20 dBm input power	6.58 W/kg
SAR for nominal HSL parameters	normalized to 1W	65.8 W/kg $\pm$ 24.4% (k = 2)

<b>SAR averaged over 10 cm<sup>3</sup> (10 g) of HSL</b>	Condition	
SAR for nominal HSL parameters	20 dBm input power	5.42 W/kg
SAR for nominal HSL parameters	normalized to 1W	54.2 W/kg $\pm$ 24.4% (k = 2)

**Appendix (Additional assessments outside the scope of SCS 0108)****Antenna Parameters with HSL at 6500 MHz**

Impedance	52.5 $\Omega$ – 6.7 j $\Omega$
Return Loss	-23.1 dB

**APD (Absorbed Power Density)**

<b>APD averaged over 1 cm<sup>3</sup></b>	Condition	
APD measured	20 dBm input power	291 W/kg
APD measured	normalized to 1W	2910 W/kg $\pm$ 29.2% (k = 2)

<b>APD averaged over 4 cm<sup>3</sup></b>	Condition	
APD measured	20 dBm input power	132 W/kg
APD measured	normalized to 1W	1320 W/kg $\pm$ 28.9% (k = 2)

\*The reported APD values have been derived using the psSAR1g and psSAR8g.

### General Antenna Parameters and Design

After long term use with 100W radiated power, only a slight warming of the dipole near the feedpoint can be measured. The dipole is made of standard semirigid coaxial cable. The center conductor of the feeding line is directly connected to the second arm of the dipole. The antenna is therefore short-circuited for DC-signals. On some of the dipoles, small end caps are added to the dipole arms in order to improve matching when loaded according to the position as explained in the "Measurement Conditions" paragraph. The SAR data are not affected by this change. The overall dipole length is still according to the Standard. No excessive force must be applied to the dipole arms, because they might bend or the soldered connections near the feedpoint may be damaged.

### Additional EUT Data

Manufactured by	SPEAG
-----------------	-------

**System Performance Check Report**

**Summary**

Dipole	Frequency [MHz]	TSL	Power [dBm]
D6.5GHzV2 - SN1032	6500	HSL	20

**Exposure Conditions**

Phantom Section, TSL	Test Distance [mm]	Band	Group, UID	Frequency [MHz], Channel Number	Conversion Factor	TSL Conductivity [S/m]	TSL Permittivity
Flat	5		CW, 0--	6500, 0	5.49	6.20	35.2

**Hardware Setup**

Phantom	TSL, Measured Date	Probe, Calibration Date	DAE, Calibration Date
MFP V8.0 Center	HSL, 2025-04-14	EX3DV4 - SN7349, 2025-01-10	DAE4ip Sn1836, 2024-10-28

**Scans Setup**

	Zoom Scan
Grid Extents [mm]	22 x 22 x 22
Grid Steps [mm]	3.4 x 3.4 x 1.4
Sensor Surface [mm]	1.4
Graded Grid	Yes
Grading Ratio	1.4
MAIA	N/A
Surface Detection	VMS + 6p
Scan Method	Measured

**Measurement Results**

	Zoom Scan
Date	2025-04-14
psSAR1g [W/Kg]	29.1
psSAR10g [W/Kg]	5.42
Power Drift [dB]	0.01
Power Scaling	Disabled
Scaling Factor [dB]	
TSL Correction	Positive / Negative

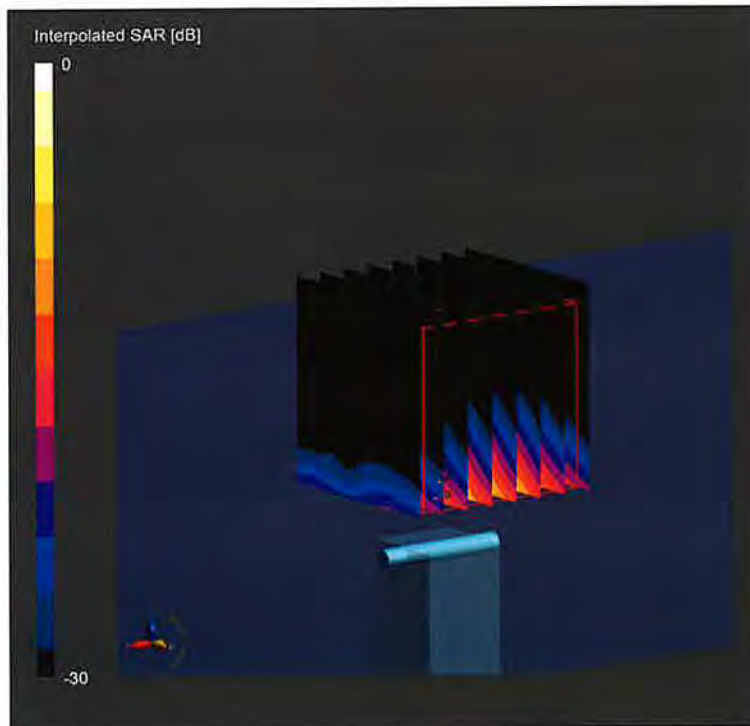

0 dB = 186 W/Kg

### Impedance Measurement Plot for HSL

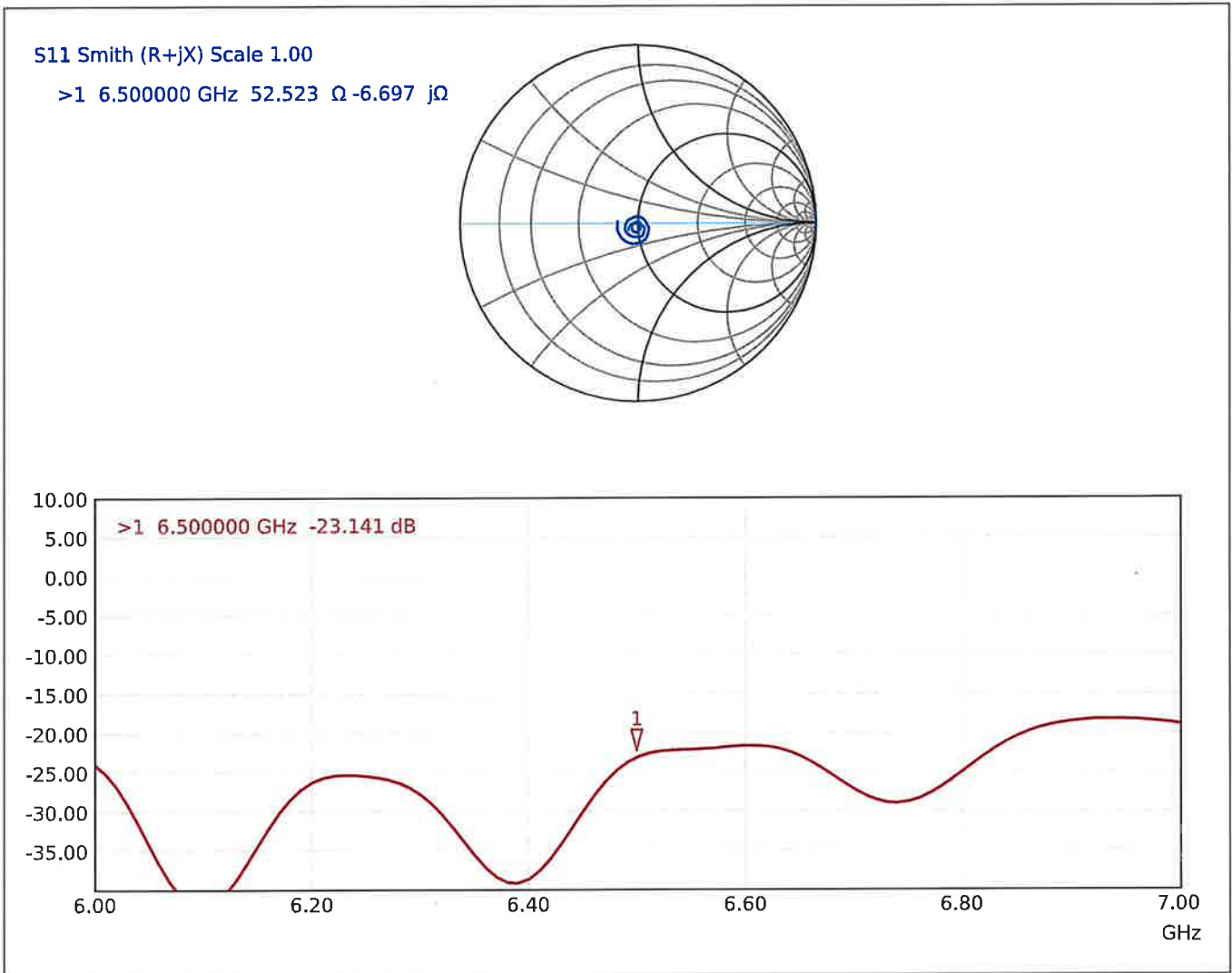



Accredited by the Swiss Accreditation Service (SAS) **Accreditation No.: SCS 0108**

**The Swiss Accreditation Service is one of the signatories to the EA  
Multilateral Agreement for the recognition of calibration certificates**

Client **UL USA**  
**Fremont, USA**

Certificate No: **D6.5GHzV2-1033\_Mar23**

## CALIBRATION CERTIFICATE

Object **D6.5GHzV2 - SN:1033**

Calibration procedure(s) **QA CAL-22.v7  
Calibration Procedure for SAR Validation Sources between 3-10 GHz**

Calibration date: **March 15, 2023**

This calibration certificate documents the traceability to national standards, which realize the physical units of measurements (SI).  
The measurements and the uncertainties with confidence probability are given on the following pages and are part of the certificate.

All calibrations have been conducted in the closed laboratory facility: environment temperature (22 ± 3)°C and humidity < 70%.

Calibration Equipment used (M&TE critical for calibration)

Primary Standards	ID #	Cal Date (Certificate No.)	Scheduled Calibration
Power sensor R&S NRP33T	SN: 100967	01-Apr-22 (No. 217-03526)	Apr-23
Reference 20 dB Attenuator	SN: BH9394 (20k)	04-Apr-22 (No. 217-03527)	Apr-23
Mismatch combination	SN: 84224 / 360D	26-Apr-22 (No. 217-03545)	Apr-23
Reference Probe EX3DV4	SN: 7405	02-Jun-22 (No. EX3-7405_Jun22)	Jun-23
DAE4	SN: 908	27-Jun-22 (No. DAE4-908_Jun22)	Jun-23

Secondary Standards	ID #	Check Date (in house)	Scheduled Check
RF generator Anapico APSIN20G	SN: 827	18-Dec-18 (in house check Dec-21)	In house check: Dec-23
Network Analyzer Keysight E5063A	SN:MY54504221	31-Oct-19 (in house check Oct-22)	In house check: Oct-25

Calibrated by:	Name <b>Leif Klysner</b>	Function <b>Laboratory Technician</b>	Signature 
Approved by:	Name <b>Sven Kühn</b>	Function <b>Technical Manager</b>	

Issued: March 16, 2023

This calibration certificate shall not be reproduced except in full without written approval of the laboratory.



Accredited by the Swiss Accreditation Service (SAS)

The Swiss Accreditation Service is one of the signatories to the EA  
Multilateral Agreement for the recognition of calibration certificates

Accreditation No.: **SCS 0108**

### Glossary:

TSL	tissue simulating liquid
ConvF	sensitivity in TSL / NORM x,y,z
N/A	not applicable or not measured

### Calibration is Performed According to the Following Standards:

- a) IEC/IEEE 62209-1528, "Measurement Procedure For The Assessment Of Specific Absorption Rate Of Human Exposure To Radio Frequency Fields From Hand-Held And Body-Worn Wireless Communication Devices - Part 1528: Human Models, Instrumentation And Procedures (Frequency Range Of 4 MHz To 10 GHz)", October 2020.

### Additional Documentation:

- b) DASY System Handbook

### Methods Applied and Interpretation of Parameters:

- *Measurement Conditions:* Further details are available from the Validation Report at the end of the certificate. All figures stated in the certificate are valid at the frequency indicated.
- *Antenna Parameters with TSL:* The dipole is mounted with the spacer to position its feed point exactly below the center marking of the flat phantom section, with the arms oriented parallel to the body axis.
- *Feed Point Impedance and Return Loss:* These parameters are measured with the dipole positioned under the liquid filled phantom. The impedance stated is transformed from the measurement at the SMA connector to the feed point. The Return Loss ensures low reflected power. No uncertainty required.
- *SAR measured:* SAR measured at the stated antenna input power.
- *SAR normalized:* SAR as measured, normalized to an input power of 1 W at the antenna connector.
- *SAR for nominal TSL parameters:* The measured TSL parameters are used to calculate the nominal SAR result.
- *The absorbed power density (APD):* The absorbed power density is evaluated according to Samaras T, Christ A, Kuster N, "Compliance assessment of the epithelial or absorbed power density above 6 GHz using SAR measurement systems", Bioelectromagnetics, 2021 (submitted). The additional evaluation uncertainty of 0.55 dB (rectangular distribution) is considered.

The reported uncertainty of measurement is stated as the standard uncertainty of measurement multiplied by the coverage factor  $k=2$ , which for a normal distribution corresponds to a coverage probability of approximately 95%.



## Measurement Conditions

DASY system configuration, as far as not given on page 1.

<b>DASY Version</b>	DASY6	V16.2
<b>Extrapolation</b>	Advanced Extrapolation	
<b>Phantom</b>	Modular Flat Phantom	
<b>Distance Dipole Center - TSL</b>	5 mm	with Spacer
<b>Zoom Scan Resolution</b>	dx, dy = 3.4 mm, dz = 1.4 mm	Graded Ratio = 1.4 (Z direction)
<b>Frequency</b>	6500 MHz $\pm$ 1 MHz	

## Head TSL parameters

The following parameters and calculations were applied.

	Temperature	Permittivity	Conductivity
<b>Nominal Head TSL parameters</b>	22.0 °C	34.5	6.07 mho/m
<b>Measured Head TSL parameters</b>	(22.0 $\pm$ 0.2) °C	34.3 $\pm$ 6 %	6.02 mho/m $\pm$ 6 %
<b>Head TSL temperature change during test</b>	< 0.5 °C	----	----

## SAR result with Head TSL

<b>SAR averaged over 1 cm<sup>3</sup> (1 g) of Head TSL</b>	Condition	
SAR measured	100 mW input power	28.9 W/kg
SAR for nominal Head TSL parameters	normalized to 1W	<b>288 W/kg <math>\pm</math> 24.7 % (k=2)</b>

<b>SAR averaged over 8 cm<sup>3</sup> (8 g) of Head TSL</b>	Condition	
SAR measured	100 mW input power	6.48 W/kg
SAR for nominal Head TSL parameters	normalized to 1W	<b>64.7 W/kg <math>\pm</math> 24.4 % (k=2)</b>

<b>SAR averaged over 10 cm<sup>3</sup> (10 g) of Head TSL</b>	condition	
SAR measured	100 mW input power	5.31 W/kg
SAR for nominal Head TSL parameters	normalized to 1W	<b>53.1 W/kg <math>\pm</math> 24.4 % (k=2)</b>

## Appendix

### Antenna Parameters with Head TSL

Impedance, transformed to feed point	49.2 $\Omega$ - 3.4 $j\Omega$
Return Loss	- 29.0 dB

### APD (Absorbed Power Density)

APD averaged over 1 cm <sup>2</sup>	Condition	
APD measured	100 mW input power	288 W/m <sup>2</sup>
APD measured	normalized to 1W	<b>2880 W/m<sup>2</sup> <math>\pm</math> 29.2 % (k=2)</b>

APD averaged over 4 cm <sup>2</sup>	condition	
APD measured	100 mW input power	130 W/m <sup>2</sup>
APD measured	normalized to 1W	<b>1300 W/m<sup>2</sup> <math>\pm</math> 28.9 % (k=2)</b>

\*The reported APD values have been derived using the psSAR1g and psSAR8g.

### General Antenna Parameters and Design

After long term use with 100W radiated power, only a slight warming of the dipole near the feedpoint can be measured.

The dipole is made of standard semirigid coaxial cable. The center conductor of the feeding line is directly connected to the second arm of the dipole. The antenna is therefore short-circuited for DC-signals. On some of the dipoles, small end caps are added to the dipole arms in order to improve matching when loaded according to the position as explained in the "Measurement Conditions" paragraph. The SAR data are not affected by this change. The overall dipole length is still according to the Standard.

No excessive force must be applied to the dipole arms, because they might bend or the soldered connections near the feedpoint may be damaged.

### Additional EUT Data

Manufactured by	SPEAG
-----------------	-------

# DASY6 Validation Report for Head TSL

Measurement Report for D6.5GHz-1033, UID 0 -, Channel 6500 (6500.0MHz)

## Device under Test Properties

Name, Manufacturer	Dimensions [mm]	IMEI	DUT Type
D6.5GHz	16.0 x 6.0 x 300.0	SN: 1033	-

## Exposure Conditions

Phantom Section, TSL	Position, Test Distance [mm]	Band	Group, UID	Frequency [MHz]	Conversion Factor	TSL Cond. [S/m]	TSL Permittivity
Flat, HSL	5.00	Band	CW,	6500	5.50	6.02	34.3

## Hardware Setup

Phantom	TSL	Probe, Calibration Date	DAE, Calibration Date
MFP V8.0 Center - 1182	HBBL600-10000V6	EX3DV4 - SN7405, 2022-06-02	DAE4 Sn908, 2022-06-27

## Scan Setup

	Zoom Scan
Grid Extents [mm]	22.0 x 22.0 x 22.0
Grid Steps [mm]	3.4 x 3.4 x 1.4
Sensor Surface [mm]	1.4
Graded Grid	Yes
Grading Ratio	1.4
MAIA	N/A
Surface Detection	VMS + 6p
Scan Method	Measured

## Measurement Results

	Zoom Scan
Date	2023-03-15, 12:39
psSAR1g [W/Kg]	28.9
psSAR8g [W/Kg]	6.48
psSAR10g [W/Kg]	5.31
Power Drift [dB]	0.01
Power Scaling	Disabled
Scaling Factor [dB]	
TSL Correction	No correction
M2/M1 [%]	55.2
Dist 3dB Peak [mm]	4.7

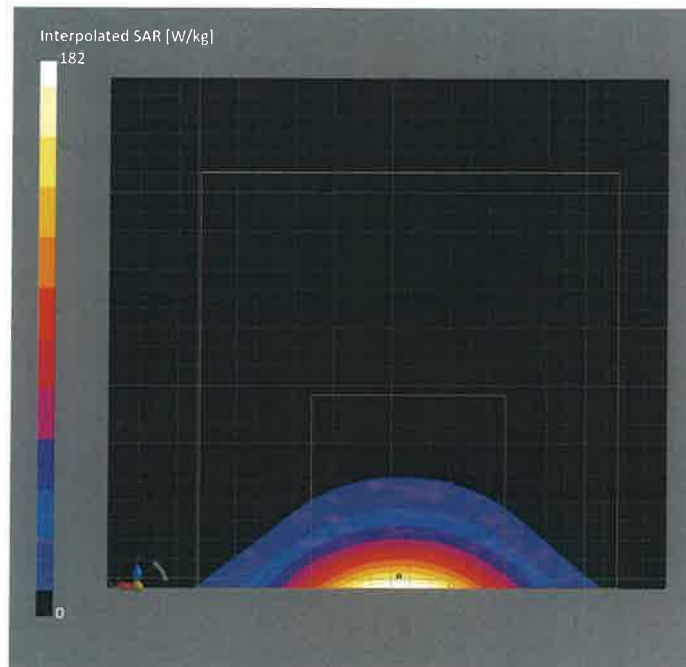

# Impedance Measurement Plot for Head TSL

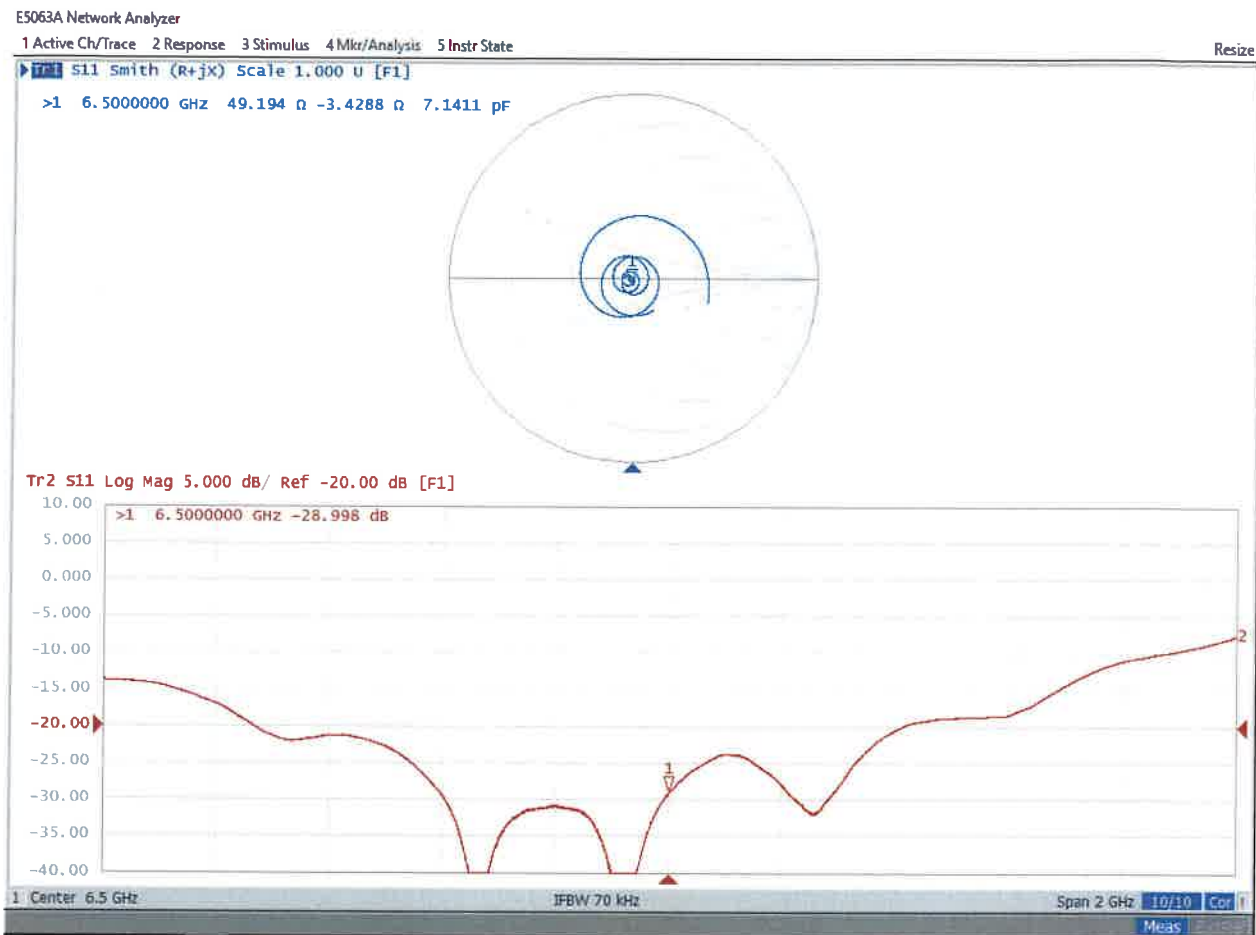



## Dipole Impedance Measurement

Equipment Location	Equipment Name	Model Name	Date of Verification
UL Verification Services Inc. 47173 Benicia Street Fremont, CA 94538, U.S.A.	Dipole Antenna	D6.55GHzV2-1033	March 15, 2024

Number:	Check List:	Result:
1	Visual Inspection	Pass
2	Return/Loss and Impedance	Pass
3	Dipole Arms	Pass

Equipment List:	
Equipment Name:	Calibration Date:
R&S ZNLE6 Vector Network Analyzer	03/05/2024
ZV-Z135 Calibration Kit	03/27/2024

## Dipole Impedance Measurement

### 1) Photo of Dipole



- The connector of dipole contains no abnormalities.

## Dipole Impedance Measurement

### 2) Impedance and Return/Loss

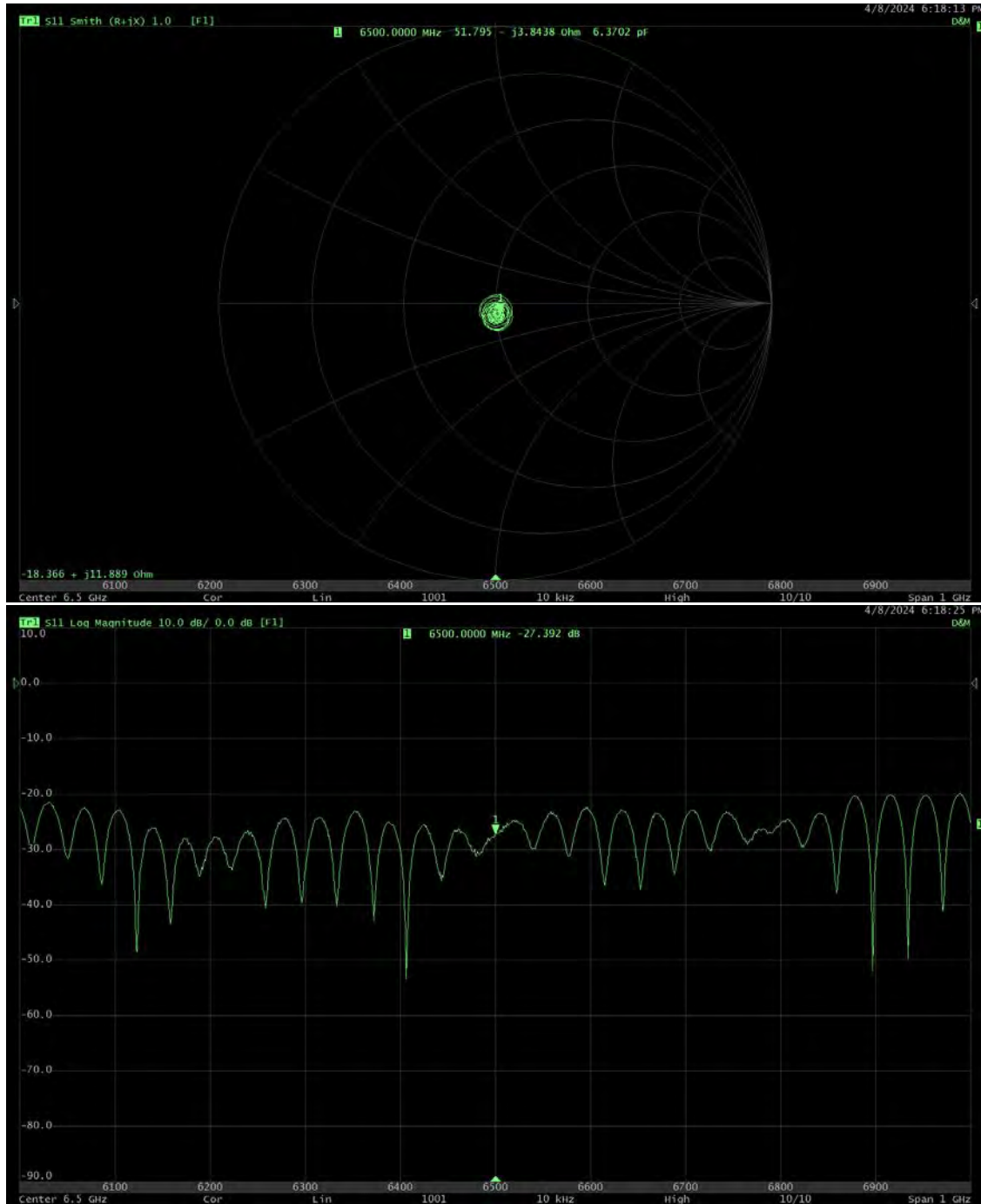

- Return/Loss is greater than the -20 dB cutoff and Impedance is within 5  $\Omega$  of previous value.

## Dipole Impedance Measurement

### 3) Dipole Arms

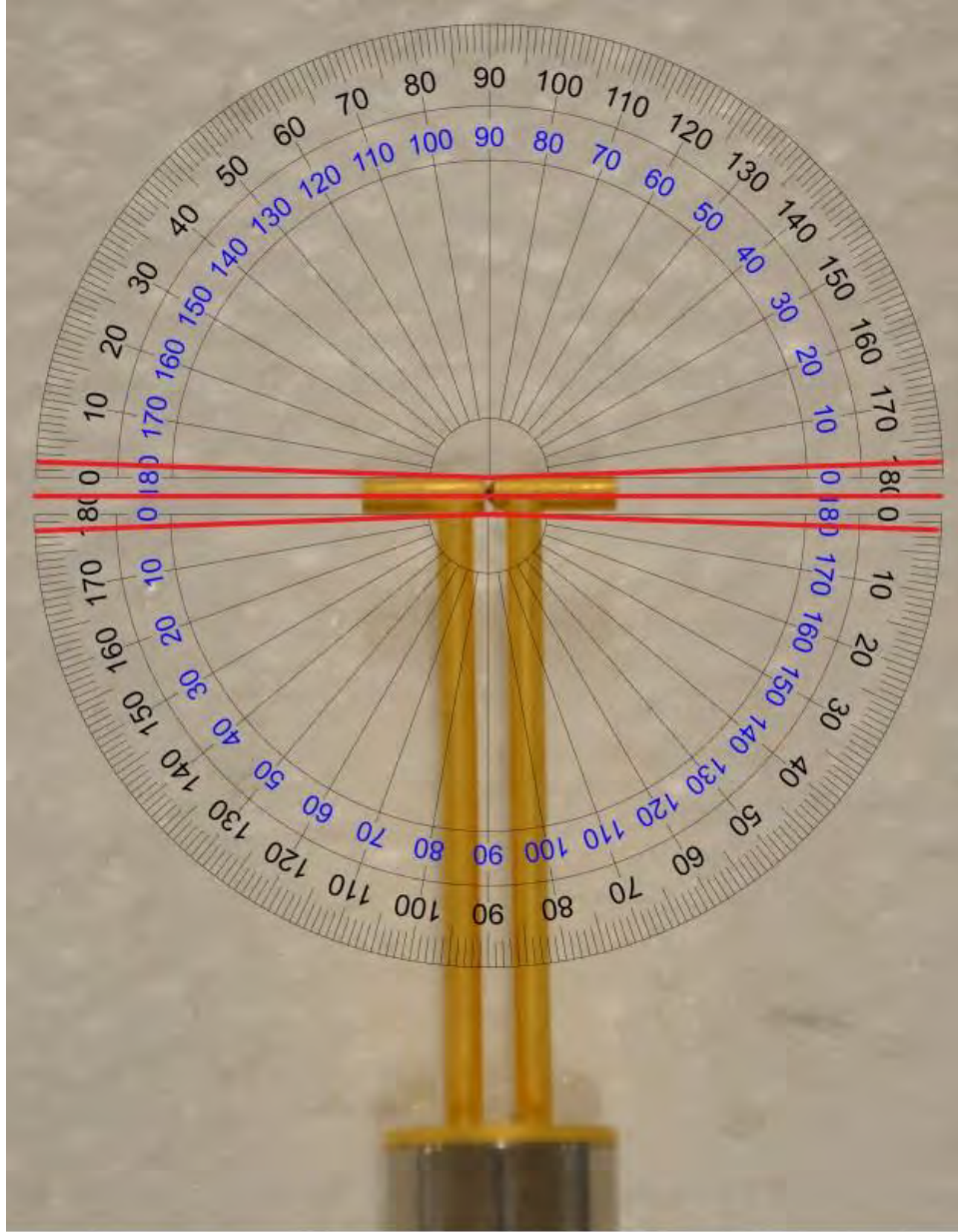

- The center red line indicates that the arms of the dipole fall within  $\pm 2^\circ$





## Dipole Impedance Measurement

Equipment Location	Equipment Name	Model Name	Date of Verification
UL Verification Services Inc. 47173 Benicia Street Fremont, CA 94538, U.S.A.	Dipole Antenna	D6.5GHzV2	April 02, 2025

Number:	Check List:	Result:
1	Visual Inspection	Pass
2	Return/Loss and Impedance	Pass
3	Dipole Arms	Pass

Equipment List:	
Equipment Name:	Calibration Date:
R&S Vector Network Analyzer	2/20/2025
ZV-Z135 Calibration Kit	2/19/2025

## Dipole Impedance Measurement



- The connector of dipole contains no abnormalities.

## Dipole Impedance Measurement

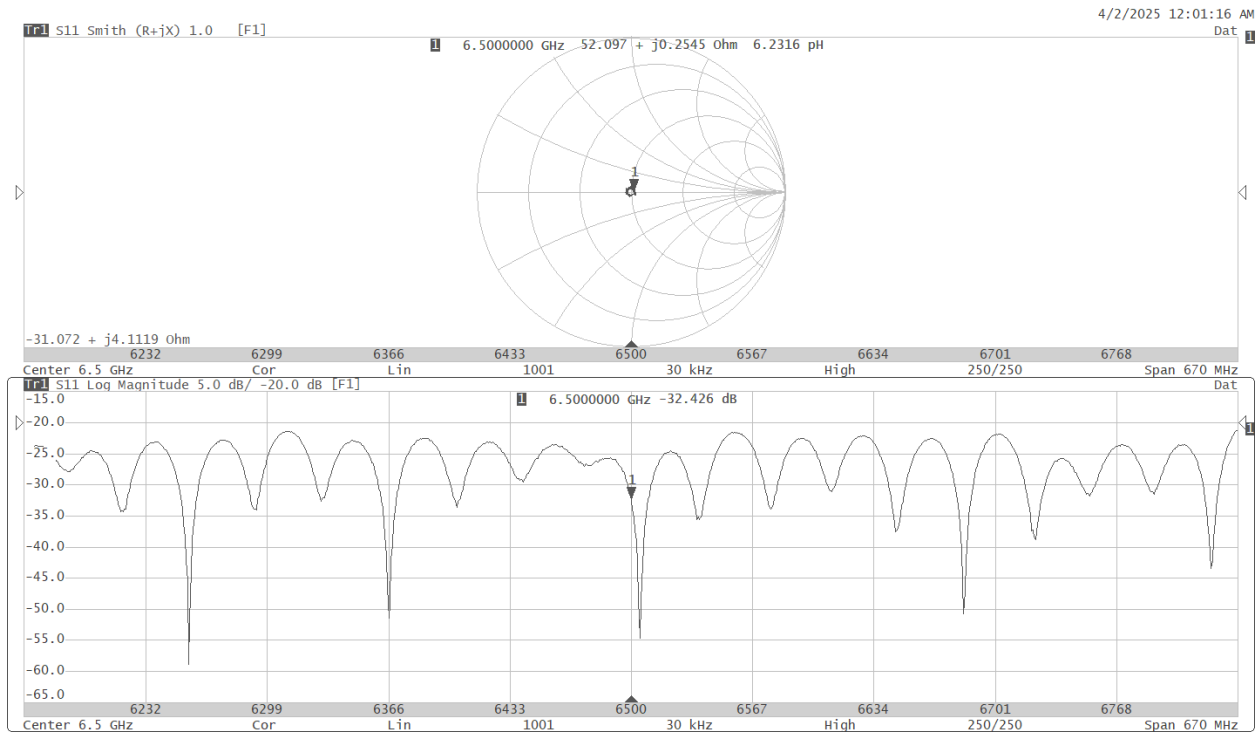

- Return/Loss is greater than the -20 dB cutoff and Impedance is within 5  $\Omega$  of previous value.

## Dipole Impedance Measurement

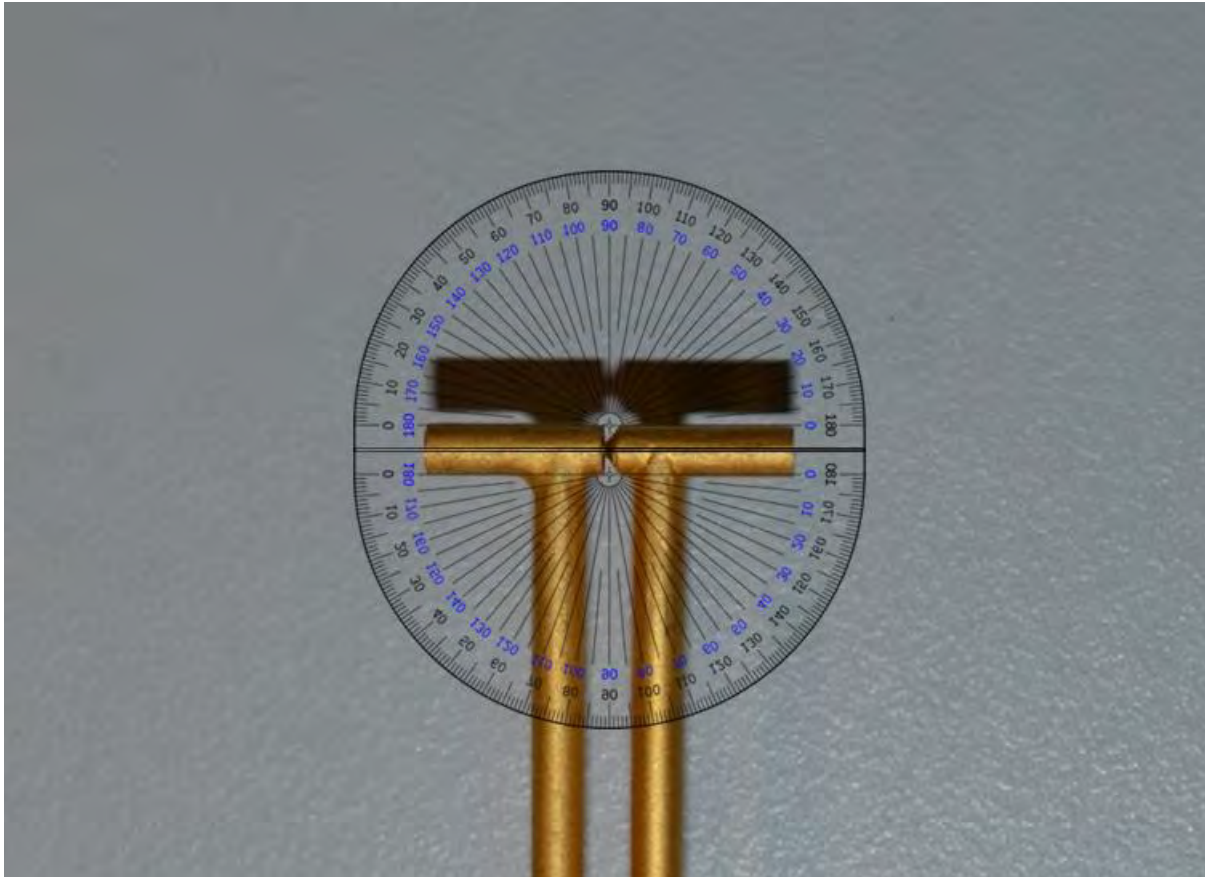

- The center red line indicates that the arms of the dipole fall within  $\pm 2^\circ$



Accredited by the Swiss Accreditation Service (SAS)  
The Swiss Accreditation Service is one of the signatories to the EA  
Multilateral Agreement for the recognition of calibration certificates

Accreditation No.: **SCS 0108**

Client **UL USA**

Certificate No: **CLA13-1008\_Jan23**

## CALIBRATION CERTIFICATE

Object **CLA13 - SN: 1008**

Calibration procedure(s) **QA CAL-15.v10  
Calibration Procedure for SAR Validation Sources below 700 MHz**

Calibration date: **January 12, 2023**

This calibration certificate documents the traceability to national standards, which realize the physical units of measurements (SI).  
The measurements and the uncertainties with confidence probability are given on the following pages and are part of the certificate.

All calibrations have been conducted in the closed laboratory facility: environment temperature ( $22 \pm 3$ )°C and humidity < 70%.

Calibration Equipment used (M&TE critical for calibration)

Primary Standards	ID #	Cal Date (Certificate No.)	Scheduled Calibration
Power meter NRP	SN: 104778	04-Apr-22 (No. 217-03525/03524)	Apr-23
Power sensor NRP-Z91	SN: 103244	04-Apr-22 (No. 217-03524)	Apr-23
Power sensor NRP-Z91	SN: 103245	04-Apr-22 (No. 217-03525)	Apr-23
Reference 20 dB Attenuator	SN: CC2552 (20x)	04-Apr-22 (No. 217-03527)	Apr-23
Type-N mismatch combination	SN: 310982 / 06327	04-Apr-22 (No. 217-03528)	Apr-23
Reference Probe EX3DV4	SN: 3877	06-Jan-23 (No. EX3-3877_Jan23)	Jan-24
DAE4	SN: 654	26-Jan-22 (No. DAE4-654_Jan22)	Jan-23

Secondary Standards	ID #	Check Date (in house)	Scheduled Check
Power meter NRP2	SN: 107193	08-Nov-21 (in house check Dec-22)	In house check: Dec-24
Power sensor NRP-Z91	SN: 100922	15-Dec-09 (in house check Dec-22)	In house check: Dec-24
Power sensor NRP-Z91	SN: 100418	01-Jan-04 (in house check Dec-22)	In house check: Dec-24
RF generator HP 8648C	SN: US3642U01700	04-Aug-99 (in house check Jun-22)	In house check: Jun-24
Network Analyzer Agilent E8358A	SN: US41080477	31-Mar-14 (in house check Oct-22)	In house check: Oct-24

Calibrated by:	Name Michael Weber	Function Laboratory Technician	Signature 
Approved by:	Sven Kühn	Technical Manager	

Issued: January 16, 2023

This calibration certificate shall not be reproduced except in full without written approval of the laboratory.



Accredited by the Swiss Accreditation Service (SAS)

The Swiss Accreditation Service is one of the signatories to the EA  
Multilateral Agreement for the recognition of calibration certificates

Accreditation No.: **SCS 0108**

### Glossary:

TSL	tissue simulating liquid
ConvF	sensitivity in TSL / NORM x,y,z
N/A	not applicable or not measured

### Calibration is Performed According to the Following Standards:

- IEC/IEEE 62209-1528, "Measurement Procedure For The Assessment Of Specific Absorption Rate Of Human Exposure To Radio Frequency Fields From Hand-Held And Body-Worn Wireless Communication Devices - Part 1528: Human Models, Instrumentation And Procedures (Frequency Range of 4 MHz to 10 GHz)", October 2020.
- KDB 865664, "SAR Measurement Requirements for 100 MHz to 6 GHz"

### Additional Documentation:

- DASY System Handbook

### Methods Applied and Interpretation of Parameters:

- Measurement Conditions:* Further details are available from the Validation Report at the end of the certificate. All figures stated in the certificate are valid at the frequency indicated.
- Antenna Parameters with TSL:* The source is mounted in a touch configuration below the center marking of the flat phantom.
- Return Loss:* This parameter is measured with the source positioned under the liquid filled phantom (as described in the measurement condition clause). The Return Loss ensures low reflected power. No uncertainty required.
- SAR measured:* SAR measured at the stated antenna input power.
- SAR normalized:* SAR as measured, normalized to an input power of 1 W at the antenna connector.
- SAR for nominal TSL parameters:* The measured TSL parameters are used to calculate the nominal SAR result.

The reported uncertainty of measurement is stated as the standard uncertainty of measurement multiplied by the coverage factor  $k=2$ , which for a normal distribution corresponds to a coverage probability of approximately 95%.

## Measurement Conditions

DASY system configuration, as far as not given on page 1.

<b>DASY Version</b>	DASY5	V52.10.4
<b>Extrapolation</b>	Advanced Extrapolation	
<b>Phantom</b>	ELI4 Flat Phantom	Shell thickness: $2 \pm 0.2$ mm
<b>EUT Positioning</b>	Touch Position	
<b>Zoom Scan Resolution</b>	$dx, dy = 4.0$ mm, $dz = 1.4$ mm	Graded Ratio = 1.4 (Z direction)
<b>Frequency</b>	$13$ MHz $\pm 1$ MHz	

## Head TSL parameters

The following parameters and calculations were applied.

	Temperature	Permittivity	Conductivity
<b>Nominal Head TSL parameters</b>	22.0 °C	55.0	0.75 mho/m
<b>Measured Head TSL parameters</b>	$(22.0 \pm 0.2)$ °C	$53.3 \pm 6$ %	$0.72$ mho/m $\pm 6$ %
<b>Head TSL temperature change during test</b>	$< 0.5$ °C	----	----

## SAR result with Head TSL

<b>SAR averaged over 1 cm<sup>3</sup> (1 g) of Head TSL</b>	Condition	
SAR measured	1 W input power	0.530 W/kg
SAR for nominal Head TSL parameters	normalized to 1W	<b>0.544 W/kg <math>\pm 18.4</math> % (k=2)</b>

<b>SAR averaged over 10 cm<sup>3</sup> (10 g) of Head TSL</b>	condition	
SAR measured	1 W input power	0.329 W/kg
SAR for nominal Head TSL parameters	normalized to 1W	<b>0.338 W/kg <math>\pm 18.0</math> % (k=2)</b>

**Appendix (Additional assessments outside the scope of SCS 0108)**

**Antenna Parameters with Head TSL**

Impedance, transformed to feed point	53.7 $\Omega$ - 1.8 j $\Omega$
Return Loss	- 28.1 dB

**Additional EUT Data**

Manufactured by	SPEAG
-----------------	-------



Test Laboratory: SPEAG, Zurich, Switzerland

**DUT: CLA13; Type: CLA13; Serial: CLA13 - SN: 1008**

Communication System: UID 0 - CW; Frequency: 13 MHz

Medium parameters used:  $f = 13$  MHz;  $\sigma = 0.72$  S/m;  $\epsilon_r = 53.3$ ;  $\rho = 1000$  kg/m<sup>3</sup>

Phantom section: Flat Section

Measurement Standard: DASY5 (IEEE/IEC/ANSI C63.19-2007)

DASY52 Configuration:

- Probe: EX3DV4 - SN3877; ConvF(15.33, 15.33, 15.33) @ 13 MHz; Calibrated: 06.01.2023
- Sensor-Surface: 1.4mm (Mechanical Surface Detection)
- Electronics: DAE4 Sn654; Calibrated: 26.01.2022
- Phantom: ELI v4.0; Type: QDOVA001BB; Serial: TP:1003
- DASY52 52.10.4(1535); SEMCAD X 14.6.14(7501)

## CLA Calibration for HSL-LF Tissue/CLA-13, touch configuration, Pin=1W/Zoom Scan,

**dist=1.4mm (8x10x8)/Cube 0:** Measurement grid: dx=4mm, dy=4mm, dz=1.4mm

Reference Value = 31.00 V/m; Power Drift = -0.09 dB

Peak SAR (extrapolated) = 1.07 W/kg

**SAR(1 g) = 0.530 W/kg; SAR(10 g) = 0.329 W/kg**

Smallest distance from peaks to all points 3 dB below = 16.6 mm

Ratio of SAR at M2 to SAR at M1 = 78.7%

Maximum value of SAR (measured) = 0.777 W/kg

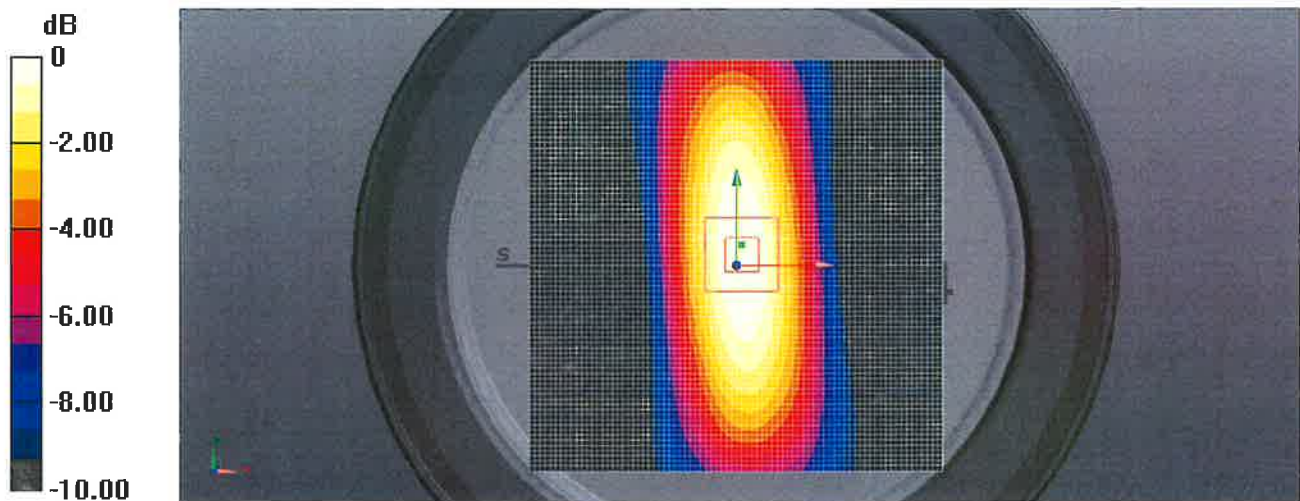

0 dB = 0.777 W/kg = -1.10 dBW/kg

# Impedance Measurement Plot for Head TSL

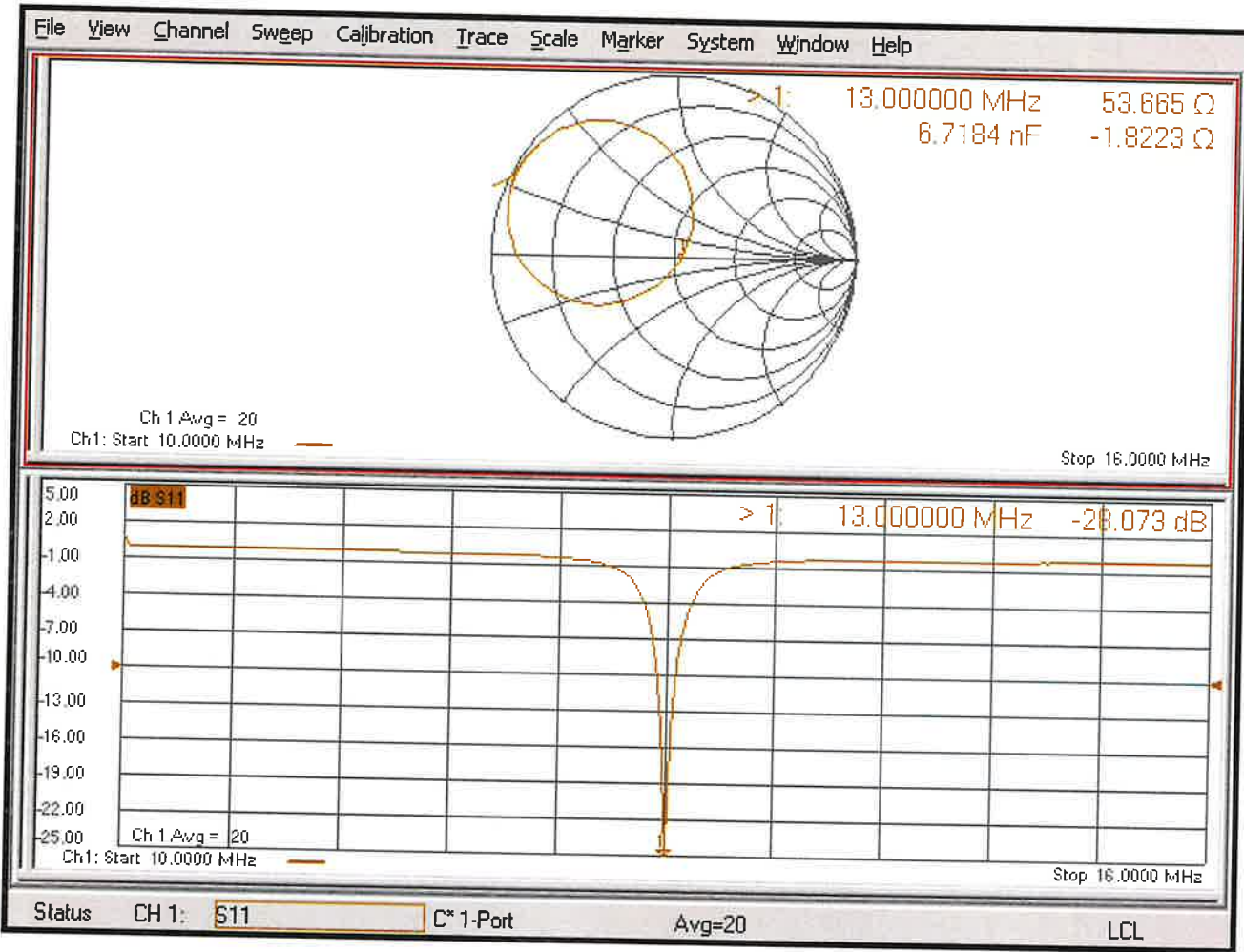



## Dipole Impedance Measurement

Equipment Location	Equipment Name	Model Name	Date of Verification
UL Verification Services Inc. 47173 Benicia Street Fremont, CA 94538, U.S.A.	Dipole Antenna	CLA13-1008	November 12, 2024

Number:	Check List:	Result:
1	Visual Inspection	Pass
2	Return/Loss and Impedance	Pass
3	Dipole Arms	Pass

Equipment List:	
Equipment Name:	Calibration Date:
R&S Vector Network Analyzer	2/13/2024
ZV-Z135 Calibration Kit	3/27/2024

## Dipole Impedance Measurement

### 1) Photo of Dipole

- The connector of dipole contains no abnormalities.

## Dipole Impedance Measurement

### 2) Impedance and Return/Loss

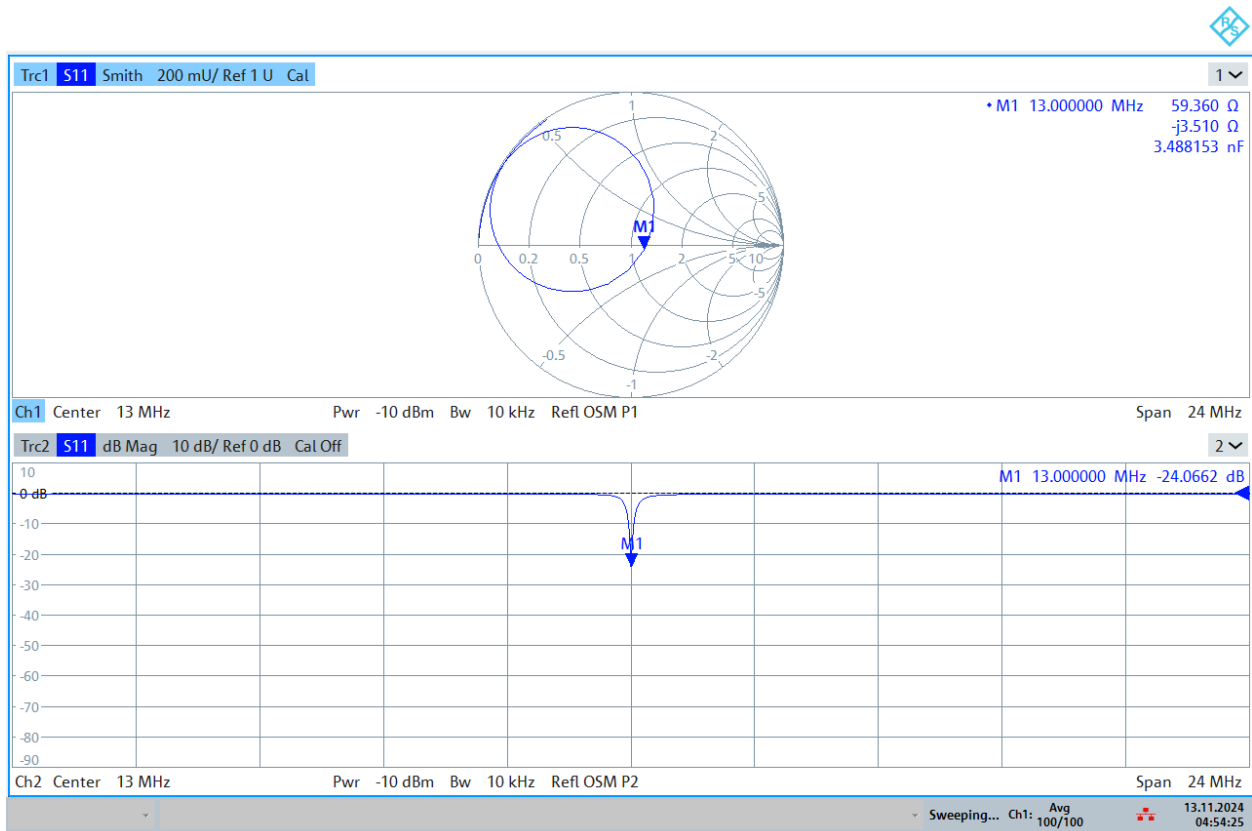

04:54:25 13.11.2024

- Return/Loss is greater than the -20 dB cutoff and Impedance is within 5 Ω of previous value.

## Dipole Impedance Measurement

### 3) Dipole Arms

- The center red line indicates that the arms of the dipole fall within  $\pm 2^\circ$