

TEST REPORT

Report Number: 15496282-E1V4

Applicant : APPLE, INC.
1 APPLE PARK WAY
CUPERTINO, CA 95014, U.S.A.

Model : A3260 (Parent)
A3516, A3517, A3518 (Variants)

Brand : APPLE

FCC ID : BCG-E8948A (Parent)
BCG-E8954A, BCG-E8955A, BCG-E8956A (Variants)

IC : 579C-E8948A (Parent)
579C-E8954A, 579C-E8955A, 579C-E8956A (Variants)

EUT Description : SMARTPHONE

Test Standard(s) : FCC 47 CFR PART 15 SUBPART C
ISED RSS-247 ISSUE 3
ISED RSS-GEN ISSUE 5 + A1 + A2

Date Of Issue:

July 28, 2025

Prepared by:

UL Verification Services Inc.
47173 Benicia Street
Fremont, CA 94538 U.S.A.
TEL: (510) 319-4000
FAX: (510) 661-0888



REPORT REVISION HISTORY

Rev.	Issue Date	Revisions	Revised By
V1	2025/07/07	Initial Issue	Francisco Guarnero
V2	2025/07/17	Addressed TCB questions on Pg 1, Sections 3, 6.1, 6.2, 6.5, 9.3, 9.4, 9.5, 10 & 11.	Francisco Guarnero
V3	2025/07/23	Addressed Feedback in sections 9.4 & 9.5 and updated Output power for BTCSM2	Francisco Guarnero
V4	2025/07/28	Updated sections 6.2 and 9.7.8	Francisco Guarnero

TABLE OF CONTENTS

REPORT REVISION HISTORY	2
TABLE OF CONTENTS	3
1. ATTESTATION OF TEST RESULTS.....	6
2. TEST SUMMARY	8
3. TEST METHODOLOGY	8
4. FACILITIES AND ACCREDITATION.....	9
5. DECISION RULES AND MEASUREMENT UNCERTAINTY.....	10
5.1. <i>METROLOGICAL TRACEABILITY</i>	<i>10</i>
5.2. <i>DECISION RULES</i>	<i>10</i>
5.3. <i>MEASUREMENT UNCERTAINTY</i>	<i>10</i>
6. EQUIPMENT UNDER TEST	11
6.1. <i>EUT DESCRIPTION.....</i>	<i>11</i>
6.2. <i>MAXIMUM OUTPUT POWER.....</i>	<i>12</i>
6.3. <i>DESCRIPTION OF AVAILABLE ANTENNAS</i>	<i>13</i>
6.4. <i>SOFTWARE AND FIRMWARE</i>	<i>13</i>
6.5. <i>WORST-CASE CONFIGURATION AND MODE.....</i>	<i>14</i>
6.6. <i>DESCRIPTION OF TEST SETUP.....</i>	<i>15</i>
7. TEST AND MEASUREMENT EQUIPMENT	20
8. MEASUREMENT METHODS.....	22
9. ANTENNA PORT TEST RESULTS	23
9.1. <i>ON TIME AND DUTY CYCLE</i>	<i>23</i>
9.2. <i>20 dB AND 99% BANDWIDTH.....</i>	<i>24</i>
9.2.1. <i>HIGH POWER BASIC DATA RATE GFSK MODULATION</i>	<i>25</i>
9.2.2. <i>HIGH POWER BASIC DATA RATE TXBF GFSK MODULATION</i>	<i>26</i>
9.2.3. <i>HIGH POWER ENHANCED DATA RATE 8PSK MODULATION</i>	<i>27</i>
9.2.4. <i>HIGH POWER ENHANCED DATA RATE TXBF 8PSK MODULATION</i>	<i>28</i>
9.2.5. <i>HIGH POWER ENHANCED DATA RATE BTCSM2 MODULATION</i>	<i>29</i>
9.2.6. <i>HIGH POWER ENHANCED DATA RATE TXBF BTCSM2 MODULATION.....</i>	<i>30</i>
9.3. <i>HOPPING FREQUENCY SEPARATION</i>	<i>31</i>
9.3.1. <i>HIGH POWER BASIC DATA RATE GFSK MODULATION</i>	<i>32</i>
9.3.2. <i>HIGH POWER BASIC DATA RATE BTCSM2 MODULATION</i>	<i>32</i>
9.4. <i>NUMBER OF HOPPING CHANNELS.....</i>	<i>33</i>
9.4.1. <i>HIGH POWER BASIC DATA RATE GFSK MODULATION</i>	<i>34</i>
9.4.2. <i>HIGH POWER BASIC DATA RATE BTCSM2 MODULATION</i>	<i>36</i>
9.5. <i>AVERAGE TIME OF OCCUPANCY.....</i>	<i>38</i>

9.5.1.	BASIC DATA RATE GFSK MODULATION.....	39
9.5.2.	BASIC DATA RATE BTCSM2 MODULATION.....	43
9.6.	<i>OUTPUT POWER</i>	45
9.6.1.	HIGH POWER BASIC DATA RATE GFSK MODULATION	47
9.6.2.	HIGH POWER BASIC DATA RATE TXBF GFSK MODULATION	47
9.6.3.	HIGH POWER ENHANCED DATA RATE QPSK MODULATION.....	48
9.6.4.	HIGH POWER ENHANCED DATA RATE TXBF QPSK MODULATION	48
9.6.5.	HIGH POWER ENHANCED DATA RATE 8PSK MODULATION	49
9.6.6.	HIGH POWER ENHANCED DATA RATE TXBF 8PSK MODULATION	49
9.6.7.	HIGH POWER ENHANCED DATA RATE BTCSM2 MODULATION	50
9.6.8.	HIGH POWER ENHANCED DATA RATE TXBF BTCSM2 MODULATION.....	50
9.6.9.	LOW POWER BASIC DATA RATE GFSK MODULATION.....	51
9.6.10.	LOW POWER BASIC DATA RATE TXBF GFSK MODULATION	51
9.6.11.	LOW POWER ENHANCED DATA RATE QPSK MODULATION.....	52
9.6.12.	LOW POWER ENHANCED DATA RATE TXBF QPSK MODULATION.....	52
9.6.13.	LOW POWER ENHANCED DATA RATE 8PSK MODULATION.....	53
9.6.14.	LOW POWER ENHANCED DATA RATE TXBF 8PSK MODULATION	53
9.6.15.	LOW POWER ENHANCED DATA RATE BTCSM2 MODULATION	54
9.6.16.	LOW POWER ENHANCED DATA RATE TXBF BTCSM2 MODULATION	54
9.7.	<i>AVERAGE POWER</i>	55
9.7.1.	HIGH POWER BASIC DATA RATE GFSK MODULATION	56
9.7.2.	HIGH POWER BASIC DATA RATE TXBF GFSK MODULATION	56
9.7.3.	HIGH POWER ENHANCED DATA RATE QPSK MODULATION.....	57
9.7.4.	HIGH POWER ENHANCED DATA RATE TXBF QPSK MODULATION	57
9.7.5.	HIGH POWER ENHANCED DATA RATE 8PSK MODULATION	58
9.7.6.	HIGH POWER ENHANCED DATA RATE TXBF 8PSK MODULATION	58
9.7.7.	HIGH POWER ENHANCED DATA RATE BTCSM2 MODULATION	59
9.7.8.	HIGH POWER ENHANCED DATA RATE TXBF BTCSM2 MODULATION.....	59
9.7.9.	LOW POWER BASIC DATA RATE GFSK MODULATION.....	60
9.7.10.	LOW POWER BASIC DATA RATE TXBF GFSK MODULATION	60
9.7.11.	LOW POWER ENHANCED DATA RATE QPSK MODULATION.....	61
9.7.12.	LOW POWER ENHANCED DATA RATE TXBF QPSK MODULATION.....	61
9.7.13.	LOW POWER ENHANCED DATA RATE 8PSK MODULATION.....	62
9.7.14.	LOW POWER ENHANCED DATA RATE TXBF 8PSK MODULATION	62
9.7.15.	LOW POWER ENHANCED DATA RATE BTCSM2 MODULATION	63
9.7.16.	LOW POWER ENHANCED DATA RATE TXBF BTCSM2 MODULATION	63
9.8.	<i>CONDUCTED SPURIOUS EMISSIONS</i>	64
9.8.1.	HIGH POWER BASIC DATA RATE GFSK MODULATION	65
9.8.2.	HIGH POWER BASIC DATA RATE TXBF GFSK MODULATION	69
9.8.3.	HIGH POWER ENHANCED DATA RATE 8PSK MODULATION	73
9.8.4.	HIGH POWER ENHANCED DATA RATE TXBF 8PSK MODULATION	77
9.8.5.	HIGH POWER ENHANCED DATA RATE BTCSM2 MODULATION	81
9.8.6.	HIGH POWER ENHANCED DATA RATE TXBF BTCSM2 MODULATION.....	85
9.8.7.	LOW POWER BASIC DATA RATE GFSK MODULATION.....	89
9.8.8.	LOW POWER BASIC DATA RATE TXBF GFSK MODULATION.....	93
9.8.9.	LOW POWER ENHANCED DATA RATE 8PSK MODULATION	97
9.8.10.	LOW POWER ENHANCED DATA RATE TXBF 8PSK MODULATION	101
9.8.11.	LOW POWER ENHANCED DATA RATE BTCSM2 MODULATION	105
9.8.12.	LOW POWER ENHANCED DATA RATE TXBF BTCSM2 MODULATION	109
10.	RADIATED TEST RESULTS.....	113

10.1.	<i>TRANSMITTER ABOVE 1 GHz</i>	115
10.1.1.	HIGH POWER BASIC DATA RATE GFSK MODULATION.....	115
10.1.2.	HIGH POWER BASIC DATA RATE TX BF GFSK MODULATION	123
10.1.3.	HIGH POWER ENHANCED DATA RATE 8PSK MODULATION.....	127
10.1.4.	HIGH POWER ENHANCED DATA RATE TXBF 8PSK MODULATION.....	135
10.1.5.	HIGH POWER ENHANCED DATA RATE BTCSM2 MODULATION	139
10.1.6.	HIGH POWER ENHANCED DATA RATE TX BF BTCSM2 MODULATION ...	147
10.1.7.	LOW POWER BASIC DATA RATE GFSK MODULATION	151
10.1.8.	LOW POWER BASIC DATA RATE TXBF GFSK MODULATION	159
10.1.9.	LOW POWER ENHANCED DATA RATE 8PSK MODULATION.....	163
10.1.10.	LOW POWER ENHANCED DATA RATE TXBF 8PSK MODULATION	171
10.1.11.	LOW POWER ENHANCED DATA RATE BTCSM2 MODULATION	175
10.1.12.	LOW POWER ENHANCED DATA RATE TX BF BTCSM2 MODULATION	183
10.1.13.	WORST CASE HARMONICS AND SPURIOUS EMISSIONS	187
10.2.	<i>WORST CASE BELOW 30MHz</i>	193
10.3.	<i>WORST CASE BELOW 1 GHz</i>	194
10.4.	<i>WORST CASE 18-26 GHz</i>	196
11.	AC POWER LINE CONDUCTED EMISSIONS	198
11.1.1.	AC POWER LINE WITH LAPTOP	199
11.1.2.	AC POWER LINE WITH AC/DC ADAPTER.....	201
12.	SETUP PHOTOS	203
	APPENDIX A – SPOT CHECK EVALUATION	203

1. ATTESTATION OF TEST RESULTS

COMPANY NAME: APPLE INC.
 1 APPLE PARK WAY
 CUPERTINO, CA 95014, U.S.A.

EUT DESCRIPTION: SMARTPHONE

MODEL: A3260 (Parent)
 A3516, A3517, A3518 (Variants)

BRAND: APPLE

SERIAL NUMBER: LFK6GGFV2V RADIATED
 C07HC90003E0000XN3 CONDUCTED

SAMPLE RECEIPT DATE: 2025-01-16

DATE TESTED: FEBRUARY 14, - JULY 17, 2025

APPLICABLE STANDARDS	
STANDARD	TEST RESULTS
CFR 47 Part 15 Subpart C	Complies
ISED RSS-247 Issue 3	Complies
ISED RSS-GEN Issue 5 + A1 + A2	Complies

UL Verification Services Inc. tested the above equipment in accordance with the requirements set forth in the above standards. The test results show that the equipment tested can demonstrate compliance with the requirements as documented in this report.

The results documented in this report apply only to the tested sample, under the conditions and modes of operation as described herein. It is the manufacturer's responsibility to ensure that additional production units of this model are manufactured with identical electrical and mechanical components. All samples tested were in good operating condition throughout the entire test program. Measurement Uncertainties are published for informational purposes only and were not considered unless noted otherwise.

This document may not be altered or revised in any way unless done so by UL Verification Services Inc. and all revisions are noted in the revisions section. Any alteration of this document not carried out by UL Verification Services Inc. will constitute fraud and shall nullify the document. This report must not be used by the client to claim product certification, approval, or endorsement by A2LA, NIST, any agency of the Federal Government, or any agency of the U.S. government.

Approved & Released For
UL Verification Services Inc. By:



Frank Ibrahim
Staff Engineer
Consumer Technology Division
UL Verification Services Inc.

Prepared By:

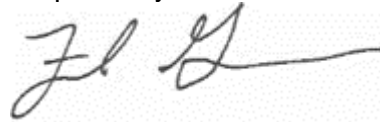

Francisco Guarnero
Test Engineer
Consumer Technology Division
UL Verification Services Inc.

2. TEST SUMMARY

This report contains data provided by the customer which can impact the validity of results. UL Verification Services Inc. is only responsible for correctly integrating customer-provided data with measurements performed by UL Verification Services Inc.

Below is a list of the data provided by the customer:

Antenna gain and type (see section 6.4)

Cable loss (see section 6.4)

FCC Clause	ISED Clause	Requirement	Result	Comment
See Comment		Duty Cycle	Reporting purposes only	Per ANSI C63.10, Section 11.6.
See Comment	RSS-GEN 6.7	20dB BW/99% OBW	Reporting purposes only	ANSI C63.10 Sections 6.9.2 and 6.9.3
15.247 (a)(1)	RSS-247 (5.1) (b)	Hopping Frequency Separation	Complies	None.
15.247 (a)(1)(iii)	RSS-247 (5.1) (d)	Number of Hopping Channels	Complies	None.
15.247 (a)(1)(iii)	RSS-247 (5.1) (d)	Average Time of Occupancy	Complies	None.
15.247 (b)(1)	RSS-247 (5.4) (b)	Output Power	Complies	None.
See Comment		Average Power	Reporting purposes only	Per ANSI C63.10, Section 11.9.2.3.2.
15.247 (d)	RSS-247 (5.5)	Conducted Spurious Emissions	Complies	None.
15.209, 15.205	RSS-GEN 8.9, 8.10	Radiated Emissions	Complies	None.
15.207	RSS-Gen 8.8	AC Mains Conducted Emissions	Complies	None.

3. TEST METHODOLOGY

The tests documented in this report were performed in accordance with:

- FCC 47 CFR Part 2
- FCC 47 CFR Part 15C
- *ANSI C63.10-2020+Cor. 1-2023+C63.10a-2024
- KDB 558074 D01 15.247 Meas Guidance
- KDB 414788 D01 Radiated Test Site
- KDB 662911 D01 Multiple Transmitter Output
- KDB 484596 D01 Referencing Test Data
- RSS-GEN Issue 5 + A1 + A2
- RSS-247 Issue 3

*Note: The use of ANSI C63.10-2020 + Cor. 1-2023 + C63.10a-2024 does not deviate from the testing procedures of ANSI C63.10-2020

4. FACILITIES AND ACCREDITATION

UL Verification Services Inc. is accredited by A2LA, certification #0751.05, for all testing performed within the scope of this report. Testing was performed at the locations noted below.

	Address	ISED CABID	ISED Company Number	FCC Registration
<input checked="" type="checkbox"/>	Building 1: 47173 Benicia Street, Fremont, CA 94538, USA	US0104	2324A	550739
<input checked="" type="checkbox"/>	Building 2: 47266 Benicia Street, Fremont, CA 94538, USA			
<input type="checkbox"/>	Building 3: 843 Auburn Court, Fremont, CA 94538 USA			
<input checked="" type="checkbox"/>	Building 4: 47658 Kato Rd, Fremont, CA 94538 USA			
<input checked="" type="checkbox"/>	Building 5: 47670 Kato Rd, Fremont, CA 94538 USA			

5. DECISION RULES AND MEASUREMENT UNCERTAINTY

5.1. METROLOGICAL TRACEABILITY

All test and measuring equipment utilized to perform the tests documented in this report are calibrated on a regular basis, with a maximum time between calibrations of one year or the manufacturers' recommendation, whichever is less, and where applicable is traceable to recognized national standards.

5.2. DECISION RULES

The Decision Rule is based on Simple Acceptance in accordance with ISO Guide 98-4:2012 Clause 8.2. (Measurement uncertainty is not considered when stating conformity with a specified requirement.)

5.3. MEASUREMENT UNCERTAINTY

Where relevant, the following measurement uncertainty levels have been estimated for tests performed on the apparatus:

PARAMETER	U_{LAB}
Conducted Antenna Port Emission Measurement	1.94 dB
Time Domain Measurements Using SA	3.39 dB
RF Power Measurement Direct Method Using Power Meter	1.3 (Peak), 0.45 (Ave)
Radio Frequency (Spectrum Analyzer)	141.16 Hz
Occupied Bandwidth	1.22%
Carrier Frequency Separation	19.70Hz
Number of Hopping Frequencies	0.000dB
Worst Case Conducted Disturbance, 9KHz to 0.15 MHz	3.78 dB
Worst Case Conducted Disturbance, 0.15 to 30 MHz	3.40 dB
Worst Case Radiated Disturbance, 9KHz to 30 MHz	2.87 dB
Worst Case Radiated Disturbance, 30 to 1000 MHz	6.01 dB
Worst Case Radiated Disturbance, 1000 to 18000 MHz	4.73 dB
Worst Case Radiated Disturbance, 18000 to 26000 MHz	4.51 dB

Uncertainty figures are valid to a confidence level of 95%.

6. EQUIPMENT UNDER TEST

6.1. EUT DESCRIPTION

The Apple iPhone is a smartphone with cellular GSM, GPRS, EGPRS, WCDMA, LTE, 5G NR1, IEEE 802.11a/b/g/n/ac/ax/be, Bluetooth (BT), Ultra-Wideband (UWB), Global Positioning System (GPS), Near-Field Communication (NFC), Narrow-Band (NB) UNII, 802.15.4, 802.15.4ab-Narrow Band (NB), Wireless Power Transfer (WPT) and Mobile Satellite Service (MSS) technologies. The rechargeable battery is not user accessible.

6.2. MAXIMUM OUTPUT POWER

The transmitter has a maximum peak conducted output power as follows:

Antenna	Config	Frequency Range (MHz)	Mode	Output Power (dBm)	Output Power (mW)
ANT 2	High Power	2402 - 2480	Basic GFSK	20.54	113.24
		2402 - 2480	DQPSK	16.51	44.77
		2402 - 2480	Enhanced 8PSK	16.68	46.56
		2402 - 2480	BTCSM2	13.50	22.39
	Low Power	2402 - 2480	Basic GFSK	7.97	6.27
		2402 - 2480	DQPSK	8.55	7.16
		2402 - 2480	Enhanced 8PSK	8.78	7.55
		2402 - 2480	BTCSM2	10.38	10.91
ANT 1	High Power	2402 - 2480	Basic GFSK	20.49	111.94
		2402 - 2480	DQPSK	16.88	48.75
		2402 - 2480	Enhanced 8PSK	17.21	52.60
		2402 - 2480	BTCSM2	13.56	22.70
	Low Power	2402 - 2480	Basic GFSK	9.84	9.64
		2402 - 2480	DQPSK	9.42	8.75
		2402 - 2480	Enhanced 8PSK	9.63	9.18
		2402 - 2480	BTCSM2	11.90	15.49
BF, ANT 2 + ANT 1	High Power	2402 - 2480	Basic GFSK TxBF	20.28	106.66
		2402 - 2480	DQPSK TxBF	19.58	90.78
		2402 - 2480	Enhanced 8PSK TxBF	19.92	98.17
		2402 - 2480	BTCSM2	13.31	21.43
	Low Power	2402 - 2480	Basic GFSK TxBF	11.89	15.45
		2402 - 2480	DQPSK TxBF	12.01	15.89
		2402 - 2480	Enhanced 8PSK TxBF	12.17	16.48
		2402 - 2480	BTCSM2	13.30	21.38

6.3. DESCRIPTION OF AVAILABLE ANTENNAS

The antenna(s) gain, type and cable loss, as provided by the manufacturer' are as follows:

Frequency Band (GHz)	Antenna Type	Antenna Peak Gain ANT 2 (dBi)	Antenna Peak Gain ANT 1 (dBi)	Cable Loss ANT 2 (dB)	Cables Loss ANT 1 (dB)
2.4	IFA	-1.5	-2.5	1.45	1.46

The cables were used for RF antenna port tests that had been offset to the test equipment during testing.

6.4. SOFTWARE AND FIRMWARE

The EUT firmware IS Luck23A256.

6.5. WORST-CASE CONFIGURATION AND MODE

The EUT was investigated in three orthogonal orientations X, Y and Z on ANT 2 and ANT 1, it was determined that X (Flatbed) was the worst-case orientation for ANT 2 and ANT 1 and Y (Landscape) orientation for 2TX beamforming.

Radiated band edge, harmonic, and spurious emissions from 1GHz to 18GHz were performed with the EUT was set to transmit at highest power on Low/Middle/High channels.

Radiated emissions below 30MHz, below 1GHz, 18-26GHz and power line conducted emissions were performed with the EUT transmits at the channel with the highest output power as worst-case scenario. There were no emissions found below 30MHz within 20dB of the limit

For below 1GHz tests EUT was connected to AC power adapter as the worst case; and for above 1GHz, the worst-case configuration reported was tested with EUT only. For AC line conducted emission, test was investigated with AC power adapter and with laptop.

For simultaneous transmission of multiple channels in the 2.4GHz BT and 5GHz bands, no noticeable emission was found.

GFSK, DQPSK, 8PSK, BTCSM2, average power is all investigated, The GFSK, 8PSK, and BTCSM2 power are the worst case. For average power data please refer to section 9.7.

Worst-case data rates as provided by the client were:

GFSK mode : DH5
8PSK mode : 3-DH5
BTCSM2 : 2Mbps

Beamforming
GFSK: DH5
8PSK: 3-DH5
BTCSM2: 2Mbps

For radiated harmonic spurious emissions test, high power beamforming GFSK mode is set to maximum power per chain to cover both SISO and MIMO modes to comply with radiated spurious emissions limits in the restricted bands between 1GHz and 18GHz low/mid/high channel.

6.6. DESCRIPTION OF TEST SETUP

SUPPORT TEST EQUIPMENT						
Description	Manufacturer	Model	Serial Number	FCC ID/ DoC		
Laptop	Apple	Macbook	G2YKJ9LWH5	N/A		
Laptop AC/DC adapter	Apple	N/A	C4H238408AEPM0WAS	DoC		
EUT AC/DC adapter	Apple	N/A	C4H238505ARPM0WAP	DoC		
Conducted Switch Box	UL	N/A	245782	N/A		
I/O CABLES (RF CONDUCTED TEST)						
Cable No.	Port	# of Identical Ports	Connector Type	Cable Type	Cable Length (m)	Remarks
1	Antenna	1	SMA	Un-shielded	0.2	To spectrum Analyzer
2	USB	1	USB	Shielded	1.0	N/A
3	AC	1	AC	Un-shielded	2	N/A
I/O CABLES (RF RADIATED TEST)						
Cable No.	Port	# of Identical Ports	Connector Type	Cable Type	Cable Length (m)	Remarks
1	AC	1	AC	Un-shielded	2	N/A
2	USB	1	USB	Un-shielded	1	N/A

TEST SETUP

The EUT is connected to a test laptop during the tests. Test software exercised the radio card.

SETUP DIAGRAM FOR CONDUCTED TESTS

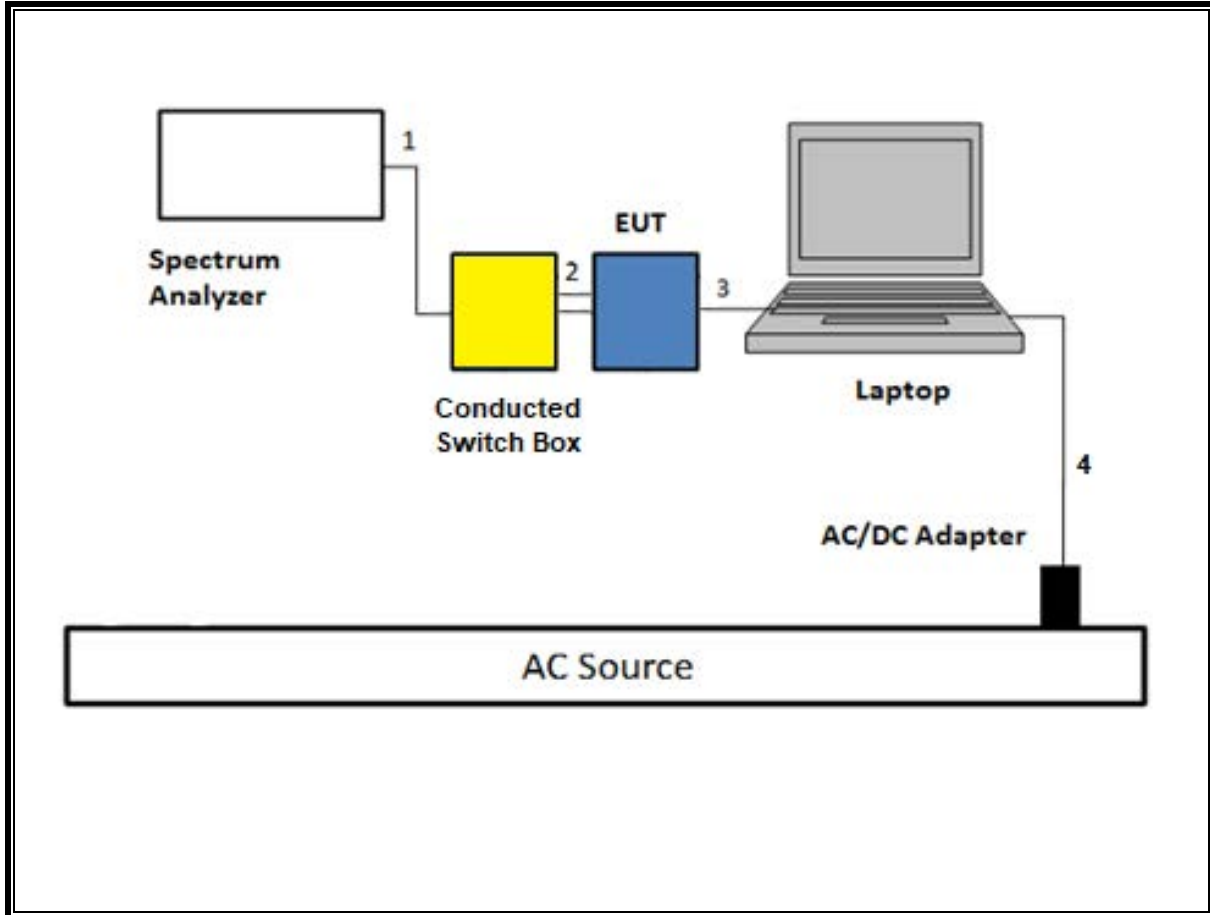

SETUP DIAGRAM FOR RADIATED TESTS Above 1 GHz

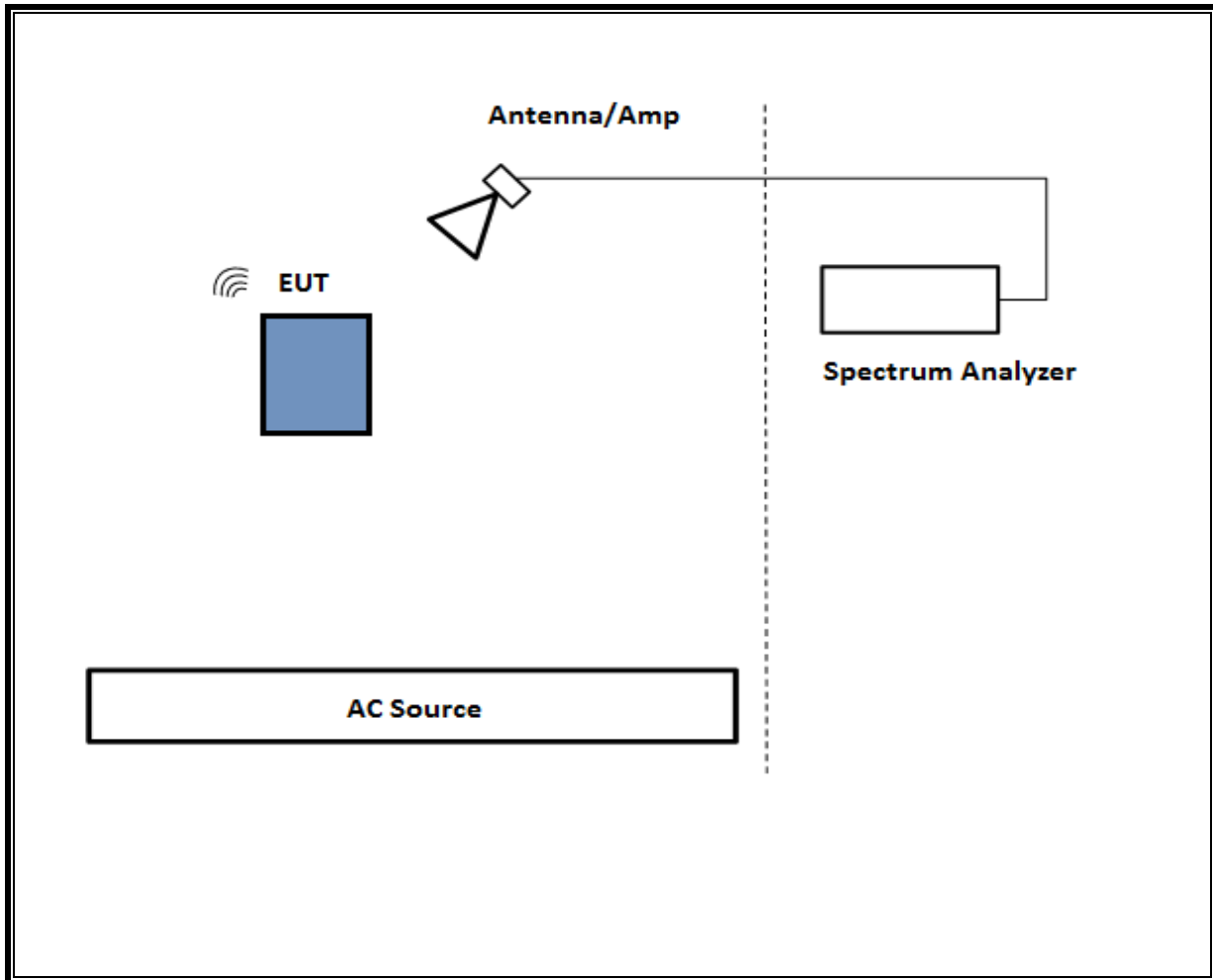

SETUP DIAGRAM FOR Below 1GHz and AC LINE CONDUCTED TEST

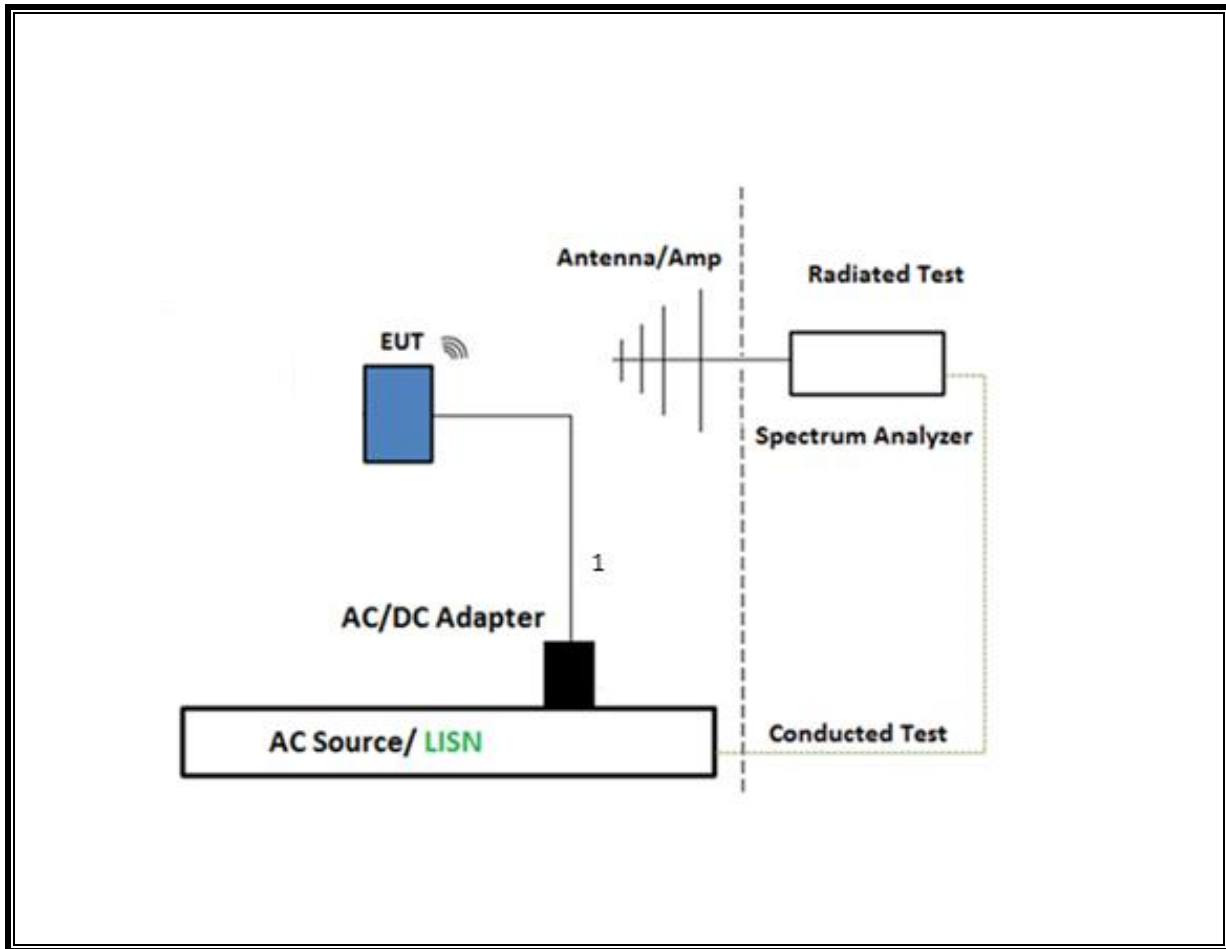

TEST SETUP- AC LINE CONDUCTED: LAPTOP CONFIGURATION

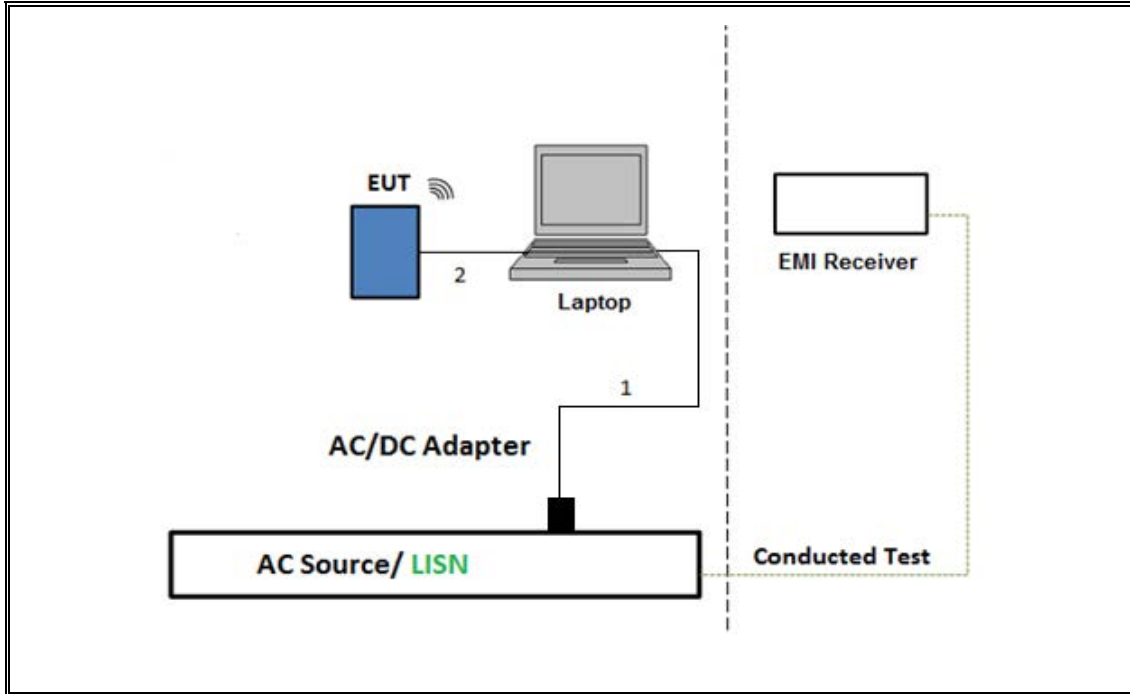

7. TEST AND MEASUREMENT EQUIPMENT

The following test and measurement equipment were utilized for the tests documented in this report:

TEST EQUIPMENT LIST				
Description	Manufacturer	Model	ID Num	Cal Due
Antenna, Horn 1-18GHz	ETS-Lindgren	3117	84796	2026/4/30
RF Filter Box, 1-18GHz, 12 Port	UL-FR1	Frankenstein	230878	2026/1/31
EMI TEST RECEIVER	Rohde & Schwarz	ESW44	191428	2026/2/28
Antenna, Horn 1-18GHz	ETS-Lindgren	3117	84797	2026/5/31
RF Filter Box, 1-18GHz, 17 Ports	UL-FR1	RAT 2	225079	2026/5/31
EMI TEST RECEIVER	Rohde & Schwarz	ESW44	235670	2026/2/28
Antenna, Horn 1-18GHz	ETS-Lindgren	3117	79834	2025/9/6
RF Filter Box, 1-18GHz, 2x12, 1x8 switches.	UL-FR1	Frankenstein, 2 Amp version	237597	2025/10/31
EMI TEST RECEIVER	Rohde & Schwarz	ESW44	169935	2026/2/27
Antenna, Horn 1-18GHz	ETS-Lindgren	3117	80403	2025/6/30
RF Filter Box, 1-18GHz, 17 Ports	UL-FR1	RAT 2	236726	2025/10/31
EMI TEST RECEIVER	Rohde & Schwarz	ESW44	223460	2026/2/28
Antenna, Broadband Hybrid, 30MHz to 3GHz	Sunol Sciences Corp.	JB3	202301	8/31/2026
Amplifier, 9KHz to 1GHz, 32dB	SONOMA INSTRUMENT	310	79584	1/31/2026
EMI TEST RECEIVER	Rohde & Schwarz	ESW44	235266	2/28/2026
Antenna, Horn 18-26.5GHz	A.R.A	MWH-1826/B	81140	*2025/3/21
Link File, RF Amplifier Assembly, 18-26.5GHz, 60dB Gain	Amplical	AMP18G26.5-60	236106	*2025/4/18
Antenna, Horn 26.5-40GHz	A.R.A	MWH-2640/B	230656	*2025/3/31
Link File, RF Amplifier Assembly, 26.5-40GHz, 65dB Gain	Amplical	AMP26G40-65	236107	*2025/4/17
Antenna, Passive Loop, 30Hz - 1MHz	Electro-Metrics	EM-6871	170014	2025/08/31
Antenna, Passive Loop, 100kHz to 30MHz	Electro-Metrics	EM-6872	170016	2025/08/31
Spectrum Analyzer, PXA, 3Hz to 44GHz	N9030A	Keysight Technologies Inc	80397	2026/01/31
Spectrum Analyzer, PXA, 3Hz to 44GHz	N9030A	Keysight Technologies Inc	125179	2026/02/28
Conducted Switch Box	UL-FR1	CSB	245782	2025/07/31
Conducted Switch Box	UL-FR1	CSB	208281	*2025/05/31
Power Meter, P-series single channel	Keysight Technologies Inc	N1911A	90715	2026/01/31
Power Sensor, P - series, 50MHz to 18GHz, Wideband	Keysight Technologies Inc	N1921A	81319	2026/01/31
Power Meter, P-series single channel	Keysight Technologies Inc	N1911A	90718	2026/01/31
Power Sensor, P - series, 50MHz to 18GHz, Wideband	Keysight Technologies Inc	N1921A	90419	2026/01/31

AC Line Conducted				
Description	Manufacturer	Model	ID Num	Cal Due
EMI Test Receiver 9kHz-7GHz	Rohde & Schwarz	ESR	171646	2026/02/28
LISN for Conducted Emissions CISPR-16	FISCHER CUSTOM COMMUNICATIONS	FCC-LISN-50/250-25-2-01-480V	175765	2026/01/31
Transient Limiter	TE	TBFL1	207996	2025/09/30
UL AUTOMATION SOFTWARE				
Radiated Software	UL	UL EMC	Ver 9.5, May 1, 2023	
Conducted Software	UL	UL EMC	2020.8.16	
AC Line Conducted Software	UL	UL EMC	Ver 9.5, Mar 3, 2023	

*Testing was completed before equipment calibration date

8. MEASUREMENT METHODS

On Time and Duty Cycle: ANSI C63.10 Section 11.6

Occupied BW (20dB): ANSI C63.10 Section 6.9.2

Occupied BW (99%): ANSI C63.10 Section 6.9.3

Carrier Frequency Separation: ANSI C63.10 Section 7.8.2

Number of Hopping Frequencies: ANSI C63.10 Section 7.8.3

Time of Occupancy (Dwell Time): ANSI C63.10 Section 7.8.4

Peak Output Power: ANSI C63.10 Section 7.8.5

Conducted Spurious Emissions: ANSI C63.10 Section 7.8.7

Conducted Band-Edge: ANSI C63.10 Section 6.10.4

Radiated Spurious Emissions Below 30MHz: ANSI C63.10 Section 6.4 & 13

Radiated Spurious Emissions 30-1000MHz: ANSI C63.10 Section 6.3, 6.5 & 13

Radiated Spurious Emissions above 1GHz: ANSI C63.10 Section 6.3, 6.6 & 13

Radiated Band-edge: ANSI C63.10 Section 6.10.5 & 13

AC Power-line conducted emissions: ANSI C63.10 Section 6.2

9. ANTENNA PORT TEST RESULTS

9.1. ON TIME AND DUTY CYCLE

LIMITS

None; for reporting purposes only.

PROCEDURE

ANSI C63.10, Section 11.6: Zero-Span Spectrum Analyzer Method.

ON TIME AND DUTY CYCLE RESULTS

Mode	ON Time B (msec)	Period (msec)	Duty Cycle x (linear)	Duty Cycle (%)	Duty Cycle Correction Factor (dB)	1/T Minimum VBW (kHz)
Bluetooth GFSK	2.87	3.75	0.766	76.6%	1.16	0.348
Bluetooth 8PSK	2.75	3.75	0.732	73.2%	1.36	0.364
BTCISM2	0.09	0.47	0.201	20.1%	6.97	10.684

Note: Both 1TX and 2TX have the same DCCF.

DUTY CYCLE PLOTS

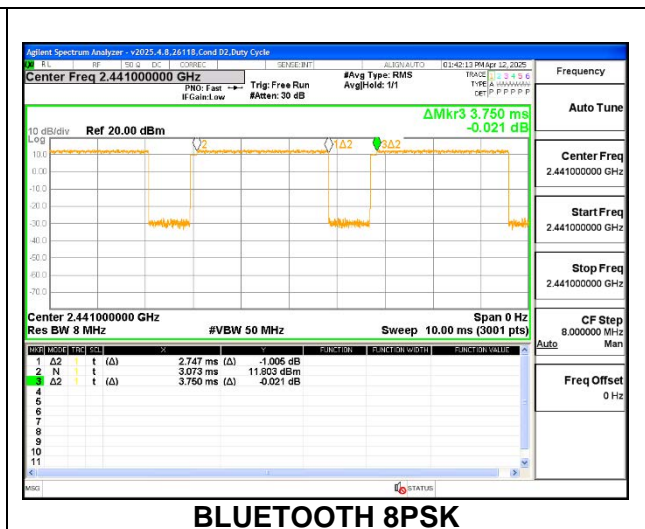
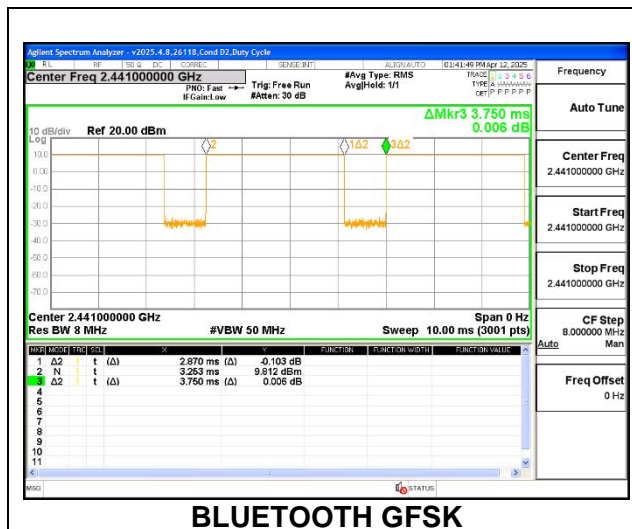

9.2. 20 dB AND 99% BANDWIDTH

LIMITS

None; for reporting purposes only.

TEST PROCEDURE

The transmitter output is connected to a spectrum analyzer. The RBW is set to $\geq 1\%$ of the 20 dB bandwidth. The VBW is set to $\geq 3 \times \text{RBW}$. The sweep time is coupled.

RESULTS

Only the High-Power modes result is reported, it covers all Low Power modes. Only Mid channel plot is reported to show the analyzer's settings.

9.2.1. HIGH POWER BASIC DATA RATE GFSK MODULATION

ANT 2

Channel	Frequency (MHz)	20dB Bandwidth (MHz)	99% Bandwidth (MHz)
Low	2402	0.9374	0.89318
Mid	2441	0.9309	0.86215
High	2480	0.8723	0.83518

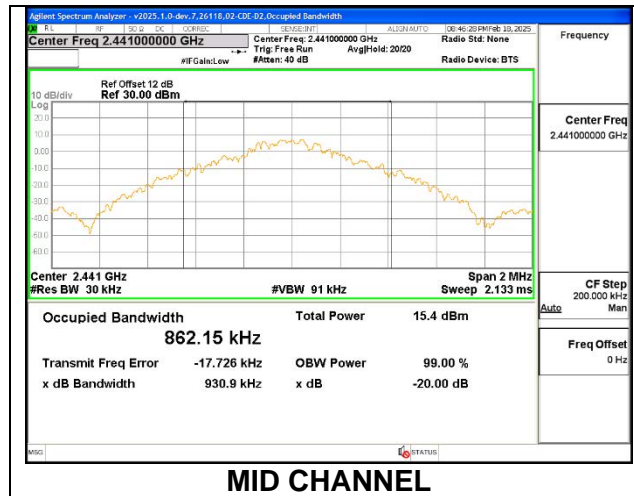

ANT 1

Channel	Frequency (MHz)	20dB Bandwidth (MHz)	99% Bandwidth (MHz)
Low	2402	0.9485	0.87220
Mid	2441	0.9248	0.85506
High	2480	0.9517	0.88695

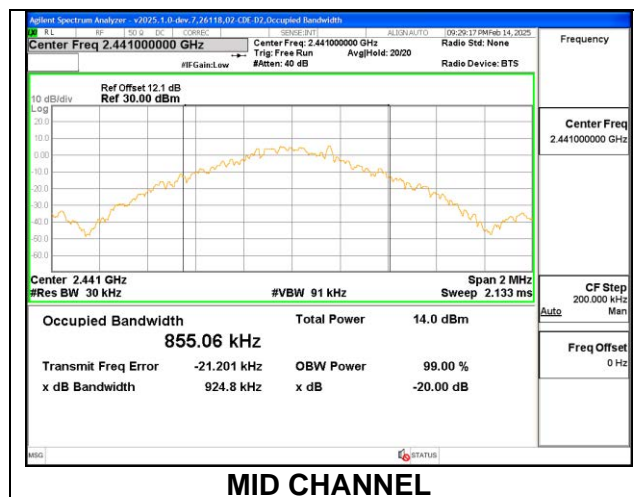

9.2.2. HIGH POWER BASIC DATA RATE TXBF GFSK MODULATION

Channel	Frequency (MHz)	20dB Bandwidth ANT 2 (MHz)	20dB Bandwidth ANT 1 (MHz)	99% Bandwidth ANT 2 (MHz)	99% Bandwidth ANT 1 (MHz)
Low	2402	0.9078	0.9327	0.84538	0.85235
Mid	2441	0.9379	0.9102	0.84808	0.84220
High	2480	0.9450	0.9256	0.86815	0.86961

Note: Test procedures and setting on beamforming mode are same as BT basic and EDR mode

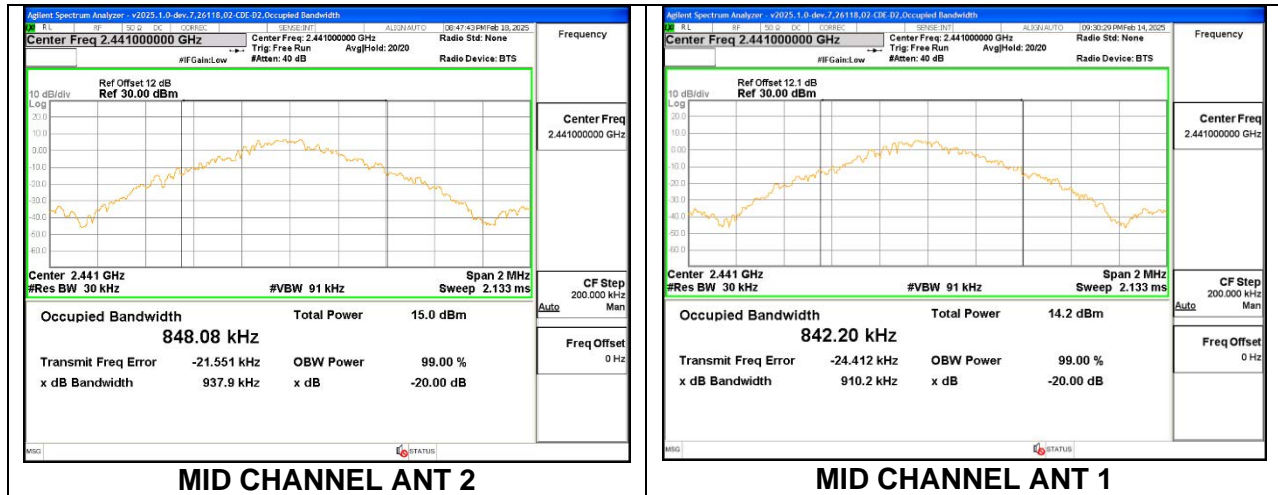

9.2.3. HIGH POWER ENHANCED DATA RATE 8PSK MODULATION

ANT 2

Channel	Frequency (MHz)	20dB Bandwidth (MHz)	99% Bandwidth (MHz)
Low	2402	1.337	1.1972
Mid	2441	1.330	1.2085
High	2480	1.316	1.1834

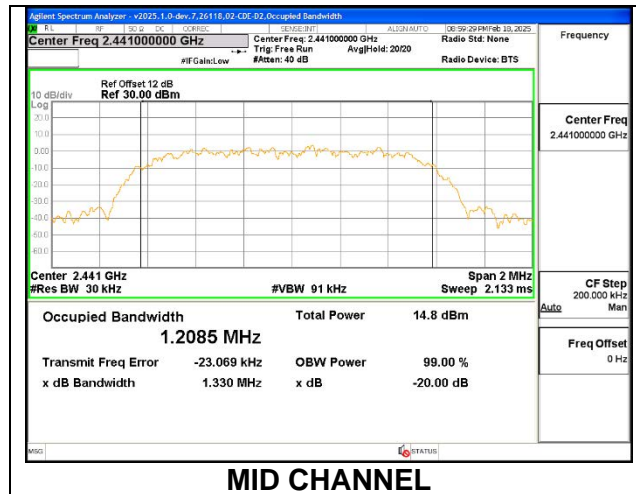

ANT 1

Channel	Frequency (MHz)	20dB Bandwidth (MHz)	99% Bandwidth (MHz)
Low	2402	1.348	1.2141
Mid	2441	1.342	1.1813
High	2480	1.340	1.1931

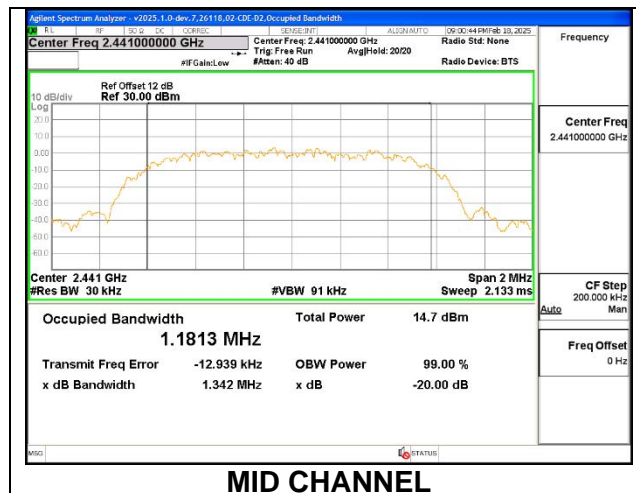

9.2.4. HIGH POWER ENHANCED DATA RATE TXBF 8PSK MODULATION

Channel	Frequency (MHz)	20dB Bandwidth ANT 2 (MHz)	20dB Bandwidth ANT 1 (MHz)	99% Bandwidth ANT 2 (MHz)	99% Bandwidth ANT 1 (MHz)
Low	2402	1.349	1.295	1.1999	1.1974
Mid	2441	1.320	1.318	1.1816	1.1988
High	2480	1.326	1.309	1.1930	1.2074

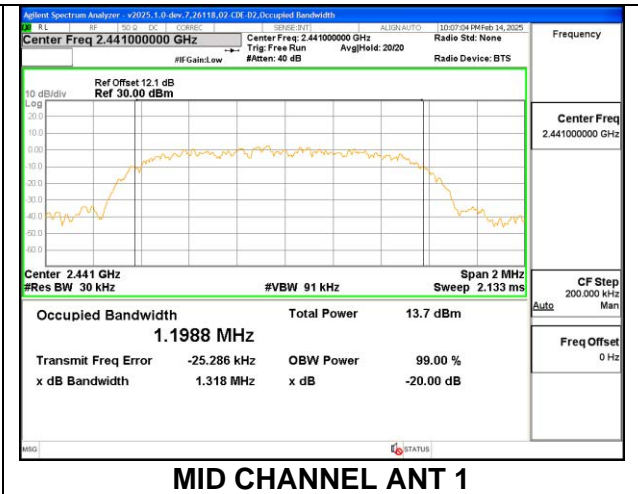
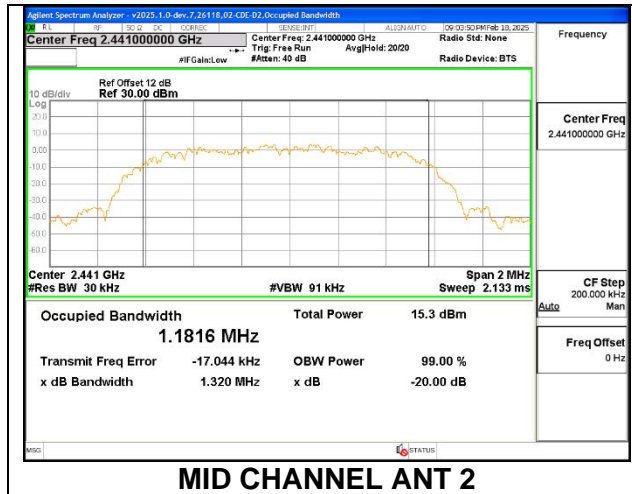

9.2.5. HIGH POWER ENHANCED DATA RATE BTCSM2 MODULATION

ANT 2

Channel	Frequency (MHz)	20dB Bandwidth (MHz)	99% Bandwidth (MHz)
Low	2402	0.1264	0.25182
Mid	2441	0.1266	0.25028
High	2480	0.1264	0.25127

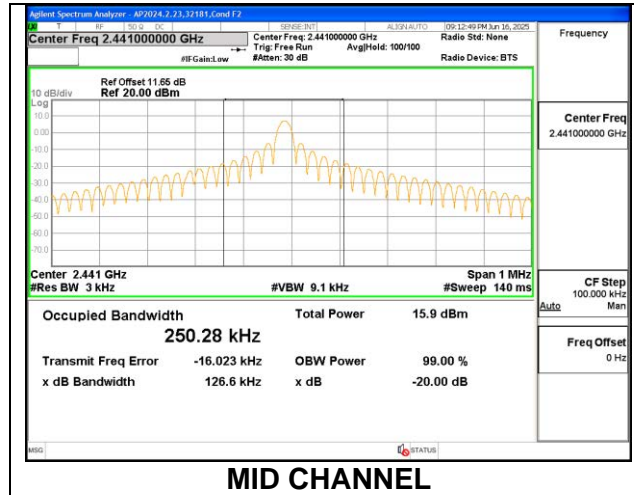

ANT 1

Channel	Frequency (MHz)	20dB Bandwidth (MHz)	99% Bandwidth (MHz)
Low	2402	0.1264	0.25140
Mid	2441	0.1266	0.24978
High	2480	0.1266	0.24978

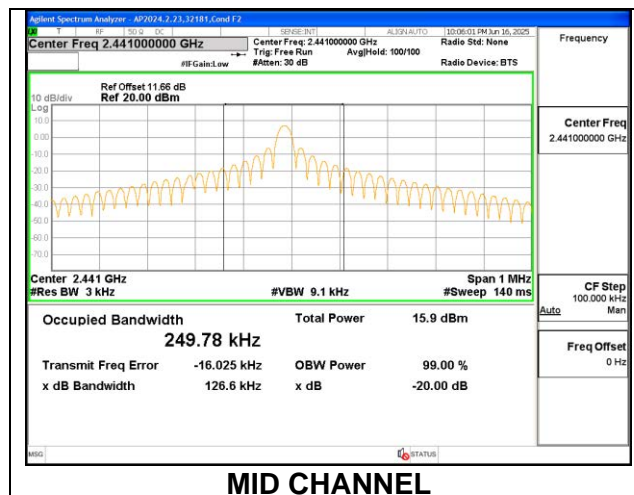

9.2.6. HIGH POWER ENHANCED DATA RATE TXBF BTCSM2 MODULATION

Channel	Frequency (MHz)	20dB Bandwidth ANT 2 (MHz)	20dB Bandwidth ANT 1 (MHz)	99% Bandwidth ANT 2 (MHz)	99% Bandwidth ANT 1 (MHz)
Low	2402	0.1266	0.1268	0.28238	0.27963
Mid	2441	0.1266	0.1267	0.29493	0.29522
High	2480	0.1265	0.1265	0.29467	0.29424

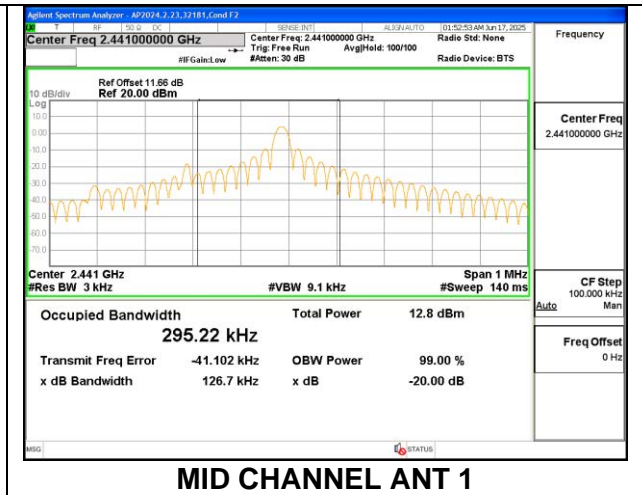
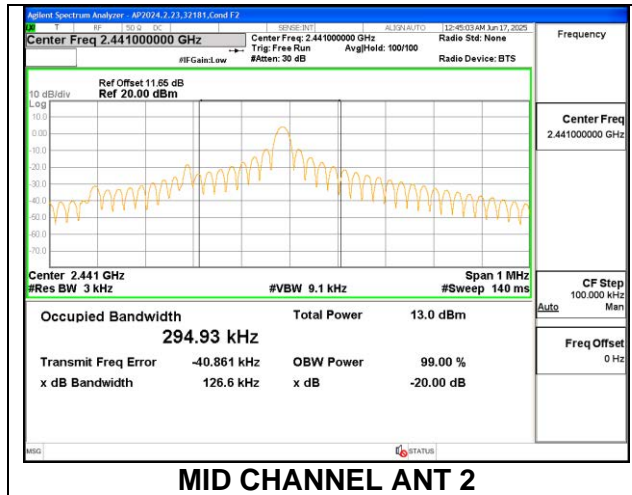

9.3. HOPPING FREQUENCY SEPARATION

LIMITS

FCC §15.247 (a) (1)

RSS-247 (5.1) (b)

Frequency hopping systems shall have hopping channel carrier frequencies separated by a minimum of 25 kHz or the 20 dB bandwidth of the hopping channel, whichever is greater.

Alternatively, frequency hopping systems operating in the 2400-2483.5 MHz band may have hopping channel carrier frequencies that are separated by 25 kHz or two-thirds of the 20 dB bandwidth of the hopping channel, whichever is greater, provided the systems operate with an output power no greater than 125 mW.

TEST PROCEDURE

The transmitter output is connected to a spectrum analyzer. The RBW is set to 300 kHz and the VBW is set to $VBW \geq 3 \times RBW$. The sweep time is coupled.

RESULTS

Only High-Power GFSK mode result is reported since EDR (QPSK/8PSK) has exactly the same channel plan.

9.3.1. HIGH POWER BASIC DATA RATE GFSK MODULATION

HOPPING FREQUENCY SEPARATION

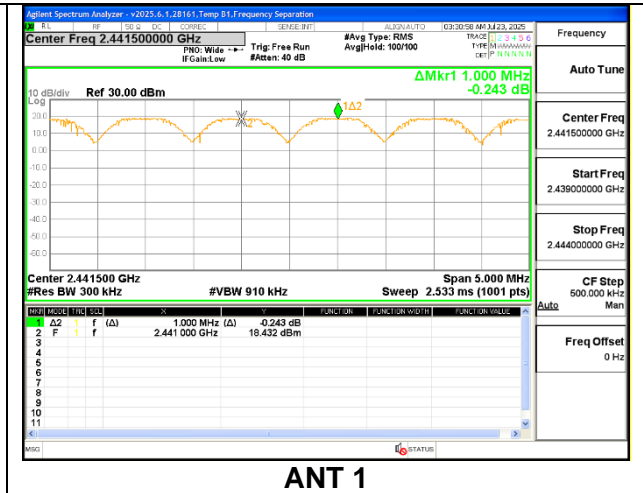
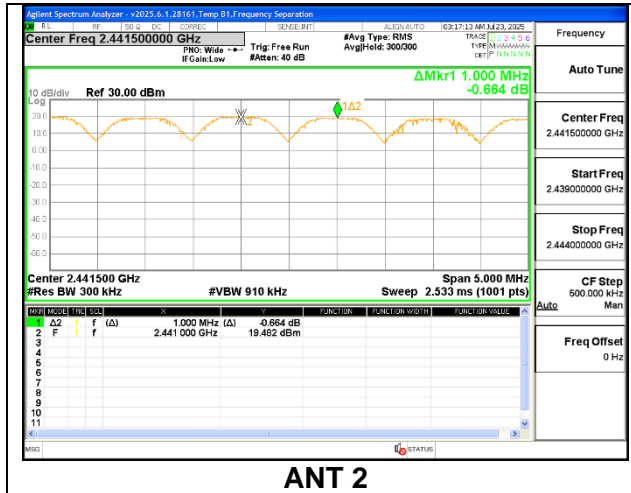

9.3.2. HIGH POWER BASIC DATA RATE BTCSM2 MODULATION

HOPPING FREQUENCY SEPARATION

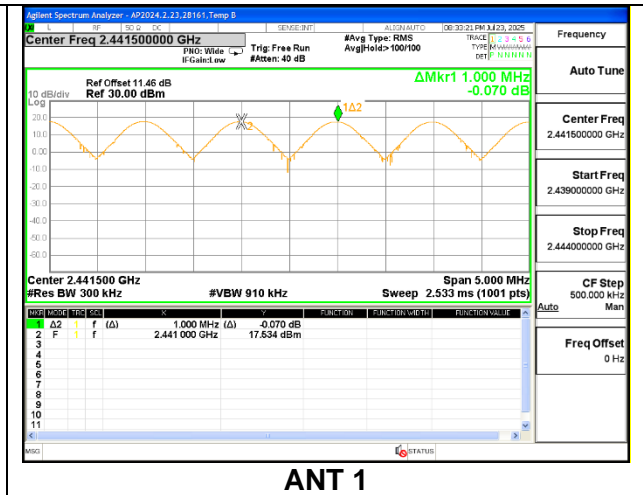
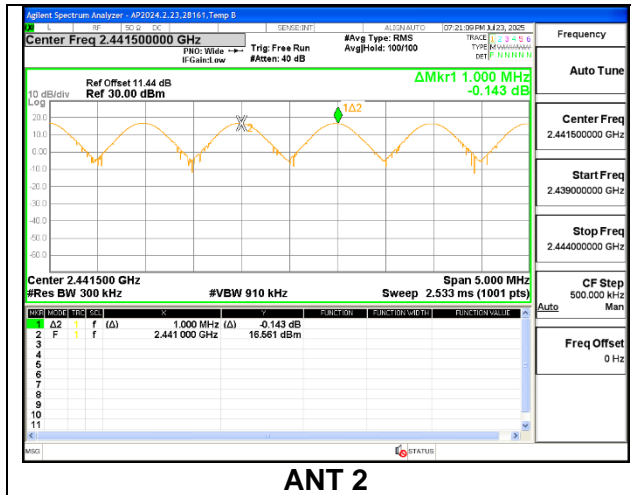

9.4. NUMBER OF HOPPING CHANNELS

LIMITS

FCC §15.247 (a) (1) (iii)

RSS-247 (5.1) (d)

Frequency hopping systems in the 2400 – 2483.5 MHz band shall use at least 15 non-overlapping channels.

TEST PROCEDURE

The transmitter output is connected to a spectrum analyzer. The span is set to cover the entire authorized band, in either a single sweep or in multiple contiguous sweeps. RBW is set to a maximum of 1 % of the span. The analyzer is set to Max Hold.

RESULTS

Normal Mode: 79 Channels Observed. Only High-Power GFSK mode result is reported since EDR (QPSK/8PSK) has the same channel plan.

9.4.1. HIGH POWER BASIC DATA RATE GFSK MODULATION

ANT 2

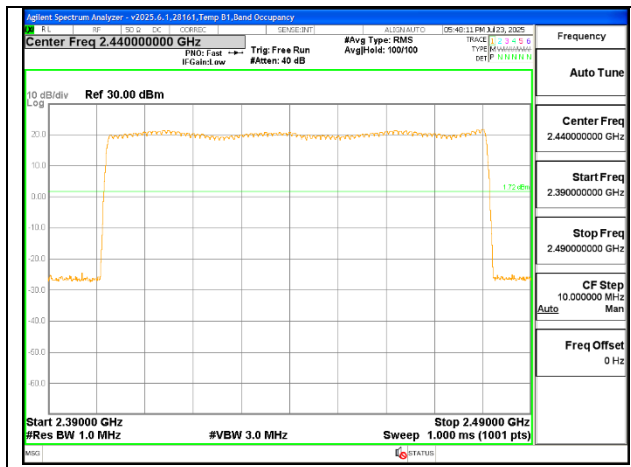

100MHz SPAN

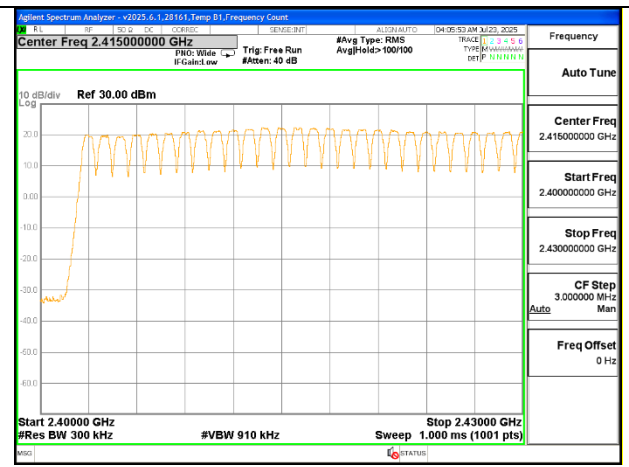

30MHz SPAN, SEGMENT 1 OF 3

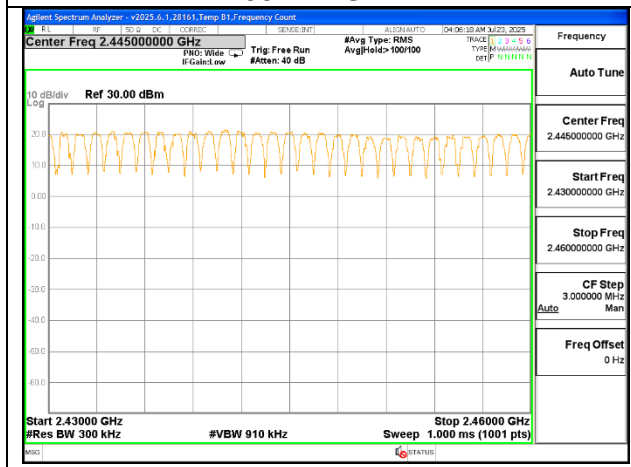

30MHz SPAN, SEGMENT 2 OF 3

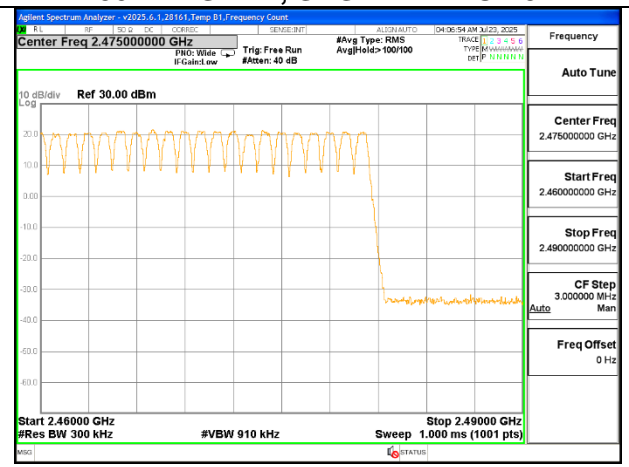

30MHz SPAN, SEGMENT 3 OF 3

ANT 1

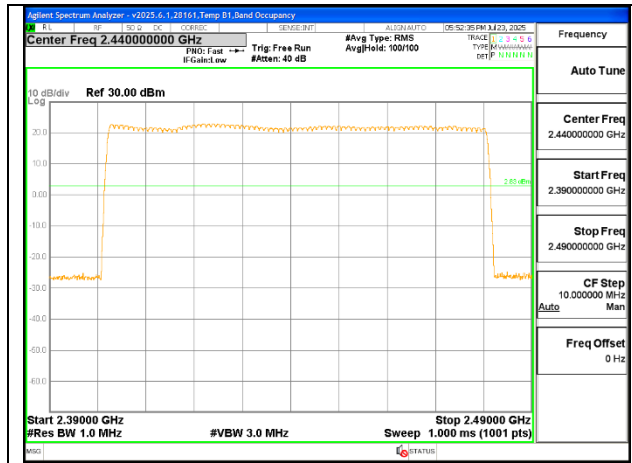

100MHz SPAN

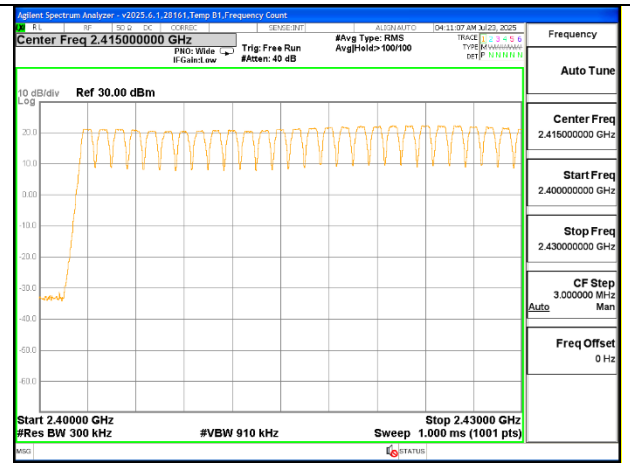

30MHz SPAN, SEGMENT 1 OF 3

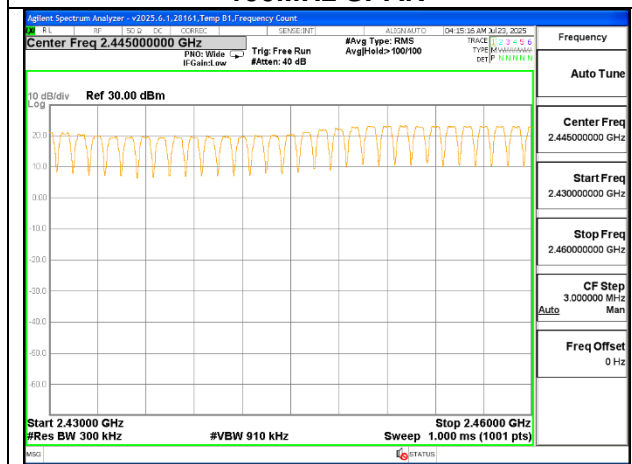

30MHz SPAN, SEGMENT 2 OF 3

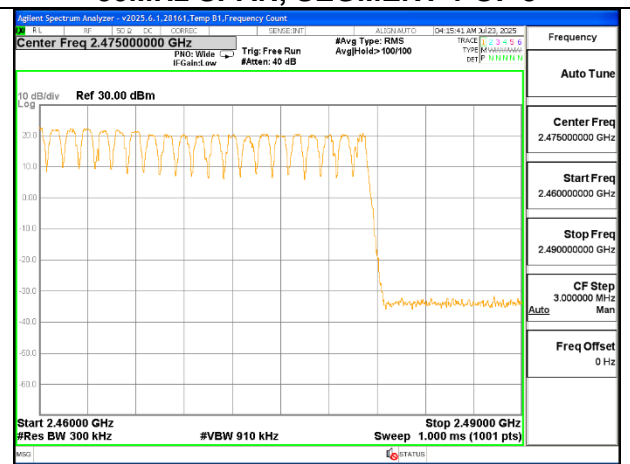

30MHz SPAN, SEGMENT 3 OF 3

9.4.2. HIGH POWER BASIC DATA RATE BTCSM2 MODULATION

ANT 2

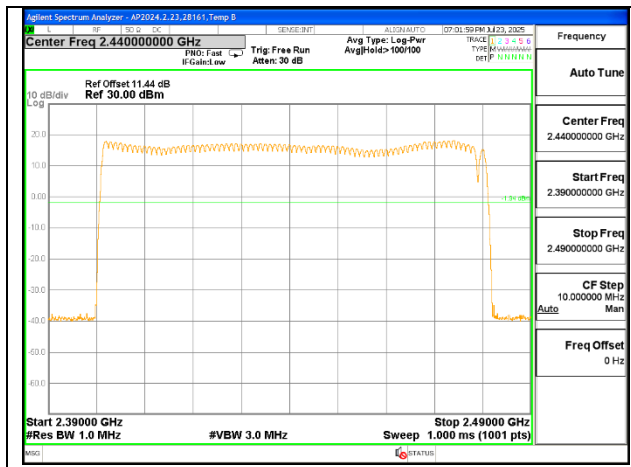

100MHz SPAN

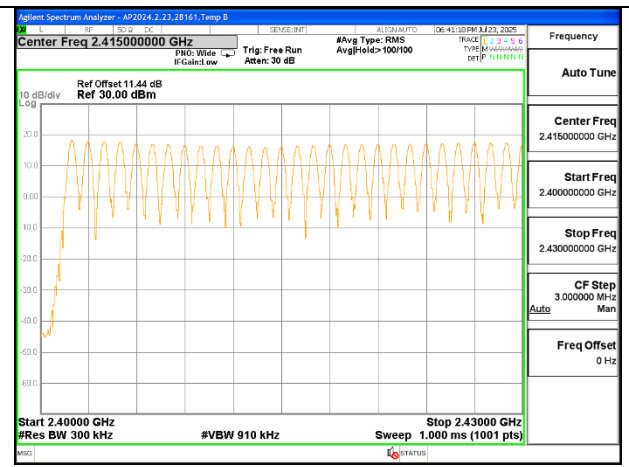

30MHz SPAN, SEGMENT 1 OF 3

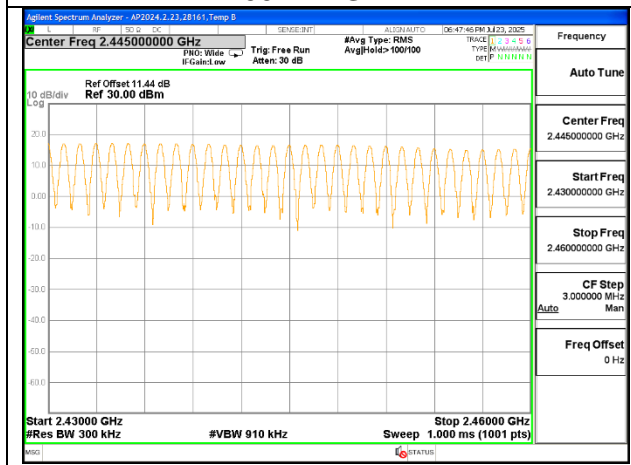

30MHz SPAN, SEGMENT 2 OF 3

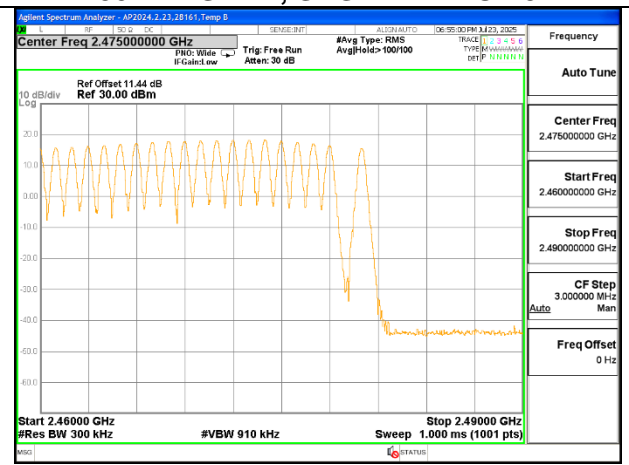

30MHz SPAN, SEGMENT 3 OF 3

ANT 1

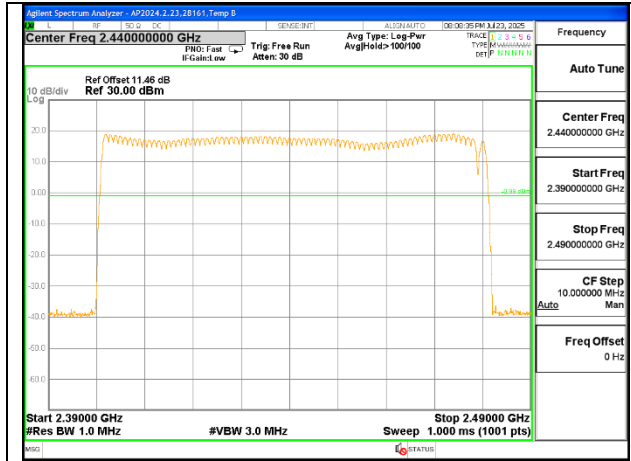

100MHz SPAN

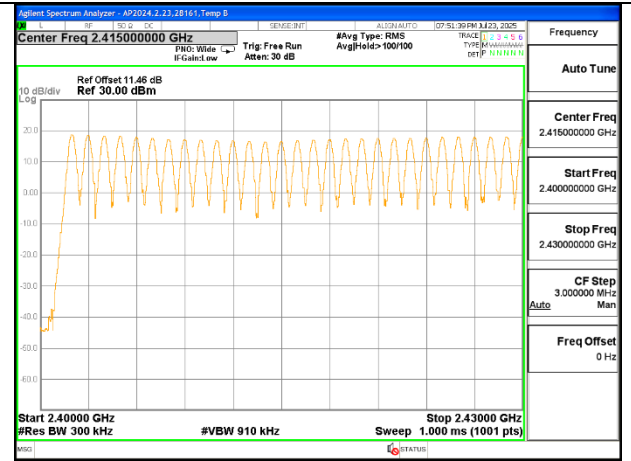

30MHz SPAN, SEGMENT 1 OF 3

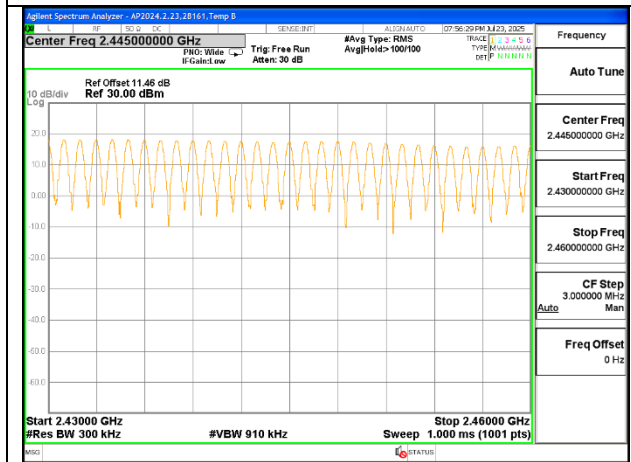

30MHz SPAN, SEGMENT 2 OF 3

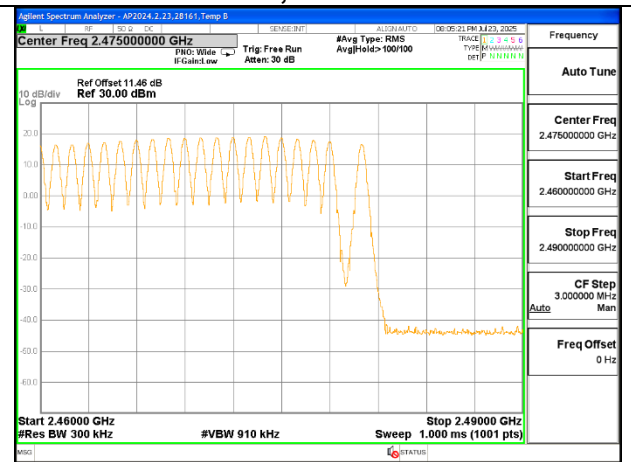

30MHz SPAN, SEGMENT 3 OF 3

9.5. AVERAGE TIME OF OCCUPANCY

LIMITS

FCC §15.247 (a) (1) (iii)

RSS-247 (5.1) (d)

The average time of occupancy on any channel shall not be greater than 0.4 seconds within a period of 0.4 seconds multiplied by the number of hopping channels employed.

TEST PROCEDURE

The transmitter output is connected to a spectrum analyzer. The span is set to 0 Hz, centered on a single, selected hopping channel. The width of a single pulse is measured in a fast scan. The number of pulses is measured in a 3.16 second scan, to enable resolution of each occurrence.

The average time of occupancy in the specified 3.16 second period (79 channels * 0.4 s) is equal to $10 * (\# \text{ of pulses in } 3.16 \text{ s}) * \text{ pulse width}$.

For AFH mode, the average time of occupancy in the specified 8 second period (20 channels * 0.4 seconds) is equal to $10 * (\# \text{ of pulses in } 0.8 \text{ s}) * \text{ pulse width}$.

RESULTS

Only GFSK mode result is reported since EDR (QPSK/8PSK) has exactly the same timing.

9.5.1. BASIC DATA RATE GFSK MODULATION**ANT 2**

DH Packet	Pulse Width (msec)	Number of Pulses in 3.16 seconds	Average Time of Occupancy (sec)	Limit (sec)	Margin (sec)
GFSK Normal Mode					
DH1	0.367	32	0.117	0.4	-0.283
DH3	1.62	19	0.308	0.4	-0.092
DH5	2.86	7	0.200	0.4	-0.200
GFSK AFH Mode					
DH Packet	Pulse Width (sec)	Number of Pulses in 0.8 seconds	Average Time of Occupancy (sec)	Limit (sec)	Margin (sec)
DH1	0.367	8	0.029	0.4	-0.371
DH3	1.62	4.75	0.077	0.4	-0.323
DH5	2.86	1.75	0.050	0.4	-0.350

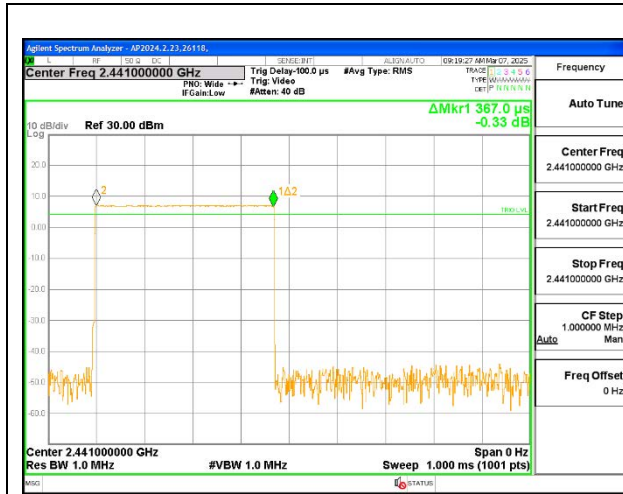

PULSE WIDTH – DH1

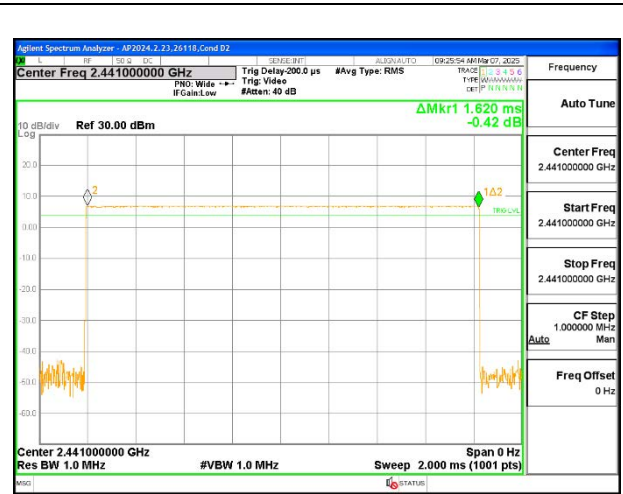

PULSE WIDTH – DH3



PULSE WIDTH – DH5



NUMBER OF PULSES IN 3.16 SECOND OBSERVATION PERIOD – DH1



NUMBER OF PULSES IN 3.16 SECOND OBSERVATION PERIOD – DH3

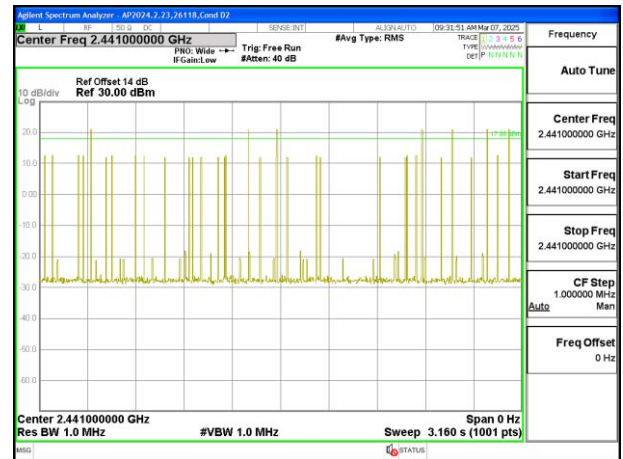

NUMBER OF PULSES IN 3.16 SECOND OBSERVATION PERIOD – DH5

ANT 1

DH Packet	Pulse Width (msec)	Number of Pulses in 3.16 seconds	Average Time of Occupancy (sec)	Limit (sec)	Margin (sec)
GFSK Normal Mode					
DH1	0.367	31	0.114	0.4	-0.286
DH3	1.620	15	0.243	0.4	-0.157
DH5	2.860	8	0.229	0.4	-0.171
DH Packet	Pulse Width (sec)	Number of Pulses in 0.8 seconds	Average Time of Occupancy (sec)	Limit (sec)	Margin (sec)
GFSK AFH Mode					
DH1	0.367	7.75	0.028	0.4	-0.372
DH3	1.62	3.75	0.061	0.4	-0.339
DH5	2.86	2	0.057	0.4	-0.343

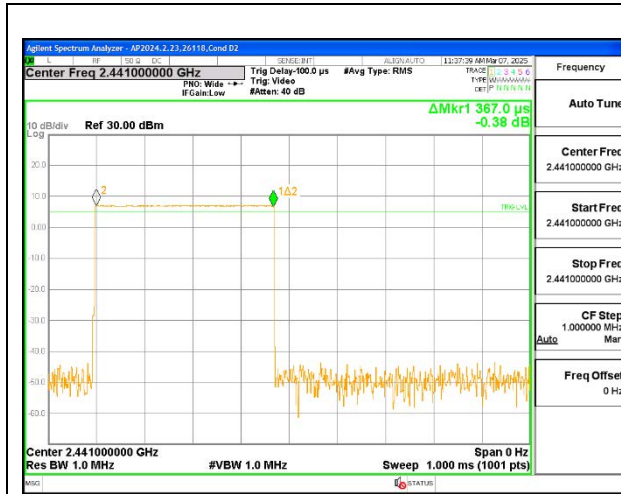

PULSE WIDTH – DH1

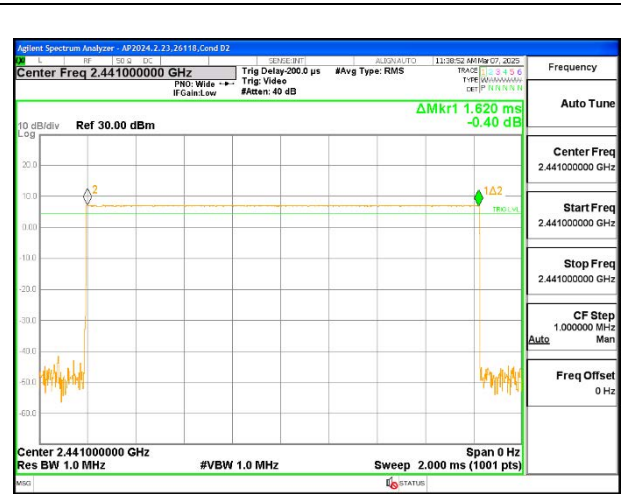

PULSE WIDTH – DH3



PULSE WIDTH – DH5

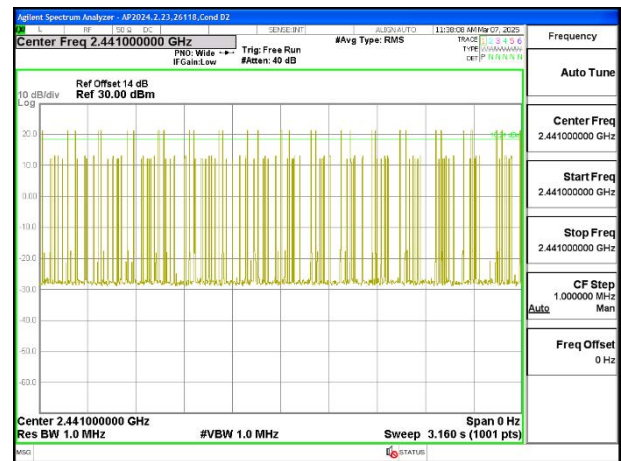

NUMBER OF PULSES IN 3.16 SECOND OBSERVATION PERIOD – DH1



NUMBER OF PULSES IN 3.16 SECOND OBSERVATION PERIOD – DH3

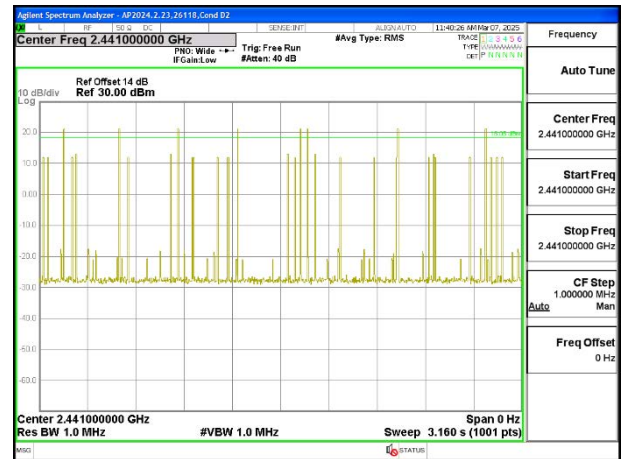

NUMBER OF PULSES IN 3.16 SECOND OBSERVATION PERIOD – DH5

9.5.2. BASIC DATA RATE BTCSM2 MODULATION

ANT 2

DH Packet	Pulse Width (msec)	Number of Pulses in 3.16 seconds	Average Time of Occupancy (sec)	Limit (sec)	Margin (sec)
BTCSM2 Normal Mode					
2Mbps	0.038	86	0.033	0.4	-0.367
BTCSM2 AFH Mode					
2Mbps	0.038	21.5	0.008	0.4	-0.392

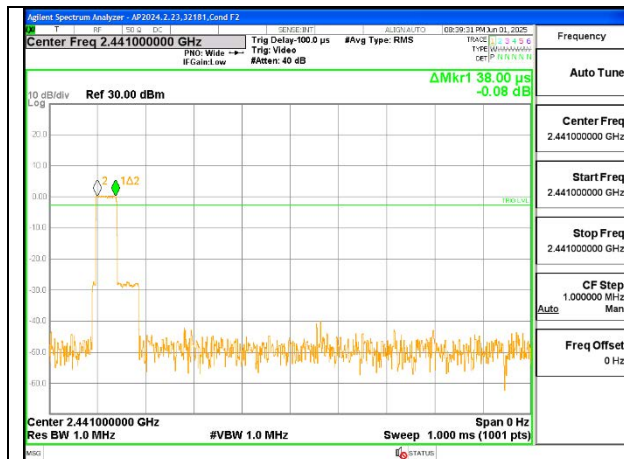

PULSE WIDTH – 2Mbps

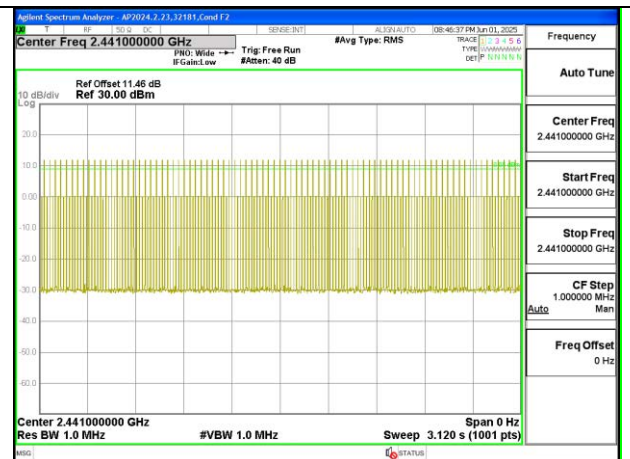

NUMBER OF PULSES IN 3.16 SECOND OBSERVATION PERIOD – 2Mbps

ANT 1

DH Packet	Pulse Width (msec)	Number of Pulses in 3.16 seconds	Average Time of Occupancy (sec)	Limit (sec)	Margin (sec)
BTCSM2 Normal Mode					
2Mbps	0.039	86	0.034	0.4	-0.366
DH Packet					
Pulse Width (msec)					
Number of Pulses in 0.8 seconds					
Average Time of Occupancy (sec)					
Limit (sec)					
Margin (sec)					
BTCSM2 AFH Mode					
2Mbps	0.039	21.5	0.008	0.4	-0.392

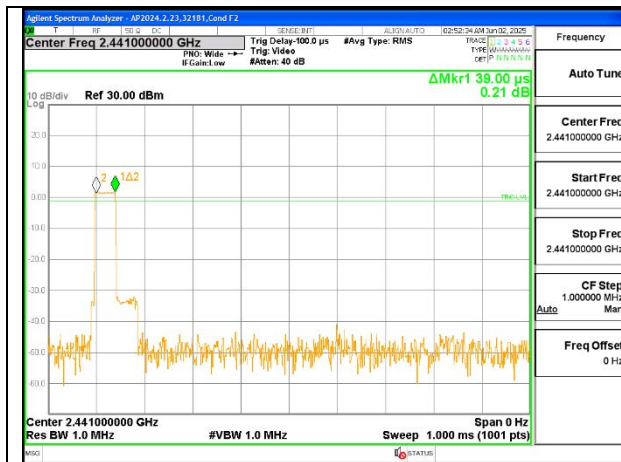

PULSE WIDTH – 2Mbps

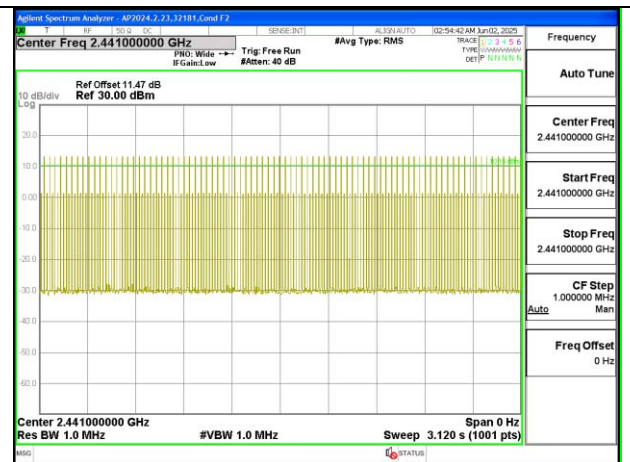

NUMBER OF PULSES IN 3.16 SECOND OBSERVATION PERIOD – 2Mbps

9.6. OUTPUT POWER

LIMITS

§15.247 (b) (1)

RSS-247 (5.4) (b)

The maximum antenna gain is less than 6 dBi, therefore, the limit is 30 dBm. Alternatively, frequency hopping systems operating in the 2400-2483.5 MHz band may have hopping channel carrier frequencies that are separated by 25 kHz or two-thirds of the 20 dB bandwidth of the hopping channel, whichever is greater, provided the systems operate with an output power no greater than 125 mW.

For frequency hopping systems operating in the 2400-2483.5 MHz band employing at least 75 non-overlapping hopping channels, and all frequency hopping systems in the 5725-5850 MHz band: 1 watt. For all other frequency hopping systems in the 2400-2483.5 MHz band: 0.125 watts

TEST PROCEDURE

Measurements are performed using a wideband RF power meter.

The power output was measured on the EUT antenna port using an SMA cable with 10dB attenuator connected to a power meter via a wideband peak power sensor. Peak output power was read directly from the power meter.

DIRECTIONAL ANTENNA GAIN

For 1 TX:

There is only one transmitter output; therefore, the directional gain is equal to the antenna gain.

For 2 TX:

Tx chains are correlated for power due to the device supporting Beamforming. The directional gains are as follows:

Band (GHz)	ANT 2 Antenna Gain (dBi)	ANT 1 Antenna Gain (dBi)	Uncorrelated Chains Directional Gain (dBi)	Correlated Chains Directional Gain (dBi)
2.4	-1.50	-2.50	-1.97	1.02

DIRECTIONAL GAIN CALCULATION:

ANSI C63.10-2020 section 14.6.3

Uncorrelated directional gain= $10 \cdot \text{LOG}((10^{\text{Ant2}/10} + 10^{\text{Ant1}/10})/2)$ Correlated directional Gain= $10 \cdot \text{LOG}(((10^{\text{Ant2}/20} + 10^{\text{Ant1}/20})^2)/2)$

Sample Calculation:

Ant 2 = -1.50, Ant 1 = -2.50

Uncorrelated Antenna gain= $10 \log[(10^{(-1.5/10)} + 10^{(0.6/10)})/2] = -1.97 \text{dBi}$ Correlated Antenna gain= $10 \log[(10^{(-2.5/20)} + 10^{(0.6/20)})^2/2] = 1.02 \text{dBi}$ **RESULTS**

9.6.1. HIGH POWER BASIC DATA RATE GFSK MODULATION

ANT 2

Tested By:	33300
Date:	3/15/2025

Channel	Frequency (MHz)	Output Power (dBm)	Limit (dBm)	Margin (dB)
Low	2402	20.05	21	-0.95
Middle	2441	19.83	21	-1.17
High	2480	20.54	21	-0.46

ANT 1

Tested By:	33300
Date:	3/15/2025

Channel	Frequency (MHz)	Output Power (dBm)	Limit (dBm)	Margin (dB)
Low	2402	20.49	21	-0.51
Middle	2441	20.35	21	-0.65
High	2480	20.34	21	-0.66

9.6.2. HIGH POWER BASIC DATA RATE TXBF GFSK MODULATION

ANT 2 + ANT 1

Tested By:	33300
Date:	3/15/2025

Channel	Frequency (MHz)	Output Power ANT 2 (dBm)	Output Power ANT 1 (dBm)	Total Power (dBm)	Limit (dBm)	Margin (dB)
Low	2402	17.13	16.97	20.06	21	-0.94
Middle	2441	17.46	16.83	20.17	21	-0.83
High	2480	17.60	16.91	20.28	21	-0.72

9.6.3. HIGH POWER ENHANCED DATA RATE QPSK MODULATION

ANT 2

Tested By:	33300
Date:	3/15/2025

Channel	Frequency (MHz)	Output Power (dBm)	Limit (dBm)	Margin (dB)
Low	2402	16.51	21	-4.49
Middle	2441	16.49	21	-4.51
High	2480	16.38	21	-4.62

ANT 1

Tested By:	33300
Date:	3/15/2025

Channel	Frequency (MHz)	Output Power (dBm)	Limit (dBm)	Margin (dB)
Low	2402	16.88	21	-4.12
Middle	2441	16.79	21	-4.21
High	2480	16.81	21	-4.19

9.6.4. HIGH POWER ENHANCED DATA RATE TXBF QPSK MODULATION

ANT 2 + ANT 1

Tested By:	33300
Date:	3/15/2025

Channel	Frequency (MHz)	Output Power ANT 2 (dBm)	Output Power ANT 1 (dBm)	Total Power (dBm)	Limit (dBm)	Margin (dB)
Low	2402	16.23	16.88	19.58	21	-1.42
Middle	2441	16.39	16.63	19.52	21	-1.48
High	2480	16.40	16.56	19.49	21	-1.51

9.6.5. HIGH POWER ENHANCED DATA RATE 8PSK MODULATION

ANT 2

Tested By:	33300
Date:	3/15/2025

Channel	Frequency (MHz)	Output Power (dBm)	Limit (dBm)	Margin (dB)
Low	2402	16.66	21	-4.34
Middle	2441	16.62	21	-4.38
High	2480	16.68	21	-4.32

ANT 1

Tested By:	33300
Date:	3/15/2025

Channel	Frequency (MHz)	Output Power (dBm)	Limit (dBm)	Margin (dB)
Low	2402	17.21	21	-3.79
Middle	2441	17.05	21	-3.95
High	2480	17.08	21	-3.92

9.6.6. HIGH POWER ENHANCED DATA RATE TXBF 8PSK MODULATION

ANT 2 + ANT 1

Tested By:	33300
Date:	3/15/2025

Channel	Frequency (MHz)	Output Power ANT 2 (dBm)	Output Power ANT 1 (dBm)	Total Power (dBm)	Limit (dBm)	Margin (dB)
Low	2402	16.67	17.08	19.89	21	-1.11
Middle	2441	16.72	17.04	19.89	21	-1.11
High	2480	16.72	17.10	19.92	21	-1.08

9.6.7. HIGH POWER ENHANCED DATA RATE BTCSM2 MODULATION

ANT 2

Tested By:	32181
Date:	2025-07-22

Channel	Frequency (MHz)	Output Power (dBm)	Limit (dBm)	Margin (dB)
Low	2402	13.44	21	-7.56
Middle	2441	13.48	21	-7.52
High	2480	13.50	21	-7.5

ANT 1

Tested By:	32181
Date:	2025-07-22

Channel	Frequency (MHz)	Output Power (dBm)	Limit (dBm)	Margin (dB)
Low	2402	13.42	21	-7.58
Middle	2441	13.56	21	-7.44
High	2480	13.46	21	-7.54

9.6.8. HIGH POWER ENHANCED DATA RATE TXBF BTCSM2 MODULATION

ANT 2 + ANT 1

Tested By:	32181
Date:	2025-07-22

Channel	Frequency (MHz)	Output Power ANT 2 (dBm)	Output Power ANT 1 (dBm)	Total Power (dBm)	Limit (dBm)	Margin (dB)
Low	2402	10.30	10.30	13.31	21	-7.69
Middle	2441	10.28	10.22	13.26	21	-7.74
High	2480	10.22	10.26	13.25	21	-7.75

9.6.9. LOW POWER BASIC DATA RATE GFSK MODULATION

ANT 2

Tested By:	33300
Date:	3/15/2025

Channel	Frequency (MHz)	Output Power (dBm)	Limit (dBm)	Margin (dB)
Low	2402	7.97	21	-13.03
Middle	2441	7.85	21	-13.15
High	2480	7.84	21	-13.16

ANT 1

Tested By:	33300
Date:	3/15/2025

Channel	Frequency (MHz)	Output Power (dBm)	Limit (dBm)	Margin (dB)
Low	2402	9.84	21	-11.16
Middle	2441	9.71	21	-11.29
High	2480	9.68	21	-11.32

9.6.10. LOW POWER BASIC DATA RATE TXBF GFSK MODULATION

ANT 2 + ANT 1

Tested By:	33300
Date:	3/15/2025

Channel	Frequency (MHz)	Output Power ANT 2 (dBm)	Output Power ANT 1 (dBm)	Total Power (dBm)	Limit (dBm)	Margin (dB)
Low	2402	7.86	9.71	11.89	21	-9.11
Middle	2441	7.76	9.62	11.80	21	-9.20
High	2480	7.76	9.58	11.77	21	-9.23

9.6.11. LOW POWER ENHANCED DATA RATE QPSK MODULATION

ANT 2

Tested By:	33300
Date:	3/15/2025

Channel	Frequency (MHz)	Output Power (dBm)	Limit (dBm)	Margin (dB)
Low	2402	8.55	21	-12.45
Middle	2441	8.49	21	-12.51
High	2480	8.50	21	-12.5

ANT 1

Tested By:	33300
Date:	3/15/2025

Channel	Frequency (MHz)	Output Power (dBm)	Limit (dBm)	Margin (dB)
Low	2402	9.42	21	-11.58
Middle	2441	9.35	21	-11.65
High	2480	9.40	21	-11.6

9.6.12. LOW POWER ENHANCED DATA RATE TXBF QPSK MODULATION

ANT 2 + ANT 1

Tested By:	33300
Date:	3/15/2025

Channel	Frequency (MHz)	Output Power ANT 2 (dBm)	Output Power ANT 1 (dBm)	Total Power (dBm)	Limit (dBm)	Margin (dB)
Low	2402	8.52	9.43	12.01	21	-8.99
Middle	2441	8.41	9.33	11.90	21	-9.10
High	2480	8.39	9.34	11.90	21	-9.10

9.6.13. LOW POWER ENHANCED DATA RATE 8PSK MODULATION

ANT 2

Tested By:	33300
Date:	3/15/2025

Channel	Frequency (MHz)	Output Power (dBm)	Limit (dBm)	Margin (dB)
Low	2402	8.78	21	-12.22
Middle	2441	8.63	21	-12.37
High	2480	8.63	21	-12.37

ANT 1

Tested By:	33300
Date:	3/15/2025

Channel	Frequency (MHz)	Output Power (dBm)	Limit (dBm)	Margin (dB)
Low	2402	9.63	21	-11.37
Middle	2441	9.53	21	-11.47
High	2480	9.48	21	-11.52

9.6.14. LOW POWER ENHANCED DATA RATE TXBF 8PSK MODULATION

ANT 2 + ANT 1

Tested By:	33300
Date:	3/15/2025

Channel	Frequency (MHz)	Output Power ANT 2 (dBm)	Output Power ANT 1 (dBm)	Total Power (dBm)	Limit (dBm)	Margin (dB)
Low	2402	8.67	9.60	12.17	21	-8.83
Middle	2441	8.57	9.48	12.06	21	-8.94
High	2480	8.50	9.45	12.01	21	-8.99

9.6.15. LOW POWER ENHANCED DATA RATE BTCSM2 MODULATION

ANT 2

Tested By:	32181
Date:	2025-07-22

Channel	Frequency (MHz)	Output Power (dBm)	Limit (dBm)	Margin (dB)
Low	2402	10.37	21	-10.63
Middle	2441	10.38	21	-10.62
High	2480	10.32	21	-10.68

ANT 1

Tested By:	32181
Date:	2025-07-22

Channel	Frequency (MHz)	Output Power (dBm)	Limit (dBm)	Margin (dB)
Low	2402	11.75	21	-9.25
Middle	2441	11.72	21	-9.28
High	2480	11.90	21	-9.1

9.6.16. LOW POWER ENHANCED DATA RATE TXBF BTCSM2 MODULATION

ANT 2 + ANT 1

Tested By:	32181
Date:	2025-07-22

Channel	Frequency (MHz)	Output Power ANT 2 (dBm)	Output Power ANT 1 (dBm)	Total Power (dBm)	Limit (dBm)	Margin (dB)
Low	2402	10.41	10.12	13.28	21	-7.72
Middle	2441	10.45	10.13	13.30	21	-7.70
High	2480	10.35	10.11	13.24	21	-7.76

9.7. AVERAGE POWER

LIMITS

None; for reporting purposes only

TEST PROCEDURE

Measurements were performed using a wideband RF power meter.

The power output was measured on the EUT antenna port using SMA cable with 10dB attenuator connected to a power meter via wideband average power sensor. Gated average output power was read directly from power meter.

RESULTS

9.7.1. HIGH POWER BASIC DATA RATE GFSK MODULATION

ANT 2

Tested By:	33300
Date	3/15/2025

Channel	Frequency (MHz)	Average Power (dBm)
Low	2402	19.44
Middle	2441	19.26
High	2480	19.99

ANT 1

Tested By:	33300
Date	3/15/2025

Channel	Frequency (MHz)	Average Power (dBm)
Low	2402	19.99
Middle	2441	19.83
High	2480	19.82

9.7.2. HIGH POWER BASIC DATA RATE TXBF GFSK MODULATION

ANT 2 + ANT 1

Tested By:	33300
Date:	3/15/2025

Channel	Frequency (MHz)	Average Power ANT 2 (dBm)	Average Power ANT 1 (dBm)	Total Power (dBm)
Low	2402	16.43	16.75	19.60
Middle	2441	16.99	16.61	19.81
High	2480	16.92	16.70	19.82

9.7.3. HIGH POWER ENHANCED DATA RATE QPSK MODULATION

ANT 2

Tested By:	33300
Date	3/15/2025

Channel	Frequency (MHz)	Average Power (dBm)
Low	2402	12.71
Middle	2441	12.69
High	2480	12.74

ANT 1

Tested By:	33300
Date	3/15/2025

Channel	Frequency (MHz)	Average Power (dBm)
Low	2402	13.20
Middle	2441	12.99
High	2480	13.12

9.7.4. HIGH POWER ENHANCED DATA RATE TXBF QPSK MODULATION

ANT 2 + ANT 1

Tested By:	33300
Date:	3/15/2025

Channel	Frequency (MHz)	Average Power ANT 2 (dBm)	Average Power ANT 1 (dBm)	Total Power (dBm)
Low	2402	12.80	13.19	16.01
Middle	2441	12.77	13.01	15.90
High	2480	12.79	13.09	15.95

9.7.5. HIGH POWER ENHANCED DATA RATE 8PSK MODULATION

ANT 2

Tested By:	33300
Date	3/15/2025

Channel	Frequency (MHz)	Average Power (dBm)
Low	2402	12.99
Middle	2441	12.94
High	2480	12.94

ANT 1

Tested By:	33300
Date	3/15/2025

Channel	Frequency (MHz)	Average Power (dBm)
Low	2402	13.48
Middle	2441	13.34
High	2480	13.36

9.7.6. HIGH POWER ENHANCED DATA RATE TXBF 8PSK MODULATION

ANT 2 + ANT 1

Tested By:	33300
Date:	3/15/2025

Channel	Frequency (MHz)	Average Power ANT 2 (dBm)	Average Power ANT 1 (dBm)	Total Power (dBm)
Low	2402	12.99	13.40	16.21
Middle	2441	12.96	13.26	16.12
High	2480	12.87	13.30	16.10

9.7.7. HIGH POWER ENHANCED DATA RATE BTCSM2 MODULATION

ANT 2

Tested By:	32181
Date:	2025-06-16

Channel	Frequency (MHz)	Average Power (dBm)
Low	2402	10.99
Middle	2441	10.89
High	2480	10.79

ANT 1

Tested By:	32181
Date	2025-06-16

Channel	Frequency (MHz)	Average Power (dBm)
Low	2402	10.99
Middle	2441	10.89
High	2480	10.89

9.7.8. HIGH POWER ENHANCED DATA RATE TXBF BTCSM2 MODULATION

ANT 2 + ANT 1

Tested By:	32181
Date:	2025-06-16

Channel	Frequency (MHz)	Average Power ANT 2 (dBm)	Average Power ANT 1 (dBm)	Total Power (dBm)
Low	2402	7.94	7.99	10.98
Middle	2441	7.97	7.94	10.97
High	2480	7.99	7.94	10.98

9.7.9. LOW POWER BASIC DATA RATE GFSK MODULATION

ANT 2

Tested By:	33300
Date	3/15/2025

Channel	Frequency (MHz)	Average Power (dBm)
Low	2402	7.77
Middle	2441	7.71
High	2480	7.67

ANT 1

Tested By:	33300
Date	3/15/2025

Channel	Frequency (MHz)	Average Power (dBm)
Low	2402	9.49
Middle	2441	9.38
High	2480	9.34

9.7.10. LOW POWER BASIC DATA RATE TXBF GFSK MODULATION

ANT 2 + ANT 1

Tested By:	33300
Date:	3/15/2025

Channel	Frequency (MHz)	Average Power ANT 2 (dBm)	Average Power ANT 1 (dBm)	Total Power (dBm)
Low	2402	7.66	9.45	11.66
Middle	2441	7.59	9.36	11.57
High	2480	7.59	9.35	11.57

9.7.11. LOW POWER ENHANCED DATA RATE QPSK MODULATION

ANT 2

Tested By:	33300
Date	3/15/2025

Channel	Frequency (MHz)	Average Power (dBm)
Low	2402	4.88
Middle	2441	4.89
High	2480	4.68

ANT 1

Tested By:	33300
Date	3/15/2025

Channel	Frequency (MHz)	Average Power (dBm)
Low	2402	6.10
Middle	2441	6.14
High	2480	6.01

9.7.12. LOW POWER ENHANCED DATA RATE TXBF QPSK MODULATION

ANT 2 + ANT 1

Tested By:	33300
Date:	3/15/2025

Channel	Frequency (MHz)	Average Power ANT 2 (dBm)	Average Power ANT 1 (dBm)	Total Power (dBm)
Low	2402	4.80	6.20	8.57
Middle	2441	4.81	6.15	8.54
High	2480	4.66	6.09	8.44

9.7.13. LOW POWER ENHANCED DATA RATE 8PSK MODULATION

ANT 2

Tested By:	33300
Date	3/15/2025

Channel	Frequency (MHz)	Average Power (dBm)
Low	2402	4.97
Middle	2441	4.99
High	2480	4.72

ANT 1

Tested By:	33300
Date	3/15/2025

Channel	Frequency (MHz)	Average Power (dBm)
Low	2402	6.40
Middle	2441	6.34
High	2480	6.24

9.7.14. LOW POWER ENHANCED DATA RATE TXBF 8PSK MODULATION

ANT 2 + ANT 1

Tested By:	33300
Date:	3/15/2025

Channel	Frequency (MHz)	Average Power ANT 2 (dBm)	Average Power ANT 1 (dBm)	Total Power (dBm)
Low	2402	4.96	6.42	8.76
Middle	2441	4.98	6.26	8.68
High	2480	4.73	6.19	8.53

9.7.15. LOW POWER ENHANCED DATA RATE BTCSM2 MODULATION

ANT 2

Tested By:	32181
Date	2025-06-16

Channel	Frequency (MHz)	Average Power (dBm)
Low	2402	7.95
Middle	2441	7.99
High	2480	7.99

ANT 1

Tested By:	32181
Date	2025-06-16

Channel	Frequency (MHz)	Average Power (dBm)
Low	2402	9.49
Middle	2441	9.39
High	2480	9.19

9.7.16. LOW POWER ENHANCED DATA RATE TXBF BTCSM2 MODULATION

ANT 2 + ANT 1

Tested By:	32181
Date:	2025-06-16

Channel	Frequency (MHz)	Average Power ANT 2 (dBm)	Average Power ANT 1 (dBm)	Total Power (dBm)
Low	2402	7.94	7.97	10.97
Middle	2441	7.84	7.83	10.85
High	2480	7.99	7.99	11.00

9.8. CONDUCTED SPURIOUS EMISSIONS

LIMITS

FCC §15.247 (d)

RSS-247 5.5

Limit = -20 dBc

TEST PROCEDURE

The transmitter output is connected to a spectrum analyzer. The resolution bandwidth is set to 100 kHz. The video bandwidth is set to 300 kHz.

The spectrum from 30 MHz to 26 GHz is investigated with the transmitter set to the lowest, middle, and highest channels.

The band edges at 2.4 and 2.4835 GHz are investigated with the transmitter set to the normal hopping mode.

RESULTS

9.8.1. HIGH POWER BASIC DATA RATE GFSK MODULATION

ANT 2 SPURIOUS EMISSIONS, NON-HOPPING

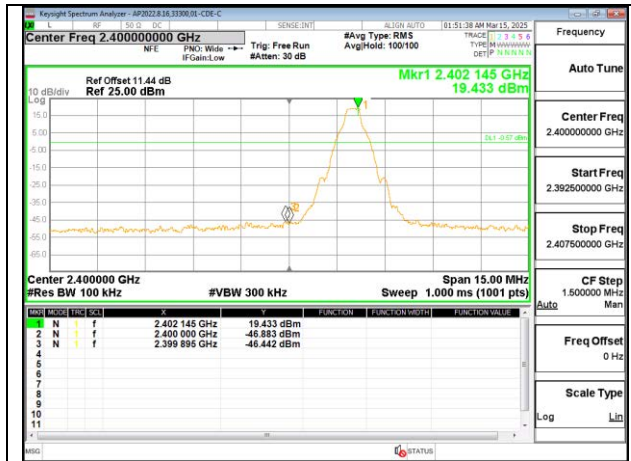

LOW CHANNEL BANDEDGE

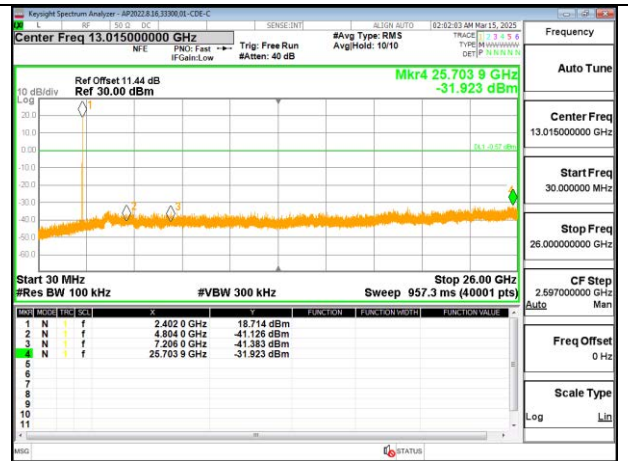

OUT-OF-BAND LOW CHANNEL

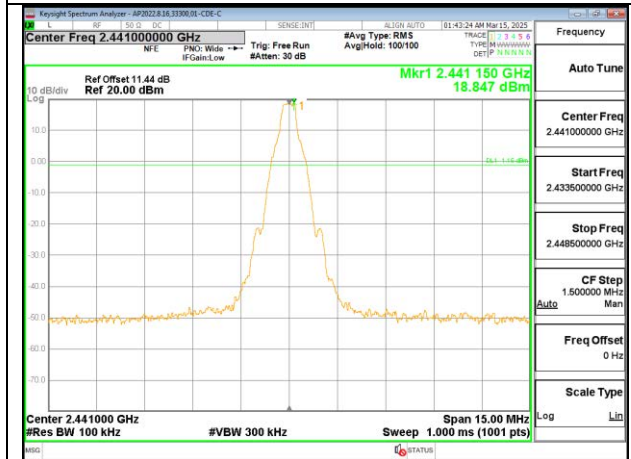

IN-BAND REFERENCE LEVEL

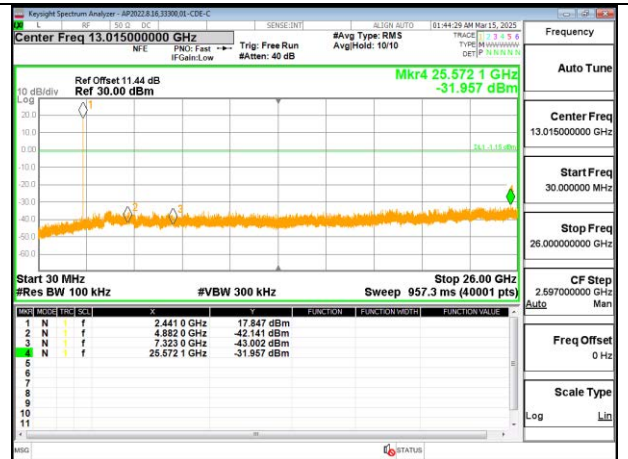

OUT-OF-BAND MID CHANNEL

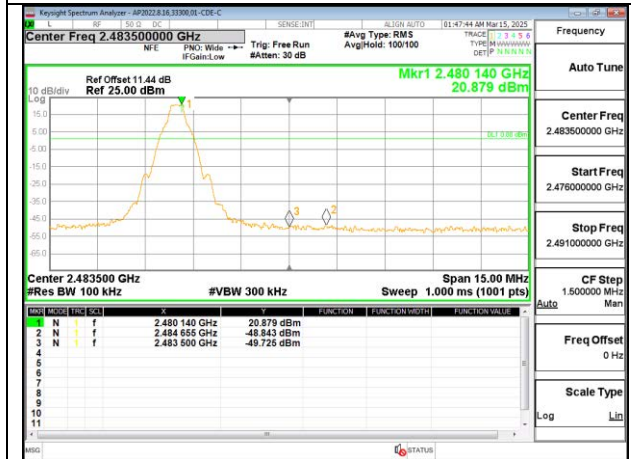

HIGH CHANNEL BANDEDGE

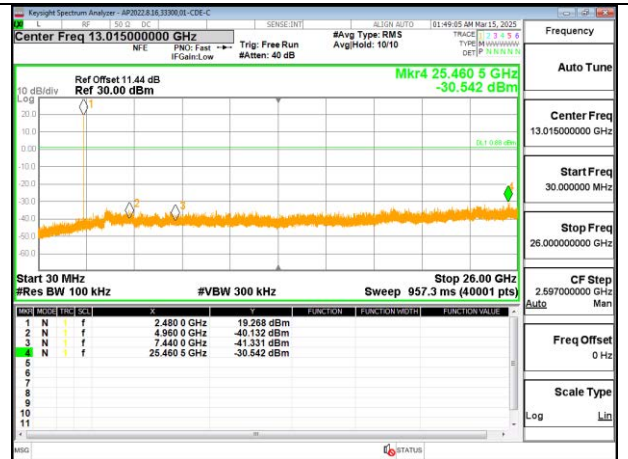

OUT-OF-BAND HIGH CHANNEL

ANT 2 SPURIOUS BANDEDGE EMISSIONS WITH HOPPING ON

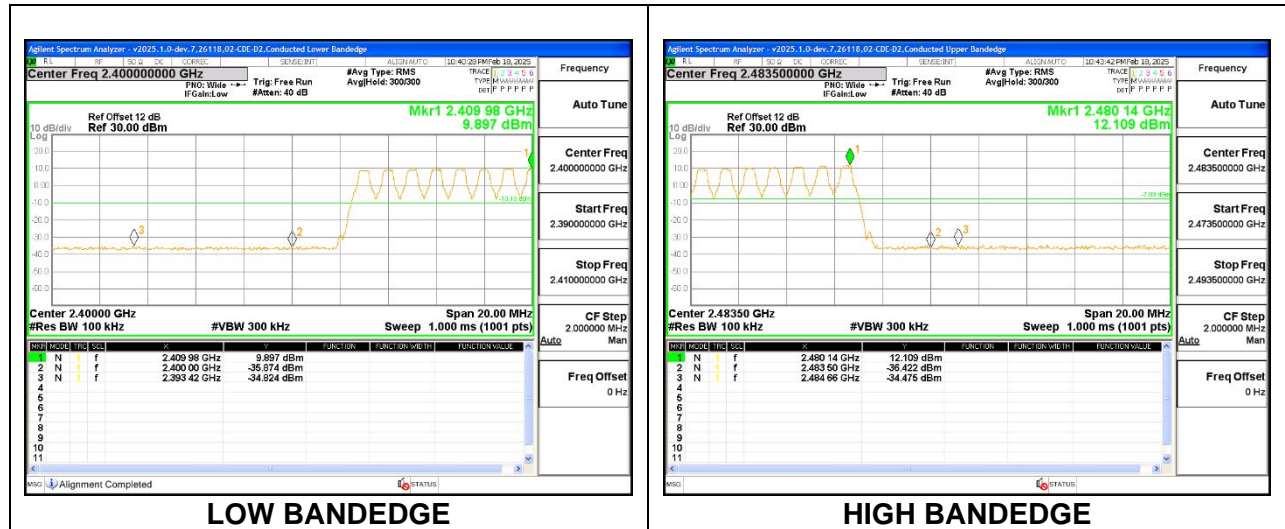

ANT 1 SPURIOUS EMISSIONS, NON-HOPPING

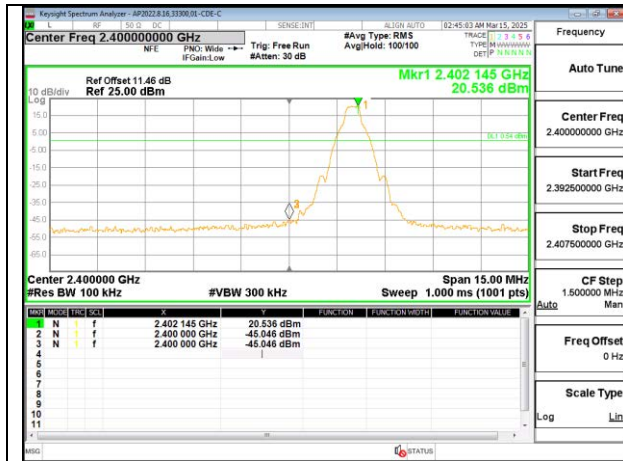

LOW CHANNEL BANDEDGE

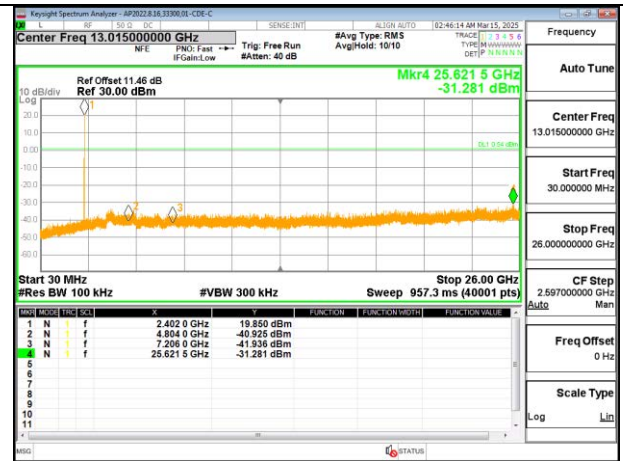

OUT-OF-BAND LOW CHANNEL

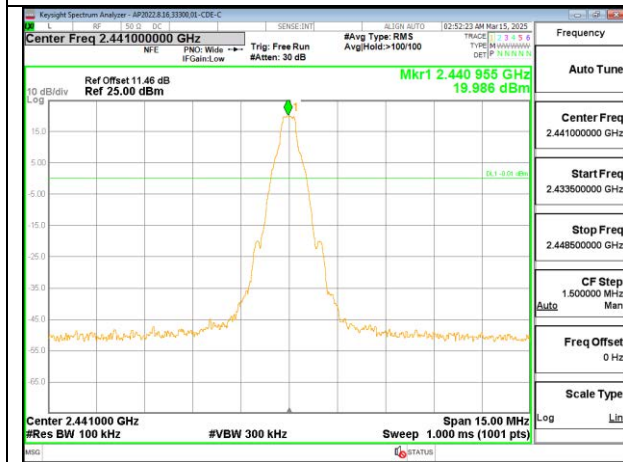

IN-BAND REFERENCE LEVEL

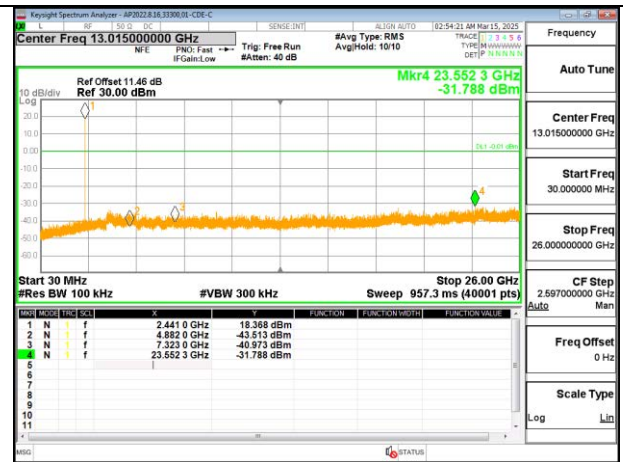

OUT-OF-BAND MID CHANNEL

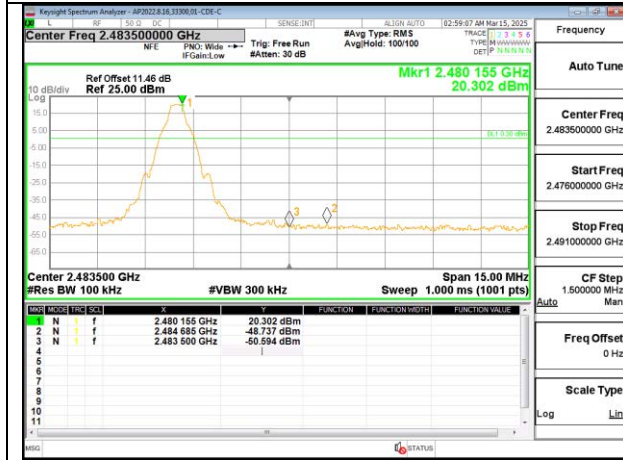

HIGH CHANNEL BANDEDGE

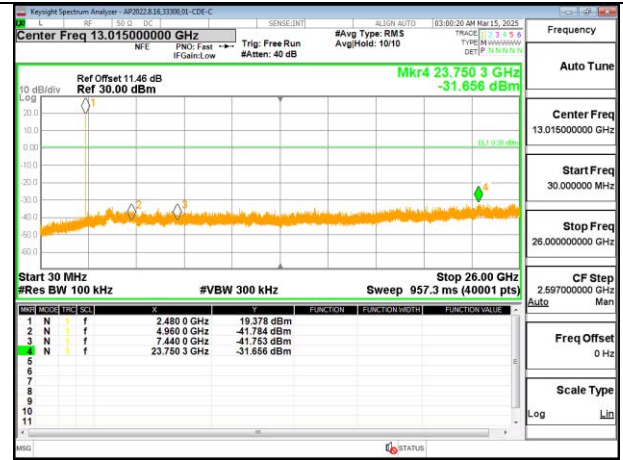

OUT-OF-BAND HIGH CHANNEL

ANT 1 SPURIOUS BANDEDGE EMISSIONS WITH HOPPING ON

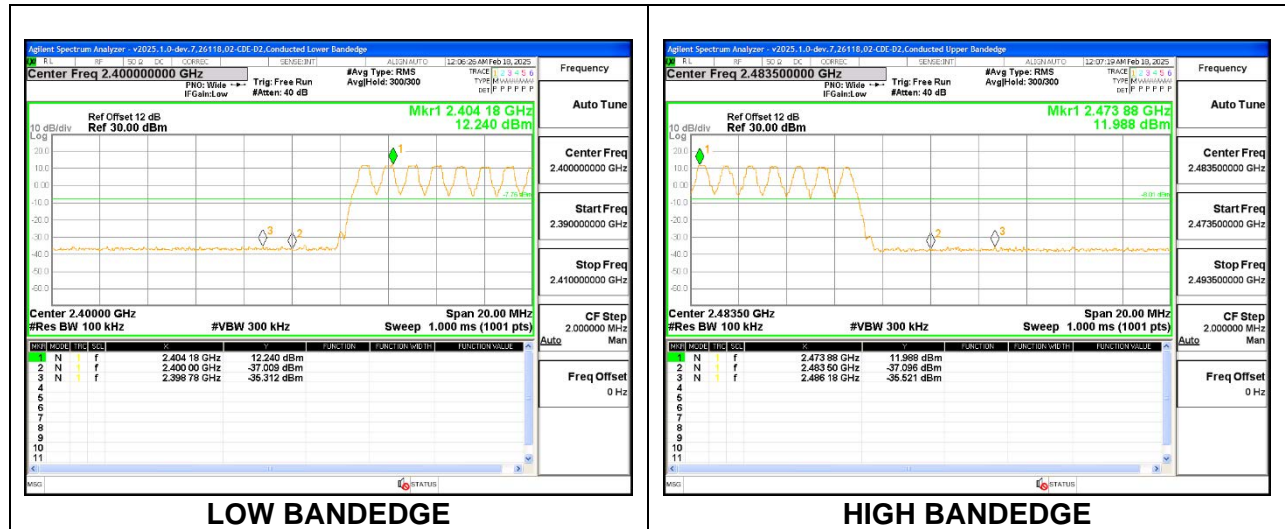

9.8.2. HIGH POWER BASIC DATA RATE TXBF GFSK MODULATION

Note: Test procedure on beamforming mode is same as BT basic and EDR mode

ANT 2

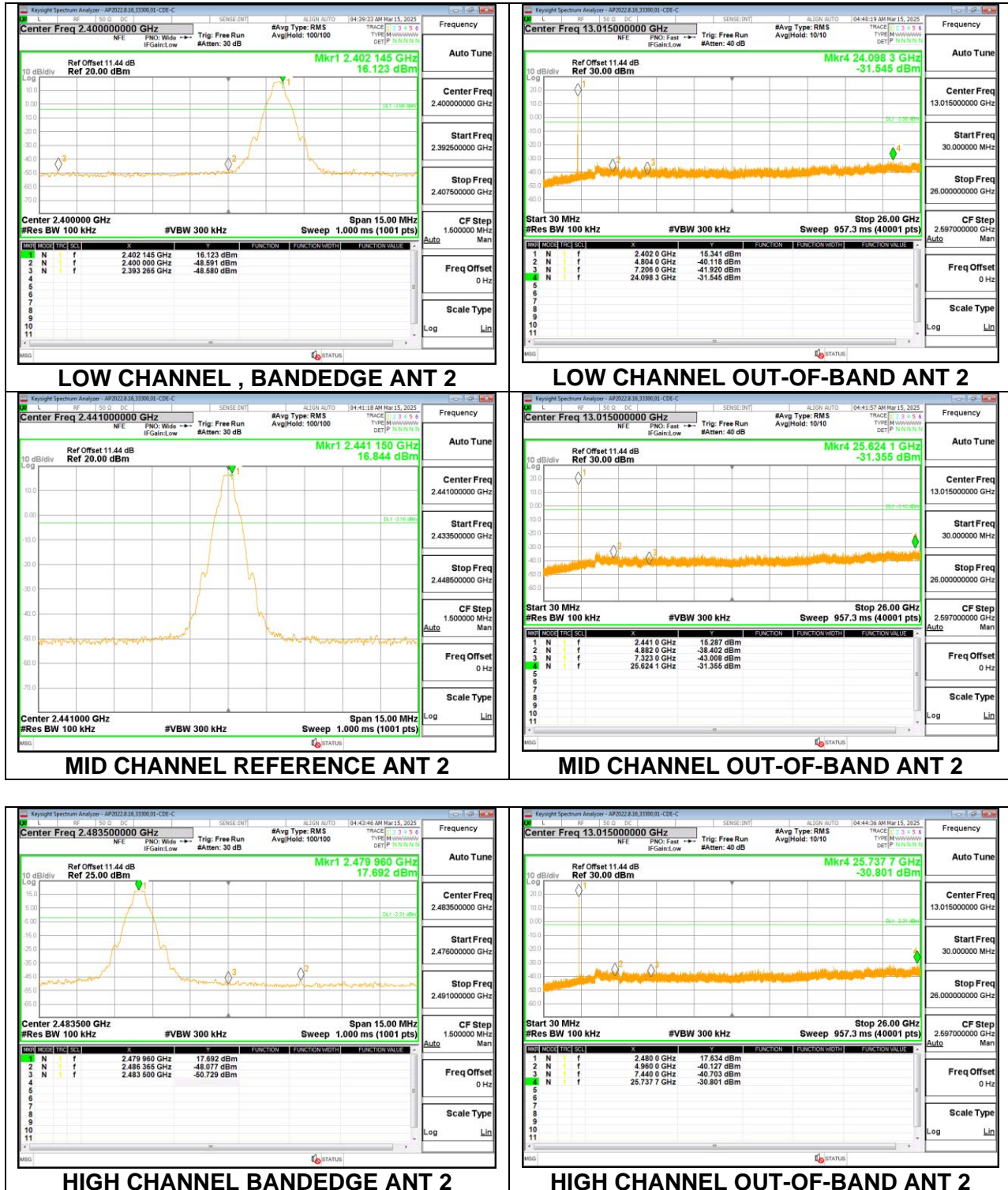

ANT 2 SPURIOUS BANDEDGE EMISSIONS WITH HOPPING ON



ANT 1

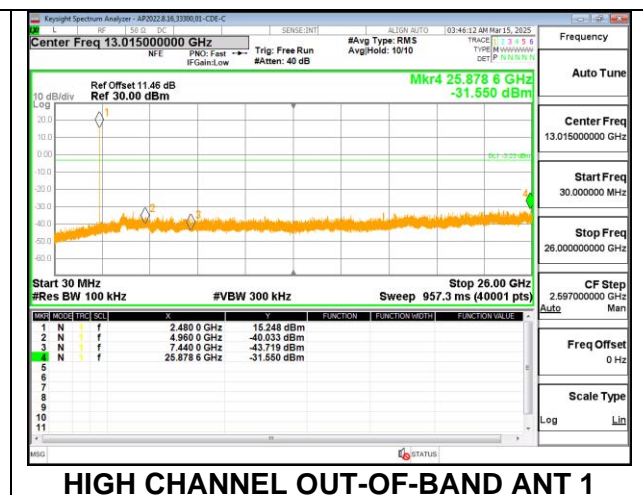
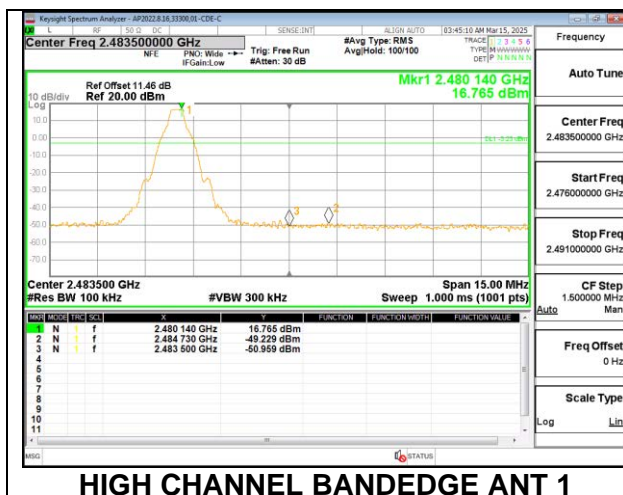
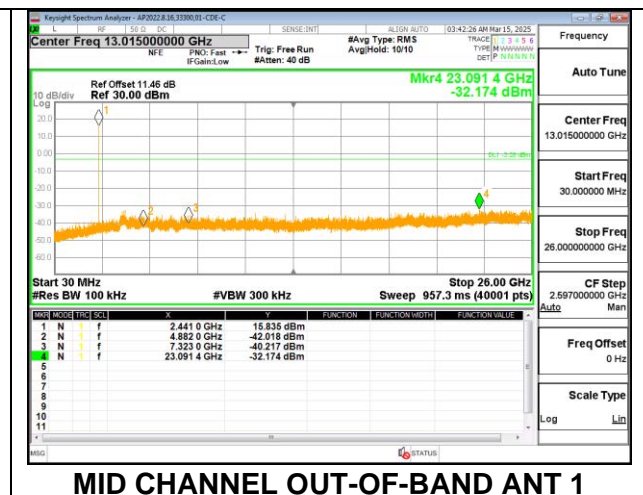
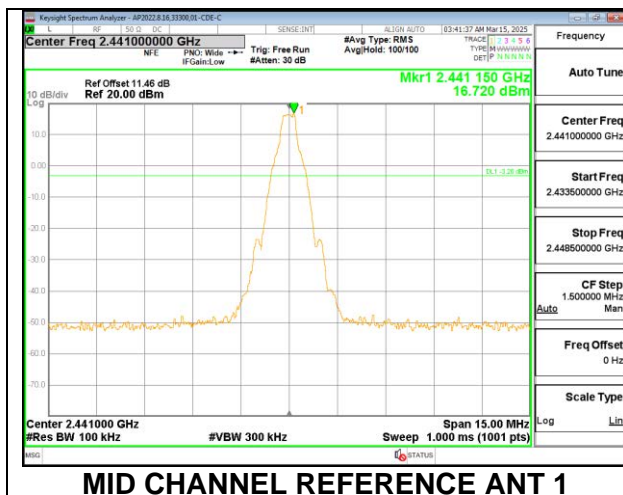
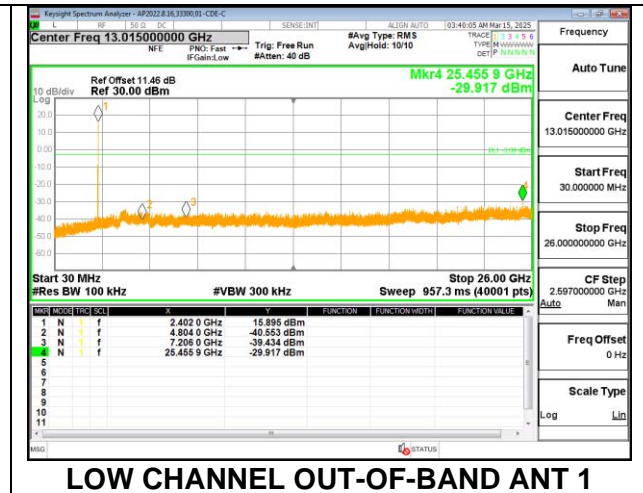
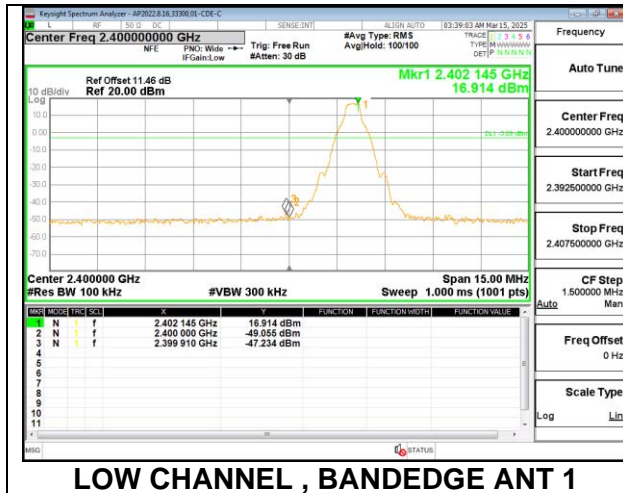

ANT 1 SPURIOUS BANDEDGE EMISSIONS WITH HOPPING ON

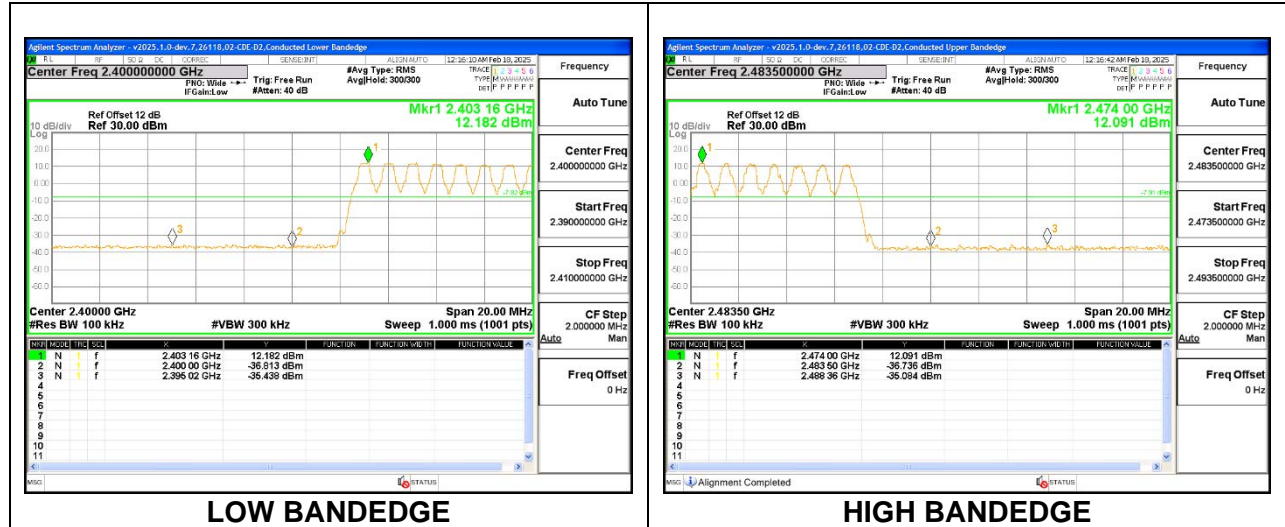

9.8.3. HIGH POWER ENHANCED DATA RATE 8PSK MODULATION

ANT 2 SPURIOUS EMISSIONS, NON-HOPPING

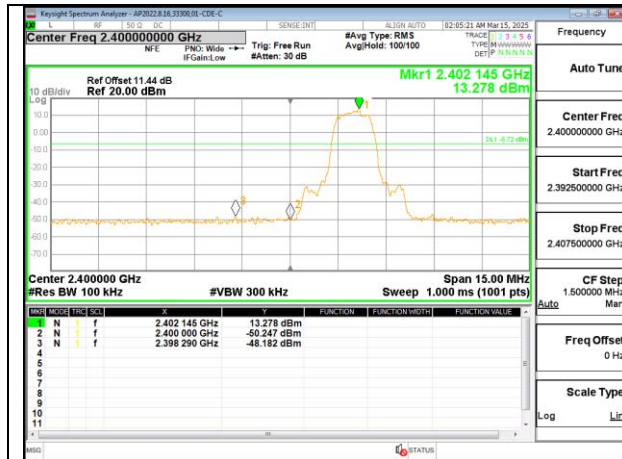

LOW CHANNEL BANDEDGE

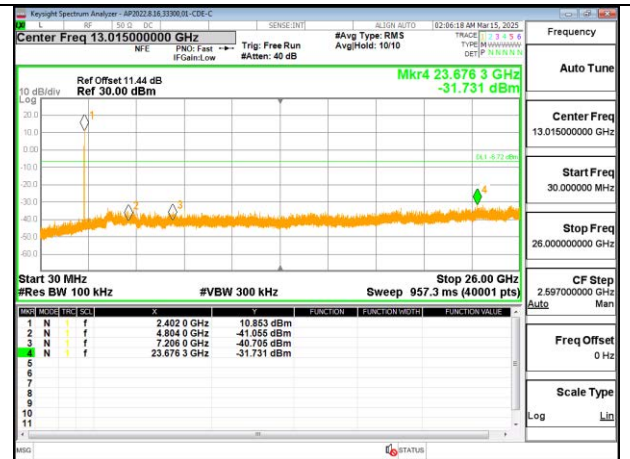

OUT-OF-BAND LOW CHANNEL

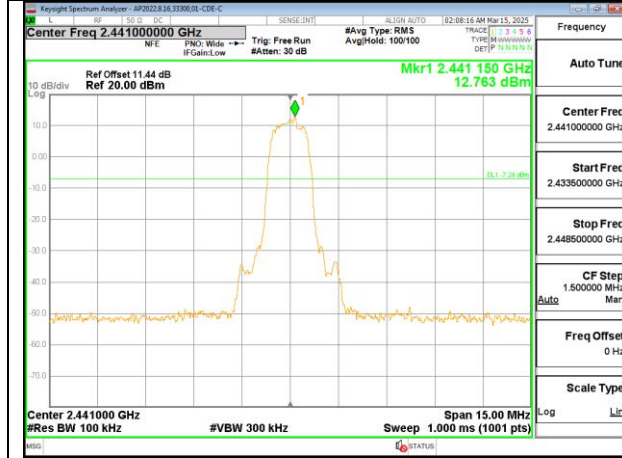

IN-BAND REFERENCE LEVEL

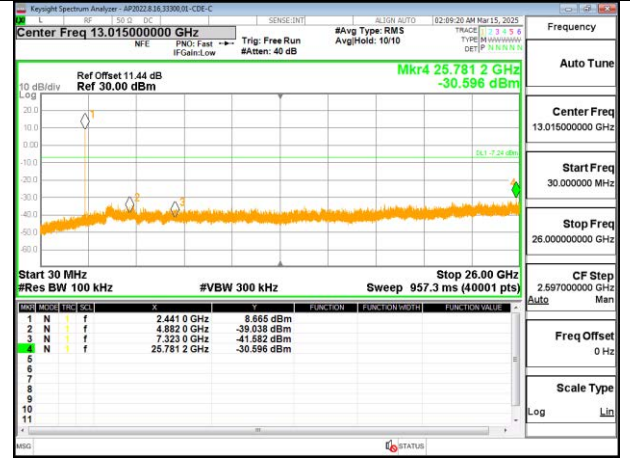

OUT-OF-BAND MID CHANNEL

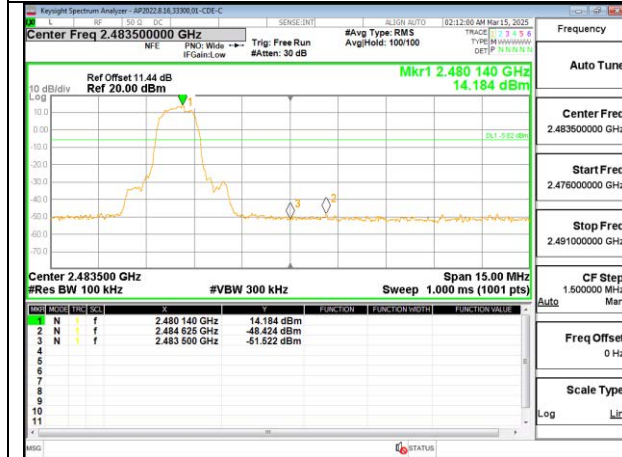

HIGH CHANNEL BANDEDGE

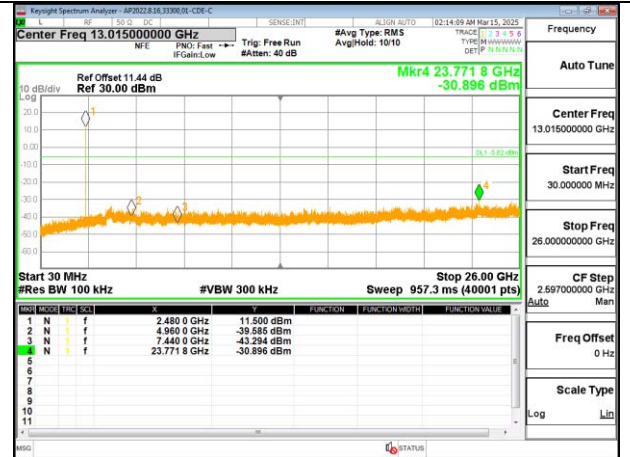

OUT-OF-BAND HIGH CHANNEL

ANT 2 SPURIOUS BANDEDGE EMISSIONS WITH HOPPING ON

